

Martins, Pedro M. G.

Working Paper

Do capital inflows hinder competitiveness? The real exchange rate in Ethiopia

CREDIT Research Paper, No. 10/07

Provided in Cooperation with:

The University of Nottingham, Centre for Research in Economic Development and International Trade (CREDIT)

Suggested Citation: Martins, Pedro M. G. (2010) : Do capital inflows hinder competitiveness? The real exchange rate in Ethiopia, CREDIT Research Paper, No. 10/07, The University of Nottingham, Centre for Research in Economic Development and International Trade (CREDIT), Nottingham

This Version is available at:

<https://hdl.handle.net/10419/65429>

Standard-Nutzungsbedingungen:

Die Dokumente auf EconStor dürfen zu eigenen wissenschaftlichen Zwecken und zum Privatgebrauch gespeichert und kopiert werden.

Sie dürfen die Dokumente nicht für öffentliche oder kommerzielle Zwecke vervielfältigen, öffentlich ausstellen, öffentlich zugänglich machen, vertreiben oder anderweitig nutzen.

Sofern die Verfasser die Dokumente unter Open-Content-Lizenzen (insbesondere CC-Lizenzen) zur Verfügung gestellt haben sollten, gelten abweichend von diesen Nutzungsbedingungen die in der dort genannten Lizenz gewährten Nutzungsrechte.

Terms of use:

Documents in EconStor may be saved and copied for your personal and scholarly purposes.

You are not to copy documents for public or commercial purposes, to exhibit the documents publicly, to make them publicly available on the internet, or to distribute or otherwise use the documents in public.

If the documents have been made available under an Open Content Licence (especially Creative Commons Licences), you may exercise further usage rights as specified in the indicated licence.



Do Capital Inflows Hinder Competitiveness? The Real Exchange Rate in Ethiopia

by

Pedro M. G. Martins

Abstract

This paper investigates the determinants of the real exchange rate (RER) in Ethiopia. In particular, it assesses whether large capital inflows (e.g. foreign aid and remittances) have an impact on the RER. This empirical exercise tries to improve the current literature in a number of ways: (i) the use of quarterly data provides a larger sample size and enables the modelling of important intra-year dynamics, which should lead to better model specifications; (ii) the use of several cointegration approaches allows interesting methodological comparisons; and (iii) the use of a time series model (Unobserved Components) provides a new empirical approach and a robustness check on the econometric models. The results suggest two main (long-run) determinants of the RER in Ethiopia: trade openness is found to be correlated with RER depreciations, while a positive shock to the terms of trade tends to appreciate the RER. Foreign aid is not found to have a statistically significant impact, while there is only weak evidence that workers' remittances could be associated with RER appreciations. The lack of empirical support for the Dutch disease hypothesis suggests that Ethiopia has been able to effectively manage large capital inflows, thus avoiding major episodes of macroeconomic instability.

JEL Classification: C22, F35, O24, O55

Keywords: Real Exchange Rate, Foreign Aid, Time Series Models, Africa



Do Capital Inflows Hinder Competitiveness? The Real Exchange Rate in Ethiopia

by

Pedro M. G. Martins

Outline

1. Introduction
2. Theoretical Background
3. Literature Review
4. Methodology
5. Data
6. Empirical Results
7. Conclusion

The Authors

Pedro M. G. Martins was a DPhil student at the Institute of Development Studies (IDS), University of Sussex, UK. Email: pedromgmartins@gmail.com

Acknowledgements

This paper is based on the author's DPhil research, which was financially supported by the *Fundação para a Ciência e a Tecnologia*. The author would also like to thank the comments and suggestions from the participants of an IDS-Sussex seminar in 2009.

1. Introduction

The term 'Dutch disease' is commonly used to describe the potential negative effects of large inflows of foreign currency on the recipient economy.¹ This 'disease' usually manifests itself through the appreciation of the real exchange rate and the consequent loss of export competitiveness. The surge in foreign exchange often takes the form of higher export receipts (e.g. following an increase in natural resource prices), foreign direct investment, workers' remittances or foreign aid inflows. The main focus of this paper will be on the latter two.

The real exchange rate is one important channel through which foreign aid inflows can affect the recipient economy. Concerns about 'Dutch disease' have been recently revived due to the commitment of the international development community to scale up aid flows to developing countries, and in particular to double the resources to Africa. Evidence that foreign aid has had a detrimental effect on the growth of the export sector could offer an explanation for the difficulty of finding robust evidence that aid fosters economic growth. For example, Rajan and Subramanian (2005) argue that aid flows are responsible for the decline in the share of labour intensive and tradable industries in the manufacturing sector – through its contribution to real exchange rate overvaluation.² However, the empirical evidence is mixed, with several studies even suggesting that foreign aid leads to the depreciation of the local currency, potentially through supply side effects or aid tied to imports (Li and Rowe, 2007:17). Moreover, the impact of foreign aid on the composition of (public) expenditure seems to be crucial to the overall effect on the exchange rate. If aid inflows are used to purchase capital goods from abroad (e.g. import support), then they are not likely to have a significant impact on the local currency. However, if the inflows are significantly biased towards the purchase of (non-tradable) local goods, and if there are significant supply-side constraints, then rising domestic inflation will erode the real exchange rate, affecting the competitiveness of the country's exports. These are some of the effects that this empirical exercise will try to uncover in order to improve our understanding of how large aid inflows impact economic performance.

The paper is organised in seven sections. After this short introduction, the theoretical underpinnings of this study will be presented. Section 3 reviews and summarises the empirical evidence from the 'Dutch disease' literature. Section 4 introduces the methodologies to be used in this study, while section 5 draws some considerations about the data. Section 6 presents the

¹ The term was originally coined by *The Economist* to reflect the paradoxical impact of the discovery of natural gas deposits in the North Sea on the Dutch manufacturing sector, through the appreciation of the Dutch real exchange rate.

² The authors do not find similar effects from remittance flows.

empirical results from the econometric models and the structural time series model. Section 7 concludes the paper.

2. Theoretical Background

2.1 Core Dutch Disease Model

This section deals with the theoretical arguments and predictions of the Dutch disease literature. The core model is described in Corden and Neary (1982:826). Their framework assumes a small open economy with three sectors: (i) the booming export sector (e.g. energy); (ii) the lagging export sector (e.g. manufacturing); and (iii) the non-traded goods sector (e.g. services), which supplies the domestic economy. The price of the non-traded good adjusts to equal supply and demand, in contrast to the export sectors where exogenous world prices prevail. The authors describe two main effects of an export sector boom: (i) spending effect; and (ii) resource movement effect. To better understand the *spending effect*, assume that the energy sector does not use any labour. The energy boom will entail higher export earnings and thus higher foreign exchange inflows. It is unlikely that all this extra income will be spent on imports, thus the boom will have an impact on the domestic economy. Provided that the demand for non-tradables rises with income, the boom will create excess demand in the non-tradable sector, increasing their price and leading to real exchange rate appreciation.³ Turning to the *resource movement effect*, assume that the income-elasticity of demand for non-tradables is zero. The increased marginal productivity of labour in the booming export sector raises profitability and the demand for labour in the energy sector. This will push wages up and eventually induce a relocation of labour to the booming sector at the expense of the other two. The fall in employment in the manufacturing sector will contract output ('direct deindustrialization') and the higher price of non-traded goods leads to real exchange rate appreciation. Through these two effects the authors suggest that the traditional export sector is crowded-out by the other two sectors (Ebrahim-zadeh, 2003).

This core model can be adapted to understand the potential impact of a surge in aid inflows, rather than an energy boom (Nkusu, 2004:9).⁴ Foreign aid can be seen as a real income transfer that will raise the demand for both tradable and non-tradable goods produced in the economy. In the context of a small open economy, the increase in the demand of tradable goods will not affect their prices, since these are exogenously determined in world markets. However, the

³ The price of traded goods in the world market remains unchanged (small economy assumption).

⁴ Michaely (1981) is an earlier reference using a two-sector small-country model.

increased demand for non-tradable goods will place an upward pressure on prices, hence, the real exchange rate appreciates (*spending effect*). The profits of exporters are squeezed as the prices for domestic inputs (services, labour, etc.) increase, therefore discouraging the production of tradable goods. Meanwhile, the relative incomes of producers of non-tradable goods are increased.

The appreciation of the RER will materialise regardless of the exchange rate regime. In a *flexible exchange rate regime*, an increase in aid inflows will appreciate the nominal exchange rate as foreign currency is swapped for domestic currency. This appreciation will reduce the value of exports in local currency, which will reduce profitability if production costs such as wages are not adjusted downwards. In a *fixed exchange rate regime*, aid flows will push up the price of domestically produced goods that are in short supply. In both cases, the aid surge will induce an appreciation of the real exchange rate, thus hindering the development of the tradable sector of the economy.

Furthermore, there is also a *resource movement effect*. The increased demand for non-traded goods will push wages up in the sector, bidding labour out of the tradable goods sector – where wages cannot be increased without squeezing the profits. As the marginal product of labour and wages in the non-tradable sector increase, there will be an incentive to relocate labour from the (lagging) tradable sector to the non-tradable sector. The final effect will depend on the factor intensity of the sectors.

Despite the popularity of the arguments presented above, the empirical support for Dutch disease effects has been mixed, especially with regard to aid inflows (as will be demonstrated in section 3). This apparent disagreement between theory and empirical evidence is bridged by Nkusu (2004). The author provides a modified theoretical framework to show that, under certain circumstances, Dutch disease symptoms may not materialise. He uses a Salter-Swan framework with two sectors to illustrate the importance of two crucial assumptions of the core Dutch disease model: (i) full and efficient employment of production factors (i.e. countries produce on their production possibility frontier) and, (ii) perfectly elastic demand for tradables (small-country assumption).

The figure below presents the core Dutch disease model (left panel) and Nkusu's modifications (right panel). The top-left quadrant of each panel represents the tradables market – PT is the price and T the quantity – while the top-right quadrant illustrates the market for non-tradables. Moreover, the bottom-right quadrant presents the production possibility frontier (PPF). The left

panel provides the setting for the core Dutch disease model. The small-country assumption is reflected on the perfectly elastic demand for tradables (horizontal DT), thereby making its price exogenous. The trade balance is in equilibrium (C). In addition, the country produces and consumes on the PPF (B). Hence, a large inflow of foreign aid will increase the demand for non-tradables (DNT to DNT') and its price (PNT to PNT'). Since the price of tradables (PT) remains at the same level, the RER will increase and discourage the production of tradables. This is usually referred to as the *spending effect*. Furthermore, the consequent increase in the supply of non-tradables (SNT to SNT') will occur at the cost of the tradables sector, which contracts from ST to ST' . This is the *resource movement effect*, which is mainly due to the relocation of labour to the non-tradables sector. Nkusu (2004) also makes reference to an *expenditure-switching effect*, which is a disincentive to buy non-tradables due to the RER appreciation. The increase in income (Y to Y'') and the shift from indifference curve ID to ID' will be consistent with a higher demand for tradables, which will create a trade deficit of magnitude $C'C''$.

Figure 1: The Core Dutch Disease and Modified Models

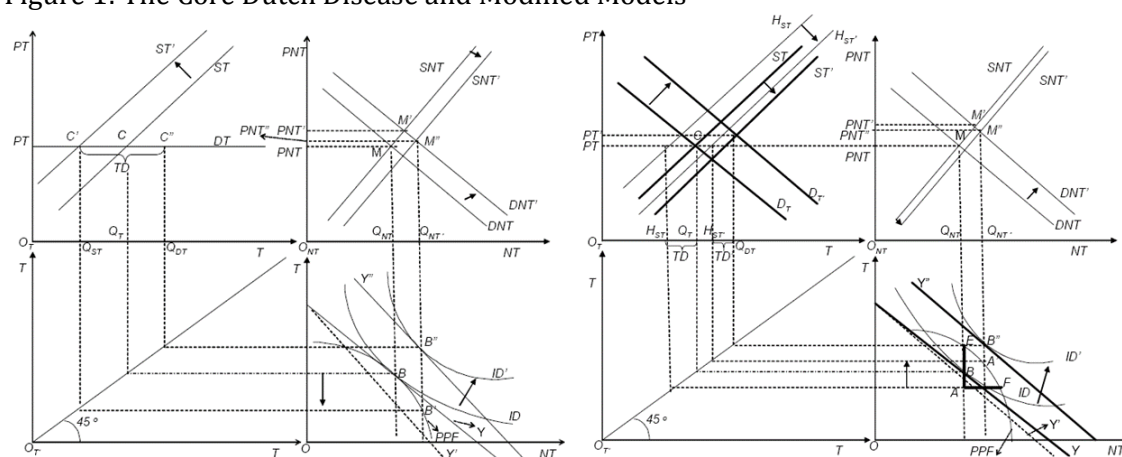

Source: Nkusu (2004:9&12)

Nkusu (2004) proposes two modifications to the core Dutch disease model. Firstly, he argues that many low-income countries (LICs) produce below their potential, and not on the PPF. On the right panel, the country produces at A (within the PPF) and consumes at B . The PPF assumption is synonymous of full-employment and efficient use of the production factors, which is clearly not the case for many LICs suffering from supply-side constraints – high structural unemployment and inefficient use of production factors seems a more plausible assumption. By relaxing this assumption, the extra demand for non-tradable goods brought by aid flows can be accommodated without creating inflationary pressures (especially if aid flows are used to improve productivity).

Secondly, he argues that the small-country assumption is not realistic with regard to many domestically produced importables in LICs. The assumption states that the price of tradable goods is exogenously determined, and hence a surge in aid will place upward pressures on wages, squeezing out profits. However, the author argues that the threat of de-industrialisation is mitigated in LICs where there is imperfect substitutability between domestically produced manufactured goods and imported ones. The imperfect substitutability allows domestic manufacturers to raise prices and increase supply in response to domestic market conditions, such as increased demand, regardless of whether they use imported or domestically produced inputs. Therefore, the demand of tradable goods is represented by a downward-sloping curve (DT). The total supply of tradables (ST) includes home supply (H_{st}) and imports equivalent to the trade deficit (TD). The initial dynamic impact of an increase in aid inflows is similar to the core model. The increase in the demand for non-tradables (DNT), and its respective price (PNT), leads to an increase in supply (SNT). The country now produces at A' (on the PPF) and consumes at B'' . In the modified version, however, the supply of tradables is actually increased (no 'de-industrialisation'), the RER may not appreciate, and the trade balance can be improved.

In summary, Nkusu (2004) suggests that if low-income countries (LICs) can "draw on their idle productive capacity to satisfy the aid-induced increased demand", the appreciation of the exchange rate will be negligible. His theoretical contribution seems to explain why Dutch disease symptoms are not necessarily present in episodes of resource boom and aid surges.⁵ This line of investigation has been taken up by several calibrated general equilibrium models, as described in section 3.

2.2 Determinants of the Real Exchange Rate

The exchange rate is a critical price for an open economy. The exchange rate affects the volume of both imports and exports (by changing their relative prices), as well as the stock of foreign debt in domestic currency terms. In fact, all transactions with the rest of the world can be potentially affected by the level of the exchange rate. A depreciation of the exchange rate is often associated with competitiveness gains, in the sense that the relative price of exports will fall, therefore becoming more attractive to foreign importers. Since imports become relatively more expensive, we usually observe an improvement of the trade balance.⁶ However, since the stock of foreign debt becomes more expensive in local currency, currency depreciations usually

⁵ Moreover, Torvik (2001) uses a learning-by-doing model (with spillovers between the sectors) to show that, in the long-run, a 'foreign exchange gift' induces a real exchange rate depreciation.

⁶ Provided that the Marshall-Lerner condition is met, i.e. the sum of the absolute export and import price elasticities is greater than unity.

worsen a country's debt position and increase interest payments. Moreover, foreign direct investments may benefit from relatively cheaper domestic goods, but revenues in local currency will translate into less foreign currency to repatriate. Finally, foreign aid flows will be able to purchase more domestic goods than before. In addition to the large literature on the merits and shortcomings of devaluations, there is an understanding that excess exchange rate volatility and misalignment can have substantial negative welfare effects. It is therefore not surprising that there is a vast literature trying to uncover the main determinants of the real exchange rate, in order to improve exchange rate policies.

There are two main approaches to understand the behaviour of the real exchange rate (RER). The traditional approach is based on the Purchasing Power Parity (PPP) theory, which defines the RER as the nominal exchange rate corrected by the ratio of the foreign price level to the domestic price level (purchasing power):

$$RER_{PPP} = NER \times \frac{P^*}{P}$$

where P^* and P are foreign and domestic prices, respectively, and the NER is expressed as units of domestic currency per unit of foreign currency. Therefore, a rise [fall] in the RER represents a depreciation [appreciation] of the domestic currency. Depending on the price indices used in the computations, the RER can be seen as the relative price of foreign to domestic consumption or production baskets (Edwards, 1989:5).

The absolute PPP equilibrium condition for a pair of currencies is achieved when the nominal rate ensures that the domestic purchasing powers of the currencies are equivalent. This implies that the RER_{PPP} is equal to 1.

$$NER = \frac{P}{P^*}$$

Hence, the PPP theory is grounded on the law of one price, which suggests that market forces acting on either the prices or the NER (depending on the exchange rate regime) will ensure that relative prices equalise across countries or at least that we have negligible price differentials (Hallwood and MacDonald, 2000:122). Empirically, it is assumed that this PPP relation holds in the long-run with strong mean reversion (stationarity). Another consequence of this approach is that the equilibrium real exchange rate (ERER) is given by a scalar (constant), which is assumed to hold for the entire period. The equilibrium value is often found by looking at the

RER for a relative stable period, when external equilibrium was likely to hold. One way to empirically test this hypothesis is to use regression analysis on the following equation:⁷

$$\ln NER = \alpha + \beta_1 \ln P + \beta_2 \ln P^* + \varepsilon_t$$

If absolute PPP holds, then $\beta_1=1$, $\beta_2=-1$ and $\alpha=0$. However, empirical work has often found little evidence of the validity of this relationship. Movements outside the 'equilibrium' appear to be persistent, indicating that mean reversion is slow (PPP relation is non-stationary). Hence, the effects of a shock take too long to disappear, which is not compatible with the 'arbitrage condition' (i.e. law of one price). This 'PPP puzzle' (Rogoff, 1996) can be explained by a number of reasons. Trade barriers (in the form of quantitative restrictions or taxes), transaction costs and productivity gains are amongst the factors that are likely to influence the path of the RER, thus it is unlikely that a single value of the RER can be seen as 'equilibrium'.

The weaker version of the PPP (relative PPP) accepts that due to market imperfections the relationship may not hold. Instead, this hypothesis states that the percentage change in the NER will equal the inflation differential (in the equation below, $\beta_3=1$ and $\beta_4=-1$). Hence, an increase in relative prices will force the NER to depreciate (law of one price). However, it should be noted that this theory requires that factors such as trade barriers and transaction costs remain constant through time, an assumption that is not likely to hold. In fact, there has been only weak support for this hypothesis.

$$\Delta \ln NER = \beta_3 \Delta \ln P + \beta_4 \Delta \ln P^* + v_t$$

This paper uses an alternative approach to the PPP theory. The equilibrium real exchange rate (ERER) is defined by Edwards (1989:5&8) as the domestic relative price of tradable goods to non-tradable goods that simultaneously attains internal and external equilibrium:

$$RER = \frac{P_T}{P_{NT}}$$

where P_T is the price of tradables (expressed in local currency) and P_{NT} the price of non-tradables. Internal equilibrium is defined as the clearing of the non-tradable goods market, hence with employment at the 'natural' level. External equilibrium is achieved when current account balances are compatible with long-run sustainable capital flows. This definition implies

⁷ Equations from Hallwood and MacDonald (2000:136).

that the EREER is not a constant number, as it depends on a number of real and nominal determinants. It is also important to distinguish between the short-run and the long-run, since some determinants may only have a temporary impact on the EREER. Misalignment is defined as “sustained departures of the actual real exchange rate from its [long-run] equilibrium level” (Edwards, 1989:15). For example, during the 1980s several developing countries had overvalued real exchange rates.

Edwards (1989) constructs a benchmark intertemporal general equilibrium model to analyse the theoretical impact of a number of real disturbances on the EREER. The assessment suggests that an increase in tariffs (trade protectionism) will usually generate an equilibrium real appreciation, while a relaxation of exchange controls (capital account liberalisation) will induce an initial equilibrium real depreciation. Transfers from abroad (e.g. foreign aid) will always result in EREER appreciation. The total effect of other determinants is ambiguous. For example, a worsening of the terms of trade will result in EREER depreciation if the income effect dominates the substitution effect, while the impact of government consumption will depend on its composition – if mainly tradables, then depreciation will ensue. Finally, the impact of technological progress will depend on how the demand (income) and supply effects play out.

3. Literature Review

Notwithstanding the theoretical arguments put forward by Corden and Neary (1982), Corden (1984), van Wijnbergen (1984, 1986)⁸ and Edwards (1989), it has been difficult to establish a robust association between increased aid inflows and the appreciation of the real exchange rate. This section provides an overview of the evidence on the Dutch disease, with special reference to foreign aid inflows. It starts with a brief presentation of the findings of computable general equilibrium (CGE) studies, followed by a survey of the empirical evidence from both cross-country and time series econometrics.⁹

Computable General Equilibrium

⁸ van Wijnbergen (1984:53) argues that Dutch disease is a ‘disease’ because “corrective medicine is needed”.

⁹ CGE simulations do not provide empirical tests of the Dutch Disease hypothesis. However, they can offer insights into the potential size of such effects, provided that the model is a reliable representation of the economy under consideration.

Computable general equilibrium (CGE) models are a useful tool to explore the different dynamics and transmission channels surrounding the Dutch disease hypothesis.¹⁰ Vos (1998) finds that foreign aid inflows induce strong Dutch disease effects in Pakistan, although these symptoms can be mitigated if the flows are used to alleviate investment constraints in the production of traded goods. He also argues that, based on similar models for Mexico, the Philippines and Thailand, the findings for Pakistan are not “easily generalisable and depend strongly on the existing economic structure, investment and savings behaviour of institutional agents, and the allocation of additional capital flows among public and private sector agents.” Bandara (1991:92) also highlights the fact that the standard Dutch disease results depend, to some extent, on the model assumptions, parameter values, and model closure. Moreover, Benjamin (1990) demonstrates that despite the RER appreciation, the tradable sector (manufacturing) only contracts in the short-run, consequently expanding via new investments. Laplagne et al (2001) calibrate a CGE for a typical South Pacific microstate and also find evidence of Dutch disease effects, in particular of the relative contraction of the tradables sector. Collier and Gunning (1992) suggest that foreign aid inflows tend to inhibit the export supply response to liberalisation through a spending effect (relocation of investment and labour into non-tradables).

Over the last couple of years there has been a renewed interest in the subject, partly due to donor commitments to scale up aid resources to developing economies. Adam and Bevan (2006) develop a small dynamic CGE model (calibrated for Uganda) with learning-by-doing externalities where investment in public infrastructure creates an intertemporal productivity spillover. Their simulations show that the supply-side effects of aid-financed public expenditure can outweigh the short-run (demand-side) Dutch disease symptoms, especially if these investments are biased towards the non-tradable sector – therefore increasing the productivity of private factors in the production of domestic goods. Devarajan et al (2008) use a standard neoclassical growth model, based on the Salter-Swan open-economy framework.¹¹ They suggest that concerns of Dutch disease do not materialise if recipients are able to optimally plan consumption and investment over time, a result that is valid for permanent and temporary aid shocks, while not requiring “extreme assumptions or additional productivity story.” However, Dutch disease might become a concern if aid flows are disbursed in an unpredictable or volatile fashion (affecting intertemporal smoothing). Hence, they conclude that “any unfavourable macroeconomic dynamics of scaled-up aid are the result of donor behaviour rather than the functioning of recipient economies.” Cerra et al (2008) use a dynamic dependent-economy

¹⁰ Some studies focus on mitigating policy responses rather than testing the empirical validity of such effects, which are often built-in by construction or dependent on crucial assumptions about the structure of the economy.

¹¹ The model uses data from Madagascar, Mozambique, and the Philippines.

model to show that while untied aid causes a temporary (and small) appreciation of the real exchange rate in the short-run, it does not induce Dutch disease effects in the long-run (i.e. no relative price effects), as long as capital is perfectly mobile between sectors.¹² In contrast, tied aid will cause permanent relative price changes, but the effects will depend on the sectoral allocation of aid: aid flows directed to enhancing productivity in the traded sector will lead to an appreciation of the real exchange rate (Balassa-Samuelson effect), while if directed to the non-traded sector they will lead to a depreciation.

Finally, some studies focus their attention on macroeconomic management policies that have the potential to mitigate the undesirable effects of aid inflows, such as RER appreciation and volatile expenditure patterns. Prati and Tressel (2006) investigate optimal fiscal and monetary policy responses in the context of a model with a closed capital account and learning-by-doing externalities, where foreign aid inflows impact productivity growth through (positive) public expenditure and (negative) Dutch disease effects. They argue that although foreign aid inflows have a negative impact on exports, this effect can be undone by tighter macroeconomic policies. This is achieved through the reduction of the net domestic assets of the central bank ('sterilisation'), which reflects both monetary and fiscal policies. This policy can be effective in preventing RER appreciation when aid is excessively 'front-loaded' (when Dutch disease costs are higher than expenditure and productivity benefits), and thus the economy is better-off saving part of the aid flows for future use. Nonetheless, when foreign aid is excessively 'back-loaded' expansionary policies can improve welfare if the stock of international reserves is large enough. Similarly, Buffie et al (2008, 2004) use an intertemporal optimising model to investigate the monetary and exchange rate policy options available to countries facing persistent shocks to aid flows. They conclude that a 'pure float' regime performs very poorly (RER overshoots), while in a 'crawling peg' regime inflation increases in the short-run. Bond sterilisation will control inflation, but the interest burden will rise. The preferred scenario is a 'managed float', where the central bank "uses unsterilised foreign exchange intervention to target the modest real appreciation needed to absorb the aid inflow." This scenario ensures low real interest rates and a quick macroeconomic adjustment, challenging suggestions that the expansion of domestic liquidity brought by aid flows requires a combination of sterilisation and a free float.

In conclusion, the CGE literature seems to suggest that while Dutch disease remains a concern for macroeconomic management in the short-run, these negative effects can be mitigated, or even reversed, if foreign aid flows induce positive supply-side effects. Moreover, there are a

¹² The model is calibrated for a representative economy.

number of policy tools that can be deployed in order to mitigate the potentially pervasive effects of a windfall of foreign aid. The challenge for empirical econometric studies is to assess whether there is robust evidence of Dutch disease effects, or if these are undone (or at least mitigated) through appropriate macroeconomic policies (e.g. fiscal and exchange rate).

Cross-Country

Most of the empirical studies reviewed in this sub-section use single-equation panel data regressions. Recent works have used dynamic panel data techniques, while one study has employed cointegration analysis. Adenauer and Vagassky (1998) use a panel of four CFA Franc Zone countries (Burkina Faso, Côte d'Ivoire, Senegal and Togo) to estimate the impact of foreign aid flows on the RER. Their GLS results suggest that both foreign aid and the terms of trade are correlated with RER appreciations. Moreover, real GDP and a proxy for technological differentials¹³ were not statistically significant. Ouattara and Strobl (2004) expand the previous analysis to 12 countries of the CFA Franc Zone and obtain quite different results. Their application of a dynamic panel data (DPD) estimator indicates that foreign aid flows (ODA) and the ratio of exports and imports to GDP (proxy for openness) tend to cause the RER to depreciate. In contrast, the ratio of government consumption to GDP, the terms of trade, and the ratio of domestic credit to GDP (proxy for monetary policy) induce RER appreciation. Lartey (2007) also utilises a DPD setting for 16 sub-Saharan African countries over the period 1980-2000. He finds that while FDI and ODA flows lead to a RER appreciation, other capital flows do not have a significant impact. Moreover, government expenditure also seems to cause the RER to appreciate, while openness has the opposite effect. Excess money growth (difference between the growth rates of M2 and GDP) is not significant in most specifications.

Table 1: Results from Selected Cross-Country 'Dutch Disease' Studies

Main Studies	Sample	Aid	Methodology	RER
Mongardini & Rayner (2009)	36 SSA (1980-06)	DAC	Panel (PMG)	-
Lartey (2007)	16 SSA (1980-00)	WB	Panel (DPD/GMM)	+
Ouattara & Strobl (2004)	12 CFA Franc Zone (1980-00)	DAC	Panel (DPD/GMM)	-
Elbadawi (1999)	62 developing (1990 & 95)	DAC	Panel (RE, FE, IV)	+
Yano & Nugent (1999)	44 aid-dependent (1970-90)	DAC	Mixed (TS, CS)	+
Adenauer & Vagassky (1998)	4 CFA Franc Zone (1980-92)	WB+	Panel (GLS)	+

Obs.: '+' appreciation, '-' depreciation, PMG Pooled Mean Group, DPD Dynamic Panel Data, GMM Generalised Method of Moments, RE Random Effects, IV Instrumental Variables, TS Time Series, CS Cross-Section.

Elbadawi (1999) presents results from a panel of 62 developing countries (28 of them from Africa). He finds that, apart from the degree of openness, all other variables contribute to the

¹³ They use a measure capturing the growth rate differences between the country and industrial countries (the Balassa-Samuelson effect).

overvaluation of the RER, namely: ratio of ODA to GNP, ratio of net foreign income to GNP, index of productivity, terms of trade, and the ratio of government consumption to GDP. Yano and Nugent (1999) argue that aid flows are associated with an expansion of the non-traded sector, thus explaining the transfer paradox. Mongardini and Rayner (2009) use the pooled mean group (PMG) estimator for a panel of 36 sub-Saharan African countries. Their results suggest that grants are associated with RER depreciations, while remittances do not have a statistically significant effect. Moreover, terms of trade and openness are correlated with appreciation and depreciation, respectively. Finally, Prati et al (2003) estimate the impact of aid flows on the real black market effective exchange rate for several developing countries for the period 1960-1998. They use fixed-effects as well as Arellano-Bond's GMM estimator. Other variables include a commodity price index, and the central bank's net domestic assets. ODA is assumed to be stationary on 'economic grounds'. The authors find that aid flows tend to appreciate the black-market RER.

Time Series

This section provides a summary of empirical studies using time series methods. Following recent developments in time series econometrics, most studies reported in this section use cointegration analysis to avoid inference based on spurious relations. Moreover, this strategy has the advantage of separating the long-run (steady-state) information from the short-run dynamics. The empirical results (for the long-run) with regard to the impact of aid inflows on the RER are reported in the table below. Unless otherwise stated, 'openness' is measured by the ratio of total trade (export plus imports) to GDP and 'terms of trade' by the ratio of export to import price indices. It should also be noted that, perhaps surprisingly, no study has reported an insignificant impact of aid flows on the RER.¹⁴

Table 2: Results from Selected Time Series 'Dutch Disease' Studies

Main Studies	Sample	Aid	Methodology	RER
Issa & Ouattara (2008)	Syria (1965-1997)	DAC	UECM (OLS)	-
Li & Rowe (2007)	Tanzania (1970-05)	DAC	EG (FM-OLS)	-
Bourdet & Falck (2006)	Cape Verde (1980-00)	WB	EG (OLS)	+
Opoku-Afari et al (2004)	Ghana (1966-00)	DAC	VECM (MLE)	+
Sackey (2001)	Ghana (1962-96)	DAC	UECM (OLS)	-
Nyoni (1998)	Tanzania (1967-93)	DAC	UECM (OLS)	-
Ogun (1998)	Nigeria (1965-90)	n/a †	Differences (OLS)	(+)
White & Wignaraja (1992)	Sri Lanka (1974-88)	Local ‡	Levels (OLS)	+

Obs.: '+' appreciation, '-' depreciation, ARDL Auto Regressive Distributed Lag, EG Engle-Granger Two-Step Approach, OLS Ordinary Least Squares, VECM Vector Error Correction Model, MLE Maximum Likelihood Estimator, UECM Unrestricted Error Correction Model, FMOLS Fully-Modified OLS. † Capital Flows, ‡ Includes Remittances. Younger (1992) does not undertake an econometric exercise (Ghana).

¹⁴ This could be seen as a symptom of 'publication bias'.

The results from Bourdet and Falck (2006) for Cape Verde, Opoku-Afari et al (2004) for Ghana, Ogun (1998) for Nigeria, and White and Wignaraja (1992) for Sri Lanka seem to suggest that foreign aid inflows are associated with appreciations of the real exchange rate. Bourdet and Falck (2006) investigate the determinants of the Cape Verdean real exchange rate. Their results suggest that remittances (ratio of private transfers to GDP), aid inflows (ratio of net ODA to GDP), the terms of trade, growth of excess credit¹⁵ and technological change (time trend) are the factors that contribute to RER appreciations, while openness has the opposite effect. Opoku-Afari et al (2004) reach similar conclusions for Ghana. However, their study goes beyond the estimation of a single-equation and uses a system-based methodology. They use three alternative measures of capital flows: (i) inflows that require repayment (e.g. aid loans, foreign debt, etc.); (ii) 'permanent' flows (i.e. grants, remittances and FDI); and (iii) aid grants and loans. The capital inflow measure and the terms of trade are shown to appreciate the RER, while openness¹⁶ and technological change (measured by total factor productivity) tend to depreciate the RER.¹⁷

Ogun (1998) also attempts to estimate the long-run determinants of the RER, but fails to find a cointegrating relation amongst the variables. He suggests that, in the case of Nigeria, the 'fundamentals' (real variables) only have short-run effects on the RER. His results indicate that net capital inflows (proxied by the capital account balance), government expenditure on non-tradables and excess credit¹⁸ tend to appreciate the RER, while openness,¹⁹ technological progress (proxied by the growth rate of real income) and nominal devaluations of the NER induce a RER depreciation. The (income) terms of trade have no significant impact. Finally, White and Wignaraja (1992) investigate the failure of nominal devaluations to translate into a competitive RER in Sri Lanka, but do not use cointegration analysis. The authors find that the growing divergence between the real and nominal exchange rates can be attributed to the increase in total transfers (aid and remittances), which have created such upward pressures on the RER (via high domestic inflation) that the devaluation strategy pursued had little effect on competitiveness. Their results also suggest that the terms of trade and changes in the nominal

¹⁵ Rate of growth of domestic credit minus rate of growth of real GDP lagged one period.

¹⁶ They also use the imports-to-GDP ratio and the ratio of imports to domestic absorption (i.e. GDP plus imports minus exports) as alternative measures.

¹⁷ We ought to be careful with the interpretation of the results, since inference from a VAR is not straightforward.

¹⁸ Ratio of domestic credit to M2 minus rate of growth of real income minus log NER minus log US WPI (used as an index of macroeconomic imbalances).

¹⁹ Here measured by the parallel market exchange rate premium, which is used as an index of the severity of trade restrictions and capital controls. Ogun (1998:11) suggests that this variable is preferred to the usual trade ratio because of the dominating influence of oil exports in the country's total exports.

exchange rate tend to depreciate the RER, while total borrowing, investment, and excess credit creation have no significant impact.

In contrast to the evidence presented above on Dutch disease, the findings from Issa and Ouattara (2008) for Syria, Li and Rowe (2007) for Tanzania, Sackey (2001) for Ghana, and Nyoni (1998) for Tanzania suggest that foreign aid flows are associated with RER depreciation, rather than appreciation. Issa and Ouattara (2008:137) base their model on Edwards (1989) to analyse the determinants of the RER for Syria. Their results show that net ODA flows are associated with RER depreciation, while openness and GDP per capita have the opposite effect. The terms of trade, government expenditure, and growth of M2 (proxy for expansionary monetary policies) are not significant in their (long-run) specification. Li and Rowe (2007) argue that in Tanzania foreign aid and openness create downward pressures in the RER, while an improvement in the terms of trade (real commodity price index) seems to cause the appreciation of the RER. Moreover, the ratio of real GDP per capita in Tanzania relative to its major trading partners (to measure relative productivity differentials, and capturing Balassa-Samuelson effects), and government investment as a percentage of GDP were not significant. Central bank reserves were included in the error correction specification (short-run) and found to depreciate the RER. Moreover, Sackey (2001) shows that the terms of trade and net ODA create downward pressures on the RER, while government consumption as a share of GDP, the parallel market premium (proxy for commercial policy stance), and the index of agricultural production (technological progress) entail RER appreciation. The result for the terms of trade implies that the substitution effect dominates the income effect. Nominal devaluations lead to (short-run) RER depreciation. Finally, Nyoni (1998) finds that net ODA and increased openness induce RER depreciation, while increased government expenditure as percentage of GDP caused the appreciation of the RER. External terms of trade and technological change (proxied by a time trend) do not have a long-run impact on the RER, while devaluations of the local currency have an expected (short-run) impact on the RER.

Overall, these studies seem to point to important empirical regularities: the terms of trade and government expenditure seem to appreciate the RER, while openness has an opposite effect. However, with regard to the impact of aid inflows, the results seem to be mixed (even when the same country is under scrutiny, e.g. Ghana). These apparent contradictions of the (long-run) impact of aid inflows on the RER may be explained by a number of factors: (i) the impact on competitiveness depends on the structure of the economy and/or country-specific aid dynamics; (ii) some studies may ignore other aspects that affect the RER (other flows, trade policies, etc); and (iii) the use of different methodologies (e.g. cointegration).

Table 3: Main RER Determinants

Main Studies	Aid	ToT	Open	ExM	GE	TP	RES	dNER
Issa & Ouattara (2008)	- (-)	0 (0)	+ (+)	0 (0)	0 (-)	+ (+)		
Bourdet & Falck (2006)	+ (•)	+ (•)	- (•)	+ (•)		+ (•)		
Li and Rowe (2007)	- (-)	+ (0)	- (-)		0(0)	0 (0)	• (-)	
Opoku-Afari et al (2004)	+	+	-		0	-		
Sackey (2001)	- (-)	- (0)			+ (+)	+ (+)		• (-)
Nyoni (1998)	- (-)	0 (0)	- (-)	• (0)	+ (+)	0 (•)		• (-)
Ogun (1998)	• (+) [†]	• (0)	• (-)	• (+)	• (+)	• (-)		• (-)
White & Wignaraja (1992)	+	-		0				-
Mongardini and Rayner (2009)	-	+	-			+		
Lartey (2007)	+		-	0	+			
Ouattara & Strobl (2004)	-	+	-	+	+			
Elbadawi (1999)	+	+	-		+	+		
Yano & Nugent (1999)								
Adenauer & Vagassky (1998)	+	+				0		

Obs.: [†]Net capital inflows, '+' appreciation, '-' depreciation. '0' negligible, '•' not applicable. Short-run effects are in brackets. ExM Excess money or domestic credit, GE Government expenditure (composition depends on the paper), TP Technological change or productivity, RES change in reserves.

However, there are a number of other related concerns that can affect the model estimates: (i) the scarce number of observations; (ii) potential structural breaks; (iii) the composition and timing for the aid variable; and (iv) endogeneity. We take these in turn. Amongst the studies surveyed here, the largest sample contains 35 yearly observations, which can be a problem if the model includes several regressors and a long lag structure. Moreover, most samples are likely to contain structural breaks, since they include periods where exchange rate markets were highly regulated and the macroeconomic policies pursued were rather different (mainly 1970s and 1980s). In this regard, the use of quarterly data will enable us to analyse the behaviour of the RER over a shorter time period (1995-2008), and therefore avoid major structural breaks. In terms of the aid variable, data is usually taken from OECD-DAC. The problem, however, is that data reported from donors is likely to include items that do not have an impact on the exchange rate. For example, aid in kind (food aid) is not likely to have a significant impact on the real exchange rate, while a substantial share of technical assistance payments do not even leave the donor country. Another issue relates to the timing of transactions, since donors may record disbursements in a different period from the recipient country. Ideally, we should recover data on grants and concessional loans from the central bank's balance of payments statistics. Finally, the single-equation approach may impose strong exogeneity conditions on the regressors. The estimates can be significantly biased in case there are unmodelled feedback effects from the RER to other variables. The only study analysed here that uses a system approach is Opoku-Afari et al (2004). However, potential misspecification

errors in one equation of the system would be propagated to the entire model,²⁰ while its finite-sample properties may be undesirable (Greene, 2003:413). The decision to use single-equation frameworks is based on two main premises: (i) the argument for endogeneity of most explanatory variables used in this paper is not particularly strong (e.g. remittances or aid flows are not likely to be responsive to the RER level); and (ii) some of the cointegration methods used in this paper provide corrections for endogeneity.

4. Methodology

While the core Dutch disease model developed by Corden and Neary (1982) is an important reference point for analytical assessments of the impact of capital inflows on the RER, empirical investigations have traditionally used the equilibrium real exchange rate (ERER) approach proposed by Edwards (1989). Moreover, the methodologies used in this paper follow recent developments in time series econometrics and thus incorporate cointegration analysis. The problem of spurious regressions is highlighted in Granger and Newbold (1974) and Davidson and MacKinnon (1993). They provide Monte Carlo simulations to illustrate how independent variables can very often have statistically significant t -ratios. This happens because the t -statistic does not have a limiting standard normal distribution (and the behaviour of R^2 is non-standard) in the presence of non-stationarity (Wooldridge, 2003). Hence, most modern econometric analysis starts by assessing the properties of the variables, namely the order of integration of the each series. This is usually done through the use of augmented Dickey-Fuller (ADF) tests on univariate $AR(p)$ processes with appropriate deterministic components. Provided that some variables are found to be non-stationary, cointegration analysis should be undertaken. Another advantage of using a cointegration framework is that we may be able to separate the long-run effects from the short-run. This is crucial to disentangle the ERER from the disequilibrium RER.

Edwards (1989:133-7) suggests that the dynamic behaviour of the RER can be captured by:

$$\Delta \ln e_t = \theta(\ln e_t^* - \ln e_{t-1}) - \lambda(Z_t - Z_t^*) + \phi(\ln E_t - \ln E_{t-1})$$

where e_t is the actual RER, e_t^* is the ERER, Z_t is an index of macroeconomic policies, Z_t^* is the sustainable level of macroeconomic policies, E_t is the nominal exchange rate, θ is the adjustment

²⁰ For example, if the aid variable cannot be satisfactorily modelled by the remaining variables in the system, the misspecification errors on the aid equation will affect the entire model.

coefficient of the self-correcting term,²¹ λ reflects pressures associated with unsustainable macroeconomic policies (e.g. excess credit), and ϕ provides information about the impact of nominal devaluations. The long-run determinants ('fundamentals') of the ERE are described by:

$$\ln e_t^* = \beta_0 + \beta_1 \ln \text{TOT}_t + \beta_2 \ln \text{GCN}_t + \beta_3 \ln \text{CAP}_t + \beta_4 \ln \text{EXC}_t + \beta_5 \ln \text{TEC}_t + \beta_6 \ln \text{INV}_t + \varepsilon_t$$

where TOT is the external terms of trade, GCN government consumption of nontradables, CAP controls on capital flows, EXC index of severity of trade restrictions and exchange controls (proxied by the spread), TEC measure of technological progress, and INV ratio of investment to GDP. Finally, he defines the index of macroeconomic policies by excess supply of domestic credit (CRE) and the ratio of fiscal deficit to lagged high-powered money (DEH). Thus the typical equation to be estimated is:²²

$$\begin{aligned} \ln e_t^* = & \gamma_0 + \gamma_1 \ln \text{TOT}_t + \gamma_2 \ln \text{GCN}_t + \gamma_3 \ln \text{CAP}_t + \gamma_4 \ln \text{EXC}_t + \gamma_5 \ln \text{TEC}_t + \gamma_6 \ln \text{INV}_t \\ & + (1 - \theta) \ln e_{t-1} - \lambda_1 \text{CRE}_t - \lambda_2 \text{DEH}_t + \phi \text{DEV}_t + \varepsilon_t \end{aligned}$$

where DEV is the nominal devaluation defined before ($\ln E_t - \ln E_t^*$), and the γ 's are combinations of the β and θ . The specific variables to be included in this study, along with their expected signs, will be presented in section 5. For now, we continue with a description of alternative estimation methods.

4.1 Econometric Models

Engle-Granger Approach (EG)

Engle and Granger (1987) propose a two-step approach to cointegration when variables are I(1). The first step entails the estimation of the long-run (static) equation by OLS and, subsequently, testing the stationarity of the estimated residuals (ε_t) through an augmented Dickey-Fuller (ADF) test. The critical values are usually taken from MacKinnon (1996).

$$y_t = \beta_0 + \beta_1 x_t + \varepsilon_t$$

²¹ Under pegged nominal rates, this adjustment takes place via changes in the price of nontradable goods.

²² This is obtained by replacing the equation of the RER determinants and the index of macroeconomic policies into the dynamic equation.

OLS estimates of β_1 are super-consistent in the presence of cointegration,²³ even though the usual standard errors are not reliable. If the residuals are found to be non-stationary, then the variables are not cointegrated and the results obtained potentially spurious. However, if the residuals are stationary, then there is a meaningful long-run relationship between the variables. In the second step, the estimated residuals are used to estimate an error-correction model (ECM) to analyse the dynamic effects:

$$A(L)\Delta y_t = B(L)\Delta x_t + \alpha(\hat{\varepsilon}_{t-1}) + v_t$$

where A and B are polynomials in the lag operator (L), and α the speed of adjustment. However, this procedure has some well-known weaknesses. Although β is super-consistent, Banerjee et al (1986) prove that the omission of dynamic terms (in the static equation) in small samples can generate considerable bias in the estimation of β (Maddala and Kim, 1998:162). Moreover, the results may depend on the order of the variables,²⁴ the step-wise procedure means that potential errors in the first step are transmitted to the second (compounding), and cointegration relies on (low power) unit root tests. Finally, because the standard errors are not reliable, it is not possible to apply statistical tests on β_1 – estimates are consistent but not fully efficient.

Unrestricted Error Correction Model (ECM)

An alternative to the Engle-Granger approach is to estimate directly the ECM presented above, transforming it into a one-step procedure. The estimated error term in the EG procedure is replaced by the potential cointegrating vector.

$$A(L)\Delta y_t = B(L)\Delta x_t + \alpha(y_{t-1} - \beta_0 - \beta_1 x_{t-1}) + v_t$$

It can be shown that this is a reformulation of the autoregressive distributed lag (ARDL) model. Start with the bivariate ARDL(p,q):

$$y_t = \mu + \sum_{i=1}^p \delta_i y_{t-i} + \sum_{j=0}^q \gamma_j x_{t-j} + \varepsilon_t$$

²³ The estimated (cointegrating) coefficients converge quickly to their true value (at a speed T^{-1} instead of $T^{-1/2}$), allowing the dynamic terms to be ignored.

²⁴ Our decision about endogeneity is likely to have an impact on the results (Asteriou and Hall, 2006:317). For example, if we regress x on y , we may find a cointegrating vector that may not emerge if we regress y on x .

where μ includes deterministic components, δ_i are coefficients of the autoregressive components (i.e. lags of the endogenous variable), γ_j are coefficients for the current and lagged values of the exogenous variable. It can be easily shown that a reparametrisation²⁵ yields the following ECM:

$$\Delta y_t = \mu + \sum_{i=1}^{p-1} \delta_i \Delta y_{t-i} + \sum_{j=0}^{q-1} \gamma_j \Delta x_{t-j} + \alpha y_{t-1} + \omega x_{t-1} + \varepsilon_t$$

$$\alpha = -\left(1 - \sum_{i=1}^p \delta_i\right) \quad \text{and} \quad \omega = \sum_{i=0}^q \gamma_i$$

where α and ω contain information on the long-run impacts and adjustment to equilibrium. The long-run information (β_1) is recovered by dividing the estimated coefficient on x_{t-1} by the estimated coefficient on y_{t-1} (α). This approach has the advantage of not imposing restrictions on the short-run terms (therefore the name ‘unrestricted’ ECM), while combining information about the long-run and short-run effects in the same equation. In fact, we obtain precise estimates of the long-run coefficients and we have valid t -ratios for the short-run coefficients.

The ECM equation can be estimated by OLS, whilst there are two main approaches to test for cointegration: (i) an ECM or t -test on the coefficient of the lagged dependent variable (α), or (ii) a Wald or F -test for the joint significance of the long-run coefficients (α and ω). However, since these tests have a non-standard distribution, the asymptotic critical values have to be obtained by simulation. Banerjee et al (1998) propose a version of the t -test and report the respective critical values. Pesaran et al (2001) suggest the use of an F -test, which is particularly suitable when we are not certain about the order of integration of the variables. This means that we are able to combine both $I(0)$ and $I(1)$ variables (i.e. trend- and first-difference stationary), which eases problems related to pre-testing such as the low power of unit root tests. However, the major drawback is that the simulations only provide lower and upper bounds for the critical region. Therefore, this ‘bounds testing approach’ creates an inconclusive region where no inference about cointegration can be made.

Dynamic OLS (DOLS)

²⁵ Replacing y_t by $(\Delta y_t + y_{t-1})$, etc. (Asteriou and Hall, 2006:311-4).

The DOLS approach, originally proposed by Saikkonen (1991), improves the asymptotic efficiency of the OLS estimator for the static relation by using available stationary information. In practice, it takes into account potential endogeneity biases by adding leads and lags of the first-differenced explanatory variables to the steady-state specification:

$$y_t = \beta_0 + \sum_{i=1}^n \beta_i x_{i,t} + \sum_{i=1}^n \sum_{j=-k_1}^{k_2} \gamma_{i,j} \Delta x_{i,t-j} + \varepsilon_t$$

where x_i is a vector of exogenous variables, while k_1 and k_2 denote the order of leads and lags, respectively. These are often chosen by standard information criteria. The OLS estimates of β_i (long-run coefficients) are super-consistent and the respective t -ratios valid, although the standard errors need to be corrected for serial correlation. Stock and Watson (1993) propose a GLS correction (which they call DGLS) to obtain heteroscedasticity and autocorrelation consistent (HAC) estimators for the covariance matrix. Alternatively, we can use the Newey-West (1987) procedure (Zivot and Wang, 2006:451).²⁶ Cointegration can be tested through a standard ADF test on the regression residuals.

Fully-Modified OLS (FMOLS)

The unrestricted ECM method aims to obtain asymptotically efficient estimates of the cointegrating vector through the inclusion of an ECM term, whereas the DOLS approach involves adding leads and lags of the first-differenced regressors. The FMOLS approach, however, applies semi-parametric corrections to deal with endogeneity and serial correlation in the OLS estimator (Maddala and Kim, 1998:161). This method was originally suggested by Phillips and Hansen (1990) and allows for both deterministic and stochastic regressors. Although it does not require a modification of the original (static) specification, it requires two steps, which may affect its performance.²⁷ In fact, Pesaran and Shin (1999:403) use Monte Carlo simulations to suggest that the ARDL approach performs better than the FMOLS in small samples. The presence of a cointegrating relationship can be evaluated through an ADF test on the regression residuals, while the Wald statistic for testing coefficient restrictions can be shown to have an asymptotic Chi-square distribution.

²⁶ “The Newey-West estimator provides a way to calculate consistent covariance matrices in the presence of both serial correlation and heteroscedasticity” (Johnston and DiNardo, 1997:333).

²⁷ The first step entails the estimation of the static long-run relation, and in the second step, we re-estimate the long-run residual covariance matrix (bias adjusted).

4.2 Structural Time Series Model

The main strength of time series models lies in their capacity to summarise the relevant properties of the data. In contrast to econometric models, a pure time series model ignores the role of explanatory variables and does not attempt to uncover economic behavioural relationships. Instead, the focus is on modelling the time series behaviour in terms of sophisticated extrapolation mechanisms to produce efficient forecasts (Kennedy, 2003:319). In recent times, the methodological gap between econometrics and time series analysis has been curbed by a number of factors. The finding that time series models tend to outperform forecasts produced by classic econometric models was taken as a strong indication that the latter were misspecified – they usually lacked a dynamic structure. Moreover, the increasing evidence of ‘spurious regressions’ in the context of non-stationary data also forced a rethink of econometric models. In practice, this led to the rise of vector autoregressive and error correction models.

Meanwhile, time series researchers were confronted with the lack of economic interpretation of their models. This led to some modelling developments, namely the combination of univariate time series analysis and econometric regressions. Two main strategies have successfully emerged: (a) mixed models, where a time series model is extended to incorporate current and/or lagged values of explanatory variables; and (b) multivariate time series models, where a set of variables is jointly analysed.

The rationale behind mixed models is that explanatory variables will only partly account for the behaviour of the variable of interest (y_t), with some degree of non-stationarity likely to remain in the system. Hence, while dynamic regression models are assumed to provide a full behavioural explanation of the process (disturbance term assumed to be stationary), a mixed model will allow a time series component to capture any left-over non-stationarity (Harvey, 1993:152-4).²⁸ This is particularly useful for the analysis of the long-run, where it is often difficult to find cointegration between a set of variables proposed by economic theory. In this case, we can specify a dynamic model with both explanatory variables and a stochastic trend to fully account for the movements in y_t .

State Space Form

The state space form is often a useful way to specify a wide range of time series models. The application of the Kalman filter can then provide algorithms for smoothing and prediction, as

²⁸ Moreover, we avoid problems of size and power usually found in unit root and cointegration tests.

well as a means to constructing the likelihood function (Harvey, 1993:82&181). The main concepts are now briefly explained for the univariate case, but these can be easily extended to a multivariate context. The observed variable y_t is related to the *state vector* α_t via the following *measurement equation* (Lutkepohl, 2005:611):

$$y_t = Z_t \alpha_t + \varepsilon_t$$

where Z_t is a matrix of coefficients that may depend on time, and ε_t is the observation error (usually taken as a white noise process). The elements of α_t are usually not observable, but are known to follow a first-order Markov process (Harvey, 1993:83). This can be expressed by the following *transition equation*:

$$\alpha_t = T_t \alpha_{t-1} + \eta_t$$

where T_t is a matrix of coefficients, which again can be time-dependent, and η_t is a white noise error process (uncorrelated to ε_t). A state space model will necessarily comprise both measurement and transition equations.

Unobserved Components (UC) Model

The exposition here follows Koopman et al (2007:171). The univariate structural time series model can be represented by the following measurement equation:

$$y_t = \mu_t + \psi_t + \gamma_t + \varepsilon_t$$

where y_t is the observed variable, μ_t is the trend, ψ_t the cycle, γ_t the seasonal, and ε_t the irregular component. All the components are assumed to be stochastic, but reduce to deterministic components as a limiting case. The stochastic trend is specified by the following transition equations:

$$\begin{aligned} \mu_t &= \mu_{t-1} + \beta_{t-1} + \eta_t \\ \beta_t &= \beta_{t-1} + \zeta_t \end{aligned}$$

where β_t is the slope of the trend, η_t (level disturbance) and ζ_t (slope disturbance) are independent white noise processes, therefore uncorrelated with the irregular component. The table below presents alternative specifications of the trend.

Table 4: Level and Trend Specifications

Level	σ_ε	σ_η	
Constant term	*	0	
Local level	*	*	
Random walk	0	*	
Trend	σ_ε	σ_η	σ_ζ
Deterministic	*	0	0
Local level with fixed slope	*	*	0
Random walk with fixed drift	0	*	0
Local linear	*	*	*
Smooth trend	*	0	*
Second differencing	0	0	*
Hodrick-Prescott	*	0	$0.025\sigma_\varepsilon$

Obs.: '*' indicates any positive number.

Source: Koopman et al (2007, Table 9.1)

The seasonal component is specified by the trigonometric seasonal form:

$$\gamma_t = \sum_{j=1}^{[s/2]} \gamma_{j,t}$$

where each $\gamma_{j,t}$ is generated by:

$$\begin{bmatrix} \gamma_{j,t} \\ \gamma_{j,t}^* \end{bmatrix} = \begin{bmatrix} \cos\lambda_j & \sin\lambda_j \\ -\sin\lambda_j & \cos\lambda_j \end{bmatrix} \begin{bmatrix} \gamma_{j,t-1} \\ \gamma_{j,t-1}^* \end{bmatrix} + \begin{bmatrix} \omega_{j,t} \\ \omega_{j,t}^* \end{bmatrix}, \quad j = 1, \dots, [s/2], \quad t = 1, \dots, T$$

where $\lambda_j = 2\pi j/s$ is the frequency in radians, and the seasonal disturbances (ω_t and ω_t^*) are mutually uncorrelated white noise processes with common variance. Finally, the cycle is specified as:

$$\begin{bmatrix} \psi_t \\ \psi_t^* \end{bmatrix} = \rho_\psi \begin{bmatrix} \cos\lambda_c & \sin\lambda_c \\ -\sin\lambda_c & \cos\lambda_c \end{bmatrix} \begin{bmatrix} \psi_{t-1} \\ \psi_{t-1}^* \end{bmatrix} + \begin{bmatrix} \kappa_t \\ \kappa_t^* \end{bmatrix}, \quad t = 1, \dots, T$$

Where ρ_ψ is a damping factor (with a range $0 < \rho_\psi \leq 1$), λ_c is the frequency in radians (with a range $0 \leq \lambda_c \leq \pi$), and the cycle disturbances (κ_t and κ_t^*) are mutually uncorrelated white noise processes with common variance.

Harvey's (1993:142) basic structural model (BSM) is often a good starting point for the analysis of time series data. The model is similar to the general univariate case specified above, except

for the cycle component, which is excluded. The BSM can thus be written in the following compact form:

$$y_t = [1 \ 0 \ 1 \ 0 \ 0]\alpha_t + \varepsilon_t$$

$$\alpha_t = \begin{bmatrix} \mu_t \\ \beta_t \\ \gamma_t \\ \gamma_{t-1} \\ \gamma_{t-2} \end{bmatrix} = \begin{bmatrix} 1 & 1 & 0 & 0 & 0 \\ 0 & 1 & 0 & 0 & 0 \\ 0 & 0 & -1 & -1 & -1 \\ 0 & 0 & 1 & 0 & 0 \\ 0 & 0 & 0 & 1 & 0 \end{bmatrix} \begin{bmatrix} \mu_{t-1} \\ \beta_{t-1} \\ \gamma_{t-1} \\ \gamma_{t-2} \\ \gamma_{t-3} \end{bmatrix} + \begin{bmatrix} \eta_t \\ \zeta_t \\ \omega_t \\ 0 \\ 0 \end{bmatrix}$$

Explanatory Variables and Interventions

The model presented above can be extended to include current and lagged values of explanatory variable, lags of the endogenous variable, as well as intervention dummies. The model can then be written as:

$$y_t = \mu_t + \psi_t + \gamma_t + \varepsilon_t + \sum_{\tau=1}^p \phi_\tau y_{t-\tau} + \sum_{i=1}^k \sum_{\tau=0}^q \alpha_{i\tau} x_{i,t-\tau} + \sum_{j=1}^h \lambda_j \varpi_{j,t}$$

where x_{it} are exogenous variables, ϖ_{jt} are intervention dummy variables (e.g. impulse, level or slope), while ϕ_τ , $\alpha_{i\tau}$ and λ_j are unknown matrices.

This ‘mixed model’ is a valuable complement to traditional econometric analysis. Since explanatory variables are often not able to account for all the variation in y_t , we allow the unobserved components to capture ‘left over’ stochastic behaviour – trend or seasonal (Harvey, 1993:152).

5. Data

5.1 Data Construction

Nominal Exchange Rate

The Ethiopian birr was pegged to the United States dollar (USD) from its inception in 1945 until the early 1990s. The birr was valued at 2.50 per USD before the collapse of the Bretton Woods system in 1971, which forced an initial revaluation to 2.30 and then in 1973 to 2.07 per USD. The macroeconomic policies of the Derg regime (1974-1991) contributed to a significant overvaluation of the birr. In 1992, the transitional government devalued the birr to 5.00 per USD, and several (smaller) devaluations followed. A foreign exchange ‘Dutch auction’ system was introduced in 1993, mainly supported by foreign aid and, to some extent, by export earnings (Geda 2006:28). For two years the official and auction-based (marginal) rates co-existed in a dual exchange rate system before they were unified in 1995. In October 2001, a foreign exchange interbank market was established. The current exchange rate system is classified as a (de facto) crawling peg to the USD, i.e. a managed (or dirty) float.²⁹

Table 5: Chronology of Main Events and Exchange Rates (Birr per USD)

Period	Event	Official	Parallel	Premium (%)
1945:07	Currency Proclamation	2.48	n/a	n/a
1964:01	Devaluation	2.50	n/a	n/a
1971:12	Revaluation (Collapse of Gold Standard)	2.30	2.44	6.1
1973:02	Revaluation	2.07	2.16	4.3
1992:10	Devaluation	5.00	12.75	155.0
1993:05	Introduction of an Auction System (fortnight)	5.00	13.30	166.0
1995:07	Unification of the Official and Auction rates	6.25	10.55	68.8
2001:10	Introduction of an Interbank Market (daily)	8.53	8.70	2.0

Source: National Bank of Ethiopia and Pick's Currency Yearbook.

Obs.: From 1945 to 1976 the currency was called Ethiopian Dollar (E\$). The Bretton Woods Agreement established 1E\$ = 0.36g of fine gold.

One consequence of the gradual liberalisation of the exchange rate was the significant reduction in the parallel exchange rate premium (Degefa, 2001). The graph below plots the official and parallel exchange rates to the USD.

²⁹ See www.imf.org/external/np/mfd/er/2008/eng/0408.htm. This means that the central bank (actively) intervenes in the foreign exchange market (by buying or selling foreign exchange) to allow a gradual devaluation of the birr.

Figure 2: Official and Parallel Exchange Rates (ETB per USD): 1981-2008

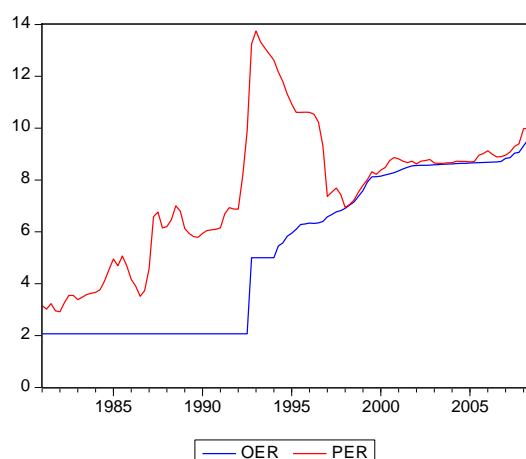

Real Effective Exchange Rate Index

In this paper, the real effective exchange rate is synonymous with the multilateral RER. In the traditional sense, however, an 'effective' exchange rate is one that accounts for the structure of protection. The drawback is that data requirements for its construction are 'usually prohibitive', while there is some evidence that it may not be significantly different from the usual measure (White and Wignaraja, 1992:1472). Therefore, this strategy is not pursued. A multilateral rate (basket of foreign currencies) is usually preferred to a bilateral rate since it tends to be a better representation of overall competitiveness.

There are several alternative methods to compute the real 'effective' exchange rate index (RER). Some important decisions need to be taken, which may or may not have an influence on the analysis. Therefore, we will justify each of these decisions in light of the purpose of this study.³⁰ The key choices include:

- (a) Nominal rate: Official or Parallel;
- (b) Averaging method: Geometric vs. Arithmetic;
- (c) Weights: Time-varying vs. Fixed, and Total trade vs. Export vs. Import;
- (d) Trading partners: Criteria to choose which ones and how many;
- (e) Price indices: CPI vs. PPI vs. WPI.

³⁰ Li and Rowe (2007:33-45) provide a detailed explanation of the concepts and issues involved in the construction a real exchange rate measure.

The first dilemma arises in countries with a dual exchange rate system (White and Wignaraja, 1992:1472). In the case of Ethiopia, the parallel premium is only significant until 1997, after which it tracks fairly closely the official rate. Hence, the use of the official exchange rate seems to be appropriate, although robustness tests will inform us if there is a significant departure from the long-run relationship for the period pre-1997.

The geometric average is often seen as a superior method over the arithmetic averaging procedure, mainly due to its desirable symmetry and consistency properties (Hinkle and Montiel, 1999:49-50). The arithmetic RER index is easier to compute, but it crucially depends on the choice of the base year. This is problematic to the extent that the base year is assumed to represent equilibrium in the assessment of exchange rate misalignment (Opoku-Afari, 2004). Moreover, the rate of change of the RER index (e.g. percent appreciation) will be sensitive to a shift of the reference period (re-basing). Finally, the arithmetic average gives larger weights to currencies that have significantly appreciated or depreciated in relation to the domestic currency.

The weighting scheme should reflect the relative importance of each country's foreign currency and prices in the context of Ethiopia's trade patterns (Hinkle and Montiel, 1999:97-8). Therefore, time-varying weights are often preferred to a fixed weighting scheme, since the former take into account changing trading patterns. For example, exchange rate fluctuations of the renminbi or the rupee (in relation to the birr) in the 1980s were not a significant determinant of Ethiopia's external competitiveness, given the little volume of trade with China and India during that period. Nonetheless, China and India are increasingly important trade partners and this should be reflected in the weighting scheme.³¹ Fixed weights may therefore misrepresent the structure of trade in some given period. The weights can be updated every period (e.g. moving average) or we could consider period averages. Various plots of the RER index suggest that there is very little variation with regard to alternative weighting schemes. Li and Rowe (2007:39-41) reach the same conclusion for Tanzania, which suggests that the changes in weights are dominated by changes in relative prices and/or nominal exchange rates. In terms of the determination of the weights, we could use total trade shares or export/import data alone. The choice should be guided by the objective of the study. Since we are interested in both export and import competitiveness, we use total trade shares to capture overall external competitiveness.

³¹ China and India currently account for about 25 percent of Ethiopia's trade (mostly imports).

We have tried to include a large number of trading partners in order to obtain a representative sample. Although we started with the major 26 trading partners, three countries had to be dropped due to poor quarterly price data (Djibouti, USSR/Russia, and Yemen). These 23 partners represented 73 percent of total trade flows during the period 1981-2008. However, the RER index does not seem to be sensitive to the number of trading partners selected, perhaps because most currencies co-move with hard currencies (e.g. USD, EUR, GBP, YEN, etc.). The RER index for the 6 major trading partners during the 1981-2008 period (Germany, Italy, Japan, Saudi Arabia, UK, and US – which still represent over 50 percent of trade flows) is not significantly different from the main index. The plot shows very little variation, which is corroborated by the very high correlation coefficient between the two indices.

With regard to the price indices, it is not possible to find a precise empirical equivalent to the price of tradables and non-tradables (Edwards, 1989:87). Hence, it is common to proxy (domestic) non-tradable prices by the country's consumer price index (CPI), while the producer price index (PPI) or wholesale price index (WPI) are usually used to proxy (foreign) tradable prices. The argument is that the PPI and WPI are a better representation of the price of intermediate goods, since they mainly contain tradable goods. Despite the fact that the CPI contains some tradable goods, it is greatly influenced by the non-tradable activities, thus it is a good proxy. Some authors suggest the use of GDP deflators and unit labour costs, but these were not available for most of the countries on a quarterly basis.

Edwards (1989:90&126) suggests that the weighting scheme, the choice of trading partners, and the choice of price indices does not seem to have a significant impact on the construction of the RER index. The crucial decision is between bilateral and multilateral rates, which show considerable differences in behaviour (sometimes moving in opposite directions). A multilateral real exchange rate index is preferred. Bearing in mind the discussion presented above, the RER index used in this study is computed as the geometric trade-weighted average of a basket of bilateral real exchange rates,

$$RER_t = \prod_{i=1}^n \left(NER_{i,t} \times \frac{P_t^d}{P_{i,t}^f} \right)^{w_{i,t}} \quad t = 1, \dots, T \quad i = 1, \dots, n$$

where NER is the bilateral nominal exchange rate index expressed in foreign currency per birr, while P^d and P^f are domestic and foreign price indices, respectively (proxied by the CPI and

PPI/WPI, as discussed above).³² Both exchange rate and price indices are period averages, with base 2000=100. The subscript i identifies the trading partner, and t the time period. A total of 23 trading partners (n) were included in the construction of the REER index. Finally, w_i corresponds to the weight of each trading partner, which is allowed to vary with time (8 quarter moving average) to capture changes in trade patterns (e.g. the rise of China and India in the later part of the sample). The weights are computed as the share of each partner's trade (exports plus imports) in the total volume of Ethiopia's trade with the group of 23,

$$w_{it} = \frac{X_{it} + Z_{it}}{\sum_{j=1}^n (X_{jt} + Z_{jt})} \quad \text{with} \quad \sum_{i=1}^n w_{it} = 1 \quad 0 < w_{it} < 1$$

Long-Run Determinants

Several studies use net capital inflows as a determinant of the RER. For example, Edwards (1989:136) uses the (lagged) ratio of net capital flows to GDP as a proxy for capital controls. However, there is a growing interest in the impact of specific capital inflows such as foreign aid, remittances and FDI. In fact, some level of disaggregation may be required, since it is unlikely that all inflows will induce the same impact, either in terms of magnitude or even sign. For example, remittances are likely to be biased towards the purchase of non-tradable (domestic) goods, while other flows may be predominantly used to purchase tradable goods.

The focus of this empirical exercise is on foreign aid inflows, both in the form of grants and concessional loans. For that purpose, most studies use net ODA flows (DAC) to proxy for foreign aid inflows. However, this paper argues that this is not a good measure for the reasons explained in previous chapters. Therefore we use data from the balance of payments. Foreign aid grants are listed as 'public transfers' in the current account, while foreign loans are a sub-item in the capital account. Due to data scarcity, remittances are proxied by 'private transfers' from the current account.³³ Data on foreign direct investment is very limited, and therefore it will not be used in this study. If the empirical results suggest that aid inflows lead to long-run RER appreciation, then concerns about Dutch disease might be justified. An insignificant coefficient would suggest that although aid flows may induce short-run adjustments, these are not permanent.

³² In this case, an increase [fall] in the REER represents an appreciation [depreciation].

³³ This item includes 'remittances' and 'other private transfers'.

The terms of trade describes the effects of external demand and supply in the tradable goods sector (Opoku-Afari et al, 2004). The variable is usually measured by the ratio of export to import price (unit value) indices. However, trade price indices for Ethiopia are extremely difficult to obtain, even for annual data. The National Bank of Ethiopia (NBE) used to publish these until the 1980s, but then the series were discontinued. Therefore, we decided to construct the terms of trade index from secondary data. As a proxy for export prices we use the international price of coffee. Alternatively, we combine coffee and agricultural raw materials with a change in the weight structure around 2001, as coffee averaged 60 percent of total exports during 1981-2000, but only 35 percent in 2001-2008. With regard to import prices, we use the unit value of exports for two groups of countries with equal weights: advanced and developing economies. We also use changing weights to account for the steady rise of developing countries' share in total trade, from about 30 percent in 1981 to 75 percent in 2008.³⁴ The expected impact of the terms of trade on the RER will depend on how income and substitution effects play out. A deterioration of the terms of trade where the income effect is predominant will tend to depreciate the RER.

The degree of openness is measured by the ratio of total trade (exports plus imports) to GDP, and is used to capture the impact of trade policy (e.g. liberalisation) on the RER.³⁵ Alternative measures in the literature include ratios of exports to GDP and imports to GDP. In the case of Ethiopia, the ratio of total trade to GDP is more appropriate since export restrictions (e.g. taxes) were significant for most of the sample. We could also use the black market premium (BMP), i.e. the spread between the official and parallel exchange rates. However, the BMP is also likely to capture factors other than trade, exchange and capital controls (Edwards, 1989:136).³⁶ In terms of its expected impact, openness is likely to contribute to a depreciation of the RER. The rationale is that trade liberalisation measures (e.g. reduction in import tariffs and abolition of non-tariff barriers) will stimulate the demand for imports, leading to the depreciation of the local currency.

Government consumption of non-tradable goods is proxied by government consumption³⁷ as a share of GDP, since it is not possible to distinguish between expenditures on tradable and non-tradable goods. The quality of this proxy will depend on the share of non-tradable goods in total government consumption, which we think is likely to be high in the case of Ethiopia. However, the inclusion of this variable in the econometric specification may cause double-counting, since

³⁴ The impact of changing the weights used in the construction of the variable is negligible.

³⁵ Average tariff rates would constitute a better proxy, but we were not able to obtain such data.

³⁶ Moreover, Edwards (1989:136) suggests that the RER and BMP are jointly determined.

³⁷ Constructed from fiscal data as current expenditure minus food aid and interest payments.

aid flows are likely to finance some government consumption, such as teachers' and nurses' wages.³⁸ This variable is expected to be positively correlated with the RER, especially if government consumption is biased toward non-tradable goods, therefore increasing its demand.

Gross Domestic Product (GDP) is a problematic variable since the government of Ethiopia does not compile National Accounts data on a quarterly basis. Since GDP is often an important variable in this literature, we decided to construct a quarterly GDP variable by interpolating annual observations. There are several ways to do this. One is to simply distribute the yearly values across each quarter. However, this method neglects seasonal patterns and may complicate the analysis since GDP changes are equal to zero for the last three quarters. A second approach relies on a local quadratic polynomial with matched sums, i.e. the sum of the quarters equals the respective observed annual observation (QMS, 2007:108). Finally, we can use the multivariate GLS regression method proposed by Chow and Lin (1971). This method allows us to use quarterly variables that are correlated with GDP to shape the intra-year behaviour of the constructed series. Potential explanatory variables include rainfall (measured in millimetres), domestic credit, and indirect taxes (e.g. VAT). Agriculture is responsible for a substantial share of Ethiopia's output and therefore quarterly rainfall can be used as a proxy (possibly with lags). The variable is constructed as an average of three meteorological stations (Addis Ababa, Jimma and Dire Dawa). Economic activity in the remainder of the economy can be proxied by domestic credit. Indirect taxes did not turn out to be a reliable proxy, mainly due to the impact of changes in the tax regime on overall collection. Since there is a real danger of introducing spurious intra-year dynamics in the GDP ratios described above (e.g. aid-to-GDP ratio), the preferred GDP variable is computed through the second approach, which produces a series that is less volatile (reduced denominator variance) and more appropriate for the purpose of this study.

Technological progress will be approximated by a deterministic time trend, as in Bourdet and Falck (2006) and Nyoni (1998), with the objective of capturing the Ricardo-Balassa (or Balassa-Samuelson) effect. Edwards (1989:136) and other authors have proxied technological progress by the growth rate of real GDP, but our quarterly GDP growth series would be very sensitive to the interpolation approach. We expect technological progress to appreciate the RER if productivity increases are stronger in the tradable sector.

Short-Run Determinants

³⁸ Some authors also use total investment as a share of GDP, which is also likely to suffer from this problem.

With regard to the short-run, expansionary macroeconomic policies may tend to appreciate the RER. A common proxy in the literature is excess money growth in the economy, measured by the growth of broad money (M2) minus real GDP growth. In our case, this variable (EXM2) is dominated by the behaviour of broad money. Moreover, nominal exchange rate devaluations will contribute to RER depreciation. Finally, international reserves (IRES) are likely to be negatively correlated with the RER. As opposed to the long-run determinants, these variables are assumed to only affect the RER in the short-run, and are often not included in the long-run specification.

5.2 Data Plots

This section provides an initial analysis of the dataset. Starting with the behaviour of the real exchange rate (LRER), the period from 1984Q2 to 1985Q4 represents the (temporary) overvaluation of the USD in relation to the other major currencies such as the German mark, British pound, and Japanese yen.³⁹ The quick appreciation of the LRER in early 1991 is mainly due to high inflation observed during the political transition from the Derg regime. The sharp drop in 1992Q4 is caused by the nominal devaluation of the birr in relation to the USD. The exchange rate regime was then changed from a ‘hard peg’ to a ‘crawling peg’ to the USD, and from 1993 to 2004 the LRER showed a clear depreciating trend. However, since 2005 the LRER has been appreciating, which is partly explained by the global increase in food prices, which strongly affected Ethiopia’s CPI (due to the large weight in the domestic basket) but not its trading partners’ WPI or PPI.⁴⁰

Figure 3: Real Exchange Rate Index and Black Market Premium

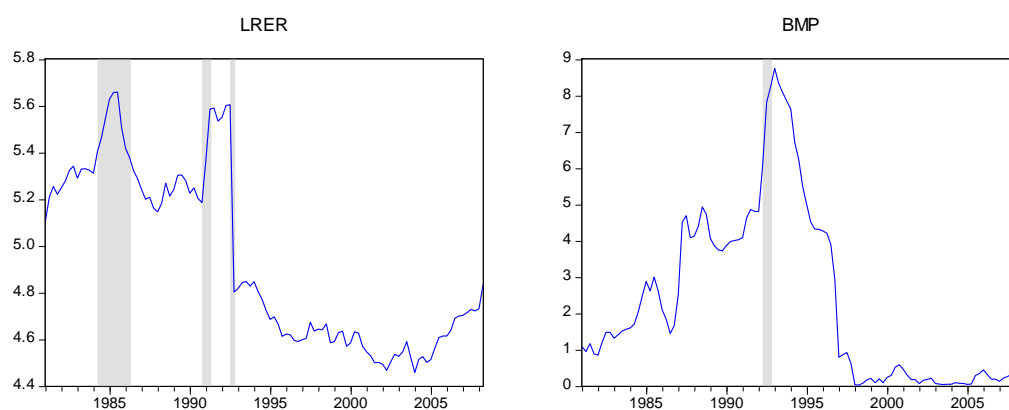

³⁹ An increase of the RER means appreciation.

⁴⁰ This effect would only be captured by the terms of trade if the share of food imports in total imports was large.

The black market premium (BMP) is the difference between the official exchange rate and the parallel market rate. The spike in the mid 1980s is mainly due to the overvaluation of the USD, the currency to which the birr was pegged. The increase in 1987 (to 1989) is likely to be associated with the macroeconomic policies of the Derg regime. The sharp increase of the premium in early 1992 is probably due to the anticipation of the devaluation of the birr. This is a usual feature of devaluations, as suggested in Edwards (1989:108). Since then, however, the premium has dropped considerably and from 1997 it is almost negligible.

The terms of trade (LTOT2) are significantly affected by the international price of coffee, which historically has revealed strong volatility.⁴¹ Thus, the steady deterioration from 1986 to 1992 is mainly explained by the fall in coffee prices. The terms of trade observed a substantial improvement in 1993-94, before a temporary deterioration and then picking up around 1997. During the period 1998-01 there was another steady fall, followed by a strong improvement until 2005. Since then the index has been relatively steady. With regard to trade openness (LOPEN), we observe a mildly declining trend in the trade-GDP ratio up to 1990. In 1991, we observe a sharp drop that can be explained by the fall in trade volumes.⁴² Since then, a steady increase ensued, as a natural consequence of the liberalisation of trade flows.

Figure 4: Terms of Trade and Openness

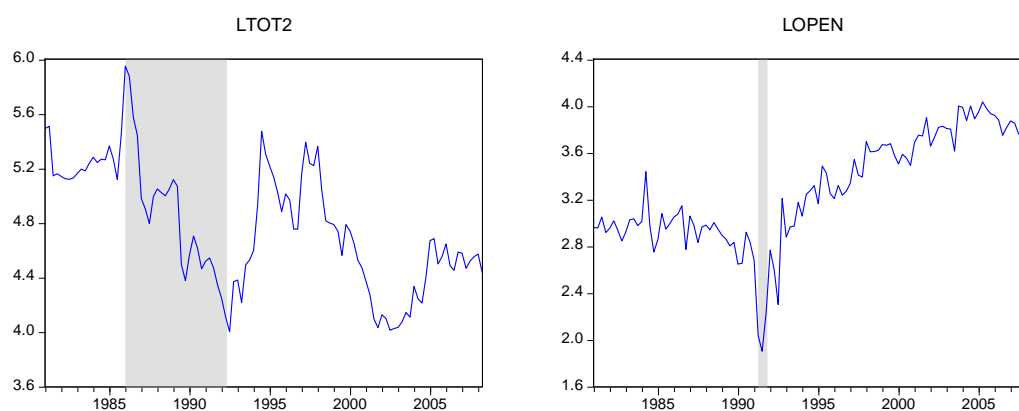

Foreign aid (as a share of GDP), which includes grants and concessional loans, shows considerable volatility. These have increased considerably in 2001, just after the end of the war with Eritrea, despite a drop during 2005 (election). With regard to remittances (as a share of GDP), these have been steadily increasing over the years, as a consequence of the growing Diaspora.

⁴¹ The preferred specification (LTOT2) uses the international price of coffee as a proxy for export prices and export unit values from both advanced and developing economies (equal weights) as a proxy for import prices.

⁴² This effect could have been compensated by a proportional fall in GDP, but in the absence of precise information the interpolation technique used does not capture it.

Figure 5: Foreign Aid Inflows (% GDP) and Remittances (% GDP)

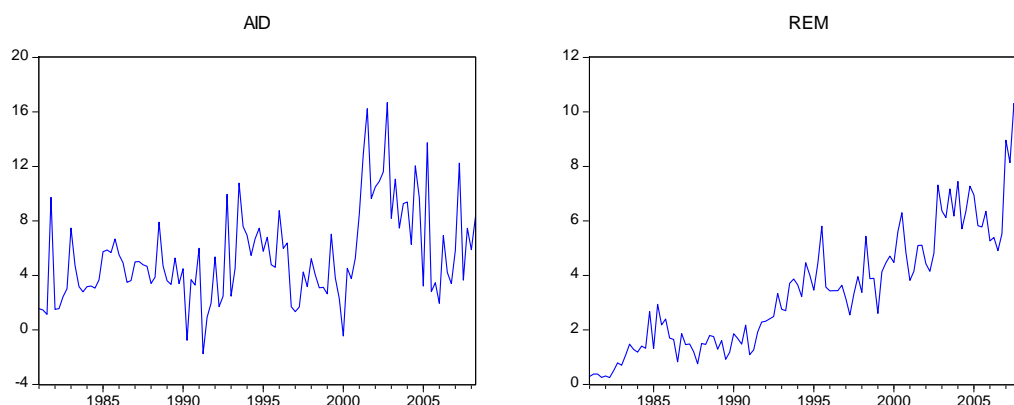

Changes in international reserves (as a share of GDP) looked fairly stable until 1993, after which they became significantly more volatile. However, we can observe that the 1981-1993 average is negative, whilst the 1994-2008 average is positive. Excess money growth shows high volatility (mainly due to M2) and appears to be stationary.⁴³

Figure 6: Change in International Reserves (% GDP) and Excess Credit Growth

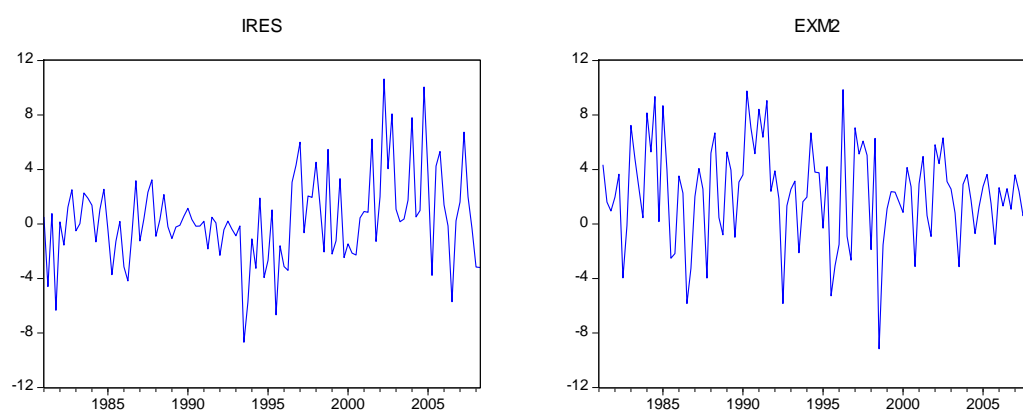

5.3 Unit Root Tests and Seasonality

This section applies seasonal unit root tests to determine the order of integration of the variables and to assess whether there is evidence of stochastic seasonality. For that purpose we use the test proposed by Hylleberg et al (1990:216) for quarterly data. The test is based on the model:

⁴³ It should be noted that the volatility in these two variables (IRES and EXM2) does not come from the denominator (i.e. GDP). The interpolation technique provided a smooth estimate of quarterly GDP precisely to minimise spurious quarterly behaviour.

$$\Delta_4 y_t = \pi_1 z_{1,t-1} + \pi_2 z_{2,t-1} + \pi_3 z_{3,t-1} + \pi_4 z_{3,t-2} + \sum_{j=1}^p \alpha_j^* \Delta_4 y_{t-j} + u_t$$

where $z_{1t} = (1 + L + L^2 + L^3)y_t$, $z_{2t} = -(1 - L + L^2 - L^3)y_t$, $z_{3t} = -(1 - L^2)y_t$ and L is the lag operator. The null hypotheses $H_0: \pi_1=0$, $H_0: \pi_2=0$ and $H_0: \pi_3=\pi_4=0$ correspond to tests for regular, semi-annual and annual unit roots, respectively. These hypotheses are tested by estimating the model above by OLS and using the relevant t -tests and F -tests. The critical values reported are from Franses and Hobijn (1997). It should be noted, however, that the asymptotic distributions of the test statistics under the respective null hypotheses depend on the deterministic terms in the model. This fact is taken into consideration since there is evidence that at least some of the series seem to be trended. The results of the unit root tests are reported below.

Table 6: Seasonal Unit Root Tests (Levels and First Differences)

Var.	Lag	H ₀	Test	Stat	Var.	Lag	H ₀	Test	Stat
LRER	0	$\pi_1=0$	t_{π_1}	-2.19	DLRER	0	$\pi_1=0$	t_{π_1}	-4.84***
		$\pi_2=0$	t_{π_2}	-6.09***			$\pi_2=0$	t_{π_2}	-5.15***
		$\pi_3=\pi_4=0$	F_{34}	49.61***			$\pi_3=\pi_4=0$	F_{34}	25.11***
LOPEN	0	$\pi_1=0$	t_{π_1}	-2.06	DLOPEN	0	$\pi_1=0$	t_{π_1}	-6.21***
		$\pi_2=0$	t_{π_2}	-5.80***			$\pi_2=0$	t_{π_2}	-4.87***
		$\pi_3=\pi_4=0$	F_{34}	23.44***			$\pi_3=\pi_4=0$	F_{34}	17.06***
LTOT2	0	$\pi_1=0$	t_{π_1}	-2.76	DLTOT2	0	$\pi_1=0$	t_{π_1}	-5.38***
		$\pi_2=0$	t_{π_2}	-7.61***			$\pi_2=0$	t_{π_2}	-6.44***
		$\pi_3=\pi_4=0$	F_{34}	32.83***			$\pi_3=\pi_4=0$	F_{34}	22.71***
AID	0	$\pi_1=0$	t_{π_1}	-2.93	DAID	0	$\pi_1=0$	t_{π_1}	-7.54***
		$\pi_2=0$	t_{π_2}	-4.76***			$\pi_2=0$	t_{π_2}	-4.72***
		$\pi_3=\pi_4=0$	F_{34}	25.73***			$\pi_3=\pi_4=0$	F_{34}	24.35***
REM	0	$\pi_1=0$	t_{π_1}	-2.77	DREM	0	$\pi_1=0$	t_{π_1}	-6.81***
		$\pi_2=0$	t_{π_2}	-4.89***			$\pi_2=0$	t_{π_2}	-4.74***
		$\pi_3=\pi_4=0$	F_{34}	36.37***			$\pi_3=\pi_4=0$	F_{34}	26.35***
EXM2	0	$\pi_1=0$	t_{π_1}	-4.58***	DEXM2	0	$\pi_1=0$	t_{π_1}	-7.25***
		$\pi_2=0$	t_{π_2}	-4.74***			$\pi_2=0$	t_{π_2}	-4.59***
		$\pi_3=\pi_4=0$	F_{34}	35.20***			$\pi_3=\pi_4=0$	F_{34}	29.13***
BMP	0	$\pi_1=0$	t_{π_1}	-1.95	DBMP	0	$\pi_1=0$	t_{π_1}	-4.04***
		$\pi_2=0$	t_{π_2}	-6.64***			$\pi_2=0$	t_{π_2}	-4.93***
		$\pi_3=\pi_4=0$	F_{34}	38.70***			$\pi_3=\pi_4=0$	F_{34}	31.68***
GEX	0	$\pi_1=0$	t_{π_1}	-1.56	DGEX	0	$\pi_1=0$	t_{π_1}	-5.60***
		$\pi_2=0$	t_{π_2}	-3.98***			$\pi_2=0$	t_{π_2}	-3.12**
		$\pi_3=\pi_4=0$	F_{34}	24.45***			$\pi_3=\pi_4=0$	F_{34}	17.48***
IRES	0	$\pi_1=0$	t_{π_1}	-4.17***	DIRES	0	$\pi_1=0$	t_{π_1}	8.58***
		$\pi_2=0$	t_{π_2}	6.52***			$\pi_2=0$	t_{π_2}	7.25***
		$\pi_3=\pi_4=0$	F_{34}	29.16***			$\pi_3=\pi_4=0$	F_{34}	30.12***

Obs.: The Schwarz Criterion was used (maximum set at 10 lags). The deterministic components included were: constant, trend, and seasonal dummies. For the differences, the trend was dropped. The results for the sub-sample 1995-2008 lead to similar conclusions, i.e. EXM2 and IRES potentially stationary. The asterisks represent significance at the 10 percent (*), 5 percent (**), and 1 percent (***) confidence levels.

The null hypothesis of the HEGY test is that there is a unit root. We include a constant, a deterministic trend, and seasonal dummies in the test regression. The number of lagged seasonal differences (i.e. lag length) was selected according to the Schwarz Criterion. As expected, the results show that most variables have regular (zero frequency) unit roots (i.e. cannot reject $\pi_1=0$). The only exception is excess money growth (EXM2) and change in international reserves (IRES), which reject the unit root hypothesis. However, and perhaps more importantly, the presence of a semi-annual unit root ($\pi_2=0$) or annual unit root ($\pi_3=\pi_4=0$) is rejected for all variables. Finally, the HEGY test on the (first) differenced variables seems to reject the null hypotheses of unit roots.

Hence, the HEGY tests do not provide evidence of seasonal unit roots. The seasonal components do not seem to be time-dependent, suggesting that the patterns of the selected variables within the year remained relatively stable throughout the sample. The tests also suggest that most variables are integrated of order one, whilst two variables (EXM2 and IRES) appear to be stationary.

6. Empirical Results

6.1 Econometric Models

This section deals with the specification and estimation of our regression models. Taking into consideration previous theoretical and empirical studies, the initial long-run relation to be explored is:

$$LRER = \alpha_0 + \alpha_1 LOPEN + \alpha_2 LTOT2 + \alpha_3 AID + \alpha_4 REM + \alpha_5 t + \varepsilon_t$$

Where LRER is the log of the real effective exchange rate index, LOPEN the log of the ratio of total trade flows to GDP, LTOT2 is a proxy for the terms of trade, AID is the ratio of foreign aid flows to GDP, and REM the ratio of private transfers to GDP.⁴⁴ The deterministic time trend is aimed at capturing the Balassa-Samuelson effect. Moreover, seasonal dummy variables are also included in the specification to account for deterministic seasonal patterns. A number of other variables were also used: the black market premium (difference between the parallel exchange rate to the USD and the official exchange rate), the change in international reserves as

⁴⁴ A similar approach is followed by Bourdet and Falck (2006).

percentage of GDP, the ratio of government consumption spending to GDP, and excess money growth. However, these variables are not found to be statistically significant.

The first set of results are computed for the unrestricted ECM specification – an ARDL(1,1,1,1,1). In terms of cointegration testing, the ECM-test proposed by Banerjee et al (1998) is a *t*-test on the lagged dependent variable, which in practice assesses the statistical significance of the adjustment coefficient of the error-correction term. The bounds test approach proposed by Pesaran et al (2001:307) also uses the conditional unrestricted ECM and performs an *F*-test (or Wald-test) on the long-run coefficients. The distribution of both tests is non-standard, and therefore we use the tabulated values from Pesaran et al (2001). We report results for the full sample (1981Q1-2008Q1) and for the later half (1995Q1-2008Q1). The advantage of the subsample is that it avoids the problematic period of the fall of the Derg regime (1991) as well as the devaluation in late 1992. It is also likely to provide better estimates of the determinants of the RER, since market forces are expected to exert stronger influence on the RER in the latter part of the sample. Moreover, an alternative measure of the RER was also used as a robustness check. RERnf refers to the construction of the RER that uses the Ethiopian CPI for non-food items rather than the overall index. The difference between these indices is particularly significant in the last three years of the sample, when food prices rose sharply since 2005 as a consequence of the world food production shortfalls. Misspecification and cointegration tests are also reported.

Table 7: Unrestricted ECM Results

	Full Sample		Sub-Sample (1995-2008)			
	DLRER	DLRER _{nf}	DLRER	DLRER	DLRER _{nf}	DLRER _{nf}
C	0.010	0.244	1.640***	1.608***	1.117*	0.990*
DLOPEN	0.004	-0.027	-0.062*	-0.064*	-0.068*	-0.055
DLTOT2	-0.026	-0.030	-0.001	0.004	0.012	0.017
DAID	-0.002*	-0.002*	-0.001	0.000	0.001	0.001
DREM	0.006	0.002	0.004	0.003	-0.004	-0.001
LOPEN(-1)	<i>0.043</i>	<i>0.030</i>	<i>-0.111</i>	<i>-0.113</i>	<i>-0.061</i>	<i>-0.041</i>
LTOT2(-1)	<i>-0.029</i>	<i>-0.034</i>	<i>0.069</i>	<i>0.075</i>	<i>0.026</i>	<i>0.023</i>
AID(-1)	<i>-0.004</i>	<i>-0.005</i>	<i>-0.001</i>		<i>0.000</i>	
REM(-1)	<i>0.004</i>	<i>0.002</i>	<i>0.000</i>		<i>-0.007</i>	
LRER _{inf} (-1)	<i>0.004</i>	<i>-0.024</i>	<i>-0.393</i>	<i>-0.393</i>	<i>-0.225</i>	<i>-0.205</i>
S1	0.021**	0.022**	0.012	0.011	0.011	0.012
S2	0.047***	0.021**	0.026**	0.025**	-0.001	0.002
S3	0.034***	0.024**	0.032**	0.031***	0.013	0.016
T	-0.001*	-0.001**	0.003***	0.003***	0.001	0.000
D924p	-0.758***	-0.723***				
D912p	0.191***	0.138***				
D911p	0.199***	0.163***				
D854p	-0.120***					
Obs	108	108	53	53	53	53
R-Squared	0.871	0.876	0.573	0.570	0.340	0.283
Serial Correlation	[0.112]	[0.102]	[0.621]	[0.622]	[0.838]	[0.363]
Functional Form	[0.416]	[0.233]	[0.468]	[0.347]	[0.001]	[0.015]
Normality	[0.201]	[0.789]	[0.778]	[0.704]	[0.974]	[0.951]
Heteroscedasticity	[0.465]	[0.458]	[0.383]	[0.273]	[0.003]	[0.003]
ECM test	0.165	-0.961	-3.771	-4.236**	-2.233	-2.276
F-test (deletion)	1.663	3.010	3.920*	6.759***	2.118	2.319

Obs.: Computed with MicroFit 4 (p-values in square brackets). The critical values for the cointegration tests are taken from Pesaran et al (2001). The significance of the long-run coefficients (*italic*) will be assessed at a later stage. The asterisks represent significance at the 10 percent (*), 5 percent (**), and 1 percent (***) confidence levels.

Perhaps not surprisingly, cointegration is only found for the sub-sample (1995Q1-2008Q1). The results suggest that trade openness has a negative impact on the RER, therefore contributing to a depreciation. A positive shock to the terms of trade has a positive impact on the RER, suggesting that the income effect dominates the substitution effect. Moreover, neither foreign aid nor remittance flows seem to have a significant impact on the long-run path of the RER.

With regard to the full sample, higher values for serial correlation seem to arise from the unexplained appreciation (and then depreciation) of the birr in the mid-1980s. Since this particular behaviour of the RER was mainly a consequence of the USD movements against other hard currencies, there is little scope to explain these movements within Ethiopia. Hence, a model was also estimated for the period after 1986Q1, and although it passes all misspecification tests, there is still no cointegration amongst the variables. A number of other variables were also included in the main specification, but did not improve the results: black market premium (BMP), change in international reserves (IRES), government consumption spending (GEX), excess money growth (EXM2).

The table below presents the results from the dynamic OLS (DOLS) approach. Only the long-run coefficients are reported, since the number of first-differenced regressors in this specification is rather large and they do not have a direct economic interpretation. The leads and lags were chosen to take into consideration the frequency of the data ($k_1=4$ and $k_2=2$). Moreover, we use adjusted variance matrices to correct for potential heteroscedasticity and serial correlation. Cointegration is evaluated through an ADF test on the residuals of each regression (without seasonal dummies, trend or constant). The lag length of the ADF regression is selected by the Schwarz Information Criterion.

Table 8: DOLS Long-Run Estimates

	Full Sample		Sub-Sample (1995-2008)		
	LRER	LRER _{nf}	LRER	LRER	LRER _{nf}
C	6.103***	6.615***	4.398***	4.340***	5.724***
LOPEN	-0.295***	-0.478***	-0.296*	-0.289**	-0.635***
LTOT2	0.023	0.064	0.163**	0.169***	0.152***
AID	-0.021*	0.002	-0.001		0.016***
REM	0.101**	0.026	-0.003		-0.043***
DEVAL	-0.642***	-0.556***			
S1	0.016	0.022	0.002	0.002	0.009
S2	0.035	0.023	0.005	0.025	-0.012
S3	0.042**	0.030*	0.007	0.006	0.005
T	-0.003	-0.002	0.007**	0.008***	0.007***
Obs	102	102	51	51	51
R-Squared	0.969	0.988	0.923	0.923	0.988
Serial Correlation	[0.000]	[0.000]	[0.000]†	[0.001]†	[0.003]†
Functional Form	[0.000]	[0.000]	[0.217]	[0.290]	[0.107]
Normality	[0.323]	[0.507]	[0.646]	[0.666]	[0.933]
Heteroscedasticity	[0.078]	[0.119]	[0.403]	[0.278]	[0.564]
ADF test	-3.88***	-4.41***	-5.36***	-5.45***	-6.40***

Obs.: Computed with Microfit 4 (p-values in square brackets). The t -statistics use the adjusted covariance matrix. † F -version does not reject the null hypothesis of serially uncorrelated errors. ADF tests are carried out in EViews 6 and use MacKinnon (1996) one-sided p-values. The asterisks represent significance at the 10 percent (*), 5 percent (**), and 1 percent (***) confidence levels.

The ADF test results suggest that these are meaningful economic (cointegrating) relations.⁴⁵ In terms of the estimated coefficients, the results suggest that increased trade openness contributes to the depreciation of the RER, while positive terms of trade shocks tend to appreciate the RER. These results are robust to both RER measures, although LTOT2 is not statistically significant in the full sample. These findings corroborate the results obtained from the unrestricted ECM specification. With regard to the other variables, foreign aid and remittance flows do not appear to be significant long-run determinants of the RER, except for the alternative RER measure in the post-1995. However, the estimated coefficients are rather

⁴⁵ It should be noted that residual-based cointegration tests are known to have low power (Type II error), especially in relatively small samples. This means that they may fail to reject the null hypothesis in the presence of cointegration.

small and not robust to the RER definition. All regressions pass the normality residual test, but do not reject other misspecification problems. Nevertheless, the standard errors used provide a correction for heteroscedastic residual and serial correlation. The CUSUM tests do not suggest any structural breaks in the sub-sample.

The table below reports results from the Phillips-Hansen approach to cointegration. The Fully-Modified OLS (FMOLS) methodology uses a semi-parametric correction to solve potential endogeneity and serial correlation, therefore providing standard errors that are more reliable than standard OLS. This procedure requires all regressors to be $I(1)$ and not cointegrated amongst themselves. Robustness checks included different weighting schemes, truncation and variables.

Table 9: FMOLS Long-Run Estimates

	Full Sample		Sub-Sample (1995-2008)	
	LRER	LRER _{nf}	LRER	LRER _{nf}
C	5.719***	6.576***	4.693***	5.821***
LOPEN	-0.291***	-0.443***	-0.305***	-0.379***
LTOT2	0.080	0.049	0.117***	0.045
AID	0.005	0.005	-0.006***	0.002
REM	0.068***	0.023*	0.008*	-0.008
DEVAL	-0.597***	-0.480***		
S1	0.031	0.032	0.000	0.021
S2	0.084**	0.071**	0.058***	0.025
S3	0.055	0.043	0.042***	0.006
T	-0.002	-0.004**	0.006***	0.000
Obs	108	108	53	53
ADF test	-3.49**	-5.23***	-5.22***	-3.94**

Obs.: Computed with MicroFit 4 (Bartlett weights with truncation lag 4). The asterisks represent significance at the 10 percent (*), 5 percent (**), and 1 percent (***) confidence levels.

The results reported above provide further evidence that trade openness depresses the RER, while the terms of trade are associated with a RER appreciation. The impact of the remaining variables is rather small or even statistically insignificant. Foreign aid is significant in the sub-sample, but not with the expected theoretical sign. Moreover, remittances appear to appreciate the RER, but the impact is not robust to the choice of the RER measure. The plot of the residuals does not suggest misspecification problems.

We now summarise the results obtained so far by focusing on the sub-sample, since these do not raise misspecification concerns and seem more reliable. The table below shows the long-run coefficient from the three cointegration approaches. It also reports their statistical significance through Wald tests, as proposed by Stock and Watson (1993) for the DOLS approach and Phillips and Hansen (1990) for the FMOLS method. The results corroborate the conclusions from the t -stats.

Table 10: Summary of RER Long-Run Determinants (1995-2008)

	ECM	DOLS	FMOLS
LOPEN	-0.29***	-0.29***	-0.30***
LTOT2	0.19***	0.17***	0.12***
AID	0.00	0.00	-0.01***
REM	0.00	0.00	0.01*

Obs.: Computed with MicroFit 4. The results for DOLS are based on adjusted covariance matrix. Wald-test statistic is distributed as a Chi-Square(1). Disaggregating aid inflows into grants and loans does not change the conclusions. The asterisks represent significance at the 10 percent (*), 5 percent (**), and 1 percent (***) confidence levels.

Overall, the three approaches to cointegration used in this paper provide strong evidence that trade openness and the external terms of trade have a significant impact on the long-run path of the RER. The former always entails a depreciation of the RER, as predicted by economic theory, whilst the latter tends to appreciate the RER, suggesting that the income effect is stronger than the substitution effect. With regard to capital inflows, there is little evidence of a significant impact of foreign aid or remittance inflows on the RER. Hence, the Dutch disease hypothesis does not seem to hold for Ethiopia. Other variables were also included in the specification, but little was gained in terms of explanatory power (i.e. relevance to either long-run or short-run) or improvement of misspecification tests. These included excess money growth (EXM2), black market premium (BMP), change in international reserves (IRES), government consumption expenditure (GEX), capital account balance (KA), and net errors and omissions from the BoP (NEO). The time trend was statistically significant in some specifications, possibly capturing the Balassa-Samuelson effect.

6.2 Unobserved Components

We now turn to a structural time series model to complement the empirical exercise undertaken above. The starting point is Harvey's basic structural model (BSM):

$$y_t = \mu_t + \gamma_t + \varepsilon_t$$

$$\mu_t = \mu_{t-1} + \beta_{t-1} + \eta_t$$

$$\beta_t = \beta_{t-1} + \zeta_t$$

where y_t is the observed variable (LRER), μ_t is the trend, γ_t the seasonal, and ε_t the irregular component. Note that the components are initially assumed to be stochastic, whilst the cycle is excluded from the specification. The BSM seems to be a good starting point for the empirical analysis since the economic theory on RER determination does not provide a strong argument for the presence of cycles. Moreover, the validity of this assumption can be analysed through

spectral analysis. The initial estimation results suggest that the seasonal component is deterministic for both sample sizes, since the estimated variance of the component is not statistically significant. This corroborates the results from the HEGY test, and further validates the use of dummy variables to account for seasonality in the econometric (cointegration) models. Moreover, the variance of the irregular component is not statistically significant, indicating that the movements of the RER are totally explained by a stochastic trend and a deterministic seasonal component. The stochastic trend is then re-specified as a 'smooth trend' by setting the level variance to zero ($\sigma_\eta = 0$) whilst letting the slope variance unrestricted. Given the insights of the initial univariate model, we will now estimate and present the results of a mixed model, where we add potential explanatory variables to the structural model. The final specification is:

$$y_t = \mu_t + \gamma_t + \varepsilon_t + \sum_{i=1}^4 \sum_{\tau=0}^1 \alpha_{i\tau} x_{i,t-\tau} + \lambda DUM924s$$

$$\mu_t = \mu_{t-1} + \beta_{t-1} + \eta_t$$

$$\beta_t = \beta_{t-1} + \zeta_t$$

where x_i includes openness (LOPEN), terms of trade (LTOT2), foreign aid (AID) and remittances (REM). Both contemporaneous and one period lags are included for all explanatory variables. A level shift is also included to account for the devaluation in the last quarter of 1992. Since the results for the full sample do not suggest that any of the variables is statistically significant, we focus on the sub-sample. The sub-sample includes 53 observations and the order of trend smoothness value (p) is 3. The summary statistics suggest that the model passes the normality test, which is the Bowman-Shenton statistic based on the third and fourth moments of the residuals. The heteroscedasticity test (H) is the ratio of the squares of the last h residuals to the squares of the first h residuals (h is set at the closet integer of $T/3$) and it is centred around unity. Serial correlation is assessed through the Durbin-Watson test, serial correlation coefficients (r) at the first and last lags, and the (portmanteau) Box-Ljung statistic (Q) based on the first p autocorrelations. The results suggest only mild autocorrelation. Finally, the coefficient of determination based on the differences around seasonal means is 0.28, whilst the more common measure (R^2) is 0.89. In terms of the component's variances, we confirm that the level variance is set to zero (smooth trend), while the seasonal variance is estimated to be zero.

Table 11: Summary Statistics and Disturbances (1995-2008)

Summary Statistics		5% critical value [p-value]	Disturbances	Variance	q-ratio
T	53		Level	0	0.000
p	3		Slope	4.87E-05	0.113
std. error	0.027		Seasonal	0	0.000
Normality	0.529	$\chi^2(2)=5.99$ [0.768]	Irregular	0.000431	1.000
H(13)	1.374	F(h,h)=2.48 [0.288]			
DW	1.681	N(2,4/T)=1.548 [0.123]			
r(1)	0.150	N(0,1/T)=-0.226 [0.863]			
q	8				
r(q)	-0.305	N(0,1/T)=-0.226 [0.013]			
Q(q,q-p)	11.578	$\chi^2(5)=11.07$ [0.041]			
Rs^2	0.280				

Obs.: Allowing a stochastic level does not change results.

The next table shows the values of the state vector and regression effects. The coefficients of the explanatory values are interpreted as in classic econometric models, and support the conclusions from the cointegration analysis. The lag of trade openness is negatively correlated with the RER, while lagged terms of trade induce a RER appreciation. The fact that the one-period lags are statistically significant and not the contemporaneous values may suggest that the transmission mechanisms take a certain time to affect the RER. Neither foreign aid nor remittance flows are statistically significant, although the coefficient for workers' remittances is not far from significance. In fact, the suggestion that remittances may appreciate the RER supports the weak evidence from the FMOLS.

Table 12: State Vector Analysis and Regression Effects at period 2008(1)

State Vector	Value	Prob.	Regressors	Coefficient	RMSE	t-value	Prob.
Level	4.846	0.000	LOPEN	-0.048	0.038	-1.255	0.217
Slope	0.006	0.587	LOPEN(-1)	-0.078*	0.040	-1.973	0.055
Seasonal (χ^2 test)	8.930	0.030	LTOT2	-0.002	0.037	-0.061	0.952
S1	-0.011	0.073	LTOT2(-1)	0.074**	0.036	2.084	0.044
S2	0.000	0.995	AID	-0.001	0.001	-0.413	0.682
S3	0.018	0.006	AID(-1)	-0.001	0.001	-0.655	0.516
S4	-0.007	0.233	REM	0.007	0.004	1.682	0.100
			REM(-1)	0.000	0.004	-0.108	0.914

Obs.: Disaggregating aid inflows into grants and loans does not change the conclusions. The asterisks represent significance at the 10 percent (*), 5 percent (**), and 1 percent (***) confidence levels.

We now undertake a graphical analysis of the residuals, in order to assess the robustness and reliability of the results. The first graph presents the standardised residuals, which do not suggest the presence of a significant outlier. Moreover, the histogram supports the normal distribution, while the CUSUM t -test confirms the stability of the model. The correlogram does not show significant autocorrelations, except perhaps for lag 8.

Figure 7: Standardised Residuals and Histogram

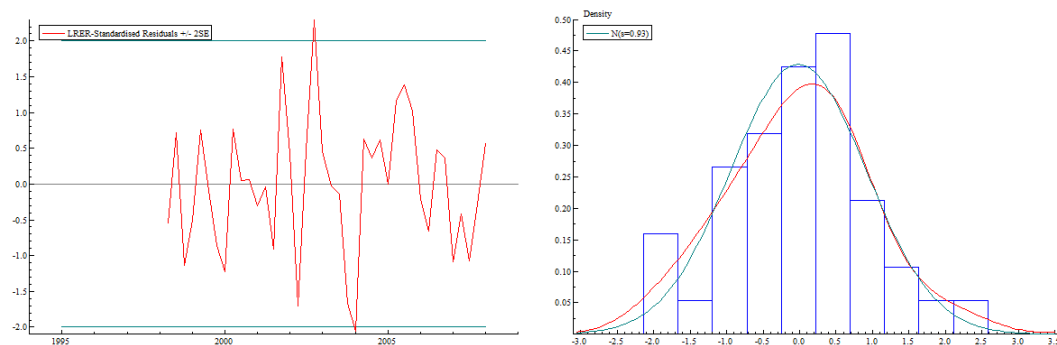
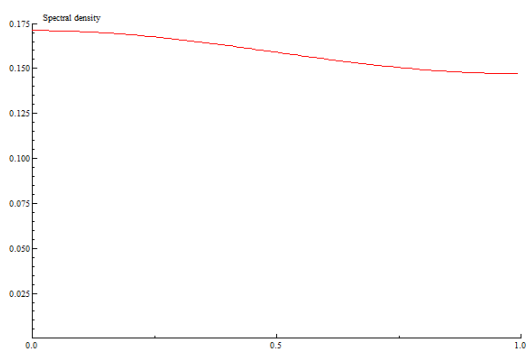

Figure 8: CUSUM t-Test and Correlogram



Finally, the spectral density is clearly flat, therefore corroborating the decision to exclude of the cycle component from the model. A marked peak in the graph would have suggested the presence of a cycle.

Figure 9: Spectral Density



In summary, the results from the unobserved components model suggest that the liberalisation of trade flows in Ethiopia (openness) have contributed to the depreciation of the RER, while positive terms of trade shocks contribute to appreciation pressures. Foreign aid inflows are not found to have a significant impact on the RER, while remittances may induce small appreciations.

7. Conclusions

This paper aimed to uncover the main determinants of RER fluctuations in Ethiopia. In particular, it tried to assess whether large capital inflows – mainly foreign aid and remittances – tend to cause the RER to appreciate as suggested by the theoretical literature. The classic Dutch disease model (Corden and Neary, 1982) was briefly reviewed, while the equilibrium RER approach (Edwards, 1989) underpinned the empirical exercise. The importance of real determinants ('fundamentals') as well as nominal (short-run) determinants was scrutinised. Despite the unequivocal theoretical prediction that large capital inflows will force the RER to appreciate, empirical studies have seldom found robust evidence of Dutch disease effects, especially with regard to foreign aid inflows. Hence, this paper reviewed some alternative arguments and proceeded to conduct a thorough empirical investigation of the RER dynamics in Ethiopia for the period 1995-2008.

Three cointegration frameworks were used: (i) the unrestricted error correction model proposed by Banerjee et al (1998); (ii) the dynamic OLS approach suggested by Saikkonen (1991) and Stock and Watson (1993); and (iii) the fully-modified OLS estimator of Phillips and Hansen (1990). Moreover, the unobserved components (UC) model (Harvey, 1992) provided an alternative empirical framework. Its main strength lies in its explicit modelling of the stochastic trend, and by extending the UC model to include explanatory variables we are able to evaluate whether capital inflows (as well as other 'fundamentals') have had a significant impact on RER determination.

The results emerging from both the econometric and time series models suggest the following conclusions. The openness measure has a negative impact on the long-run value of the RER, which means that reforms undertaken in the 1990s to liberalise trade flows and exchange markets have contributed to downward pressures on the RER (depreciation). Moreover, external terms of trade shocks have a positive impact on the RER (appreciation). The implication of this finding is that the income effect outweighs any potential substitution effects. With regard to capital inflows, neither foreign aid nor workers' remittances were found to be statistically significant, although the latter might be weakly associated with appreciation pressures. This may be due to the fact that a large share of private transfers is spent on domestic products. The lack of robust evidence that capital inflows appreciate the RER questions the Dutch disease thesis, but is not totally surprising.

“Time-series models [...] tend to find that it [RER] responds much less to variations in aid flows than it does to other exogenous foreign exchange flows, most notably commodity price or terms of trade variations.” (Adam 2006:178)

Hence, this paper argues that the main fluctuations of the Ethiopian RER can be accounted by three main factors: (i) external commodity price shocks (measured by the terms of trade), mainly affecting coffee exports and oil imports; (ii) political events, such as the instability towards the end of the Derg regime that caused unusually high inflation; and (iii) economic policy, especially the liberalisation of trade flows and the exchange rate market. These effects are not likely to act through the capital account, since there are still several restrictions in Ethiopia. Moreover, the lack of significance of variables such as excess money supply and government consumption may suggest that Ethiopia has pursued sound macroeconomic policies since the fall of the Derg regime. To conclude, the results suggest that Ethiopia has been able to effectively manage large capital inflows, thus avoiding major episodes of macroeconomic instability. A prudent approach from the central bank and aid flows targeted at alleviating supply-side constraints (mostly through public investment) may have played an important role.

References

- Adam, C. (2006), "Exogenous Inflows and Real Exchange Rates: Theoretical Quirk or Empirical Reality?" in P. Isard, L. Lipschitz, A. Mourmouras, and B. Yontcheva (eds) The Macroeconomic Management of Foreign Aid: Opportunities and Pitfalls (Washington: International Monetary Fund, 2006).
- Adam C. and D. Bevan (2006), "Aid and the Supply Side: Public Investment, Export Performance, and Dutch Disease in Low-Income Countries." *The World Bank Economic Review*, 20(2), 261-290.
- Adenauer I. and L. Vagassky (1998), "Aid and the Real Exchange Rate: Dutch Disease Effects in African Countries." *Intereconomics: Review of International Trade and Development*, 33(4), 177-185.
- Asteriou, D. and S. Hall (2007), Applied Econometrics: A Modern Approach Using EViews and Microfit (Revised Edition), Palgrave MacMillan.
- Bandara, J. (1991), "An Investigation of 'Dutch disease' Economics with a Miniature CGE Model." *Journal of Policy Modeling*, 13(1), 67-92.
- Banerjee, A., J. Dolado and R. Mestre (1998), "Error-Correction Mechanism Tests for Cointegration in a Single-Equation Framework." *Journal of Time Series Analysis*, 19(3), 267-283.
- Banerjee, A., J Dolado, D. Hendry and G. Smith (1986), "Exploring Equilibrium Relationships in Econometrics through Static Models: Some Monte Carlo Evidence." *Oxford Bulletin of Economics and Statistics*, 48(3), 253-277.
- Benjamin, N. (1990), "Investment, the Real Exchange Rate, and Dutch Disease: A Two-Period General Equilibrium Model of Cameroon." *Journal of Policy Modeling*, 12(1), 77-92.
- Bourdet, Y. and H. Falck (2006), "Emigrants' Remittances and Dutch Disease in Cape Verde." *International Economic Journal*, 20(3), 267-84.
- Buffie, E., C. Adam, S. O'Connell and C. Pattillo (2008), "Riding the Wave: Monetary Responses to Aid Surges in Low-Income Countries." *European Economic Review*, 52(8), 1378-1395.
- Buffie, E., C. Adam, S. O'Connell, and C. Pattillo (2004), "Exchange Rate Policy and the Management of Official and Private Capital Flows in Africa." International Monetary Fund, Staff Papers, 51(Special Issue), 126-60.
- Cerra, V., S. Tekin and S. Turnovsky (2008), "Foreign Aid and Real Exchange Rate Adjustments in a Financially Constrained Dependent Economy." International Monetary Fund, IMF Working Paper 08/204.
- Chow, G. and A. Lin (1971), "Best Linear Unbiased Interpolation, Distribution, and Extrapolation of Time Series by Related Series." *Review of Economics and Statistics*, 53(4), 372-375.
- Collier, P. and J. Gunning (1992), "Aid and Exchange Rate Adjustment in African Trade Liberalisations." *The Economic Journal*, 102(413), 925-39
- Corden, M. (1984). "Boom Sector and Dutch Disease Economics: Survey and Consolidation." *Oxford Economic Papers*, 36(3), 359-380.

- Corden, M. and P. Neary (1982), "Booming Sector and De-Industrialisation in a Small Open Economy." *The Economic Journal*, 92 (368), 825-48.
- Davidson, R. and J. MacKinnon (1993), Estimation and Inference in Econometrics, Oxford University Press, New York.
- Degefa, D. (2001), "The Parallel Foreign Exchange Market and Macroeconomic Performance in Ethiopia." AERC Research Paper 107.
- Devarajan, S., D. Go, J. Page, S. Robinson and K. Thierfelder (2008), "Aid, Growth, and Real Exchange Rate Dynamics." The World Bank, Policy Research Working Paper 4480
- Ebrahim-zadeh, C. (2003), "Back to Basics. Dutch Disease: Too Much Wealth Managed Unwisely." International Monetary Fund, Finance & Development, 40(1).
- Edwards, S. (1989), Real Exchange Rates, Devaluation and Adjustment: Exchange Rate Policy in Developing Countries, MIT Press, Cambridge, Massachusetts.
- Elbadawi, I. (1999), "External Aid: Help or Hindrance to Export Orientation in Africa?" *Journal of African Economies*, 8(3), 578-616.
- Engle, R. and C. Granger (1987), "Co-Integration and Error Correction: Representation, Estimation, and Testing." *Econometrica*, 55(2), 251-276.
- Franses, P and B. Hobijn (1997), "Critical Values for Unit Root Tests in Seasonal Time Series." *Journal of Applied Statistics*, 24(1), 25-47.
- Geda, A. (2006), "The Structure and Performance of Ethiopia's Financial Sector in the Pre- and Post-Reform Period with a Special Focus on Banking." WIDER Research Paper 2006/112.
- Granger, C. and P. Newbold, (1974), "Spurious Regressions in Econometrics." *Journal of Econometrics*, 2(2), 111-120
- Greene, W. (2003), Econometric Analysis (Fifth Edition), Prentice Hall, New Jersey.
- Hallwood, P. and R. MacDonald (2000), International Money and Finance (Third Edition), Blackwell.
- Harvey, A. (1993), Time Series Models (Second Edition), MIT Press, New York.
- Hinkle, L. and P. Montiel, eds. (1999), Exchange Rate Misalignment: Concepts and Measurement for Developing Countries, World Bank, Oxford Press University.
- Hylleberg, S., R. Engle, C. Granger and B. Yoo (1990), "Seasonal Integration and Cointegration." *Journal of Econometrics*, 44(1-2), 215-238.
- Issa, H and B. Ouattara (2008), "Foreign Aid Flows and Real Exchange Rate: Evidence from Syria" *Journal of Economic Development*, 33(1), 133-46
- Johnston, J. and J. DiNardo (1997), Econometric Methods (Fourth Edition), McGraw-Hill.
- Kennedy, P (2003), A Guide to Econometrics (Fifth Edition), John Wiley & Sons

Koopman, S., A. Harvey, J. Doornik and N. Shephard (2007), STAMP 8: Structural Time Series Analyser and Modeller and Predictor, Timberlake Consultants Press, London.

Laplagne, P., M Treadgold and J. Baldry (2001), "A Model of Aid Impact on some South Pacific Microstates." *World Development*, 29(2), 365-383.

Lartey, E. (2007), "Capital Inflows and the Real Exchange Rate: An Empirical Study of Sub-Saharan Africa." *Journal of International Trade and Economic Development*, 16(3), 337-57.

Li, Y. and F. Rowe (2007), "Aid Inflows and the Real Effective Exchange Rate in Tanzania." World Bank Policy Research Working Paper 4456.

Lütkepohl, H. (2005), New Introduction to Multiple Time Series Analysis, Springer.

MacKinnon, J. (1996). "Numerical Distribution Functions for Unit Root and Cointegration Tests." *Journal of Applied Econometrics*, 11(6), 601-618.

Maddala, G. and I. Kim (1998), Unit roots, Cointegration, and Structural Change, Cambridge University Press.

Michaely, M. (1981), "Foreign Aid, Economic Structure, and Dependence." *Journal of Development Economics*, 9(3), 313-330.

Mongardini, J. and B. Rayner (2009), 'Grants, Remittances, and the Equilibrium Real Exchange Rate in Sub-Saharan Africa Countries.' International Monetary Fund, IMF Working Paper 09/75.

Newey, W. and K. West (1987), "A Simple, Positive Semi-definite, Heteroskedasticity and Autocorrelation Consistent Covariance Matrix." *Econometrica*, 55(3), 703-708.

Nkusu, M. (2004), "Aid and the Dutch Disease in Low-Income Countries: Informed Diagnoses for Prudent Prognoses." International Monetary Fund, Working Paper 04/49.

Nyoni, T. (1998), "Foreign Aid and Economic Performance in Tanzania." *World Development*, 26(7), 1235-40.

Ogun, O. (1998), "Real Exchange Rate Movements and Export Growth: Nigeria, 1960-1990." AERC Research Paper 82.

Opoku-Afari, M. (2004), "Measuring the Real Effective Exchange Rate in Ghana." CREDIT Research Paper 04/11.

Opoku-Afari, M, O. Morrissey and T. Lloyd (2004), "Real Exchange Rate Response to Capital Inflows: A Dynamic Analysis for Ghana" CREDIT Research Paper 04/12.

Ouattara, B. and E. Strobl (2004), "Do Aid Inflows Cause Dutch Disease? A Case Study of the CFA Franc Countries." University of Manchester, School of Economic Studies, Discussion Paper 0330.

Pesaran, H., Y. Shin and R. Smith (2001), "Bounds Testing Approaches to the Analysis of Level Relationships." *Journal of Applied Econometrics*, 16(3), 289-326.

Pesaran, H. and B. Pesaran (1997), Working with Microfit 4.0: Interactive Econometric Analysis. Oxford University Press, London.

Pesaran, H. and Y. Shin (1999), "An Autoregressive Distributed Lag Modelling Approach to Cointegration Analysis." *Econometrics and Economic Theory in 20th Century: the Ragnar Frisch Centennial Symposium*, eds. S. Strom, Cambridge University Press, Cambridge.

Phillips, P. and B. Hansen (1990), "Statistical Inference in Instrumental Variables Regression with I(1) Processes." *The Review of Economic Studies*, 57(1), 99-125.

Prati, A. and T. Tressel (2006), "Aid Volatility and Dutch Disease: Is There a Role for Macroeconomic Policies?" International Monetary Fund, Working Paper 06/145.

Prati, A., R. Sahay and T. Tressel (2003), "Is There a Case for Sterilizing Foreign Aid Inflows?" Paper presented at the Research Workshop "Macroeconomic Challenges in Low Income Countries", October 23-24, Washington D.C.: IMF.

QMS (2007), EViews 6 User's Guide I, Quantitative Micro Software, LLC.

Rajan, R. and A. Subramanian (2005), "What Undermines Aid's Impact on Growth?" International Monetary Fund, Working Paper 05/126.

Rogoff, K. (1996), "The Purchasing Power Parity Puzzle." *Journal of Economic Literature*, 34(2), 647-668.

Sackey, H. (2001), "External Aid Inflows and the Real Exchange Rate in Ghana." AERC Research Paper 110.

Saikkonen, P. (1991), "Asymptotically Efficient Estimation of Cointegration Regressions." *Econometric Theory*, 7(1), 1-21.

Stock, J. and M. Watson (1993), "A Simple Estimator of Cointegrating Vectors in Higher Order Integrated Systems." *Econometrica*, 61(4), 783-820.

Torvik, R. (2001), "Learning by Doing and the Dutch Disease." *European Economic Review*, 45(2), 285-306.

Van Wijnbergen, S. (1986), "Macroeconomic Aspects of the Effectiveness of Foreign Aid: On the Two-Gap Model, Home Goods Disequilibrium and Real Exchange Rate Misalignment." *Journal of International Economics*, 21(1-2), 123-36.

Van Wijnbergen, S. (1984), "The 'Dutch Disease': A Disease After All?" *The Economic Journal*, 94(373), 41-55.

Vos, R. (1998), "Aid Flows and 'Dutch Disease' in a General Equilibrium Framework for Pakistan." *Journal of Policy Modeling*, 20(1), 77-109.

White, H. and G. Wignaraja (1992), "Exchange Rates, Trade Liberalization and Aid: The Sri Lankan Experience." *World Development*, 20(10), 1471-80.

Wooldridge, J. (2003), Introductory Econometrics: A Modern Approach (Second Edition), South-Western.

Yano, M. and J. Nugent (1999), "Aid, Nontraded Goods, and the Transfer Paradox in Small Countries." *American Economic Review*, 89(3), 431-449.

Younger, S. (1992), "Aid and Dutch Disease: Macroeconomic Management When Everybody Loves You." *World Development*, 20(11), 1587-97.

Zivot, E. and J. Wang (2006), Modeling Financial Time Series with S-PLUS (Second Edition), Springer-Verlag.