

Kirstein, Roland; von Wangenheim, Georg

Working Paper

A generalized condorcet jury theorem with two independent probabilities of error

MAGKS Joint Discussion Paper Series in Economics, No. 11-2010

Provided in Cooperation with:

Faculty of Business Administration and Economics, University of Marburg

Suggested Citation: Kirstein, Roland; von Wangenheim, Georg (2010) : A generalized condorcet jury theorem with two independent probabilities of error, MAGKS Joint Discussion Paper Series in Economics, No. 11-2010, Philipps-University Marburg, Faculty of Business Administration and Economics, Marburg

This Version is available at:

<https://hdl.handle.net/10419/56511>

Standard-Nutzungsbedingungen:

Die Dokumente auf EconStor dürfen zu eigenen wissenschaftlichen Zwecken und zum Privatgebrauch gespeichert und kopiert werden.

Sie dürfen die Dokumente nicht für öffentliche oder kommerzielle Zwecke vervielfältigen, öffentlich ausstellen, öffentlich zugänglich machen, vertreiben oder anderweitig nutzen.

Sofern die Verfasser die Dokumente unter Open-Content-Lizenzen (insbesondere CC-Lizenzen) zur Verfügung gestellt haben sollten, gelten abweichend von diesen Nutzungsbedingungen die in der dort genannten Lizenz gewährten Nutzungsrechte.

Terms of use:

Documents in EconStor may be saved and copied for your personal and scholarly purposes.

You are not to copy documents for public or commercial purposes, to exhibit the documents publicly, to make them publicly available on the internet, or to distribute or otherwise use the documents in public.

If the documents have been made available under an Open Content Licence (especially Creative Commons Licences), you may exercise further usage rights as specified in the indicated licence.

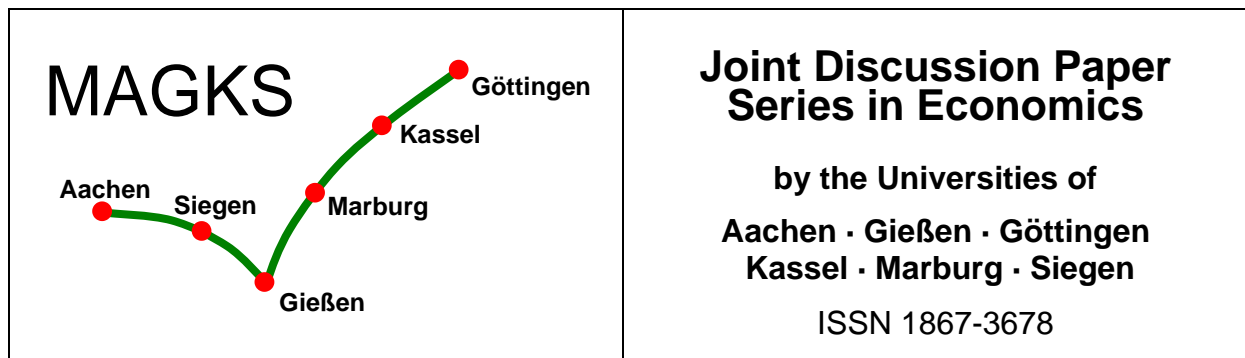

No. 11-2010

Roland Kirstein & Georg v. Wangenheim

**A Generalized Condorcet Jury Theorem with
Two Independent Probabilities of Error**

Roland Kirstein
Faculty of Economics and Management
Otto-von-Guericke-University
Email: roland.kirstein@ovgu.de

Georg v. Wangenheim
Kassel University

This paper can be downloaded from
http://www.uni-marburg.de/fb02/makro/forschung/magkspapers/index_html%28magks%29

Coordination: Bernd Hayo • Philipps University Marburg • Faculty of Business Administration &
Economics • Universitätsstr. 24, D-35032 Marburg
Tel: ++49-6421-2823091, Fax: ++49-6421-2823088 e-mail: hayo@wiwi.uni-marburg.de

A Generalized Condorcet Jury Theorem with Two Independent Probabilities of Error

Roland Kirstein * Georg v. Wangenheim **

March 12, 2010

Abstract

The Condorcet Jury Theorem is derived from the implicit assumption that jury members only commit one type of error. If the probability of this error is smaller than 0.5, then group decisions are better than those of individual members. In binary decision situations, however, two types of error may occur, the probabilities of which are independent of each other. Taking this into account leads to a generalization of the theorem. Under this generalization, situations exist in which the probability of error is greater than 0.5 but the jury decision generates a higher expected welfare than an individual decision. Conversely, even if the probability of error is lower than 0.5 it is possible that individual decisions are superior.

JEL-Code: *D71, K40, L22*

Encyclopedia of Law and Economics: *0610, 7100*

Keywords: *Group decisions, judicial, imperfect decision-making.*

*Corresponding author: Economics of Business and Law, Faculty of Economics and Management, Otto-von-Guericke-University, Bldg. 22/D-003, PO Box 1402, 39016 Magdeburg, Germany. Email: roland.kirstein@ovgu.de.

**Professor of Law and Economics, Kassel University, Germany.

Contents

1	Introduction	3
2	The Condorcet Jury Theorem	5
3	Imperfect binary decisions	8
3.1	The basic decision model	8
3.2	Decision without experts or a one-expert jury	10
4	Imperfect binary decisions and juries	11
4.1	Optimal size of juries	11
5	Solution of complete decision problem	21
6	Results and discussion	23
A	Proof of Lemma 1	28
B	Proof of Part c. of Theorem 1	31
C	Proof of Lemma 2	32
D	Proof of the definition of k^* in Corollary 1	33
E	Proof of Lemma 3	34
F	Proof of Lemma 4	36
G	Proof of Properties of $\hat{r}_k(w)$ and of $\tilde{r}_k(w)$	37
G.1	$\hat{r}_k(w)$	37
G.2	$\tilde{r}_k(w)$	38
H	Proof of Lemma 5	39
I	Proof of Lemma 6	39

1 Introduction

The Condorcet Jury Theorem (henceforth: CJT) states the conditions under which a jury that decides with absolute majority is less likely to commit an error than each single member.¹ Under two further implicit assumptions (namely: correct decisions are efficient and the group decides without organizational costs) the CJT thus states the condition under which the group decision increases expected welfare, compared to the individual decision.

In this paper, we maintain the assumptions that correct decisions are beneficial and groups decide with absolute majority and without cost. We take a closer look at the fact that the CJT focuses on binary decisions.² Such decision situations are governed by two types of errors. E.g., if the decision is among a legislative initiative and the status quo, the new law may improve or deteriorate welfare. Thus, the decision for it can be welfare decreasing (one type of error) or maintaining the status quo may result in a foregone welfare gain (second type of error). The probabilities with which these two types of errors are committed are independent from each other. Condorcet himself notes (1785: 12 and several times later) that errors of the two types may involve different costs and thus deserve different quorums for decisions which may involve the more expensive error. However he does not discuss the case of different error probabilities for the two types of error. It is the aim of this paper to derive a modified CJT under the assumption that the probabilities of two types of errors are independent from each other.

The CJT makes three statements: If the probability of an individual jury member to decide correctly is greater than 0.5, then 1. the group decides correctly with a higher probability than an individual member; 2. increasing the group size increases the probability of its correct decision; 3. this probability goes towards one if the group size goes towards infinity. Taking into account two independent error-probabilities, we can prove corresponding results for these three claims.

With two probabilities of errors, the comparison of the decision quality of

¹For an overview of Condorcet's contributions to mathematical economics see Crépel/Rieucan (2005) and Rothschild (2005). Many real-world examples can be found in Surowiecki (2004) who, however, fails to even mention the name Condorcet.

²The case of more than two options has been analyzed by List/Goodin (2001).

two juries of different size is not as trivial as in the simplified case covered by the CJT. The first step of our analysis is, thus, the determination of the expected welfare generated by a jury that consist of homogeneous members who decide with absolute majority. Using expected welfare as a criterion for decision quality, we derive our results on the relation between jury size and expected welfare. Our results show that the CJT is a special case of our generalized jury theorem, as the CJT assumes two equal probabilities of error. Under this assumption, our model reproduces all the results of the original CJT. However, many combinations of error probabilities exist under which the claims made by the original CJT had to be modified.

The CJT has been used in Schofield (2002), (2005) and Congleton (2005) to evaluate the merits of representative democracy. Another possible area of application is public choice, e.g., the analysis of federalism in Mueller (2001). In business administration, the CJT may prove useful to analyze hierarchies.³ Another application to organizational theory has been provided by Ladha (1992), while Berg/Marañon (2001) and Koh (2005) have analyzed hierarchies.

Moreover, the CJT may help to theoretically determine the decision quality of collegial courts compared to that of single judges. An empirical study by Karotkin (1994) has demonstrated that chambers composed of three judges do not come to better judgements in private law cases. In penal law cases, however, the opposite is true.⁴ The CJT may provide valuable insights for the design of court systems.⁵ Society wishes courts to avoid errors. If the theorem is true, then society faces a trade-off between decision quality (demanding larger chambers or juries) and the cost of running the court system, as collegial courts are more cost-intensive. Moreover, the duration of a court case might be increased if more judges are involved, as Tullock

³Boland (1989) examines whether it is better to split a jury of, say, nine members into three sub-committees, let each of these sub-committees vote on the issue, and then aggregate the three votes to one decision. In his model, an indirect majority system does not improve the quality of a group decision.

⁴The criterion for decision quality was the rejection rate in appeal courts.

⁵In 1970, the US Supreme Court ruled that state juries need not consist of twelve members (No. 399-U.S. 78, Williams vs. Florida). This decision has provoked research activities regarding the impact of jury size on the probability of conviction; see Gelfand/Solomon (1973).

(1994) has argued. Juries of peers are also costly, as ordinary citizens may face enormous opportunity costs when serving in a jury. These cost aspects are assumed away in the CJT.

The rest of this paper is organized as follows: Section 2 briefly repeats the CJT, which mainly serves to introduce our notation.

In section 3.1 we introduce a theory of imperfect binary decision making. This theory highlights decision situations in which the choice between two options A and B is influenced by the probability of two types of errors. It serves well to model decisions by experts, i.e., decision-makers whose probabilities of error are smaller than those of ordinary people. The analysis in section 3.1 presents conditions under which it is better for society to blindly carry out one of the two options, and when it is beneficial to ask an expert.

Our ultimate goal is to derive the condition under which it is better to appoint a jury (consisting of homogeneous experts who decide with majority) rather than a single expert or a decision based solely on the prior information. As the single expert can be perceived as a jury of size one, the next step of our analysis derives the conditions under which it is beneficial to appoint a larger jury, based on expected payoffs from the decision. This analysis allows us to derive the modified jury theorem in Section 4. In Section 5 we extend the modified theorem to the comparison with the decision based solely on the prior information. In Section 6 we briefly discuss the derived insights.

2 The Condorcet Jury Theorem

Assume that a decision body is composed of an odd number of members ($k = 2h + 1$ with $h \in \mathbb{N}^+$), and that each of these members decides independently of the others. The collective decision is made with absolute majority, while abstention is neglected and prior communication is excluded.⁶ Moreover, the jury members are assumed to be homogeneous: each comes to the correct

⁶Juries with members who do not decide independently of each other are analyzed by Berg (1993) and Ladha (1995). The qualified majority rule was analyzed by Nitzan/Paroush (1984) and Ben-Yasar/Nitzan (1997). The reliability of jury decisions under alternative majority rules has been compared by Klausner/Pollak (2001). Feddersen/Pesendorfer (1998) have asked whether the decision quality of a jury increases if it switches from a majority to an unanimity rule.

decision with probability $q \in [0, 1]$.⁷ Finally it is assumed that the members do not face incentive problems when making their decisions.⁸

Let $Q(j, q)$ denote the probability that j members come to the correct decision, and $Q_k(q)$ the probability that more than h out of k members decide correctly. Then

$$Q(j, q) = \binom{k}{j} q^j (1 - q)^{k-j}, j \leq k \quad (1)$$

and

$$Q_k(q) = \sum_{j=h+1}^k Q(j, q). \quad (2)$$

We will later make use of the following lemma:⁹

Lemma 1 *For all $h \in \mathbb{N}^+$ and $k = 2h + 1$:*

1. $Q_k(0) = 0$ and $Q_k(1) = 1$,
2. $Q_k(q)$ is symmetric in the sense that $Q_k(1 - q) = 1 - Q_k(q)$, which implies that $Q(1/2) = 1/2$,
3. $\frac{dQ_k(q)}{dq} = k \binom{2h}{h} q^h (1 - q)^h$,
4. $\frac{d^2Q_k(q)}{dq^2} = kh \binom{2h}{h} q^{h-1} (1 - q)^{h-1} (1 - 2q)$, which implies that $Q_k(q)$ is s-shaped.
5. $\Delta_{k+2}(q) \equiv Q_{k+2}(q) - Q_k(q) = (2q - 1) \binom{k}{h} q^{h+1} (1 - q)^{h+1}$ is positive (negative) for all $q \in (1/2, 1)$ ($q \in (0, 1/2)$).
6. $\Delta_{k+2}^2(q) \equiv \Delta_{k+4}(q) - \Delta_{k+2}(q) = (2q - 1) q^{h+1} (1 - q)^{h+1} (4q(1 - q) \frac{k+1}{k+2} - 1) = \Delta_{k+2}(q) (4q(1 - q) \frac{k+1}{k+2} - 1) \binom{k}{h}^{-1}$ has the opposite sign of $\Delta_{k+2}(q)$ and is thus negative (positive) for all $q \in (1/2, 1)$ ($q \in (0, 1/2)$).

Figure 1 exemplifies the shape of $Q_k(q)$ for $k = 3, 7, 15, 99$. The higher k , the greater the curvature of $Q_k(q)$. Using this Lemma, the main claim of the CJT is easy to be proven.

⁷For larger juries, however, this assumption is hardly satisfied; Berg (1996, 231) derives results for heterogeneous juries; see also Paroush (1998), Berend/Paroush (1998), Berend/Sapir (2007).

⁸Strategic voting is analyzed in Feddersen/Pesendorfer (1998).

⁹The proof of Lemma 1 is found in Appendix A.

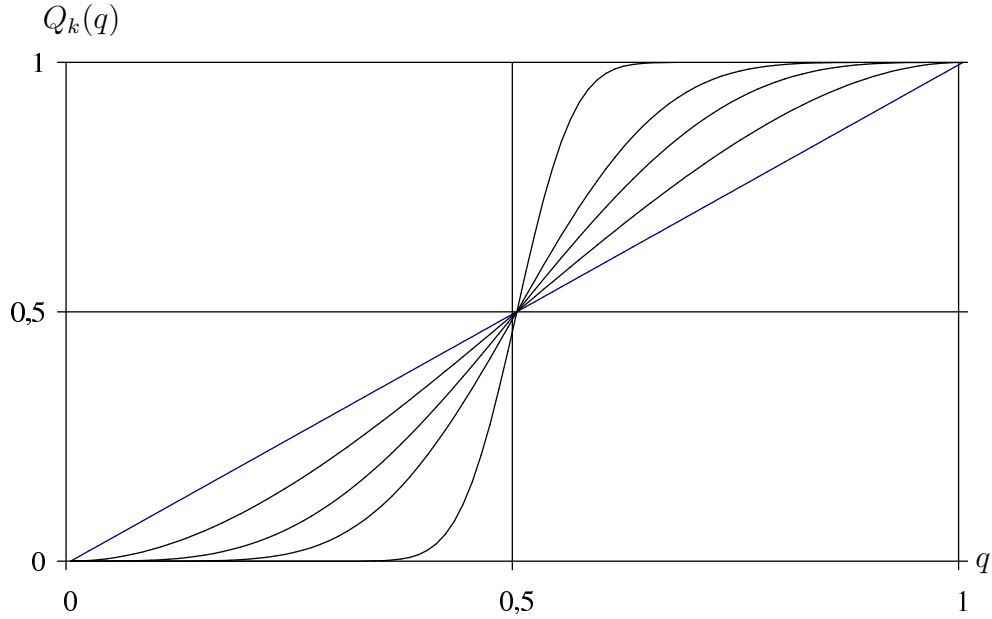

Figure 1: Shape of $Q_k(q)$ for $k = 3, 7, 15, 99$

Theorem 1 (Condorcet Jury Theorem) *Consider a jury that consists of $k = 2h + 1$ members, each of whom decide correctly with probability q . The jury decides with absolute majority. For all $h \in \mathbb{N}^+$, and for all $q \in (1/2, 1)$:*

- a. $Q_k(q) > q$
- b. $Q_{k+2}(q) > Q_k(q)$
- c. $\lim_{k \rightarrow \infty} Q_k(q) = 1$.

Proof: We first note that for $k = 3$ we have: $Q_k(q) = q^3 + 3q^2(1 - q) = q(1 + (2q - 1)(1 - q)) > q$ for $1/2 < q < 1$, which proves part a. for $k = 3$. Part b. follows directly from part 5 of Lemma 1 and implies that part a. also holds true for all $k > 3$.

Part c is is proven in Condorcet (1785: 8-9). *alternative last sentence:* Part c is proven in the appendix.*end of alternative*¹⁰ \square

¹⁰For other proofs of the theorem see Black (1958) and Young (1988).

We remark that for $0 < q < 1/2$, we have $Q_k(q) < q$, $Q_{k+2}(q) < Q_k(q)$, and $\lim_{k \rightarrow \infty} Q_k(q) = 0$.¹¹

Berend/Paroush (1998) derive sufficient and necessary conditions for the theorem to hold for individuals with heterogeneous probabilities of error, but they do not discuss differences in the probabilities of errors of different type.

The CJT evaluates jury decisions in a very optimistic manner, as long as an individual member's probability of error is smaller than 0.5: In this case, a majority decision of a jury is always better than a decision of a single member. Moreover, the probability of a correct jury decision is strictly increasing in the size of the body. For a body of infinite size, this probability even converges to certainty. For $q < 1/2$, the opposite claims are true. In the remainder of the paper, we challenge this optimism for probabilities of error which depend on the type of error.

3 Imperfect binary decisions

3.1 The basic decision model

Courts or juries often face a binary decision and, thus, may commit two types of errors.¹² For example, a judge may convict an innocent suspect, or acquit a guilty suspect. There is no reason why these two types of errors should occur with identical probabilities. In general, these probabilities of error are independent of each other. However, this is neglected by the original CJT and the variations we find in the literature so far.

Consider a risk-neutral decision-maker – for example, a judge, a manager, a prime minister, a committee, a legislative body, a people's assembly – who has to decide between two options, A and B, without knowing which of the two is better. Assume that the payoff generated by the options depends on the unknown state of nature s which is either “A is better” (denoted α) or “B is better” (denoted β). Hence, the decision-maker faces a payoff structure $U(A|\alpha) > U(B|\alpha)$ and $U(A|\beta) < U(B|\beta)$. Let π denote the prior probability that A is the better option.

¹¹For $q \in \{0; 1/2; 1\}$, we have $\lim_{k \rightarrow \infty} Q_k(q) = Q_{k+2}(q) = Q_k(q) = q$.

¹²Tullock (1994), Kirstein/Schmidtchen (1997).

true state	α	β
better decision	A	B
prior	π	$1 - \pi$
probability that an expert decides for A	r	w
probability that an expert decides for B	$1 - r$	$1 - w$
payoff from decision for A	$G > 0$	$L < 0$
payoff from decision for B	0	0

Table 1: Parameters of Imperfect Binary Decisions

We define G as the the gain from carrying out option A if this is the better option, hence: $G = U(A|\alpha) - U(B|\alpha) > 0$. Moreover, let L denote the loss from carrying out A if B is the better option, thus: $L = U(A|\beta) - U(B|\beta) < 0$.

To make his decision, the decision-maker may either rely on his priors or delegate the decision to one or several experts, each of whom has private and independent information and, on the basis of this information, decides for A with probability $r \in [0, 1]$ if the true state of the world is $s = \alpha$ and with probability $w \in [0, r]$ if the true state of the world is $s = \beta$.¹³ The parameters r and w provide a measure for their decision quality: $r = 1, w = 0$ represents the case of perfect experts who decide without errors, while $r = w$ implies the lack of ability to distinguish the two possible true states from each other. $0 < w < r < 1$ models the case of experts who decide better than just blindly, albeit not perfectly. If $r = 1 - w$ the probability of error is independent of the true state of the world, as in the statements of the original CJT.¹⁴ In correspondance to Condorcet's argument, we assume that the decision-maker aggregates the decisions of more than one agents by simple majority.

Table 1 displays all relevant parameters of the model. The following list summarizes the three stylized approaches how the decision-maker may decide between A and B:

1. **No jury:** He can just pick one of the two options solely on the basis

¹³The possible incentive problem between the expert and the decision-maker is not in the focus of this paper and, thus, is assumed to be solved.

¹⁴The assumption $w \leq r$ corresponds to $q > 1/2$ in the original CJT. One can easily extend the argument by allowing $w > r$, but the exposition of the argument is more simple with $w \leq r$.

of his priors.

2. **Jury of size one:** He can delegate the decision to a single expert who determines the choice.
3. **Jury of size larger than one:** In the light of the CJT, he may consider a group of $k \geq 3$ of such (homogeneous) experts, i.e., a “jury” that decides with majority.

Before we generalize the CJT in section 4, we analyze the decision-maker’s problem if he can only decide ‘blindly’ between A and B or delegate the decision to one single expert.

3.2 Decision without experts or a one-expert jury

Assume for the moment that the decision-maker has no experts at hand and, therefore, has to decide “blindly” between the two options A and B. He will carry out A if $\pi G + (1 - \pi)L > 0$, and pick B if $\pi G + (1 - \pi)L < 0$. If $\pi G + (1 - \pi)L = 0$ he is indifferent between the two options. Defining a parameter

$$T = \frac{-L(1 - \pi)}{G\pi}$$

allows us to simplify these three conditions as $T < 1$, $T > 1$, and $T = 1$, respectively.

We extend the previous decision problem by allowing the decision-maker to appoint one single expert instead of deciding blindly. Figure 2 depicts the new decision problem. First, a random move (by nature N) determines whether A (probability π) or B ($1 - \pi$) is better. This is unobservable for the decision-maker (D) who decides whether to “blindly” carry out A or B only based on the priors, or to employ an expert who makes the correct decision with probabilities r or $1 - w$.

Delegating the decision to a single expert yields an expected payoff of $r\pi G + w(1 - \pi)L$. This is better than carrying out the respective better option without delegation if, and only if, $r\pi G + w(1 - \pi)L > \max[\pi G + (1 - \pi)L, 0]$, or simply:¹⁵

¹⁵This result is parallel to the “reliability condition” in Heiner (1983).

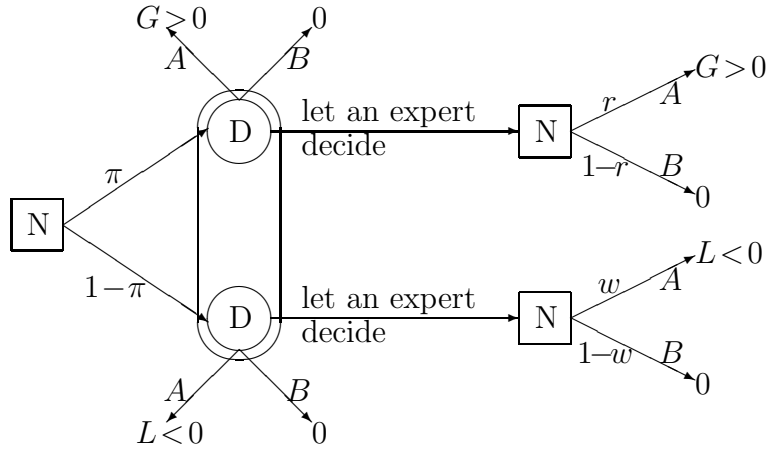

Figure 2: Decision among A, B, and employing one expert

$$T \in \left(\frac{1-r}{1-w}, \frac{r}{w} \right). \quad (3)$$

The following table summarizes the optimal choice of the decision-maker when he is restricted to “blind” decisions or one-expert juries:

decision environment	optimal choice
$T < \frac{1-r}{1-w}$	“blindly” choose A
$T = \frac{1-r}{1-w}$	“blindly” choose A or delegate decision to one-expert jury
$\frac{1-r}{1-w} \leq T \leq \frac{r}{w}$	delegate decision to one-expert jury
$T = \frac{r}{w}$	“blindly” choose B or delegate decision to one-expert jury
$T > \frac{r}{w}$	“blindly” choose B

4 Imperfect binary decisions and juries

4.1 Optimal size of juries

We now consider the decision-maker’s option to employ a jury that consists of $k \in \{3; 5; \dots\}$ experts. The decision-situation is outlined in figure 3. First,

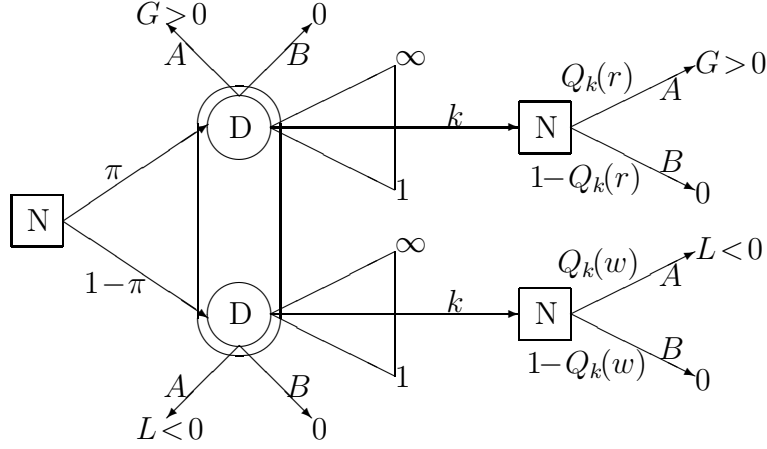

Figure 3: Decision among A, B, and employing an expert jury

nature decides which option is best. Then, the decision-maker either carries out A or B blindly, or employs a jury of k members. Employing one agent is a special case, namely $k = 1$, which was analyzed in the previous section.

If a jury is employed and the true state of the world were known to an exogenous observer, the situation would be perfectly parallel to the original jury problem of Condorcet. The probability that a majority of the jury decides correctly is given by $Q_k(q)$ with q being replaced by r or w depending on the true state of the world.¹⁶ Hence, if the true state of the world were $s = \alpha$, then a majority of experts would decide for A with probability $Q_k(r)$. If the true state of the world were $s = \beta$, a majority of experts would (wrongly) decide for A with probability $Q_k(w)$.

Hence, if the decision-maker employs a jury of k identical, imperfect experts who are characterized by quality parameters (r, w) then the expected payoff will be

$$W_k(r, w) \equiv Q_k(r)\pi G + Q_k(w)(1 - \pi)L. \quad (4)$$

Note that if the two types of error were symmetric, i.e. if $r = w = q$ and $G = L$, this expression would be a constant multiple of $Q_k(q)$ in equation (2). An extension of Lemma 1 therefore suggests itself. Before we present

¹⁶Recall that $Q_k(\cdot)$ has been defined in equation (2) above.

the extension, we introduce a Definition for easier reference.

Definition 1 *Let the set C be the combinations of r and w , for which no error probability is larger than one half and at least one of them is smaller: $C = \{(r, w) \mid 0 \leq w \leq 1/2 \leq r \leq 1\} \setminus (\{1/2, 1\} \times \{0, 1/2\})$.*

Lemma 2 *For all $h \in \mathbb{N}^+$ and $k = 2h + 1$:*

1. $W_k(0, 0) = 0$ for $r = w = 0$ and $W_k(1, 1) = \pi G + (1 - \pi)L$ for $r = w = 1$,
2. $W_k(r, w)$ is symmetric around $1/2(\pi G + (1 - \pi)L)$ in the sense that $W_k(1 - r, 1 - w) = (\pi G + (1 - \pi)L) - W_k(r, w)$, which implies that $W_k(1/2, 1/2) = 1/2(\pi G + (1 - \pi)L)$,
3. $\frac{dW_k(r, w)}{dr} = k \binom{2h}{h} r^h (1 - r)^h \pi G > 0$ and $\frac{dW_k(r, w)}{dw} = k \binom{2h}{h} w^h (1 - w)^h (1 - \pi)L < 0$,
4. $\frac{d^2W_k(r, w)}{dr^2} = kh \binom{2h}{h} r^{h-1} (1 - r)^{h-1} (1 - 2r)\pi G$ and $\frac{d^2W_k(r, w)}{dw^2} = kh \binom{2h}{h} w^{h-1} (1 - w)^{h-1} (1 - 2w)(1 - \pi)L$, which implies that $W_k(r, w)$ is s-shaped when only one probability of error is considered,
5. $\Psi_{k+2}(r, w) \equiv W_{k+2}(r, w) - W_k(r, w)$ is positive when $(r, w) \in C$, and is negative for $k \rightarrow \infty$ when either $r > w > 1/2$ or $1/2 > r > w$,
6. $\Psi_{k+2}^2(r, w) \equiv \Psi_{k+4}(r, w) - \Psi_{k+2}(r, w)$ is negative when either of the following conditions is satisfied:
 - (a) $(r, w) \in C$
 - (b) $\Psi_{k+4}(r, w) \geq 0$ and either $r > w > 1/2$ or $1/2 > r > w$.

To cope with problems resulting from our assumption that the size of a jury is an odd number, we introduce the following

Definition 2 *We say that the jury size satisfying a property is **quasi-unique** if the difference of any two jury sizes satisfying the property is at most 2.*

In other words, quasi-uniqueness requires that either only one jury size satisfies the property or one jury size and one of its direct neighbors.

With this definition, Lemma 2 has an important

Corollary 1 *The size of the jury that maximizes the expected payoff as defined in equation (4) is*

1. *infinite for $(r, w) \in C$,*
2. *finite, quasi-unique and given by $k^*(r, w) = 2 \max \{0, \lfloor h^*(r, w) \rfloor + 1\}$ for $r > w > 1/2$ and for $1/2 > r > w$, where*

$$h^*(r, w) = \ln \left[\frac{(2w-1)T}{(2r-1)} \right] / \ln \left[\frac{r(1-r)}{w(1-w)} \right] \quad (5)$$

and $\lfloor x \rfloor$ is the largest integer smaller than, or equal to x .

Proof: Part 1 of the corollary follows immediately from part 5 of Lemma 2. Finiteness in part 2 of the corollary follows from $\lim_{k \rightarrow \infty} \Psi_{k+2}(r, w) < 0$ (part 5 of Lemma 2). Quasi-uniqueness follows from parts 5 and 6 of Lemma 2: Part 5 implies that for all sufficiently large k , the expected payoff from increasing the jury size is negative. Part 6 implies that $\Psi_k(r, w) > 0$ for all $k < k^*$ when $\Psi_{k^*}(r, w) \geq 0$. Hence once the jury size is small enough to let a decline in the jury size by two members result in a non-positive change of the expected payoff, then all further declines in the jury size will strictly decrease the expected payoff. The definition of $h^*(r, w)$ is given by the largest h for which $\Psi_{k^*}(r, w) \geq 0$ is satisfied (see Appendix D).

In order to easily see the relation between the error probabilities and the optimal jury size, we take a closer look at the conditions for $\Psi_{k+2}(r, w) = 0$, i.e. the conditions for $W_k(r, w)$ being as large as $W_{k+2}(r, w)$, which is shown in Appendix C to be equivalent to:

$$(2r-1)(r(1-r))^{h+1} = T(2w-1)(w(1-w))^{h+1} \quad (6)$$

Definition 3 *For $T \leq 1$, let $\mathcal{R}_k(w)$ be the set of $r \in (0, 1)$ which solve equation (6) for a given value of $w \in (0, 1)$. Further, define $r_k^*(w) = \max(\mathcal{R}_k(w))$.*

For $T > 1$, let $\mathcal{W}_k(r)$ be the set of $w \in (0, 1)$ which solve equation (6) for a given value of $r \in (0, 1)$. Further, define $w_k^(r) = \min(\mathcal{W}_k(r))$.*

Lemma 3 *For all $k^* \in \mathbb{N}^+$ and $T \leq 1$,*

- a. *$r_k^*(w)$ exists and is unique and continuous except for $w = 1/2$, where $\lim_{w \uparrow 1/2} r_k^*(w) = r_k^*(1/2) = 1/2$ and $\lim_{w \downarrow 1/2} r_k^*(w) = 1$;*

- b. $\lim_{w \rightarrow 0} r_k^*(w) = 1/2$ and $\lim_{w \rightarrow 1} r_k^*(w) = 1$;
- c. $r_k^*(w)$ has one minimum and no interior maximum for $w \in (0, 1/2)$ and one minimum and no interior maximum for $w \in (1/2, 1)$;
- d. $r_k^*(w)$ increases in k when $w \in (0, 1/2)$ and decreases in k when $w \in (1/2, 1)$.

For all $k^* \in \mathbb{N}^+$ and $T > 1$, $w_k^*(r)$ has corresponding properties.

The proof follows directly from the previous definition. Details are given in Appendix E.

Corollary 2 *The optimal size of the jury is k^* if and only if*

$$r \in [r_{k^*-2}^*(w), r_{k^*}^*(w)] \text{ for } T \leq 1 \text{ and } w \in (0, 1/2);$$

$$r \in [r_{k^*}^*(w), r_{k^*-2}^*(w)] \text{ for } T \leq 1 \text{ and } w \in (1/2, 1);$$

$$w \in [w_{k^*-2}^*(r), w_{k^*}^*(r)] \text{ for } T > 1 \text{ and } r \in (0, 1/2);$$

$$w \in [w_{k^*}^*(r), w_{k^*-2}^*(r)] \text{ for } T > 1 \text{ and } r \in (1/2, 1).$$

Proof: The corollary follows from the fact that $W_k(r, w) = W_{k+2}(r, w)$ on $r_k^*(w)$ and on $w_{k+2}^*(r)$ and the fact that for $T \leq 1$, $h^*(r, w)$ increases (decreases) in r for $w \in (0, 1/2)$ (for $w \in (1/2, 1)$) and for $T \geq 1$, $h^*(r, w)$ increases (decreases) in w for $r \in (0, 1/2)$ (for $r \in (1/2, 1)$). Hence, for example on $r_3^*(w)$ we have $W_3(r, w) = W_5(r, w)$, i.e. a jury of three is as good as a jury of five. If $T \leq 1$ and $w \in (0, 1/2)$ and we slightly increase r , then $h^*(r, w)$ becomes larger, i.e. now we have $W_3(r, w) < W_5(r, w)$. As we still have $r < r_5^*(w)$, it is also true that $W_5(r, w) > W_7(r, w)$. Hence, five is the optimal size of the jury.

Figure 4 depicts the optimal jury sizes for $T < 1$ and for $T = 1$; the graph for $T > 1$ is symmetric to the graph for $T < 1$.

We have now shown that for $r > w > 1/2$ and for $1/2 > r > w$ increasing the size of the jury is not always better. To the contrary, increasing the size of the jury may result in a reduction of the expected payoffs. One can hence not exclude that too large juries may even be worse than the decision by a

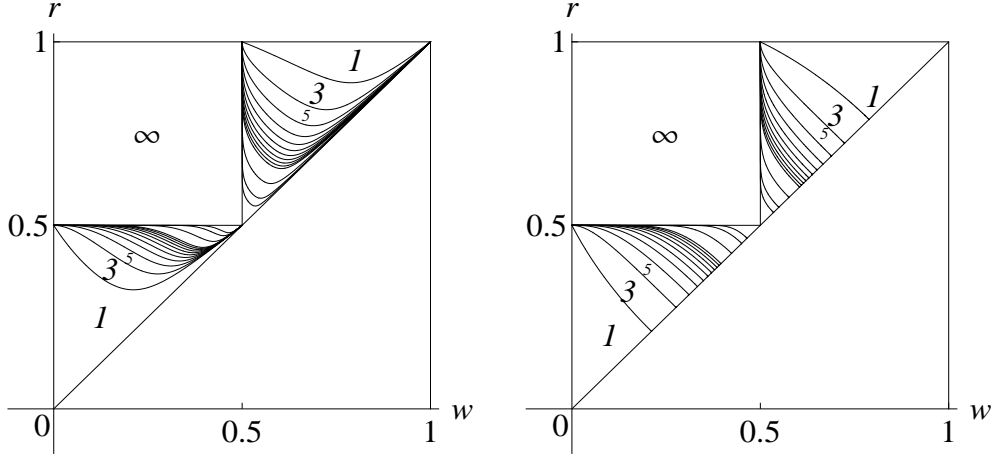

Figure 4: Optimal jury size: areas of combinations of r and w for which the optimal size is 1, 3, 5 or infinity are marked by italicized numbers; the borders $r_k^*(w)$ of these areas are drawn for all $k \leq 21$ and for $k \in \{41, 101, 201\}$. Left: $T = 0.8$, right: $T = 1$.

single expert. To derive an insight corresponding to part a of the original CJT, we therefore consider the expected-payoff advantage of a large jury:

$$V_k(r, w) \equiv W_k(r, w) - W_1(r, w) = (Q_k(r) - r)\pi G + (Q_k(w) - w)(1 - \pi)L \quad (7)$$

Due to separability of $V_k(r, w)$, we can derive the following first important property of this function (see figure 5 for an example):

Lemma 4 *The expected-payoff advantage $V_k(r, w)$ of a jury of size $k > 1$ is a continuous function of r and w . This function is strictly positive for $(r, w) \in C$ and assumes the following interior extrema:*

- *With respect to r , the unique maximum is at $r = 1/2 + K_k$ and the unique minimum at $r = 1/2 - K_k$,*
- *with respect to w , the unique maximum is at $w = 1/2 - K_k$ and a unique minimum at $w = 1/2 + K_k$,*

where

$$K_k \equiv \sqrt{\frac{1}{4} - \left[k \binom{2h}{h} \right]^{-1/h}} \in \left(0, 1/\sqrt{12} \right]. \quad (8)$$

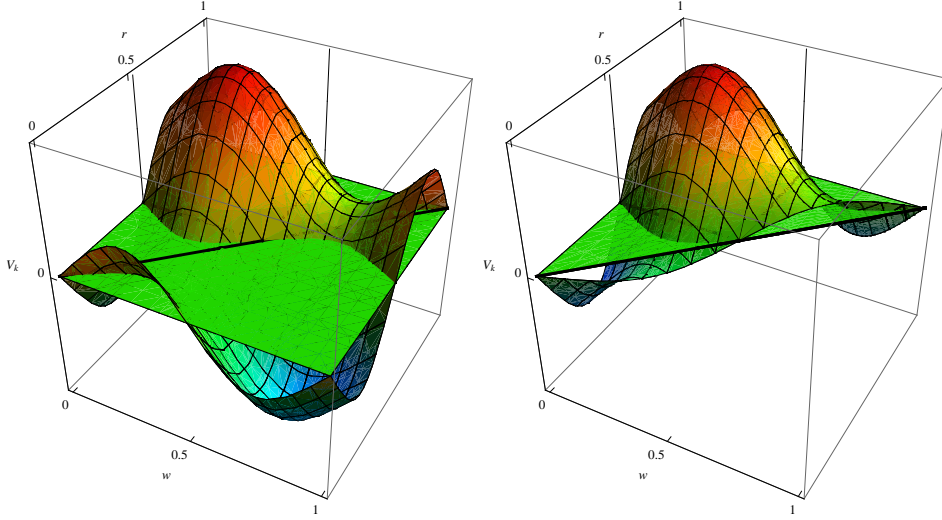

Figure 5: $V_k(r, w)$ for $k = 7$ and $T = 0.7$. w is from left to right, r from front to back. The green plane is at $V_k(r, w) = 0$. The left figure plots the entire unit square, the right figure is restricted to $0 \leq w \leq r \leq 1$

In order to identify the combinations of r and w for which $V_k(r, w) > 0$ holds true, we define a unique function $\hat{r}_k(w)$ for $T < 1$ implicitly by:

$$V_k(\hat{r}_k(w), w) \equiv 0 \wedge \hat{r}_k(w) \in (w, 1) \quad (9)$$

For $w \in (0, 1/2)$ this function exists, is unique and continuous, has a unique interior minimum at $w = 1/2 - K_k$ with $\hat{r}_k(1/2 - K_k) > 1/2 - K_k$ and approaches $r = 1/2$ both for $w \rightarrow 0$ and for $w \rightarrow 1/2$. $\lim_{k \rightarrow \infty} \hat{r}_k(w) = 1/2$ for all $w \in (0, 1/2)$.

Similarly, for $w \in (1/2, 1)$ the function exists, is unique and continuous, has a unique interior minimum at $w = 1/2 + K_k$ with $\hat{r}_k(1/2 + K_k) > 1/2 + K_k$, and approaches $r = 1$ both for $w \rightarrow 1/2$ and for $w \rightarrow 1$. Further, for $w \in (1/2, 1)$ we have $\hat{r}_k(w) > 1 - T + wT$ and $\lim_{k \rightarrow \infty} \hat{r}_k(w) = 1 - T + wT$. The function is undefined for $w \in \{1/2, 1\}$. These properties are proven in Appendix G. This function as well as the two further functions to be defined in what follows are depicted in Figure 6.

For $T > 1$, we define a corresponding function $\hat{w}_k(r)$ by

$$V_k(r, \hat{w}_k(r)) \equiv 0 \wedge \hat{w}_k(r) \in (0, r), \quad (10)$$

which has symmetric properties: For $r \in (1/2, 1)$ (and for $r \in (0, 1/2)$) this function exists, is unique and continuous, has a unique interior maximum at $r = 1/2 + K_k$ with $\hat{w}_k(1/2 + K_k) < 1/2 + K_k$ (at $r = 1/2 - K_k$ with $\hat{w}_k(1/2 - K_k) < 1/2 - K_k$), and approaches $w = 1/2$ for $r \rightarrow 1/2$ and for $r \rightarrow 1$ ($w = 0$ for $r \rightarrow 0$ and for $r \rightarrow 1/2$). For $r \in (0, 1/2)$, we have $\hat{w}_k(r) < r/T$ and $\lim_{k \rightarrow \infty} \hat{w}_k(r) = r/T$. The proof is also symmetric to the proof of $\hat{r}_k(w)$ and therefore omitted.

Finally, for $T = 1$ we define $\tilde{r}_k(w)$ by:

$$V_k(\tilde{r}_k(w), w) \equiv 0 \wedge \tilde{r}_k(w) \in (w, 1) \quad (11)$$

This function exists only for $w \in [0, 1/2 - K_k) \cap (1/2, 1/2 + K_k)$, is unique, continuous and strictly decreasing in the same interval, satisfies $\tilde{r}(0) = 1/2$ and approaches $\tilde{r}(w) = 1$ when $w \rightarrow 1/2$ and $\tilde{r}(w) = 1/2 \pm K_k$ when $w \rightarrow 1/2 \pm K_k$, (proof in Appendix G).

With these functions, we can easily define the set of r - w -combinations for which $V_k(r, w) > 0$:

Lemma 5 *A jury of size $k > 1$ hands down better decisions than an individual expert if and only if $(r, w) \in C \cup C_{1,k}^T \cup C_{2,k}^T$, where*

$$\begin{aligned} \text{for } T < 1: C_{1,k}^T &= \{(r, w) | w \in (0, 1/2) \wedge r \in (\hat{r}_k(w), 1/2)\} \\ \text{and } C_{2,k}^T &= \{(r, w) | w \in (1/2, 1) \wedge r \in (w, \hat{r}_k(w))\} \end{aligned}$$

$$\begin{aligned} \text{for } T = 1: C_{1,k}^T &= \{(r, w) | w \in (0, 1/2 - K_k) \wedge r \in (\max\{w, \tilde{r}_k(w)\}, 1/2)\} \\ \text{and } C_{2,k}^T &= \{(r, w) | w \in (1/2, 1/2 + K_k) \wedge r \in (w, \tilde{r}_k(w))\} \end{aligned}$$

$$\begin{aligned} \text{for } T > 1: C_{1,k}^T &= \{(r, w) | r \in (1/2, 1) \wedge w \in (1/2, \hat{w}_k(r))\} \\ \text{and } C_{2,k}^T &= \{(r, w) | r \in (0, 1/2) \wedge w \in (\hat{w}_k(r), w)\} \end{aligned}$$

With respect to $T = 1$ we recall that $\tilde{r}_k(w)$ fails to exist for $w \in (1/2 - K_k, 1/2)$ so that $\max\{w, \tilde{r}_k(w)\} = w$ in this interval. Figure 6 depicts the sets $C_{i,k}^T$ with $i \in \{1, 2\}$ for $k = 11$. For all other k , the shape of these sets is similar, except for $k \in \{3, 5\}$ for which $\tilde{r}_k(w)$ (which is only relevant for $T = 1$) is convex (concave) close to $w = 1/2 - K_k$ (close to $w = 1/2 + K_k$).

We are now ready to generalize the CJT to the case of two independent error probabilities:

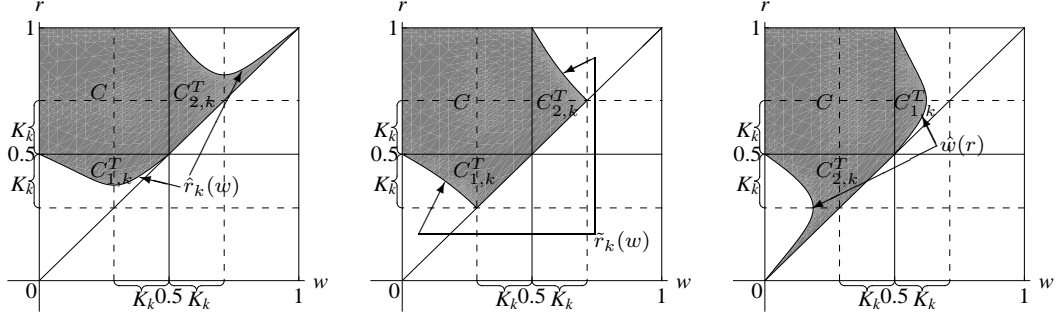

Figure 6: Jury decision ($k = 11$) is superior to individual decision in grey areas. Left: $T = 0.8$, middle: $T = 1$, right: $T = 1.25$.

Theorem 2 (Generalized Condorcet Jury Theorem) Consider a jury that consists of $k = 2h+1$ members, each of whom decide in favor of option A correctly with probability r and wrongly with probability w . The jury decides with absolute majority. For all $h \in \mathbb{N}^+$:

- a. $W_k(r, w) > W_1(r, w)$ if and only if $(r, w) \in C \cup C_{1,k}^T \cup C_{2,k}^T$.
- b. $W_{k+2}(r, w) > W_k(r, w)$ if $(r, w) \in C$ or $k < 2h^*(r, w) + 1$;
 $W_{k+2}(r, w) < W_k(r, w)$ if $(r, w) \notin C$ and $k > 2h^*(r, w) + 1$
- c. The limit of $W_k(r, w)$ for $k \rightarrow \infty$ depends on r, w , and T :
 - (i) if $(r, w) \in C$
then $\lim_{k \rightarrow \infty} W_k(r, w) > W_{\bar{k}}(r, w)$ for all $\bar{k} < \infty$;
 - (ii) if $1 - (1 - w)T > r \geq w > 1/2$ or $1/2 > r \geq w > r/T$
then $\lim_{k \rightarrow \infty} W_k(r, w) \in (W_1(r, w), W_{k^*}(r, w))$;
 - (iii) if $1/2 > r \geq \max(w, wT)$ or $1/2 < w \leq \min(r, 1 - (1 - r)/T)$
then $\lim_{k \rightarrow \infty} W_k(r, w) < W_{\bar{k}}(r, w)$ for all $\bar{k} < \infty$.

For better intuition of part c. of the theorem and its proof, we mark the three cases in figure 7 for $T \leq 1$. One should note that case (ii), i.e. $\lim_{k \rightarrow \infty} W_k(r, w) \in (W_1(r, w), W_{k^*}(r, w))$ occurs only for $r \geq w > 1/2$ (for $1/2 > r \geq w$) if $T < 1$ (if $T > 1$) and not at all if $T = 1$, since at least one of the inequalities defining this case is violated in each case.

Proof: Part a. replicates Lemma 5. Part b. is a restatement of Corollary 1.

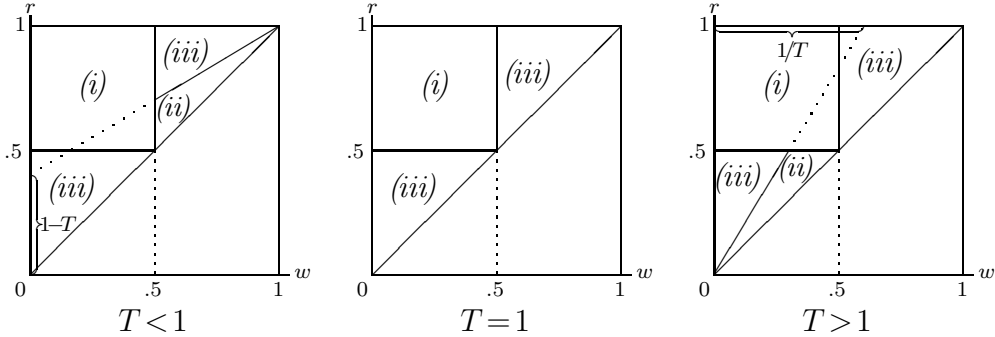

Figure 7: Three cases of part c. of Theorem 2 for $T \leq 1$ (only solid lines separate areas).

To prove Part c. we first note that the jury of infinite size hands down perfect decisions if $(r, w) \in C$ (case (i)) because then $\lim_{k \rightarrow \infty} Q_k(r) = 1$ and $\lim_{k \rightarrow \infty} Q_k(w) = 0$. For $r \geq w > 1/2$ and $1/2 > r \geq w$ we note that due to the convergence properties of $\hat{r}_k(w)$ and $\hat{w}_k(r)$ the set $C_{1,k}^T$ (Lemma 5) converges to the empty set for $k \rightarrow \infty$ and $C_{2,k}^T$ converges to the set defined by the conditions of case (ii). Hence $\lim_{k \rightarrow \infty} W_k(r, w) > W_1(r, w)$ in case (ii) and $\lim_{k \rightarrow \infty} W_k(r, w) < W_1(r, w)$ in case (iii). Quasi-uniqueness of k^* implies $\lim_{k \rightarrow \infty} W_k(r, w) < W_{\bar{k}}(r, w)$ for all $\bar{k} \geq k^*$ and $W_1(r, w) < W_{\bar{k}}(r, w) < W_{k^*}(r, w)$ for all $\bar{k} \in (1, k^*)$. Hence in case (ii) we have $W_1(r, w) < \lim_{k \rightarrow \infty} W_k(r, w) < W_{k^*}(r, w)$ and in case (iii) we have $\lim_{k \rightarrow \infty} W_k(r, w) < W_1(r, w) < W_{\bar{k}}(r, w)$.

If we compare Theorem 2 to Theorem 1 it becomes obvious that the results of the Condorcet Jury Theorem carry over to all cases in which no error probability is larger than one half and at least one of them differs from both zero and one half ($(r, w) \in C$). However, if one probability of error is larger than one half, none of the claims of the Condorcet Jury Theorem is valid any more: juries need not render better decisions than individuals, increasing the jury size reduces the decision quality if the jury becomes large enough since the optimal jury size is finite. Even worse, for most combinations of error probabilities, the decisions of a jury of infinite size are worse than the decisions of any smaller jury.

5 Solution of complete decision problem

In the previous two sections, we have compared the “blind” decision to the decision of one expert and the decisions of juries of various sizes. What is still open is the comparison of the decisions of a jury larger than one member and the “blind” decision based solely on the priors. We first compare the jury of a given size to the blind decision and then contrast the decisions of juries of optimal size to the “blind” decision. To abbreviate, we write $W_o \equiv \max(0, \pi G + (1 - \pi)L)$ for the expected payoff of the optimal “blind” decision.

For juries of a given size, we start with the most simple case: $T = 1$. Then the “blind” decision yields an expected payoff of zero (independently of whether A or B is chosen). The decision of a jury of uninformed experts ($r = w$) induces the same expected payoff due to

$$W_k(r, r) = Q_k(r)\pi G + Q_k(r)(1 - \pi)L = Q_k(r)(\pi G + (1 - \pi)L) = 0. \quad (12)$$

Since $\frac{\partial W_k(r, w)}{\partial r} > 0$ (Lemma 2, part 3), $W_k(r, w) > W_o = 0$ for all $r > w$.

For $T < 1$, the optimal “blind” decision is A and thus $W_o = \pi G + (1 - \pi)L > 0$. The expected payoff from a decision of a jury of uninformed experts ($r = w$) is smaller than the payoff from the optimal “blind” decision, except for the limiting case of $r = w = 1$, when the jury “blindly” decides for A :

$$W_k(r, r) = Q_k(r)\pi G + Q_k(r)(1 - \pi)L = Q_k(r)(\pi G + (1 - \pi)L) \leq \pi G + (1 - \pi)L$$

with equality only for $r = 1$. On the other hand, with $r = 1 > w$ a jury induces a higher expected payoff than the “blind” decision:

$$W_k(1, w) = Q_k(1)\pi G + Q_k(w)(1 - \pi)L = \pi G + Q_k(w)(1 - \pi)L > \pi G + (1 - \pi)L$$

due to $L < 0$. Hence, $\frac{\partial W_k(r, w)}{\partial r} > 0$ (again Lemma 2, part 3) implies that there is a unique function $r_k^o(w)$, well defined for all $w \in [0, 1)$, for which the following holds true:

$$W_k(r_k^o(w), w) \stackrel{\cong}{\leq} W_o \Leftrightarrow r \stackrel{\cong}{\leq} r_k^o(w)$$

By symmetry, we can define a corresponding function $w_T^o(r)$ for $T > 1$:

$$W_k(r, w_T^o(r)) \stackrel{\cong}{\leq} W_o \Leftrightarrow w \stackrel{\cong}{\leq} w_T^o(r)$$



Figure 8: Properties of $r_k^o(w)$.

Obviously, $r_k^o(w) = 1 - T + wT$ and $w_k^o(r) = r/T$.

These functions have a number of interesting properties:

Lemma 6 $\frac{dr_k^o(w)}{dw} > 0$, $r_k^o(0) \in (0, 1)$, $r_k^o(0) \leq 1/2 \Leftrightarrow T \geq 1/2$, $\lim_{w \rightarrow 1} r_k^o(w) = 1$, $r_k^o(w) < \min(1 - T + wT, r_k^*(w))$ for $w \in (1/2, 1)$, $\lim_{k \rightarrow \infty} r_k^o(w) = 1/2$ for $w \in [0, 1/2]$ and $\lim_{k \rightarrow \infty} r_k^o(w) = w$ for $w \in (1/2, 1)$.

$\frac{dw_k^o(r)}{dr} > 0$, $w_k^o(1) \in (0, 1)$, $w_k^o(1) \leq 1/2 \Leftrightarrow T \geq 2$, $\lim_{r \rightarrow 0} w_k^o(r) = 0$, $w_k^o(r) > \max(r/T, w_k^*(r))$ for $r \in (0, 1/2)$, $\lim_{k \rightarrow \infty} w_k^o(r) = 1/2$ for $r \in [1/2, 1]$ and $\lim_{k \rightarrow \infty} w_k^o(r) = r$ for $r \in (0, 1/2)$.

The proof is given in Appendix I. Figure 8 shows $r_k^o(w)$ for $T = 0.4$ and for $T = 0.7$ and $k \in \{1, 3, 5, 39\}$. For better reference, the figure also shows $r_k^*(w)$. The graphs for $T > 1$ are symmetric. The properties of $r_k^o(w)$ become clear in the figure: The function increases in w , starts from some value in the interval $(0, 1/2)$ if $T > 1/2$ and from some value in the interval $(1/2, 1)$ if $T < 1/2$, and eventually approaches one as w grows towards one. For $w > 1/2$, the value of $r_k^o(w)$ is strictly below both the line delimiting the range for which the “blind” decision is better than the individual expert’s decision ($1 - T + wT$) and the curve above which k is the optimal jury size ($r_{k+2}^*(w)$).

The lemma has two important implications:

Corollary 3 *The decision of an optimally-sized jury may only be worse than*

the “blind” decision, if its bias is in the opposite direction of the payoff-weighted priors (i.e. if $1/2 > r > w$ despite $T < 1$ or $r > w > 1/2$ despite $T > 1$) or it consists of ignorant experts ($r = w$).

If $k \rightarrow \infty$ the jury decision is worse than the “blind” decision, if its bias is in the opposite direction of the payoff-weighted priors or it consists of ignorant experts ($r = w$). Otherwise, its decisions are better than the “blind” decision.

With this background, it is easy to compare the decision of juries of optimal size to the “blind” decision:

Theorem 3 (Extension to Generalized Condorcet Jury Theorem)
 $W_{k^*(r,w)}(r, w) \geq W_o \Leftrightarrow \left(T < 1 \wedge r \geq \min_k(r_k^o(w)) \right) \vee \left(T > 1 \wedge w \leq \max_k(w_k^o(r)) \right)$

In words, the “blind” decision is better than the decision of a jury of optimal size if and only if either the jury consists of ignorant members ($r = w$) or its bias is so much in the opposite direction of the payoff-weighted priors that r is smaller than the lower hull of all $r_k^o(w)$ (for $T < 1$) or w is larger than the upper hull of all $w_k^o(r)$. The careful reader will realize that for $T \notin (1/2, 2)$, this is the case whenever the jury’s bias is in the opposite direction of the payoff-weighted priors ($1/2 > r \geq w$ and $T < 1$ or $r \geq w > 1/2$ and $T > 1$). Otherwise the “blind” decision is worse than the decision of a jury of optimal size. If $T = 1$, the “blind” decision is better than the decision of a jury of optimal size only if the jury members are completely uninformed ($r = w$). Figure 9 adds the insights of Theorem 3 to Figure 4: In the area labeled “ \mathcal{O} ” the blind decision is better than the decision of a jury of optimal size.

6 Results and discussion

Judges and juries have to make binary decisions and, therefore, may commit two types of errors, the probabilities of which are independent of each other. This fact is not taken into account in the original Condorcet Jury Theorem nor in the ensuing literature. Acknowledging this independence, however, makes a more complex definition of “decision quality” inevitable. We have introduced an expected payoff measure based on the benefits and costs of

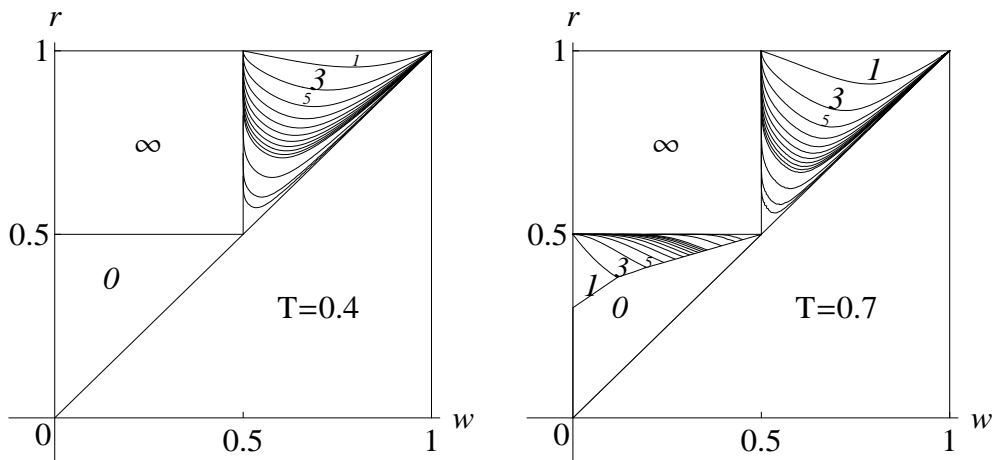

Figure 9: Optimal jury size: areas of combinations of r and w for which the optimal size is 1, 3, 5 or infinity are marked by italicized numbers; the borders $r_k^*(w)$ of these areas are drawn for all $k \leq 21$ and for $k \in \{41, 101, 201\}$. The area of combinations of r and w for which it is best to rely on the optimal “blind” decision is marked by “ O ”.

selecting one alternative rather than the other. This allowed us to compare the qualities of decisions based on prior information (“blind” decisions), on the information of one expert, and on the majority vote of a number of alike experts. This comparison entails a generalized version of the Condorcet Jury Theorem for probabilities of error not adding up to one. In addition, we derived an extension which adds the comparison with the “blind” decision to the Generalized Condorcet Jury Theorem.

The Generalized Condorcet Jury Theorem implies that none of the three claims of the original Condorcet Jury Theorem holds true for all juries of equally informed experts. Even if the jury members are all informed (each of them is more likely to vote for an alternative if it is the better choice than if it is the worse choice) a jury of more than one member not necessarily decides better than an individual expert (a jury of size one), larger juries are not necessarily better than smaller juries, and the optimal jury size may be finite. Our extension implies that even decisions of juries of the optimal size need not be better than “blind” decisions, i.e. decisions based solely on the prior probabilities of the states of the world.

Just as the original CJT, the generalized theorem works with rather

strict assumptions. Some of them (homogeneous jury members, independent decision-making) have been dealt with in the literature on the original CJT. We conjecture that the insights of this branch of literature transfers – *mutatis mutandis* – to our setting. Nevertheless, further research will be valuable in combining the variations dealt with in that literature with our extension.

Biased information of jury members as we allow for may open the possibility of juries to improve their decision quality by giving up some of their information. Two ways to do so suggest themselves. One would be to ignore the votes of some jury members if a jury is too large. The other would be that each member neglects his information with some positive probability and simply votes for one predetermined alternative. That this latter neglect of information may improve the decision becomes obvious if one considers a jury of large finite size with r and w such that the optimal jury size would be one and the jury’s decision is worse than the “blind” decision.¹⁷ If the jury members with these probabilities gave up some of their information by sometimes blindly voting for A , they could reach any combination of r and w which is on the straight line between their original r - w -combination and the point $r = w = 1$. Obviously some of these r - w -combinations induce jury decisions which are better than the “blind” decision. Details of the conditions under which such improving decision quality by neglecting information have to be left for further research.

References

- Ben-Yasar, Ruth/Nitzan, Shmuel I. 1997:** The Optimal Decision Rule for Fixed-Size Committees in Dichotomous Choice Situations: The General Result. In: *International Economic Review* 38, 175-186.
- Berend, Daniel/Sapir, Luba 2007:** Monotonicity in Condorcets Jury Theorem with dependent voters. *Social Choice and Welfare* 28(3), 507-528.
- Berend, Daniel/Paroush, Jacob 1998:** When is Condorcet’s Jury Theorem valid? In: *Social Choice and Welfare* 15(4), 481-488.

¹⁷In Figure 8 one could consider a jury of 39 members with $T = 0.7$, a sufficiently small value of w , and a value of r such that $r \in (1 - T + wT, r_{39}^o(w))$.

- Berg, Sven 1993:** Condorcet's Jury Theorem, Dependency Among Voters. In: *Social Choice and Welfare* 10, 87-96.
- Berg, Sven 1996:** Condorcet's Jury Theorem and the Reliability of Majority Voting. In: *Group Decisions and Negotiation* 5, 229-238.
- Berg, Sven/Marañón, Antonio 2001:** Collective Decisional Skills and Decisive Voting Games - Some Results. In: *Group Decision and Negotiation* 10(5), 389-403.
- Boland, Philip J. 1989:** Majority Systems and the Condorcet Jury Theorem. In: *The Statistician* 38(3), 181-189.
- Congleton, Roger D. 2005:** Informational Limits to Democratic Public Policy: The Jury Theorem and Rational Ignorance; Working Paper, Fairfax/VA.
- Crépel, Pierre/Rieucau, Jean-Nicolas 2005:** Condorcet's Social Mathematics, A Few Tables. In: *Social Choice and Welfare* 25(2-3), 243-285.
- Feddersen, Timothy/Pesendorfer, Wolfgang 1998:** Convicting the Innocent: The Inferiority of Unanimous Jury Verdicts under Strategic Voting. In: *American Political Science Review* 92 (1), 23-35.
- Gelfand, Alan E./Solomon, H. 1973:** A Study of Poisson's Model for Jury Verdicts in Criminal and Civil Trials. In: *Journal of the American Statistical Association* 68 (342), 271-278.
- Heiner, R.A. 1983:** The Origin of Predictable Behavior. In: *American Economic Review* 73, 560-595.
- Karotkin, Drora 1994:** Effect of the Size of the Bench on the Correctness of Court Judgements: The Case of Israel. In: *International Review of Law and Economics* 14, 371-375.
- Karotkin, Drora/Paroush 2003:** Optimum Committee Size: Quality-versus-Quantity Dilemma. In: *Social Choice and Welfare* 20(3), 429-441.
- Kirstein, R./Schmidtchen, D. 1997:** Judicial Detection Skill and Contractual Compliance. In: *International Review of Law and Economics* 17 (4), 509-520.
- Klausner, Amir/Pollak, Moshe 2001:** Comparative Reliability of Verdicts. In: *Management Science* 47(7), 931-948.
- Koh, Winston T.H. 2005:** Optimal Sequential Decision Architectures and the Robustness of Hierarchies and Polyarchies. In: *Social Choice and Welfare* 24(3), 397-411.

- Koriyama, V./Szentes, B. 2009:** A Resurrection of the Condorcet Jury Theorem. In: *Theoretical Economics* 4, 227-252.
- Analyze (finite) optimal size of a jury (without conflicting interest, when information is costly). Members simultaneously decide whether to acquire inf. A bit trivial that, with pos. inf cost, the optimal k is not infinite.
- Ladha, Krishna K. 1992:** The Condorcet Jury Theorem, Free Speech, and Correlated Votes. In: *American Journal of Political Science* 36 (3), 617-634.
- Ladha, Krishna K. 1995:** Information Pooling Through Majority-Rule Voting. In: *Journal of Economic Behavior and Organization* 26, 353-372.
- List, Christian/Goodin, Robert E. 2001:** Epistemic Democracy: Generalizing the Condorcet Jury Theorem. In: *The Journal of Political Philosophy* 9(3), 277-306.
- Mood, Alexander M./Graybill, Franklin A./Boes, Duane C. 1950:** Introduction to the Theory of Statistics. Tokyo, McGraw-Hill.
- Mueller, Dennis C. 2001:** Centralism, Federalism, and the Nature of Individual Preferences. In: *Constitutional Political Economy* 12 (2), 161-172.
- Nitzan, Shmuel I./Paroush, Jacob 1984:** Are Qualified Majority Rules Special? In: *Public Choice* 42, 257-272.
- Paroush, Jacob 1998:** Stay Away From Fair Coins: A Condorcet Jury Theorem. In: *Social Choice and Welfare* 15(1), 15-20.
- Rothschild, Emma:** "Axiom, theorem corollary & c.": Condorcet and Mathematical Economics. In: *Social Choice and Welfare* 25(2-3), 287-302.
- Schofield, Norman 2002:** Representative Democracy as Social Choice. In: Arrow, K.J./Sen, A.K./Suzumura, K. (eds.): *Handbook of Social Choice and Welfare*, vol. 1, ch. 9, Elsevier, 425-455.
- Schofield, Norman 2005:** The intellectual contribution of Condorcet to the founding of the US Republic 1785 to 1800. In: *Social Choice and Welfare* 25 (2-3), 303-318.
- Surowiecki, James 2004:** *The Wisdom of Crowds. Why the Many Are Smarter than the Few.* Reprint 2005, Abacus, London.
- Swets, J.A. 1988:** Measuring the Accuracy of Diagnostic Systems. In: *Science* 240, 1285-1293.
- Tullock, G. 1994:** Court Errors; in: *European Journal of Law and Economics* 1, 9-21.

Young 1988: Condorcet's theory of voting. American Political Science Review, 82 (4), 1231-44.

A Proof of Lemma 1

Parts 1 and 2 are obvious. A simple proof of part 3 is to differentiate all $Q(j, q)$ -terms yielding

$$\frac{dQ(j, q)}{dq} = k \binom{k-1}{j-1} q^{j-1} (1-q)^{k-j} - k \binom{k-1}{j} q^j (1-q)^{k-j-1} \text{ for } j < k \text{ and}$$

$$\frac{dQ(k, q)}{dq} = k \binom{k-1}{k-1} q^{k-1} = kq^{k-1}$$

and sum these terms up to get

$$\begin{aligned} \frac{dQ_k(q)}{dq} &= k \left(q^{k-1} + \sum_{j=h+1}^{k-1} \binom{k-1}{j-1} q^{j-1} (1-q)^{k-j} - \sum_{j=h+1}^{k-1} \binom{k-1}{j} q^j (1-q)^{k-j-1} \right) \\ &= k \left(\sum_{j=h+1}^k \binom{k-1}{j-1} q^{j-1} (1-q)^{k-j} - \sum_{j=h+2}^k \binom{k-1}{j-1} q^{j-1} (1-q)^{k-j} \right) \\ &= k \binom{2h}{h} q^h (1-q)^h \end{aligned}$$

For an alternative proof of part 3 see e.g. Boland (1989) referring to Mood (1950: 253).

Part 4 follows immediately from part 3, with s-shapedness following from

$$\frac{d^2 Q_k(q)}{dq^2} \begin{matrix} \geq \\ \leq \end{matrix} 0 \quad \Leftrightarrow \quad q \begin{matrix} \leq \\ \geq \end{matrix} 1/2.$$

To prove part 5, we can either simply refer to Condorcet (1785: 5) or present a similar, but perhaps slightly more comprehensible proof: We first rewrite $Q_k(q) = qQ_k(q) + (1-q)Q_k(q)$, shift the index of the first sum,

re-arrange terms and make use of the fact that $\binom{a}{b} + \binom{a}{b-1} = \binom{a+1}{b}$ to get:

$$\begin{aligned}
Q_k(q) &= q \sum_{j=h+1}^{2h+1} \binom{2h+1}{j} q^j (1-q)^{2h+1-j} + (1-q) \sum_{j=h+1}^{2h+1} \binom{2h+1}{j} q^j (1-q)^{2h+1-j} \\
&= \sum_{j=h+1}^{2h+1} \binom{2h+1}{j} q^{j+1} (1-q)^{2h+1-j} + \sum_{j=h+1}^{2h+1} \binom{2h+1}{j} q^j (1-q)^{2h+2-j} \quad (13)
\end{aligned}$$

$$= \sum_{j=h+2}^{2h+2} \binom{2h+1}{j-1} q^j (1-q)^{2h+2-j} + \sum_{j=h+1}^{2h+1} \binom{2h+1}{j} q^j (1-q)^{2h+2-j} \quad (14)$$

$$\begin{aligned}
&= \sum_{j=h+2}^{2h+1} \left[\binom{2h+1}{j-1} + \binom{2h+1}{j} \right] q^j (1-q)^{2h+2-j} \\
&\quad + \binom{2h+1}{2h+1} q^{2h+2} (1-q)^0 + \binom{2h+1}{h+1} q^{h+1} (1-q)^{h+1} \quad (15)
\end{aligned}$$

$$\begin{aligned}
&= \sum_{j=h+2}^{2h+1} \binom{2h+2}{j} q^j (1-q)^{2h+2-j} \\
&\quad + \binom{2h+2}{2h+2} q^{2h+2} (1-q)^0 + \binom{2h+1}{h+1} q^{h+1} (1-q)^{h+1} \quad (16)
\end{aligned}$$

$$= \sum_{j=h+2}^{2h+2} \binom{2h+2}{j} q^j (1-q)^{2h+2-j} + \binom{2h+1}{h+1} q^{h+1} (1-q)^{h+1} \quad (17)$$

We proceed in the same manner with the sum in equation (17), which yields:

$$Q_k(q) = \sum_{j=h+3}^{2h+3} \binom{2h+2}{j-1} q^j (1-q)^{2h+3-j} + \sum_{j=h+2}^{2h+2} \binom{2h+2}{j} q^j (1-q)^{2h+3-j} + \binom{2h+1}{h+1} q^{h+1} (1-q)^{h+1} \quad (18)$$

$$= \sum_{j=h+3}^{2h+2} \left[\binom{2h+2}{j-1} + \binom{2h+2}{j} \right] q^j (1-q)^{2h+3-j} + \binom{2h+2}{2h+2} q^{2h+3} (1-q)^0 + \binom{2h+2}{h+2} q^{h+2} (1-q)^{h+1} + \binom{2h+1}{h+1} q^{h+1} (1-q)^{h+1} \quad (19)$$

$$= \sum_{j=h+3}^{2h+3} \binom{2h+3}{j} q^j (1-q)^{2h+3-j} + \binom{2h+2}{h+2} q^{h+2} (1-q)^{h+1} + \binom{2h+1}{h+1} q^{h+1} (1-q)^{h+1} \quad (20)$$

$$= Q_{k+2}(q) - \binom{2h+3}{h+2} q^{h+2} (1-q)^{h+1} + \binom{2h+2}{h+2} q^{h+2} (1-q)^{h+1} + \binom{2h+1}{h+1} q^{h+1} (1-q)^{h+1} \quad (21)$$

$$= Q_{k+2}(q) - \left[\binom{2h+2}{h+1} q^{h+2} (1-q)^{h+1} - \binom{2h+1}{h+1} q^{h+1} (1-q)^{h+1} \right]$$

$$= Q_{k+2}(q) - \left[\frac{2h+2}{h+1} q - 1 \right] \binom{2h+1}{h+1} q^{h+1} (1-q)^{h+1}$$

$$= Q_{k+2}(q) - [2q - 1] \binom{2h+1}{h} q^{h+1} (1-q)^{h+1} \quad (22)$$

Hence,

$$\Delta_{k+2}(q) = Q_{k+2}(q) - Q_k(q) = [2q - 1] \binom{2h+1}{h} q^{h+1} (1-q)^{h+1} \quad (23)$$

(Condorcet, 1785: 5). Obviously, $\Delta_{k+2}(q) > 0$ for all $1/2 < p < 1$ and all $k = 2h + 1$, which completes the proof of part 5.

Part 6 makes use of the fact that $\binom{k+2}{h+1} = \frac{(2h+2)(k+2)}{(h+1)(h+2)} \binom{k}{h} = \frac{4(h+1)(k+2)}{(h+1)2(h+2)} \binom{k}{h} = 4 \frac{k+2}{k+3} \binom{k}{h}$. In addition, $(4q(1-q) \frac{k+2}{k+3} - 1) < 0$ due to $q(1-q) \leq \frac{1}{4}$ and $\frac{k+2}{k+3} < 1$, which completes the proof.

B Proof of Part c. of Theorem 1

The proof of Part c. follows Condorcet (1785: 8-9): We first expand the recursive definition of $Q_k(q)$ from as equation (23) as a sum and then make use of the Taylor expansion of $(1 - 4q(1 - q))^{-1/2}$ to eliminate the summation term, which allows us to determine $\lim_{k \rightarrow \infty} Q_k(q)$.

From equation (23) we get

$$Q_{2h+1}(q) = q + \sum_{\ell=0}^{h-1} \Delta_{2\ell+3}(q) = q + [2q - 1] \sum_{\ell=0}^{h-1} \binom{2\ell+1}{\ell} q^{\ell+1} (1-q)^{\ell+1} \quad (24)$$

for $h \geq 1$. Hence

$$\lim_{k \rightarrow \infty} Q_k(q) = q + [2q - 1] \sum_{\ell=0}^{\infty} \binom{2\ell+1}{\ell} q^{\ell+1} (1-q)^{\ell+1} \quad (25)$$

Consider the following transformation of the Taylor expansion of $f(z) = (1 - 4z)^{-1/2}$:

$$\begin{aligned} (-1 + f(z))/2 &= \frac{1}{2} \left(-1 + f(0) + f'(0) \frac{z}{1!} + f''(0) \frac{z^2}{2!} + f'''(0) \frac{z^3}{3!} + \dots \right) \\ &= \frac{1}{2} \left(-1 + 1 + \frac{2!}{1!1!} z + \frac{4!}{2!2!} z^2 + \frac{6!}{3!3!} z^3 + \dots \right) \\ &= \frac{1}{2} \left(\sum_{\ell=1}^{\infty} \frac{(2\ell)!}{\ell!\ell!} z^{\ell} \right) = \frac{1}{2} \left(\sum_{\ell=0}^{\infty} \frac{(2(\ell+1))!}{(\ell+1)!(\ell+1)!} z^{\ell+1} \right) \\ &= \frac{1}{2} \left(\sum_{\ell=0}^{\infty} \frac{(2\ell+1)!2(\ell+1)}{(\ell+1)!(\ell+1)!} z^{\ell+1} \right) = \sum_{\ell=0}^{\infty} \binom{2\ell+1}{\ell} z^{\ell+1} \quad (26) \end{aligned}$$

Note that if we replace $z = q(1 - q)$, the last term in equation (26) is the same as the last term in equation (25). We can thus rewrite the latter as:

$$\begin{aligned} \lim_{k \rightarrow \infty} Q_k(q) &= q + [2q - 1] \frac{1}{2} \left(-1 + (1 - 4q(1 - q))^{-1/2} \right) \\ &= q - q + \frac{1}{2} + \frac{1}{2} \frac{2q - 1}{\sqrt{1 - 4q + 4q^2}} = 1, \end{aligned}$$

which completes the proof.

C Proof of Lemma 2

Part 1 is obvious when we insert part a. of Theorem 1 into equation (4). Parts 2 through 4 may easily be derived in a similar way from parts 2 through 4 of Lemma 1 and equation (4).

To prove part 5 we note that

$$\begin{aligned}
\Psi_{k+2}(r, w) &\equiv W_{k+2}(r, w) - W_k(r, w) \\
&= Q_{k+2}(r)\pi G + Q_{k+2}(w)(1 - \pi)L - (Q_k(r)\pi G + Q_k(w)(1 - \pi)L) \\
&= [Q_{k+2}(r) - Q_k(r)]\pi G + [Q_{k+2}(w) - Q_k(w)](1 - \pi)L \\
&= \binom{k}{h} \left[(2r - 1) r^{h+1} (1 - r)^{h+1} \pi G + (2w - 1) w^{h+1} (1 - w)^{h+1} (1 - \pi)L \right],
\end{aligned}$$

where the last equality makes use of part 5 of Lemma 1. For $(r, w) \in C$, the two terms in brackets in the last line are non-negative due to $L < 0$ and at least one of them is strictly positive.

For $r > w > 1/2$, we rewrite

$$\begin{aligned}
\Psi_{k+2}(r, w) &= \binom{k}{h} w^{h+1} (1 - w)^{h+1} \left[(2r - 1) \left(\frac{r(1 - r)}{w(1 - w)} \right)^{h+1} \pi G + (2w - 1) (1 - \pi)L \right],
\end{aligned}$$

which for $h \rightarrow \infty$ is negative as all terms outside the brackets are positive, the fraction inside the brackets is smaller than one and thus the entire term in brackets reduces to $(2w - 1) (1 - \pi)L < 0$.

For $1/2 > r > w$, we rewrite

$$\begin{aligned}
\Psi_{k+2}(r, w) &= \binom{k}{h} r^{h+1} (1 - r)^{h+1} \left[(2r - 1) \pi G + (2w - 1) \left[\frac{w(1 - w)}{r(1 - r)} \right]^{h+1} (1 - \pi)L \right],
\end{aligned}$$

which for $h \rightarrow \infty$ is negative as all terms outside the brackets are positive, the fraction inside the brackets is smaller than one and thus the entire term in brackets reduces to $(2r - 1) \pi G < 0$.

To prove part 6 we make use of part 6 of Lemma 1 and equation (4) to get:

$$\begin{aligned}
\Psi_{k+2}^2(r, w) &= (2r - 1) (r(1 - r))^{h+2} \pi G \left[4 \frac{k+2}{k+3} - \frac{1}{r(1 - r)} \right] \\
&\quad + (2w - 1) (w(1 - w))^{h+2} (1 - \pi)L \left[4 \frac{k+2}{k+3} - \frac{1}{w(1 - w)} \right], \quad (27)
\end{aligned}$$

of which the first term is negative for $r \in (1/2, 1)$ and the second for $w \in (0, 1/2)$ since both terms in brackets are negative due to $4 \frac{k+2}{k+3} < 4 < \frac{1}{q(1-q)}$

for $q \in \{r, w\}$ and their respective co-factors are both positive. For $r \in \{1/2, 1\}$ and for $w \in \{0, 1/2\}$ the respective terms are zero. Hence, for $0 \leq w \leq 1/2 \leq r \leq 1$ we have $\Psi_{k+2}^2(r, w) \leq 0$ with equality only for $(r, w) \in \{1/2, 1\} \times \{0, 1/2\}$.

For $r > w > 1/2$ and for $1/2 > r > w$ we note that by the proof of part 5 of this lemma $\Psi_{k+4}(r, w) > 0$ implies:

$$(2w - 1)(w(1 - w))^{h+2}(1 - \pi)L \geq -(2r - 1)(r(1 - r))^{h+2}\pi G$$

Recalling that in equation (27) the terms in brackets are negative, this yields:

$$\begin{aligned} \Psi_{k+2}^2(r, w) &\leq (2r - 1)(r(1 - r))^{h+2}\pi G \left[4\frac{k+2}{k+3} - \frac{1}{r(1-r)} \right] \\ &\quad - (2r - 1)(r(1 - r))^{h+2}\pi G \left[4\frac{k+2}{k+3} - \frac{1}{w(1-w)} \right] \\ &= (2r - 1)(r(1 - r))^{h+2}\pi G \left[\frac{1}{w(1-w)} - \frac{1}{r(1-r)} \right] \\ &= (2r - 1)\frac{(r(1 - r))^{h+1}}{w(1-w)}\pi G [r(1 - r) - w(1 - w)] \quad (28) \end{aligned}$$

For $r > w > 1/2$ the last factor in line (28) is negative and the other factors are positive, while for $1/2 > r > w$ first factor is negative and the other factors are positive. Hence, the entire term in line (28) is negative in both cases which implies $\Psi_{k+2}^2(r, w) < 0$ and thus completes the proof.

D Proof of the definition of k^* in Corollary 1

$\Psi_k(r, w) \geq 0$ implies

$$(2w - 1)(w(1 - w))^h(1 - \pi)L \geq -(2r - 1)(r(1 - r))^h\pi G$$

which may be rewritten as:

$$\frac{(2w - 1)}{(2r - 1)}T \leq \left(\frac{r(1 - r)}{w(1 - w)} \right)^h$$

with a reversed greater sign for $1/2 > r > w$. We note that the left-hand side is positive both for $r > w > 1/2$ and for $1/2 > r > w$. Taking logarithms yields

$$\ln \left[\frac{(2w - 1)}{(2r - 1)}T \right] \leq h \ln \left[\frac{r(1 - r)}{w(1 - w)} \right]$$

again with a reversed greater sign for $1/2 > r > w$. Dividing by the logarithm on the right-hand side entails

$$h \leq \ln \left[\frac{(2w-1)}{(2r-1)} T \right] / \ln \left[\frac{r(1-r)}{w(1-w)} \right] \quad (29)$$

both for $r > w > 1/2$ and for $1/2 > r > w$, since $\ln \left[\frac{r(1-r)}{w(1-w)} \right]$ is negative (positive) for $r > w > 1/2$ (for $1/2 > r > w$). Due to parts 5 and 6 of Lemma 2 h maximizes the expected payoffs when it is the largest h which satisfies equation (29). Hence:

$$h^*(r, w) = \max \left\{ 0, \left\lfloor \ln \left[\frac{(2w-1)}{(2r-1)} T \right] / \ln \left[\frac{r(1-r)}{w(1-w)} \right] \right\rfloor \right\}, \quad (30)$$

where $\lfloor x \rfloor$ is the largest integer smaller than x . Note that if the fraction of logarithms happens to be an integer h^+ , then $\Psi_{2h^+1}(r, w) = 0$, i.e. $W_{2h^+-1}(r, w) = W_{2h^++1}(r, w) > W_k(r, w)$ for all $k \notin \{2h^+ - 1, 2h^+ + 1\}$. Our definition of $\lfloor x \rfloor$ selects the smaller of such two equally good jury sizes.

Also note that the max operator accounts for the restriction of jury sizes to the positive odd natural numbers.

E Proof of Lemma 3

To prove the properties of $r_k^*(w)$ consider the function

$$g(x) \equiv (2x-1)(x(1-x))^{h+1},$$

which is equal to the left-hand side of equation (6) if $x = r$ and equal to the right-hand side of equation (6) divided by T if $x = w$. It is easy to see that $g(x)$ has the following properties (cf. Figure 10):

$$g(0) = g(1/2) = g(1) = 0 \quad (31)$$

$$g(x) < 0 \quad \forall x \in (0, 1/2); \quad g(x) > 0 \quad \forall x \in (1/2, 1) \quad (32)$$

$$g'(x) \equiv \frac{dg(x)}{dx} = -(x(1-x))^h [2(3+2h)x^2 - 2(3+2h)x + (h+1)] \quad (33)$$

$$g'(x) = 0 \text{ if } x = x_{\min} \equiv \frac{1}{2} - \sqrt{\frac{1}{2(3+2h)}} \text{ or } x = x_{\max} \equiv \frac{1}{2} + \sqrt{\frac{1}{2(3+2h)}} \quad (34)$$

$$g'(x) > 0 \text{ if } x \in (x_{\min}, x_{\max}); \quad g'(x) < 0 \text{ if } x \in (0, x_{\min}) \cup (x_{\max}, 1) \quad (35)$$

$$g_{\text{extr}} \equiv g(x_{\max}) = -g(x_{\min}) = \sqrt{\frac{1}{2(3+2h)}} \left(\frac{h+1}{2(3+2h)} \right)^{h+1} \quad (36)$$

For the moment, we assume $T < 1$. To prove existence and uniqueness of $r_k^*(w)$ for $w \in (0, 1)$, we first note that $g(x) = y$ has two solutions $x_s(y) \in [0, 1)$ for all $y \in (-g_{\text{extr}}, g_{\text{extr}})$. $T < 1$ implies $|Tg(w)| < g_{\text{extr}}$ and there

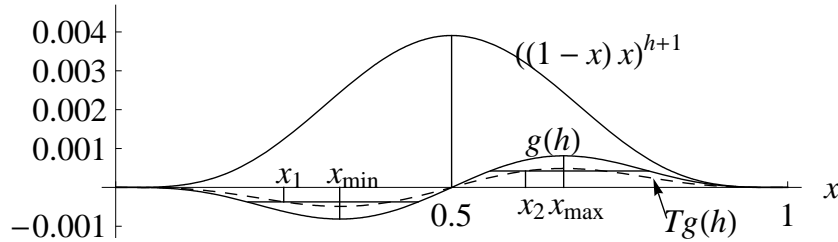

Figure 10: Properties of the function $g(x)$. x_1 and x_2 are arbitrary.

are thus also two solutions in r to $g(r) = Tg(w)$. Because for $r = w \in (0, 1) \setminus \{1/2\}$ we have $|g(r) - Tg(w)| > 0$, one of these solutions is smaller than w and the other is larger (see x_1 and x_2 as examples in Figure 10). Hence, for $w \in (0, 1) \setminus \{1/2\}$, $r_k^*(w) \in (0, 1)$ exists and is unique. We note that for $w \in (0, 1/2)$ we have $r_k^*(w) \in (x_{\min}, 1/2)$ and for $w \in (1/2, 1)$ we have $r_k^*(w) \in (x_{\max}, 1)$. Since $Tg(1/2) = 0$ and due to properties (31) and (32), $r = 0$, $r = 1/2$ and $r = 1$ are the only solutions to $g(r) = Tg(1/2)$. The definition of $r_k^*(w)$ excludes $r = 0$ and $r = 1$ and thus $r_k^*(1/2) = 1/2$ exists and is unique.

Continuity for $w \neq 1/2$ and the discontinuity at $w = 1/2$ are obvious from the previous argument and Figure 10. Together with properties (31) and (32) this implies that $\lim_{w \rightarrow 0} r_k^*(w) = 1/2$ and $\lim_{w \rightarrow 1} r_k^*(w) = 1$. This completes the proof of parts *a.* and *b.*

To prove part *c.*, we first concentrate on $w \in (0, 1/2]$. We know that in this range $r_k^*(w)$ is continuous. By the Implicit Function Theorem and properties (34) and (35) of $g(x)$, $\frac{dr_k^*(w)}{dw} = T \frac{g'(w)}{g'(r_k^*(w))} = 0$ if and only if $w = x_{\min}$. Due to $r_k^*(w) \in (x_{\min}, 1/2)$, we know that $g'(r_k^*(w)) > 0$ for all $w \in (0, 1/2)$. Since $g'(w) < 0$ for $w < x_{\min}$ and $g'(w) > 0$ for $w > x_{\min}$, we also have $\frac{dr_k^*(w)}{dw} = T \frac{g'(w)}{g'(r_k^*(w))} < 0$ for $w < x_{\min}$ and $\frac{dr_k^*(w)}{dw} = T \frac{g'(w)}{g'(r_k^*(w))} > 0$ for $w > x_{\min}$ if $w \approx x_{\min}$. Hence, the extremum at $w = x_{\min}$ must be a minimum. Uniqueness of x_{\min} implies that this minimum is the unique interior extremum for $w \in (0, 1/2]$. The argument for $w \in (1/2, 1)$ runs accordingly, after noting that in this range $g'(w) \geq 0$ if and only if $w \leq x_{\max}$ and $g'(r_k^*(w)) < 0$ for all $r_k^*(w) \in (x_{\max}, 1/2)$.

For the proof of part *d.* we note that an increase in k entails an increase of both sides of equation (6), but the increase of the left-hand side is stronger (weaker) when $1/2 > r_k^*(w) > w$ (when $r_k^*(w) > w > 1/2$). Keeping w constant thus requires to reduce (increase) the left-hand side of equation (6). Due to $r_k^*(w) \in (x_{\min}, 1/2)$ if $1/2 > r_k^*(w) > w$ and $r_k^*(w) \in (x_{\max}, 1)$ if

$r_k^*(w) > w > 1/2$, the left-hand side of equation (6) increases (decreases) in $r_k^*(w)$ if $1/2 > r_k^*(w) > w$ (if $r_k^*(w) > w > 1/2$). Thus equation (6) may only remain satisfied after an increase in k , if $r_k^*(w)$ increases if $w \in (0, 1/2)$ and decreases if $w \in (1/2, 1)$, which completes the proof of the properties of $r_k^*(w)$.

The proof of the properties of $w_k^*(r)$ for $T > 1$ is symmetric and therefore omitted.

For $T = 1$, $g(r) = Tg(w)$ has always two solutions and $r = w$ is always one of them, except for $w = x_{\min}$ or $w = x_{\max}$, where the two solutions coincide on $r = w$. Again making use of the Implicit Function Theorem it is easy to see that the solution satisfying $r \neq w$ declines in w due to the fact that for $1/2 > w$ it satisfies either $r > x_{\min} > w$ or $r < x_{\min} < w$ and for $w > 1/2$ the same is true with x_{\max} replacing x_{\min} . Hence if $w \in (0, x_{\min})$ or $w \in (1/2, x_{\max})$, $r_k^*(w) > w$ declines in w ; if $w = x_{\min}$ or $w = x_{\max}$, $r_k^*(w)$ reaches its minimum; finally, if $w \in (x_{\min}, 1/2)$ or $w \in (x_{\max}, 1)$, $r_k^*(w) = w$ increases in w . The remainder of the argument follows the lines of the case $T < 1$.

F Proof of Lemma 4

Continuity follows from the fact that $\tilde{V}(r, w)$ is a difference of a polynomial in r and a polynomial in w . For $(r, w) \in C$ we know that $Q_k(r) - r \geq 0 \geq Q_k(w) - w$ with at least one strict inequality which implies that both terms in the definition of $V_k(r, w)$ (equation 7) are non-negative and at least one is strictly positive which proves $V_k(r, w) > 0$.

From part 3 of Lemma 2 we know that $\frac{dV_k(r, w)}{dr} = (k \binom{2h}{h} r^h (1-r)^h - 1) \pi G$ and $\frac{dV_k(r, w)}{dw} = (k \binom{2h}{h} w^h (1-w)^h - 1) (1-\pi)L$. Equating the two derivatives to zero and solving for r and w , respectively, yields the extrema at the levels of r and w given in the Lemma. From part 4 of Lemma 2 we get the second derivatives and immediately see that the extrema are maxima and minima as stated in the Lemma. To see that $K_k \in (0, 1/\sqrt{12}]$, one should first note that $K_3 = 1/\sqrt{12}$. We then make use of

Claim 1

$$(2h+1) \binom{2h}{h} = \prod_{i=1}^h \left(4 + \frac{2}{h}\right)$$

which we prove by induction: It is easy to see that for $h = 1$, both sides are equal to 6. Suppose that the Claim is true for $h - 1$. Then it is also true for h because:

$$\begin{aligned} (2h+1) \binom{2h}{h} &= \frac{(2h+1)2h}{h^2} (2(h-1)+1) \binom{2(h-1)}{h-1} \\ &= \left(4 + \frac{2}{h}\right) \prod_{i=1}^{h-1} \left(4 + \frac{2}{h-1}\right) = \prod_{i=1}^h \left(4 + \frac{2}{h}\right) \end{aligned}$$

The term $k \binom{2h}{h}$ is therefore the a product of h factors, and $[k \binom{2h}{h}]^{1/h}$ is their geometric mean. Increasing h by 1 adds another factor which is smaller than all previous factors and thus lowers the geometric mean. As a consequence, K_k declines in h and $k = 2h + 1$. When h grows towards infinity, $[k \binom{2h}{h}]^{1/h}$ approaches 4, because the additional factors and hence the geometric mean of all factors becomes ever closer to 4. Thus K_k approaches zero.

G Proof of Properties of $\hat{r}_k(w)$ and of $\tilde{r}_k(w)$

G.1 $\hat{r}_k(w)$

To prove existence and uniqueness, we first note that for $w = 0$, $V_k(r, 0) = (Q_k(r) - r)\pi G$ is strictly negative (strictly positive) for $r \in (0, 1/2)$ (for $r \in (1/2, 1)$) by Part 2 of Lemma 1 and Part a of Theorem 1. Only for $r = 1/2$ we have $V_k(r, 0) = (Q_k(r) - r)\pi G = 0$.

Again referring to Part 2 of Lemma 1 and Part a of Theorem 1, for $w \in (0, 1/2)$ we know that $V_k(w, w) = (Q_k(w) - w)\pi G + (Q_k(w) - w)(1 - \pi)L = (Q_k(w) - w)\pi G(1 - T) < 0$ while $V_k(r, w) > 0$ for all $r \in [1/2, 1]$ by Lemma 4. Then $V_k(r, w)$ must be zero exactly once for $r \in (\max\{w, 1/2 - K_k\}, 1/2)$ and never for $w < r < 1/2 - K_k$, since $V_k(r, w)$ increases only in the entire interval $r \in (1/2 - K_k, 1/2 + K_k)$ and is continuous (Lemma 4). The convergence property $\lim_{k \rightarrow \infty} \hat{r}_k(w) = 1/2$ for all $w \in (0, 1/2)$ follows from $\lim_{k \rightarrow \infty} K_k = 1/2$ (Proof of Lemma 4).

Finally, for $w \in (1/2, 1)$, we know that $V_k(w, w) = (Q_k(w) - w)\pi G(1 - T) > 0$ and $V_k(1, w) = (Q_k(w) - w)(1 - \pi)L < 0$. Since by Lemma 4 $V_k(r, w)$ is continuous and for $r \in (w, 1] \subset (1/2, 1]$ decreases in r only in the entire interval $r \in (1/2 + K_k, 1]$, the solution of $V_k(r, w) = 0$ must again exist, be unique and satisfy $r > 1/2 + K_k$, which completes the proof of existence, uniqueness and the range of $\hat{r}(w)$.

Given existence and uniqueness for the entire domain of definition, continuity of $V_k(r, w)$ implies continuity of $\hat{r}_k(w)$. To prove existence and uniqueness of the minima, we consider the first derivative of $\hat{r}_k(w)$, which by the implicit function theorem is given by:

$$\frac{d\hat{r}_k(w)}{dw} = -\frac{\frac{\partial V_k}{\partial w}}{\frac{\partial V_k}{\partial r}} = T \frac{k \binom{2h}{h} w^h (1 - w)^h - 1}{k \binom{2h}{h} r^h (1 - r)^h - 1} \quad (37)$$

We know from the proof of existence and uniqueness of the function that $\frac{\partial V_k}{\partial r}$ is strictly positive (strictly negative) at $\hat{r}_k(w)$ when $w < 1/2$ (when $w > 1/2$). From Lemma 4 we know that $\frac{\partial V_k}{\partial w} = 0$ only at $w = 1/2 \pm K_k$. Lemma 4 also implies that $\frac{\partial V_k}{\partial w}$ is negative only for $w \in (1/2 - K_k, 1/2 + K_k)$ and positive for $w \notin [1/2 - K_k, 1/2 + K_k]$. Given the sign of $\frac{\partial V_k}{\partial r}$, this implies that $\hat{r}_k(w)$ declines for $w \in [0, 1/2 - K_k)$ and for $w \in (1/2, 1/2 + K_k)$, reaches

its minima at $w = 1/2 \pm K_k$ and increases again for $w \in (1/2 - K_k, 1/2)$ and for $w \in (1/2 + K_k, 1)$, which completes the proof of existence and uniqueness of the minima.

To prove the claims on the limits, we first concentrate on $w \rightarrow 0$ and extend the argument for the other three cases by analogy. We note that $V_k(1/2, 0) = 0$, $V_k(r, 0) < 0$ for $r \in (0, 1/2)$, and $V_k(1/2, w) > 0$ for $w \in (0, 1/2)$. By continuity, this implies that in every small neighborhood of $(r, w) = (0, 1/2)$ there must be some pairs $(r, w) \in (0, 1/2) \times (0, 1/2)$ for which $V_k(r, w) = 0$. As this is true for every arbitrarily small neighborhood, uniqueness of $\hat{r}_k(w)$ implies that $\lim_{w \rightarrow 0} \hat{r}_k(w) = 1/2$. By analogy, the same argument holds true for the other limits of w .

Finally, for $w \in (1/2, 1)$ if the derivative of $\hat{r}_k(w)$ is positive, it is also smaller than T because the denominator of the right-hand side of equation 37 is strictly negative and the numerator is either positive, which implies that $0 > \frac{d\hat{r}_k(w)}{dw} < 0 < T$. Or the numerator also is negative, which implies that $0 > k \binom{2h}{h} w^h (1-w)^h - 1 > k \binom{2h}{h} r^h (1-r)^h - 1$ so that the fraction is smaller than one. Noting that $r = 1 - T + wT$ is the straight line through $(w, r) = (1, 1)$ with slope T , it is obvious that with $\frac{d\hat{r}_k(w)}{dw} < T$ and $\lim_{w \rightarrow 1} \hat{r}_k(w) = 1$ the function $\hat{r}_k(w)$ must always be larger than the function $r = 1 - T + wT$ in the entire neighborhood of $(w, r) = (1, 1)$ for which $\hat{r}_k(w)$ is continuous, i.e. for $w \in (1/2, 1)$. For $k \rightarrow \infty$ we know from the proof in Appendix F that $k \binom{2h}{h} \rightarrow 4^h$ which implies that both $k \binom{2h}{h} w^h (1-w)^h \rightarrow 0$ and $k \binom{2h}{h} r^h (1-r)^h \rightarrow 0$ so that $\lim_{k \rightarrow \infty} \frac{d\hat{r}_k(w)}{dw} = T$ for all $w \in (1/2, 1)$. Thus $\lim_{k \rightarrow \infty} \hat{r}_k(w) = 1 - T + wT$ for all $w \in (1/2, 1)$.

G.2 $\tilde{r}_k(w)$

To prove existence and uniqueness we first note that due to $T = 1$, we have $V_k(w, w) = (Q_k(w) - w)\pi G(1 - T) = 0$. Given the extrema of $V_k(r, w)$ with respect to r as stated in Lemma 4, $V_k(r, w)$ is strictly increasing in r for all $r \in (1/2 - K_k, 1/2 + K_k)$ and decreasing for all $r \notin [1/2 - K_k, 1/2 + K_k]$. Then the facts that $V_k(r, w) > 0$ for all $(r, w) \in C$ and $V_k(w, w) = 0$ imply that $V_k(r, w) = 0$ has a unique solution for $w \in [0, 1/2 - K_k)$ and no solution for $w \in [1/2 - K_k, 1/2]$. Obviously, the solution must be in the interval $r \in (1/2 - K_k, 1/2)$. Similarly, the facts that for $w \in (1/2, 1)$, $V_k(1, w) < 0$ and $V_k(w, w) = 0$ imply that $V_k(r, w) = 0$ has a unique solution for $w \in [1/2, 1/2 + K_k)$ and no solution for $w \in [1/2 + K_k, 1]$. Now the solution has to be in the interval $(1/2 + K_k, 1)$.

Given existence and uniqueness of $\tilde{r}_k(w)$, continuity of $V_k(r, w)$ implies continuity of $\tilde{r}_k(w)$. By the implicit function Theorem, the first derivative of $\tilde{r}_k(w)$ is given by the same expression as the first derivative of $\hat{r}_k(w)$ (equation 37). Due to the slopes of $V_k(r, w)$ implicit in Lemma 4 this expression is negative for $w \in [0, 1/2 - K_k)$ and for $w \in (1/2, 1/2 + K_k)$.

The limits for the boundaries of the two definition intervals may be derived

in a parallel way as for $\hat{r}_k(w)$. The details are therefore omitted here.

H Proof of Lemma 5

The claim that a jury of size $k > 1$ hands down better decisions than an individual expert is equivalent to $V_k(r, w) > 0$. For $(r, w) \in C$, the lemma restates the first insight of Lemma 4. For $T < 1$ and $(r, w) \notin C$ we know from the proof of the properties of $\hat{r}(w)$ in Appendix G that $V_k(r, w) = 0$ only at $r = \hat{r}(w)$ and that $\frac{\partial V_k}{\partial r} > 0$ at $r = \hat{r}(w) < 1/2$ and $\frac{\partial V_k}{\partial r} < 0$ at $r = \hat{r}(w) > 1/2$ which implies that $V_k(r, w) > 0$ only in the regions stated in the lemma. The corresponding result for $T > 1$ follows by symmetry. For $T = 1$ and $(r, w) \notin C$ the proof of the properties of $\tilde{r}(w)$ in Appendix G implies that for $w \in [0, 1/2 - K_k]$ we have $V_k(r, w) > 0$ if and only if $r > \tilde{r}(w)$ while for $w \in (1/2, 1/2 + K_k]$ we have $V_k(r, w) > 0$ if and only if $r < \tilde{r}(w)$. We have also seen there, that for $w \in [1/2 - K_k, 1/2)$ we have $V_k(r, w) > 0$ for all $r > w$ while for $w \in [1/2 + K_k, 1)$ we never have $V_k(r, w) > 0$. This completes the proof.

I Proof of Lemma 6

We concentrate on the properties of $r_k^o(w)$ and leave the properties of $w_k^o(r)$ to a symmetry argument.

$r_k^o(w)$ is defined by $W_k(r_k^o(w), w) = W_o$, which for $T < 1$ reduces to

$$W_k(r_k^o(w), w) = \pi G + (1 - \pi)L \quad (38)$$

By the Implicit Function Theorem, we get

$$\frac{dr_k^o(w)}{dw} = -\frac{\frac{\partial W_k}{\partial w}}{\frac{\partial W_k}{\partial r}} = -\frac{k \binom{2h}{h} [w(1-w)]^h (1-\pi)L}{k \binom{2h}{h} [r(1-r)]^h \pi G} = \left[\frac{w(1-w)}{r(1-r)} \right]^h T > 0, \quad (39)$$

where the second equality follows from part 3. of Lemma 2.

Writing $W_k(r_k^o(w), 0) = Q_k(r_k^o(w))\pi G + Q_k(0)(1 - \pi)L = Q_k(r_k^o(w))\pi G$ implies that $r_k^o(0)$ is defined by $Q_k(r_k^o(0))\pi G = \pi G + (1 - \pi)L$ which reduces to $Q_k(r_k^o(0)) = 1 - T$. Since $1 - T \in (0, 1)$, we have $Q_k(r_k^o(0)) \in (0, 1)$ which entails $r_k^o(0) \in (0, 1)$.

In addition, $T \gtrless 1/2$ implies $1 - T \lesseqgtr 1/2$ and thus $Q_k(r_k^o(0)) \lesseqgtr 1/2$ which entails $r_k^o(0) \lesseqgtr 1/2$ by Lemma 1.

If we extend the domain of $r_k^o(w)$ to include $w = 1$,¹⁸ equation (38) implies $W_k(r_k^o(1), 1) = Q_k(r_k^o(1))\pi G + Q_k(1)(1 - \pi)L = Q_k(r_k^o(1))\pi G + (1 - \pi)L =$

¹⁸We restricted the domain of $r_k^o(w)$ to $w \in [0, 1]$ in the original definition, because our restriction of the domain of our analysis to $1 \geq r \geq w$ implies $r = 1$ for $w = 1$ and thus does not leave any place for consideration on r being larger or smaller than any value for $w = 1$.

$\pi G + (1 - \pi)L$ which implies $Q_k(r_k^o(1)) = 1$ and thus $r_k^o(1) = 1$. Since $r_k^o(w)$ as defined by equation (38) is continuous for $w \in [0, 1]$, we get $\lim_{w \rightarrow 1} r_k^o(w) = 1$.

From equation (39) we get $\frac{dr_k^o(w)}{dw} = \left[\frac{w(1-w)}{r(1-r)} \right]^h T > T$ for $w \in (1/2, 1)$. Hence whenever the lines $r_k^o(w)$ and $1 - T + wT$ intersect when $w \in (1/2, 1)$, the slope of $r_k^o(w)$ is larger than the slope of $1 - T + wT$. Since at $w = 1$ we have $r_k^o(w) = 1 - T + wT = 1$, we get $r_k^o(w) < 1 - T + wT$ for all $w \in (1/2, 1)$. Similarly, the slope of $r_k^*(w)$ is given by (see Appendix E):

$$\begin{aligned} \frac{dr_k^*(w)}{dw} &= T \frac{-(w(1-w))^h [2(3+2h)w^2 - 2(3+2h)w + (h+1)]}{-(r_k^*(w)(1-r_k^*(w)))^h [2(3+2h)r_k^*(w)^2 - 2(3+2h)r_k^*(w) + (h+1)]} \\ &= T \left[\frac{w(1-w)}{r_k^*(w)(1-r_k^*(w))} \right]^h \frac{2(3+2h)w(1-w) - (h+1)}{2(3+2h)r_k^*(w)(1-r_k^*(w)) - (h+1)} \end{aligned}$$

If this derivative is positive for $w > 1/2$, then the numerator and the denominator in the first line are negative (recall property (35) of $g'(x)$), and thus the signs of the numerator and the denominator of the last fraction in the second line are negative too. Hence $r_k^*(w) > w > 1/2$ implies $w(1-w) > r_k^*(w)(1-r_k^*(w))$ and $0 > 2(3+2h)w(1-w) - (h+1) > 2(3+2h)r_k^*(w)(1-r_k^*(w)) - (h+1)$ and thus $\frac{2(3+2h)w(1-w) - (h+1)}{2(3+2h)r_k^*(w)(1-r_k^*(w)) - (h+1)} < 1$. As a consequence,

$$\frac{dr_k^*(w)}{dw} < T \left[\frac{w(1-w)}{r_k^*(w)(1-r_k^*(w))} \right]^h \quad (40)$$

Obviously, the same holds true, when $\frac{dr_k^*(w)}{dw} < 0$. Hence whenever the lines $r_k^o(w)$ and $r_k^*(w)$ intersect when $w \in (1/2, 1)$, the slope of $r_k^o(w)$ is larger than the slope of $r_k^*(w)$. Since at $w = 1$ we have $r_k^o(w) = r_k^*(w) = 1$, we get $r_k^o(w) < r_k^*(w)$ for all $w \in (1/2, 1)$. Combining the insights from this paragraph, we get $r_k^o(w) < \min(1 - T + wT, r_k^*(w))$ for $w \in (1/2, 1)$.

We note that for $w < 1/2$,

$$\lim_{k \rightarrow \infty} W_k(r, w) = \lim_{k \rightarrow \infty} Q_k(r)\pi G + Q_k(w)(1 - \pi)L = \begin{cases} \pi G & \text{if } r > 1/2 \\ 0 & \text{if } r < 1/2 \end{cases}$$

Hence, for any given r , we have $\lim_{k \rightarrow \infty} W_k(r, w) \neq W_o$. Only if $r_k^o(w)$ approaches $1/2$ fast enough, as k grows to infinity, $\lim_{k \rightarrow \infty} W_k(r_k^o(w), w) = W_o$ is possible. Hence, $\lim_{k \rightarrow \infty} r_k^o(w) = 1/2$.

For $r > w > 1/2$, we note that

$$\lim_{k \rightarrow \infty} \frac{dr_k^o(w)}{dw} = \lim_{h \rightarrow \infty} \left[\frac{w(1-w)}{r(1-r)} \right]^h T > 1$$

unless r approaches w sufficiently quickly: if $r = w > 1/2$, we have $\lim_{k \rightarrow \infty} \frac{dr_k^o(w)}{dw} = T < 1$. Since due to $r_k^o(1) = 1$ the slope $\frac{dr_k^o(w)}{dw} > 1$ would violate $r_k^o(w) > w$, r has to approach w as $k \rightarrow \infty$.