

Bofinger, Peter; Mayer, Eric; Wollmershäuser, Timo

Working Paper

The BMW model: Simple macroeconomics for closed and open economies a requiem for the IS/LM-AS/AD and the Mundell-Fleming model

W.E.P. - Würzburg Economic Papers, No. 35

Provided in Cooperation with:

University of Würzburg, Department of Economics

Suggested Citation: Bofinger, Peter; Mayer, Eric; Wollmershäuser, Timo (2002) : The BMW model: Simple macroeconomics for closed and open economies a requiem for the IS/LM-AS/AD and the Mundell-Fleming model, W.E.P. - Würzburg Economic Papers, No. 35, University of Würzburg, Department of Economics, Würzburg

This Version is available at:

<https://hdl.handle.net/10419/48477>

Standard-Nutzungsbedingungen:

Die Dokumente auf EconStor dürfen zu eigenen wissenschaftlichen Zwecken und zum Privatgebrauch gespeichert und kopiert werden.

Sie dürfen die Dokumente nicht für öffentliche oder kommerzielle Zwecke vervielfältigen, öffentlich ausstellen, öffentlich zugänglich machen, vertreiben oder anderweitig nutzen.

Sofern die Verfasser die Dokumente unter Open-Content-Lizenzen (insbesondere CC-Lizenzen) zur Verfügung gestellt haben sollten, gelten abweichend von diesen Nutzungsbedingungen die in der dort genannten Lizenz gewährten Nutzungsrechte.

Terms of use:

Documents in EconStor may be saved and copied for your personal and scholarly purposes.

You are not to copy documents for public or commercial purposes, to exhibit the documents publicly, to make them publicly available on the internet, or to distribute or otherwise use the documents in public.

If the documents have been made available under an Open Content Licence (especially Creative Commons Licences), you may exercise further usage rights as specified in the indicated licence.

W. E. P.

Würzburg Economic Papers

No. 35

The BMW model: simple macroeconomics for closed and open economies – a requiem for the IS/LM-AS/AD and the Mundell-Fleming model

Peter Bofinger, Eric Mayer and Timo Wollmershäuser

October 2002 (Revised)

Universität Würzburg
Lehrstuhl für Volkswirtschaftslehre, Geld
und internationale Wirtschaftsbeziehungen
Sanderring 2, D-97070 Würzburg
peter.bofinger@mail.uni-wuerzburg.de
Tel.: +49/931/31-2945

The BMW model: simple macroeconomics for closed and open economies – a requiem for the IS/LM-AS/AD and the Mundell-Fleming model*

Peter Bofinger, Eric Mayer and Timo Wollmershäuser

October 2002

Abstract

While the IS/LM-AS/AD model is still the central tool of macroeconomic teaching in most macroeconomic textbooks, it has been criticised by several economists. Colander [1995] has demonstrated that the framework is logically inconsistent, Romer [2000] has shown that it is unable to deal with a monetary policy that uses the interest rate as its operating target, Walsh [2001] has criticised that it is not well suited for an analysis of inflation targeting. In our paper we start with a short discussion of the main flaws of the IS/LM-AS/AD model. We present the BMW model as an alternative framework, which develops the Romer approach into a very simple, but comprehensive macroeconomic model. In spite of its simplicity it can deal with issues like inflation targeting, monetary policy rules, and central bank credibility. We extend the model to an open-economy version as a powerful alternative to the IS/LM-based Mundell-Fleming (MF) model. The main advantage of the open-economy BMW model is its ability to discuss the role of inflation and the determination of flexible exchange rates while the MF model is based on fixed prices and constant exchange rates.

This working paper is an extended and more theoretical version of Bofinger et al. [2002]. Besides describing the derivation of optimal interest rate rules and the concept of loss functions more in detail, it also discusses simple interest rate rules in an open economy as well as a strategy of managed floating within the same theoretical framework. Additionally, we explore the stabilizing properties of simple interest rate rules.

JEL classification: A 2, E 1, E 5, F 41

Keywords: monetary policy, inflation targeting, optimal interest rate rules, simple rules, managed floating, IS/LM, Mundell-Fleming

* The authors would like to thank Sebastian Dullien, Peter Spahn and Michael Woodford for extremely helpful and valuable comments on WEP 34 which helped to improve WEP 35.

Contents

1	Introduction	1
2	Four main flaws of the IS/LM-AS/AD model	1
3	The BMW model for the closed economy	4
	<i>3.1 Its main building blocs</i>	<i>4</i>
	<i>3.2 The unregulated system.....</i>	<i>7</i>
	<i>3.3 Monetary Policy under discretion.....</i>	<i>9</i>
	<i>3.3.1 Monetary policy under discretion: the optimal interest rate rule</i>	<i>9</i>
	<i>3.3.2 Monetary policy under discretion: demand shocks.....</i>	<i>12</i>
	<i>3.3.3 Monetary policy under discretion: supply shocks</i>	<i>13</i>
	<i>3.3.3.1 Monetary policy under discretion: supply shocks and the inflation nutter</i>	<i>14</i>
	<i>3.3.3.2 Monetary policy under discretion: supply shocks and the output junkie.....</i>	<i>15</i>
	<i>3.3.3.3 Monetary policy under discretion: supply shocks and intermediate preferences.....</i>	<i>16</i>
	<i>3.4 Simple interest rate rules.....</i>	<i>19</i>
	<i>3.4.1 Minimum requirements for reasonable rules.....</i>	<i>22</i>
	<i>3.4.1.1 Loss implied by the unregulated system.....</i>	<i>23</i>
	<i>3.4.1.2 Loss implied by the regulated system: deriving minimum requirements for reasonable rules ..</i>	<i>23</i>
	<i>3.4.2 Simple interest rate rules: demand shocks.....</i>	<i>26</i>
	<i>3.4.3 Simple interest rate rules: supply shocks.....</i>	<i>27</i>
	<i>3.5 A welfare theoretic comparison between optimal and simple rules</i>	<i>30</i>
	<i>3.6 The inflation bias in monetary policy.....</i>	<i>32</i>
	<i>3.6.1 Reaction function of the central bank</i>	<i>33</i>
	<i>3.6.2 Surprise inflation, rational expectations and commitment.....</i>	<i>34</i>
	<i>3.6.3 The Barro/Gordon model in the BMW framework.....</i>	<i>38</i>
4	The BMW model for an analysis of monetary policy in an open economy	39
	<i>4.1 Monetary policy under discretion – the optimal interest rate rule under independently floating rates.....</i>	<i>41</i>
	<i>4.1.1 Monetary policy under flexible rates if PPP and UIP hold simultaneously (long-term scenario) 41</i>	
	<i>4.1.2 Monetary policy under flexibles rates if UIP holds but not PPP (short-run scenario).....</i>	<i>42</i>
	<i>4.1.3 Monetary policy under exchange rates that behave like a random walk.....</i>	<i>48</i>
	<i>4.2 Simple interest rate rules under independently floating exchange rates</i>	<i>50</i>
	<i>4.3 Monetary policy under absolutely fixed exchange rates.....</i>	<i>56</i>
	<i>4.4 Monetary policy under a strategy of managed floating</i>	<i>64</i>

5	Summary and comparison.....	72
5.1	<i>The closed economy BMW model and the IS/LM-AS/AD model.....</i>	<i>72</i>
5.2	<i>The open economy BMW model and the Mundell-Fleming model</i>	<i>74</i>
6	Conclusion.....	77
	Reference List.....	79

1 Introduction

While the IS/LM-AS/AD model is still the central tool of macroeconomic teaching in most macroeconomic textbooks, it has been criticised by several economists. Colander [1995] has demonstrated that the framework is logically inconsistent, Romer [2000] has shown that it is unable to deal with a monetary policy that uses the interest rate as its operating target, Walsh [2001] has criticised that it is not well suited for an analysis of inflation targeting. In our paper we start with a short discussion of the main flaws of the IS/LM-AS/AD model. In section 2 we present the BMW model as an alternative framework, which develops the Romer approach into a very simple, but comprehensive macroeconomic model. In spite of its simplicity it can deal with issues like inflation targeting, monetary policy rules, and central bank credibility. In section 3 we extend the model to an open-economy version as a powerful alternative to the IS/LM based Mundell-Fleming (MF) model. The main advantage of the open-economy BMW model is its ability to discuss the role of inflation and the determination of flexible exchange rates while the MF model is based on fixed prices and constant exchange rates.

2 Four main flaws of the IS/LM-AS/AD model

The standard version of the IS/LM-AS/AD model suffers from several serious flaws, which we will discuss in the following.

- As Colander [1995] has shown, it suffers from an inconsistent explanation of aggregate supply.
- The model is designed for a monetary policy that targets the money supply. Thus, as emphasised by Romer [2000], it is unable to cope with real world monetary policy, which is conducted in the form of interest rate targeting.
- As pointed out by Walsh [2001], the model has nothing to say about the inflation rate. As a consequence, the expectations augmented Phillips curve is not an integral part of the model. Furthermore, the model cannot deal with modern concepts such as inflation targeting, credibility, monetary policy rules and loss functions.
- Its open economy version (Mundell-Fleming model) is unable to deal with flexible prices and exchange rate paths. This implies that it cannot adequately cope with the two basic theories of open economy monetary policy, i.e. uncovered interest parity theory and purchasing power parity theory.

The first flaw has been formulated by Colander [1995] as follows:

“Given that the Keynesian model includes assumptions about supply, one cannot logically add another supply analysis to the model unless that other supply analysis is consistent with the Keynesian model assumption about supply. *The AS curve used in the standard AS/AD model is not; thus the model is logically inconsistent.*” (ibid., p. 176)

Figure 1: The classical IS/LM-AS/AD model

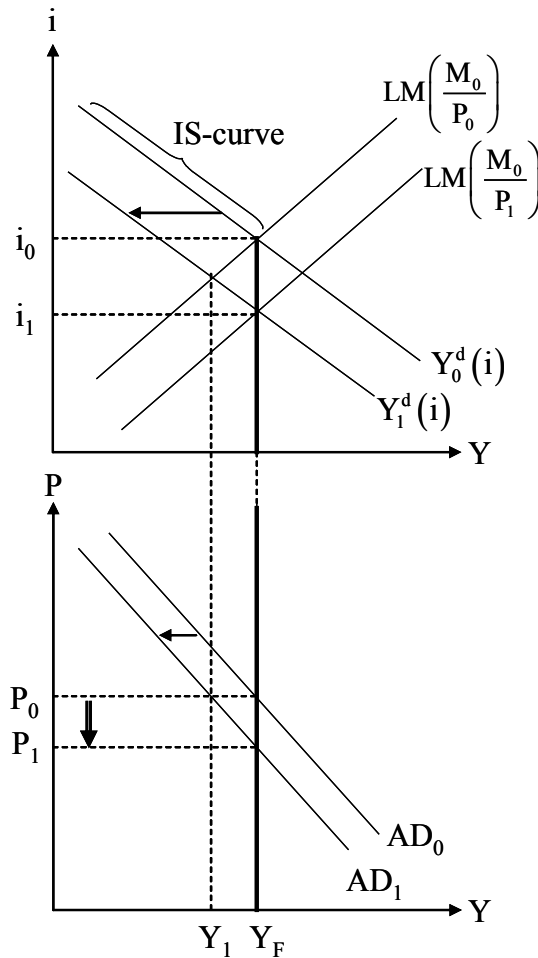

This argument can be demonstrated with the help of a simple graphical analysis. It starts with a slightly different approach to the IS curve. As this curve is the locus where aggregate demand and aggregate supply are identical, we can make both curves explicit. First, we draw an aggregate demand curve that depends negatively on the nominal interest rate (upper panel of Figure 1). The aggregate supply can be derived under the assumption that there is a full employment output which is determined on a neoclassical labour market (Y_F). From the logic of Keynesian economics the aggregate supply is determined by aggregate demand as long as it is

below Y_F . This leads to an aggregate supply curve which is identical with the aggregate demand curve and which becomes vertical at Y_F . In the lower panel we have depicted the AS/AD model i.e. a classical aggregate supply curve – which has been derived in the same way as Y_F – and a typical aggregate demand curve.

The inconsistency is obvious for negative demand shocks, which shift both aggregate demand curves to the left. The main message of the IS/LM-AS/AD model is now that this shock leads to a fall of the price level, which is caused by an excess supply ($Y_F > Y_1$) at the old price level P_0 . But this effect on the price level is only possible if the firms are actually supplying the full employment output (Y_F). According to the logic of the IS curve they would simply adjust their supply to the given demand Y_1 so that the price level would remain constant. Thus, the whole explanation of the price level provided by the IS/LM-AS/AD model rests on inconsistency between a Keynesian determination of demand in the IS/LM plane and a neoclassical determination in the AS/AD plane.

The second main flaw of the IS/LM-AS/AD model concerns its approach to the implementation of monetary policy. As Romer [2000] has shown the LM curve is derived under the assumption that the central bank uses the monetary base as its operating target. With a constant multiplier this is automatically translated into a targeting of the money supply. This approach is not compatible with actual practice of central banks using a short-term interest rate (or a set of short-term rates) as operating target. An additional short-coming of the standard derivation of the LM is the fact that the money supply process is discussed in a completely mechanistic way which does not take into account the relevant interest rates (central bank refinancing rate and loan rate of banks); a price-theoretic approach is presented in Bofinger [2001]. For teaching purposes the LM curve has the main disadvantage that it can say nothing about the impact of changes in the official interest rates (the Federal Funds Rate or the ECB's Repo Rate) on the economy. In addition, representing monetary policy by the LM curve requires that one uses a nominal interest rate. While the *nominal* interest rate is the relevant opportunity cost of holding non-interest bearing money aggregate demand depends on the *real* interest rate. In order to make the two rates compatible the IS/LM-model has to assume that the inflation rate is zero and hence, that prices are constant.¹

This leads to the third flaw of the IS/LM-AS/AD model. Due to its modelling of monetary policy via the LM curve, its analysis is limited to one-time changes in the price level. Thus, it can say nothing about the determination of the inflation rate although this variable is much more relevant in the public debate than changes in the price level. As mentioned by Romer [2000], a decline in the price level, which is the consequence of a negative demand shock in the IS/LM-AS/AD model has been rarely encountered in the post-war period. However, a decline in the inflation rate is something very common. As a consequence of its focus on the price level, the IS/LM-AS/AD model is also not able to integrate the standard expectations-augmented Phillips curve. Thus, the common textbook procedure is the presentation of an aggregate supply curve based on price levels and one or several chapters later a separate presentation of the Phillips curve based on the inflation rate.² We will also see that this approach is responsible for the inconsistent derivation of aggregate supply. Because of its inability to include the inflation rate, the IS/LM-AS/AD model is unable to discuss new concepts such as inflation targeting, monetary policy rules, and loss functions which are all based on the inflation rate.

In the open-economy version (MF model) the modelling of monetary policy in the form of the LM curve is even more limiting. As a fix-price model the MF model is unable to analyse the determination of the price level in an open economy. Thus, it cannot be used for an analysis of supply shocks. In addition, as the model is only focussing on one-time changes in the level of the exchange rate, its discussion of flexible rates is very limited. Above all, the core concepts of exchange rate theory, the uncovered interest parity theory and the purchasing power theory, are not used for a determination of the flexible exchange rate.

3 The BMW model for the closed economy

3.1 Its main building blocs

The closed-economy version of the BMW model consists of four building blocs:

- an aggregate demand equation,
- an aggregate supply equation,
- an interest rate equation, and
- a Phillips curve equation.

¹ McCallum [1989] presented a model which tries to deal with these two approaches under a positive inflation rate. However, it is much too complicated for introductory purposes.

Aggregate demand, which is presented, in the form of the output gap (y) depends on autonomous demand components (a), negatively on the real interest rate and a demand shock (ε_1):

$$(1) \quad y^D = a - br + \varepsilon_1.$$

As Figure 2 shows, this approach is very much in line with Romer [2000].

Figure 2: The aggregate demand curve

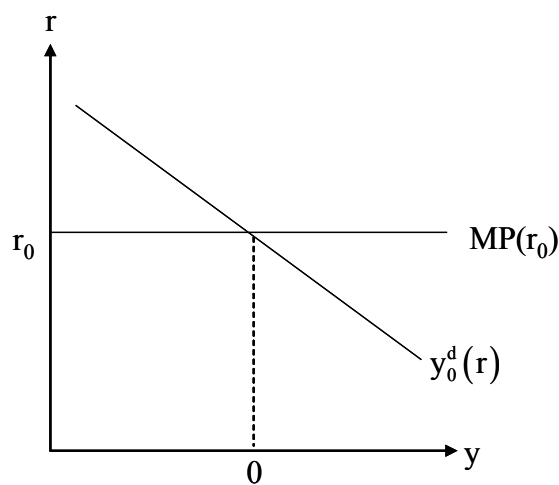

We assume for our short-run analysis that *aggregate supply* is determined by aggregate demand and that there are no capacity constraints:

$$(2) \quad y^S = y^D = y.$$

For the sake of simplicity we do not differentiate between y^S and y^D in the following. As a third building bloc we assume for monetary policy that the central bank is able to determine a real interest rate. In the most simplest version we assume that the central bank decides on interest rates on a discretionary basis:

$$(3) \quad r = \bar{r}.$$

² See for instance Blanchard [2000], Abel and Bernanke [2001].

In Figure 4 this is depicted as a horizontal interest rate line (ML). As the central bank controls the nominal interest rate on the money market, it determines the required nominal rate by adding inflation to the real interest rate:

$$(4) \quad \bar{i} = \bar{r} + \pi.$$

The fourth building bloc is the expectations-augmented *Phillips curve* (Figure 5) which we model in a similar way as Walsh [2001]:

$$(5) \quad \pi = \pi^e + \alpha y + \varepsilon_2.$$

The inflation rate is determined by inflation expectations, the output gap, and a supply shock. In the most simple version one can assume that the central bank is *credible*, i.e. that private inflation expectations are identical with the central bank's inflation target (π_0). Thus, the Phillips curve becomes

$$(6) \quad \pi = \pi_0 + \alpha y + \varepsilon_2.$$

It is important to note that this curve is not a short-term supply curve but simply a device for calculating the inflation rate that is associated with an output gap, which is determined in Figure 3.

Figure 3: The expectations augmented Phillips curve

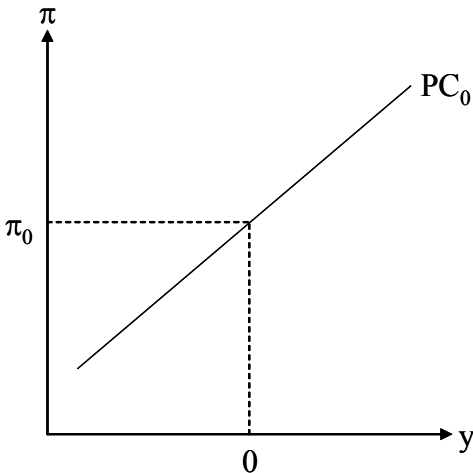

3.2 The unregulated system

In this section we introduce the notion of the unregulated system. The unregulated system is defined by an unchanged monetary policy stance where the real interest rate is set state independently equal to its long run equilibrium value r^* . Accordingly following supply and demand shocks the real interest rate is left unchanged. This concept is useful for the following reasons. First, if we assume that the economy is hit by supply or demand shocks the unregulated system illustrates the basic interactions between the variables of the BMW-model. Second, it equips us with a useful tool at hand by which we can restrict the set of reasonable rules (see section 3.4.1).

Assume that the economy is hit by a unit supply shock. The shock will generate an equivalent jump in the inflation rate. The output gap remains equal to its equilibrium value as the inflation rate does not enter equation (1).

Figure 4: Comparative static response to a supply shock

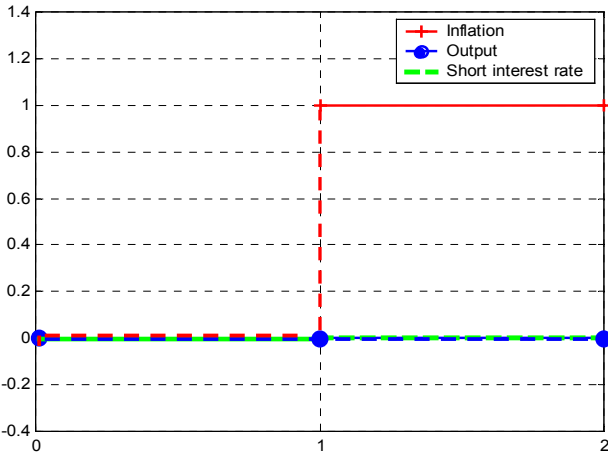

The final outcome will be a permanent jump in the inflation rate that will not be undone by subsequent monetary policy action, as real interest rates by definition will remain unchanged. Note that this implies that nominal interest rates have to be adjusted one for one with the inflation rate so that the stance of monetary policy, as measured by real interest rates, remains unchanged.

Assume that the economy is hit by a unit demand shock. Equations (1) and (5) depict that the shock will have a twofold impact on the unregulated system. First, the output gap will exhibit a

permanent jump of the same size. Second, as the the output gap influences inflation, the inflation rate will rise by d times the unit shock (see Figure 5).

Figure 5: Comparative static response to a supply shock

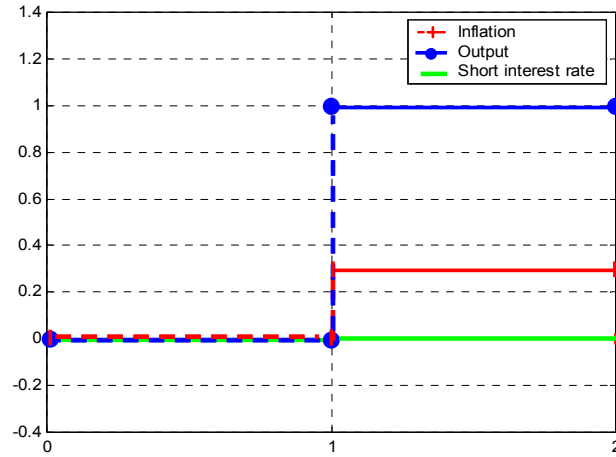

Comparing the two types of shocks shows that supply shocks only have an impact on inflation whereas demand shocks influence both goal variables. We can equally express these results in terms of variances. The variance of the output gap is given by:

$$(7) \quad \text{Var}[y] = \text{Var}[\varepsilon_1],$$

Equation (7) reflects that only demand shocks influence output in the unregulated system.

$$(8) \quad \text{Var}[\pi] = \text{Var}[\varepsilon_2] + d^2 \text{Var}[\varepsilon_1].$$

The variance of the inflation rate is derived by inserting equation (1) into equation (6) and squaring the resulting expression. If we assume that monetary policy makers aim at minimizing a linear combination of the variances of output and inflation equations (7) and (8) are then a useful benchmark against which other strategies such as optimal or simple rules can then be evaluated. Note that we assume that demand and supply shocks are individually distributed iid with mean zero and variances of $\sigma_{\varepsilon_1}^2$ and $\sigma_{\varepsilon_2}^2$ respectively.

3.3 Monetary Policy under discretion

The standard textbook literature typically depicts monetary policy by manipulating the monetary base or more generally monetary aggregates. Nevertheless it is common practice to implement monetary policy in the form of interest rate targeting. This important aspect has been emphasised by Romer [2000]. Taking this more realistic stance we will present two notions by which an interest rate based monetary policy strategy can be implemented. In Chapter 3.3 we present optimal monetary policy under discretion. Policymakers minimize a loss function exploiting their knowledge on the complete structure of the economy. Acting in an environment of complete information leads to a global optimum. In chapter 3.4 we introduce the concept of simple rules. The philosophy behind simple rules is quite different compared to optimal rules. Simple monetary policy rules can be considered as a heuristic - a rule of thumb -, which allows successful and fast decision making even under incomplete knowledge on the structure of the economy. A welfare theoretic comparison will underline the superiority of optimal policy when the structure of the economy is known.

3.3.1 Monetary policy under discretion: the optimal interest rate rule

The overall goal of monetary policy is to promote welfare. This is usually interpreted in terms of keeping the inflation rate close to the inflation target and stabilizing output around its potential³. The implementation of monetary policy is based on a so-called monetary policy strategy. The strategy facilitates the internal decision-making process as well as the transparency and accountability in relation to the public. The strategy of inflation-forecast targeting has become more and more popular throughout the last decade. Countries like New Zealand, Canada, the UK, Sweden, Finland, Australia and Brazil have introduced a full-fledged inflation-targeting regime. Other central banks most notably the FED and the ECB implicitly implemented such an approach. Following Bofinger [2001], Svensson [2002] and Woodford [2002a] an inflation forecast targeting can be defined by the following main characteristics:

- There is a numerical value for the inflation target. Achieving this inflation rate is the dominant goal of monetary policy although some space for other goals like stabilizing output around its trend is left.
- Interest rates are set in such a way that the inflation forecast will return to the inflation target in the periods to come. Therefore the inflation forecast plays a prominent role in

the decision-making process. The speed of dis- and reflation is determined by preferences.

- The decision-making process is characterised by a high degree of transparency and accountability.

In the literature it is common practice to centre the exposition of central bank strategies around quadratic loss functions depicting preferences⁴. The goal variables are modelled in terms of the output gap and the inflation rate. The central bank's problem can be stated within the linear quadratic framework as follows:

$$(9) \quad L = (\pi - \pi_0)^2 + \lambda y^2$$

The popularity of the quadratic stems from the fact that it is able to map the popular strategy of 'inflation-forecast targeting'. The nested regimes can be stated as follows:

- i) Strict-inflation targeting: $\lambda = 0$
- ii) Flexible-inflation targeting $\lambda \in [0,1]$

The intuition behind the quadratic loss function is quite simple. Policymakers stabilize squared deviations of the inflation rate around the inflation target while equally holding squared deviations of the output gap near null. The quadratic implies that positive and negative deviations of target values impose an identical loss on economic agents. Additionally large deviations from target values generate a more than proportional loss. The parameter λ depicts the weight policymakers attach to stabilizing the inflation rate compared to stabilizing the output gap. If λ is equal to null policymakers only care on inflation. This type will be called inflation nutter. If λ goes to infinity policymakers only care on output. This preference type will be called output junkie.

The optimisation problem of the central bank can be stated as follows: Set the instrument in such a way that the loss function is minimized. Given the 'transmission structure' of the model

$$(10) \quad r \rightarrow y \rightarrow \pi$$

³ For a microfounded derivation of the standard loss function see Woodford [2002b].

the optimal interest rate rule can be derived by applying the following two-step procedure:

1. Insert the Phillips curve into the loss function, take the first order condition and solve for y . The solution will be an optimal value for y which is given by equation (11):

$$(11) \quad y = \frac{-d}{d^2 + \lambda} \varepsilon_2$$

This solving procedure has the advantage that we can give a simple intuition to it as it shows that monetary policy is conducted via an optimal control of the output gap. Note that if we insert (11) into the Phillips curve (6) we get the following reduced form expression for the inflation rate under discretion:

$$(12) \quad (\pi - \pi_0) = \frac{\lambda}{d^2 + \lambda} \varepsilon_2$$

Equations (11) and (12) imply that under discretion the output gap as well as the inflation gap only depend on supply shocks ε_2 . In other words demand shocks can be completely undone. We will further elaborate on this point in section 3.3.2.

2. Inserting equation (11) into equation (1) and solving for r results for the optimal monetary policy rule:

$$(13) \quad r^{\text{opt}} = \frac{a}{b} + \frac{1}{b} \varepsilon_1 + \frac{d}{b(d^2 + \lambda)} \varepsilon_2^5$$

If monetary policy is conducted according to equation (13) the loss function (9) is minimized. If demand and supply shocks are absent ($\varepsilon_1 = \varepsilon_2 = 0$) the central bank targets $r^{\text{opt}} = a/b$. In line with Blinder [1998], p.31 this rate can be regarded as a neutral real short-term interest rate.

⁵ Note that we could have equally depicted the optimization problem following Walsh [2001] by solving equation (11) for ε_2 and inserting it into equation (6) to derive a relationship between the inflation gap and the output gap that is consistent with optimizing agents. This relationship could be interpreted as an optimal monetary policy rule if we treat the output gap as the instrument of monetary policy.

Figure 6: Interest rate response to supply and demand shocks

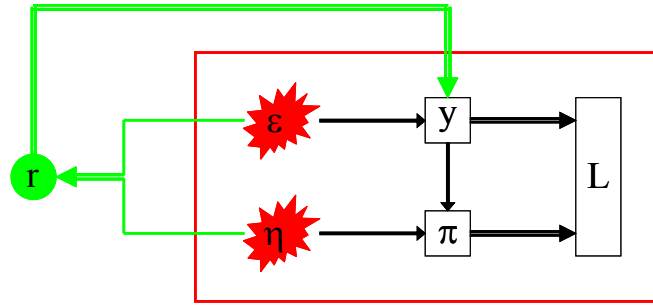

Figure 6 illustrates the fundamental difference between supply and demand shocks that already prevailed in the unregulated system. Monetary policy is able to control the output gap directly by changing the real interest rate. Accordingly, demand shocks can be undone by choosing an appropriate real interest rate. Thereby the inflation rate will not be affected by a demand shock. Given supply shocks, the central bank faces a trade-off. The question which inflation-output gap mix will be chosen is determined by the weight monetary policy puts on stabilizing the output gap versus stabilizing the inflation rate.

3.3.2 *Monetary policy under discretion: demand shocks*

Assume that the economy is hit by a demand shock, e.g. an unexpected increase in consumer spending. If supply shocks are absent the optimal reaction following a demand shock is derived by setting ε_2 equal to null in equation (13):

$$(14) \quad r^{\text{opt}} = \frac{a}{b} + \frac{1}{b} \varepsilon_1$$

Inserting equation (14) in the aggregate demand relationship results in equation (15).

$$(15) \quad y = a - b \left[\left(\frac{a}{b} \right) + \frac{1}{b} \varepsilon_1 \right] + \varepsilon_1$$

Simplifying equation (15) shows that the output gap will remain at its equilibrium level of null. Monetary authorities can totally undo demand shocks. $(\pi_0; 0)$ represents the global optimum. Therefore each preference type sets the real interest rate according to equation (14). In other words, r^{opt} does not depend on the preference parameter λ (see Figure 7).

Figure 7: Discretionary policy following a demand shock

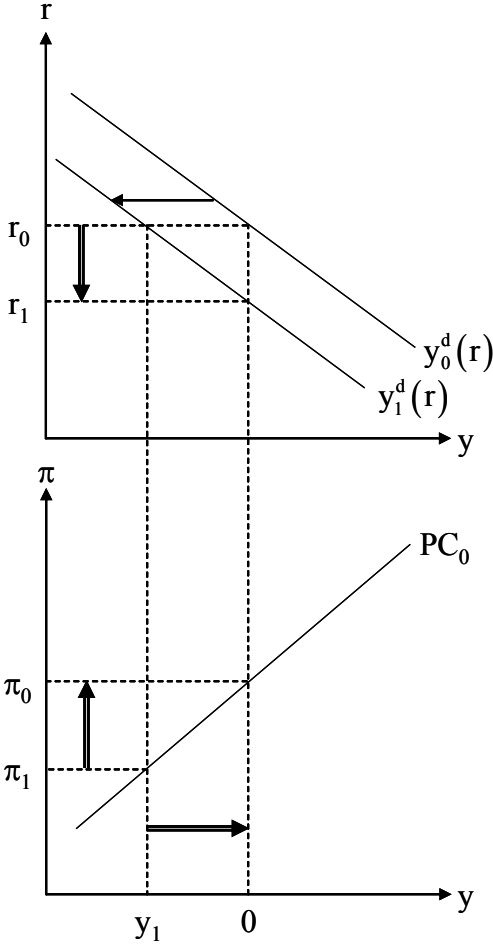

Due to the demand shock, the aggregate demand curve shifts to the left from y_0^d to y_1^d , resulting in a negative output gap y_1 . In the lower panel this is translated into an inflation rate π_1 that is below the central bank's target rate. If the central bank lowers the real rate from r_0 to r_1 the output gap is closed and the inflation rate is brought back on its target level.

3.3.3 Monetary policy under discretion: supply shocks

Assume that the economy is hit by a supply shock. If we assume that demand shocks are absent the optimal real interest rate is given by setting ε_1 equal to null in equation (13)

$$(16) \quad r^{opt} = \frac{a}{b} + \frac{d}{b(d^2 + \lambda)} \varepsilon_2$$

Equation (16) implies that the optimal response to supply shocks depends on the preference parameter λ . To illustrate this point we evaluate two extreme preference types: the inflation nutter ($\lambda = 0$) and the output junkie ($\lambda \rightarrow \infty$).

3.3.3.1 Monetary policy under discretion: supply shocks and the inflation nutter

The loss function of the inflation nutter is derived by setting λ equal to null in equation (9).

$$(17) \quad L = (\pi - \pi_0)^2$$

The corresponding optimal feedback rule is derived by setting λ equal to null in (16).

$$(18) \quad r^{\text{opt}} = \frac{a}{b} + \frac{1}{b} \varepsilon_1 + \frac{1}{b \cdot d} \varepsilon_2$$

With equation (18) at hand we can evaluate the following expression for the output gap:

$$(19) \quad y = -\frac{1}{d} \varepsilon_2$$

The corresponding inflation gap ($\pi - \pi_0$) is given by:

$$(20) \quad \pi - \pi_0 = d \left(-\frac{1}{d} \varepsilon_2 \right) + \varepsilon_2$$

Equation (20) shows that the inflation rate will stay equal to the inflation target. Hence, we arrive at the intriguing result that the inflation nutter generates a change in the overall economic activity that exactly compensates the impact of the initial supply shock on the inflation rate.

Figure 8 depicts the corner solution of a preference type that only cares on inflation. The supply shock ($\varepsilon_2 > 0$) shifts the Phillips curve from PC_0 to PC_1 in the lower panel. In order to meet the inflation target π_0 the central bank rises real rates from r_0 to r_1 . This generates a negative output gap of y_1 .

Figure 8: Positive supply shock and the reaction of the inflation nutter

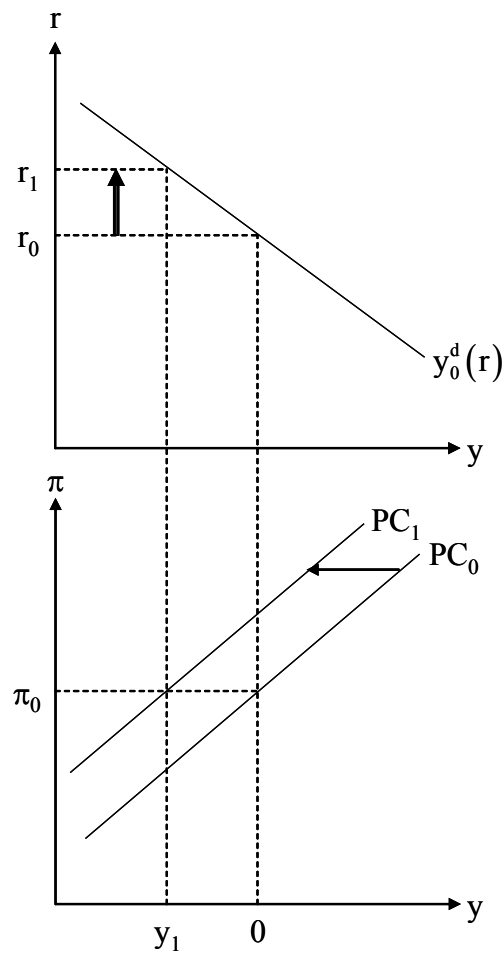

3.3.3.2 Monetary policy under discretion: supply shocks and the output junkie

A preference type that only cares on output stabilization conducts monetary policy according to the following rule:

$$(21) \quad r^{\text{opt}} = \frac{a}{b} + \frac{1}{b} \varepsilon_1$$

As supply shocks only alter the inflation rate the real interest rate r^{opt} does not depend on ε_2 . Inserting equation (21) into equation (1) leads to the following expression for the output gap and the inflation rate.

$$(22) \quad y = a - b \left(\frac{a}{b} + \frac{1}{b} \varepsilon_1 \right) + \varepsilon_1 = 0$$

$$(23) \quad \pi = \pi_0 + \varepsilon_2$$

The output gap will be stabilized at its target value of null. Contrary to that the inflation rate will exhibit a permanent deviation from the inflation target π_0 . Within a graphical analysis this result can be represented as follows.

Figure 9: Positive supply shock and the reaction of the output junkie

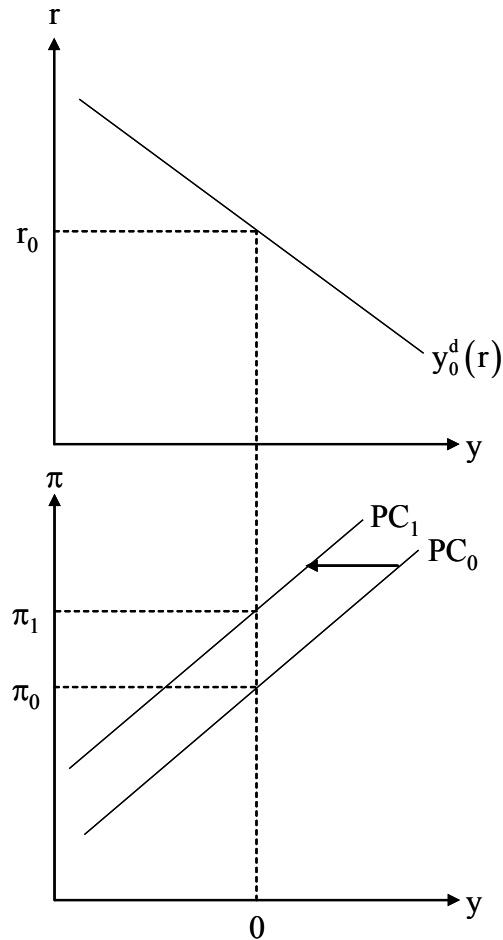

The supply shock shifts the Phillips curve from PC_0 to PC_1 . The central bank leaves the real interest rate equal to r_0 . Consequently the supply shock will be transmitted one to one to the inflation rate and the inflation rate rises from π_0 to π_1 .

3.3.3.3 Monetary policy under discretion: supply shocks and intermediate preferences

If we assume more realistically that the central bank puts a positive weight on both target variables the loss function is given by equation (9). In the π/y space loss functions can be

represented by circles around a “bliss point” (see Figure 10). The bliss point is defined by an inflation rate, which is equal to the inflation target and an output gap of zero. It represents the optimal outcome. The circle can be derived by dividing equation (9) by L.

$$(24) \quad \frac{(\pi - \pi_0)^2}{g^2} + \frac{(y - 0)^2}{h^2} = 1 \quad \text{with: } g = \sqrt{L^{Opt}}; \quad h = \sqrt{\frac{L^{Opt}}{\lambda}}$$

Figure 10: Isoquant of the loss function and the bliss point

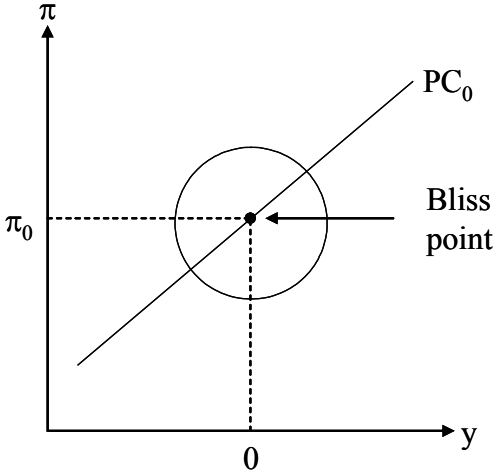

In the case of a demand shock we have already seen that monetary policy is able to maintain the “bliss combination” of π and y at the centre of the circle. In the case of *supply shocks* the loss function helps us to identify the optimum combination of π and y . The Phillips curve serves as a restriction under which the loss function has to be minimised. The optimum combination $(y_1; \pi_1)$ is given by the tangency point of the Phillips curve PC_1 with the ellipse (assuming that $g \neq h$).

For increasing values of λ the ellipse flattens, hence we move closer to the preference type of the inflation nutter (see Figure 11). In the presence of supply shocks ε_2 , the central bank conducts an accomodating policy by distributing the effects of the shock between the final targets y and π according to its preferences λ . Figure 12 gives some further intuition to the result. All intermediate preference types will choose a point on the line between A and B. Hence each preference type will choose an output gap from the interval $[y_1, 0]$ and an inflation rate from the interval $[\pi_1, \pi_0]$ by setting the real interest rate accordingly.

Figure 11: Isoquant of the loss function

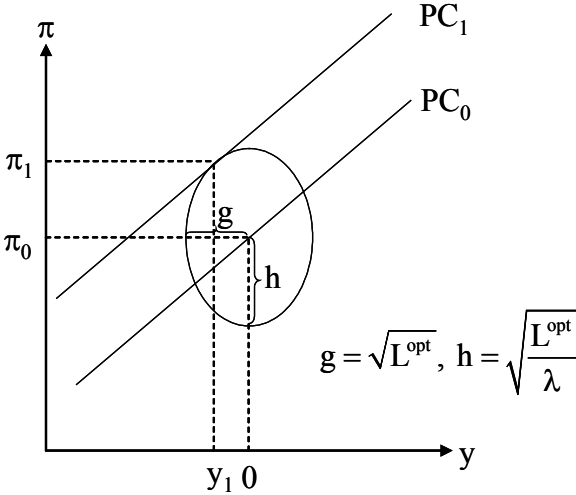
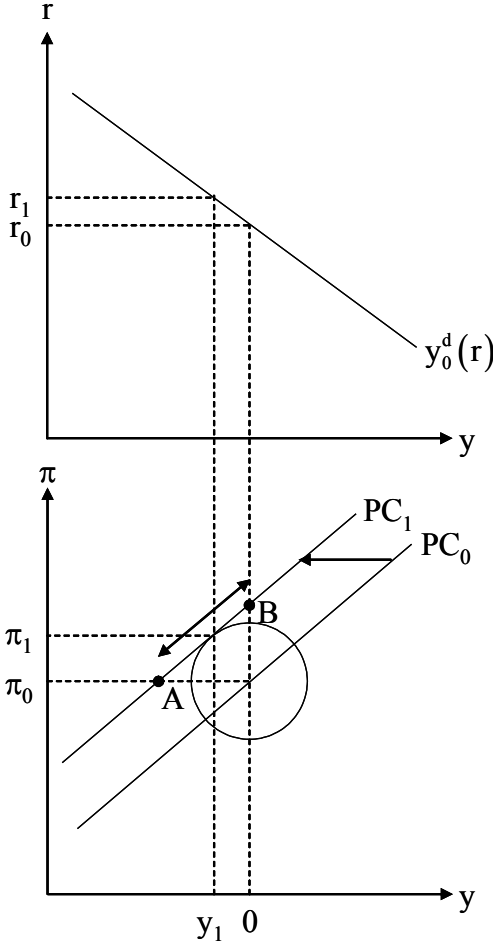

Figure 12: Supply shocks: intermediate preferences



⁶ Note that the loss which will only be a circle if $g=h$. In the more general case $g \neq h$ the loss function can be represented by an ellipse (see Figure 11).

Algebraically the deviation of the output gap and the inflation gap are given by equation (25) and (26):

$$(25) \quad y = \frac{-d}{d^2 + \lambda} \varepsilon_2$$

$$(26) \quad (\pi - \pi_0) = \frac{\lambda}{d^2 + \lambda} \varepsilon_2$$

Equipped with equations (25) and (26) at hand we arrive at the following expressions in terms of variances:

$$(27) \quad \text{Var}(y) = \left(\frac{d}{d^2 + \lambda} \right)^2 \text{Var}(\varepsilon_2)$$

$$(28) \quad \text{Var}(\pi - \pi_0) = \left(\frac{\lambda}{d^2 + \lambda} \right)^2 \text{Var}(\varepsilon_2)$$

As demand shocks can be instantly undone the variances of the goal variables will only depend on the exogeneously given variance of the supply shock ε_2 .

3.4 Simple interest rate rules

In section 3.3.1 we have developed the notion of optimal monetary policy under discretion. In this section we will illustrate the concept of simple rules Taylor [1993]. A simple monetary policy rule can be stated as follows:

$$(29) \quad r = FX$$

F is a coefficient vector and X are the variables of the model. At the heart of simple rules lies the notion that the coefficients of F are not derived in order to minimize the loss function. Instead one may say that the coefficients are chosen ad hoc based on the experiences and skills of the monetary policy makers. Typically some of the coefficients will be set equal to zero meaning

that policy makers explicitly ignore certain variables which are considered to be only of minor importance for the conduct of monetary policy. Hence simple monetary policy rules may be considered as a heuristic- a rule of thumb-, which allows successful and fast decision making even under incomplete knowledge on the structure of the economy. As a workhorse to evaluate the performance of simple rules we will rely on the Taylor rule. The Taylor rule can be stated as follows:

$$(30) \quad r = r_0 + e(\pi - \pi_0) + fy .$$

Graphically the Taylor rule gives an upward-sloping interest rate line (MP) in the r/y diagram (Figure 13):

Figure 13: Taylor rule

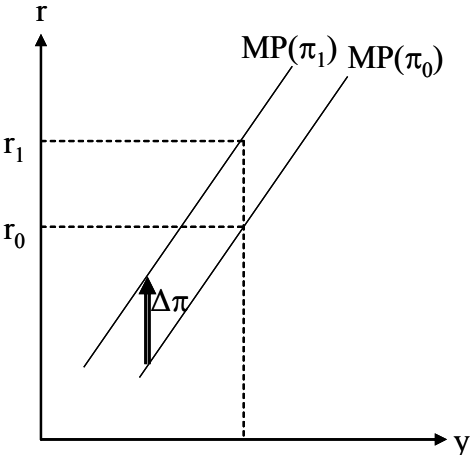

The MP line is shifted upwards if the inflation rate increases. In the π/y diagram the Taylor rule leads to a downward sloping aggregate demand function. This line can be derived graphically as follows (Figure 14). Initially the inflation rate is equal to the inflation target π_0 . The MP line corresponding to this inflation rate is $MP(\pi_0)$ which is associated with $y=0$ (Point A, lower panel). If the inflation rate increases to π_1 the MP line is shifted upwards to $MP(\pi_1)$. This leads to an output decline corresponding to a negative output gap y_1 . In the π/y diagram this combination of inflation and output leads to point B which together with point A allows us to draw a downward-sloping $y(\pi)$ line.

Figure 14: Deriving the aggregate demand curve

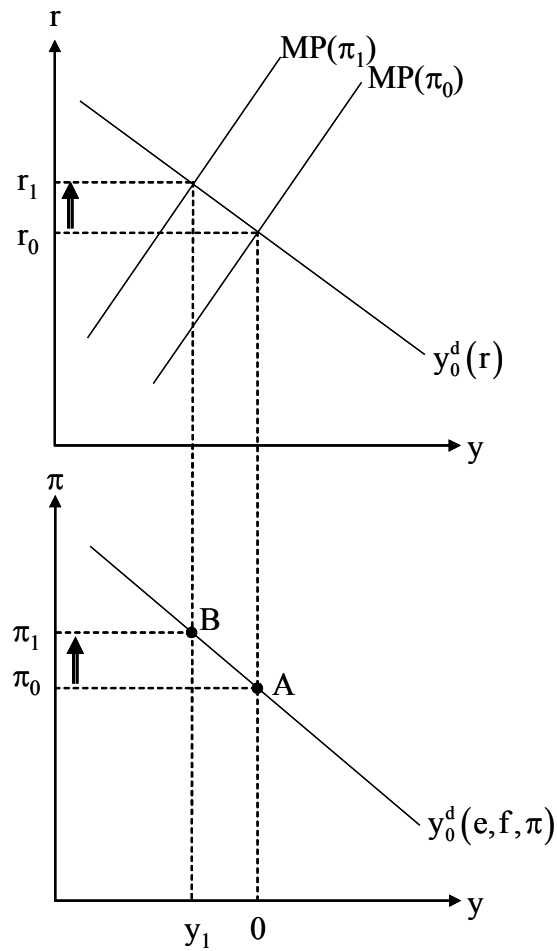

We can derive the $y(\pi)$ -curve algebraically by inserting the Taylor rule (30) into the aggregate demand curve:

$$(31) \quad y^d(\pi) = \frac{(a - br_0) + be\pi_0}{1 + bf} - \frac{be}{1 + bf}\pi + \frac{1}{1 + bf}\varepsilon_1$$

As the parameters b, e and f are positive the $y^d(\pi)$ -curve has a negative slope. Inserting equation (31) into the Phillips-curve leads to the following expression for the output gap:

$$(32) \quad y = -\frac{be}{1 + bf + dbe}\varepsilon_2 + \frac{1}{1 + bf + dbe}\varepsilon_1$$

Inserting equation (32) into the Phillips curve determines the inflation rate:

$$(33) \quad \pi = \pi_0 + \frac{d}{1+bf+dbe} \varepsilon_1 + \frac{1+bf}{1+bf+dbe} \varepsilon_2$$

If we insert equations (32) and (33) into the Taylor-rule we directly see how monetary policy adjusts its instrument in response to shocks. The Taylor rule is given by:

$$(34) \quad r^{\text{Taylor}} = r_0 + \frac{ed+f}{1+bf+bed} \varepsilon_1 + \frac{e}{1+bf+dbe} \varepsilon_2$$

As can be seen from equation (34) the Taylor rule depends equally on the structural parameters of the model b and d as well as on the Taylor rule parameters e and f . Hence one should be cautious in interpreting estimated Taylor rules only in terms of preferences. Even central banks that have identical preferences can exhibit a distinct interest rate setting behaviour if the structural parameters of the economy b and d are different. The variances of the inflation rate and the output gap are given by the following two equations:

$$(35) \quad \text{Var}[y] = \left(\frac{1}{1+bf+dbe} \right)^2 \text{Var}[\varepsilon_1] + \left(\frac{be}{1+bf+dbe} \right)^2 \text{Var}[\varepsilon_2]$$

$$(36) \quad \text{Var}[\pi] = \left(\frac{d}{1+bf+dbe} \right)^2 \text{Var}[\varepsilon_1] + \left(\frac{1+bf}{1+bf+dbe} \right)^2 \text{Var}[\varepsilon_2]$$

If the central bank conducts monetary policy according to a simple rule the variances of y and π additionally depend on demand shocks ε_1 . Hence the suboptimal response to demand shocks induces an extra loss compared to a strategy when monetary policy is conducted under discretion (see (27) and (28)).

3.4.1 *Minimum requirements for reasonable rules*

If we assume that a policymaker behaves rational, in the sense that he prefers less loss compared to more, we have a tool at hand by which we can restrict the set of reasonable rules. Every (reasonable) rule has to meet the requirement that the loss inflicted on policymakers is smaller than the loss implied by a policy rule that leaves real interest rates unchanged. We referred to this benchmark as the ‘unregulated system’ (See section 3.2). For the set of ‘reasonable’ rules we postulate that the following inequality has to hold:

$$(37) \quad L^{\text{unregulated}} > L^{\text{Simple}}$$

Hence monetary policy rules are only stabilizing if the loss inflicted on monetary policymakers is smaller compared to a scenario in which monetary policy is conducted by keeping real interest rates constantly equal to their long run equilibrium value.

3.4.1.1 Loss implied by the unregulated system

As supply and demand shocks are uncorrelated by definition we can evaluate the loss generated by each shock in term separately. If we assume that the economy is hit by a demand shock the loss $L_{\varepsilon_1}^{\text{unregulated}}$ is given by equation (38). It illustrates that a demand shock has a twofold impact on the unregulated system. On the one hand it influences the output gap directly over the aggregate demand relationship. On the other hand it influences $L_{\varepsilon_1}^{\text{unregulated}}$ indirectly as the state of the business cycle is the driving force of the inflation rate in the BMW-model.

$$(38) \quad L_{\varepsilon_1}^{\text{unregulated}} = d^2 \text{Var}(\varepsilon_1) + \lambda \text{Var}(\varepsilon_1)$$

The loss $L_{\varepsilon_2}^{\text{unregulated}}$ generated by supply shocks is given by equation (39). The supply shock has a direct impact on the variance of the inflation rate. As the real interest rate is kept at its long run level r_0 the value of the output gap will be equal to null. Accordingly the supply shock does not induce an output loss in the unregulated system.

$$(39) \quad L_{\varepsilon_2}^{\text{unregulated}} = \text{Var}(\varepsilon_2)$$

3.4.1.2 Loss implied by the regulated system: deriving minimum requirements for reasonable rules

Equipped with the unregulated system as a reference point we can state the following proposition as a minimum requirement for reasonable rules:

$$(40) \quad L^{\text{unregulated}} > L^{\text{Simple}}$$

As supply and demand shocks are uncorrelated by definition we evaluate the restrictions imposed by equation (40) separately for each type of shock.

If the economy is hit by a demand shock it has to hold that:

$$(41) \quad L_{\varepsilon_1}^{\text{Simple}} < L_{\varepsilon_1}^{\text{unregulated}}$$

Inserting the corresponding expressions results in:

$$(42) \quad d^2 \cdot \text{Var}[\varepsilon_1] + \lambda \cdot \text{Var}[\varepsilon_1] > \left(\frac{d}{1 + bf + dbe} \right)^2 \text{Var}[\varepsilon_1] + \lambda \left(\frac{1}{1 + bf + dbe} \right)^2 \text{Var}[\varepsilon_1]$$

If we simplify inequality (42) we arrive at the following two restrictions:

$$(43) \quad e > -\frac{1}{d} \cdot f$$

$$(44) \quad e < -\frac{2}{bd} - \frac{1}{d} \cdot f$$

As the economy is hit by a supply shock it has to hold that:

$$(45) \quad L_{\varepsilon_2}^{\text{simple}} < L_{\varepsilon_2}^{\text{unregulated}}$$

$$(46) \quad \text{Var}[\varepsilon_2] > \left(\frac{1 + bf}{1 + bf + dbe} \right)^2 \text{Var}[\varepsilon_2] + \lambda \left(\frac{be}{1 + bf + dbe} \right)^2 \text{Var}[\varepsilon_2]$$

Note that in the regulated system the supply shock does not only influence inflation but also the output gap as monetary policy uses the real interest rate to choose its preferred stabilization mix.

If we simplify the expression and solve again for e we obtain the following two restrictions:

$$(47) \quad e \geq 0$$

$$(48) \quad e < \frac{2d}{b(\lambda - d^2)} + \frac{2db}{b(\lambda - d^2)} \cdot f$$

Restriction (47) reflects the Taylor-principle. A rise in the inflation rate will lead to an increase in real interest rates. Plotting the binding restrictions generates Figure 15.⁷

Figure 15: Regions of stabilizing and destabilizing rules

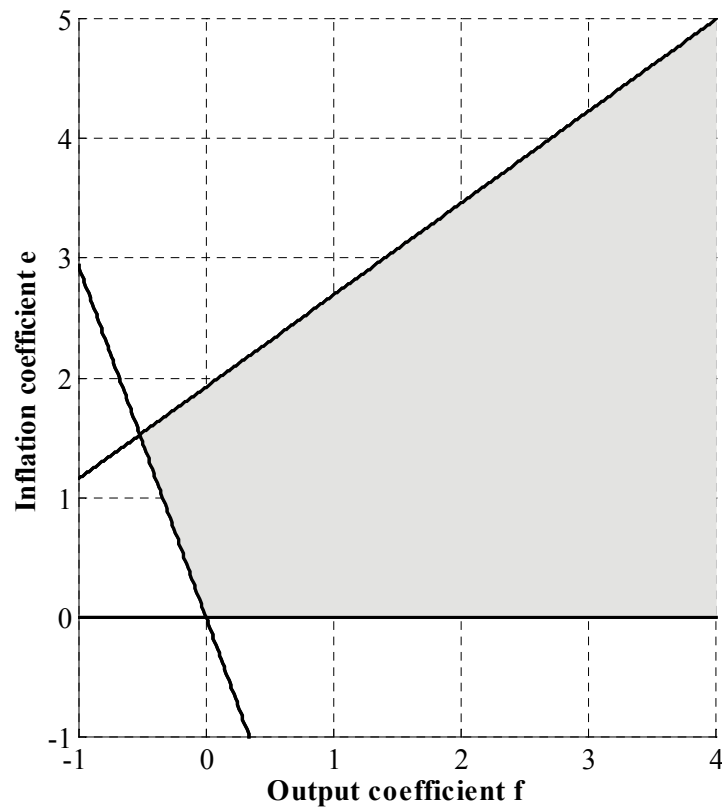

An intuition to Figure 15 can be given by looking at the slope of the aggregate demand curve $y(\pi)$ which is given by:

$$(49) \quad m = -\frac{be}{1 + bf}$$

⁷ We calibrated the model as stated in footnote 8. Additionally, we assumed the preference parameter λ to take a value of 0.5.

Increasing values of e (f) lead to a steepening (flatening) of the aggregate demand curve until it becomes vertical (horizontal) in the limit. Hence as long as the ratio of e and f do not exceed a certain threshold supply and demand shocks are not amplified but damped.

3.4.2 Simple interest rate rules: demand shocks

In what follows we implicitly assume that we restrict our attention to the set of stabilizing rules. Assume that the economy is hit by a demand shock. With a Taylor rule we get different outcomes for monetary policy compared to the discretionary case. If we set the supply shock ε_2 equal to null in equations (32), (33) and (34) the economy is described by the following set of equations:

$$(50) \quad y = \frac{1}{1 + bf + dbe} \varepsilon_1$$

$$(51) \quad \pi = \pi_0 + \frac{d}{1 + bf + dbe} \varepsilon_1$$

$$(52) \quad r^{\text{Taylor}} = \frac{a}{b} + \frac{ed - f}{1 + bf + dbe} \varepsilon_1$$

Given the expressions at hand the difference between optimal and suboptimal behaviour clearly prevails in succession of a demand shock. The fact that policymakers do not respond adequately results in deviations of the output gap and the inflation rate from their target values. If monetary policy is conducted according to the optimal monetary policy rule (13) demand shocks can be totally undone. Hence simple rules impose an additional loss compared to optimal behaviour. Consequently simple rules should be interpreted as a rule of thumb that are able to guide monetary policy if there exists uncertainty on the structure of the economy. Figure 16 illustrates the losses induced by the demand shock. Note that an increase in the Taylor-rule coefficients e and f comprises a higher degree of demand shock stabilization.

Starting with a negative demand shock the aggregate demand curve shifts from y_0^d to y_1^d . In response to the decrease of output from 0 to y' the central bank lowers- by moving along the $MP(\pi_0)$ -line real interest rates from r_0 to r' . As the inflation rate initially remains unchanged the new $y_1^d(\pi)$ curve is determined as follows. It has to go through a point, which is a combination of the new output gap y' and an unchanged inflation rate π_0 . With a negative output gap the

Phillips curve as the inflation determining relationship tells us that the inflation rate will start to fall. The new equilibrium is the intersection of the shifted $y_1^d(\pi)$ line with the unchanged Phillips curve. It is characterised by a somewhat dampened output decline that is due to the fact that the central bank reduces real rates because of the lower inflation rate. Thus, we also get a downward shift of the MP line so that it intersects with the $y_1^d(r)$ line at the same output level as the intersection of the $y_1^d(\pi)$ line with the Phillips curve.

Figure 16: Simple rules and demand shocks

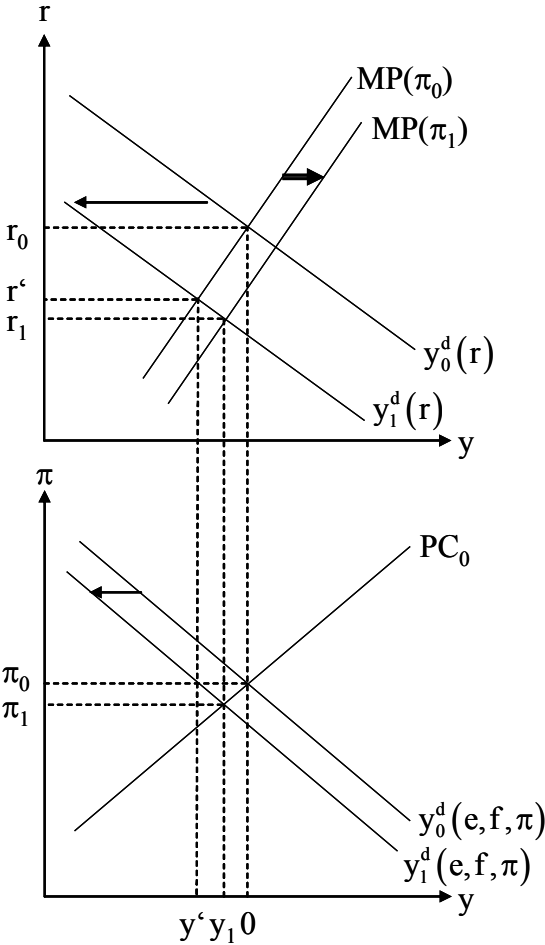

3.4.3 Simple interest rate rules: supply shocks

Assume that the economy is hit by a supply shock. Accordingly if we set ϵ_1 equal to null in equations (32), (33) and (34) the economy will be described by the following set of equations:

$$(53) \quad y = -\frac{be}{1 + bf + dbe} \epsilon_2$$

$$(54) \quad \pi = \pi_0 + \frac{1 + bf}{1 + bf + dbe} \varepsilon_2$$

$$(55) \quad r^{\text{Taylor}} = r_0 + \frac{e(1 + bf) - fbe}{1 + bf + dbe} \varepsilon_2$$

To give some intuition to equations (53)-(55) we take a look at the graphical analysis.

Figure 17: Taylor rule and supply shocks

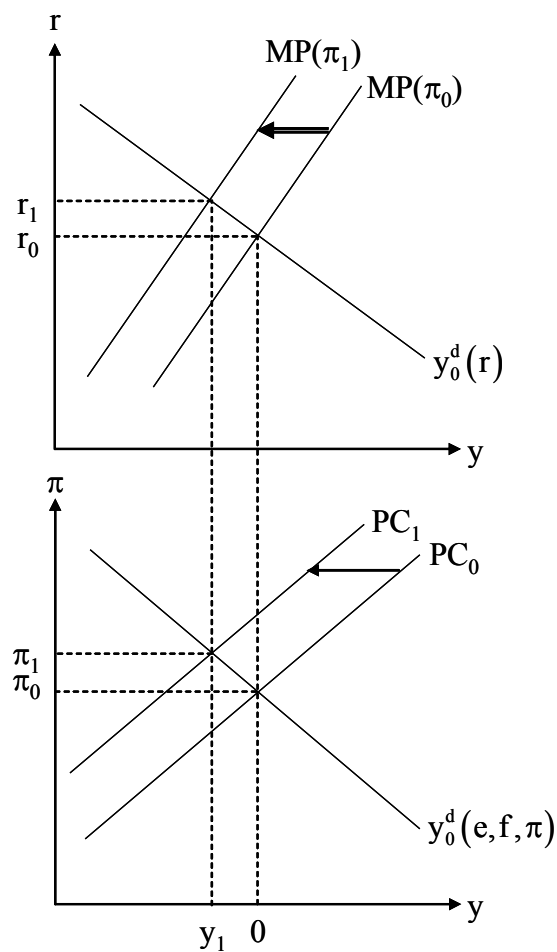

For the discussion of a supply shock we start the analysis in the lower panel of Figure 17. Given the initial supply shock the Phillips curve is shifted upwards which increases inflation. Because of the higher inflation rate the Taylor rule line in the upper panel is also shifted upwards from $MP(\pi_0)$ to $MP(\pi_1)$. The increase in real interest rates from r_0 to r_1 produces a negative output gap y_1 which corresponds to the inflation rate π_0 .

The degree of output and inflation stabilization depends on the parameters e and f of the Taylor rule. This can be seen analytically as follows. Solving the $y(\pi)$ -curve for π results in the following $\pi(y)$ -curve:

$$(56) \quad \pi = \pi_0 - \frac{1+bf}{be} y + \frac{1}{be} \varepsilon_1$$

The slope of the $\pi(y)$ -line is given by:

$$(57) \quad m = -\frac{1+bf}{be}$$

Figure 18: Simple rules and supply shocks

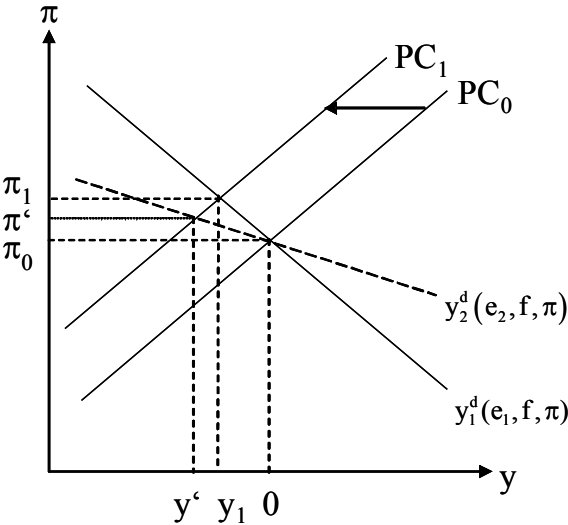

Equation (57) depicts that an increasing degree of aggressiveness e with which the central bank reacts on inflation flattens the slope of the y^d -curve (see Figure 18 where e rises from e_1 to e_2). Accordingly, the central bank opts to keep the inflation rate close to the inflation target at the cost of a relatively large output gap ((π', y') instead of (π_1, y_1)). In contrast to this, if f increases the central bank will prefer to keep the output gap near null at the cost of a relatively large inflation gap. This clearly underlines that the actual outcomes in terms of the inflation and output gaps crucially depends on the concrete coefficients e and f of the Taylor rule.

3.5 A welfare theoretic comparison between optimal and simple rules

The concept of the efficiency frontier equips us with a tool at hand by which we can evaluate a welfare comparison between simple and optimal rules.

If we plot for each preference type λ the variances of the inflation rate and the output gap in a $(\text{Var}(y); \text{Var}(\pi - \pi_0))$ -space we arrive at the following efficiency frontier.⁸

Figure 19: The Efficiency Frontier

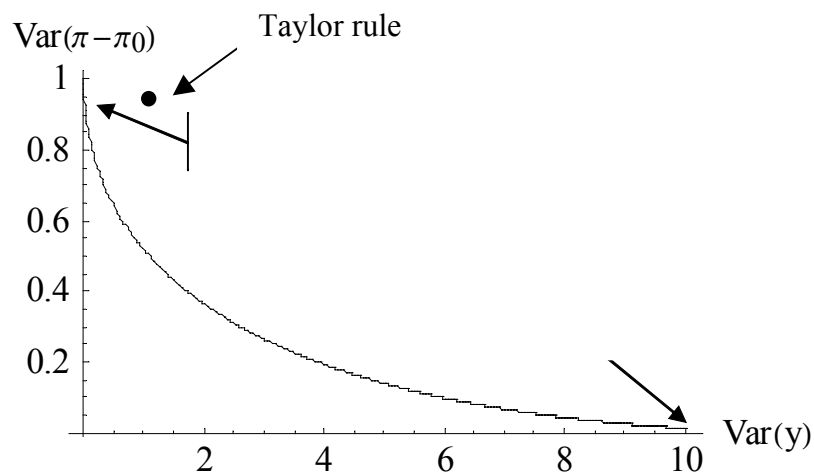

Analytically we can derive the efficiency frontier by taking the ratio of equation (27) and (28) and solving the resulting expression for $\text{Var}(\pi - \pi_0)$ which yields:

$$(58) \quad \text{Var}(\pi - \pi_0) = \left(\frac{\lambda}{d}\right)^2 \cdot \text{Var}(y).$$

Hence an increasing preference for output stabilization results in an increasing variance of the inflation rate. We equally see that the slope of the efficiency frontier depends on the slope of the Phillips curve. This implies that given a relatively flat Phillips curve reductions in the inflation variability are associated with relatively large increases in the output variability as monetary policy has to make rather rigorous use of its monetary policy instrument to control the variability of the inflation rate.

The efficiency frontier divides the plane in two regions; All points that lie below the line are not feasible. All lines that lie above the line are feasible but not efficient. The line itself represents all feasible and efficient combinations of variances of the inflation gap and the output gap. Figure 19 clearly depicts that the Taylor rule is inferior compared to optimal behaviour. Optimal rules are available that generate less variance of the inflation gap and less variance of the output gap. As already stated, assuming that the structure of the economy is common knowledge the case for simple rules is somewhat weak. Nevertheless if policymakers face an environment where they have to choose between competing models of the economy simple rules in comparison to optimal rules typically exhibit robustness. Following McCallum [1988] a policy rule is robust if it is not only able to perform well in the model for which it has been fitted but also well in other models. Therefore simple rules should not be ruled out as an interesting option as they provide a useful compass in an uncertain environment.

The convex shape of the efficiency frontier results from the trade-off induced by supply shocks. A lower variance of the inflation gap (output gap) can only be realized at the cost of an increasing variance of the output gap (inflation gap). Additionally given that the second derivative of the curve is positive, moving from the centre to the fringes goes hand in hand with steadily increasing ‘marginal rates of substitutions’. In other words, one can only reduce the squared inflation gap (output gap) at the cost of over proportionally increasing output gaps (inflation gaps).

An alternative welfare comparison between simple and optimal rules is given in Figure 20. Note, that again compared with inflation targeting (discretionary policy guided by a loss function) a simple rule leads to a sub-optimal outcome.

Optimal monetary policy would choose the tangency point of the inner ellipse with the Phillips curve. As monetary policy is conducted by a Taylor rule the final outcome will be the intersection of the Phillips curve PC_1 and the aggregate demand curve $y_0^d(e, f, \pi)$. The loss attached to this outcome is given by the outer isoquant of the loss function. The distance between the two isoquants indicates the welfare loss implied by sticking to a simple rule.

⁸ For these and further (see e.g. Figure 15) calculations we calibrated our model as follows: $b = 0.4$, $d = 0.34$. These coefficients were estimated by Orphanides and Wieland [1999] for the Euro area. The variances of the shocks are standardised to unity.

Figure 20: Supply shocks: Optimal and simple rules: a welfare comparison

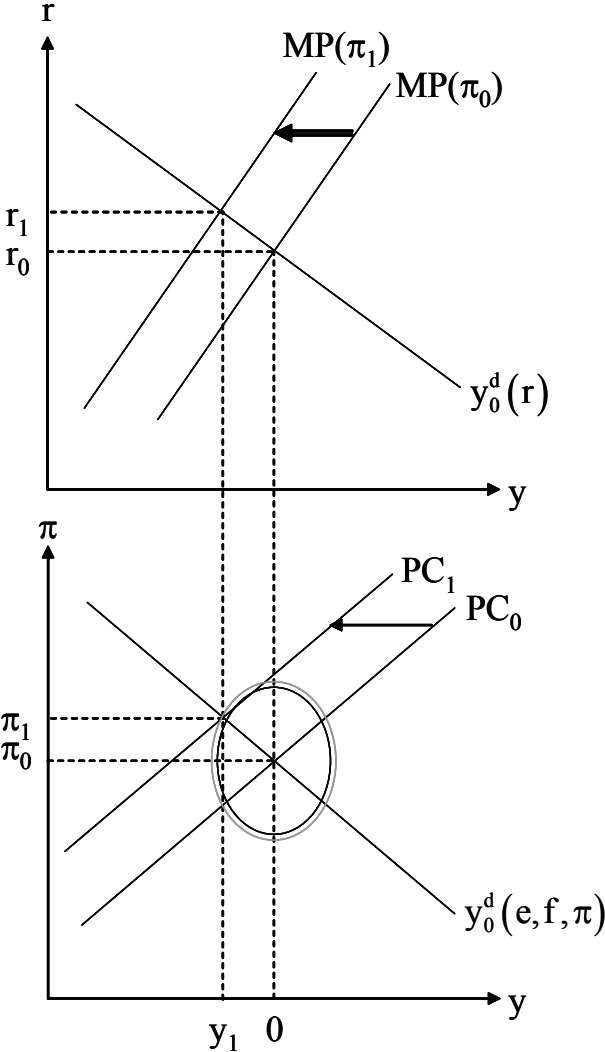

3.6 The inflation bias in monetary policy

So far we have assumed that the central bank follows a loss function which is compatible with an output gap of zero. In this context, we have discussed the Taylor rule as a “heuristic” or “rule of thumb” which allows fast and successful decision making even if the central bank is confronted with diverse kinds of uncertainties like, e.g. Brainard uncertainty, model uncertainty or data uncertainty.

However, in much of the literature the term “rule” is also used with a somewhat different meaning. Based on the seminal model by Barro and Gordon [1983], the purpose of a “rule” is not facilitating the decision making of a central bank under pure discretion but rather to limit this

discretion in order to avoid the problem of an inflation bias. For a discussion of these issues we have to modify our loss function as follows:

$$(59) \quad L = (\pi - \pi^T)^2 + \lambda(y - k)^2 \quad \text{with } k > 0$$

By introducing the parameter k , the central bank targets an output gap that is above zero. This could be justified by monopolistic distortions in goods and labour markets which keep potential output below an efficient level. Compared with the loss function that we have used so far, the bliss point $(k; \pi^T)$ has moved to the right.

In line with the Barro/Gordon model the game between the private sector and the central bank can be modelled as follows. The private sector builds its inflation expectations which enter the goods and labour market contracts. Observing private expectations the central bank chooses an inflation rate that minimizes its loss function.

3.6.1 *Reaction function of the central bank*

If we insert the Phillips curve in the loss function, we get the following optimisation problem for the central bank:

$$(60) \quad L = (\pi - \pi^T)^2 + \lambda \left(\frac{1}{d} \pi - \frac{1}{d} \pi^e - k \right)^2$$

Minimizing the loss function L with respect to the inflation rate yields:

$$(61) \quad \pi^{\text{opt}}(\pi^e) = \frac{\lambda}{\lambda + d^2} \pi^e + \frac{d^2}{\lambda + d^2} \pi^T + \frac{\lambda d}{\lambda + d^2} k$$

Thus, the optimum inflation rate depends on inflation expectations, the inflation target, and the parameter k . Inserting the optimal inflation rate into the Phillips curve relationship leads to the following expression for the output gap:

$$(62) \quad y^{\text{opt}}(\pi^e) = -\frac{d}{\lambda + d^2} (\pi^e - \pi^T) + \frac{\lambda}{\lambda + d^2} k$$

If we solve the Phillips curve for π^e and insert it in equation (62) we can derive a relationship between the output gap (y) and the optimum inflation rate π^{opt} of the central bank. This rate is identical with the actual inflation rate since the central bank can control inflation perfectly.

$$(63) \quad \pi = \pi^T + \frac{\lambda}{d}k - \frac{\lambda}{d}y$$

Figure 21: The Bliss Point and Optimal Monetary Policy

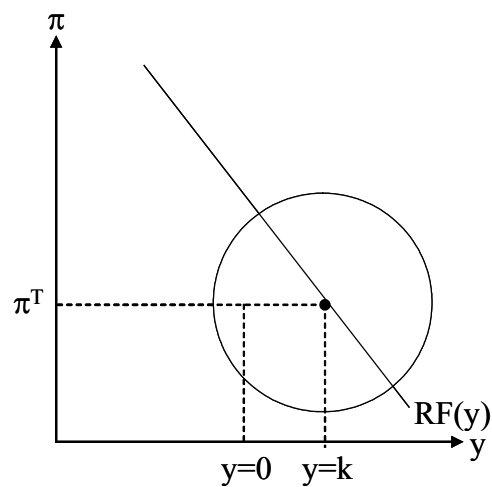

We can see in Figure 21 that this relationship is a downward sloping line in the $(\pi; y)$ -space which goes through the bliss point of the loss function. It represents the *reaction function* of the central bank. For any given value of private expectations and thus any given location of the Phillips curve it shows the inflation rate which produces a minimum loss for the central bank.

3.6.2 *Surprise inflation, rational expectations and commitment*

Hence if we want to make predictions on the final monetary policy outcome we have to specify the way in which the private sector builds its expectations. Following Barro/Gordon we can now distinguish between three different outcomes:

- Discretion and surprise inflation: $\pi^e = \pi^T < \pi$
- Discretion and rational expectations: $\pi^e = \pi^{\text{opt}} = \pi$
- Commitment solution: $\pi^e = \pi^T = \pi$

Surprise Inflation

As a starting point we assume that the central bank announces an inflation target of π^T and that the public believes in the announcement. Thus, expectations of the private sector are given by: $\pi^e = \pi^T$. Based on these expectations the central bank chooses the optimal inflation rate π^s according to its reaction function (63) as follows:

$$(64) \quad \pi^s = \pi^T + \frac{\lambda d}{\lambda + d^2} k$$

It is obvious that this rate exceeds the announced inflation target π^T . The second term on the right hand side of equation (64) denotes the inflation bias under surprise inflation. The output gap is:

$$(65) \quad y^s = \frac{\lambda}{\lambda + d^2} k$$

Due to the surprise inflation it is positive. Figure 22 shows this combination of the output gap y^s and inflation π^s and the corresponding loss circle.

Figure 22: Surprise Inflation under discretionary policy

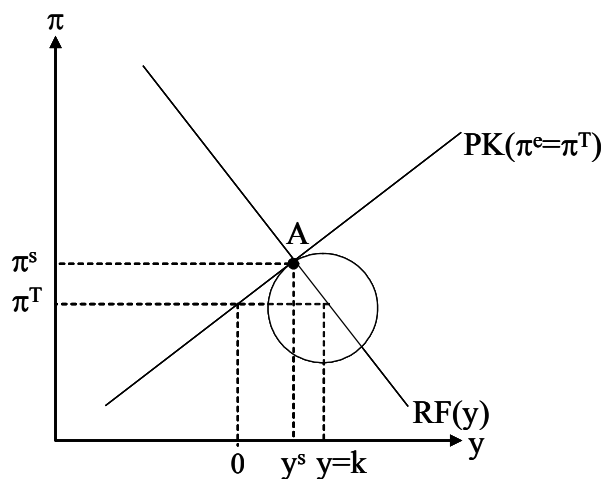

Discretion and rational expectations

With pure discretion of the central bank the outcome of surprise inflation is not very realistic. Let us now assume that the private sector forms its expectations rationally. This means that the

optimal value $\pi^{\text{opt}}(\pi^e)$ is used for forming expectations on π^e and that the private sector minimizes the following loss function:

$$(66) \quad L = \left(\pi(\pi^e) - \pi^e \right)^2$$

The first order condition is given by:

$$(67) \quad \pi^{\text{opt}}(\pi^e) = \pi^e$$

Equating $\pi^{\text{opt}}(\pi^e)$ with π^e yields:

$$(68) \quad \pi^e = \frac{\lambda}{\lambda + d^2} \pi^e + \frac{d^2}{\lambda + d^2} \pi^T + \frac{\lambda d}{\lambda + d^2} k$$

Solving for π^e we obtain the following rational expectations equilibrium for the inflation rate.

$$(69) \quad \pi^{\text{opt}} = \pi^T + \frac{\lambda}{d} k$$

Figure 23: Rational expectations under discretionary policy

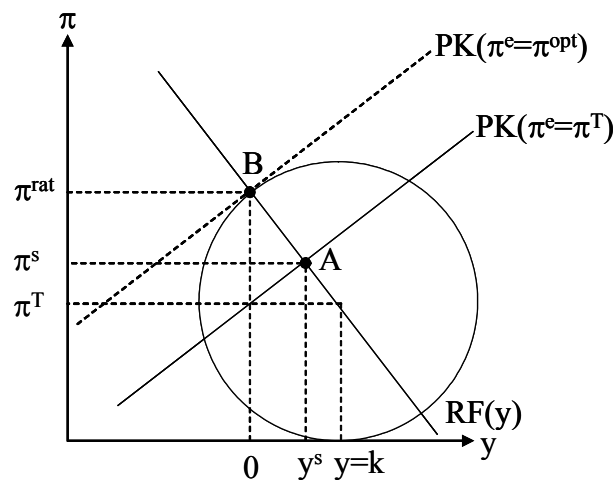

This rate lies again above the inflation target π^T and also above inflation under surprise inflation π^S as given by equation (64). As π^e equals π , the Phillips curve shows that the output gap is zero.

Figure 23 depicts the rational expectations solution. Compared to surprise inflation this solution is clearly inferior since it leads to a higher inflation rate without a positive gain in output. The loss circle lies outside the loss circle attached to the solution with surprise inflation.

Commitment to a rule

So far we have seen that an inflationary bias is inherently nested in the rational expectations solution under discretion. Even if the central bank announces an inflation target, rational market participants will realise that it has a strong incentive to renege on its announcement. In order to avoid the high negative social loss under discretion, a mechanism is required that credibly commits the central bank to a socially optimal inflation target. We assume that such a rule can be designed and that the private sector expects now always the inflation target ($\pi^e = \pi^T$) which by assumption becomes the actual inflation rate that equals the inflation target:

$$(70) \quad \pi^e = \pi^T = \pi$$

The output gap is again zero.

Figure 24: Rational expectations under commitment

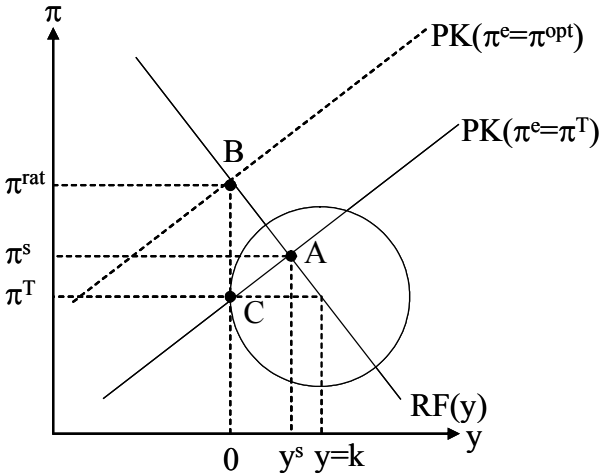

Comparison of the three solutions

As we can see from Figure 24 the first-best outcome is surprise inflation. Discretion turns out to be the worst solution as the public anticipates the higher inflation rate without generating a positive output effect. The commitment solution is second best since it allows to reach the inflation target but monetary policy is unable to come closer to its bliss point combination. These

results are also shown by the concrete values of the social loss under the three different scenarios. It becomes also obvious that the whole problem of the inflation bias is due to the rather arbitrary assumption of $k > 0$. With $k = 0$ the central bank has no incentive to deviate from an announced inflation target and the social loss is always zero.

Discretion: Surprise Inflation $\pi^e = \pi^T < \pi$

$$(71) \quad L^S = \lambda k^2 \cdot \frac{d^2}{\lambda + d^2}$$

Discretion: Rational Expectations $\pi^e = \pi^{opt} = \pi$

$$(72) \quad L^{rat} = \lambda k^2 + \frac{\lambda}{d^2} k^2$$

Commitment Solution $\pi^e = \pi^T = \pi$

$$(73) \quad L^C = \lambda k^2$$

3.6.3 The Barro/Gordon model in the BMW framework

Thus, the BMW framework can be easily extended for an analysis of the issues that are related to the Barro/Gordon model. While have not made explicit the adjustment of real interest rates that is required to generate the specific values of inflation and output gap, our approach has the advantage that it discusses surprise inflation with a framework that also includes the demand side of the economy. As a consequence, one could show that a rule does not prevent an optimum reaction of the central to demand shocks. As demonstrated in Figure 24, the central bank is still able to cope with such a disturbance while remaining on an unchanged position on the Phillips curve. One could also discuss supply shocks within our framework. They would show that – depending on the size of the shock – the outcome under discretion with rational expectations could be better than a commitment to a rule which requires a constant inflation rate.

4 The BMW model for an analysis of monetary policy in an open economy

To present the basic idea of the problem of the monetary policy authority in an open economy, we use a very simple comparative-static model where aggregate demand (y) is described by

$$(74) \quad y = a - br + c\Delta q + \varepsilon_1,$$

with the real interest rate (r), the change in the real exchange rate (Δq)⁹, positive structural parameters of the economy (a , b and c), and a random demand shock ε_1 . The parameter a reflects the fact that there may be positive neutral values of r .¹⁰ The interest rate elasticity b and the exchange rate elasticity c take values smaller than one.

For the determination of the inflation rate we will differentiate between two polar cases. In the first case which represents a *long-term perspective* especially for a small economy the domestic inflation rate is completely determined by the foreign rate of inflation expressed in domestic currency terms (π^f), and hence by purchasing power parity (PPP):

$$(75) \quad \pi = \pi^f = \pi^* + \Delta s.$$

Because of the long-term perspective we do not include a shock term. Thus, the domestic inflation rate equals the foreign inflation rate (π^*) plus the depreciation of the domestic currency (Δs). In other words, we assume that the real exchange rate $\Delta q = \Delta s + \pi^* - \pi$ remains constant.

In the second case we adopt a *short-term perspective*. We assume that companies follow the strategy of *pricing-to-market* so that they leave prices unchanged in each local market even if the exchange rate changes. As a consequence, changes in the exchange rate affect mainly the profits of enterprises. One can regard this as an *open-economy balance-sheet channel* where changes in profitability are the main lever by which the exchange rate affects aggregate demand. In this case the Phillips curve is identical with the domestic version (see Chapter 3.1):

⁹ As is usually done in the literature, $\Delta q > 0$ is a real depreciation of the domestic currency.

¹⁰ One could think of the neutral Wicksellian rate of interest (r_0) that is compatible with an output gap of zero and thus, full employment. In this case r_0 would be equal to a/b . Alternatively, equation (74) could be written as $y = -b(r - r_0) + c\Delta q + \varepsilon_1$

$$(76) \quad \pi = \pi_0 + d y + \varepsilon_2 .$$

Of course, it would be interesting to discuss an intermediate case where the real exchange has an impact on the inflation rate. But using an equation like

$$(77) \quad \pi = (1 - e) \pi^d + e \pi^f = \pi_0 + d y + e \Delta q + \varepsilon_2$$

would make the presentation very difficult, above all the graphical analysis. According to (77) the overall inflation rate would be calculated as a weighted (by the factor e) average of domestic inflation π^d (determined by (76)) and imported inflation π^f (determined by (75)).

As a further ingredient of open economy macro models we have to take into account the behaviour of international financial markets' participants which is in general described by the uncovered interest parity condition (UIP)

$$(78) \quad \Delta s + \alpha = i - i^* .$$

According to equation (78) the differential between domestic (i) and foreign (i^*) nominal interest rates have to equal the rate of nominal depreciation (Δs) and a stochastic risk premium (α).

The traditional literature on monetary policy in open economies distinguishes between two "pure" exchange rate regimes: independently floating rates (Chapters 4.1 and 4.2) and absolutely fixed rates (Chapter 4.3). The fundamental difference of each regime lies in the way of how central banks set their basic operating target, the short-term interest rates. Additionally, we present the strategy of managed floating as an intermediate regime between the two polar systems (Chapter 4.4). Under this setting, central banks simultaneously control the short-term interest rate and the exchange rate.

4.1 Monetary policy under discretion – the optimal interest rate rule under independently floating rates

For a discussion of monetary policy under independently floating exchange rates it is important to decide how a flexible exchange rate is determined. In the following we discuss three different variants:

- PPP and UIP hold simultaneously (4.1.1),
- UIP holds, but deviations from PPP are possible (4.1.2),
- the exchange rate is a pure random variable (4.1.3).

4.1.1 Monetary policy under flexible rates if PPP and UIP hold simultaneously (long-term scenario)

As it is well-known that PPP does not hold in the short-term, the first case can mainly be regarded as a long-term perspective. If PPP is strictly fulfilled,

$$(79) \quad \Delta s = \pi - \pi^*,$$

then changes in the real exchange rate do not occur:

$$(80) \quad \Delta q = \Delta s + \pi^* - \pi = 0.$$

For the sake of simplicity we assume a UIP condition that is perfectly fulfilled and thus, without a risk premium:

$$(81) \quad \Delta s = i - i^*$$

which can be transformed with the help of the Fisher equation for the domestic interest rate

$$(82) \quad i = r + \pi$$

and the foreign interest rate

$$(83) \quad i^* = r^* + \pi^*,$$

and equation (79) into

$$(84) \quad r = r^* .$$

Thus, one can see that in a world where PPP and UIP hold simultaneously there is no room for an independent real interest rate policy, even under independently floating rates. As the domestic real interest rate has to equal the real interest rate of the foreign (world) economy, the central bank cannot target aggregate demand by means of the real rate.

This does not imply that monetary policy is completely powerless. As equation (82) shows, the central bank can achieve a given real rate (which is determined according to equation (84) by the foreign real interest rate) with different nominal interest rates. Changing nominal interest rates in turn go along with varying rates of nominal depreciation or appreciation of the domestic currency Δs , for a given nominal foreign interest rate (see equation (81)). If i^* and r^* are exogenous, then π^* is exogenous as well, and the chosen (long-run) nominal interest rate finally determines via the related Δs and the PPP equation (80) the (long-run) domestic inflation rate π .

In sum, the long-term scenario with valid UIP *and* valid PPP leads to the conclusion that monetary policy has

- no real interest rate autonomy for targeting aggregate demand, but
- a nominal interest rate autonomy for targeting the inflation rate.

This comes rather close to the vision of the proponents of flexible rates in the 1960s who argued that this arrangement would allow each country an autonomous choice of its inflation rate (see Johnson [1972]). It can be regarded as an open-economy version of the *classical dichotomy* according to which monetary policy can affect nominal variables only without having an impact on real variables.

4.1.2 Monetary policy under flexible rates if UIP holds but not PPP (short-run scenario)

Thus, in order to be able to attribute a fully autonomous role to the monetary policy maker, we need to assume that the existence of price rigidities makes deviations from PPP possible, and thus facilitate real appreciations and real depreciations. This assumption corresponds with

empirical observation that in the short-run the real exchange is rather unstable and mainly determined by the nominal exchange rate (see Figure 25).

Figure 25: Nominal and real exchange rate of the euro area

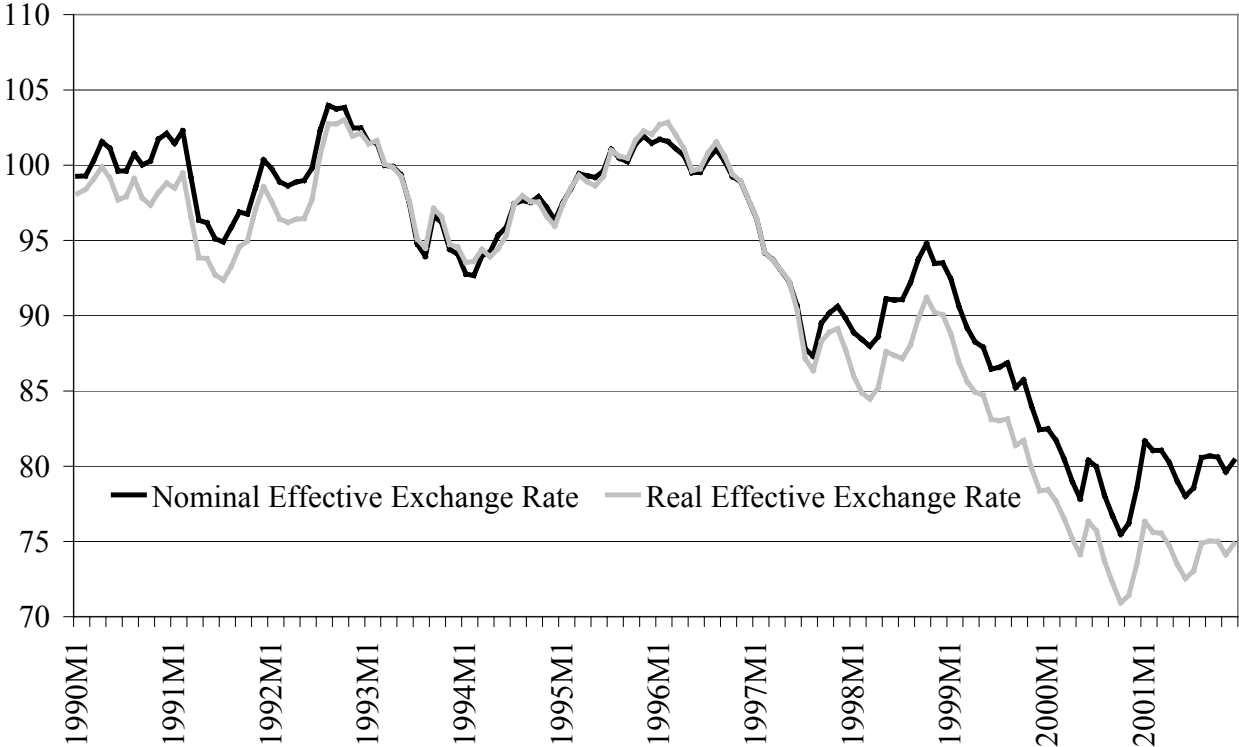

Source: IMF, International Financial Statistics

As before, UIP is assumed to be valid, but we allow for the possibility of shocks that are measured by the risk premium α . Moreover, shocks originating in the foreign economy are captured by variations of the foreign real interest rate r^* .

If we assume optimal behaviour of the central bank and full discretion of the decision makers the central bank’s problem is to set and to adjust its operating target r so that a loss function

$$(85) \quad L = (\pi - \pi_0)^2 + \lambda y^2$$

similar to that in a closed economy (see equation (9)) is minimised. In a first step we assume that the central bank’s only instrument is the interest rate r . The optimal reaction of the central bank in response to shocks can be derived by minimising (85) subject to (76) which yields an optimal value for y :

$$(86) \quad y = -\frac{d}{d^2 + \lambda} \varepsilon_2.$$

Inserting (86) into (74) and solving for r then leads to the optimal policy rule of the central bank in terms of the real interest rate:

$$(87) \quad r^{\text{opt}} = \frac{a}{b} + \frac{1}{b} \varepsilon_1 + \frac{d}{b(d^2 + \lambda)} \varepsilon_2 + \frac{c}{b} \Delta q.$$

Accordingly, quite similar to a situation in a closed economy, the central bank adjusts its interest rates each time a demand or a supply shock hits the economy. For the case of flexible rates where UIP holds the real exchange rate in (87) can be substituted as follows. The UIP condition with a risk premium

$$(88) \quad \Delta s + \alpha = i - i^*$$

can be transformed via equations (82), (83) and

$$(89) \quad \Delta q = \Delta s + \pi^* - \pi \neq 0$$

into its real equivalent

$$(90) \quad \Delta q + \alpha = r - r^*.$$

Inserting (90) into (87) yields

$$(91) \quad r^{\text{opt}} = \frac{a}{b} + \frac{1}{b} \varepsilon_1 + \frac{d}{b(d^2 + \lambda)} \varepsilon_2 + \frac{c}{b} (r - r^* - \alpha)$$

which can be solved for r (assuming that $r = r^{\text{opt}}$)

$$(92) \quad r^{\text{opt}} = \frac{a}{b-c} + \frac{1}{b-c} \varepsilon_1 + \frac{d}{(b-c)(d^2 + \lambda)} \varepsilon_2 - \frac{c}{b-c} (r^* + \alpha).$$

Equation (92) provides the optimal real interest rate rule for a central bank in a system of independently floating exchange rates where UIP holds (with the possibility of risk premium shocks) while PPP does not hold. It shows that real interest rate has to respond to the following types of shocks:

- domestic shocks: supply and demand shocks,
- international shocks: the shock of a change in the foreign real interest rate and the shock of a change in the risk premium.

Since r^{opt} can be set autonomously, the central bank can target the real interest rate in the open economy in the same way as in a closed economy. Given this central bank behaviour, we obtain a solution for the output gap by first, replacing Δq in equation (74) with $r - r^* - \alpha$ (see equation (90)) and then, inserting equation (92) into the resulting expression. This leads to

$$(93) \quad y = -\frac{d}{d^2 + \lambda} \varepsilon_2.$$

By substituting this solution for y into the Phillips curve (equation (76)) we finally get the solution for π :

$$(94) \quad \pi = \pi_0 + \frac{\lambda}{d^2 + \lambda} \varepsilon_2.$$

Equations (93) and (94) are identical with the solutions of the endogenous variables in the discretionary case of the closed economy model (see equations (25) and (26)). Thus, the central bank is able to fully compensate the effects of a demand shock (ε_1) by adjusting its interest rates. In the presence of supply shocks (ε_2), however, the central bank conducts an accommodating policy by distributing the effects of the shock between the final targets y and π according its preferences γ . Additionally, the open economy specific shocks of the risk premium α and the foreign real interest rate r^* are, as in the case of demand shocks, fully compensated. In terms of variances, these results can be summarized as follows:

$$(95) \quad \text{Var}[y] = \left(\frac{d}{d^2 + \lambda} \right)^2 \text{Var}[\varepsilon_2]$$

$$(96) \quad \text{Var}[\pi - \pi_0] = \left(\frac{\lambda}{d^2 + \lambda} \right)^2 \text{Var}[\varepsilon_2].$$

For the graphical solution we have to construct the $y^d(r)$ -curve by replacing Δq in equation (74) with the UIP expression of equation (90). We get a demand curve for the open economy which is only determined by domestic real interest rate:

$$(97) \quad y^d(r) = a - (b - c)r - c(r^* + \alpha) + \varepsilon_1.$$

This curve is characterised by two features:

- the slope of the $y^d(r)$ -curve is negative as long as $b > c$, i.e. the interest rate channel of aggregate demand prevails over the exchange rate channel; we refer to this as the “normal” case;
- the slope of the $y^d(r)$ -curve is steeper in an open economy compared to a closed economy: $1/(b - c) > 1/b$. That implies that an identical change of the real interest rate has a stronger effect on aggregate demand in closed economy than in the open economy since in the latter interest rate changes are accompanied by counteracting real exchange rate changes.

We begin with Figure 26 which illustrates the interest rate reaction of the central bank in the presence of a negative shock hitting the *demand side* of the economy. From equation (97) we can see that such shocks have their origin either in the behaviour of domestic actors such as the government or the consumers ($\varepsilon_1 < 0$), or in the international environment in the form of an increase of the foreign real interest rate or the risk premium. The latter group of shocks affects domestic demand via the real exchange rate. Thus, the aggregate demand curve can now be shifted by domestic and foreign shocks. In the case of a negative shock it shifts to the left, resulting in a negative output gap (y_1) and a decrease of the inflation rate (π_1). As a consequence, the central bank lowers the real interest rate from r_0 to r_1 so that the output gap disappears, and

hence, the deviation of the inflation rate from its target. One can see that the graphical solution for the open economy is fully identical with the closed economy case.

Figure 26: Optimal interest rate policy in the case of shocks which affect the demand side

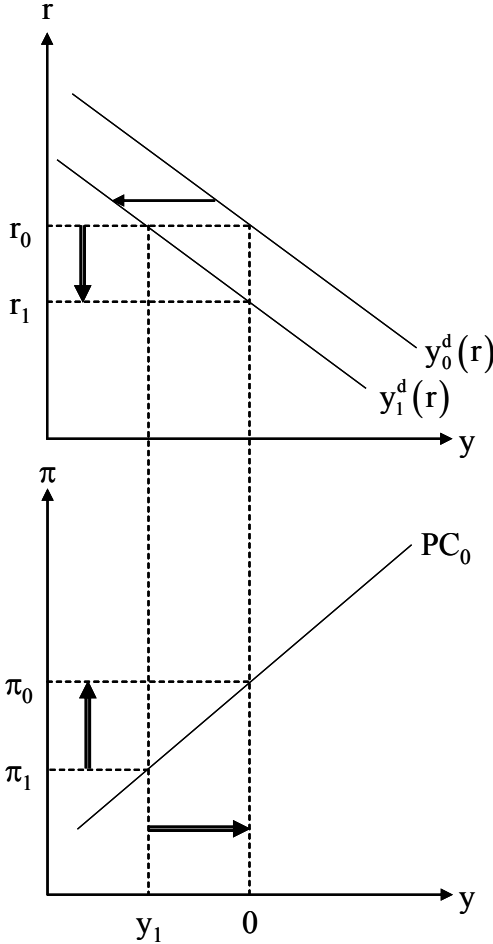

If the economy is hit by a supply shock, the central bank faces a trade-off between y and π . Figure 27 illustrates this point. A positive supply shock ($\varepsilon_2 > 0$) shifts the Phillips curve to the left. If there is no monetary policy reaction (the real interest rate remains at r_0), then the output gap is unaffected and the inflation rate rises to π_1 (point B). If, on the other hand, the central bank tightens monetary policy by augmenting the real interest rate to r_1 , the output gap becomes negative, thereby lowering the inflation rate to π_0 (point A). As in the closed economy case, the exact point (A, B, or in between) solely depends on the preferences γ of the central bank. If π and y are equally weighted in the loss function, the iso-loss locus is a circle, and PC_1 touches the circle at (π_2, y_2) .

Figure 27: Optimal interest rate policy following a supply shock

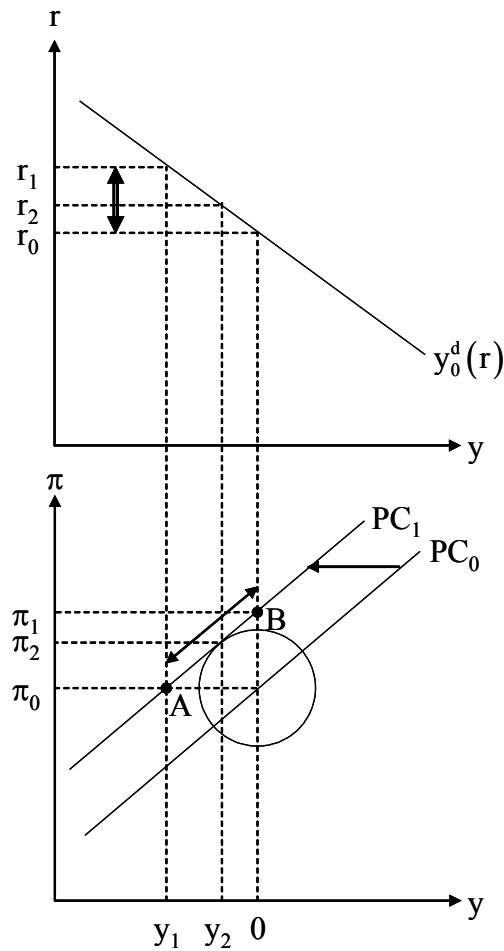

4.1.3 Monetary policy under exchange rates that behave like a random walk

One of the main empirical findings on the determinants of the exchange rate is that in a system of independently floating exchange rates no macroeconomic variable is able to explain exchange rate movements (especially in the short and medium run which is the only relevant time horizon for monetary policy) and that a simple random walk out-performs the predictions of the existing models of exchange rate determination (Messe and Rogoff [1983]). In particular, the hypothesis of a valid UIP condition is widely rejected under independently floating exchange rates (Froot and Thaler [1990]). The random walk behaviour of the real exchange rate can be described in a very simple way by

$$(98) \quad \Delta q = \eta$$

where η is a random white noise variable. Inserting equation (98) into (87) yields an interest rate rule

$$(99) \quad r^{\text{opt}} = \frac{a}{b} + \frac{1}{b} \varepsilon_1 + \frac{d}{b(d^2 + \lambda)} \varepsilon_2 + \frac{c}{b} \eta$$

according to which the central bank additionally responds to the random exchange rate movements. At first sight, even under this scenario monetary policy autonomy is still preserved. However, there are obvious limitations which depend on

- the size of such shocks, and
- the impact of real exchange rate changes on aggregate demand which is determined by the coefficient c in equation (74).

Empirical evidence shows that the variance of real exchange rates exceeds the variance of underlying economic variables such as money and output by far. This so-called “excess volatility puzzle” of the exchange rate is excellently documented in the studies of Baxter and Stockman [1989] and Flood and Rose [1995]. Based on these results we assume that $\text{Var}[\eta] \gg \text{Var}[\varepsilon_1]$.

Thus if a central bank would try to compensate the demand shocks created by changes in the real exchange rate, it could generate highly unstable real interest rates. While this causes no problems in our purely macroeconomic framework, there is no doubt that most central banks try to avoid an excessive instability of short-term interest rates (“interest rate smoothing”) in order to maintain sound conditions in domestic financial markets.¹¹ If this has the consequence that the central bank does not sufficiently react to a real exchange rate shock, the economy is confronted with a sub-optimal outcome for the final targets y and π .

For the graphical solution the $y^d(r)$ -curve is simply derived by inserting equation (98) into (74) and eliminating Δq :

$$(100) \quad y^d(r) = a - b r + c \eta + \varepsilon_1 .$$

Exchange rate shocks η lead to a shift of the $y^d(r)$ -curve, similar to what happens in the case of a demand shock. In Figure 28 we introduced a smoothing band that limits the room of manoeuvre of the central banks interest rate policy. In order to avoid undue fluctuations of the interest rate,

the central bank refrains from a full and optimal interest rate reaction in response to a random real appreciation ($\eta < 0$) that shifts the $y^d(r)$ -curve to the left. As a result, the shock is only partially compensated so that the output gap and the inflation rate remain below their target levels.

Figure 28: Interest rate smoothing and exchange rates that behave like a random walk

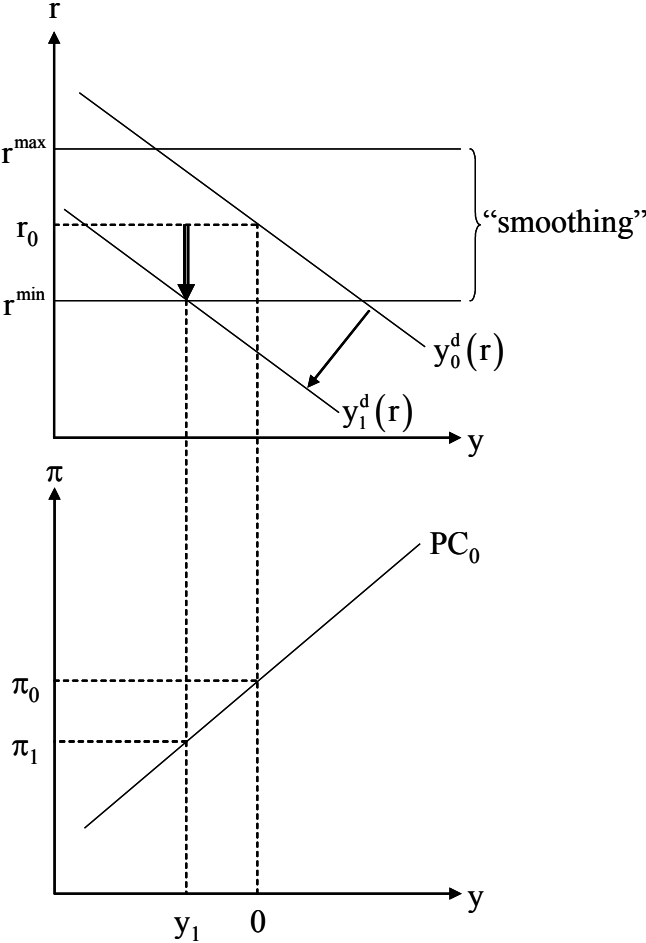

4.2 Simple interest rate rules under independently floating exchange rates

As in the case of optimal central bank behaviour, there is only a role for monetary policy in the case of a valid UIP and an invalid PPP. The simple interest rate rule has the same shape as in Chapter 3.4:

$$(101) \quad r = r_0 + e(\pi - \pi_0) + fy$$

¹¹ However, most models, as the one presented here, fail to integrate the variance of interest rates and its consequences into a macroeconomic context.

In order to obtain the solutions for the goal variables y and π we have to proceed as follows. As shown in Chapter 4.1.2 we first have to replace Δq in the aggregate demand equation. By inserting the interest rate rule (101) into equation (97) and solving the resulting equation for y we obtain the following equation:

$$(102) \quad y = \frac{a - (b - c)r_0 + (b - c)e\pi_0 - c(r^* + \alpha) + \varepsilon_1}{1 + (b - c)f} - \frac{(b - c)e}{1 + (b - c)f} \pi.$$

With the Phillips curve

$$(103) \quad \pi = (\pi_0 + \varepsilon_2) + d y$$

(102) and (103) constitute a system of two equations with the two unknowns y and π which can easily be solved by using standard methods. By doing so, we get the following expressions:

$$(104) \quad y = \frac{[a - br_0] - c[r^* - r_0 + \alpha] + \varepsilon_1 - (b - c)e\varepsilon_2}{1 + (b - c)(f + de)},$$

$$(105) \quad \pi = \pi_0 + \frac{d[a - br_0] - dc[r^* - r_0 + \alpha] + d\varepsilon_1 - (1 + (b - c)f)\varepsilon_2}{1 + (b - c)(f + de)}.$$

If no shocks occur ($\varepsilon_1 = \varepsilon_2 = \alpha = 0$ and r^* unchanged), the terms in squared brackets are also equal to zero. The reason for this is that in case of a neutral monetary policy stance, $r = r_0 = a/b$ ¹² and $\Delta q = r^* - r_0 + \alpha = 0$. Thus, the output gap is zero, and the inflation rate is equal to the central bank's inflation target. If the economy is hit by a shock to which the central bank responds according to a Taylor type interest rate rule, we finally get the following variances of the goal variables:

¹² See also footnote 10.

$$(106) \quad \text{Var}[y] = \left(\frac{1}{1+(b-c)(f+de)} \right)^2 \cdot \left\{ c^2 \text{Var}[r^*] + c^2 \text{Var}[\alpha] + \text{Var}[\varepsilon_1] + ((b-c)e)^2 \text{Var}[\varepsilon_2] \right\},$$

$$(107) \quad \text{Var}[\pi] = \left(\frac{1}{1+(b-c)(f+de)} \right)^2 \cdot \left\{ (dc)^2 \text{Var}[r^*] + (dc)^2 \text{Var}[\alpha] + d^2 \text{Var}[\varepsilon_1] + (1+(b-c)f)^2 \text{Var}[\varepsilon_2] \right\}.$$

With these variances it is again possible to restrict the theoretically infinite number of rules to a subset of stabilizing rules. As in Chapter 3, a rule is said to be stabilizing if the impact of shocks on the loss function after policy intervention is lower than the impact of shocks on the loss function in the unregulated system. The unregulated system is defined as a system in which the real interest rate remains constant. For the open economy we extended the procedure of Chapter 3.4.1 by the open economy specific shocks r^* and α .¹³ By inserting the real UIP condition (equation (90)) into aggregate demand (equation (74)) we get a reduced form of the output gap:

$$(108) \quad y = a - (b-c)r - c(r^* + \alpha) + \varepsilon_1.$$

For a reduced form of the inflation rate we finally have to replace y in the Phillips curve equation (76) by equation (108):

$$(109) \quad \pi = \pi_0 + da - d(b-c)r - cd(r^* + \alpha) + d\varepsilon_1 + \varepsilon_2.$$

From this follows that the variances of the unregulated system are given by

$$(110) \quad \text{Var}[y] = c^2 \text{Var}[r^*] + c^2 \text{Var}[\alpha] + \text{Var}[\varepsilon_1]$$

and

$$(111) \quad \text{Var}[\pi] = (cd)^2 \text{Var}[r^*] + (cd)^2 \text{Var}[\alpha] + d^2 \text{Var}[\varepsilon_1] + \text{Var}[\varepsilon_2].$$

The combinations of e and f that result in a stabilizing simple rule are highlighted by the shaded area in Figure 29.¹⁴ It shows that the typical Taylor rule with $e = f = 0.5$ can also be applied in an open economy environment.

Figure 29: Regions of stabilizing and destabilizing simple rules

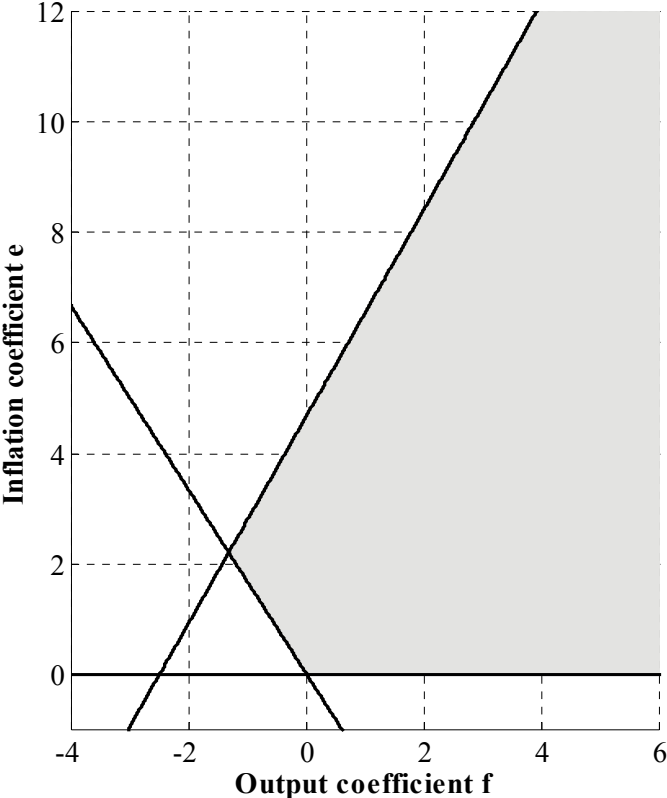

Graphically, the monetary policy (MP) line is determined by the Taylor rule specified in equation (101). The slope depends on the coefficient f which usually takes non-negative values. Additionally, the current rate of inflation (multiplied by the inflation coefficient e) is a shift parameter. The $y^d(r)$ -curve is derived in the same way as in Chapter 4.1.2:

$$(112) \quad y^d(r) = a - (b - c)r - c(r^* + \alpha) + \varepsilon_1.$$

¹³ In fact, these two shocks do not impose any further restriction on the choice of the coefficients e and f . They yield the same inequalities as in the case of a demand shock ε_1 .

¹⁴ For the numerical calculations, we calibrated the model as follows: $b = 0.6$, $c = 0.2$, $d = 0.6$, and $\lambda = 1$. The variances of the shocks are standardised to unity.

For the same reasons as explained in the closed economy case (Chapter 3), under interest rate rules other than the optimal rule, we need to derive the interest-rate-rule-dependent $y^d(\pi)$ -curve which corresponds to equation (102):

$$(113) \quad y^d(\pi) = \frac{a - (b - c)r_0 + (b - c)e\pi_0 - c(r^* + \alpha) + \varepsilon_1}{1 + (b - c)f} - \frac{(b - c)e}{1 + (b - c)f} \pi.$$

As long as $(b - c)$ is positive (the “normal” case), the $y^d(\pi)$ -curve has a negative slope.

Figure 30: Simple rules and shocks affecting the demand side

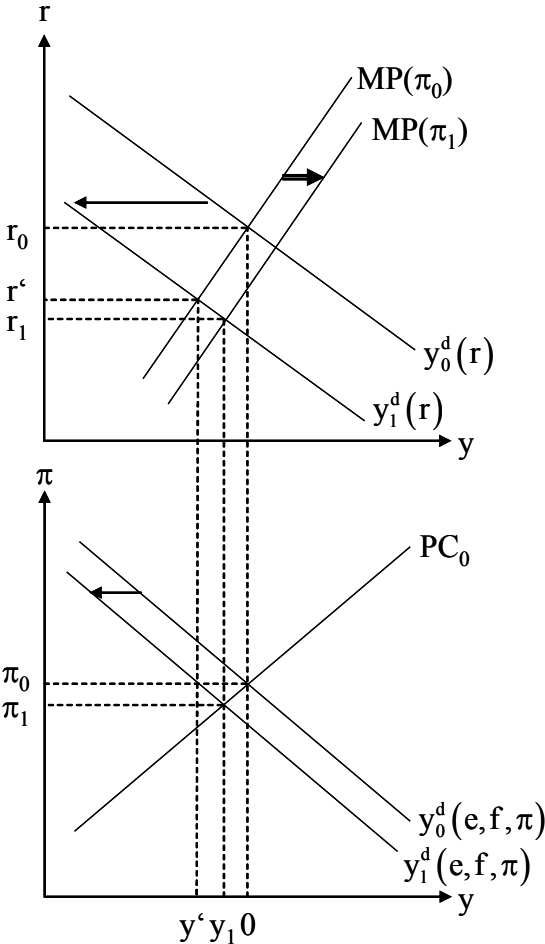

The monetary policy reaction after a negative demand shock is shown in Figure 30. In a first step, the shock shifts the $y^d(r)$ -curve to the left. For a moment we assume that prices are sticky so that the inflation rate remains at its initial level π_0 . As the the output gap becomes negative, the central bank lowers its interest rates from r_0 to r' , and by doing so, it limits the fall of the output gap to y' (which is clearly smaller than the shift of the $y^d(r)$ -curve). Due to the shock, the

interest-rate-rule-dependent $y^d(\pi)$ -curve in the lower chart also shifts to the left by $\overline{0y'}$. However, as can be seen from the Phillips curve, this drop in economic activity entails a decrease of the inflation rate from π_0 to π_1 which, in turn, induces the central bank to further cut the interest rates from r' to r_1 . This policy reaction goes along with a shift of the monetary policy line to the right.

Figure 31: Simple rules and supply shocks

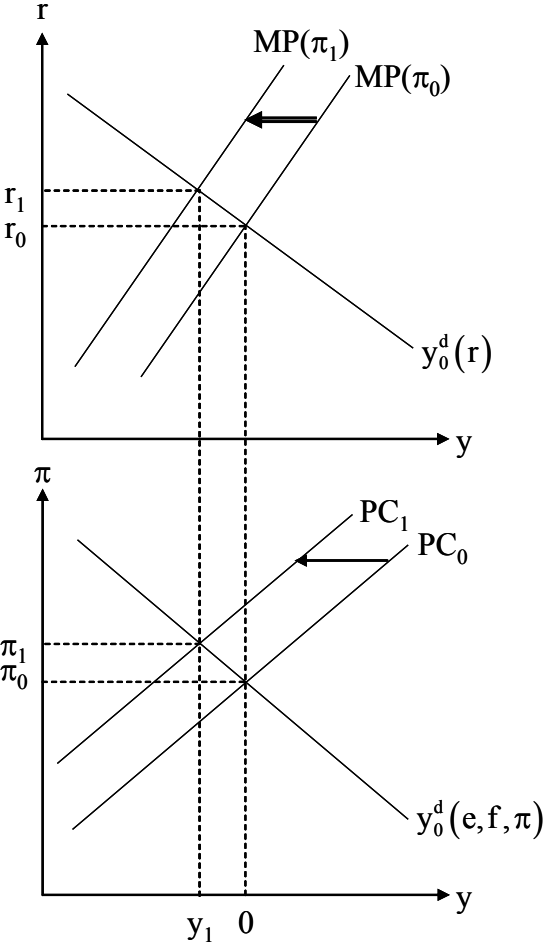

The case of a positive supply shock is illustrated in Figure 31. In the lower graph the shock shifts the Phillips curve to the left. Again, as the interest rate response of the central bank is already taken into account in the $y^d(\pi)$ -curve, the effects of the shock are already accommodated, resulting in an inflation rate π_1 and an output gap y_1 . The increase of the inflation rate was associated with a shift of the monetary policy line to the left. In sum, the central bank raised the interest rates from r_0 to r_1 .

4.3 Monetary policy under absolutely fixed exchange rates

With fixed exchange rates a central bank completely loses its leeway for a domestically oriented interest rate policy. The interest rate rule of the central bank that pegs its currency against the currency of the foreign country is restricted by the necessity of an equilibrium on the international financial markets. In order to avoid short-term capital inflows and short-term capital outflows which would exert pressure on the fixed exchange rate, the central bank strictly needs to set its interest rates according to the UIP condition

$$(114) \quad i = i^* + \alpha$$

where Δs has been set to zero. Inserting equation (82) into (114) yields a simple rule for the real interest rate:

$$(115) \quad r = i^* + \alpha - \pi.$$

As the real interest rate is only determined by foreign variables and as it depends negatively on the inflation rate, the central bank can no longer pursue an autonomous real interest rate policy. In principle, this interest rate rule can be interpreted as a special case of a simple rule. Equation (115) can easily be transformed into

$$(116) \quad r = (i^* + \alpha - \pi_0) + (-1)(\pi - \pi_0) + 0 \cdot y,$$

that is, a specific simple rule with $e = -1$ and $f = 0$ (see equation (101) for a general definition of simple rules). It is interesting to see that under fixed exchange rates the real interest rates have to fall when the domestic inflation rate rises. Thus, monetary policy becomes more expansive in situations of accelerating price increases which questions the stabilizing properties of fixed exchange rates in times of shocks. A further indication in support of this presumption is presented in Figure 29 where we showed that a basic precondition for a simple interest rate rule to stabilizing is that e has to be positive. Anyhow, for the sake of clarity we conducted the same analysis of stability as in the case of simple rules. First, we calculated the policy rule dependent solutions for the output gap

$$(117) \quad y = \frac{[a - br_0] - b[r^* + \alpha - r_0] + (b - c)[\pi_0 - \pi^*] + \varepsilon_1 + (b - c)\varepsilon_2}{1 - (b - c)d}$$

and the inflation rate

$$(118) \quad \pi = \pi_0 + \frac{d[a - br_0] - bd[r^* + \alpha - r_0] + (b - c)d[\pi_0 - \pi^*] + d\varepsilon_1 + \varepsilon_2}{1 - (b - c)d}.$$

Second, for each possible shock we computed the variances of π and y and the value of the loss function (L^{fixed}). We finally compared the results with the value of the loss function under a system where monetary policy does not react ($L^{\text{unregulated}}$) (see equations (110) and (111) for the variances of the unregulated system). For the calculations we assumed the variances of the shocks to be standardised to unity.

Table 1: Stabilizing properties of absolutely fixed exchange rates

shocks	$L^{\text{unregulated}}$	L^{fixed}	results for $b > c$	results for $b < c$
ε_1	$d^2 + \lambda$	$\left(\frac{1}{1 - (b - c)d}\right)^2 [d^2 + \lambda]$	$L_{\varepsilon_1}^{\text{unreg.}} < L_{\varepsilon_1}^{\text{fixed}}$	$L_{\varepsilon_1}^{\text{unreg.}} > L_{\varepsilon_1}^{\text{fixed}}$
ε_2	1	$\left(\frac{1}{1 - (b - c)d}\right)^2 [1 + \lambda(b - c)^2]$	$L_{\varepsilon_2}^{\text{unreg.}} < L_{\varepsilon_2}^{\text{fixed}}$	$L_{\varepsilon_2}^{\text{unreg.}} < L_{\varepsilon_2}^{\text{fixed}}$ $>$
r^*, α	$(cd)^2 + \lambda c^2$	$\left(\frac{1}{1 - (b - c)d}\right)^2 [(bd)^2 + \lambda b^2]$	$L_{r^*, \alpha}^{\text{unreg.}} < L_{r^*, \alpha}^{\text{fixed}}$	$L_{r^*, \alpha}^{\text{unreg.}} > L_{r^*, \alpha}^{\text{fixed}}$

The last two columns of Table 1 show that only in the extreme case, when the exchange rate channel dominates the interest rate channel in the determination of aggregate demand ($b < c$), absolutely fixed exchange rates may be stabilizing in the presence of shocks.¹⁵ But this situation may only apply to very small open economies. For the “normal” case ($b > c$), however, monetary policy under fixed exchange rates is clearly destabilizing.

¹⁵ For demand shocks, foreign interest rate shocks and risk premium shocks absolutely fixed exchange rates are always stabilising in the case of $b < c$. If, however, a supply shock hits the economy, the result crucially depends on the parameters λ and d .

From this result one would be tended to conclude that floating exchange rates are clearly superior to fixed exchange rates since the former have the precious advantage of an autonomous interest rate policy. However, the theory of optimum currency areas (Mundell [1961]) teaches us that this conclusion only holds as long as shocks (originating from the demand side) asymmetrically hit the domestic economy. If the foreign economy to which the country under consideration pegs its currency is equally affected by the same shock, the outcome is likely to be more supportive for regimes of fixed exchange rates. Thus, in the following, we extend our simple model to a two-country model. Compared to the small open domestic economy, the foreign country plays the role of a hegemonial leader which is assumed to be a closed economy with a central bank following a simple interest rate rule similar to our analysis in Chapter 3.4. Thus, instead of taking i^* and hence, r^* and π^* , simply as given, it is important to take into account the interest rate reaction of the foreign central bank. In terms of the shocks that affect the foreign economy the simple rule takes the following form (see equation (34)):

$$(119) \quad r^* = r_0^* + \frac{e^* d^* + f^*}{1 + b^* f^* + d^* b^* e^*} \varepsilon_1^* - \frac{e^* (1 + b^* f^*) + f^* b^* e^*}{1 + b^* f^* + d^* b^* e^*} \varepsilon_2^* = r_0^* + n_1^* \varepsilon_1^* + n_2^* \varepsilon_2^*$$

The asterisk characterises the foreign variables. The second foreign variable that enters the solutions of the domestic goal variables (equations (117) and (118)) is the foreign inflation rate π^* . In Chapter 3.4 (equation (33)) we derived the following reduced form of π^* :

$$(120) \quad \pi^* = \pi_0^* + \frac{d^*}{1 + b^* f^* + d^* b^* e^*} \varepsilon_1^* - \frac{1 + b^* f^*}{1 + b^* f^* + d^* b^* e^*} \varepsilon_2^* = \pi_0^* + m_1^* \varepsilon_1^* + m_2^* \varepsilon_2^* .$$

By inserting equations (119) and (120) into equations (117) and (118) we get the following solutions for y and π under fixed exchange rates with endogenised foreign variables:

$$(121) \quad y = \frac{1}{1 - (b - c)d} \cdot \left[\begin{array}{l} a - br_0^* + (b - c)(\pi_0 - \pi_0^*) + \varepsilon_1 + (b - c)\varepsilon_2 - \\ - (bn_1^* + (b - c)m_1^*)\varepsilon_1^* - (bn_2^* + (b - c)m_2^*)\varepsilon_2^* - b\alpha \end{array} \right]$$

$$(122) \quad \pi = \pi_0 + \frac{1}{1 - (b - c)d} \cdot \left[\begin{array}{l} ad - bdr_0^* + (b - c)d(\pi_0 - \pi_0^*) + d\varepsilon_1 + \varepsilon_2 - \\ -(bdn_1^* + (b - c)dm_1^*)\varepsilon_1^* - (bdn_2^* + (b - c)dm_2^*)\varepsilon_2^* - bd\alpha \end{array} \right].$$

With these two equations, we can easily introduce the idea of symmetric demand shocks. So far, our analysis was based on the assumption that the shocks affecting the domestic economy were independently distributed. In contrast to this, symmetry means nothing else than a certain degree of correlation between the shocks. Instead of computing the variance of a variable Z as the variance of the independently distributed shock X multiplied by the squared coefficient α_1

$$(123) \quad \text{Var}[Z] = \text{Var}[\alpha_0 + \alpha_1 X] = \alpha_1^2 \text{Var}[X],$$

we have to apply the following formula which takes into account the correlation between two shocks X_1 and X_2 :

$$(124) \quad \begin{aligned} \text{Var}[Z] &= \text{Var}[\alpha_0 + \alpha_1 X_1 + \beta_0 + \beta_1 X_2] = \\ &= \alpha_1^2 \text{Var}[X_1] + 2\alpha_1 \beta_1 \rho \sqrt{\text{Var}[X_1]} \sqrt{\text{Var}[X_2]} + \beta_1^2 \text{Var}[X_2] \end{aligned}$$

ρ is the correlation coefficient of the two shocks. It ranges from -1 , that is perfectly asymmetrical shocks, to $+1$, that is perfectly symmetrical shocks. From this point on, the proceeding is similar to the analysis of uncorrelated shocks. Based on equations (121), (122) and (124) we computed the variances of the output gap and the inflation rate for the case of correlated demand shocks ε_1 and ε_1^* . We next calculated the value of the loss function and compared it to the value of the loss function of the unregulated system. The variances of the unregulated system in the event of correlated demand shocks were derived from equations (108) and (109) where r^* has been replaced by equation (119). We then solved the inequality

$$(125) \quad L_{\varepsilon_1, \varepsilon_1^*}^{\text{fixed}} < L_{\varepsilon_1, \varepsilon_1^*}^{\text{unregulated}}$$

for the correlation coefficient ρ

$$(126) \quad \rho > \frac{1}{2(m_1^* + (1 + cd(2 - bd + cd))n_1^*)\sqrt{\text{Var}[\varepsilon_1]}\sqrt{\text{Var}[\varepsilon_1^*]}} \cdot \left. \begin{aligned} & \left\{ -d(bd - cd - 2)\text{Var}[\varepsilon_1] + \right. \\ & \left. + (m_1^* + n_1^* + cdn_1^*)(b(m_1^* + n_1^* + cdn_1^*) + c(-m_1^* + n_1^* + cdn_1^*))\text{Var}[\varepsilon_1^*] \right\} \end{aligned} \right\}$$

which can be interpreted as a minimum degree of real integration between the two countries. To get a numerical value of the minimum ρ we calibrated the foreign economy as stated in footnotes 8 and 7 and the domestic economy as stated in footnote 14. Additionally, we assumed the variances of the shocks to be one and the foreign central bank to follow a Taylor rule with $e^* = f^* = 0.5$. As a result we get

$$(127) \quad \rho > 0.82$$

which implies that at least 82 % of the foreign demand shock have to occur in the domestic economy for the fixed exchange rate system to have a stabilizing impact on the goal variables y and π .

For the graphical solution the monetary policy (MP) line is described by the interest rate rule of the central bank under fixed exchange rates (see also equation (115)):

$$(128) \quad r = i^* + \alpha - \pi.$$

Accordingly, the MP line is horizontal in the (y, r) -space. As in the case of independently floating rates with valid UIP (see Chapter 4.1.2), inserting equation (90) into (74) and eliminating Δq yields the $y^d(r)$ -curve:

$$(129) \quad y^d(r) = a - (b - c)r - c(r^* + \alpha) + \varepsilon_1.$$

The corresponding $y^d(\pi)$ -curve in the (y, π) -space is derived in a similar way as in the case of simple interest rate rules under independently floating exchange rates. By inserting the interest rate rule (115) into the $y^d(r)$ -curve (129) we get the following equation:

$$(130) \quad y^d(\pi) = a - b(r^* + \alpha) - (b - c)\pi^* + (b - c)\pi + \varepsilon_1.$$

Again, $(b - c)$ is supposed to be positive. Thus, the $y^d(r)$ -curve has a negative slope whereas the slope of the $y^d(\pi)$ -curve is positive. Compared with the negative slope of the $y^d(\pi)$ -curve under a simple rule (see Chapter 4.2), the positive slope of the $y^d(\pi)$ -curve shows again the destabilising property of the interest rate “rule” generated by fixed exchange rates. For the graphical analysis it is important to see that

- the slope of the $y^d(r)$ -curve and the $y^d(\pi)$ -curve have the same absolute value, but the opposite sign.,
- the slope of the $y^d(\pi)$ -curve is $1/(b - c)$ which exceeds one if $c < b < 1$. Thus, the $y^d(\pi)$ -curve is steeper than the slope of the Phillips curve with a slope of d for which we also assume that is positive and smaller than one.

In our graphical approach we only refer to situations where the two economies are asymmetrically hit by a shock. Figure 32 illustrates the consequences of a negative shock affecting the demand side of the domestic economy. According to equation (129) the source for such a shift in the demand curve can originate either from a domestic demand shock (ε_1) or from an increase in the foreign real interest rate (r^*) or the risk premium (α). The result is a shift of the $y^d(r)$ -curve to the left. Without repercussions on the real interest rate the output gap would fall to y' and the inflation rate to π' .

However, in a system of fixed exchange rates the initial fall in π increases the domestic real interest rates since the nominal interest rates are kept unchanged on the level of the foreign nominal interest rates. Thus, in a first step, we use the new output gap (y') and an unchanged inflation rate (π_0) to construct the new location of the $y^d(\pi)$ -curve in the (π/y) -diagram. It also shifts to the left to $y_1^d(\pi)$.¹⁶ This finally leads to the new equilibrium combination (π_1, y_1) which is the intersection between the Phillips curve and the new $y^d(\pi)$ -curve. This equilibrium goes along with a rise of the real interest rate from r_0 to r_1 which is equal to the fall of the inflation

¹⁶ In fact, the described shift of the $y^d(\pi)$ -curve is only true in the case of ε_1 -shocks which affect the $y^d(\pi)$ -curve and the $y^d(r)$ -curve by exactly the same extent (see equations (129) and (130)). If, however, the economy is hit by a risk premium (α)-shock or a foreign (r^*)-shock, the $y^d(\pi)$ -curve shifts by a larger amount than the $y^d(r)$ -curve as $b > c$.

rate from π_0 to π_1 . It is obvious from Figure 32 that the monetary policy reaction in a system of fixed exchange rates is destabilising since $\pi_1 < \pi'$ and $y_1 < y'$.

Figure 32: Fixed exchange rates and shocks affecting the demand side

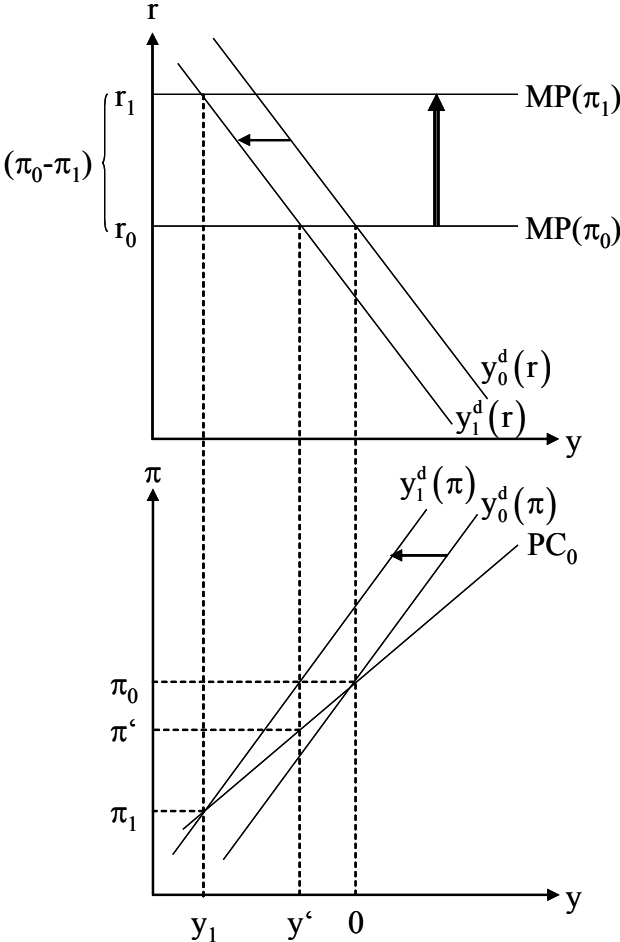

In the event of a supply shock the result is the same (see Figure 33). Initially, the Phillips curve shifts to the left, resulting in a higher rate of inflation (π') with unchanged output gap. Since the rise in inflation lowers the real interest rate, a positive output gap emerges which leads to a further rise of π . The final equilibrium is the combination (π_1, y_1) . Again, one can see that the policy rule of fixed exchange rate has a destabilising effect. It causes an increases of the inflation rate which is even higher than under a completely passive real interest rate policy in a closed economy.

Figure 33: Fixed exchange rates and supply shocks

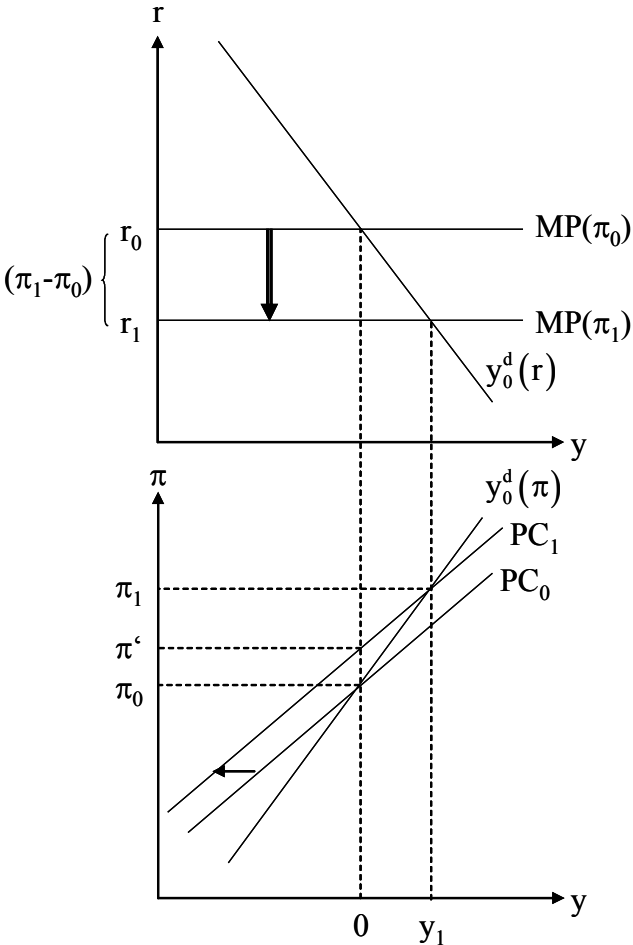

Figure 34: Loss under different strategies in an open economy

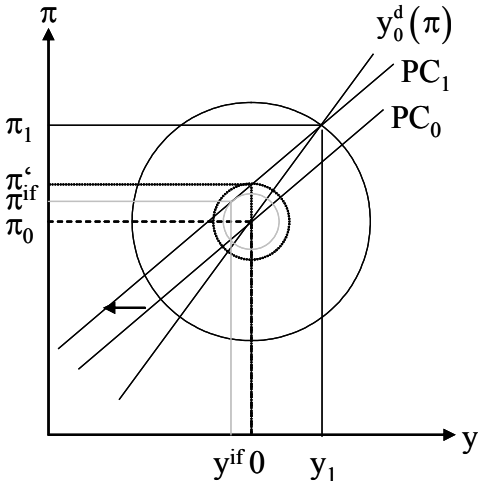

Figure 34 shows that this combination is also sub-optimal compared with the outcome a central bank chooses under optimal policy behaviour in a system of independently floating exchange rates (see Figure 27). Assuming again that the central bank equally weights π and y in its loss

function, the grey circle (π^{if}, y^{if}) depicts the loss under independently floating exchange rates. If the central bank had followed a policy of constant real interest rates (that is absence of any policy reaction) the dotted circle would have been realised with $(\pi', 0)$. Under fixed exchange rates, however, the iso-loss circle expands significantly, and the final outcome in terms of the final targets is (π_1, y_1) .

4.4 Monetary policy under a strategy of managed floating

In contrast to the traditional exchange rate regimes of absolutely fixed exchange rates and independently floating rates, a strategy of managed floating is defined by two central features:

- there is no preannounced target for the exchange rate (this is in sharp contrast to fixed rate regimes or to their “first derivative”, the crawling pegs);
- the exchange rate is mainly determined by the central bank (this is in sharp contrast to independently floating regimes where the exchange rate is mainly market determined).

There are at least two stylized facts of the current international monetary order that support the idea to develop a theoretical framework for a monetary policy strategy that lies in between the two poles of absolutely fixed and independently floating regimes. First, intermediate regimes did not disappear over the last decade which is clearly in opposition to the wide-spread academic view dubbed the “vanishing middle” or “hollowing out” and supported by economists like Eichengreen [1999] and Fischer [2001]. Instead, a couple of empirical cross-country studies found that a high degree of flexibility of the exchange rate comes along with a heavy intervention activity measured by the changes in the foreign exchange reserves of central banks. Some economists called this phenomenon a “float with a life-jacket” Hausmann et al. [2001]), others “fear of floating” (Calvo and Reinhart [2000] and Reinhart [2000]). In (Bofinger and Wollmershäuser [2001]) we decided for “managed floating” as our focus is on the introduction of the exchange rate management in the traditional monetary management of a central bank.

Our approach is directly related to the second stylized fact. In Bofinger and Wollmershäuser [2001] we further showed that for most of the managed floaters that we identified as such, changes in the net foreign assets of the central bank’s balance sheet were sterilized by reverse movements of the net domestic assets. As a result, the central banks were able to maintain the control over the domestic monetary base and thus over short-term interest rates while at the same

time intervening in the foreign exchange market and thus controlling the path of the exchange rate.

Under managed floating we understand a monetary arrangement where the central bank *directly* targets the real interest rate on the domestic money market *and* the real exchange rate on the foreign exchange market. The core of the model is a determination of aggregate demand by a monetary conditions index (MCI) which we define as a linear combination of the two operating targets, the real interest rate (r) and the change in the real exchange rate (Δq):

$$(131) \quad \text{MCI} = r - \delta \Delta q$$

with $\delta > 0$. Thus, in contrast to conventional usage, the MCI is not only an indicator for monetary policy but an operating target which underlines the controllability of both constituents. With this definition of the MCI the aggregate demand equation (74) can then be reformulated as

$$(132) \quad y = a - b \text{MCI} + \varepsilon_1$$

if δ equals c / b . The Phillips curve relation and the central bank's loss function are the same as before (see equations (76) and (85)). Instead of solving the model for an optimal real interest rate which was the only operating target under independently floating exchange rates, we solve for an optimal MCI:

$$(133) \quad \text{MCI}^{\text{opt}} = \frac{a}{b} + \frac{1}{b} \varepsilon_1 + \frac{d}{b(d^2 + \lambda)} \varepsilon_2.$$

Equation (133) can easily be derived from equation (87) by subtracting the Δq term on both sides of the equation. It is obvious that with

$$(134) \quad \text{MCI} = r - \frac{c}{b} \Delta q = \frac{a}{b} + \frac{1}{b} \varepsilon_1 + \frac{d}{b(d^2 + \lambda)} \varepsilon_2 = \text{MCI}^{\text{opt}}$$

there is an infinite number of linear combinations between r and Δq that create a monetary policy stance equal to the right hand side of equation (134). In order to provide a unique instrument

setting rule to the central bank, there has to be a further relationship between r and Δq . This relationship is generally derived from the UIP condition that takes the following form in a comparative-static setting:

$$(135) \quad \Delta s = i - i^* .$$

Equation (135) plays a crucial role under a strategy of managed floating. While the UIP hypothesis is generally rejected under independently floating exchange rates (see Chapter 4.1.3), the additional instrument of sterilised foreign exchange market interventions under managed floating aims at realising a UIP compatible exchange rate and interest rate path. In Bofinger and Wollmershäuser [2001] we have shown that contrary to the mainstream wisdom sterilised foreign exchange market interventions can be very effective if they target an exchange rate path that is determined by the interest rate differential. Such a target path has the dual advantage that

- the *cost of sterilisation* are equal to zero, as potential interest rate costs of sterilised intervention (if $i > i^*$) are fully compensated by an increase in the value of a central bank's foreign assets,
- no interest rate induced short-term inflows (or outflows) will occur since a potential interest rate advantage (disadvantage) of the home currency is always fully compensated by a depreciation (appreciation) of this currency.

We have also shown that under managed floating a central bank can in principle try to target the exchange rate without taking into account a risk premium. Thus, the target path (Δs^T) becomes

$$(136) \quad \Delta s^T = i - i^* .$$

If the risk premium of the market differs from zero and/or if the market expects an exchange rate change (Δs^e) that differs from Δs^T , managed floating implies a violation of UIP:

$$(137) \quad i - i^* \neq \Delta s^e + \alpha .$$

Such a situation leads to capital inflows or outflows which have to be compensated by means of sterilised interventions. The volume of interventions (I) depends on the degree of the violation of UIP and on the degree of capital market integration (φ):

$$(138) \quad I = \varphi(\Delta s^T - \Delta s^e - \alpha)$$

where $\varphi > 0$. The potential for such interventions is high if

$$(139) \quad i - i^* > \Delta s^e + \alpha.$$

In this case, the target path for the domestic currency implies a depreciation (appreciation) which is higher (lower) than the sum of the risk premium and the depreciation (appreciation) expected by the market. As such a violation of UIP leads to capital *inflows* and an increase in domestic currency reserves, the intervention policy can be operated without the limitations of a budget constraint.¹⁷

In the opposite case where

$$(140) \quad i - i^* < \Delta s^e + \alpha$$

a central bank's intervention policy has to compensate for capital *outflows* which leads to a reduction of the stock of foreign exchange reserves. Thus, such interventions have to be suspended as soon as the stock of foreign exchange reserves falls below a critical level. This asymmetry is an important feature of a strategy managed floating as we define it, i.e. with a *direct* targeting of the exchange rate *and* the interest rate.

As monetary policy is always best described in real terms we have to transform the nominal UIP equation (135) into its real counterpart (see Chapter 4.1.2 for the exact proceeding)

$$(141) \quad \Delta q = r - r^*.$$

Inserting equation (141) into the left hand side of equation (134) finally yields the monetary policy stance in terms of the MCI that can be achieved under the assumption of a valid UIP condition:

$$(142) \quad \text{MCI} = \left(1 - \frac{c}{b}\right)r + \frac{c}{b}r^*.$$

It depends on the foreign and the domestic real interest rate. It is important to note that the domestic and foreign inflation rate have no effect on the MCI and hence do not affect the output gap. The fact that the domestic real interest rate is a determinant of the MCI shows that under managed floating an autonomous control of the MCI is possible as long as the central bank can keep the exchange rate on its target path.

The only exception is the case of $\delta = c / b = 1$ which results in

$$(143) \quad \text{MCI} = r^*.$$

Thus, an autonomous control of the MCI is only possible if the interest rate and the exchange rate channel have a different impact on the output gap. In most cases one can assume that the interest rate channel is dominating the exchange rate channel (the “normal” case), i.e. $\delta = c / b < 1$.

In sum, the central bank’s policy rule consists of two pillars:

- first, set the interest rate r so that the actual monetary policy stance (the right hand side of equation (142)) equals the optimal monetary policy stance (the right hand side of equation (134));
- second, guarantee by sterilized foreign exchange market interventions that the path of the exchange rate permanently fulfils the UIP condition, given the interest rate policy of the first pillar.

For the graphical solution we have to extend the previous approach by two items:

- Instead of formulating aggregate demand in terms of the real interest rate ($y^d(r)$), it now depends on the MCI: $y^d(\text{MCI})$.

¹⁷ In wo we have shown that in addition a central bank needs a high sterilisation potential. This can be created easily with the instrument of a deposit policy (see Bofinger [2001], p. 331).

- As the MCI is a composite index, the concrete instrument setting in response to shocks is not revealed. Thus, we introduce two additional charts which decompose the MCI in its components r and Δq .

Figure 35 exemplarily shows the strategy of managed floating in the case of a positive demand shock. Compared with the previous open economy strategies the graphical approach now consists of four quadrants. The Phillips curve relationship which is depicted in quadrant I remains unchanged. Quadrant II shows the demand side of the economy. The $y^d(\text{MCI})$ -curve has already been derived in equations (131) and (132):

$$(144) \quad y = a - b \text{MCI} + \varepsilon_1 .$$

Thus, in the (y, MCI) -space the $y^d(\text{MCI})$ -curve has a negative slope and it shifts to the left in the presence of negative domestic demand shocks ($\varepsilon_1 < 0$). According to equation (133) the optimal reaction of the central bank is a decrease of the overall monetary conditions from MCI_0 to MCI_1 so that the demand shock is fully compensated. The output gap and the inflation rate remain at their target levels. The decomposition of the MCI into r and Δq is shown in quadrants III and IV. Quadrant III simply transforms any value of the MCI (depicted on the ordinate) into $\text{MCI} \cdot \frac{b}{c}$ (depicted on the abscissa) which defines the point of intersection of the MCI line with the $(-\Delta q)$ -axis in quadrant IV. The MCI line is given by the basic definition of the MCI (see also equation (131)):

$$(145) \quad \text{MCI} = r - \frac{c}{b} \Delta q .$$

Thus, for $r = 0$ equation (145) gives the aforementioned point of intersection $-\Delta q = \text{MCI} \cdot \frac{b}{c}$. If monetary conditions fall from MCI_0 to MCI_1 , the MCI line in quadrant IV shifts down to the left. The related policy mix is finally determined by the intersection of the MCI line and the dashed UIP line in quadrant IV. The UIP line which is given by

$$(146) \quad \Delta q = r - r^*$$

has a slope of -1 and intersects with the r -axis at $r = r^*$. In the case of a domestic demand shock the UIP line remains unchanged. However, due to the shift of the MCI line the policy mix adjusts from $(\Delta q_0, r_0)$ to $(\Delta q_1, r_1)$, hence a lower real interest rate combined with a higher real appreciation which in sum results in a higher MCI.¹⁸

Figure 35: Managed floating and demand shocks

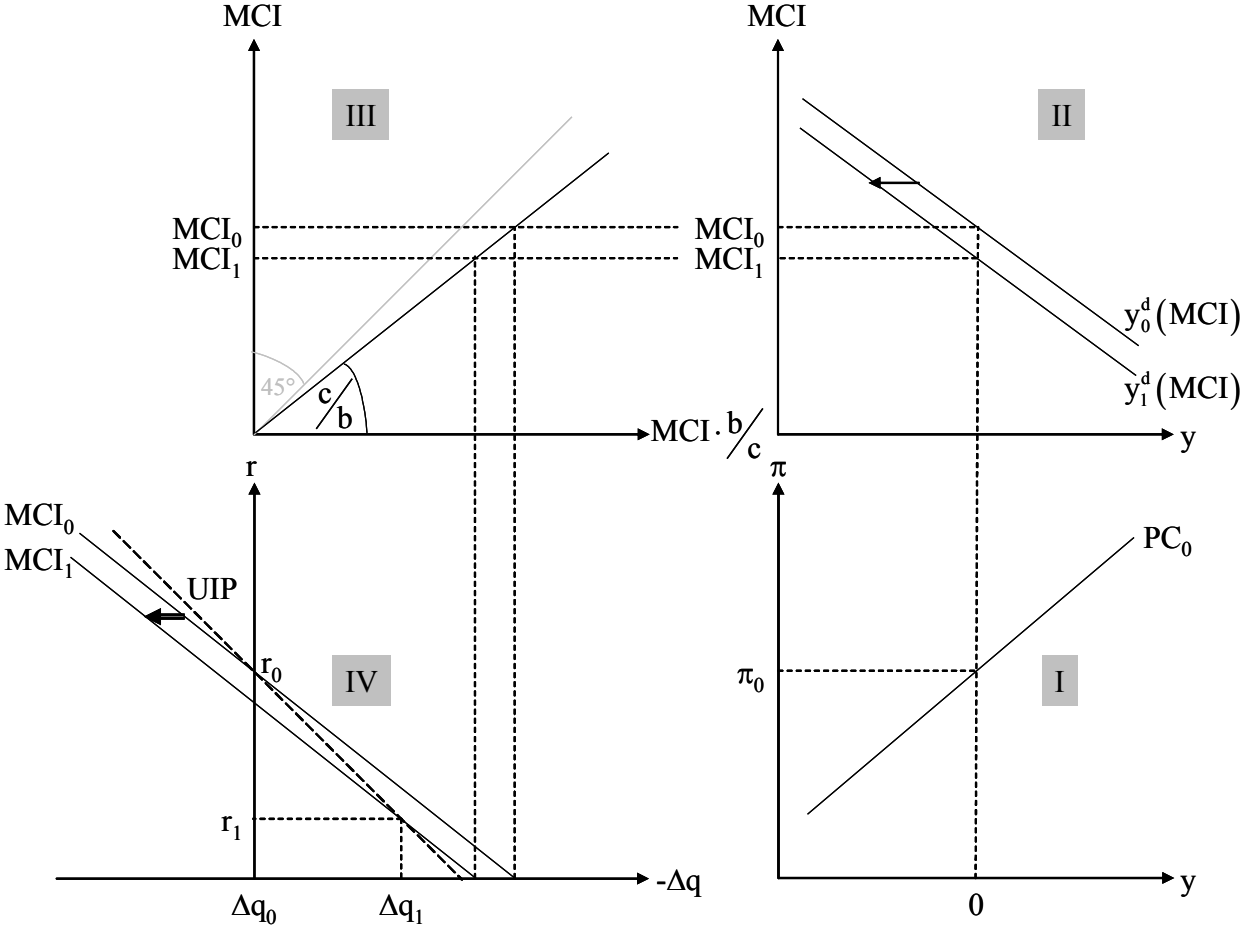

The analysis is somewhat different in the case of foreign interest rate (r^*) shocks. Figure 36 shows a rise in r^* which shifts the UIP line up to the right from UIP_0 to UIP_1 . As the optimum MCI is unaffected by the change in r^* (see equation (133)) the only adjustment process takes place on the level of the operating targets in quadrant IV. The new policy mix $(\Delta q_1, r_1)$ is given by the intersection of the UIP_1 line with the MCI_0 line.

¹⁸ The initial monetary conditions were characterised by a neutral exchange rate stance ($\Delta q_0 = 0$) and a real interest rate r_0 that is equal to the foreign real interest rate r^* .

Figure 36: Managed floating and foreign interest rate shocks

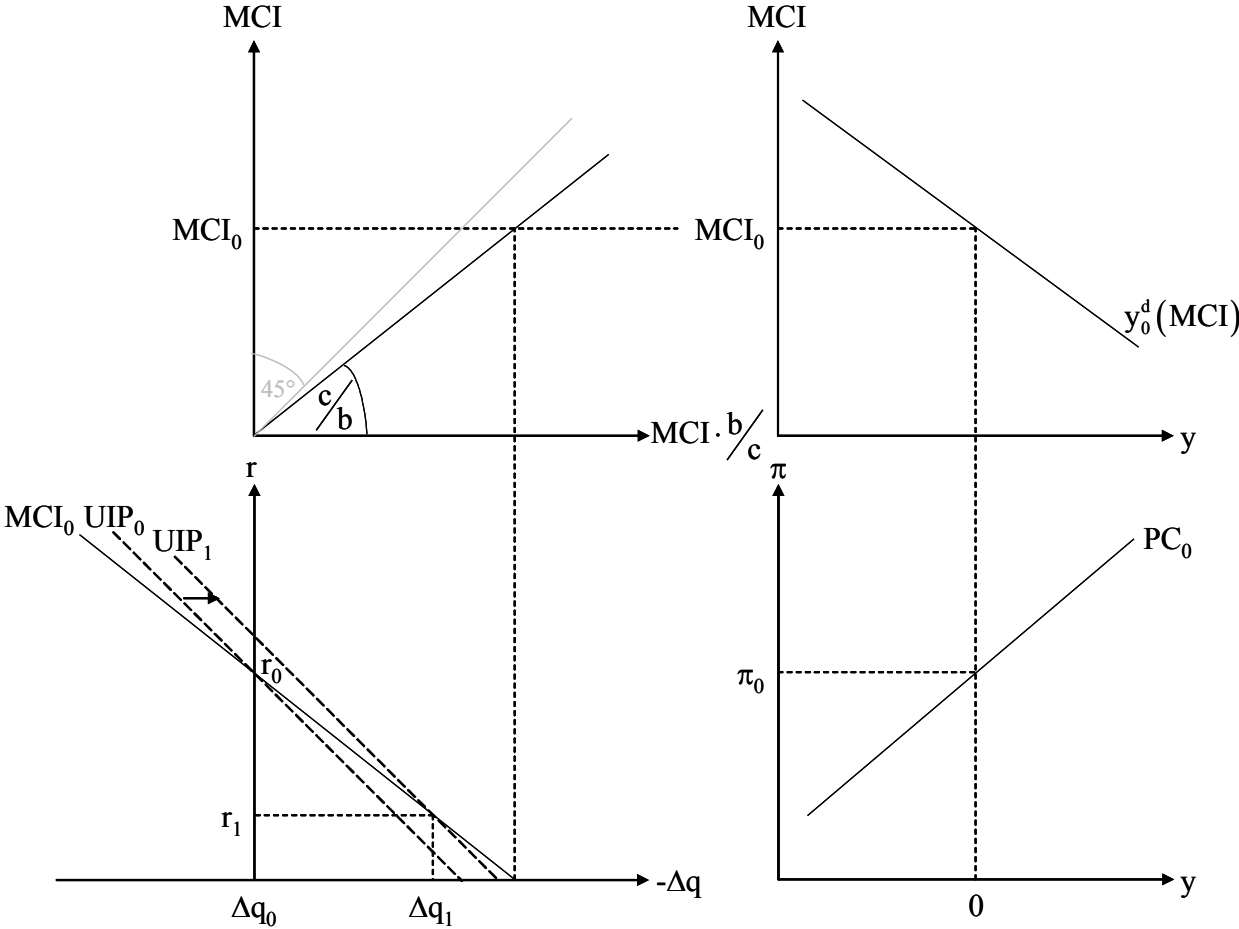

If the economy is hit by a negative supply shock ($\varepsilon_2 < 0$), the Phillips curve moves downwards from PC_0 to PC_1 . The optimum policy response (equation (133)) depends on the preference parameter λ of the central bank which is reflected by the ellipse in the (y, π) -space. Accordingly, the MCI has to decrease to MCI_1 which is achieved by a fall of the real interest rate to r_1 and a real appreciation Δq_1 (see the new point of intersection in quadrant IV).

Figure 37: Managed floating and supply shocks

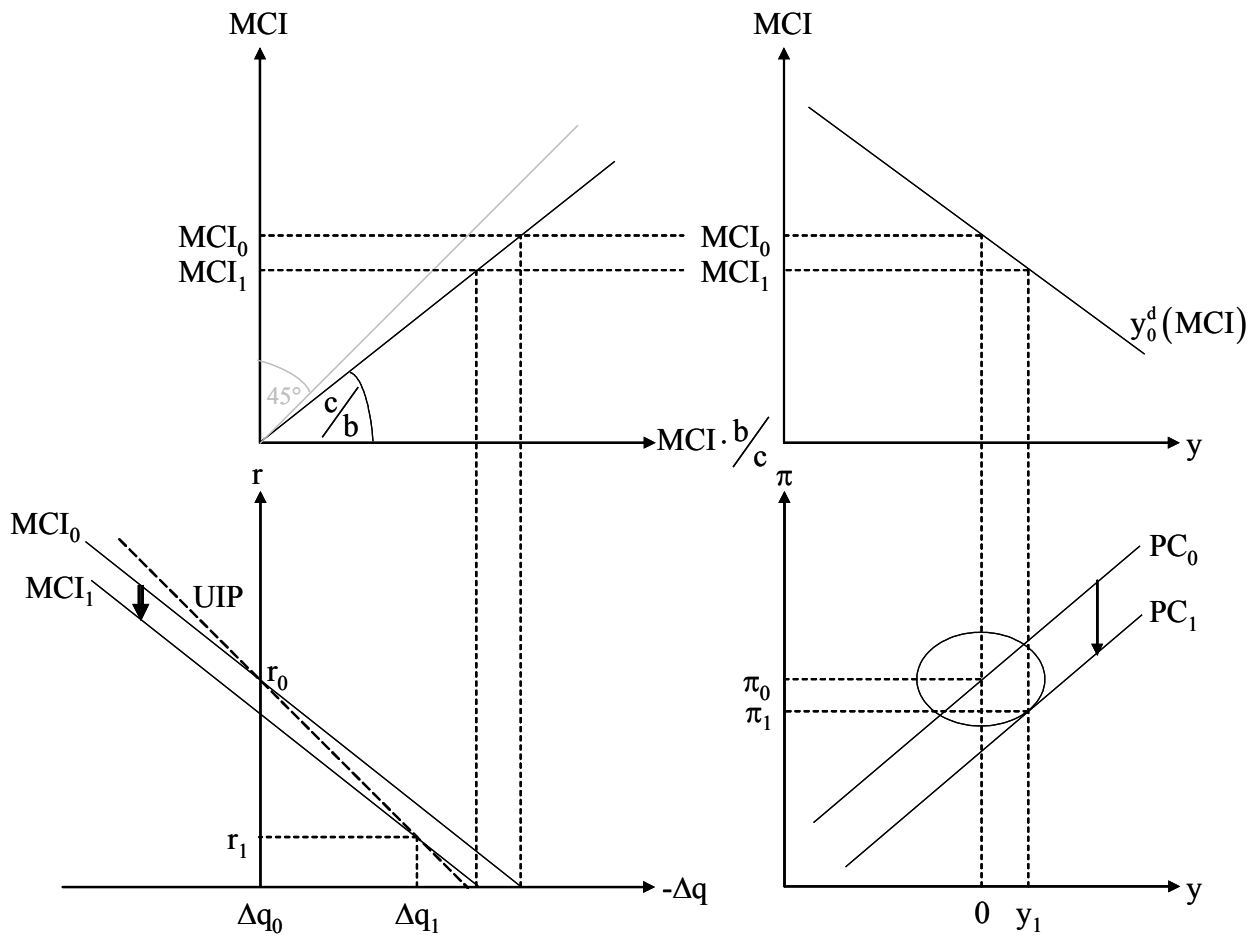

5 Summary and comparison

5.1 The closed economy BMW model and the IS/LM-AS/AD model

In order to summarize the main advantages of the BMW-model compared to the standard IS/LM-AS/AD textbook model it is useful to focus on the following points:

- Compared to the IS/LM-AS/AD model the BMW model is internally consistent with respect to its derivation of aggregate supply and demand. Additionally the causality incorporated in the BMW-model, running from the output gap to the inflation rate is in line with US postwar data.
- The BMW model is a more comprehensive framework for teaching monetary macroeconomics as it can easily deal with modern concepts like inflation targeting and other issue like credibility or monetary policy rules.

In line with Colander [1995] we stated the case that the standard IS/LM-AS/AD approach suffers from at least two series drawbacks. First of all we pointed out that the explanation of the price level provided by the IS/LM-AS/AD model rests on an inconsistency between a Keynesian determination of demand (and supply) in the IS/LM plane and a neoclassical determination in the AS/AD plane. The inconsistency as shown is obvious for negative demand shocks, which shift both aggregate demand curves to the left. The main message of the IS/LM-AS/AD model is that firms are still producing the full employment output Y_F generating an excess supply in the good market which leads to a drop in the price level. But according to the logic of the IS curve they would simply adjust their supply to the given demand so that the price level would remain constant. Thus, the whole explanation of the price level provided by the IS/LM-AS/AD model rests on an inconsistency between a Keynesian determination of demand in the IS/LM plane and a neoclassical determination in the AS/AD plane. Secondly the implied disequilibrium dynamics of the IS/LM-AS/AD model are at odds with intuition. The standard IS/LM-AS/AD model argues that a change in the price level generates output movements via its effects on the real money supply. This causality is not in line with the data as the hump shaped response in output has a lead compared to the movements in the price level. The BMW model, by construction easily accomodates the correlation structure embedded in the data. Following for instance a negative demand shock the central bank lowers real interest rates to stabilize the overall economic activity. In response the inflation rate as determined by the Phillips curve starts to pick up again. Therefore the BMW model clearly predicts that output gap movements lead movements in the inflation rate. Accordingly the BMW model in contrast to the IS/LM-AS/AD model is consistent with the data.

The second main advantage of the BMW model is that it provides a comprehensive framework to deal with modern central bank strategies such as inflation targeting and other issues like credibility or monetary policy rules:

- The introduction of a loss function depicted as a circle in the $(\pi; y)$ -space equipped us with a useful tool at hand to illustrate the decision making problem monetary policymakers face when the economy is hit by a supply shock. The overall macroeconomic outcome critically depends on the weights attached to the different goal variables. Contrary to that we saw that under discretion demand shocks could be totally stabilized. There is no trade off between stabilizing the inflation rate around the inflation target and stabilizing output at its full employment level Y_F .

- Compared to the IS/LM-AS/AD model the BMW model is designed to deal with interest rate rules like Taylor rules which have become increasingly popular over the recent years. The IS/LM-AS/AD model on contrary is mainly designed for analysing a monetary policy that targets the money supply; a strategy that has been abandoned by all major central banks.
- Additionally the IS/LM-AS/AD model focusses on the price level and treats therefore inflation and deflation as equally likely which is clearly at odds with the data. The BMW model in contrast focusses on the explanation of changes in the inflation rate. Therefore it is well suited to discuss important issues like changes in the inflation target and central bank credibility in a more realistic setting.

In sum, as the IS/LM-AS/AD model is getting more and more antiquated the closed economy BMW framework provides a natural follow up model as it carries over many qualitative policy outcomes attached to the IS/LM-AS/AD model while equally providing a more comprehensive framework for macroeconomic teaching. In particular the BMW-model accommodates institutional changes that have taken place in actual central bank practice over the recent decade.

Table 2: Summary of the results for a closed economy

Aggregate supply determination	IS/LM-AS/AD	Keynesian (IS/LM-plane) and Neoclassical (AS/AD-plane)	Logically inconsistent
	BMW-model	Consistently determined by aggregate demand	No inconsistency
Dynamics of the model	IS/LM-AS/AD	$P \rightarrow Y$	Not consistent with the data
	BMW-model	$y \rightarrow \pi$	Consistent with the data
Monetary Policy	IS/LM-AS/AD	Targeting the money supply	Outdated
	BMW-model	Targeting interest rates	In line with actual central bank practice

5.2 The open economy BMW model and the Mundell-Fleming model

For a summary of the open-economy version of the BMW-model it seems useful to compare it with the main result of the MF model (see also Table 3).

For *fixed exchange rates* the MF model comes to the conclusion that

- *monetary policy* is completely ineffective, while
- *fiscal policy* is more effective than in a closed-economy setting.

The BMW model shows that *monetary policy* is not only ineffective but rather has a destabilising effect on the domestic economy. Compared with the MF model the sources of demand shocks can be made more explicit (above all the foreign real interest rate and the risk premium) and it becomes also possible to analyse supply shocks. It is important to note that the BMW model can also show that for small economies and in the case of very similar economies fixed rates can also have a stabilising effect. As far as the effects of *fiscal policy* are concerned the BMW model also comes to the conclusion that it is an effective policy tool and that it is more effective than in a closed economy. If we treat a restrictive fiscal policy as a negative demand shock we can use the results of Figure 32. We see immediately that the initial effect on the output gap is magnified by the destabilising feature of fixed exchange rates. In the case of a very small economy the opposite is the case.

For *independently floating exchange rates* the MF models provides two main results:

- *monetary policy* is more effective than in a closed-economy setting, while
- *fiscal policy* becomes completely ineffective.

It is important to note that the MF model implicitly assumes that neither UIP nor PPP hold. As far as UIP is concerned, the MF model assumes that a reduction of the domestic interest rate is associated with a depreciation of the domestic currency (because of capital outflows). For PPP the MF model must assume that it is always violated if the nominal exchange rate changes since the MF model assumes absolutely fixed prices.

For the three versions of flexible rates the BMW models comes to results that are partly compatible and partly incompatible with the MF model.

For a world where PPP and UIP (*long-term perspective*) hold the BMW model produces the contradictory result that there is no *monetary policy* autonomy with regard to the real interest rate. Thus, the central bank is unable to cope with demand shocks. However, because of its

control over the nominal interest rate it can target the inflation rate and thus react to supply shocks. For fiscal policy the BMW model also differs from the MF model. As it assumes an exogenously determined real interest rate, i.e. a horizontal monetary policy line, fiscal policy has the same effects as in a closed economy. By shifting the $y^d(r)$ -curve it can perfectly control the output-gap and indirectly also the inflation rate.

Under a *short-term perspective* (UIP holds, PPP does not hold) the results of the BMW model are identical with regard to monetary policy as far as the signs are concerned. The central bank can control aggregate demand and the inflation rate by the real interest rate. However, because of the UIP condition a change in the real interest rate (i.e. a decline) is always accompanied by an opposite change in the real exchange rate (i.e. a real appreciation), the effects of changes in the real interest rate are smaller in the open economy than in the closed economy. Fiscal policy is again effective and if one assumes that the central bank does not react to actions of fiscal policy (constant real rate) it is as effective as in a closed economy.

In the third and most realistic scenario for flexible exchange rates (*random walk*) the results of the BMW model are in principle identical with those of the short-term perspective. However, the ability of monetary policy to react to exchange rate shocks can be limited by the need to follow a policy of interest rate smoothing. Thus, there can be clear limits to the promise of monetary policy autonomy made by the MF model. Again fiscal policy remains fully effective.

In sum, the BMW model shows that for flexible rates a much more differentiated approach is needed than under the MF model. Above all, the results of the MF model concerning fiscal policy are no longer valid if monetary policy is conducted in the form of interest rate policy instead of a monetary targeting on which the MF model is based. In the BMW model fiscal policy remains a powerful policy tool in all three version of floating.

A further advantage of the BMW model is that it is able to describe monetary policy strategies other than the two traditional regimes of independently floating and absolutely fixed exchange rates. On the one hand, in a real world scenario which is characterised by informational limitations central banks rather follow *simple interest rate rules* (e.g. Taylor rules) instead of optimal rules. As in the closed economy case, the introduction of a rule specific monetary policy line extends the graphical analysis to a wide range of simple rules. In particular, it can be shown that absolutely fixed exchange rates belong to the subgroup of simple rules that lead to a

destablising development of the target variables y and π . On the other hand, many central banks in small open economies follow an implicit and flexible exchange rate target which is realised by sterilised foreign exchange market interventions. Such a strategy of *managed floating* simultaneously combines interest rate targeting and exchange rate targeting which can easily be implemented in the BMW model. The model describes how the exchange rate path and the interest rates have to be adjusted in the event of shocks so that the central bank always creates the optimal monetary conditions.

Table 3: Summary of the results in an open economy

		Monetary policy	Fiscal policy
F i x e d	MF model	Ineffective	More effective than in a closed economy
	BMW model	$b > c$: Destabilising $b < c$: Stabilising	$b > c$: More effective than in a closed economy $b < c$: Less effective than in a closed economy
F l e x I b l e	MF model	More effective than in a closed economy	Ineffective
	BMW model I (PPP and UIP)	Real interest rate: Ineffective Nominal interest rate: effective	Effective as in closed economy
	BMW model II (UIP only)	Effective as in closed economy, but with $b > c$ real interest rate changes are less effective	Effective as in closed economy
	BMW model III (random walk)	Effective as in closed economy, but with $b > c$ real interest rate changes are less effective. Limits by the need of interest rate smoothing	Effective as in closed economy

6 Conclusion

In sum, the BMW model captures a wide range of monetary policy strategies in a closed as well in an open economy. It reduces complex solution procedures of dynamic macroeconomic models to a simple comparative-static level without losing their main insights. Compared to the IS/LM-AS/AD model it provides obvious advantages. As far as the closed-economy set-up is concerned, the BMW model is in most basic version more simple and at the same time more powerful than the IS/LM-AS/AD model. In its more complex versions it can analyse important concepts such as loss functions and monetary policy rules without getting more difficult than the IS/LM-

AS/AD model. With respect to the open economy version of the BMW model the degree of complexity is more or less similar to that of the MF model. As the BMW model assumes full capital mobility, it can avoid a discussion of the balance of payments adjustment process that requires an intensive discussion in the MF model. The BMW model is somewhat more complicated as far as the determination of the flexible exchange rate is concerned. However, this makes it much more powerful than the MF model.

Reference List

- Abel, Andrew B. and Ben S. Bernanke (2001), *Macroeconomics*, Reading.
- Barro, Robert J. and David B. Gordon (1983), A Positive Theory on Monetary Policy in a Natural Rate Model, in: *Journal of Political Economy*, 91, 589-610.
- Baxter, Marianne and Alan C. Stockman (1989), Business cycles and the exchange-rate regime ; Some international evidence, in: *Journal of Monetary Economics*, 23, 377-400.
- Blanchard, Olivier (2000), *Macroeconomics*, Upper Saddle River.
- Bofinger, Peter (2001), *Monetary Policy: Goals, Institutions, Strategies, and Instruments*, Oxford.
- Bofinger, Peter, Eric Mayer, Timo Wollmershäuser, Oliver Hülsewig, and Robert Schmidt (2002), The BMW model: a new framework for teaching monetary macroeconomics in closed and open economies, *Würzburg Economic Papers* No. 34.
- Bofinger, Peter and Timo Wollmershäuser (2001), *Managed Floating: Understanding the New International Monetary Order*, CEPR Discussion Paper No. 3064.
- Calvo, Guillermo A. and Carmen M. Reinhart (2000), *Fear of Floating*, mimeo.
- Colander, David (1995), The Stories we Tell: A Reconsideration of AS/AD Analysis, in: *Journal of Economic Perspectives*, 9, 169-188.
- Eichengreen, Barry (1999), *Toward a New International Financial Architecture: A Practical Post-Asia Agenda*, Washington D.C.
- Fischer, Stanley (2001), Exchange Rate Regimes: Is the Bipolar View Correct?, in: *Journal of Economic Perspectives*, 15, 3-24.
- Flood, Robert P. and Andrew K. Rose (1995), Fixing exchange rates: A virtual quest for fundamentals, in: *Journal of Monetary Economics*, 36, 3-37.
- Froot, Kenneth A. and Richard H. Thaler (1990), Anomalies: Foreign Exchange, in: *Journal of Economic Perspectives*, 4, 179-192.
- Hausmann, Ricardo, Ugo Panizza, and Ernesto Stein (2001), Why do countries float the way they float?, in: *Journal of Development Economics*, 66, 387-414.
- Johnson, Harry G. (1972), The Case for Flexible Exchange Rates, 1969, in: Harry G. Johnson (ed.), *Further Essays in Monetary Economics* 198-222.
- McCallum, Bennett T. (1988), Robustness Properties of a Rule for Monetary Policy, in: *Carnegie Rochester Conference Series on Public Policy*, 29, 173-204.

- McCallum, Bennett T. (1989), *Monetary Economics*, New York.
- Messe, Richard A. and Kenneth Rogoff (1983), Empirical Exchange Rate Models of the Seventies: Do They Fit Out of Sample, in: *Journal of International Economics*, 14, 3-24.
- Mundell, Robert A. (1961), A Theory of Optimum Currency Areas, in: *The American Economic Review*, 51, 509-517.
- Orphanides, Athanasios and Volker Wieland (1999), Inflation Zone Targeting, European Central Bank Working Paper No. 8.
- Reinhart, Carmen M. (2000), The Mirage of Floating Exchange Rates, in: *The American Economic Review*, 90, 65-70.
- Romer, David (2000), Keynesian Macroeconomics without the LM curve, in: *Journal of Economic Perspectives*, 14, 149-169.
- Svensson, Lars E. O. (2002), Inflation targeting: Should it be modeled as an instrument rule or a targeting rule?, in: *European Economic Review*, 46, 771-780.
- Taylor, John B. (1993), Discretion versus Policy Rules in Practice, in: *Carnegie Rochester Conference Series on Public Policy*, 39, 195-214.
- Walsh, Carl E. (2001), Teaching Inflation Targeting: An Analysis for Intermediate Macro, mimeo, University of California, Santa Cruz.
- Woodford, Michael (2002a), *Interest and Prices: Foundations of a Theory of Monetary Policy*, Chapter 1. The Return of Monetary Rules, Book Manuscript, Princeton University, Princeton.
- Woodford, Michael (2002b), *Interest and Prices: Foundations of a Theory of Monetary Policy*, Chapter 6. Inflation Stabilization and Welfare, Book Manuscript, Princeton University, Princeton.