

Koop, Michael J.

Working Paper — Digitized Version

Trade, Foreign direct investment, and multinational enterprises in a general equilibrium model

Kiel Working Paper, No. 833

Provided in Cooperation with:

Kiel Institute for the World Economy – Leibniz Center for Research on Global Economic Challenges

Suggested Citation: Koop, Michael J. (1997) : Trade, Foreign direct investment, and multinational enterprises in a general equilibrium model, Kiel Working Paper, No. 833, Kiel Institute of World Economics (IfW), Kiel

This Version is available at:

<https://hdl.handle.net/10419/46685>

Standard-Nutzungsbedingungen:

Die Dokumente auf EconStor dürfen zu eigenen wissenschaftlichen Zwecken und zum Privatgebrauch gespeichert und kopiert werden.

Sie dürfen die Dokumente nicht für öffentliche oder kommerzielle Zwecke vervielfältigen, öffentlich ausstellen, öffentlich zugänglich machen, vertreiben oder anderweitig nutzen.

Sofern die Verfasser die Dokumente unter Open-Content-Lizenzen (insbesondere CC-Lizenzen) zur Verfügung gestellt haben sollten, gelten abweichend von diesen Nutzungsbedingungen die in der dort genannten Lizenz gewährten Nutzungsrechte.

Terms of use:

Documents in EconStor may be saved and copied for your personal and scholarly purposes.

You are not to copy documents for public or commercial purposes, to exhibit the documents publicly, to make them publicly available on the internet, or to distribute or otherwise use the documents in public.

If the documents have been made available under an Open Content Licence (especially Creative Commons Licences), you may exercise further usage rights as specified in the indicated licence.

Kieler Arbeitspapiere

Kiel Working Papers

Working Paper No. 833

**Trade, Foreign Direct Investment, and Multinational
Enterprises in a General Equilibrium Model**

by

Michael J. Koop

September 1997



Institut für Weltwirtschaft an der Universität Kiel
The Kiel Institute of World Economics

ISSN 0342 - 0787

Kiel Institute of World Economics

Düsternbrooker Weg 120, D-24105 Kiel

Working Paper No. 833

**Trade, Foreign Direct Investment, and Multinational
Enterprises in a General Equilibrium Model**

by

Michael J. Koop

September 1997

781802

The author himself, not the Kiel Institute of World Economics, is solely responsible for the contents and distribution of Kiel Working Papers.

Since the series involves manuscripts in a preliminary form, interested readers are requested to direct their criticisms and suggestions directly to the author and to clear any quotations with him.

Abstract

Trade, foreign direct investment and the existence of multinational enterprises are often analyzed in separate model, which are frequently based on mutually exclusive assumptions. The paper integrates several features of international economic exchange into one general equilibrium model. This model explains various types of trade (interindustry, intraindustry, intrafirm), foreign direct investment (one-way, cross-hauling of FDI), and the existence of multinational enterprises (vertically as well as horizontally integrated ones). With the market structure being endogeneous, different production, trade and investment patterns can occur. In order to assess the influence of country asymmetries (relative and absolute factor endowment differences) and transport costs on production patterns as well as trade and investment flows, simulation techniques are applied to various specifications of the model.

JEL Classification: F12, F21, L11

Contents

1. Introduction
2. The Model
3. Parameterization of the Model
4. Simulation Results
 - 4.1. Allocation of Production
 - 4.2. Trade and Investment Flows
 - 4.3. The Trade-FDI Relationship
 - 4.4. Factor Prices
 - 4.5. The Role of Multinational Enterprises
5. Conclusions

References

Michael J. Koop
Phone: 0431-8814-214
Fax: 0431-8814-502
e-mail: mkoop@ifw.uni-kiel.de

1. Introduction

The internationalization of economic activities has increased considerably over the last ten years. While trade was the main form of internationalization for most of the post-war era this changed in the early eighties. Although trade volumes are still growing faster than world output, other forms of international economic activities are expanding even more rapidly. For instance, foreign direct investment (FDI) has been growing at a rate of more than 10 percent annually for most of the past 15 years (IMF 1996). The expansion of trade and investment is accompanied by a change in their respective structures. Two-way intraindustry trade is now dominating traditional Heckscher-Ohlin trade, and arm's length trade between unrelated firms has been partly replaced by trade related to multinational enterprises (MNE): one third of world trade is intrafirm trade within one MNE (UNCTAD 1995). The role of MNEs is even bigger, considering that another third of world trade is trade of MNEs with unrelated third parties. Moreover, sales of MNE foreign affiliates now exceed MNE exports (WTO 1996). Another striking feature of the internationalization process is that trade and investment have developed along similar geographical lines, with intraindustry trade and two-way investment flows between industrialized countries accounting for the lion's share of world trade and FDI. Only recently, has FDI in developing countries and emerging market economies picked up.

A comprehensive theory of international economic activity must focus on the international allocation of production in a system of value-added activities across national borders. It has to integrate and simultaneously explain inter- and intraindustry trade in goods and services, capital flows downstream as well as cross-hauling of FDI between industrialized countries. Moreover, it has to account for the existence of vertically and horizontally integrated MNEs with significant intrafirm trade as well as foreign affiliate sales. Combining such diverse phenomena in one model makes economic analysis technically complex and economists have traditionally resorted to analyzing them individually or a few at a time. Recently, a more comprehensive theory of international economic activity has been approached from two sides. First, standard general equilibrium trade models now include industrial organization ideas. Secondly, the managerial literature on MNEs has been formalized in general equilibrium settings.

The major contribution of the managerial literature on MNEs, Dunning's eclectic paradigm (also known as the OLI theory, Dunning 1977, 1988), is by now textbook knowledge. A firm needs some kind of ownership-specific advantage (O-advantage) such as a patent in order to offset its intrinsic competitive disadvantage compared with a foreign market's indigenous producers (Hymer 1960). If the market for the ownership-specific advantage is perfect the firm's optimal decision is to licence its technology to a firm in the foreign country. If the market is imperfect so that the company cannot reap the full benefits of its technology it internalizes the transfer of technology (I-advantage). It can do so by either exporting the final product but not the underlying technology or by locating its production abroad. Only if the foreign country offers some kind of locational advantage (L-advantage) such as lower factor prices or better infrastructure will the firm choose to invest in the foreign country¹.

Although the OLI theory seems to encompass the major building blocks of international economic activity, it is by no means undisputed. The list of factors that constitute the reasons for the three types of advantage is almost infinite, making the theory somewhat arbitrary. In addition, the relative importance of the different types of advantages is still unclear. Rugman (1986) stresses that internalization is the key to understanding MNEs and Casson (1986) argues that ownership advantages are a major factor in explaining the existence of firms but

that they do not contribute to the understanding as to why there are national and multinational firms². Moreover, it is not at all clear whether the subsidiary of a foreign multinational faces a competitive disadvantage compared to independent national firms. Quite to the contrary, empirical evidence supports the view that foreign affiliates of MNEs are more flexible with respect to entry and exit decisions (Shapiro 1983) but also with respect to the ability of global sourcing, the creation of global brands, and better access to a wider range of advanced technologies. In short, the OLI theory provides an intuitive way of organizing one's thoughts on trade, investment and MNEs, however, it fails as a rigorous theory of internationalization.

The more powerful approach to integrating different types of international economic activity appears to be the international trade literature with its industrial organization extensions. By now, the existence of ownership-specific advantages has been integrated in the trade literature in the form of proprietary assets giving rise to increasing returns to scale (Krugman 1979, Helpman, Krugman 1985). Starting with Buckley, Casson (1976) numerous contributions have analyzed the internalization advantage, i.e. the conditions under which a firm's best decision is to internalize the geographical spreading of its technology. For instance, Ethier (1986) shows that internalization is the dominant strategy when there are imperfections in licensing under uncertainty. Likewise, Horstman, Markusen (1987) find that when consumers have imperfect information about the quality of a product a firm chooses to become a multinational firm if it cannot ensure that a foreign licensee maintains the company's reputation for quality. When a firm has incomplete information on demand in a foreign market but can sell its products through a better informed foreign agent the decision to either grant a licence to the foreign agent or to undertake investment abroad and become a MNE depends on the level of agency costs (Horstmann, Markusen 1992a)³. Most models analyzing trade and multinationals now simply take internalization as a precondition for the existence of MNEs without bothering about the particular reasons for it. Instead, they combine internalization with more conventional approaches of the literature on international trade and industrial organization, in particular factor proportions and the proximity-concentration tradeoff (Krugman 1983, Brainard 1993c). While factor proportions approaches generally focus on differences between countries the proximity-concentration tradeoff weighs the costs and benefits of exploiting economies of scale or producing close to the markets.

Factor proportions models with two constant returns to scale goods generally find that the potential for interindustry trade between countries increases with the difference in relative factor endowments. If one good is produced with increasing returns to scale the potential for intra-industry trade increases with the two countries becoming bigger and/or more similar in terms of relative endowments. If the production process can be separated into two or more stages differences in factor proportions can also explain some of the activities related to MNEs. Helpman, Krugman (1985) develop a number of such predictions for a model in which two countries differ only with respect to their factor endowments (and therefore income levels) but are otherwise identical. If the differentiated goods sector is allowed to split up its production process and the different production activities have different factor intensities, the production activities will be located in different countries according to their relative factor endowments, i. e. the capital-intensive production of headquarter services is located in the capital-abundant country whereas the labor-intensive final assembly stage is located in the labor-abundant country. With increasing factor proportions differences, the emergence of vertically integrated MNEs grows more likely for without sufficient factor endowment differences there is no reason to split up the production process and therefore for MNEs. MNE-related trade is one-way interindustry trade. Allowing for more production stages, i.e. intermediate inputs, does not change this result, except that there will be interindustry trade in more than the two goods.

Whereas factor proportions models preponderantly concern themselves with vertical integration proximity-concentration models focus on horizontal integration. These models hinge on two main assumptions. On the one hand, producing close to the market is advantageous because this either saves transport costs, import tariffs or other market entry costs that exporters have to bear. On the other hand, these models recognize that economies of scale may not only be present at the firm level but also at the plant level (Markusen 1984). Therefore it is advantageous to concentrate production in as few plants as possible. Obviously, the tradeoff between the two types of costs is that by concentrating production the companies raise their transport costs while by producing close to their markets they forgo economies of scale. For two identical countries, the production and location decisions (as well as the market structure) depend on the relative magnitudes of transport costs and the ratio of firm level to plant level fixed costs (Horstmann, Markusen 1992b). Specifically, the emergence of MNEs with plants in both countries is more likely the higher transport costs and firm level fixed costs are compared to plant level fixed costs. In this case, sales of horizontally integrated MNEs of both countries supplant exports and intraindustry trade would only occur in headquarter services. The other extreme is a situation where due to high plant-specific fixed costs and/or low transport costs only national, one-plant firms prevail which export to the foreign market. Intraindustry trade would exist in the final product but headquarter services would no longer be traded.

When differences in factor proportions and the proximity-concentration tradeoff are analyzed simultaneously the emerging patterns of production and trade depend on transport costs, factor price differences and the relative magnitude of the two types of fixed costs. In one such „hybrid“ model with a two-stage production process, Brainard (1993a) shows that when factor proportions differences are introduced into proximity-concentration models different trade and investment regimes can occur, ranging from pure trade and pure multinational equilibria to situations in which exporters and MNEs coexist. When relative endowment differences are too big for factor prices to equalize, vertical single-plant MNEs supplant national exporters when concentration advantages are strong. When proximity advantages dominate concentration advantages vertical single-plant MNEs displace horizontal MNEs. In both cases, the introduction of differences in relative factor endowments enhances the production of the differentiated product in a single location.

The most recent advances in the direction of a unified theory of international economic activity were brought forth in a series of papers by Markusen and Venables (1995, 1996) and Konan et al. (1996). For instance, Konan et al. analyze inter- and intraindustry trade as well as trade in services in a general equilibrium simulation model with factor proportions differences and the proximity-concentration tradeoff. This framework allows them to investigate the emergence and influence of different types of multinational enterprises. Depending on the level of transport costs and country characteristics such as country size and relative factor endowments, different types of production and trade regimes are identified. Specifically, exporting is the dominant strategy when trade costs are low and relative factor endowments similar. When relative factor endowments are very different but absolute endowments are similar, vertically integrated MNEs prevail. Finally, when trade costs are high and relative as well as absolute factor endowments are similar, horizontally integrated MNEs dominate. With respect to the resulting trade flows deviations from traditional trade theory arise when due to the segmentation of the production process by vertical multinationals, the capital-abundant country imports the capital-intensive good.

This paper extends the analysis by explicitly introducing capital flows and a somewhat more complex production function which includes an intermediate input. By applying the Markusen-Venables simulation techniques, the paper aims at explaining the patterns of various forms of trade and investment, specifically taking country asymmetries into account. The key idea is that in each of two countries a homogeneous good which is produced with economies of scale at the plant and at the firm level can be produced by exporters and/or multinational firms. Exporters produce all components of the good in their home country and then export a part of the output incurring some transport costs. Multinational firms, on the other hand, produce all of the intermediate inputs abroad. Final assembly is split up in the way that plants in each country produce the goods to be sold in the respective market. In order for this to be possible, part of the intermediate inputs produced abroad are shipped back to the multinationals' home country. The rationale for the emergence of multinationals and therefore FDI is twofold. First, multinationals are able to exploit factor price differences (vertical direct investment). Secondly, contrary to exporters they do not incur transport costs (horizontal direct investment). However, they have to weigh this advantage against the additional fixed costs of operating a second plant abroad.

Simulations of the model identify the circumstances under which vertically and/or horizontally integrated MNEs exist and establish the conditions for one-way capital flows (downstream and upstream) and for the cross-hauling of FDI. The model explains intraindustry trade in the oligopolistic market as well as in services and intermediate inputs. Generally, it is found that specialization of production in the two countries is broadly in line with factor endowments. However, more complex specialization patterns can emerge because factors cannot only be exchanged indirectly through trade but in the case of capital can be directly transferred abroad. When relative factor endowments are very different, vertically integrated MNEs dominate and all labor-intensive goods are produced in the labor-abundant country. Production of R&D is concentrated in one country when this country owns most of the world's capital stock, (almost) independent of its labor supply. Similarly, accommodating headquarters of domestic MNEs does not depend on a country's size but on the fact that it is capital-abundant. The only exception is when transport costs are positive and factor endowments very similar. With zero transport costs, intraindustry trade dominates the oligopolistic market when relative factor endowments are not too different and when the distribution of the world capital stock is not too uneven. Horizontally integrated MNEs never exist and FDI of vertically integrated MNEs only occurs when relative factor endowments are very different. Generally, the results for zero transport costs are driven by the firms' desire to take advantage of concentration advantages and factor price differences. With positive transport costs, intraindustry trade only occurs when income levels are very similar and relative endowments are not too different. When both income levels and relative factor endowments are similar, intraindustry trade exists as well as cross-hauling of FDI carried out by (horizontal) MNEs of both countries. Increasing transport costs generally leads to higher levels of FDI and to dropping total trade volumes although the decrease in trade in the final product is partially offset by increases in the trade in intermediate inputs and services.

The remainder of the paper is organized as follows: Section 2 outlines the basic structure of the model, Section 3 identifies the major assumptions for the simulations, and Section 4 presents the simulation results. The first part of Section 4 deals with the allocation of the various production stages, the second and third parts analyze trade and investment flows while the last two parts of the section discuss the degree of factor price equalization and the role of multinationals. Section 5 summarizes and concludes.

2. The Model

The model consists of two countries (i), the domestic country d and the foreign country f , with stocks of the two factors of production capital (K_i) and labor (L_i). Whereas capital is internationally mobile (within a firm), labor cannot migrate. Both factors are mobile across sectors within the same country. There are two homogeneous goods, Y and X . Good Y which will be used as the numeraire throughout the paper is produced according to the following CES technology:

$$(1) \quad Y_i = (\beta L_{iy}^{\rho} + (1 - \beta) K_{iy}^{\rho})^{1/\rho} \quad i = d, f$$

where β stands for the (country-invariant) value share of capital, $(1 - \beta)$ for the value share of labor and ρ for the elasticity of substitution. K_{iy} and L_{iy} denote the amounts of capital and labor used in country i for the production of good Y .

In both countries, good X can be produced by exporters and by multinational firms. Good X is produced with increasing returns to scale at the firm as well as at the plant level. Research and development is carried out at the firm level. The results (denoted R&D) are public goods throughout the firm. In order to implement the results of R&D activities (e.g. in sophisticated equipment or through training workers) the firm incurs additional fixed costs (denoted T) at each plant. These fixed costs are specific to each plant and lead to increasing returns to scale at the plant level. Therefore adding more plants raises total fixed costs at the plant level but not at the firm level. The intermediate input which is used in the X sector is produced with constant returns to scale and constant marginal costs. Each exporter (E) produces good X according to the following cost function:

$$(2) \quad w_i L_{Ei} + r_i K_{Ei} = w_i [FL_{Ei} + PL_{Ei} + (c_{iL} + c_{Fi}) X_{Eii} + (c_{iL} + c_{FL} + \tau) X_{Eij}] + \\ r_i [FK_{Ei} + PK_{Ei} + (c_{iK} + c_{FK}) (X_{Eii} + X_{Eij})] \quad i, j = d, f \quad i \neq j$$

where w_i denotes the wage rate in country i and r_i the rate of interest. L_{Ei} stands for total labor demand of one exporter of country i whereas K_{Ei} is the exporter's total demand for capital. Since an exporter only produces in the home country, the respective factor demand is restricted to domestic suppliers. FL_{Ei} (PL_{Ei}) denote total labor demand of a country i exporter for firm-specific (plant-specific) fixed costs. Likewise FK_{Ei} and PK_{Ei} denote an exporter's demand for capital for firm-specific and plant-specific fixed costs. The parameters c_{iL} and c_{FL} stand for constant marginal labor requirements for the production of the intermediate input and final production. Likewise, c_{iK} and c_{FK} denote marginal capital requirements for the intermediate input and for final production. The parameter τ denotes fixed transport costs measured in units of domestic labor which are independent of the direction of trade. Transport costs may, however, differ due to differences in labor costs. Contrary to good X , good Y and the intermediate input I can be transported at no cost. Therefore the X -specific transport costs may be interpreted as a refinement activity necessary to appeal to foreign consumers or to obey foreign regulation such as labeling provisions. Finally, X_{Eii} is the quantity of output produced by an exporter of country i to be sold in the home market whereas X_{Eij} denotes the same exporter's output for sales in the foreign market, i.e. exports. Diagram 1 illustrates the production scheme for an exporter of country d . Subscripts denote whether the factors used are of domestic (d) or of foreign (f) origin.

Diagram 1: Production Scheme of Exporters

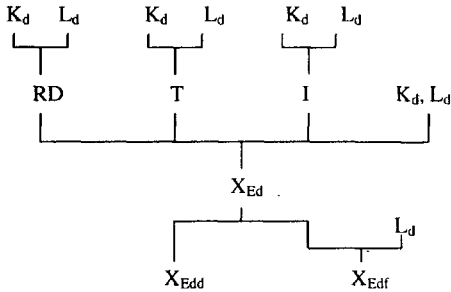

A multinational enterprise (for simplicity denoted by M in the equations) serves both markets by producing the final output in the respective country. It produces firm-specific fixed costs in the home country and incurs plant-specific fixed costs in both countries. By transferring its technologies (R&D) to a foreign affiliate, the multinational firm engages in international trade in services. Because this transfer is carried out within the firm it constitutes intrafirm trade. Production of the intermediate input is completely carried out in the foreign country. Part of the intermediate inputs is then shipped back to M 's home country where it is used for final production. Because there are no independent suppliers of the intermediate input, trade in intermediate inputs is a strictly internal transaction, constituting the model's second type of intrafirm trade. Contrary to Konan et al. (1996), intrafirm trade consists of trade in services and intermediate inputs but not in final goods. From an empirical point of view, multinationals engage in both types of intrafirm trade. However, the larger share of trade between foreign subsidiaries and the parent company is in intermediate inputs (vertical integration) whereas intrafirm trade in final products is often carried out between different subsidiaries of the same MNE⁴. Since the model only involves two countries it seems appropriate to model intrafirm trade as trade in R&D and intermediate inputs.

A multinational firm fulfills the capital requirements of its foreign affiliate for plant-specific fixed costs as well as for intermediate and final production by deploying part of its domestic capital stock in the foreign country. This constitutes the FDI part of the model. It is a restricted form of capital mobility as it does not allow domestic firms to draw directly on the foreign capital stock but only indirectly by moving some production activities abroad. This specification differs markedly from that in Markusen, Venables (1995) and Konan et al. (1996) who also claim to analyze foreign direct investment (which the latter call skilled labor). However, the capital transfer is of an indirect nature as it is the capital content of headquarter services exported which constitutes foreign direct investment, i.e. FDI is done via an inverse embodiment effect. Instead of technology embodied in capital exports it is capital embodied in the export of technology.

It is assumed that the minimum rate of return on capital deployed abroad is equal to the company's domestic return on investment. Total production costs of a multinational enterprise of country i are:

$$\begin{aligned}
 (3) \quad & w_i L_{Mii} + w_j L_{Mij} + r_i K_{Mii} = w_i [FL_{Mii} + PL_{Mii} + c_{FL} X_{Mii}] + \\
 & r_i [FK_{Mii} + PK_{Mii} + PK_{Mij} + c_{IK} (X_{Mii} + X_{Mij}) + c_{FK} (X_{Mii} + X_{Mij})] + \\
 & w_j [PL_{Mij} + c_{IL} (X_{Mii} + X_{Mij}) + c_{FL} X_{Mij}] \quad i, j = d, f \quad i \neq j
 \end{aligned}$$

where L_{Mii} stands for a multinational's total demand for domestic labor and L_{Mij} for its labor demand abroad. The firm's demand for capital K_{Mii} is strictly limited to domestic sources. FL_{Mii} (PL_{Mii}) are again labor requirements for firm-specific fixed costs (domestic plant-specific fixed costs). Contrary to exporters, however, multinationals also engage in production in the foreign country. FK_{Mii} (PK_{Mii} , PK_{Mij}) denote the demand for capital for firm-specific and (domestic and foreign) plant-specific fixed costs. Since all capital requirements are fulfilled through the parent company in the domestic country, PK_{Mij} dwells on the domestic capital stock as well. PL_{Mij} constitutes the labor requirements for the plant-specific fixed costs abroad. The parameters c_{IL} and c_{FL} (c_{IK} and c_{LK}) again denote per unit requirements of labor (capital) for intermediate and final production. Finally, X_{Mii} and X_{Mij} are the quantities of X produced and sold by an MNE of country i in countries i and j , respectively. Diagram 2 illustrates the production process of good X for a multinational enterprise.

Diagram 2: Production Scheme of Multinational Firms

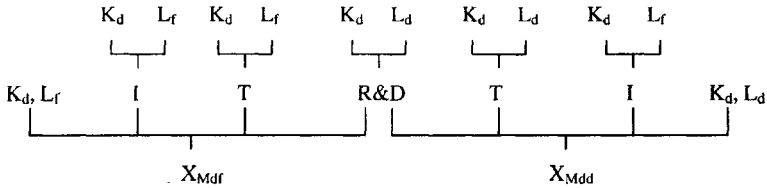

This specification differs significantly from the one presented in Konan et al. (1996) where two different kinds of multinationals were included. On the one hand, vertically integrated multinational firms exist with headquarters and plants in different countries. On the other hand, horizontally integrated firms produce the final output in both countries. While this is analytically appealing it is not consistent with empirical evidence. Firms operating in a global environment do not position themselves as vertically or horizontally integrated entities. They rather pursue vertical and horizontal integration simultaneously, the relative importance of the two strategies depending on market sizes and factor price differences. Therefore this paper will continue to analyze both types of integration while at the same time abandoning the formal distinction between the different types of multinational firms⁵.

Despite the fact that the number of firms producing good X is finite and may be small, factor markets in both countries are assumed to be fully competitive, i.e. neither exporters nor MNEs can exert monopsonistic powers. The labor market in country i clears if the domestic labor supply (L_i) equals total labor demand generated by exporters of country i and multinational firms from both countries:

$$(4) \quad L_i = L_{iy} + e_i L_{Ei} + m_i L_{Mii} + m_j L_{Mji}$$

where e_i is an endogeneous variable denoting the number of exporters in country i . Accordingly, $e_i L_{Ei}$ equals total labor demand of exporters in country i . Likewise, m_i (m_j) is the

number of multinationals of country i (j) so that $m_i L_{Mii}$ ($m_j L_{Mji}$) equal total labor demand of country i (country j) multinationals in country i .

The national capital markets clear if the domestic capital supply (K_i) equals total capital demand of domestic exporters and domestic multinational firms:

$$(5) \quad K_i = K_{iy} + e_i K_{Ei} + m_i K_{Mji}.$$

In order to endogenize the number of firms in the oligopolistic market (e_i , m_i) there is free entry and exit. The approach followed is the static entry concept (Friedman 1983) in which positive profits immediately induce new firms to enter and negative profits immediately trigger the exit of some firms. This implies that capital is perfectly mobile across sectors and that structural change occurs instantaneously and at no cost. With free entry and exit, no profits are made in the oligopolistic sector. Therefore income in country i (I_i) consists of the sum of factor rewards for domestic capital and labor:

$$(6) \quad I_i = w_i L_i + r_i K_i.$$

Income can be spent on the two goods. With p_i representing the relative price of good X in terms of the numeraire, the budget constraint is:

$$(7) \quad I_i = p_i X_i + Y_i$$

with X_i representing total supply of good X in country i :

$$(8) \quad X_i = e_i X_{Eii} + e_j X_{Eji} + m_i X_{Mii} + m_j X_{Mji}.$$

It is assumed that consumers in both countries have identical homothetic preferences. Therefore the distribution of income and property rights can be ignored. In other words, it does not matter who owns the multinational firms, an issue with otherwise important implications. Moreover, consumers have no preferences as to whether good X is produced in the home or in the foreign country or whether it is supplied by an exporter or a multinational firm. The utility function of country i is assumed to be of the Cobb-Douglas type:

$$(9) \quad U_i = X_i^\alpha Y_i^{1-\alpha}.$$

Maximizing (9) subject to the household budget constraint (7) results in the following demand functions for the two goods:

$$(10) \quad X_i = \alpha I_i / p_i \quad Y_i = (1 - \alpha) I_i$$

Exporters and MNEs maximize their profits subject to the constraints that production quantities and profits be nonnegative. Their behavior is strictly noncooperative. Strategic alliances, licencing agreements and other forms of joint profit maximization are ruled out. When making their output decisions each firm conjectures that the output quantities chosen by all other firms in both markets are independent of its own production, i.e. there is Cournot competition. The ensuing equilibrium is the standard single-period Cournot-Nash equilibrium. In order to maximize profits firms set marginal revenues to be not higher than marginal costs. In other words, if marginal costs exceed marginal revenues the company will not exist in equilibrium. The pricing equations are given in complementary slackness form:

$$(11) \quad p_i (1 - z_{Eii}) - [w_i (c_{iL} + c_{FL}) + r_i (c_{iK} + c_{FK})] \leq 0; \quad X_{Eii} \geq 0;$$

$$\{p_i (1 - z_{Eii}) - [w_i (c_{iL} + c_{FL}) + r_i (c_{iK} + c_{FK})]\} X_{Eii} = 0$$

$$(12) \quad p_j (1 - z_{Eij}) - [w_j (c_{jL} + c_{FL} + \tau) + r_j (c_{jK} + c_{FK})] \leq 0; \quad X_{Eij} \geq 0;$$

$$\{p_j (1 - z_{Eij}) - [w_j (c_{jL} + c_{FL} + \tau) + r_j (c_{jK} + c_{FK})]\} X_{Eij} = 0$$

$$(13) \quad p_i (1 - z_{Mii}) - [w_i c_{FL} + w_j c_{iL} + r_i (c_{iK} + c_{FK})] \leq 0; \quad X_{Mii} \geq 0;$$

$$\{p_i (1 - z_{Mii}) - [w_i c_{FL} + w_j c_{iL} + r_i (c_{iK} + c_{FK})]\} X_{Mii} = 0$$

$$(14) \quad p_j (1 - z_{Mij}) - [w_j (c_{jL} + c_{FL}) + r_j (c_{jK} + c_{FK})] \leq 0; \quad X_{Mij} \geq 0;$$

$$\{p_j (1 - z_{Mij}) - [w_j (c_{jL} + c_{FL}) + r_j (c_{jK} + c_{FK})]\} = 0$$

The parameters z_{Eii} (z_{Eij}) and z_{Mii} (z_{Mij}) denote markups which the companies charge in order to recover their fixed costs. The markups are of the Lerner (1934) type, defined as the relative difference between price and marginal costs, i.e. they are applied on a gross basis. In a Cournot model with homogeneous products, the optimal markups can be approximated by dividing a firm's market share by the Marshallian price elasticity of demand in the respective market. In this model, the price elasticity of demand equals one. Therefore the optimal markups are equal to a firm's market share in the two markets:

$$(15) \quad z_{Eii} = p_i X_{Eii} / \alpha I_i \qquad z_{Eij} = p_j X_{Eij} / \alpha I_j \qquad i, j = d, f$$

$$z_{Mii} = p_i X_{Mii} / \alpha I_i \qquad z_{Mij} = p_j X_{Mij} / \alpha I_j$$

Given that there are no barriers to free entry and exit in the oligopolistic sector, companies must make zero profits, i.e. total markup revenues must be equal to total fixed costs. Since the number of firms present in equilibrium is endogenous it might turn out that in some situations the zero profit condition cannot be fulfilled by one or more firm types. In this case e_i or m_i are equal to zero, meaning that good X is not produced by the respective firm type. In other words, the set of possible solutions is not by assumption restricted to interior solutions but may very well contain corner solutions. Accordingly, the zero profit conditions for the four firm types are given in comparative slackness form with the associated variables in parentheses:

$$(16) \quad p_d X_{Ed} z_{Ed} + p_f X_{Edf} z_{Edf} \leq w_d (FL_{Ed} + PL_{Ed}) + r_d (FK_{Ed} + PK_{Ed}) \qquad (e_d)$$

$$(17) \quad p_f X_{Efd} z_{Efd} + p_d X_{Efd} z_{Efd} \leq w_f (FL_{Efd} + PL_{Efd}) + r_f (FK_{Efd} + PK_{Efd}) \qquad (e_f)$$

$$(18) \quad p_d X_{Mdd} z_{Mdd} + p_f X_{Mdf} z_{Mdf} \leq w_d (FL_{Mdd} + PL_{Mdd}) + w_f PL_{Mdf} + r_d (FK_{Mdd} + PK_{Mdd} + PK_{Mdf}) \qquad (m_d)$$

$$(19) \quad p_f X_{Mfd} z_{Mfd} + p_d X_{Mfd} z_{Mfd} \leq w_f (FL_{Mfd} + PL_{Mfd}) + w_d PL_{Mfd} + r_f (FK_{Mfd} + PK_{Mfd} + PK_{Mfd}) \qquad (m_f)$$

In equilibrium exporters from both countries and therefore intraindustry trade in identical products can exist. When transport costs are zero exporters from both countries basically operate in an integrated goods market although factor markets remain separated. Even with positive transport costs intraindustry trade in identical products is profitable as exporters engage in „reciprocal dumping“, i.e. they undercut the price in the other country as they only have to cover their marginal costs which are below prices due to fixed costs (Brander, Krugman 1983). For all levels of transport costs it is assumed that there are no resale activities. Therefore a product sold at a lower price in the foreign market cannot profitably be re-imported to the country of origin.

The model can be summarized as follows. Production (cost) functions of the two goods and the (up to four) different types of firms are given in equations (1) through (3). Factor market clearance is ensured through equations (4) and (5). Together with the utility function (9), the income equations (6) and (7) determine demand functions (10) and assure that goods markets clear. Inequalities (11) - (14) and (16) - (19) associated with the four types of companies determine production levels and thereby trade and investment flows. Thus, the model consists of 36 equations of which the 12 determining output levels and number of firms are inequalities. Although marginal costs are constant which normally allows to solve one-period oligopoly problems for each market separately (Brander 1981), the equations need to be solved simultaneously because the markets are interrelated. This is due to the endogeneity of the number and type of firms which determine supply conditions in the two markets simultaneously. In order to analyze the effects of different factor endowments and transport costs, the comparative statics analysis would have to be performed on a set of 12 simultaneous inequalities. Since this proved to be technically intractable, simulation techniques were applied.

3. Parameterization of the Model

In the simulations⁶, good X is the capital-intensive good whereas Y is the labor-intensive one. However, firms can split up the production of X into three different stages: the production of fixed costs (R&D, T), the intermediate input (I) and final assembly (F). Each step requires capital and labor to be used, albeit in different proportions. The assumptions on relative factor endowments (in the benchmark scenario) and capital intensities with respect to the various production stages are as follows:

$$(K^{R\&D}_i / L^{R\&D}_i) = (K^T_i / L^T_i) > (K_i / L_i) > (K^F_i / L^F_i) > (K^Y_i / L^Y_i) > (K^I_i / L^I_i)$$

In the benchmark equilibrium, total capital intensity of good X is approximately twice that of good Y. The expenditure shares in the Cobb-Douglas utility functions are 0.5 for both products. The simulations were carried out for two transport costs scenarios for which the transport cost parameter (τ) equals 0 and 0.08. The part of the production process in which domestically produced output is converted into exports is of the Leontief-type, assuming that one unit of exports always needs a constant amount of domestic labor to be exported. For simplicity, the two scenarios will be called the 0 and 8 percent transport costs cases, although the use of percent is somewhat misleading.

Some of the tables will drive home the point as to why this type of comprehensive models does not generate unique analytical results: the general equilibrium effects are so numerous that much depends on the parameterization of the model. In order to check the robustness of the results a large number of respecified versions were simulated. For instance, increasing the

share of plant-specific fixed costs in total fixed costs regularly enhanced the competitiveness of exporters which was also found by Brainard (1993a) in a theoretical, differentiated goods model. Increasing elasticities of substitution in the production functions did not change the results in any significant way while lowering them sometimes led to situations in which no equilibrium existed. In those cases, the redistribution of factors between the two countries was too large for the low flexibility of the economies to attain a new equilibrium. Experimenting with slightly different technologies for the exporters and multinational firms also did not produce marked changes.

4. Simulations Results

As the model aims at specifying the role of factor endowment asymmetries in determining production levels as well as trade and investment flows, the simulation results will be presented in terms of the Edgeworth box. The factor endowment boxes measure the two countries' endowment shares, starting for the domestic country *d* in the lower left-hand corner with both 5 percent of the world's capital stock and labor endowment. Vertical movement up increases the domestic country's capital share by 5 percentage points at a time. Horizontal movement to the right increases its share in labor endowment, likewise by 5 percentage points at a time. Foreign endowment shares are measured starting from the upper right-hand corner. Along the diagonal, the two countries are identical with respect to relative but differ with respect to absolute factor endowments. Above the diagonal, the domestic country is relatively capital-abundant and the foreign country is labor-abundant.

Besides relative and absolute factor endowments, real income is the third major determinant of the simulation equilibria. Real income matters because it determines demand in the two markets and thereby market size. The wage-rental ratio of the benchmark equilibrium is equal to one. The model is parameterized such that world labor endowment exceeds the world supply of capital (by a factor of 2.5). Therefore the equal-income line always runs from the point where one country owns 95 percent of the world capital stock and roughly 30 percent of the world labor supply through the point of identical factor endowments down to the point where the same country owns only 5 percent of the world capital stock and about 70 percent of the labor supply (see appendix). At all points to the left of the equal-income line country *d* is considered the „small“ country whereas to the right it is the „big“ country.

Each figure consists of two parts. In the upper part, transport costs are equal to zero, in the lower part equal to 8 percent. All the numbers above are chosen arbitrarily. Hence it is meaningless to interpret the quantitative effects. All that matters are qualitative results. Despite this disclaimer, the actual numbers are occasionally used to illustrate some of the findings. As was said before, countless respecification runs make sure that the results bear some generality.

4.1 Allocation of Production

For different factor distributions, Figure 1 shows which types of firms are active in the counterfactual equilibria. The figure will be interpreted meticulously because many of the findings discussed later ensue from the type of firms active in equilibrium. Later on, only major changes will be pointed out as the general equilibrium effects are too numerous to be mentioned individually. Starting in the lower part of Figure 1, the lower left-hand corner of the diagram where the home country possesses only five percent of the world's resources but has the same relative endowment as the foreign country, only foreign exporters produce good *X*. Obviously, with identical relative endowments there are no vertically integrated MNEs.

Because the home country's market is so small it is also not profitable for horizontally integrated MNEs to operate a second plant in the domestic country. Due to the large foreign market foreign exporters exploit substantial economies of scale and outcompete domestic exporters.

Increasing the domestic country's share in the world capital stock and (somewhat lagging behind) also increasing its labor supply makes the country relatively capital-abundant and raises domestic income. The country's wage-rental ratio exceeds that of the foreign country. This makes domestic MNEs competitive which deploy some of the relatively cheap domestic capital in the foreign country to take advantage of the relatively cheap foreign labor. Compared to the domestic exporters they seem to be driven by vertical integration. Compared to foreign exporters they appear at least partially as horizontal MNEs which save on transport costs by supplying the foreign market through foreign production. Moving the capital endowment axis up even further, domestic MNEs outcompete the foreign exporters owing to substantial factor price differences but also because they are able to exploit significant returns to scale.

Moving to the right and increasing the domestic share in world labor supply beyond 50 percent raises domestic income and lowers the domestic wage-rental ratio at the same time. Because exporters' production is marginally more labor-intensive (due to transport costs and lower fixed costs) some domestic exporters enter the market. Since they only incur the fixed costs of one plant they can charge lower markups than MNEs. Since optimal markups equal market shares it follows that the output of an individual exporter is always smaller than that of an individual MNE. Which of the firm types is dominant in terms of accumulated market shares is indeterminate as the number of firms of each type can vary according to factor distribution and transport costs. Close to the diagonal, the domestic country gets so big that the foreign country's market is too small to generate sufficient markup revenues for a second MNE plant abroad and domestic exporters supplant all other firm types.

The most interesting part of Figure 1 is the core where the two countries have similar income levels and similar relative factor endowments. In this area, where factor proportions differences are small and proximity advantages balance concentration advantages, exporters and MNEs from both countries exist. By covering intraindustry trade in final goods, intermediate inputs and services as well as two-way FDI, this situation appears to be a fair image of economic exchange between industrial countries. Evidently, factor price differences vanish and multinational enterprises exist purely as the horizontal type. The number of firms of each firm type is solely determined on the basis of the tradeoff between transport costs and additional fixed costs. Since no country is sufficiently bigger than the other, neither firm type can exploit economies of scale to an extent that allows them to outcompete other firm types. Moving upward from the center point (with factor prices still being equalized), foreign income decreases. This will at first eliminate foreign MNEs, further up in the figure foreign exporters follow.

Lowering transport costs to zero (upper part of Figure 1) changes the simulation results, particularly in the center. Since the proximity advantage (saving on positive transport costs) is the very reason for the existence of horizontal MNEs zero transport costs make MNEs disappear even when market sizes are very similar. Exporters continue to penetrate foreign markets by reciprocal dumping. However, since markets are no longer segmented goods prices are equalized and domestic and foreign companies are of equal size and charge the same markups. For factor distributions which do not result in factor price equalization when transport costs

are positive, lowering transport costs allows exporters to become competitive earlier. Generally, the role of vertically integrated multinational firms is diminished while horizontal MNEs disappear entirely.

Figure 1: Active Type of Firms

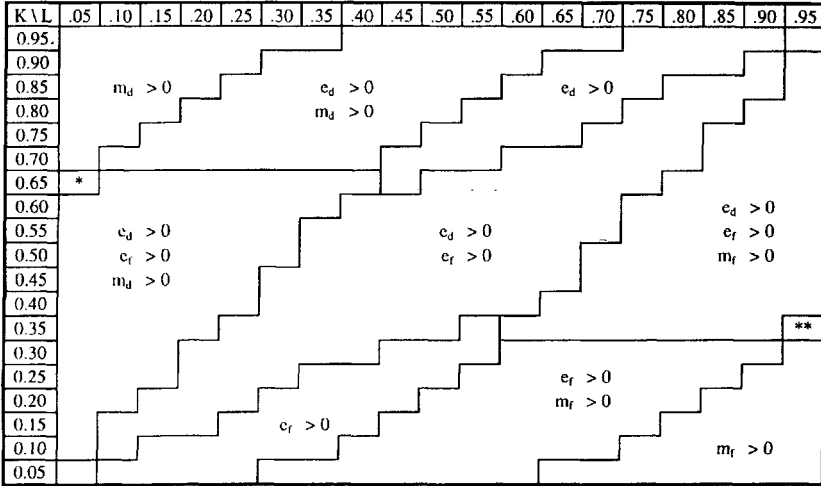

$\tau = 0$; * $e_r > 0, m_d > 0$; ** $e_d > 0, m_r > 0$.

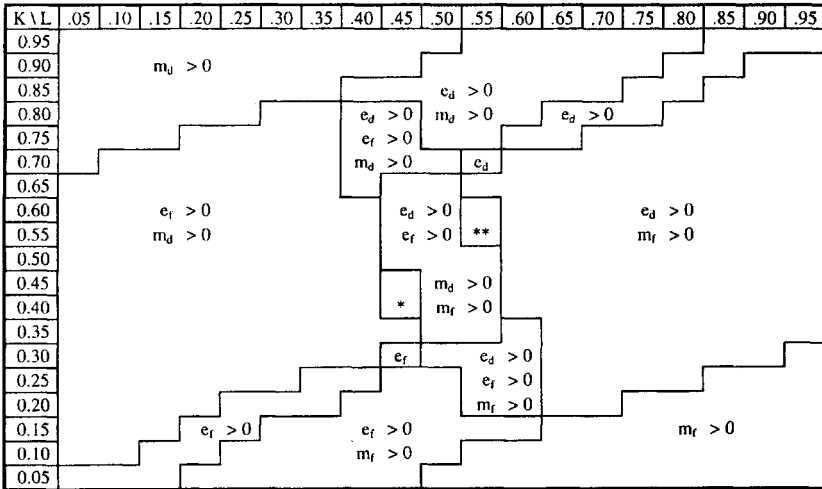

$\tau = 0.08$; * $e_d > 0, e_r > 0, m_d > 0$; ** $e_d > 0, e_r > 0, m_r > 0$.

Figure 1 can also be used for determining where R&D is carried out and where the final assembly of good X takes place. In the overwhelming number of cases final production of X is carried out in both countries. With 8 percent transport costs, merely the small area underneath (above) the diagonal in the left (right) part of Figure 1 where foreign (domestic) exporters outcompete all other firm types, X is only produced in the capital-abundant foreign (domestic) country (except for the two corners where relative endowments are identical). Lowering transport costs does not give rise to substantial change. The only difference occurs in the area where the production of X was geographically concentrated in the 8 percent scenario. Without transport costs, this area increases somewhat because exporters displace multinational firms in some cases.

With respect to the location of R&D activities three different areas can be recognized when transport costs are 8 percent. If a country's share in the world capital stock is below 25 percent it (almost) never produces R&D, independent of its income. The only exception to this is when the country is tiny but capital-abundant. In this situation, a small number of fairly big domestic MNEs engages in R&D. This might reflect the cases of Sweden and the Netherlands which are small, capital-abundant and home to a number of big MNEs. For capital shares in the range of 25-75 percent, both countries produce R&D although the share of R&D in GDP is higher for the capital-abundant country. If a country's share in the world's capital stock exceeds 75 percent, this country is almost always the sole producer of R&D, more or less independent of its share in the world's labor supply. Setting transport costs equal to zero does not change the results significantly. In particular, the concentration of R&D in the very capital-abundant country is basically unaffected by transport costs.

Figure 2 briefly highlights where the labor-intensive activities, i.e. production of good Y and intermediate input I, are carried out. With 8 percent transport costs, both countries always produce some amount of good Y. The intermediate input I is solely produced in one country when this country owns at least 65 percent of the world labor supply. With the exception of some very extreme distributions of the world capital stock this is true independent of the size of that country's capital stock. Only if the world's labor supply is divided up fairly evenly do both countries engage in the production of I.







Lowering transport costs and thereby reducing the factor price equalizing activities of multinational enterprises leads to a more diversified pattern of specialization. The three parallelograms stretching from the south-west to the north-east indicate an enlarged area where both countries engage in both labor-intensive productions. For very uneven relative factor endowments in the upper left-hand corner and the lower right-hand corner both countries continue to produce the final output Y but the production of I is concentrated in the labor-abundant country. Fairly even distributions of the capital stock combined with unequal shares in total labor supply forces the capital-abundant country to discontinue production of Y and to engage its labor force mainly in the production of the (even more labor-intensive) intermediate input. This somewhat unexpected result occurs because domestic exporters are the dominant firm type which uses up most of the country's relatively scarce labor supply. The remaining labor is employed by domestic MNEs for producing fixed costs and the final output. Only when the country's labor supply rises sufficiently, is the production of Y taken up again. In two small areas ($L_i = 0.05$, $K_i = 0.6-0.7$ and the reverse for country j), the capital-abundant country completely specializes in the production of R&D and final production, leaving both labor-intensive productions to the other country.

Combining these findings allows the discussion of structural change within one economy. The general result is that structural change is a fairly smooth process rather than one characterized by abrupt changes in the production patterns. For positive transport costs, the moderately capital-intensive final assembly of X and the moderately labor-intensive production of Y are carried out in both countries for most factor endowment distributions. Changes in a country's specialization pattern mainly occur with respect to the heavily capital-intensive production of R&D and the heavily labor-intensive production of the intermediate input. For example, a labor-abundant developing country with 5 percent of the world's capital stock and 20 percent of the world's labor supply (which may be called the Korean case) initially does not have a R&D sector of its own and produces only a small quantity of good X. The main part of its production consists of the two labor-intensive goods. When the country starts accumulating capital (faster than the developed country) its capital-labor ratio and relative size increase. As a consequence it discontinues the production of the most labor-intensive good I and extends the production of Y. Accumulating more capital, some domestic MNEs emerge and the country starts producing capital-intensive R&D. Continuing capital accumulation, the country increases production of R&D and X further and lowers its production of Y, thereby turning from an exporter to an importer of Y. An initially big labor-abundant country such as China develops along similar lines. Starting out with no domestic R&D, the accumulation of capital leads to a shift towards the production of good X. Later on, a domestic R&D sector emerges while the output of the labor-intensive sectors decline as the country turns from an exporter of Y to an importer and as domestic MNEs shift the production of the intermediate input abroad. Structural change mostly appears to be a rather smooth process for both countries. They gradually reduce the most labor-intensive activities for more capital-intensive ones. They do not close down whole industries at once and replace them with others⁷.

The simulation results with respect to the geographical allocation of production can be condensed into 3 hypotheses:

- Concentration of production: The most capital-intensive production of R&D is concentrated in the (very) capital-abundant country, (almost) independent of transport costs and the country's labor endowment. If the world capital stock is divided fairly evenly among the two countries, both engage in R&D. On the contrary, the most labor-intensive production of the intermediate input is concentrated in the labor-abundant country independent of the country's capital endowment. Final production of the moderately labor-intensive good Y is always and that of the moderately capital-intensive good X is (almost) always carried out in both countries unless one country is big and slightly capital-abundant.
- Specialization of countries: Even with big absolute and/or relative factor endowment differences, countries seldom fully specialize. Only when a country is small and slightly labor-abundant will it fully specialize in the labor-intensive good Y. Except for similar absolute and relative factor endowments the degree of specialization increases with transport costs. Structural change in the wake of capital accumulation mostly is a gradual process of replacing labor-intensive production with more capital-intensive production.
- Existence of multinational enterprises: MNEs become more important (a) the more uneven relative factor endowments become, (b) the more similar income and relative endowments become and (c) the higher transport costs are.

Figure 2: Production of Good Y and Intermediate Input I

	$Y_d > 0$ $Y_f > 0$ $I_f > 0$		$Y_d > 0$ $Y_f > 0$ $I_d > 0$		$Y_d > 0$ $I_d > 0$ $I_f > 0$		$Y_f > 0$ $I_f > 0$		$Y_d > 0$ $I_d > 0$		$Y_f > 0$ $I_d > 0$		$Y_f > 0$ $I_d > 0$ $I_f > 0$
--	-------------------------------------	---	-------------------------------------	---	-------------------------------------	---	------------------------	---	------------------------	---	------------------------	---	-------------------------------------

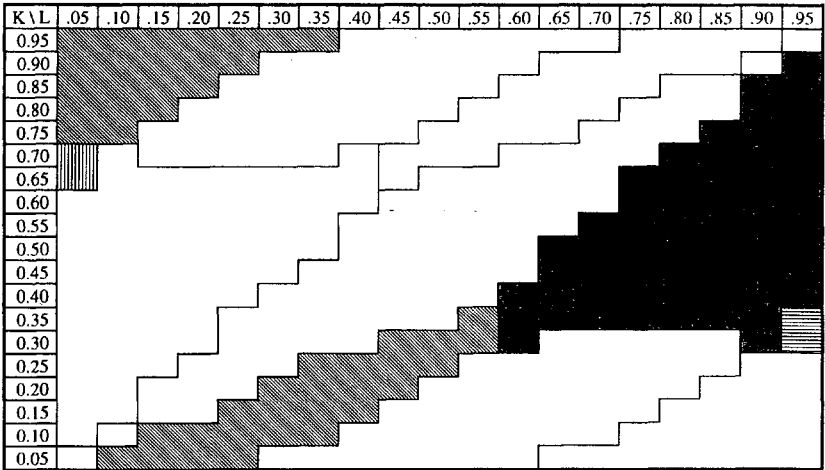

$\tau = 0$

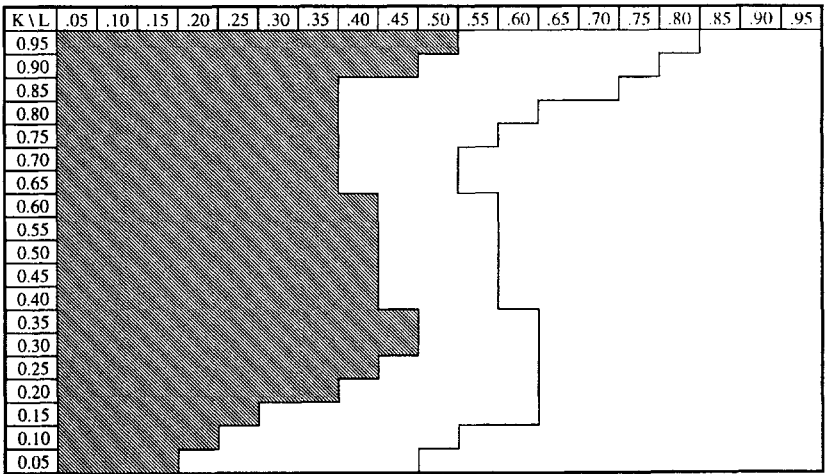

$\tau = 0.08$

4.2 Trade and Investment Flows

Since there are numerous international transactions involved in most equilibria a short summary in terms of the balance of payments is in order. Commodity trade consists of three goods, namely X, Y, and the intermediate input I. While the intermediate input and good X can simultaneously be imported and exported by one country, good Y can only flow in one direction. Commodity trade of each country need not balance as there are transactions covered in a country's service account. First, the export of capital generates capital income that is repatriated by the parent companies. Secondly, the transfer of technology by a country's multinational firms to their foreign subsidiaries is remunerated in terms of markup revenues which are equally repatriated by the parent companies. In summary, only a country's current account must be balanced. The transfer of capital in a one-period model is somewhat blurred. It is assumed that the rate of depreciation is zero and that the capital stock is returned to the home country at the end of the period. Therefore the capital accounts of both countries are necessarily balanced.

Figure 3 presents the simulation results for trade in good X and foreign direct investment flows. In the 8 percent transport cost scenario, the most interesting part, again, is the center of the figure where absolute and relative endowments differ only slightly. In this area, intraindustry trade as well as cross-hauling of foreign direct investment occurs. As multinational firms exist in both countries there is also intra-industry trade in intermediate inputs and R&D. Evidently, with similar relative and absolute factor endowments factor proportions considerations play no role. In addition, with positive transport costs proximity and concentration advantages just balance so that neither firm type has a significant competitive advantage. With factor prices equalized multinationals survive because they do not have to pay transport costs, whereas exporters save the costs of operating a second plant abroad.

Moving up and to the left, intraindustry trade continues to exist but capital only flows in one direction. This is because a reduction of the foreign country's capital stock reduces that country's market size and tends to slightly lower its wage-rental ratio. In effect, both foreign firm types lose in market shares in both countries. The necessary reduction in X production hits the foreign multinational firms harder because they demand somewhat more capital (due to the fixed costs of the second plant abroad) relative to foreign exporters. In addition, transport costs for the foreign exporters decrease marginally because of relatively cheaper labor. Finally, because the foreign multinational firms' market shares were smaller to begin with any further reduction leads to markups which are insufficient to cover total fixed costs and the foreign MNEs exit the market.

In the extreme upper left-hand (lower right-hand) corner, vertical multinational enterprises prevail, taking advantage of substantial factor price differences. Therefore the capital-abundant country continues to export capital whereas trade in the final product X comes to a halt. Below (above) that area, the biggest section of the figure is made up of equilibria with one way-trade and one-way FDI, with good X and capital flowing in opposite directions. Finally, close to the diagonal there is a narrow band where the exporters of the capital-abundant country displace all other firm types so that there is only one-way trade in X but no capital flows.

Lowering transport costs mostly has the expected effects. For the whole area surrounding the diagonal, including the core region, extended intraindustry trade replaces multinational en-







terprises and thereby capital flows. This resembles the integrated world economy parallelogram in Helpman, Krugman (1985). As before, extremely dissimilar relative factor endowments favor multinational firms and one-way capital flows completely displace trade in X. When a country is capital-abundant but not too large intraindustry trade continues to exist but due to factor price differentials multinational firms of that country become competitive and some capital flows abroad. When the country is capital-abundant and fairly big the exporters of the labor-abundant country exit the market and the capital-abundant country exports capital as well as the final product X. Finally, with one country being very big and slightly capital-abundant capital flows dry up completely and only one-way trade prevails.

With respect to FDI one would expect that capital flows from the capital-abundant to the labor-abundant country. For the scenario without transport costs this is always true although capital-abundance does not necessarily imply that capital exports actually take place. For the 8 percent transport cost scenario, however, the simulation results indicate that there are exceptions from that rule. The first one is the cross-hauling of FDI between almost identical countries. The second exception is that capital flows upstream when the two countries are similar (but not identical) in relative and not too different in absolute endowments. In this case, the labor-abundant country still has a marginally higher wage-rental ratio because the other country's exporters exert a high demand for their domestic capital. Moreover, in addition to exporting capital the labor-abundant country also has substantial exports of the labor-intensive good Y.

Since trade in services (R&D) is bound to an MNE's foreign investment, exporting (importing) capital always implies exporting (importing) services. Therefore when a country is capital-abundant it (almost) always exports services. When relative endowments and income levels are similar and transport costs are positive both countries export services (intraindustry trade in services) but the capital-abundant country remains the net exporter of services. As with capital flows, the only exception is when a country is only somewhat capital-abundant but somewhat bigger at the same time. In this case, capital flows upstream and so do services. Since lower transport costs favor exporters and impede MNEs the volume of trade in services decreases with transport costs. With zero transport costs there is also no intraindustry trade in services. Trade in services increases when both relative factor endowments and income levels either converge or diverge. Only when one of the two is similar while the other is very different will trade in services be small.

Figure 4 analyzes trade in the labor-intensive products Y and I. Here, the trade patterns with 8 percent transport costs are straightforward when relative factor endowments differ substantially. This is the case in the triangle starting in the upper left-hand (lower right-hand) corner where the capital-abundant country imports both labor-intensive products. When moving closer to similar relative endowments, the smaller but capital-abundant country continues to import the most labor-intensive product I but starts to export the somewhat less labor-intensive product Y. This is also the case when the world labor supply is split fairly evenly but one country owns the overwhelming part of the capital stock. When countries are identical good Y is not traded and trade in intermediate inputs is balanced.

Figure 3: Trade in X and FDI

	Intra- industry trade only		Intraindustry trade and one-way FDI		One-way trade and one-way FDI		One-way FDI only		One-way trade only		Intraindustry trade and two-way FDI
--	----------------------------------	---	---	---	-------------------------------------	---	------------------------	---	--------------------------	---	---

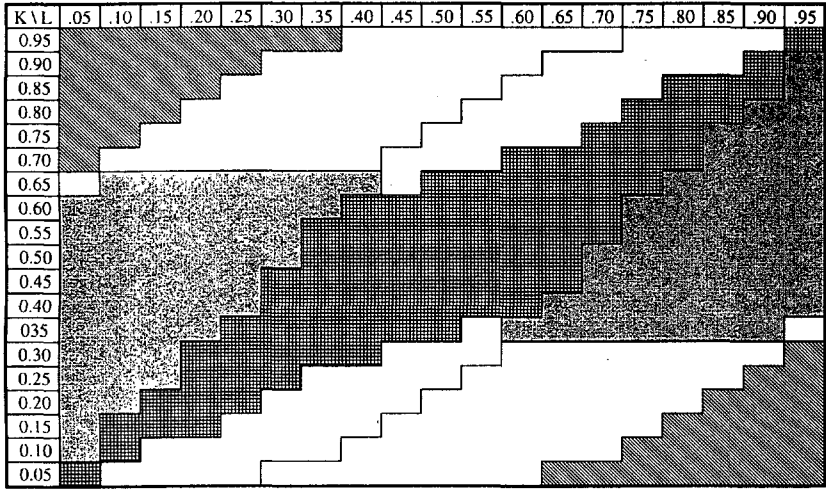
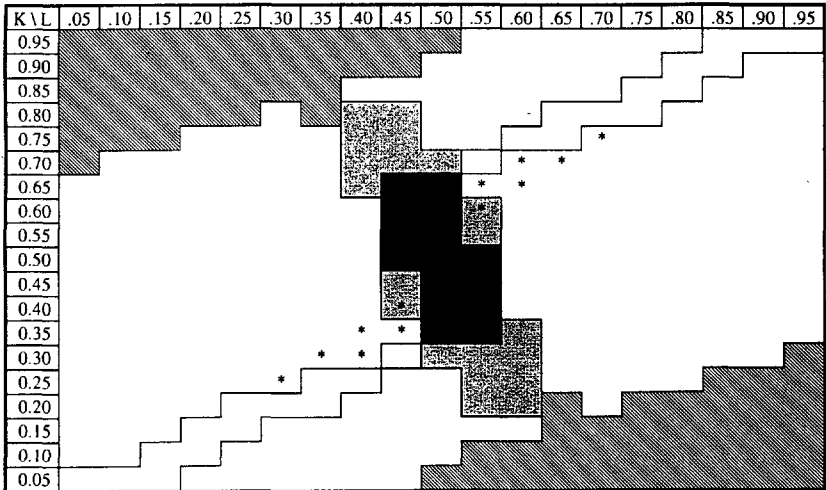
 $\tau = 0$  $\tau = 0.08$; * Capital flows from the labor-abundant to the capital-abundant country.

Erasing transport costs simplifies the trade structure of labor-intensive goods. When countries are sufficiently capital-abundant they import both labor-intensive goods independent of their size. If they are only somewhat capital-abundant they continue to import good Y but the intermediate input I is not traded any longer. This is because goods trade leads to factor price equalization so that (with zero transport costs) no horizontal MNEs exist and therefore all intermediate production takes place in the respective home countries. In this situation, good X is simply traded for good Y. With identical relative factor endowments neither good Y nor intermediate input I is traded (and since markets are no longer segmented intraindustry trade in X is balanced).

The only exception from this rather conventional outcome is when the distribution of capital is extremely uneven whereas the labor shares only differ to a much smaller extent. In these cases which are dominated by multinational firms of the capital-abundant country most of the labor demand for producing good X is located in the labor-abundant country. Therefore idle labor in the capital-abundant country is partly used for producing Y. Thus, even when markets are integrated (no transport costs) and differences in relative factor endowments are marked, there are situations in which the capital-abundant country exports the labor-intensive good.

Figure 5 takes a closer look at intraindustry trade in intermediate inputs. The iso-trade lines indicate factor endowments with identical volumes of intraindustry trade. The numbers in the figure are a cardinal measure for comparing intraindustry trade levels and bear no other meaning. With zero transport costs, intraindustry trade only occurs when relative endowments differ to a large degree. It is highest when income levels are very similar at the same time. In this case, MNEs of the capital-abundant country have the world demand for intermediate inputs produced in the foreign low-wage country. Due to very similar domestic and foreign income levels about half of the I-production is shipped back home. Generally, intraindustry trade increases with transport costs. With positive transport costs the center region develops into the second area where intraindustry trade is strong due to the existence of horizontal multinationals. Here, the third type of intraindustry trade can be observed (in addition to intraindustry trade in good X and services): cross-hauling of the intermediate input.

Economic policies often limit the openness of countries with respect to trade and investment. The damage done by such restrictions can be expected to be most severe for countries which would substantially specialize in the absence of such restrictions. When total exports include services, the two final products and the intermediate input, the simulation results support the empirical observation that the share of exports in GDP is lower in large countries than in small countries. More interestingly, however, small countries turn out to be more open when they are labor-abundant rather than capital-abundant⁸. The reason for this is that labor is immobile internationally. Therefore labor services can only be traded in terms of the labor content of goods and labor-abundant countries must export all their labor embodied in goods. Contrary to labor, capital is internationally mobile, so that capital-abundant countries can export capital services indirectly embodied in goods as well as directly in the form of FDI. Since FDI does not enter export shares small labor-abundant countries are more open with respect to trade in goods and services. The results are roughly the same for import shares and total trade shares. Consequently, trade policies which restrict exports out of (or imports into) small labor-abundant countries are more harmful than in the case of either small or big capital-abundant countries.

Figure 4: Direction of Trade in Good Y and the Intermediate Input I

	Country d imports Y and I		Country d exports Y and I		Country d imports I, exports Y		Country d exports Y, imports I
	Country d imports Y, I not traded		Goods Y, I not traded		Country d exports Y, I not traded		

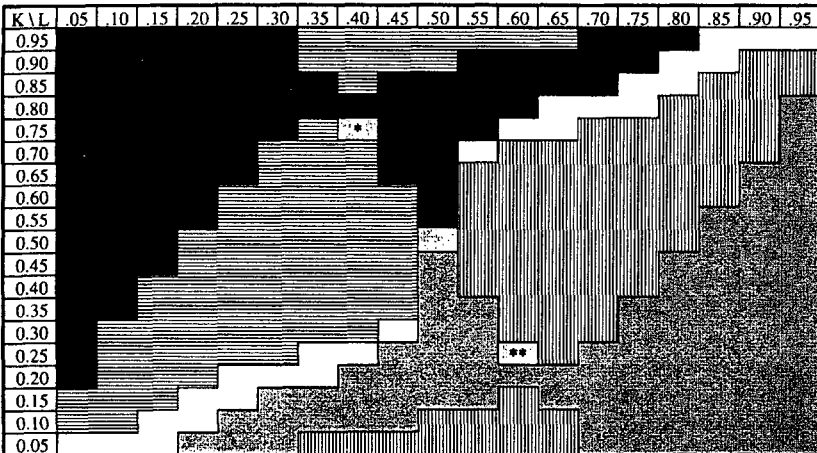
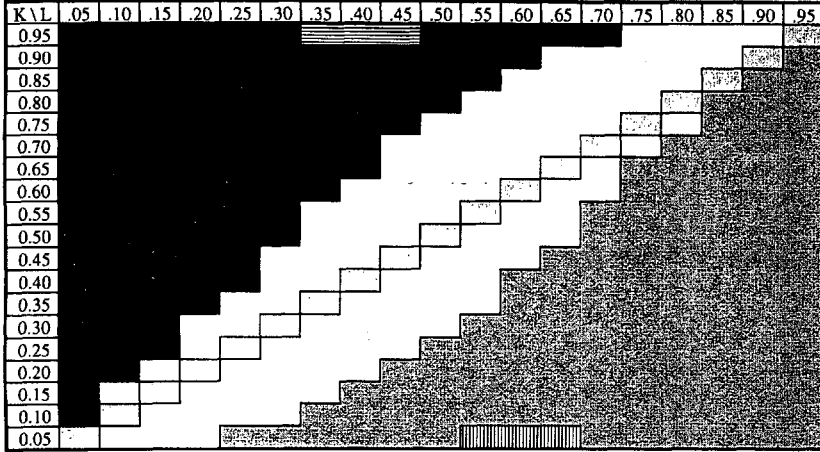
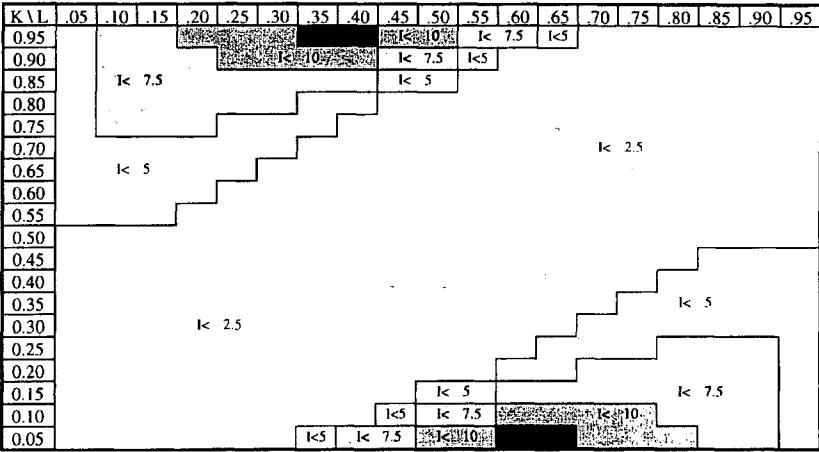
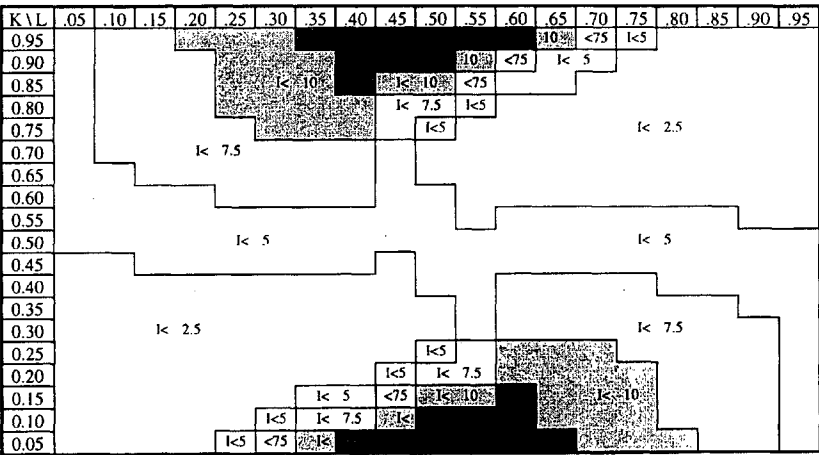

Figure 5: Intrafirm Trade in Intermediate Inputs



$\tau = 0.0$



$\tau = 0.08$

Figure 6 presents a summary of the direction of trade and investment flows. With positive transport costs small capital-abundant countries always export capital and services. They always import the most labor-intensive good I and never export the economies of scale good X. The larger the discrepancy in relative endowments is the less likely they are to import X and the more likely they are to import Y. Medium-income capital-abundant countries exchange capital, services, and X for imports of the labor-intensive goods Y and I. Only capital-abundant countries which are also home to most of the world's labor supply export good X in exchange for good Y. This is the case of (Heckscher-Ohlin type) interindustry trade in final products, albeit with (almost) no differences in factor proportions. When transport costs are zero, differences in absolute factor endowments are of second order importance. Trade and capital movements are mainly determined by differences in relative endowments. When relative factor endowments differ only slightly, the capital-abundant country imports Y and is a net exporter of X. This is in line with the results of most intraindustry models with either homogeneous or differentiated products. When differences in relative endowments get bigger, the capital-abundant country imports Y and I and exports capital as well as services and the final product X. Extremely capital-abundant countries continue their import patterns but discontinue export of the final good X in favor of higher direct exports of capital and services.

Without covering the details of all the different production and trade scenarios, some general results can be derived:

- Intraindustry trade in the oligopolistic market is the dominant trade regime when transport costs are zero. Only when one country is very capital-abundant do its exporters and MNEs outcompete all foreign firm types and intraindustry trade ceases to exist. With positive transport costs intraindustry trade only occurs when countries converge in income levels more or less independent of relative factor endowments. Surprisingly, despite higher transport costs intraindustry trade is more wide spread (in the center region) than with zero transport costs. However, total trade volumes (of X) are smaller.
- The volume of service trade increases with transport costs and when both relative factor endowments and income levels either converge or diverge. When income levels diverge and relative endowments converge trade in services is either small or absent.
- Intrafirm trade in intermediate inputs increases with converging income levels and with rising transport costs. With positive transport costs there is also a local intrafirm trade maximum when relative and absolute factor endowments converge. Here, intraindustry trade in intermediate inputs can occur.
- Higher transport costs always stimulate capital flows but reduce total trade volumes. This is true in spite of the fact that the volumes of trade in services and intermediate inputs increase with transport costs. Only when relative endowments are so different that there is no trade in X when transport costs are zero, are trade and investment unaffected by changes in transport costs.
- Capital flows only exist for sufficiently big differences in relative endowments when transport costs are zero. Capital always flows to the labor-abundant country. With increasing transport costs, FDI spreads to more factor endowment distributions and the size of capital flows increases. Whereas capital often flows to the labor-abundant country, there are circumstances under which the capital-abundant country directly imports capital from the labor-abundant country. When countries are very similar in terms of relative as well as absolute factor endowments cross-hauling of FDI occurs.

Figure 6: Direction of Trade and Investment Flows*

d imports Y, I, exports K, R&D, no trade in X	d imports I, exports Y, R&D, K, no trade in X	d imports I, X, Y, exports K, R&D	d imports I, X, exports Y, K, R&D**	d imports Y, I exports X, K, R&D
d imports Y, exports X, no trade in R&D, I, K	d imports I, exports X, Y, K, R&D	No trade in Y, no net trade in X, I, K, R&D	d imports I, X, exports K,R&D; no trade in Y	No trade in Y, I, R&D; no net trade in X

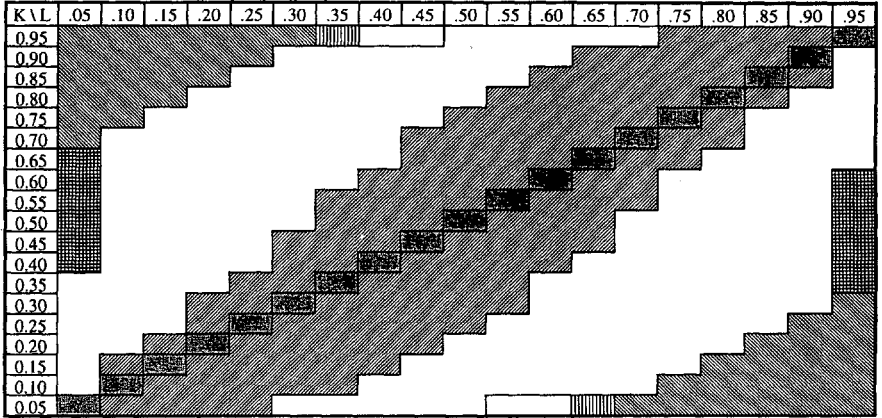

$\tau = 0.0$

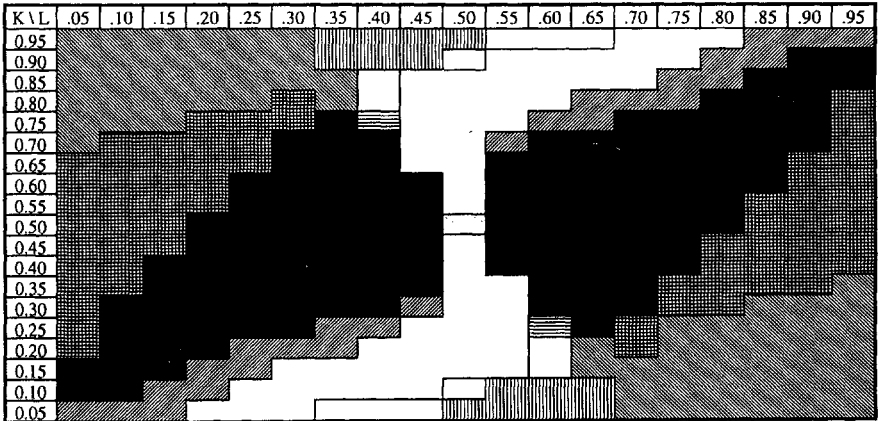

$\tau = 0.08$ * Directions of trade and investment flows are given for endowment distributions above the diagonal. For distributions below the diagonal read country f instead of country d. ** For distributions to the left of the (vertical) equal-labor-distribution line.

4.3 The Trade-FDI Relationship

With respect to foreign direct investment, a contentious policy issue is whether domestic jobs are exported in the wake of increasing investment abroad.⁹ Contrary to this „national“ point of view, the theoretical literature has discussed the issue from a more global perspective, i.e. whether the relationship between goods trade and factor mobility is one of substitutability or complementarity (e.g. Mundell 1957, Markusen 1983). While the latter studies conceptualize substitutability and complementarity in a number of ways, Wong (1995, p. 99) proposes two intuitive definitions. In the price-equalization sense trade and capital mobility are substitutes if free capital flows lead to goods price equalization and/or free commodity trade leads to factor price equalization. In the quantitative-relationship sense capital movements and goods trade are substitutes if increasing capital flows lower trade volumes and/or if bigger trade volumes diminish factor flows.¹⁰

The simulation results presented so far contribute to the debate in terms of clarifying the role of different relative and absolute factor endowments as well as varying trade costs in the FDI-trade relationship. However, since the model outlined in Section 2 is strictly static, arguments advanced, for instance, in the literature on the optimal timing of investment, cannot be dealt with. Moreover, the question whether trade precedes or follows investment is irrelevant in this context because trade and investment are driven by factor proportions differences and the proximity-concentration tradeoff. Moreover, the general equilibrium, market clearing nature of the model does not allow to draw any conclusions with respect to temporary unemployment in the wake of changes in FDI flows.

The results presented in Figure 7 are derived by applying the quantitative-relationship concept. For total FDI and the volume of X-related goods trade (exports of the final good plus intrafirm trade in the intermediate input), the covariance matrix was calculated. Generally, the simulation model suggests that the overall relationship between trade and FDI is substitutive in the quantitative-relationship sense with correlation coefficients of (-0.5692) for the 8 percent transport cost scenario and (-0.6861) when transport costs are absent. In other words, more FDI diminishes trade volumes. Under special circumstances, however, trade and FDI can be complements. For instance, when transport costs are 8 percent, relative endowments are similar but absolute endowments and income levels differ substantially, FDI and trade are complements: the more foreign direct investment is undertaken, the more trade occurs. Because of the big difference in country size very little trade occurs and capital flows are minor as the small country is not able to absorb more imports or to provide more capital to be deployed abroad.

More interestingly, the second region where trade and FDI appear to be complements is when relative endowments differ substantially but income levels are fairly similar. In this region, trade as well as FDI exceed their average values. Because the countries are dissimilar with respect to relative factor endowments the multinational firms of the capital-abundant country export large quantities of capital and import similarly large quantities of the intermediate input to be used for final production at home. In addition, the similarity in income levels fosters intraindustry trade in good X.

The results for the case where there are no transport costs are not too different. Whereas trade and FDI are substitutes in most cases there are again two regions where they are complements. This is the case when income levels differ to a large degree. Besides the size effect described

above, the other obvious reason for this outcome is that for most of the corner regions there are no capital flows and hence no trade in intermediate inputs. The second small area where the relationship is complementary is when income levels as well as relative factor endowments differ somewhat but not too much. On the one hand, similarity in income levels allows some exporters to be competitive, on the other hand, factor price differences make multinational firms competitive so that investment abroad as well as trade are above their average values.

Figure 7: Complementarity between Trade and Foreign Direct Investment

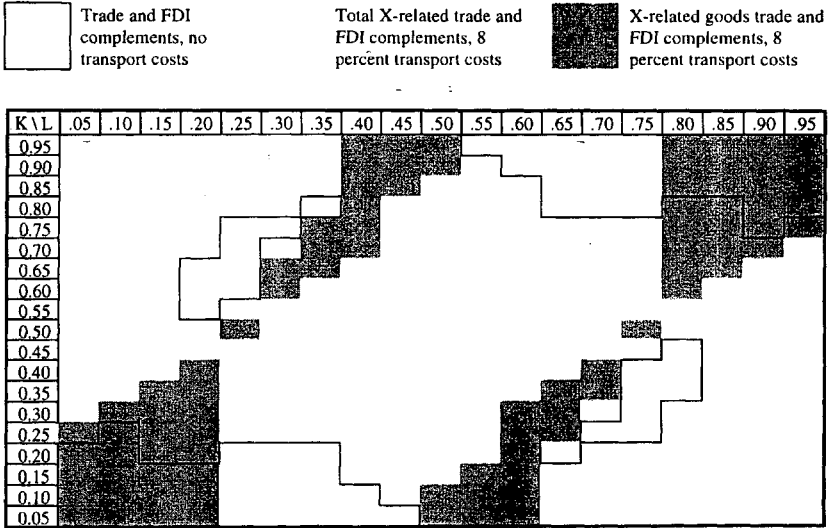

The lightly shaded area indicating total X-related trade also comprises the darker area confined to X-related goods trade.

So far, the simulations uphold the argument that more FDI leads to lower trade volumes. However, as more foreign direct investment coincides with higher exports of services the substitutive element in the trade-investment relationship should be weaker than indicated so far. Indeed, taking trade in services (measured in terms of markup revenues generated abroad) into account alters the results considerably. For both transport cost scenarios the value of the correlation coefficient increases substantially. Especially in the 8 percent transport cost scenario, results differ profoundly. Here, the regions where trade and FDI are complements are far bigger than without service trade (represented by the two shaded areas together). In particular, the area where country size only differs somewhat now covers a far broader range of income levels. The reason is that those are the areas where multinationals do not only produce substantial quantities of the intermediate input abroad but also have a big market share in the X-market of the (still) richer foreign country. Hence they generate handsome markup revenues which are repatriated.

Overall, the simulation results suggest that FDI and trade in X-related goods and services are weak substitutes. This is particularly true when absolute endowments and income levels are

both either very different or very similar. If, however, countries significantly differ in relative factor endowments or income and are similar with respect to the other then trade and capital flows in fact appear to be complements.

4.4 Factor Prices

Without transport costs, the two countries are fully integrated in the sense that there are no external factors which inhibit the free movement of goods. In this scenario, identical relative factor endowments always imply factor price equalization. As there are no multinational firms, X is traded and although intraindustry trade exists the net exports of X are zero. Whereas most partial equilibrium oligopoly models suggest that due to a home market bias the big country is the net exporter of good X (e.g. Brander 1981) this is not necessarily true in a general equilibrium framework with an endogeneous market structure. Adjustment in relative factor prices assures that exporters in both countries are identical in every way, including size. Therefore no firm can charge a lower markup and the only difference between the X sectors in the two countries is that the big country accomodates a higher number of firms. With relative factor endowments differing, however, factor price equalization breaks down almost immediately. Even the existence of vertical MNEs is insufficient to bring about factor price equalization when relative endowments differ widely. This finding remains valid for situations where one-way trade in X complements one-way capital flows.

The existence of positive transport costs should by itself reduce the degree of factor price equalization because it inhibits trade. Evidently, this effect is more than offset by the emergence of MNEs which promote factor price equalization by transferring capital from the low rental rate country to the high rental rate country. As it turns out this direct mechanism of factor price equalization is much more effective than the indirect way via the factor content of trade. The widening of the area with full factor price equalization in the center of the figure does therefore not come as a surprise as there are now MNEs complementing intraindustry trade. Somewhat astonishing is that MNEs bring forth (near) factor price equalization in most parts of the figure, especially in areas where there was none before. The reason for this is that direct production abroad replaces intraindustry trade, switching from the indirect mechanism of factor price equalization to the direct one. Only in the most divergent factor distributions, capital movements, though existing, fail to achieve factor price equalization.

Whether trade and factor movements are complements or substitutes in the price-equalization sense of Wong (1995) can only be answered loosely. Because factor trade is not free¹¹ only the weak version of the concept is applicable, demanding that free trade must imply factor price equalization. The somewhat shaky conclusions which can be drawn are that with zero transport costs the relationship is substitutive only when relative factor endowments are similar whereas in the case of positive transport costs substitutability prevails in a wider range of endowment combinations. At least with respect to the positive transport cost scenario this is in line with the findings for the quantitative-relationship concept although the areas for substitutability and complementarity are not fully congruent.

4.5 The Role of Multinational Enterprises

So far, the simulations demonstrated that the role of multinational firms looms larger the higher transport costs are, i.e. the stronger proximity advantages are felt. Unless relative factor

endowments are so different that even with zero transport costs there are only MNEs, higher transport costs always increase affiliate sales and lower trade volumes in the oligopolistic market. This is because transport costs inhibit intraindustry trade and weaken the drive for factor price equalization which promotes vertical multinational firms. With positive transport costs, MNEs are dominant when relative endowments diverge and play an important role when converging relative endowments coincide with converging income levels (Figure 1).

Often, the economic importance of MNEs is assessed in terms of stocks or flows of FDI. However, as Brainard (1993b) points out this is a severe conceptual mismatch because the transaction analog to international trade are sales of MNE foreign affiliates, not FDI. One of the main reasons why the two concepts should not be used interchangeably is that once a foreign investment has been carried out it can, in principle, continue to produce forever so that in the years after the particular FDI was reported sales of foreign affiliates can remain positive while there is no more FDI¹². Since this model is a one-period model no conclusions can be drawn in this respect. However, the simulation results show that even in a single-period factor proportions model with a proximity-concentration tradeoff volumes of FDI and affiliate sales do not follow a functional relationship and that therefore one cannot be used as a proxy of the other.

Figure 8: Degree of Factor Price Equalization

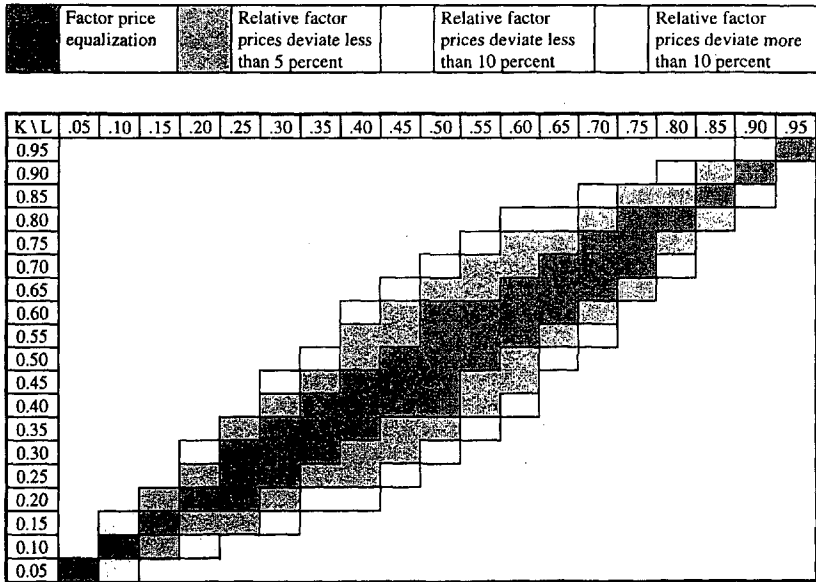

$\tau = 0.0$

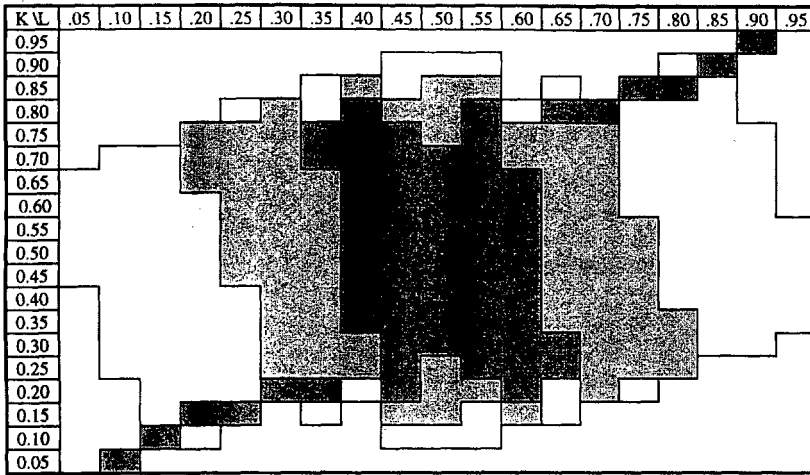

$$\tau = 0.08$$

One way of assessing the role of MNEs is to look at their market shares in the home and the foreign market or at the combined world market shares of domestic and foreign MNEs. With respect to the importance of MNEs in national markets some general trends are noticeable. For any labor endowment, increasing a country's capital stock always increases the market share of domestic MNEs (if some MNEs exist) until it reaches one. The reason is that redistributing capital from the foreign to the domestic country tends to increase the domestic wage-rental ratio, thereby strengthening MNEs if they are of the vertically integrated type. By the same token, increasing the domestic country's labor endowment leads to decreasing market shares of domestic MNEs at home and abroad (once they are smaller than one, i.e. other firm types become competitive). Only at the centre region is this not true. Since horizontal MNEs are most competitive when both countries have identical factor endowments, factor redistribution towards equality increases the market shares of domestic as well as foreign MNEs in both countries and therefore in the world market. This implies that for intra-industry FDI raising (reducing) the capital-abundant country's labor (capital) supply favors domestic and foreign MNEs if this narrows the endowment gap between the two countries.

The fact that in the absence of significant factor price differentials MNEs are more competitive the more similar countries are also explains why MNEs tend to have higher market shares in small markets. One consequence is that MNEs from the low income country tend to have higher market shares in their home market, whereas MNEs from the rich country enjoy bigger market shares in the foreign country. The role that MNEs play in the oligopolistic world market can be assessed in terms of the combined world market share of domestic and foreign MNEs. World market shares are highest when relative endowments differ substantially (and in fact only MNEs of one of the two countries exists) or when relative endowments and income levels are similar and horizontally integrated MNEs of both countries exist. This pattern repeats itself when looking at the share of affiliate sales in total trade plus affiliate sales which can be taken as a proxy for the role of MNEs in international transactions (Figure 9).

Figure 9: Share of Affiliate Sales in Total Trade and Affiliate Sales

0 - 10	10.01 - 25	25.01 - 40	40.01 - 55	55.01 - 70	70.01 - 100
--------	------------	------------	------------	------------	-------------

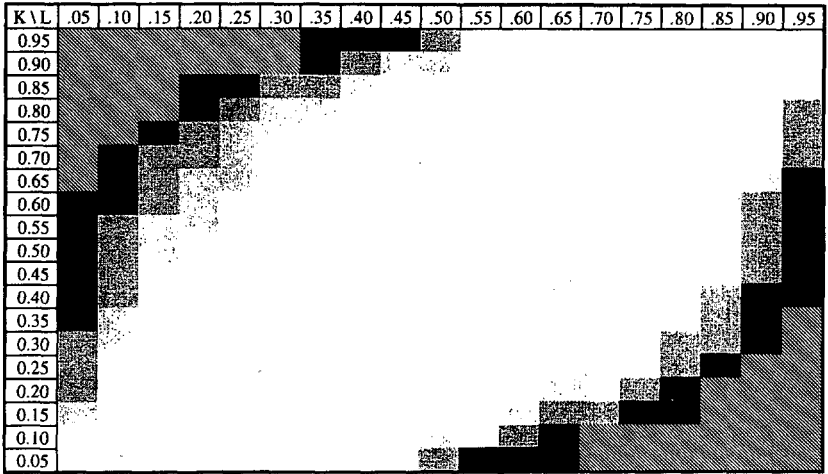

$\tau = 0.0$

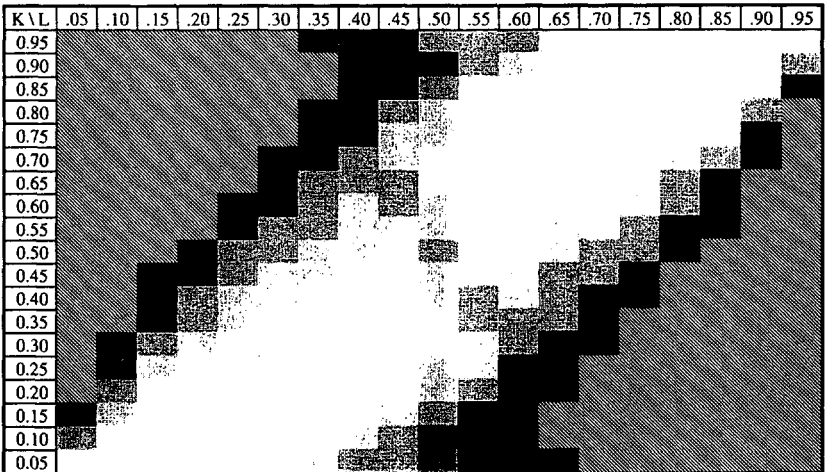

$\tau = 0.08$

5. Conclusions

The paper sets up a fairly general model of trade, foreign direct investment, and multinational enterprises based on differences in factor proportions and a proximity-concentration tradeoff. It covers a number of theoretical models (Horstman, Markusen 1992b, Brainard 1993a) as well as simulation studies (Markusen, Venables 1995, Konan et al. 1996) as special cases. The new feature of the model is that MNEs cannot only split up their product process and transfer their technologies to their foreign affiliates but that they can deploy part of their capital stock abroad. With a three stage production process, the simulations identify the circumstances under which vertically and/or horizontally integrated MNEs exist and establish the conditions for one-way capital flows (downstream and upstream) and the cross-hauling of FDI. At the same time, the model explains intraindustry trade in the oligopolistic market as well as in services and intermediate inputs. Generally, it is found that specialization is broadly in line with factor endowments. However, because factors cannot only be exchanged indirectly through trade but in the case of capital can be directly transferred abroad more complex links between the two countries occur. When relative factor endowments are very different vertically integrated MNEs dominate and all labor-intensive goods are produced in the labor-abundant country. Accommodating headquarters of domestic MNEs does not depend on a country's size but on the fact that it is capital-abundant. The only exception is when transport costs are positive and factor endowments very similar. With zero transport costs, intraindustry trade dominates the oligopolistic market when relative factor endowments are not too different or when the distribution of the world capital stock is not too uneven. With positive transport costs, intraindustry trade only occurs when income levels are very similar and relative endowments are not too different. When income levels and relative factor endowments are similar, intraindustry trade exists as well as cross-hauling of FDI carried out by (horizontal) MNEs of both countries. Increasing transport costs generally leads to higher levels of FDI and to dropping total trade volumes although the decrease in trade in the final product is partially offset by increases in the trade in intermediate inputs and services. Independent of the level of transport costs, trade and FDI are identified as weak substitutes. However, when relative endowments are similar but absolute endowments differ greatly or when income levels are similar but relative endowments differ substantially, trade and FDI are weak complements.

One obvious result of the paper is that at times small changes in the distribution of factor endowments can lead to very different production, trade and FDI patterns. In other situations, factor redistributions of similar magnitude produce only marginal adjustments. This result is important for devising sound economic policies. It emphasizes that in some situations a set of specific policy tools can achieve its goals while in similar situations it may completely fail to do so or even produce detrimental results. The reason simply is that a change in a country's factor endowment can alter the previously existing production and/or trade regime entirely. Therefore the amount of information necessary for finetuning economic policies is tremendous. In the light of these findings, it seems that most models which explicitly deal with normative issues of economic policy making are overly simplistic and might therefore come up with policy advice that cannot be generalized. This is particularly true if economic policies are themselves dynamic in the sense that they change domestic factor endowments and thereby a country's relative position in the world. In this case, the policies may bring about exactly the type of change that renders them ineffective or even harmful. The paper, however, did not attempt to analyze any specific type of economic policy. As the model provides a fairly general framework future research will address policy issues more directly. Besides fairly obvious candidates such as trade and investment policies, it will be worthwhile to

analyze strategic industrial policies and the taxation of capital income in a general equilibrium framework with a distinct international structure.

Despite its fairly general nature with respect to the international aspects, the model is severely deficient in other aspects. Most desirable would be to change its static nature into a dynamic one. This is important in two ways. First, the static Cournot behavior of firms is too restrictive. Multinational firms do take future periods into consideration and thereby future actions and responses of competitors. Secondly, factor endowments which were assumed to be supplied inelastically change over time. In particular, growth of national capital stocks brought about by endogeneous decisions to save and invest should be included and could provide additional insight into how a country's comparative advantage shifts over time as well as how the balance between national exporters and multinational firms develops in due course. Finally, the specific approach of simulation studies could be exploited by including more than two countries, thereby deriving an explicit geographical structure of trade and investment. This could be done by interpreting differences in transport costs as differences in distance between countries. The results of this study indicate, for example, that big capital-abundant countries would set up foreign affiliates in big labor-abundant countries far away and export to small capital-abundant countries close by.

Finally, the model can be used as a starting-point for empirical research. First, simplified versions of the model could be simulated with real world data with the emphasis on assessing the effects of economic policies, e.g. comparing the impact of a tax policy with varying tax rates. Secondly, the model allows the derivation of very specific hypotheses well beyond those presented in this paper. These hypotheses could then be subjected to econometric tests replacing the ad-hoc assumptions occasionally used in econometric studies.

References

- Brainard, S. Lael (1993a): *A Simple Theory of Multinational Corporations and Trade with a Tradeoff between Proximity and Concentration*, NBER Working Paper No. 4269, Cambridge, Mass.
- Brainard, S. Lael (1993b): *An Empirical Assessment of the Proximity-Concentration Tradeoff between Multinational Sales and Trade*, NBER Working Paper, No. 4580, Cambridge, Mass.
- Brainard, S. Lael (1993c): *An Empirical Assessment of the Factor Proportions Explanation of Multinational Sales*, NBER Working Paper, No. 4583, Cambridge, Mass.
- Brander, James A. (1981): *Intra-industry Trade in Identical Commodities*, Journal of International Economics, Vol. 11, No. 1, 1-14.
- Brander, James A, Paul R. Krugman (1983): *A 'Reciprocal Dumping' Model of International Trade*, Journal of International Economics, Vol. 15, 313-323.
- Buckley, Peter J., Mark Casson (1976): *The Future of the Multinational Enterprise*, London.
- Casson, Mark (1986): *Multinationals and World Trade: Vertical Integration and the Division of Labour in World Industries*, London.
- Dunning, John H. (1977): *Trade, Location of Economic Activity and the MNE: A Search for an Eclectic Approach*, in: B. Ohlin, P.O. Hesselborn and P.M. Wijkman (eds.), *The International Allocation of Economic Activity*, London, 395-418.
- Dunning, John (1988): *Explaining International Production*, London.
- Ethier, Wilfrid (1986): *The Multinational Firm*, Quarterly Journal of Economics, Vol. CI, No. 4, 805-833.
- Friedman, James W. (1983): *Oligopoly Theory*, Cambridge.
- Graham, Edward M. (1995): *Foreign Direct Investment in the World Economy*, in: International Monetary Fund, *Staff Studies for the World Economic Outlook*, Washington, 120-135.
- Graham, Edward M., Paul R. Krugman (1995): *Foreign Direct Investment in the United States*, Third edition, Washington, D.C.
- Helpman, Elhanan, Paul R. Krugman (1985): *Market Structure and Foreign Trade*, Cambridge, Mass.
- Horstmann, Ignatius, James R. Markusen (1987): *Licensing versus Direct Investment: A Model of Internalization by the Multinational*, Canadian Journal of Economics, Vol. XX, No. 3, 464-481.
- Horstmann, Ignatius J., James R. Markusen (1992a): *Exploring New Markets: The Multinational Firm's Choice of Direct Investment versus Licensing*, Institut for International Economic Studies Seminar Paper No. 528, Stockholm.
- Horstmann, Ignatius J., James R. Markusen (1992b): *Endogeneous Market Structures in International Trade (Natura Facit Saltum)*, Journal of International Economics, Vol. 32, No. 1, 109-129.
- Hymer, Stephen H. (1960): *The International Operations of National Firms: A Study of Direct Foreign Investment*, MIT Ph.D. dissertation published in 1976, Cambridge, Mass.
- International Monetary Fund [IMF] (1996): *Balance of Payments Statistics Yearbook*, Washington, D.C.
- Itaki, Masahiko (1991): *A Critical Assessment of the Eclectic Theory of the Multinational Enterprise*, Journal of International Business Studies, Vol. 22, 445-460.
- Klau, Arne Ragnar (1995): *Firmeninterner Handel. Eine theoretische und empirische Analyse des unternehmensinternen Aussenhandels multinationaler Unternehmen*, Berlin.

- Konan, Eby, James R. Markusen, Anthony J. Venables, Kevin Zhang (1996): *A Unified Treatment of Horizontal Direct Investment, Vertical Direct Investment and the Pattern of Trade in Goods and Services*, paper presented at the European Trade Workshop in International Trade, Glasgow, September 5-8, 1996.
- Koop, Michael J. (1997): *Intrafirm Trade of US Multinationals*, mimeo.
- Krugman, Paul R. (1979): *Increasing Returns, Imperfect Competition, and International Trade*, Journal of International Economics, Vol. 9, 469-479.
- Krugman, Paul R. (1983): *The 'New Theories' of International Trade*, in: David B. Audretsch, Charles P. Kindleberger, *The Multinational Corporation in the 1980s*, 57-73, Cambridge, Mass.
- Lerner, Abba (1934): *The Concept of Monopoly and the Measurement of Monopoly Power*, Review of Economic Studies, Vol. 1, 157-175.
- Markusen, James R. (1983): *Factor Movements and Commodity Trade as Complements*, Journal of International Economics, Vol. 14, 341-356.
- Markusen, James R. (1984): *Multinationals, Multi-plant Economies, and the Gains from Trade*, Journal of International Economics, Vol. 16, No. 1, 205-226.
- Markusen, James R., Anthony J. Venables (1995): *Multinational Firms and the New Trade Theory*, NBER Working Paper No. 5036, Cambridge, Mass.
- Markusen, James R., Anthony J. Venables (1996): *The Theory of Endowment, Intra-industry and Multinational Trade*, CEPR Discussion Paper No. 1341, London.
- Mundell, Robert (1957): *International Trade and Factor Mobility*, American Economic Review, Vol. 67, 321-335.
- Rugman, Alan M. (1986): *New Theories of the Multinational Enterprise: An Assessment of Internalization Theory*, Bulletin of Economic Research, Vol. 38, No. 2, 101-117.
- Shapiro, Daniel M. (1983): *Entry, Exit, and the Theory of the Multinational Corporation*, in: Charles P. Kindleberger and David B. Audretsch (eds.), *The Multinational Corporation in the 1980s*, 103-122, Cambridge, Mass.
- Stehn, Jürgen (1992): *Ausländische Direktinvestitionen in Industrieländern*, Tübingen.
- United Nations Conference on Trade and Development [UNCTAD] (1995): *World Investment Report 1995*, New York, Geneva.
- US Department of Commerce, Bureau of Economic Analysis (1992): *US Direct Foreign Investment Abroad: 1989 Benchmark Survey*, Washington, D. C.
- Wong, Kar-yiu (1986): *Are International Trade and Factor Mobility Substitutes?*, Journal of International Economics, Vol. 21, No. 1, 25-43.
- Wong, Kar-yiu (1995): *International Trade in Goods and Factor Mobility*, Cambridge, Mass.
- World Trade Organization [WTO] (1996): *Trade and Foreign Direct Investment*, Report No. 96-3995, Geneva.

Appendix

Country Positions with Respect to Relative Factor Abundance and Income

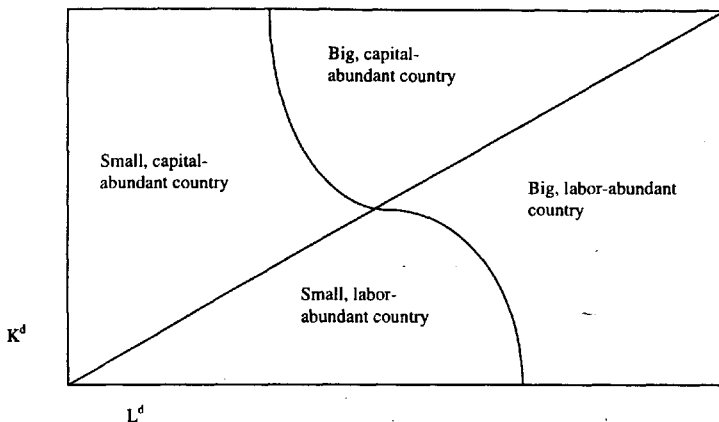

Endnotes

¹ For an extended version see Stehn (1992).

² An extensive critique of the eclectic theory is provided by Itaki (1991).

³ For a comprehensive overview of internalization motives see Klau (1995).

⁴ A survey carried out by the US Bureau of Economic Analysis found that on average more than 55 percent of US intrafirm trade consisted of intermediate inputs (US Department of Commerce, 1992, 247). Around 50 percent of intrafirm trade with affiliates in European countries consisted of intermediate inputs while this ratio increases with difference in the GDP levels per capita (more than 90 percent of US intrafirm trade with Mexico was in intermediate inputs).

⁵ The MNEs considered here always contain an element of horizontal integration because they produce the final output in both countries but also an element of vertical integration because they produce the intermediate input abroad.

⁶ The model was simulated using the GAMS subsystem MPSGE.

⁷ Still, even this smooth type of structural change may cause serious adjustment problems if labor is not perfectly mobile across sectors. If, for instance, different types of qualification prevail in the different sectors and retraining takes time, temporary unemployment is likely to emerge.

⁸ For small and medium-sized countries the results indicate that export shares are highest when relative factor endowment are close to the world factor endowment ratio. In most of these cases factor price equalization prevailed so that there were no vertical MNEs. Hence all exchange of factors occur in terms of factor content of trade.

⁹ Graham, Krugman (1995) rightly argue that full employment is not affected much by changes in FDI in the long run. However, in economies with labor market regulations that only allow structural

change to take place over a longer period of time, increasing capital outflows may cause unemployment to rise.

¹⁰ Wong (1995) further divides the two definitions into a strong and a weak version according to whether the statements hold in the „and“ or only in the „or“ form. For additional conceptualization of the substitutability-complementarity issue see Wong (1986).

¹¹ Capital is only mobile to the extent that it is employed in MNEs while labor is internationally immobile altogether.

¹² Given that the investment abroad is profitable, the profits would also constitute FDI because FDI is usually defined as the increase in the book value of the net worth of investment in other countries (Graham 1995).