

Rosellón, Juan; Mysliková, Zdenka; Zenón, Eric

Working Paper

Incentives for transmission investment in the PJM electricity market: FTRs or regulation (or both?)

DIW Discussion Papers, No. 1026

Provided in Cooperation with:

German Institute for Economic Research (DIW Berlin)

Suggested Citation: Rosellón, Juan; Mysliková, Zdenka; Zenón, Eric (2010) : Incentives for transmission investment in the PJM electricity market: FTRs or regulation (or both?), DIW Discussion Papers, No. 1026, Deutsches Institut für Wirtschaftsforschung (DIW), Berlin

This Version is available at:

<https://hdl.handle.net/10419/46197>

Standard-Nutzungsbedingungen:

Die Dokumente auf EconStor dürfen zu eigenen wissenschaftlichen Zwecken und zum Privatgebrauch gespeichert und kopiert werden.

Sie dürfen die Dokumente nicht für öffentliche oder kommerzielle Zwecke vervielfältigen, öffentlich ausstellen, öffentlich zugänglich machen, vertreiben oder anderweitig nutzen.

Sofern die Verfasser die Dokumente unter Open-Content-Lizenzen (insbesondere CC-Lizenzen) zur Verfügung gestellt haben sollten, gelten abweichend von diesen Nutzungsbedingungen die in der dort genannten Lizenz gewährten Nutzungsrechte.

Terms of use:

Documents in EconStor may be saved and copied for your personal and scholarly purposes.

You are not to copy documents for public or commercial purposes, to exhibit the documents publicly, to make them publicly available on the internet, or to distribute or otherwise use the documents in public.

If the documents have been made available under an Open Content Licence (especially Creative Commons Licences), you may exercise further usage rights as specified in the indicated licence.

Discussion Papers

1026

Juan Rosellón • Zdenka Mysliková • Eric Zenón

**Incentives for Transmission Investment
in the PJM Electricity Market:
FTRs or Regulation (or Both?)**

Berlin, June 2010

Opinions expressed in this paper are those of the author(s) and do not necessarily reflect views of the institute.

IMPRESSUM

© DIW Berlin, 2010

DIW Berlin
German Institute for Economic Research
Mohrenstr. 58
10117 Berlin
Tel. +49 (30) 897 89-0
Fax +49 (30) 897 89-200
<http://www.diw.de>

ISSN print edition 1433-0210
ISSN electronic edition 1619-4535

Available for free downloading from the DIW Berlin website.

Discussion Papers of DIW Berlin are indexed in RePEc and SSRN.
Papers can be downloaded free of charge from the following websites:

http://www.diw.de/de/diw_01.c.100406.de/publikationen_veranstaltungen/publikationen/diskussionspapiere/diskussionspapiere.html
<http://ideas.repec.org/s/diw/diwwpp.html>
http://papers.ssrn.com/sol3/JELJOUR_Results.cfm?form_name=journalbrowse&journal_id=1079991

Incentives for Transmission Investment in the PJM Electricity Market: FTRs or Regulation (or Both?)¹

Juan Rosellón²

Zdeňka Myslíková³

and

Eric Zenón⁴

Abstract

This paper presents an application of a mechanism that provides incentives to promote transmission network expansion in the area of the US electric system known as PJM. The applied mechanism combines the merchant and regulatory approaches to attract investment into transmission grids. It is based on rebalancing a two-part tariff in the framework of a wholesale electricity market with locational pricing. The expansion of the network is carried out through the sale of financial transmission rights for the congested lines. The mechanism is tested for 14-node and 17-node geographical coverage areas of PJM. Under Laspeyres weights, it is shown that prices converge to the marginal cost of generation, the congestion rent decreases, and the total social welfare increases. The mechanism is shown to adjust prices effectively given either non-peak or peak demand.

Keywords: Electricity transmission expansion, incentive regulation, PJM

JEL-code: L51, L91, L94, Q40

¹ We thank Jeff Pavlovic for valuable help with data processing, and Hannes Weigt for helpful comments. Juan Rosellón acknowledges support from Pieran_Colegio de México, the Alexander von Humboldt Foundation, and Conacyt (p. 60334). The usual disclaimer applies.

² Corresponding author, Centro de Investigación y Docencia Económicas (CIDE), and German Institute for Economic Research (DIW-Berlin). Contact details: Mexico: División de Economía, Carretera México-Toluca 3655, Mexico, D.F., 01210, Mexico; Tel.: +52-55-57-27-9800, ext. 2711, fax: +52-55-57-27-9878; email: juan.rosellon@cide.edu.

³ Centro de Investigación y Docencia Económicas (CIDE).

⁴ Facultad de Ingeniería, Universidad Nacional Autónoma de México (UNAM).

I. Introduction

Government led reforms of the electric industry have taken place in the United States of America (USA) since the 1990s. The restructuring of the industry was concerned with changing the system historically treated as a natural monopoly to a free market industry. The generation and the distribution segments of the system were opened to competition. Transmission services, because of its characteristics, stayed as a monopoly under regulation. While the generation and distribution sectors were thus flourishing under the reforms, the transmission sector experienced a shortfall in necessary investment because it lacked incentives for development. The system has become congested in various areas as growth in electricity demand and investment in new generation facilities have not been matched by investment in new transmission facilities.⁵

The transmission network is a critical part of the system, and in the last decade transmission expansion became a crucial issue for the Federal Energy Regulatory Commission (FERC) and the US Department of Energy (US Department of Energy, 2002 and 2006). It was then understood that without efficient transmission expansion, the electric grid in the near future would be stretched far beyond its capacity increasing dramatically the final cost of electric energy, and negatively affecting the entire economy. Present-day reforms are searching for optimal mechanisms that would provide adequate transmission investment incentives to guarantee expanding the capacity of the network and relieve congestion problems. One area with congestion problems in its electricity networks is the US region known as PJM.⁶ Our paper proposes and applies a mechanism that provides adequate incentives to promote expansion of the network in this area.

This paper is organized as follows. In Section II, we review the literature on incentive mechanisms for the expansion of electric transmission networks. Section III reviews the features of the PJM electricity transmission market, its current transmission pricing and investment policies. Section IV provides description of the mechanism used in this paper for transmission expansion in the PJM region. It is an application of a merchant-regulatory mechanism where the optimization problem is treated as a two-level (or bi-level) programming problem of a Transmission Company (Transco), and an Independent System Operator (ISO). The Transco maximizes its benefit subject to a regulatory constraint (upper level problem). The ISO solves an optimal dispatching problem maximizing the social welfare (lower level problem). The two levels are solved simultaneously. In

⁵ For a detailed analysis see the National Transmission Grid Study (NTGS) from US Department of Energy (2002) or Joskow (2005a).

⁶ PJM is an abbreviation for the region operated by PJM Interconnection. The letters P-J-M represent names of its three original principal member states: Pennsylvania, New Jersey and Maryland.

Section V, the details of the simulation of the model are explained. The mechanism is tested for 17-node geographical coverage area of PJM, divided into zones according to the historical utilities control areas. The analysis addresses market efficiency and changes in social welfare caused by changes in nodal prices (an extension of the analysis for a modified region is provided in the appendix). Section VI concludes.

II. Review of Literature – Incentive Mechanisms in Electricity Transmission

This section presents a survey of current research paths on transmission expansion mechanisms. We survey three approaches according to basic assumptions about whether the transmission sector can sustain competition, and according to the tools --regulatory, merchant and combined merchant-regulatory tools-- employed by the mechanism.⁷

There are two basic regulatory approaches suggested in the literature. First, there is a regulatory mechanism based on price regulation (Vogelsang, 2001). This mechanism relies on the rebalancing of the two (fixed and variable) parts of a price-capped tariff. The fixed part of the tariff is an instrument through which long-term costs are recuperated (i.e., it is a complementary charge). The variable part can be understood as a nodal price difference in the sense of the financial transmission right (FTR) literature (Rosellón, 2003). The Transco rebalances over time the two parts of the tariff while meeting the price cap established by the regulator, and efficiently expands the network. The expansion process takes place so that incentives to keep the network congested are broken and, under certain conditions, there will be convergence to a steady-state Ramsey-type of equilibrium.⁸ However, a critical aspect of the regulatory mechanism is its definition of the transmission output as the capacity flow between two points, and also that its reliance on assumed smoothly behaved properties of production and cost functions of transmission services which --both in theory and practice-- are difficult to establish. Hogan (2002) argues that the properties of these functions are not well known (the functions are considered not linear), and are suspected to be generally non-differentiable and even discontinuous. Also, the definition of transmission output in

⁷ Apart from the three main approaches, usually one more is mentioned in the literature. This approach defines optimal expansion of the transmission network according to the strategic behavior of generators, and considers conjectures made by each generator on other generators' marginal costs due to the expansion. It explicitly models the existing interdependence of generation investment and transmission investment. However, it also relies on a transportation model with no network loop flows.

⁸ The model reconciles allocative, productive and even distributive efficiencies as well as promotes convergence to Ramsey prices. Likewise, the expansion process is incentivated since, with the use of the mechanism, the expected revenues from expanding the network become greater than or equal to the revenues from keeping the network congested. Convergence to a "congestion" equilibrium --where the marginal cost of expanding the network equals the congestion cost of not adding an additional unit of capacity-- is also achieved (see Crew, Fernando, and Kleindorfer, 1995, Vogelsang, 2001, and Hogan, Rosellón and Vogelsang, 2007).

meshed networks is a difficult issue. Under the definition of transmission output that he uses, the Vogelsang (2001) mechanism can typically be applied to radial lines only.

The second regulatory approach is based on a measure of welfare loss with respect to the Transco's performance. The basic approach used in Léautier (2000) and similarly in Joskow and Tirole (2002) is that the regulator rewards the Transco when the capacity of the network is increased so that congestion rents are decreased. On the other hand, the regulator can punish the Transco for taking advantage of a congested network by charging increasing fees, and accumulating higher congestion rents. Another variation is an "out-turn" based regulation. The out-turn is defined as the difference between the price for electricity actually paid to generators and the price that would have been paid absent congestion (Léautier, 2000). The Transco is made responsible for the full cost of out-turn, plus any transmission losses.

The merchant approach to transmission expansion aims to bring competition into the transmission expansion process through the assignment of property rights specified as FTRs. An FTR is a financial instrument that allows the value of increased transmission capacity to be security and auction competitive, facilitating the entry of the private sector into transmission expansion investment (Hogan, 2002). FTRs are defined according to transmission capacity between nodes with different prices, and grant their owner the right to collect the difference between the nodal prices. This process motivates investment. The assignment of FTRs is managed by the ISO. Under loop flows within a meshed transmission network, negative externalities might arise on property-right holders since the expansion of one link in the network might affect the capacities of other links. Kristiansen and Rosellón (2006) suggest a solution to this issue where the ISO retains some "unallocated FTRs" to use in case that negative externalities arise during the expansion process. They argue that using unallocated FTRs prevents a gaming- behavior of investors.

The last approach to transmission expansion aims to bring together the main tools of both the merchant and regulatory mechanisms. Hogan, Rosellón and Vogelsang (2007) design a combined model where price-cap regulation is merged with a redefinition of transmission output in terms of FTRs. This allows that FTR auctions inherit the regulatory logic in Vogelsang (2001). Conversely, the combined approach upgrades the Vogelsang model into a bi-level programming model where an ISO maximizes dispatch through a power-flow model providing the optimal loads and nodal prices needed to achieve expansion in meshed networks according to the rebalancing of each part of the two-part tariff. Rosellón and Weigt (2008) further combine the merchant and regulatory price-cap mechanisms with an engineering approach to calculating locational marginal prices (LMPs). They prove that this approach is effective in incentivizing investment in a real transmission network in Northwestern Europe.

III. The PJM Electricity Market

The US transmission network is a part of the North American electricity transmission system which consists of three interconnected systems - the Western Interconnect, the Eastern Interconnect, and the Electric Reliability Council of Texas (ERCOT). Together they comprise the bulk power system in the USA, much of Canada and a small portion of Mexico. Each system is coordinated independently within its power grid and the three systems are not synchronized together (electricity cannot flow between them except through the use of asynchronous tie lines). The current day organization of the electric industry in the USA differs across the states. In general there is no agreement or policies (or mechanism employed) that would establish how appropriate transmission investments should be identified, who bears the responsibility for making the investments, and who pays for the associated costs (Joskow 2005b). While in some states (or regions)⁹ the operation via wholesale competitive market was accepted, other regions keep the industry under a completely regulated system without any marks of competitive market. No pure merchant system exists in any state. Even if FERC maintains the function of the regulator of “last instance” (exercising principal regulatory authority over interstate wholesale trade, and the associated transmission interconnection) the electric power industry in the USA has historically been regulated primarily by the states¹⁰. The legal responsibilities for important aspects of transmission policy are split between the federal government and the states. Each state or region has unique circumstances and organization of the transmission sector, and applied transmission investment policies.

Investor-owned utilities (IOUs) own 73 percent of the transmission lines, federally owned utilities own 13 percent, and public utilities and cooperative utilities own 14 percent¹¹. On one hand, in regions with wholesale markets (such as PJM, New York and New England), LMPs are widely used and FTRs could be used as a risk hedging tool.¹² Considering the investment to the transmission network, it is not always clear who should pay for it. When a new generator is included to the interconnection, reliability of the grid could be threatened, and new investment could be necessary to upgrade the grid. The new transmission investment costs could be projected into the basic charges for the transmission service reflected in their tariffs, or generators bear the costs. The exact policies differ from one market to another. On the other hand, in regions with pure regulation, transmission pricing and retail electricity power prices are usually calculated based on

⁹ For example in PJM area, New England, New York or California.

¹⁰ Joskow (2005b) argues that states in the USA have a variety of different views on the desirability of transitioning to competitive wholesale and retail electricity markets, and that there are has no clear and coherent national laws that adopt a competitive wholesale and retail market model as national policy.

¹¹ The values correspond to the year 2000 (Department of Energy, Energy Information Administration 1).

¹² In the New York Independent System Operator (NYISO)'s region FTRs are also known as long-term transmission rights or firm transmission rights.

cost of service or a utility's embedded costs plus a negotiated rate of return on their investments, and the transmission network expansion policy is planned by state. From the point of view of expansion of interconnection capacity between control area operators, there is no process in place that would systematically evaluate opportunities to expand transmission capacity on both sides of the borders between them (Joskow 2005b).

PJM Interconnection is a part of the eastern-interconnect grid nowadays managing high-voltage electric networks as well as the wholesale electricity market in which 13 states¹³ and the District of Columbia were included in 2008. It provides service to a population of approximately 51 million¹⁴. PJM is a Regional Transmission Organization (RTO). It is federally regulated, with the service in the area provided by IOUs and Public Owned Utilities (POUs).

As an RTO, PJM coordinates the movement of power within its region and is responsible for the operational and planning functions of the PJM bulk power system on behalf of participant members¹⁵. It also administers an open access transmission tariff that establishes prices for various categories of transmission services available to the third party transmission users, and defines how the associated revenues are distributed to the transmission owners (Joskow 2005b). It is not engaged in wholesale or retail marketing, and does not own generation, transmission or distribution assets. PJM actually operates four major product markets: energy¹⁶, capacity, FTRs, and the ancillary services markets. The price of transmission service offered by PJM is based on traditional regulatory cost-of-service (rate-of-return) formulas applied to one or more transmission owners.

The main features characterizing PJM markets are the use of LMPs and the existence of FTRs as a tool for hedging against the congestion costs.¹⁷ LMPs in PJM are defined as “the cost to serve the next MW of load at a specific location, using the lowest production costs of all available generation while observing all transmission limits” (PJM Member Training Department, 2007). In this way, the LMP reflects an equilibrium price including not only the value of available generation but the marginal losses and marginal cost of transmission congestion at each location as well. The LMPs in PJM are collected from 10 main hubs.¹⁸ The FTRs market provides the market participants an opportunity to hedge themselves against congestion in the energy market. FTRs are obtained

¹³ All or parts of Delaware, Illinois, Indiana, Kentucky, Maryland, Michigan, New Jersey, North Carolina, Ohio, Pennsylvania, Tennessee, Virginia, West Virginia.

¹⁴ After establishing competition in wholesale markets in the USA, PJM was the first largest wholesale competitive operating market in the world. Currently it is one of the biggest Operators in the USA together with NYISO, New England ISO, California ISO, and the Midwest ISO (MISO).

¹⁵ It is also responsible for maintaining the integrity of the regional power grid and for managing a regional planning process for generation expansion needed to ensure the reliability of the electric system (PJM Interconnection).

¹⁶ The administrated energy markets consist of real time and day-ahead markets.

¹⁷ Also the financial trading hubs, bilateral markets, day-ahead markets, real-time markets, ancillary services and installed capacity.

¹⁸ The ten hubs for which PJM posts prices are: AEP Gen (all generator buses in AEP), AEP-Dayton (all buses in AEP and Dayton), Chicago Gen, Chicago, Eastern, N Illinois, New Jersey, Ohio, West Int., and Western.

through annual and monthly auctions and bilateral trading.¹⁹ It has a form of a financial contract which enables the holder to receive revenues based on the day-ahead hourly energy price differences across a specified transmission path, and so give their holders the right to a proportionate share of annual congestion charges.

The transmission expansion planning is prepared by the RTO. There are several categories of transmission investments in PJM. When a new generating unit seeks to connect to the PJM network, the reliability criteria could be violated and an investment to the new transmission capacity could be needed. Also “merchant investment projects” (motivated by appearance of FTRs when a project is implemented) or “economic transmission projects” (which are investments whose expected economic benefits are associated with reductions in congestion costs) exist (Joskow, 2000). In general, PJM develops an annual regional transmission expansion plan that identifies transmission system enhancement requirements. The transmission companies propose their plans about the construction of new transmission lines or capacity increase to the RTO, FERC and the Department of Energy (DOE). When a transmission expansion plan is approved, FERC can offer incentive-rate treatment to reduce regulatory risk. The costs for investment made in order to reestablish reliability after connecting a new generation unit are generally paid by the generation unit.

According to the US Department of Energy (2006), the congested zones were identified in both Eastern and Western interconnected systems. PJM is one of the regions where one of the two principal critical congestion areas within the Eastern Interconnect Grid has been identified²⁰. The area includes the eastern coast of the PJM region – beginning at metropolitan New York continuing southwards through Washington D.C. to Northern Virginia. Historically, the concern has always been how to move the electric energy from the lower-cost western part of the market to the eastern part of the market where the major load far away from the low cost generation is situated. The congestion in the PJM region is caused mainly because of the growing load together with plant retirements. Limited new generation investment near loads is another cause of congestion there.

¹⁹ Parallel to FTRs, another tool exists on FTR markets – it is called an Auction Revenue Right (ARR). ARRs are allocated annually and provide their holders with revenue based on locational price difference between ARR sources and sink determined in the annual FTR auction (see Frayer, Ibrahim, Bahceci and Pecenkovic, 2007).

²⁰ The critical congestion area is defined as a place where it is critically important to remedy existing or growing congestion problems because the current and/or projected effects of the congestion are severe. In these locations of the network it has frequently been necessary to interrupt electric transactions or redirect electricity flows because the existing transmission capacity was insufficient to deliver the desired energy without compromising grid reliability (US Department of Energy, 2006, p. 21).

Even if there is a low-cost coal and nuclear power generation in Midwest, the east parts of PJM cannot use it because the capacity of the transmission network does not allow it²¹.

The installed capacity of PJM at the end of 2006 was 162,143 MW. Table 1 provides an overview of the generation plants in PJM, installed capacities (in percentage terms), structure of average weighted LMP²² (how the fuel prices influence the final LMP, in percentage terms), and percentage of total real generation. The PJM region could also be a power source for the neighboring regions (especially the New York metropolitan area) as long as transmission cross-border constraints are relieved.²³

Table 1 – Plant characteristics and price structure in PJM

Plant Type	% of Total Installed Capacity in PJM	Part of Total Average Weighted LMP PJM price in the 2006	% of Total Generation
Coal	41%	38.7%	56.8%
Nuclear	18.5%	0%	34.6%
Natural Gas	29%	32.3%	5.5%
Oil	6.6%	5%	0.3%
Hydroelectric	4.4%	0%	2%
Solid Waste	0.4%	NA	0.7%
Wind	0.19%	0%	0.1%

Source: Own calculations with from the PJM Interconnection (2006).

IV. The Model

The model of transmission expansion that we apply to the PJM transmission network integrates the key concepts of incentive mechanisms presented in Section II of this paper, and relies on the modeling logic in Vogelsang (2001), Hogan, Rosellón and Vogelsang (2007), and Rosellón and Weigt (2008). The approach is then a combination of the merchant and regulatory mechanisms with an engineering approach – it merges the tools of the two main models for the adequate transmission expansion problem: a welfare optimization dispatch power-flow problem (lower-level problem) with a two-part tariff cap regulatory model (upper level). The way it is constructed simulates the

²¹ The nodal prices reflect the described congestion problem for the west-east deliveries. For instance, at the western AEP-Dayton hub the nodal price in given moment in 2005 was \$46/MWh while at PJM Eastern Hub it was \$66/MWh at the same time (PJM Interconnection, 2006, and PJM Summer, 2007, Reliability Assessment).

²² The other components of the average weighted nodal price are the price corresponding to generating NOx, SO2, VOM and markup.

²³ Figure 3 in the Section V shows some of the transmission links within the PJM region subject to congestion.

real transmission operation and planning issues faced by an ISO, and a Transco. It has power to model many crucial aspects of practical cases where (1) a central authority applies certain kind of regulation, imposing a regulation constraint, (2) the Transco, subject to the regulation constraint, charges a fee for the transmission service and plans the transmission expansion, and (3) the ISO, operating the wholesale market, manages the electric dispatch, subject to the characteristics and capacity limitations of the transmission network. Its goal is to dispatch electric power in an efficient way.

The combination of the last three concepts is modeled in the following way:

1. The merchant mechanism is introduced via system of nodal pricing and FTRs. Transmission expansion is carried out through the sale of FTRs. FTRs are defined according to node pairs that suffer congestion, and are commercialized via auctions where the participants enter voluntarily.
2. The regulatory part of the mechanism is based on Vogelsang (2001) regulatory mechanism – a cap constraint is intertemporally applied over a two-part tariff.
3. Dispatching is modeled through a welfare optimization program, subject to the engineering restrictions reflecting the transmission network’s technical limitations. It defines the wholesale market prices in each short-run period.

The crucial step which enables the combination of the merchant and the regulatory approach is the definition of the transmission output in terms of FTRs. It is an approach originally introduced by Hogan, Rosellón and Vogelsang (2007), and solves the shortcoming of Vogelsang (2001) with an exact and convenient measure of transmission output as point-to-point transactions or FTR obligations. Hogan, Rosellón and Vogelsang (2007) show that, under certain conditions, convergence to Ramsey prices might be reached. In the case of PJM, the transmission sector bears parts of regulation as well as merchant elements. The structure in PJM region is similar to a theoretic “centralized ISO” structure.²⁴ The features of our model are in general compatible with the institutional setup in the PJM region. In particular, the existence of a competitive wholesale market with FTRs in PJM facilitates the application of our model.

Mathematically, the model is divided into two levels of optimization. The upper level represents a dynamic profit maximization problem solved by a Transco when considering transmission expansion. It reflects the opposite incentives that the Transco faces – to expand the transmission network which releases congestion and produces long term benefits for the society (given the growing demand for electricity and need for higher capacity), or to keep congestion in

²⁴ Wilson (2002) defines two possible structures for an ISO: a centralized structure and a decentralized structure. Generally speaking, in the former structure the ISO coordinates the equilibrium of the various electricity markets as a central planner, while the latter approach would reach such equilibrium in a sequential way through the free participation of economic agents. No electricity market has been proven to work in practice under a decentralized ISO.

the network and get high congestion rents. The lower level problem reflects the optimization problem faced by an ISO operating the wholesale market, and dispatching the generation and transmission optimally. The lower problem, hence, defines the wholesale market outcome. The two-part tariff maximization forms a dynamic optimization problem running thru T periods, subject to complementarity constraints. The two levels of the optimization are solved simultaneously.

A. Upper Level Problem

The Transco maximizes its objective function (the intertemporal flow of profits) subject to a price cap constraint:

$$\max_{k,F} \pi = \sum_t \left[\sum_{ij} \tau_{ij}^t(k^t) q_{ij}^t(k^t) + F^t N^t - \sum_{i,j} c(k_{ij}^t) \right] i \neq j \quad (1)$$

s.t.:

$$\frac{\sum_{ij} \tau_{ij}^t(k^t) q_{ij}^w + F^t N^t}{\sum_{ij} \tau_{ij}^{t-1} q_{ij}^w + F^{t-1} N^t} \leq 1 + RPI + X \quad (2)$$

The profit function allows for two basic sources of revenue – the first term of the profit function represents the congestion rent. In the FTR literature the congestion rent is generally defined as point-to-point FTRs, q_{ij} , between two nodes i and j , multiplied by the FTR price, τ_{ij} , which is set on the FTR auction. The congestion rent is only charged in the lines that generate “space” for new FTRs. If the limit of the overall capacity of a line is not reached during the transmission process in the period t , there are no FTRs generated on the line in t , and no congestion rent charged by the Transco.²⁵ The second term is a fixed fee F charged to each of N users of the transmission grid. It represents a fixed payment for the access to the transmission network. The last

²⁵ The idea that the throughput has to reach the capacity upper limit of the line to be congested is simplified. In reality, an important factor in congestion is also the susceptance of the transmission lines. Certain susceptance of a line can cause the line to be a source of congestion even though the throughput in the line has not reached the upper limit capacity of the line. This is considered in the constraints of the lower level problem.

term in the maximization problem is the cost function, $c(k)$, which represents the costs of transmission-line capacity expansion between the nodes i and j incurred by Transco.

The restriction on revenue is the regulatory constraint set by the regulatory authority. The constraint is built as a two part tariff cap. The opportunity to rebalance the parts of the tariff guarantees that the Transco will not lose income through the diminishing of the congestion rent when the transmission network is expanded. A lower congestion rent will in turn decrease profits. This is offset as the Transco counters the diminishing congestion rent by increasing the fixed fee.

The weights w used in the price tariff are the Laspeyres weights. According to Rosellón (2007), the Laspeyres weights applied to the Vogelsang (2001) two-part tariff mechanism grant a solution that will converge to an optimum under stable cost and demand functions. The price cap also adjusts for an efficiency factor, X , and an inflation factor, RPI . The Transco maximizes its profit subject to the regulatory restriction, through T periods, considering the transmission lines between all the nodes i and j within the grid. Perfect information is assumed and there is no uncertainty about demand and generation capacity²⁶.

In order to find the first-order optimality conditions, ignoring inflation and the efficiency factors, the derivative of the objective function (1) subject to the constraint (2) is:

$$\nabla q_{ij}^t \tau_{ij}^t(k^t) - \nabla c^* = (q_{ij}^w - q_{ij}^t(k^t)) \nabla \tau_{ij}^t \quad (3)$$

In order to simplify the application of this model to actual electricity networks Rosellón and Weigt (2008) avoid the FTR. They redefine the system of equations (1) and (2), so that the profit maximization problem can be rewritten as:

$$\max_{k,F} \pi = \sum_t^T \left[\sum_i (p_i^t d_i^t - p_i^t g_i^t) + F^t N^t - \sum_{i,j} c(k_{ij}^t) \right] \quad i \neq j \quad (4)$$

s.t.

$$\frac{\sum_i (p_i^t d_i^w - p_i^t g_i^w) + F^t N^t}{\sum_i (p_i^{t-1} d_i^w - p_i^{t-1} g_i^w) + F^{t-1} N^t} \leq 1 + RPI + X \quad (5)$$

²⁶ The model relaxes from an auction FTR price setting and the distribution of FTRs to the specific market participants.

The first term of the equation (4) represents an alternative way to define the congestion rent. Instead of a congestion rent expressed in terms of FTRs multiplied by their price corresponding to each part of the grid, this is now defined in terms of the market clearing prices, demand and generation at every node. More exactly, it is defined as the difference between the payments from the loads, $p_i d_i$, and the payments to the generators, $p_i g_i$. When the loads pay the generators precisely the price that energy costs at the place it was generated, no congestion and congestion rent exists. The relationship between the market clearing prices, p_i , and the FTR prices used in the original maximization problem is $\tau_{ij} = p_j - p_i$. The regulation constraint is written in the same manner. It substitutes the FTR revenue with congestion rents arising from the differences in nodal market clearing prices.

B. Lower Level Problem

This is a welfare maximization problem, and determines the wholesale market outcome. The optimization of electric dispatch undertaken by the ISO is subject to the technical restrictions of the network and power flows. There is a perfectly competitive environment assumed where the ISO maximizes social welfare W . Following Rosellón and Weigt (2008), the social welfare is defined as a difference between the gross consumer surplus and the total generation costs²⁷:

$$\max_{d,g} W = \sum_{i,t} \left(\int_0^{d_i^t} p_i(d_i^t) dd_i^t \right) - \sum_{i,t} mc_i g_i^t \quad (6)$$

s.t.:

$$g_i^t \leq g_i^{t,\max} \quad \forall i,t \quad (7)$$

$$|pf_{ij}^t| \leq k_{ij}^t \quad \forall ij \quad (8)$$

$$g_i^t + q_i^t = d_i^t \quad \forall i,t \quad (9)$$

The first restriction to the welfare optimization, equation (7), is a capacity constraint that does not let any generation in any node i exceed its generation capacity. Equation eight reflects the

²⁷ Rosellón and Weigt (2008) use this approach in order to obtain a more straightforward expression of the consumer rent and generators' rent.

restriction that the power flow pf_{ij} between the nodes i and j cannot exceed the transmission capacity k_{ij} of the line. The constraint described by equation (9) imposes that demand at each node is satisfied by local generation or by a net injection k_i .

Then, in the same manner as in Hogan, Rosellón and Vogelsang (2007) and Rosellón and Weigt (2008), a DC-Load-Flow approach is applied in order to get the power flow within the meshed network. Simulation of the optimization of both levels simultaneously leads to iteration of efficient solution values. From the lower level optimization process, the vectors of optimal values of d and g , as well as nodal prices p , are obtained and substituted into the upper level problem. Then the optimal values of capacity k and fixed fee F are in turn obtained.

V. Transmission-Expansion Simulation for the PJM Network

The data used for the simulation are obtained from a “snap shot” of a power flow during a non-peak demand period in the USA in 2006. The database information is organized according to the transmission operators of six main regions within the Eastern Interconnection in the USA, and a part of Canada. A more detailed subdivision of the data is presented according to the historic control areas in each region. In the system modeling for PJM, each of the historic control areas is called a zone. Every zone is characterized by number of generators, total generation potential, transmission lines and instantaneous demand of load centers within the zone. The total area operated by PJM (and included in the database) is divided into 17 zones.²⁸ For the purpose of modeling the PJM network topology, one node is assigned to each zone.²⁹

Since the region that PJM operates has expanded significantly during various years, there are two data sets considered for the simulation. The first data set covers a region operated by PJM until 2006. The topology corresponding to this area is tested for original non-peak demand obtained from the database. The second data set is reduced to a region known as PJM-Classic which is an area operated by PJM until 2001. This data set is tested for peak demand. The basic difference in peak and non-peak demands will be reflected in the level of congestion within the network, and in the level of the nodal prices. When peak demand has to be satisfied, higher levels of energy are being transported among the nodes, and there is a higher load for some lines in the grid. Hence, the lines are more prone to congestion. Moreover, to satisfy higher demand it is more probable that higher cost generators would have to be turned on. Together with higher congestion levels in the

²⁸ The analysis assumes a closed area with a closed system of transmission lines. While in reality PJM trades energy to NYISO to the north, MISO to the west, and also to states in the south, congestion linked to these exchanges is not considered in the topology.

²⁹ The decision to assign one node to each zone comes from the fact that each utility owner within the region of PJM is given monopoly over the zone where it operates.

network, this is a cause for higher peak-demand LMPs in comparison with the LMPs during the non-peak demand periods. Details of the PJM Classic topology --and the corresponding results for peak-demand data simulation-- are included in the first part of the appendix.

V.1 Topology of the Network

The first data set includes the area of PJM until 2006.³⁰ Figure 1 represents the simplified topology of its Transmission Network. There are 17 nodes in total, where thirteen nodes are connected with more than two other nodes and the rest is connected to one or two other nodes. In two cases, where a single historic control area is divided in two parts without a common border, the topology follows this division and two sub-zones per one control zone are considered. Each sub-zone has its own node assigned in the model (nodes N11, N12 and N4, N5).

Figure 1 – Topology of PJM³¹

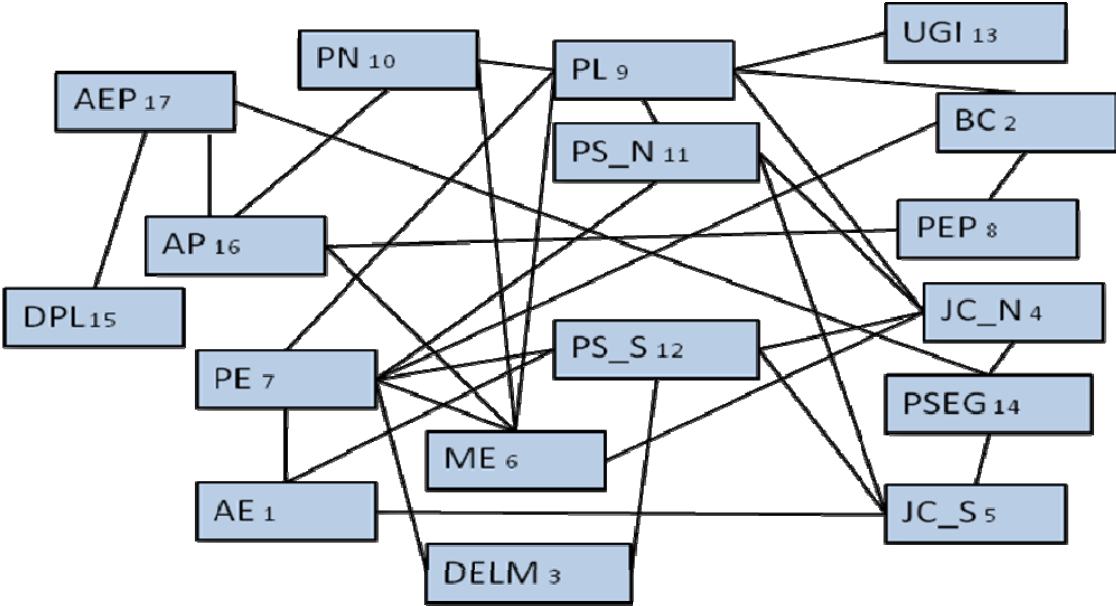

Source: Own elaboration with information from PJM Interconnection

³⁰ The original PJM-West region was modified for the purpose of the simulation. First, it excludes the territory nowadays corresponding to Virginia Electric and Power Company which was added to PJM Interconnection in 2004 under the name of “Dominion Power”. This territory is considered neither in the topology (and consequently nor in the simulation) because the data base does not include it. Second, given that the analysis is for a closed area only (so as to preserve integrity of the topology and avoid bias of results), the zone corresponding to Commonwealth Edison Company --which is a part of PJM-West situated in the state Illinois-- is excluded from the data set. The exclusion was made because the zone has stronger transmission connections and commerce with zones which are parts of different ISOs’ regions, and does not have common frontiers with any part of the remainder area of PJM.

³¹ An explication of the abbreviations and precise location corresponding to the nodes is shown in Figure 7 in the Appendix.

The transmission lines between the connected zones were aggregated in a way to obtain the total maximum capacity that can be transmitted between each two connected zones. These total connected capacities are represented in the model as single lines between the two zones. Because of the scale of aggregation, each aggregated area is considerably large, and consists both of load and generator centers. All nodes but node N14 (which has zero demand in the moment the snapshot was taken) are considered to be load nodes.

A detail of the transmission network topology is shown in Figure 2. It is a scheme of variables, and their concrete values that are needed for the simulation. Each node in the topology has associated its maximum generation capacities, a reference (starting) demand, the cost of generation per MW, and the capacity of the transmission lines that connect it with other nodes.

Figure 2 – Detailed scheme of Transmission Network

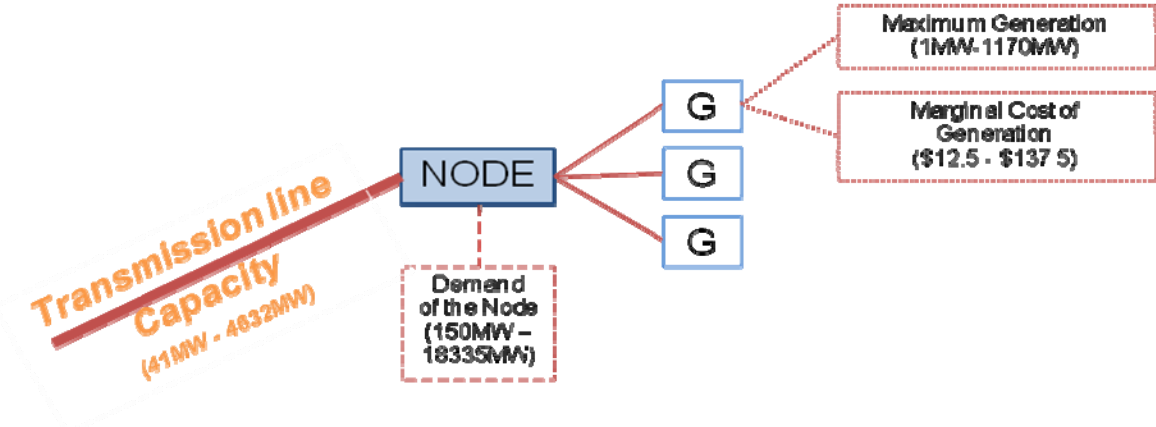

Source: Own elaboration

The distinction and the assignation of the fuel type used by the generation units were made according to the maximum generation limit of the plant. This way the distribution and classification of the generation units in PJM --the types of generating plants and marginal cost of generating MWh corresponding to each kind-- were obtained, and are shown in Table 2. An equal marginal cost level is assumed for each type of generation unit.

Table 2 Generation Plant Characteristics³² (Source: Own elaboration)

Assumed Technology	MW Cap for the Generation Plant	Fuel	Price for MWh
Internal Combustion	1-20 MW	Diesel	\$137.5

³² The fuel prices were obtained as an average cost reported in PJM Interconnection (2007) and Edison Electric Institute data reviews (www.eei.org).

Turbine Simple Cycle	21-199MW	Natural Gas	\$72.5
Turbine Combined Cycle	200-499MW	Natural Gas	\$45
Coal	500-800MW	Coal	\$20
Nuclear	801-9999MW	Uranium	\$12.5

Source: Own elaboration with information from PJM Interconnection

V.2 Initial Conditions

Our simulator works in such a way that, given the technical restrictions of the network, the demand is satisfied employing the low cost generators first. On the other hand, the total demand has to be satisfied completely (see equation (9) in Section IV) even if the last activated generator produces energy for double, triple or even higher costs compared to the first generator employed.³³ The functional forms --and if necessary also starting values of the parameters used in the simulation-- are assumed according to the values in Table 3.

Table 3 Simulation values

Simulation values	
Number of periods	20
Costs	linear
Cost function	$c_{ij}^t = c_0 \cdot (k_{ij}^t - k_{ij}^{t-1})$
c_0 (line expansion cost)	130 \$/MW
Demand	linear
Assumed elasticity	0.25
Reactance in t=0	$x_{ij}^0 = 42.5$

Source: Own elaboration with information from PJM Interconnection

The demand function for each node is derived from the load level for each node, a reference price derived from the weighted average marginal cost³⁴ corresponding to every zone, and an assumed price elasticity of 0.25 at the reference point. The demands are assumed to be linear.

³³ We only consider in this paper the case where new capacity can only be added to already existing transmission lines.

³⁴ Weights for each level of marginal cost are settled according to the proportion of the maximum generating potential of each plant type within the node.

Uniform reactance values $x_{ij}^0 = 42.5$ for all the lines are assumed in $t=0$ and individually change according to the expansion of each line. A depreciation factor of 8% is assumed.³⁵

The tariff cap is formed using a Laspeyres index in the regulatory tariff where the weights are the $(t-1)$ period amounts. In the simulation there are 20 periods of time considered. The derived market results for one time period represent one hour.³⁶ Even if the analysis of the transmission-network power flow is based on various simplifying assumptions, in a simulation with three-node network simplifying assumptions will not influence the general properties of the mechanism outcome. When relaxing simplifying constraints, the robustness of the mechanism is not affected – there is no effect on the desired properties of the mechanism. This result can be extended to a more complicated transmission network topology (see (Rosellón and Weigt, 2008)).

As mentioned in Section III, there is an extended part of PJM that suffers high grade of congestion. 12 “zones” suffering from congestion were identified (US Department of Energy, 2006). These congested paths within the PJM topology are shown in Figure 3 as the thicker lines connecting the nodes. Because of the scale of aggregation, some of the congested parts inside the zones do not appear separately but will be identified during the simulation in aggregation in a particular line.

Figure 3 – Potentially congested lines

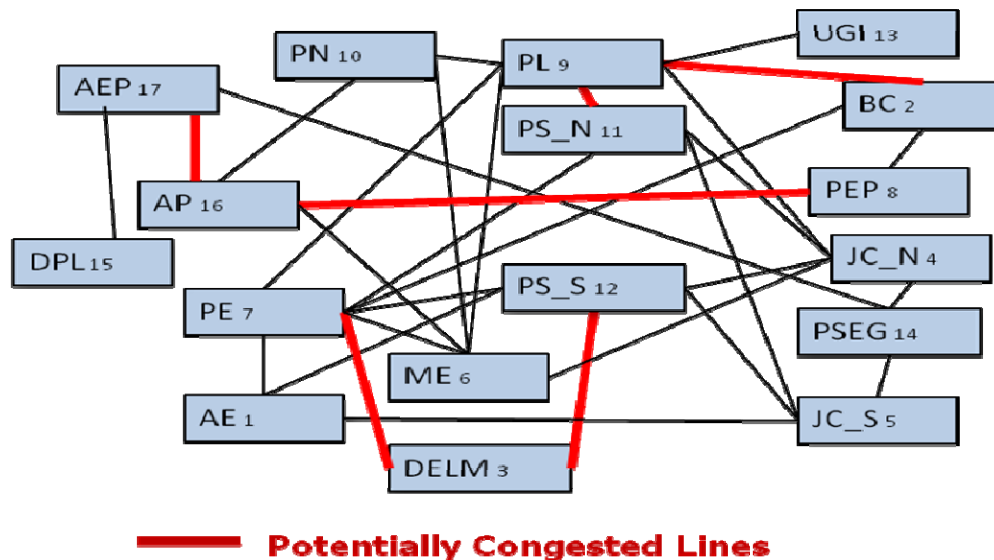

Source: Own elaboration with information from PJM Interconnection

³⁵ The value of the depreciation factor is taken from Rosellón and Weigt (2008). 20 years are supposed to represent the depreciation time of assets in electricity markets and 8% represent an investment with rather low risk. For simplification, we do not account for inflation or efficiency factors within the Transco’s price cap.

³⁶ As the values are obtained in hours, the Transco’s revenue is multiplied by 8760 for each period so as to represent yearly income.

The highest nodal prices correspond to the nodes on the eastern part of the topology. These nodes correspond to an area that historically has high demand given by high population density and -- compared to the generation situated in the west part of the region-- with high cost electricity generation. Due to transmission bottlenecks, it is not possible to transport cheap energy from the west to the eastern part. The simulation will show if an application of the incentive mechanism would lead to price arbitrage, and decrease of nodal prices.

V.3 Results – Price Development and Welfare Properties

The mechanism seeks to promote for capacity increase of the transmission lines, which should then permit transmission of lower cost energy from the western part of the region to the eastern-coast area. To test scope of the mechanism, the development of nodal prices and welfare properties are considered as well.

Figure 4 shows price development in the PJM nodes over 20 periods. In the first period the nodal prices differ substantially as they are subject to a high level of congestion. Eastern node N2 has the highest nodal price (\$100). The average price of the nodal prices in the first period is \$53.64. However, convergence towards a common price level occurs fast within the first nine periods. The average price after the first nine periods is 17 % lower compared to the average nodal price at the beginning of the simulation. If the average level of the five highest nodal prices at the beginning of the simulation is compared to the average price of the same nodes after the first six periods of simulation, a decrease of 32% can be observed. During the rest of the periods, most of the nodal nodal prices change only marginally.

The extension of the grid follows similar dynamics – the grid is expanded extensively during the first nine periods, and after the ninth period the grid expansion is relatively small. The striking fall of the prices is visible mainly for the nodes N2, N4, and N8. All of them are situated in the eastern area of PJM. This reflects the current problem mentioned in the Section III. Transmission congestion separates the eastern part of the market from the remainder of the grid, and electricity prices on the east coast are higher compared to the rest of the region. Transmission congestion does not allow bringing cheaper energy produced in the western part of the region to the east.

Figure 4 – Price development for the PJM region (Source: Own elaboration)

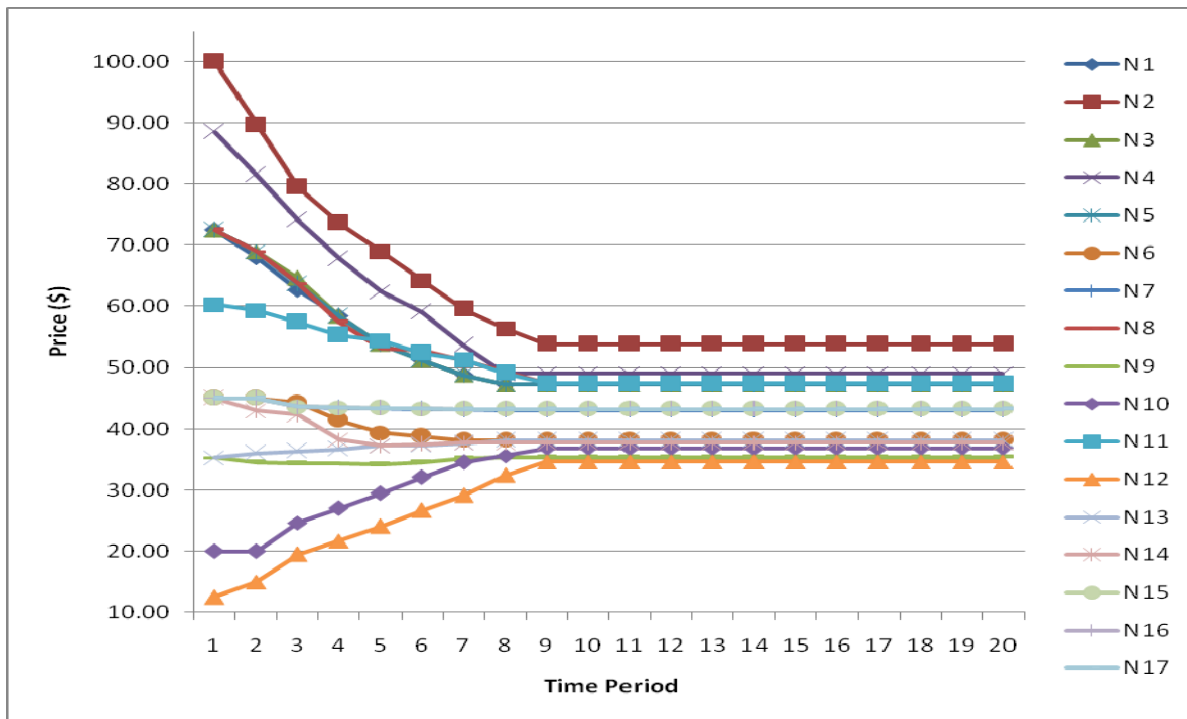

If the grid is expanded, cheap nuclear and carbon energy that can be produced and transported mainly from nodes N10 and N12 is utilized to satisfy demand at other nodes, and nodal prices in nodes N10 and N12 increase. The average nodal price at the end of the simulation decreases to \$43.11, which is 20% lower than at the beginning of the simulation. An arbitrage of nodal prices occurs and the former difference of \$87.5 between the highest and the lowest price at the beginning of the simulation is reduced to \$19.22 after the 20 periods.

V. 4 Welfare Properties

The nodal price development brings about welfare changes. The purpose of the mechanism is to permit arbitrage of prices, and an increase in social welfare, through transmission expansion. When comparing social welfare, only changes that are caused by nodal prices changes are considered. As argued in Vogelsang (2001), the fixed fee acts as a lump-sum tax. The major concern is centered on the development of the nodal prices which converge to marginal costs. Figure 8 in the appendix shows the general development of the fixed fee when nodal prices increase.

In order to assess the performance of the mechanism (“Regulatory Approach”), the results from the simulation are compared to the benchmark case without network extension, and to a benevolent ISO case³⁷ (“Welfare Maximization”). Table 4 shows the welfare characteristics of the

³⁷ The benevolent ISO case is obtained from the maximization problem:

mechanism. The basis for the estimation of the corresponding rents are the demand function of each node, the congestion rent (first part in equation (4)), and consumer and producer surpluses (equation (6)).

Table 4 – Comparison of the Regulatory and Benevolent ISO approach for PJM region

	No grid extension	Regulatory Approach	Welfare Maximization
Consumer Rent (MioUSD/h)	6.53	6.63	6.67
Producer Rent (MioUSD/h)	0.36	0.59	0.64
Congestion Rent (MioUSD/h)	0.067	0.01	0.006
Total Welfare (MioUSD/h)	6.95	7.23	7.32
Total Grid Capacity (GW)	35.8	50.83	52.83
Average Price (USD/MWh)	53.64	43.11	42.97

Source: Own elaboration.

An increase in consumer rent is observed after the mechanism is applied. Consumers pay lower congestion costs. Even if the nodal prices increase in two cases, the consumer surplus reduction is offset by a price decrease in the other 15 nodes. Note that the sum of the demands in the two nodes that experienced price increase is not higher than the sum of the demands in the remainder part of the system. Since, after the adjustment, prices lie above its marginal cost the producer surplus increases as well as a significant part of total generation that corresponds to nuclear and carbon generation.

The new installed capacity is 42% higher than the capacity at the beginning of the simulation. As expected, the congestion rent is not equal to zero but its level decreases substantially. The original level of the congestion rent is reduced to 15% within the 20 periods. The regulatory approach then produces results that are relatively close to a pure welfare-maximizing outcome, and suggest convergence to the welfare optimum levels. Comparing the results for the European model tested by Rosellón and Weigt (2008), the results for PJM show a similar tendency.

As mentioned at the beginning of this section, even more pronounced fall of the nodal prices and bigger increase of the rents could be experienced if the demand tested in the simulation were a peak one. In Table 5, results from the non-peak demand and peak demand testing are compared. Details of peak-demand testing within the smaller region of PJM called PJM-Classic are

$$\max_{d,g} W = \sum_{i,t} \left(\int_0^{d_i^*} p_i(d_i^t) dd_i^t \right) - \sum_{i,t} mc_i g_i^t - \sum_{i,j} c(k_{ij}^t), \text{ subject to the restrictions in the lower}$$

level problem.

presented in the appendix. The first period nodal prices for the peak demand testing are in several nodes higher than in the case of non-peak demand. In general, this is given so as to satisfy the peak demand. Apart from the cheapest generators that provide energy when satisfying non-peak demand, more expensive generators have to be turned on. Another factor that increases the total cost of providing energy for peak demand is higher congestion. For the majority of the nodes, the final level of the nodal prices is higher when peak demand is satisfied. For example, in the case of nodes N13 and N14, even if the first period nodal prices were higher for the non-peak demand, at the end of the simulation their nodal prices are higher when the peak demand is satisfied. However, when comparing the nodal price levels for the peak and non-peak demand situations, it has to be taken into account that differences in topologies influence the differences in the nodal prices as well.

Table 5 – Comparison of the non-peak and peak demand nodal prices for the 17-and 14-node topology

Number of the node	Non-peak demand (17 node topology)		Peak demand (14 node topology)	
	1. period nodal price	Final nodal price	1. period nodal price	Final nodal price
1	\$ 72.5	\$ 47.23	\$ 137	\$ 49.70
2	\$ 100	\$ 53.84	\$ 137	\$ 59.30
3	\$ 72.5	\$ 47.23	\$ 72.50	\$ 46.20
4	\$ 88.53	\$ 49.01	\$ 137	\$ 51.97
5	\$ 72.50	\$ 47.23	\$ 72.50	\$ 46.76
6	\$ 45.00	\$ 38.16	\$ 45.00	\$ 46.70
7	\$ 45.00	\$ 43.04	\$ 72.50	\$ 46.15
8	\$ 72.50	\$ 47.43	\$ 137	\$ 59.30
9	\$ 35.27	\$ 35.33	\$ 20.00	\$ 39.60
10	\$ 20.00	\$ 36.86	\$ 20.00	\$ 39.30
11	\$ 60.33	\$ 47.36	\$ 72.50	\$ 46.80
12	\$ 12.50	\$ 34.62	\$ 45.00	\$ 42.70
13	\$ 35.27	\$ 38.12	\$ 20.00	\$ 39.40
14	\$ 45.00	\$ 37.72	\$ 20.00	\$ 39.70
15	\$ 45.00	\$ 43.21	-	-
16	\$ 45.00	\$ 43.21	-	-
17	\$ 45.00	\$ 43.21	-	-

Source: Own elaboration

VI. Conclusions

This paper presents an application of a merchant-regulatory mechanism for transmission grid expansion to the transmission network in the PJM region. The theoretical model is based on a structure with regulated profit-maximizing Transco, and a competitive wholesale market with nodal price setting and FTRs. Regulation is applied through a price cap imposed on a two-part price tariff that the Transco can charge to users of the transmission network. The regulatory constraint allows for the rebalancing of the variable and fixed parts of the fee in order to let the Transco preserve its benefits when congestion rents decrease due to the increased transmission-grid capacity. The Laspeyres weights are used in the two-part tariff mechanism. The wholesale market is operated by an ISO that coordinates generation and transmission, maximizing the social welfare. FTRs signal the need for new transmission capacity.

The purpose of the mechanism used for the simulation is to arbitrage nodal prices and to foster their convergence to an steady-state equilibrium state with lower congestion rents and higher total welfare. The capacity increases of the transmission lines permit transmission of lower-cost energy to the zones with higher demand and more expensive energy generation. The mechanism is applied to the region that suffers critical levels of congestion combined with growing demand. To date, no coherent mechanism that promotes adequate expansion of the PJM transmission network exists. Moreover, the PJM network is a complicated system of loads and generators covering a considerably large part of the US area. Transmission services are getting unreliable in PJM, and the congestion costs are a significant part of the energy price charged in the region.

A 17-node and 14-node network topology was designed for PJM, and the mechanism is tested for both non-peak and peak demands. Starting with a grid that suffers critical levels of congestion in various zones, the simulation of the mechanism proves that after first nine periods the congestion is relieved, nodal prices converge to a common lower average level resembling the marginal cost of energy generation, the consumers pay lower congestion costs and both consumer and producers surplus increase. In general, the nodal prices for peak-demand periods are higher than for the non-peak period, given that more of the high-cost generators are turned on and also because the higher demand could cause higher congestion in the transmission lines. The simulation proves that the mechanism works for a quite complicated meshed topology such as the PJM one. The installed capacity of the 17-node transmission network after the simulation is 42% higher than the capacity of the original grid, and the congestion rent decreases to 15% of its original level. Total welfare increases. Given that the various composing elements of our mechanism and its features are compatible with the FTR-based competitive wholesale market in PJM region, we believe that our mechanism holds promise for being applied in practice.

Next steps in modeling the PJM electric transmission system would implement some new elements to the model. The purpose of future research would improve on the engineering – lower level problem – part of the optimization, and focus in a more detailed geographical division of the PJM region. The intention would be to create different zonal divisions which could reflect the set of zonal areas that is actually used in the internal PJM modeling. Additionally, we would also like to improve on the data set on marginal costs. In the actual operation of markets, marginal costs can be much higher due to imperfect competition.

VII. Bibliography

Armstrong, M., Cowan, S., and J. Vickers (1994) “Regulatory Reform: Economic Analysis and British Experience”, *The MIT Press*, Cambridge.

Carreón, V., and J. Rosellón (2005) “Incentives for Supply Adequacy in Electricity Markets: An Application to the Mexican Power Sector”, *Documento de trabajo CIDE 332*. Mexico.

Carreón, V., and J. Rosellón (2001) “Incentives for Expansion of Electricity Supply and Capacity Reserves in the Mexican Electricity Sector”, *Documento de trabajo CIDE 219*. Mexico.

Crew, M. A., C.S. Fernando, and P. R. Kleindorfer (1995) “The Theory of Peak-Load Pricing: A Survey,” *Journal of Regulatory Economics*, 8: 215-248.

Department of Energy, Energy Information Administration 1 (<http://www.eia.doe.gov>) , consulted in January 2009.

Department of Energy, Energy Information Administration 2, Chapter 1 – Chapter 7 (http://www.eia.doe.gov/cneaf/electricity/chg_stru_update/chapter-.html), consulted in January 2009.

Edison Electric Institute (<http://www.eei.org>), consulted in January 2009.

Frayer, J.; Ibrahim A., Bahceci S., and S. Pecenkovic, S. “A Comparative Analysis of Actual Locational Marginal Prices in the PJM Market and Estimated Short-Run Marginal Costs: 2003-2006”. *London Economics International LLC*, Boston, 2007.

Hogan, W. (1992) “Contract Networks for Electric Power Transmission”, *Journal of Regulatory Economics* 4: 211-242.

Hogan, W. (2002) “Financial Transmission Right Formulations”. *Mimeo*, JFK School of Government: Harvard Electricity Policy Group Harvard University, USA.

Hogan, W., Rosellón J., and I. Vogelsang (2007) “Toward a Combined Merchant-Regulatory Mechanism for Electricity Transmission Expansion”, *Documento de trabajo CIDE 389*. Mexico.

Joskow, P. (2005a) “The difficult Transition to Competitive Electricity Markets in the U.S.” in *Electricity Regulation: Choices and Challenges*, J. Griffin and S. Puller, University of Chicago Press, Chicago.

Joskow, P.L. (2005b) “Transmission policy in the United States”. *Utilities Policy*, 13, 95-115.

Joskow, P. and J. Tirole (2002) “Transmission Investment: Alternative Institutional Frameworks”. *Journal of Industrial Economics* 53: 233-264.

Kristiansen, T. and J. Rosellón (2006) “A Merchant Mechanism for electricity transmission expansion”. *Journal of Regulatory Economics* 29 : 167-193.

Léautier, T. (2000) “Regulation of an Electric Power Transmission Company”. *The Energy Journal* 21 : 61-92.

- Mas-Colell, A. and M. Whinston, & J. Green (1995) "Microeconomic Theory". New York: Oxford University.
- OECD Competition Issues in the Electricity Sector, OECD 2003.
- OECD Background Report on Regulatory Reform in the Electricity Industry, OECD 1998.
- PJM Interconnection, *2006 State of the Market Report*, Market Monitoring Unit; March 2007.
- PJM Interconnection (<http://www.pjm.com>), consulted in January 2009.
- PJM Member Training Department (2007), *Locational Marginal Pricing 101, LMP-101 Training*.
- PJM Summer 2007 Reliability Assessment, *Indiana Utility Regulatory Commission*, May 30, 2007.
- Prieto, A. (2001) "La industria eléctrica del futuro en México, soluciones a un problema no planteado". Porrúa. México.
- Rosellón, J. (2007) "An Incentive Mechanism for Electricity Transmission Expansion in Mexico". *Energy Policy* 35: 3003-3014.
- Rosellón, J. (2003) "Different Approaches Towards Electricity Transmission Expansion". *The Review of Network Economics* 2: 238-269.
- Rosellón, J. and H. Weigt. (2008) "A Dynamic incentive mechanism for transmission expansion in electricity networks – Theory, Modeling and Application". *Documento de trabajo CIDE 424*. Mexico.
- Rosellón, J. (2000) "Alternativas de la regulación de precios" in *Reforma estructural del sector eléctrico*. México, ITAM Asociación Mexicana de Cultura. Mexico.
- Schweppe, F., Caramanis, M., Tabors, R., and R. Bohn. (1988) "Spot Pricing of Electricity", Kluwer. Boston.
- Tovar, R. (2000) "Lecturas en regulación económica y política de competencia". ITAM Asociación Mexicana de Cultura. Mexico.
- U.S. Department of Energy, *National Electric Transmission Congestion Study*, August 2006.
- U.S. Department of Energy, *National Transmission Grid Study*, May 2002.
- Vogelsang, I. (2001) "Price Regulation for Independent Transmission Companies". *Journal of Regulatory Economics* 20: 141-165.
- Vogelsang, I. (2003) "Electricity Transmission Pricing and Performance-based Regulation". *Energy Journal* 27.
- Vogelsang, I. (2006) "Electricity Transmission Pricing and Performance-Based Regulation," *The Energy Journal*, Vol. 27, No. 4.
- Wilson, R. (2002), "Architecture of Power Markets," *Econometrica*, Vol. 70, No. 4, pp. 1299-1340.

Appendix

(1) PJM Classic: Peak Demand Testing

The second data set includes the zones which comprised PJM prior to 2006, referred to by the term “PJM Classic”. It takes account of the PJM region after the establishment of a competitive wholesale power market and before it expanded, when its operating territory consisted of eastern Pennsylvania, New Jersey, and part of Maryland, Delaware and District of Columbia. Figure 5 represents the simplified topology of the transmission network of PJM-Classic which has 14 nodes, and 26 transmission lines connecting the nodes.

Figure 5 – Topology of PJM Classic region

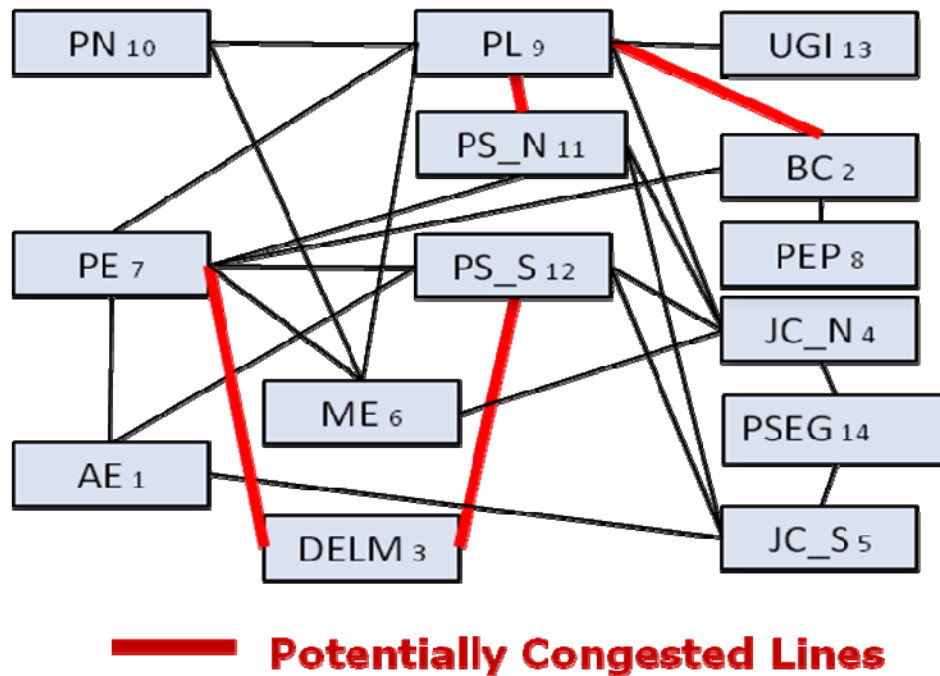

Source: Own elaboration with information from PJM Interconnection

Compared to the 17-node PJM region, this data sample excludes the zones corresponding to nodes 15, 16 and 17. The PJM Classic topology is used in order to test the mechanism facing a peak demand conditions³⁸. If not specified differently, the starting conditions and all the details of the simulation are the same as in the case of simulation of the mechanism for 17-node PJM topology.

The results of nodal price development are shown in Figure 6. In Table 6, the welfare properties results are specified.

³⁸ The peak demand values were obtained adjusting the original demand data according to the February 2006 peak values reported in „PJM Summer 2007 Reliability Assessment (2007)“ for the zones at PJM Classic.

Figure 6 – Price development for PJM Classic region

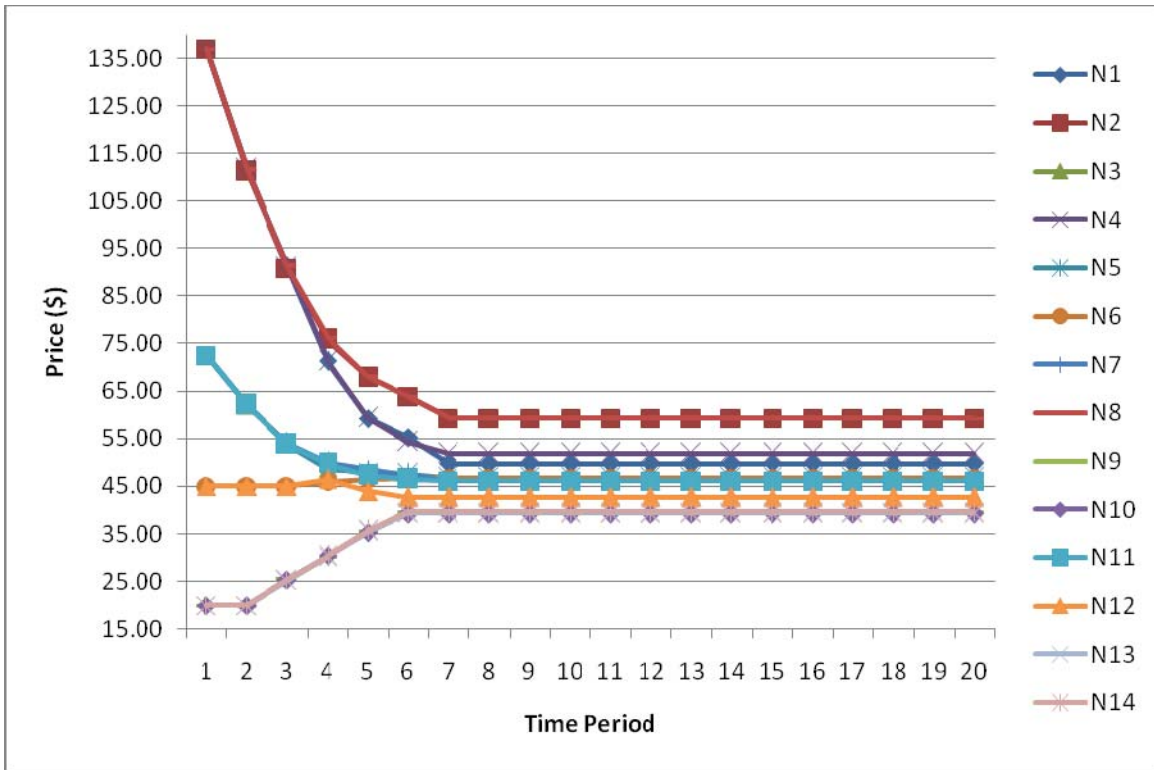

Source: Own elaboration

The general results are the same for both topologies – the nodal prices converge to an equilibrium level after the first six periods of the transmission network expansion. However, when comparing the welfare properties of the mechanism for the simulation of the peak demand, the results are more pronounced, highlighting the power of the mechanism. The average nodal price is almost 36% lower after the mechanism is applied, the transmission network capacity is doubled compared to the first period, and both consumer and producer surplus increase. The price fall is steeper and, given that the demand is higher, the consumers’ surplus increase is higher than in the case of 17-node PJM case³⁹. The congestion rent after the twenty periods of simulation decreases to 16% percent of its original level.

³⁹ However, a comparison with the results for 17-node PJM topology should be made with precaution as there are some significant differences between the cases. The PJM Classic topology does not include three nodes with quite high demands and generation potential. Another important detail is that it is tested for demand in different periods of the year and day.

Table 6 – Comparison of the Regulatory and Benevolent ISO approach for PJM Classic region

	No grid extension	Regulatory Approach	Welfare Maximization
Consumer Rent (MioUSD/h)	8.01	8.13	8.17
Producer Rent (MioUSD/h)	0.44	0.68	0.73
Congestion Rent (MioUSD/h)	0.076	0.012	0.0076
Total Welfare (MioUSD/h)	8.53	8.82	8.91
Total Grid Capacity (GW)	26.91	49.88	52.63
Average Price (USD/MWh)	72.0	46.63	46.21

Source: Own elaboration.

In general, the welfare properties in case of higher demand are expected to be more pronounced as the need for transmission network expansion in the network that suffers high levels of congestion could be higher.

(2) PJM Zones

Figure 7 – Map of PJM region and the utilities operating in each zone in the year 2008⁴⁰

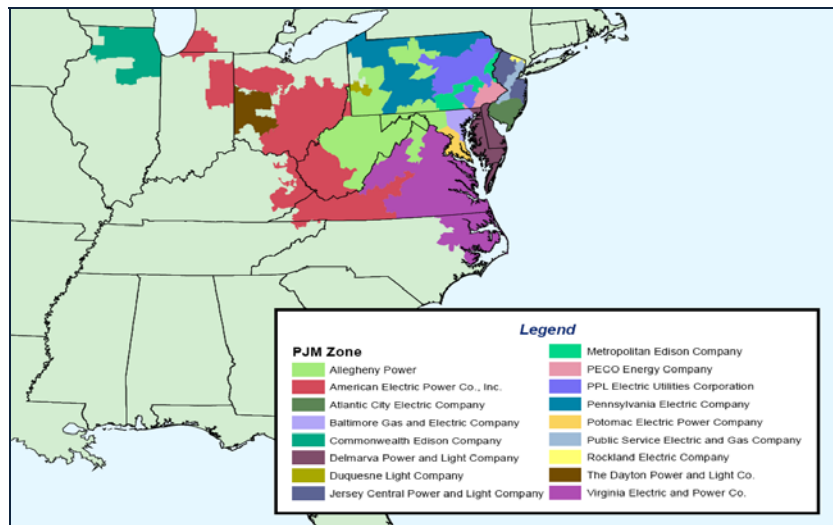

Source: PJM Interconnection

⁴⁰ The map was obtained from PJM Interconnection (<http://www.pjm.com>). The correspondence with the abbreviations used in the topology are the following: AE Atlantic City Electric, BC Baltimore Gas and Electric Company, DELM Delmarva Light and Power Company, JC_N Jersey Central Power and Light Company (North), JC_S Jersey Central Power and Light Company (South), ME Metropolitan Edison Company, PE PECO Energy Company, PEP Potomac Electric Power Company, PL and PN Pennsylvania Electric Company, PS_N Pennsylvania Electric Company (North), PS_S Pennsylvania Electric Company (South), UGI Public Service Electric and Gas Company.