

Abele, Steffen (Ed.); Froberg, Klaus (Ed.)

Research Report

Subsistence agriculture in Central and Eastern Europe: how to break the vicious circle?

Studies on the Agricultural and Food Sector in Central and Eastern Europe, No. 22

Provided in Cooperation with:

Leibniz Institute of Agricultural Development in Transition Economies (IAMO), Halle (Saale)

Suggested Citation: Abele, Steffen (Ed.); Froberg, Klaus (Ed.) (2003) : Subsistence agriculture in Central and Eastern Europe: how to break the vicious circle?, Studies on the Agricultural and Food Sector in Central and Eastern Europe, No. 22, ISBN 3-9809270-2-4, Institute of Agricultural Development in Central and Eastern Europe (IAMO), Halle (Saale), <https://nbn-resolving.de/urn:nbn:de:gbv:3:2-3386>

This Version is available at:

<https://hdl.handle.net/10419/45940>

Standard-Nutzungsbedingungen:

Die Dokumente auf EconStor dürfen zu eigenen wissenschaftlichen Zwecken und zum Privatgebrauch gespeichert und kopiert werden.

Sie dürfen die Dokumente nicht für öffentliche oder kommerzielle Zwecke vervielfältigen, öffentlich ausstellen, öffentlich zugänglich machen, vertreiben oder anderweitig nutzen.

Sofern die Verfasser die Dokumente unter Open-Content-Lizenzen (insbesondere CC-Lizenzen) zur Verfügung gestellt haben sollten, gelten abweichend von diesen Nutzungsbedingungen die in der dort genannten Lizenz gewährten Nutzungsrechte.

Terms of use:

Documents in EconStor may be saved and copied for your personal and scholarly purposes.

You are not to copy documents for public or commercial purposes, to exhibit the documents publicly, to make them publicly available on the internet, or to distribute or otherwise use the documents in public.

If the documents have been made available under an Open Content Licence (especially Creative Commons Licences), you may exercise further usage rights as specified in the indicated licence.

Studies on the Agricultural and Food Sector in Central and Eastern Europe

Subsistence Agriculture in Central and Eastern Europe: How to Break the Vicious Circle?

edited by
Steffen Abele and Klaus Froberg



Subsistence Agriculture in Central and Eastern Europe:
How to Break the Vicious Circle?

Studies on the Agricultural and Food Sector
in Central and Eastern Europe

Edited by
Institute of Agricultural Development in Central and Eastern Europe
IAMO

Volume 22

Subsistence Agriculture in Central and Eastern Europe: How to Break the Vicious Circle?

**Edited by
Steffen Abele and Klaus Frohberg**

IAMO

2003

Bibliografische Information Der Deutschen Bibliothek

Die Deutsche Bibliothek verzeichnet diese Publikation in der Deutschen Nationalbibliografie; detaillierte bibliografische Daten sind im Internet über <http://dnb.ddb.de> abrufbar.

Bibliographic information published by Die Deutsche Bibliothek

Die Deutsche Bibliothek lists the publication in the Deutsche Nationalbibliografie; detailed bibliographic data are available in the internet at: <http://dnb.ddb.de>.

© 2003

Institut für Agrarentwicklung in Mittel- und Osteuropa (IAMO)

Theodor-Lieser-Straße 2

062120 Halle (Saale)

Tel. 49 (345) 2928-0

Fax 49 (345) 2928-199

e-mail: iamo@iamo.de

<http://www.iamo.de>

ISSN 1436-221X

ISBN 3-9809270-2-4

INTRODUCTION

STEFFEN ABELE, KLAUS FROHBERG

Subsistence agriculture is probably the least understood and the most neglected type of agriculture. In a globalised, market-driven world, it remains at the same time a myth and a marginal phenomenon.

Empirically, subsistence agriculture for a long time seemed to be restricted to developing countries, with only a few cases reported in Western Europe (CAILLAVET and NICHELE 1999; THIEDE 1994). Governmental support offered to subsistence agriculture was mainly done through agricultural development policies, the main objective being to have subsistence farmers participate in markets. The strategy was to make farmers produce more by introducing new technologies and consequently bring their output to the market. Failures of such attempts were numerous, yet attempts to understand the failures were few. This lack of understanding led to the change of politics towards already developed and market-oriented systems, hence to the neglect and marginalisation of subsistence-oriented systems.

This picture changed when subsistence agriculture started to appear right at the door of the European Union: With the fall of the Iron Curtain, subsistence agriculture in Eastern Europe turned out to be an urgent case. Suddenly, there were and still are a large number of vulnerable small scale farmers, many of which will, at least by the date of EU enlargement, be entitled to receive funds from the CAP and thus compete with western farmers. Moreover, these poor rural people were subject to social discrimination, as no one likes to have a poor house right next to him in his neighbourhood.

One of the now quite numerous attempts to address the problem of subsistence agriculture in Eastern Europe was a workshop held at the Institute of Agricultural Development in Central and Eastern Europe (IAMO) in May 2001. It gathered scientists from Western and Eastern Europe to discuss problems of subsistence agriculture, ways of analysing such systems and approaches to overcome subsistence agriculture.

The workshop's overall objective was to contribute some answers to the main questions regarding subsistence agriculture in Central and Eastern Europe, but also everywhere else on the globe. These questions are: What is the definition of subsistence agriculture, and what are its characteristics? Is there a conclusive theoretical approach research can rely on? Is subsistence agriculture really a problem or is it, as so many other economic phenomena, just another efficient equilibrium? And if it is agreed upon among scientists to be a problem, what are possible solutions?

We shall provide a brief overview of these issues and how they are addressed in the following contributions. Let us therefore start with the definition of subsistence agriculture.

One of the major problems in dealing with subsistence agriculture is defining the term as such. Many of the authors in this book offer a definition, amongst them *HEIDHUES and BRÜNTRUP*, *VON BRAUN and LOHLEIN*, as well as *LERMAN*. It seems that the preferred definition of subsistence agriculture relates it to the share of marketed produce. The lower this share, the higher is the degree of subsistence orientation. Still, this definition is a relative one, as it can be assumed that there is no longer "one hundred percent" subsistence agriculture, either in Eastern Europe or elsewhere in the world. This assumption should be kept in mind, as it is important for the following theoretical discussion.

The assessment of the characteristics of subsistence agriculture based on the above definition provides a link to theoretical aspects and political options to develop this form of agriculture. The first and most prominent characteristic is the high degree of own consumption of produce, mostly more than 50 percent. Subsistence farms are small (although smallness does not necessarily imply subsistence farming, as, for example, suburban horticulture farms may be small but quite market-oriented and efficient), and they have low capital endowment, which often contributes to low competitiveness. They also suffer from remoteness to urban centres and have poor access to markets, be it in physical terms (roads as well as other transportation routes and telecommunication infrastructure), or in terms of accessing factor markets, especially capital markets (which is a prerequisite for starting market-oriented production), and low on- and off-farm income. The latter especially shows an important aspect: Off-farm income opportunities are scarce and of low revenue for subsistence farmers (see especially the macro-economic assessment by *VON BRAUN and LOHLEIN*). This hints that macro-economic conditions are also important factors driving subsistence agriculture (which will be important for both the theoretical and the political discussion). We will find these characteristics throughout the contributions. *KEGEL* provides a case study on the problems of defining subsistence agriculture in Georgia. *KOVÁCS* gives a geographically based index system to categorize farming systems in Romania. Another question is the one whether farming systems in transition countries are really subsistence-oriented,

and if yes, to what degree. The latter question is especially closely related to the definition of subsistence agriculture, as *LERMAN* points out. In *YEFIMOV's* argumentation, we will find that the lack of market attendance found, especially in the former Soviet Union countries, is due to the institutional set-up of former Soviet agriculture, which, in terms of institutional economics, used hierarchies instead of markets to organise production and commodity exchanges. But that means that they do exchange products and factors, so are they really subsistence-oriented in the narrow sense of above, or do they just use other institutions to interact with the outside world? *NEDOBOROVSKYY* gives an appealing quantitative description of such hierarchy-integrated systems.

The next problem is to provide a theoretical framework for subsistence agriculture. In theory, subsistence is seen as just an early stage of development that will perish once *Ricardos'* comparative advantages are perceived and result in wealth-generating trade (*ROSE and SAUERNHEIMER 1995*). Newer approaches provide different theoretical models to subsistence agriculture which are somewhat contradictory to each other; a broad scope of them is given by *HEIDHUES and BRÜNTRUP*. One of the theories described is based on the assumption of inverse supply reaction due to satisfactory behaviour in production which does not go beyond consumption needs, or (assuming that some share of the produce is marketed) liquidity requirements. This behaviour is seen as caused by strong preferences for leisure and has been brought up by authors like *Chayanov*, cited by *HEIDHUES and BRÜNTRUP*. Yet, this should be discussed critically, as incorporating leisure implies that people would reject higher incomes for the same labour input for the sake of more leisure and thus act irrationally in the strict sense of the *homo oeconomicus* model. Nonetheless, backward sloping supply functions have been explained by authors who point out that short-term post-harvest sales may increase with decreasing prices due to liquidity constraints, but that in the longer run, even subsistence farmers will react positively to increasing prices (*HENZE 1994; ABELE 2001*).

Another, argument strengthened by *HEIDHUES and BRÜNTRUP* is the transaction cost approach, which says that high transaction costs in marketing make selling unattractive, and keep people from buying expensive products, which adds up to self-produced consumption. This may be so, and one could even add mere transportation costs to the list of trade impediments. But, at least as far as transaction costs and the resulting margins are concerned, one could as well assume that, when supply decreases, and farmers turn to their own subsistence production, traders would offer higher prices to producers and lower prices to consumers. This would then cover the transaction costs or reduce the margins, respectively, for consumers. Consequently, transaction costs can only be seen as a temporal explanation for subsistence agriculture.

The next issue raised by *HEIDHUES and BRÜNTRUP* is that risk keeps subsistence farmers from developing their business, be it production risk based on climatic

factors or market risks based on price volatility. But it seems that risk has to be considered as a two-way process, affecting and being caused by subsistence agriculture: autarchy is prone to production risks that cannot be buffered by functioning markets. In fact, this argument may rather hold for developing countries in the tropics than for of mid-European climate. However, *PETRICK and TYRAN* show, in their contribution about Polish subsistence farmers, that market-oriented farmers are less risk averse than subsistence-oriented farmers. This is most probably because market-oriented farmers can afford to take risks – they are covered by markets, cash reserves earned from markets or based on credit lines from banks. Both *MISHEV and KOSTOV* and *KOPEVA and NOEV* emphasize the function of subsistence agriculture to buffer hardships arising from the economic transition process. This means that subsistence agriculture can also be seen as insurance against economic risks – albeit a fragile one. The latter argument brings us back to the macro-economic environment of subsistence farmers that has already been addressed above: subsistence agriculture is applied because there are no alternatives. To conclude this section, we may come back once again to *HEIDHUES and BRÜNTRUP* who discuss this "fuzziness" of theoretical approaches to subsistence agriculture and the research gaps that still exist. The decisive point in their discussion is the statement about the presumed non-economic behaviour of subsistence farmers, which they prove to be wrong. In the words of Ruttan, "They claim that one has to understand economic systems before judging them."

One of the first steps of organising this workshop was to justify why subsistence agriculture is a problem at all. Some authors see subsistence agriculture as a sustainable economic system because of its autarchy (DOPPLER 1991). Others would argue that it cannot be a problem because if it were inefficient, it would not exist. Finally, a third group would argue that subsistence agriculture is no problem at all but rather a solution, as it provides relief from the curses of globalisation and modernisation. In fact, the subsequent contributions to the seminar will prove that all of them are wrong. In the first place, the organisers of the seminar argued that subsistence agriculture is critical for two reasons:

First, autarchy is prone to production risks that cannot be buffered by functioning markets. This has already been discussed in the theory section. The second argument raised by the organisers was that subsistence agriculture yields lower incomes than market-oriented agriculture. It is again *PETRICK and TYRAN* who point out the relationship between income on- and off-farm and subsistence orientation: Subsistence farms seem to have a lower agricultural income than market-oriented farms, but they also seem to have lower income from off-farm employment. *LERMAN* comes to the same conclusions. The same phenomenon is picked up on the macro-economic level by *VON BRAUN and LOHLEIN*, who prove that the lower the national income is, the higher is the number of subsistence

plots. It is thus easy to conclude that subsistence farmers are overall disadvantaged, and that subsistence agriculture really *is* a problem.

The next point to discuss is the future of subsistence agriculture: in the contributions from Central Europe by *PETRICK and TYRAN*, as well as *NOEV*, ways of getting out of this stage of farming are discussed: investment in agriculture and subsequent farm growth will help subsistence farmers to become market-oriented. The same findings are highlighted for both Central European and Central Asian countries assessed by *LERMAN*. He also describes ways and solutions for the development of subsistence farmers, namely, improved access to input and output markets, but also to credits as well as services (especially extension) to ensure the potential for farm size growth. This also requires the proper functioning of factor markets, both land and labour, as both factors have to be re-allocated during the commercialisation process. Organisations are seen as a crucial factor of farmers' empowerment, as they may strengthen farmers' positions on markets, and they may also provide the utilization of economies of scale without the need to re-allocate factors. A last point to improve agriculture and make it more market-oriented is given by *WEHRHEIM and WOBST*: They claim an improvement of institutions, namely markets and trade policies, would foster trade and reduce transaction costs, so that incentives for farmers would be given to producing and marketing more of their product.

Making farms more efficient is a necessary but not a sufficient solution to the problem of subsistence agriculture. As many of the authors will show, subsistence agriculture is also driven by a lack of alternative income sources, mainly in rural areas but also in urban sites. *YEFIMOV* points out that Russian subsistence farmers might as well resist a restructuring of post-Soviet agriculture, because that would, even while making agriculture more efficient, make them lose their only income source, as there is no alternative in Russian rural areas. That leads to the point that creating income alternatives in rural areas is a decisive prerequisite for overcoming subsistence agriculture. This argument is strengthened by the analysis of *VON BRAUN and LOHLEIN* as cited above.

But how to address this? *NUPPENAU's* contribution provides an overview: better linkages of agriculture to the downstream sector will increase both primary production profits and create off-farm jobs, thus increasing economic wealth in rural areas. This might be feasible, but it has to be stated that this cannot be done by agricultural policies alone. Structural policies must aim to develop rural areas, improve infrastructure and the climate for investments, and finally create a favourable environment for the downstream sector and other industries that will provide a labour market for those who have to quit agriculture. Structural policies also have the task of facilitating factor mobility, which is a crucial point for rural development.

But let us now leave the introductory remarks and go for a journey through Eastern Europe and its subsistence farming systems. We will start with the keynotes, which discuss theoretical approaches of subsistence agriculture, and possible institutional and political solutions. We will then go from the West to the East, starting in Poland, down to the Balkans, crossing over to Central Asia and ending up in Russia, where the most interesting systems, but also a tremendous pace of change, are found. By travelling this way, we shall, so is the hope of the editors, find some answers to the questions raised above, and also find some sympathy for those who have to struggle for their livelihood by farming their small plots. These people probably need the assistance of scientists and politicians more than anybody else.

Acknowledgements

Neither the conference nor this book would have realised without the assistance of many people to whom we are very grateful. Our special thanks go to the presenters and authors of the contributions, for their marvellous work and, more than anything else, for their patience during the long process of editing this volume. We would also like to thank the numerous reviewers for the time and efforts they spent pushing forward the quality of this book.

Our special gratefulness is dedicated to Dr. Klaus Reinsberg, without whom the seminar could not have taken place. He gave us a lot of support in raising funds, organising the seminar and doing the financial accounting. For the latter issue, we also have to thank Mrs. Margot Heimlich for her outstanding support. Thanks to Catrin Schreiber for organising the editing process, and for pushing it forward. Special thanks go to Jim Curtiss for the language revision. Milena Krasteva has done a great job in editing the proceedings, just as she has done so many times before. Of course, all the remaining faults are the sole responsibility of the editors.

Halle (Saale), Germany, October 2003

Steffen Abele and Klaus Froberg

REFERENCES

- ABELE, S. (2001): Bewertung von technischen Innovationen für kleinbäuerliche Betriebe in West-Niger unter Berücksichtigung von institutionellen Rahmenbedingungen, Stuttgart (Grauer).
- CAILLAVET, F., NICHELE, V. (1999): Autoconsommation et jardin: Arbitrage entre production domestique et achats de légumes, *Économie rurale* 250, März-April 1999, pp. 11-20.
- DOPPLER, W. (1991): Landwirtschaftliche Betriebssysteme in den Tropen und Subtropen, Ulmer Verlag, Stuttgart.
- HENZE, A. (1994): Marktforschung: Grundlage für Marketing und Marktpolitik, Ulmer Verlag, Stuttgart.
- ROSE, K., SAUERNHEIMER, K. (1995): Theorie der Außenwirtschaft, Vahlen Verlag, München.
- THIEDE, G. (1994): Die meisten EU-Betriebe sind nicht lebensfähig, *Landwirtschaftsblatt Weser-Ems* No. 33, pp. 35-36.

CONTENTS

Introduction	I
Subsistence Agriculture in Development: Its Role in Processes of Structural Change	1
<i>Franz Heidhues, Michael Brüntrup</i>	
Institutions and Technologies for Subsistence Agriculture: How to Increase Commercialization	28
<i>Zvi Lerman</i>	
Policy Options to Overcome Subsistence Agriculture in the CEECs	46
<i>Joachim von Braun, Daniela Lohlein</i>	
Decision Making Patterns of Subsistence Farmers in Bulgaria	71
<i>Plamen Mishev, Philip Kostov</i>	
Commercialisation of Subsistence Agriculture in Transition Economies: On Imperfect Competition, Market Development and Support Policies.....	86
<i>Ernst-August Nuppenau</i>	
Development Perspectives of Subsistence Farms in Southeastern Poland: Social Buffer Stock or Commercial Agriculture?	107
<i>Martin Petrick, Ewa Tyran</i>	
The Market Potential and Patterns of Contemporary Agriculture in Romania's Northwestern Plain.....	124
<i>Csaba M. Kovács</i>	
Subsistence Farming in Bulgaria: Between Tradition and Market Requirements.....	133
<i>Diana Kopeva, Nivelin Noev</i>	

The Significance of Subsistence Farming in Georgia as an Economic and Social Buffer	147
<i>Hannah Kegel</i>	
Agrarian Reform and Subsistence Agriculture in Russia.....	161
<i>Vladimir Yefimov</i>	
Economic Background and Development Opportunities of Individual Subsidiary Holdings in the Ukraine: Some Empirical Evidence	179
<i>Andriy Nedoborovskyy</i>	
Modeling Subsistence Agriculture in Russia: Effects of Total Productivity Changes and Reduction of Marketing Margins	189
<i>Peter Wehrheim, Peter Wobst</i>	

SUBSISTENCE AGRICULTURE IN DEVELOPMENT: ITS ROLE IN PROCESSES OF STRUCTURAL CHANGE

FRANZ HEIDHUES, MICHAEL BRÜNTRUP

1 INTRODUCTION

Subsistence agriculture is closely linked to a low level of economic development. We find it both in today's less developed countries and in the early stages of industrialised countries. Typically, subsistence agriculture is characterized by a low-external input level and low productivity (per land and/or per labour). In these situations agriculture is generally the dominant economic activity, thus allowing subsistence and agriculture to appear identical.

The term "subsistence agriculture" is used synonymously with such concepts as traditional, small scale, peasant, low income, resource poor, low-input or low technology farming. Many of these concepts are also used in non-economic disciplines with very different meanings. Thus, it is difficult to give a generally accepted definition of subsistence agriculture – the definitional problems will be discussed below.

Whatever the terms used to describe subsistence agriculture, the attributes ascribed to it are predominantly negative, at least in the agricultural economics literature (ROGERS 1970; SEAVOY 2000). Subsistence-oriented agriculture is said to lack efficiency of resource use for various reasons:

- The priority given to satisfy family needs implies foregoing the benefits of comparative advantage, specialisation and division of labour. It assures only a low standard of living for subsistence farmers and their families;
- Formal credit and external inputs are rarely used in subsistence production. Simple technologies, lack of entrepreneurship and absence of specialisation keep land and labour productivity low;
- Markets are supplied only if there are surpluses from subsistence production, which occurs mainly in good harvest seasons. Subsistence agriculture, therefore, cannot be relied upon to provide a continuous food supply to urban

populations. Also, such production patterns trigger high price instability on food markets;

- Subsistence agriculture displays low responsiveness to policies and is therefore difficult to influence through developmental policies.

In summary, farming oriented towards subsistence is usually seen as synonymous with backwardness and inefficiency, holding down economic growth and economic performance.

Consequently, governments have tried to change or eliminate subsistence agriculture: Colonial and post-colonial governments in many developing countries have tried to force peasants into markets by poll taxes, imposed labour and cropping practices and mandatory deliveries. Marxism-Leninism has systematically suppressed peasantry.

In this paper we will argue that, although subsistence agriculture may at first appear to be an impediment to economic growth, it often is the only way for rural people to survive under extremely difficult and risky conditions. Subsistence can be seen as an effective strategy to cope with high transaction costs and risks and uncertainties that threaten poor families' survival. Subsistence agriculture can even play an important role in stabilising fragile economies. Policies need to take these aspects into account and instead of neglecting or even fighting subsistence agriculture, they need to address the underlying reasons for the drift into subsistence and open viable ways for farmers to increasingly join markets.

In the following, we will a) review the changing role of traditional (subsistence) agriculture in overall development, theory and practice over the last few decades, b) discuss issues regarding the definition of subsistence agriculture, as the concept of subsistence itself is unclear and often a major source of misunderstanding and confused analysis, c) discuss within the framework of the main theoretical concepts the numerous factors which can contribute to the emergence and persistence of subsistence agriculture, and d) draw conclusions for policies and further research. The emphasis will be on developing countries where most of the research on subsistence agriculture has been done. Where we see parallels, we will make references to the situation in transformation countries.

2 TRADITIONAL AGRICULTURE IN DEVELOPMENT THEORY

Developmental economists of the 1950s did not view agriculture as an important contributor to economic growth (JOHNSTON 1970). They knew little about tropical agriculture and there was no substantial body of empirical literature to draw from (LITTLE 1982). Development economists' thinking in the 1950s and 1960s was dominated by the dualistic model of development, which was based on W.A. LEWIS' influential article titled "Economic Development with

Unlimited Supplies of Labour" (LEWIS 1954). LEWIS presented a theoretical model of economic growth with two sectors – a modern, mostly industrial sector and a traditional, mostly agricultural sector, which was largely comprised of subsistence farming. Growth and development took place through the transfer of labour from the subsistence sector, where the marginal productivity of labour was low, to the modern sector, where marginal productivity of labour was high and where the reinvestment of profits was driving economic expansion and creating new employment opportunities.

The minor role attributed to agriculture in economic growth was reinforced by Prebisch's and Singer's thesis of declining terms of trade for countries exporting largely primary products. Also, HIRSCHMAN's book "The Strategy of Economic Development" (HIRSCHMAN 1958), which advanced the unbalanced growth model with the concept of "linkages" as the central instrument necessary to induce the investment process, did little to draw attention to agriculture; agriculture lacked the direct stimulus to spur investments in other sectors through linkage effects.

Other reasons for the scant attention given to agricultural research and particularly subsistence farming include:

- Agriculture, and particularly subsistence agriculture, are seen as low productivity sectors that lack the dynamism to act as the motor of economic development;
- Subsistence farmers' behaviour often appears "mysterious" to economists; they seem to behave irrationally, or at least in ways not consistent with the principles of economic theory;
- The science of economics and its analytical tools are based on the existence of markets which are outside of the range of subsistence;
- Research is difficult because statistics about subsistence are not available or unreliable;
- Subsistence farming is seen, even derided, as being traditional and resistant to change and innovation, thus barring it from being a preferred target group for development practitioners and policy makers.

It was only relatively recently in the process of development research that greater attention has been given to agriculture and subsistence farming. This was triggered by recognizing that without agricultural growth, the lack of food, resulting in increasing amounts of foreign exchange spent on food imports, would tend to choke the development process. Moreover, the increasing number of failures of development programs, which too often were based on modernization approaches and innovation technologies, without taking subsistence farmers' resource constraints, institutional and infra-structural limitations and traditional cultural values adequately into account, also played a role.

That the neglect of agriculture in the industrialization models was theoretically inconsistent and would inevitably lead to the strategies' failure, was pointed out early on by agricultural economists. JOHNSTON and MELLOR argued already in 1961 that agriculture had an important role to play in a country's development. It could provide – apart from labour – capital and foreign exchange; even more importantly, it would need to supply the food necessary for an expanding industrial and urban sector and it would be an important market for the industrial sector's output (JOHNSTON and MELLOR 1961).

The subsequent discussion was instrumental for economists' thinking about agriculture in development: it stimulated interest in looking at the interdependencies between agricultural and industrial growth and also stressed the importance of an improved understanding of agriculture itself as well as the process of agricultural change (MELLOR and MUDAHAR 1992). Moreover, the discussion had an important impact on the agricultural economics research approach, i.e., it encouraged movement away from a priori theorizing towards empirical research (STAATZ and EICHER 1998).

Within this line of thinking it was THEODORE W. SCHULTZ' seminal work "Transforming Traditional Agriculture" (1964) that gave small farmer research a major impetus. The influence of T.W. SCHULTZ's book for research on subsistence farming can hardly be overstated; it highlighted the importance of understanding small farmers' ecological, economic and institutional environment, which determines and explains their behaviour and decision making as rational and efficient. SCHULTZ's "efficient but poor" hypothesis of small farmer behaviour triggered a major shift in research from macro-strategy thinking into micro-behaviour research.

From the historical perspective, agricultural research has gone through further ups and downs in development thinking. SCHULTZ's (1964) emphasis on the technology constraints that lock farmers into operating at low levels of productivity encouraged major investments in agricultural research and technology development.

Many agricultural research centres were involved in developing high yield crop varieties that laid the foundation for what has become known as the Green Revolution, an innovation package comprising new seeds, fertilizers, water and plant protection. The Green Revolution had a two-fold effect on subsistence farming research and thinking. On the one hand, as a scale neutral and divisible technology, it was also suitable for introduction into existing small-scale farming systems. It allowed subsistence farmers to increase market production while maintaining the level of subsistence production necessary to feed their own family. On the other hand, as it required external inputs, the institutional and policy environment became important.

The lack of farmers' response to innovation packages and the concomitant failure of many agricultural development projects, most notably those in Sub-Saharan Africa, led to a shift in attention to the policy and institutional environment. Policy research made it increasingly clear that the earlier emphasis on industrialization models had led to "urban bias" policies that discriminated against agriculture. In many developing countries, agriculture was heavily taxed, both directly through export taxes and indirectly through pricing and trade protection mechanisms and overvalued exchange rates.

Beginning in the early 1980s the pendulum swung back towards placing major emphasis on macro-policy and structural adjustment. Macro-economic stabilization, privatisation, trade and exchange rate liberalization and fiscal discipline all had major impacts on economic growth. At the same time it became apparent that these policy changes also implied costs and that the costs in most countries were unevenly distributed and often heavily borne by the poor. Income distribution, poverty and food insecurity moved to centre stage. Research into the social dimension of structural adjustment, the causes of persistent poverty and increasing attention to the degradation of natural resources moved part of the attention back to the micro level. Farmers' ecological basis and natural resource endowment, as well as their institutional and socio-cultural environment are emerging as key determinants of their livelihood.

At the same time, on the macro-level, emphasis has also shifted to include, aside from the economic policy area, the importance of the political scene. The importance of good governance, a fair and enforceable legal and administrative framework and the role of civil society have been brought to the forefront. In the new concepts such as the comprehensive development framework, the macro framework as well as the functioning of small farmers' environment at the micro-level are important for improving rural livelihoods. Government at all different levels, the private sector and the numerous social structures of civil society, are all seen as necessary to fight poverty and move development forward.

3 SUBSISTENCE IS A FUZZY CONCEPT: DEFINITIONAL ISSUES

By using the term "subsistence" in the development debate, one descends a slippery slope. There is no copyright for the term "subsistence" in any one discipline. Early interdisciplinary attempts to discuss subsistence economy found that "the most frequent (conceptual difficulty) concerned the various notions of 'subsistence' and different levels of analysis or aggregation" (WHARTON 1970). It is important to understand these disciplinary differences since agricultural economics is not the only discipline that has a stake in the discussion and formulation of development policies.

But even within the economic disciplines the term subsistence is used with different meanings. We want to highlight three sources of ambiguity: a) subsistence is used as a concept of market-integration but also as a concept for measuring the standard of living, b) subsistence orientation can be measured from the point of view of consumption but also of production, and c) adding to these conceptual ambiguities, any subsistence indicator can move along a gradient from almost 100% to practically zero. Drawing the line between subsistence and market orientation always involves a certain arbitrariness.

It would go beyond the purpose of this presentation to discuss the different definitional concepts. We will limit ourselves to classifying the definition most commonly employed in the agricultural economics discipline, which relates to the share of production devoted to a family's own consumption. For a more detailed presentation of the different conceptual definitions within the economics discipline please refer to Annex 1 of the paper. In agricultural economics, the share of production devoted to the family's own consumption is most often used as the criterion of subsistence farming. Thus, a farmer who "predominantly" produces for his or her own family's consumption is labelled a subsistence farmer. If he produces predominantly for the market, he is considered a commercial farmer. Where to draw the line is arbitrary – often the 50% line is used.

4 DETERMINANTS OF SUBSISTENCE PRODUCTION

Any policy effort that aims at changing subsistence agriculture requires an understanding of its determining factors. Experience has shown that "programs of directed change designed to reach peasants are likely to fail unless based upon understanding of the values, attitudes, and motivations of this audience" (ROGERS 1970).

With development, technological change, urbanisation and industrialisation, improvements in infrastructure and transport, etc., markets for agricultural products and rural labour have emerged. International trade has also encouraged market production, technology development and the increase of productivity. Moreover, government policies have actively supported the switch from subsistence to market production, often by force (colonialist, socialist and many independently developing countries). But despite the long existence of such markets and efforts, billions of rural people have remained in a (partial) subsistence economy. In former socialist countries it even seems that a re-emergence of a "secondary" subsistence economy is visible.

Thus, what are those strong forces that keep rural people in subsistence, and even induce others outside of agriculture to get "back to the roots"? Subsistence agriculture is ubiquitous and dependent on internal and external factors; they are

inevitably multifaceted. In Figure 1 the determinant factors have been grouped into three categories:

1. Country external factors that are given for each country (such as a country's ecology, climate, history, culture and international environment);
2. The farm external and country internal factors, such as government policies, institutions, markets etc., which can be influenced by the country itself but are exogenous for the individual household;
3. The farm/household internal factors, i.e., factor endowment and farm-family specific characteristics. Farm/household decisions are influenced by all categories of factors. Many of these factors are interlinked and influence each other.

In the following, we will focus on those factors and theories which capture the most important of these determinants of subsistence production: these are Chayanov's model of peasant production; farm/household models with simultaneous production, consumption and leisure optimisation; transaction costs and market failures; and risk and risk aversion models.

Figure 1: Determinants of Subsistence Versus Market Orientation

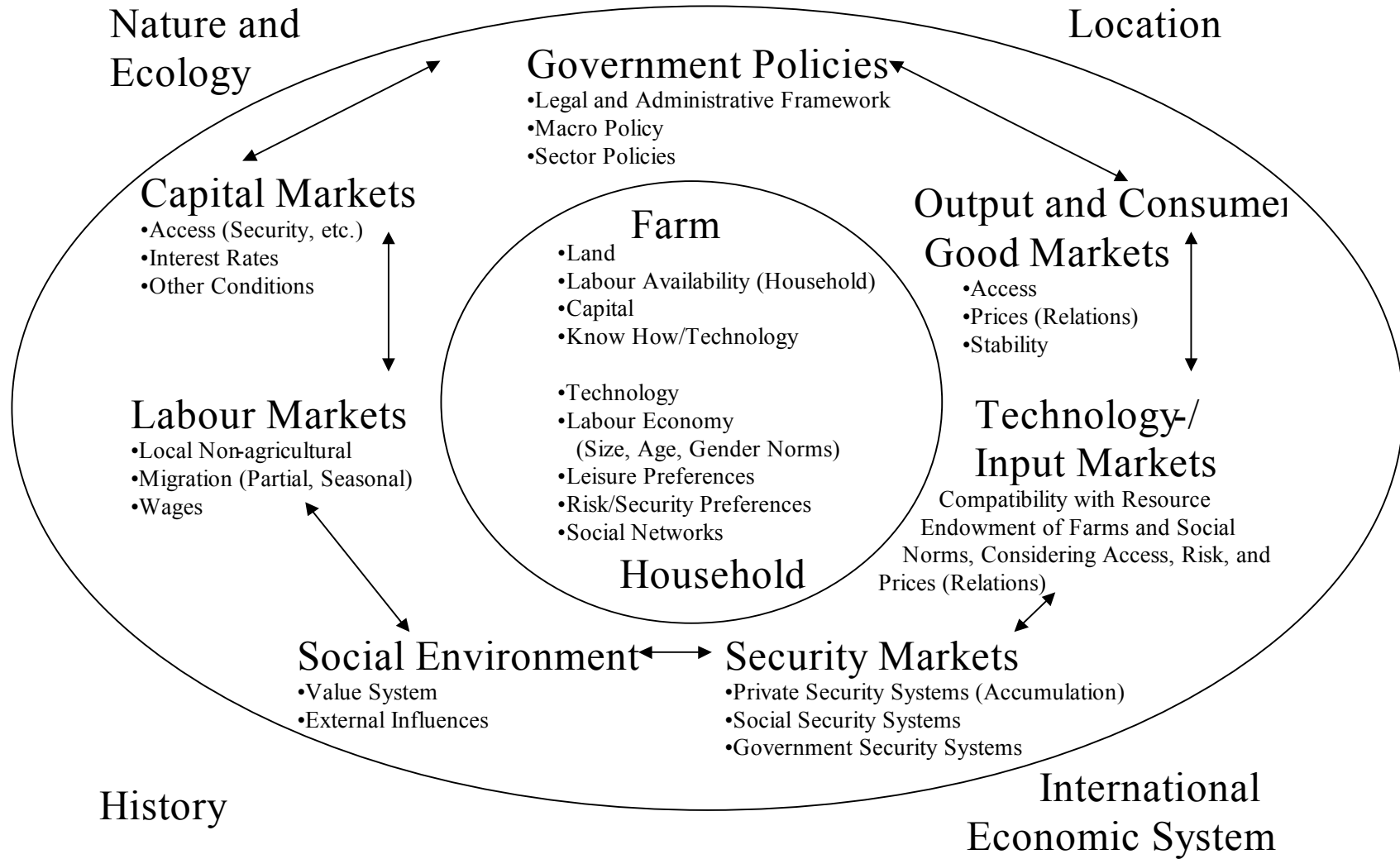

Source: Own design.

5 MODELS OF SUBSISTENCE PRODUCTION

Most prominent among the theories of subsistence production is the leisure model by Chayanov (THORNER et al. 1966). His theory is based on quantitative research of Russian peasant agriculture in the 1920s. The fundamental hypothesis is that peasants have a high marginal propensity for leisure even if it means sacrificing additional income, i.e., they prefer to reduce the hardship of manual work. This behaviour can lead to a backward bending supply curve which has been found in some studies in developing countries (compare PÜTZ 1991).

An extreme variant of Chayanov's propensity for the leisure approach is the hypothesis of a satisfying strategy, in which households work only to achieve a certain minimum level of consumption; they aim at maximising leisure. Such behaviour plays a dominant role in the alternative subsistence literature mentioned above; it automatically leads to a backward bending supply curve.

Chayanov's theory has been found useful in explaining farmers' behaviour in some areas, particularly in Africa (DURRENBERGER 1984). However, it assumes the absence of a labour market (ELLIS 1988). Whether Chayanov's model is relevant for the emergence of subsistence production in transformation countries is doubtful given that in many former socialist countries peasant agriculture plays only a minor role and labour markets do exist. In terms of the linkages shown in Figure 1, Chayanov's model focuses on history – the social environment, output markets, (the absence of) labour markets, household preferences and the labour economy.

A further elaboration of the Chayanov model of peasant behaviour is the farm/household model of new home economics. It also integrates consumption choices into decisions related to a household's time allocation. It maximizes the utility of three types of goods: self- and market-produced goods, home-produced goods for household consumption like fuel searching, water carrying, cooking, house repairing, child raising, etc., (the so called Z-goods), and real leisure. Z-goods are home-produced goods. A backward bending supply curve for agricultural products is possible if there is no labour market.

In most model specifications the household usually interacts with a labour market, i.e., it can buy or sell labour at the prevailing wage rate. The existence of a wage rate gives an externally determined value to time and leads to a separation of production and consumption.

For transition economies, the existence of a labour market with effective wage payments may be a crucial factor that contributes to (partial) subsistence production. Labour markets are often imperfect, with widespread open or hidden unemployment, non-payment of salaries, etc. Salaries are often low and not protected against inflation and purchasing power erosion. Wages may fall below

the subsistence level and force those who have the opportunity (access to land and basic inputs) into subsistence production. Decision analyses must be capable of taking these considerations into account. These models capture the linkages between labour markets, household preferences and labour economy (in Figure 1).

Rural farm/household interactions with markets are generally subject to high transaction costs, particularly under conditions of underdeveloped market infrastructure such as those typically found in developing countries. They originate in imperfect information, transportation, negotiation, monitoring and supervision, motivation, coordination, management, etc. A comprehensive approach to analyse the impact of transaction costs on self-sufficiency is presented by DE JANVRY and SADOULET (1992) (see Figure 2). "The result (of transaction costs) is that there exists a price band that creates a gap between the effective price received for items sold and the effective price for items purchased. There exists a range of products and factors for which equilibrium between supply and demand occurs within the price band. In this case, the shadow price is higher than the sale price and lower than the purchase price, with the result that neither sale nor purchase are desired, and there is self-sufficiency in this commodity or factor". Seen in this way, a commodity is not by its nature a tradable or non-tradable one, and a farm is not defined as subsistence or market-oriented by its production or consumption structure, but by prices and transaction costs specific to each decision unit.

DE JANVRY and SADOULET (1992) identify five basic cases that illustrate when farmers will participate in the market and under what conditions they will behave as subsistence producers (see Figure 2): farmers are net sellers if the supply conditions allow production at costs below the lower price band ($q(p)^5$ in Figure 2); they are net buyers if the internal costs are above the higher price band ($q(p)^1$); for those situations in between, farmers will neither buy nor sell, but are regarded as self-sufficient.

This concept allows an analysis of how a certain policy measure, by changing transaction costs, affects supply response. It can, for instance, explain why many subsistence households do not reduce their production of self-consumed commodities and increase purchases when the market price falls (the effective purchase price does not drop under the internal cost price) or why market production is not increased by upward price shifts (the effective sale price does not surmount the internal shadow price), and why an aggregated supply response is much lower than that of individual farm/households (only a part of farms comes out of the price band).

The DE JANVRY/SADOULET model of subsistence production is more suitable to the real world of small farmers and rural populations than those classical approaches to agricultural development which disregard institutional issues and imperfect markets.

Figure 2: Supply Response under Price Bands for Units with Different Supply Functions

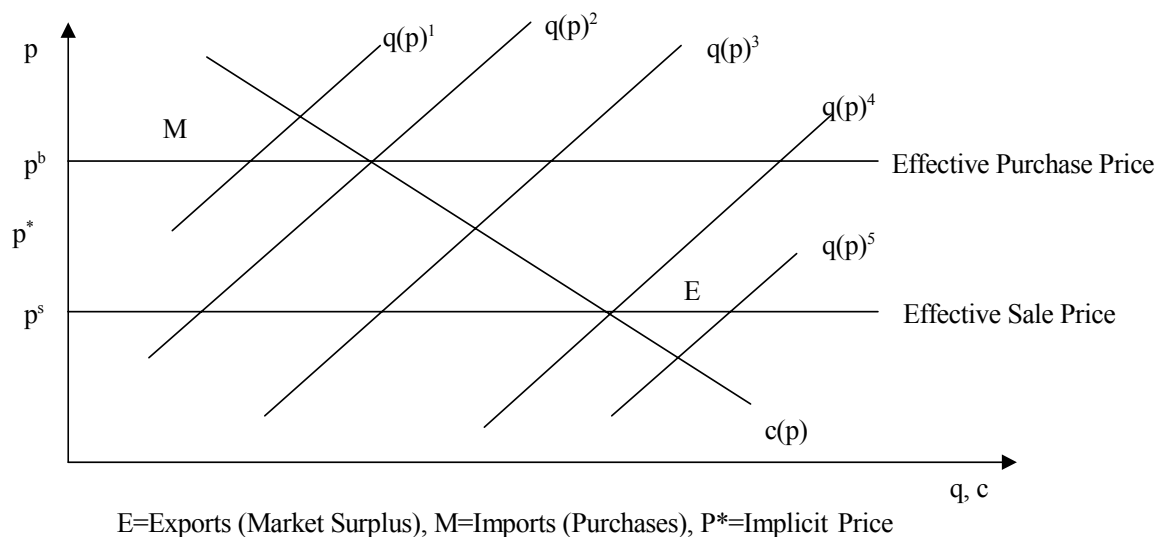

Source: According to DE JANVRY and SADOULET (1992).

An important reason for the dominance of subsistence production often is the lack of market access for outputs, inputs and consumption goods. In Figure 2, this would mean that the price P^* is extremely low. This may be due to extremely high transaction costs and trade risks that are prohibitive for agricultural supply from remote areas to find market outlets. Today, in a highly integrated international market for agricultural products and subsidisation of exports by many industrialised countries, such a situation has become a serious market threat for the landlocked African countries. It could also be a relevant scenario for transformation countries if it is cheaper to supply the urban centres from the international market rather than from own rural areas. These trends may be reinforced if rural infrastructure continues to degrade.

Subsistence production may be the result of inaccessible consumption goods. If there is no access to consumer good markets, the incentive to produce marketable surpluses is low (AZAM and BESLEY 1991). Several studies show that in Africa's early colonial times, farmers had no incentive to produce as they had no access to consumption goods considered useful. The colonial powers introduced (poll) taxes with the objective of creating a need for farmers to earn monetary income (ELWERT and FETT 1982). In today's world many consumer goods are easily accessible even in remote areas. The explanatory power of this model in today's world is rather limited (linkages shown in Figure 1 are location, (policy) – input markets, output markets – consumer goods markets – household utility).

Inadequate access to technology inputs and rural finance markets may constitute a constraint for farmers to produce for the market. The lack of appropriate technology has been identified as a serious problem for large parts of rain fed

agriculture in developing countries, particularly in marginal areas where green-revolution technology packages are not working (DOMMEN 1988; BROMLEY and CHAVAS 1989).

Closely linked with the existence of technologies is the access to necessary inputs and credit. In developing countries input and credit markets are often inaccessible for small farmers and/or distorted by policy intervention (BOSC and FREUD 1996; DELGADO 1995). Credit access is often limited by lack of physical collateral (land), high transaction costs (particularly information) and distorted credit markets. With no access to suitable technologies, inputs and rural finance, farmers remain at a low level of productivity and have high production costs; in Figure 2, supply curves would be far to the left and few farms would be producing for the market linkages shown in Figure 1: history, policies – capital market, input markets – farm capital and technology)

Subsistence production may be the result of taxation. Farmers focus on subsistence if prices for agricultural products, particularly exports, are depressed by heavy taxation. Typically, in colonial and post-colonial Africa, producer prices for important export crops have been taxed to the extent that variable costs and labour are no longer covered. Under those incentive structures, farmers often return to subsistence production (HEIDHUES and WEINSCHENCK 1989; GHAI and SMITH 1987; FALGON 1988; MAXWELL and FERNANDO 1989).

6 BEHAVIOUR OF SUBSISTENCE PRODUCERS: RISK COPING STRATEGIES

Risk behaviour of farms/households has been widely researched. A common and consistent result has been that poor farmers have been found to be extremely risk averse (BINSWANGER 1980). This can be generalised for most human behaviour in situations where the consequences of risk are serious or life threatening.

The models of risk behaviour (see Annex 3) show that subsistence agriculture can be interpreted as the protection of a household against extreme and unpredictable risks, particularly risks that may endanger a household's survival or expose it to hunger. In these situations, the implications at stake for an unfavourable event (income loss, lack of food provision, lack of basic social security – in effect risk of hunger and starvation) are so far reaching that they justify extremely risk averse behaviour. Subsistence agriculture may be inefficient in terms of return to labour, investment or other factor input, but it assures survival and a basic standard of living without, however improbable, disastrous consequences.

Resource poor farmers in developing countries have been observed to choose from a wide variety of risk coping strategies involving both agricultural and non-agricultural activities. While in transition countries rural people move into subsistence agriculture, in developing countries they come from that position. It

may be hypothesised that both will search for an optimum of income and security that follows similar objectives.

What then, are the options for subsistence households to cope with the various risks they are exposed to given their ecological, infra-structural and institutional environment? Farmers' options to cope with risk may be categorized in five groups. Strategies and activities subsumed under the five headings are in many ways interlinked and even dependent on each other; they may reinforce or counteract each other.

Figure 3: Food Security and Survival at Risk – Options to Secure a Farm's/Household's Food Security

Increasing/ Diversifying Own Production	Wealth Accumulation	Gaining Access to Markets	Seeking Off-farm Employment	Security Systems
<ul style="list-style-type: none"> • Expand Area • Increase Productivity (Technological Change) • Diversification of Farm Activities and Cropping Pattern 	<ul style="list-style-type: none"> • Storage • Saving • Asset Building (Livestock, etc.) 	<ul style="list-style-type: none"> • Credit (Insurance) • Input/Output • Knowledge 	<ul style="list-style-type: none"> • In Agriculture • Non-agricultural Activities 	<ul style="list-style-type: none"> • Intergenerational Insurance, Child Education • Institutional Capital (Insurance Systems) • Social Capital

Source: Own design.

1. The first group of coping strategies is directed at the diversification of farm production activities. A whole range of highly sophisticated actions can be observed, often testifying to farmers' intimate knowledge of their soils' characteristics, such as fertility, moisture holding capacity, erodibility, etc. Farmers may try to increase production, either through expanding cultivated land or through introducing productivity enhancing technologies or management changes. They may plant early or late depending on observed rainfall and weather patterns; they vary crops within and between fields; they adjust their cropping pattern and leave fields fallow; they vary the seeding rate and mulching/manuring pattern, etc. It is this fine-tuned and sophisticated resource management that leads THEODORE SCHULTZ to conclude that outsiders could, at the given level of technology, add little to efficient resource allocation. These "poor but efficient" farmers could only be moved to higher levels of production by technological change, i.e., by research, innovation development and actions to get farmers to accept them.
2. Farm households regularly save and build assets for various reasons. A key motive is "to provide for emergencies" (JUNG 1987; see also RUTHERFORD 2000). Also, food storage is an often-observed risk coping strategy, although climatic and storage technology may limit its applicability. Other asset

building strategies include accumulating livestock as a multipurpose asset, which serves as productive investment, income diversification, risk insurance, and source of energy. Planting trees may serve similar functions. Jewellery and clothes are frequently found as forms of saving in the absence of secure ways of storing money.

3. Establishing and strengthening links to markets can be an important strategy for dealing with risks. Access to knowledge, credit, and input and output markets is a precondition for raising productivity.

Credit markets, apart from their vital role in enabling the acquisition of investments and modern inputs, often play a special role in dealing with stressful situations. Access to credit can be an important and efficient instrument to help bridge short-term, temporary food stress situations. Without credit access, households may be forced to sell their equipment, animals or other means of production to survive. With access to credit, households can avoid losing their productive assets, and recovery after stressful situations is faster (ZELLER et al. 1997). Credit access has also been found to be more efficient than national or regional food aid or emergency support programmes, as credit is a flexible instrument that allows tailoring the credit to the specific needs of individual households and thus avoids the administrative costs and leakages of wholesale support programmes.

4. A particular form of asset building as a risk coping strategy is the formation of human and institutional capital. Children are sent to school, particularly to secondary or tertiary education, to be able later on to assist their families in overcoming stressful situations. This can also be considered as a diversification strategy out of agriculture.

Solidarity networks are probably the most important insurance institutions for subsistence households. Particularly in rural areas, many types of ceremonies, invitations and reciprocal exchange of gifts serve the purpose of building mutual solidarity networks. Other expressions of social security institutions are working groups, savings and credit groups, renting livestock and land at reduced costs, gifts, visits, adoption of children, etc. Building solidarity networks entails high opportunity costs in the form of the time necessary to form and maintain them. GROH (1986) argues that most labour inefficiencies found in traditional societies can probably be explained by the time-intensive efforts required for maintaining solidarity networks.

Social networking is an effective insurance against individual risks such as farm-related production short-falls, sickness or death of family members, fire, theft, etc. Against collective and positively covariant risks, such as widespread droughts and floods, war, massive market collapse, etc., it is less effective. Their effectiveness increases, however, with sectoral and spatial diversification of the network (FAFCHAMPS 1992; PLATTEAU 1991).

A serious but often neglected problem of informal solidarity networks is the free riders syndrome or the "abuse" of solidarity (people may work less and rely on help, and they may hide, dissimulate or misrepresent their situation of need or affordability). The most important response of networks is to have contingent security to ensure a survival or subsistence level. Another efficiency problem of solidarity networks is that "accumulation wealth constitutes both a curse and a blessing for the mutual insurance system", (FAFCHAMPS 1992) since wealth constitutes a personalised insurance and permits the better off, who are in principle the most valuable elements for the system, to escape it.

In summary, despite many mechanisms for reducing the incentive problem such as insuring only a minimum subsistence level, heavily penalising misuse, stigmatising escape from solidarity duties, networking along family and neighbourhood linkages in order to reduce monitoring costs, and landlord-client types of relations which allow to include poor and wealthy in the same network, the fact persists that mutual solidarity systems tend to reduce the level of production.

5. Diversification of household activities may extend beyond the farm production domain and include off-farm employment in agriculture or non-agricultural activities, often linked to temporary or long-term migration. This is favoured by the fact that farm/household and social security networks are inefficient at dealing with covariant risks at the local level.

7 CONCLUSIONS

Subsistence is an imprecise concept. In this paper we use the concept of subsistence production to imply a farm/household production dominated by agriculture and producing predominantly for its own consumption needs. However, in different contexts subsistence is used with different meanings and has become a term burdened with prejudices and misinterpretations. Is it a consistent use of the term subsistence if we hear that 90% of the potato market, in Russia for example, is supplied by "subsistence farmers"? Perhaps we should avoid the term in favour of more neutral concepts such as "small scale" farming. If the term "subsistence" is used, it needs to be clearly defined and placed in its material and behavioural dimensions to avoid confusion and elicit prejudices.

The existence of a subsistence sector may have different origins. In the early stages of economic development it is caused by the absence of markets, low technology levels and division of labour. It conforms to and is part of traditional behaviour. Where subsistence agriculture coexists side by side with commercial agriculture it can be explained as a response to high transaction costs and very risky environments. The distortions of markets for inputs, outputs, consumer goods, labour, capital and security should be explicitly taken into consideration

when analysing subsistence production. Subsistence agriculture constitutes a low-level but secure survival strategy.

In consequence, subsistence agriculture is not only an indicator of poor market performance and high transaction costs, it also fulfils important functions which should not be neglected. Despite its low efficiency it may be the most rational answer to an adverse environment. Strategies to improve the efficiency of subsistence-oriented agriculture should be based upon the understanding of the factors underlying farmers' decisions. A special "non-economic" mentality often associated with subsistence production should not be presumed or should be empirically underscored – we would argue with RUTTAN (1988) that "one should try to understand economic phenomena before making judgements about them".

Some of the elements of this analysis are:

- Farms and households in subsistence-oriented agriculture have to be seen as an interdependent and simultaneous allocation of production and consumption;
- High transaction costs for input, output and particularly food commodities can explain subsistence behaviour;
- Risks in agricultural production and off-farm employment, in consumer goods, credit and security markets, as well as uncertainty stemming from past and future policy interventions should be taken into account explicitly;
- We have not discussed the issue of intra-household aspects of subsistence agriculture, but in many cases they are of prime importance – particularly the gender orientation of labour allocation and decision making must be considered for research, technology and policy options (ELLIS 1988; QUISUMBING 1993; UDRY et al. 1995; FALCON 1996).

A policy orientation against subsistence farmers' interests will fail. Even relatively effective coercive instruments and institutions in colonial times were hardly ever successful, and in poor countries with a weak government, as well as in democratic societies with a strong rural population, this will even be less likely.

In contrast, if subsistence producers are considered as rational, technological and institutional options should be designed to cater to their objectives. According to our discussion, these should aim at:

- Reducing transaction costs (infrastructure, market institutions, legal security, information, transport, etc.);
- Improving stability in farm input and output markets, particularly of those relevant for survival, but also in the off-farm sector (employment and wages) and the macro-economy;
- Supporting reliable finance and social security development;
- Developing technologies which conform with the objectives, needs and constraints of subsistence farmers.

Since improvements of key economic variables are difficult to discern in a highly variable environment, and since decisions about issues of survival will be governed by strong risk aversion, it must be accepted that responses of subsistence farmers will be sluggish. New institutions must gain confidence over a longer period before they have proven their sustainability and efficiency. It is probable that many subsistence farmers will rely on subsistence production at least in the medium term before they (re)turn to more market reliance.

ANNEX 1

The three main sources of ambiguity about subsistence will be further discussed here: 1) subsistence is used as a concept of market-integration but also as a concept for measuring the living standard, 2) subsistence orientation can be measured from the point of view of consumption but also of production, and 3) any subsistence indicator can move along a gradient from almost 100% to practically zero.

- 1) Subsistence can have both a meaning of material consumption in the context of the definition of subsistence level but is also used in the meaning of a certain way of production (subsistence production) which subsumes certain typical behaviours.

In classical economic texts (Smith, Ricardo, Malthus), subsistence is basically understood as a material consumption basket that is necessary for (working) people to make a living and to reproduce themselves. This subsistence level is, however, higher than the sheer existence minimum (SHARIF 1986), it is a "basic need" consumption basket which can only be defined with respect to a certain society and time. If, in addition, immaterial needs are included such as freedom, social security or cultural identity, it is hardly an operational concept.

The alternative approach to "subsistence" is the way of earning subsistence needs, or subsistence production. Particularly in non-economic contexts (anthropology, sociology, psychology, history, politics), production, exchange and consumption are not simply economic acts subject to optimal allocation of resources but embedded in social norms of behaviour. Thus, the economic decision includes non-material issues such as reproduction, social considerations, leisure preference or religious beliefs. Modern feminism has added the intra-household perspective of women producing mainly reproductive services. Women's role and value depends on the appreciation of these essential subsistence goods which is subject to social considerations. All these behavioural components are often seen as inherent to subsistence production and as different from market production where produced goods are exchanged on an anonymous market.

Although modern economics sometimes tries to include these issues in diverse utility functions (leisure, household Z-goods, risk premiums, etc.), there are certain limits, particularly in defining a common measure of utility in the absence of (uniform) prices for most if not all of the goods and services in the absence of anonymous markets for them. Also, the notions of power and exploitation are rather uncommon in classical economics.

The divergence of concepts can be very large, to the extent that communication regarding the subject is endangered. Whereas in economics

one would assume that subsistence economy is always based on subsistence agriculture due to the fact that for low-income households, food alone makes up for much more than 50% of total consumption value, in some non-economic approaches subsistence production can consist entirely of non-food products which are marketed. What counts for the classification in these cases is that the income level is low (e.g., slum population) or that the objective of production is not profit maximisation but consumption satisfaction (see for example MIES (1995) or BENNHOLDT-THOMSEN (1981)). If agricultural economics wants to effectively participate in the political debate, it has to take this competition for definition into consideration.

Whatever the case is in non-economic disciplines, most development and agricultural economists understand subsistence economy as a model of behaviour. There is a frequent connotation that the decisions of the subsistence economic subjects follow a special logic which is different from the classical income maximising "homo oeconomicus". For example, the list of attributes compiled by ROGERS (1970) cites: 1. Mutual distrust in interpersonal relations, 2. Lack of innovativeness, 3. Fatalism, 4. Low aspirational levels, 5. A lack of deferred gratification, 6. Limited time perspective, 7. Familism, 8. Dependency upon government authorities, 9. Provincialism, 10. A lack of empathy. Economic textbooks amply discuss the special economic logics ascribed to subsistence farmers (UPTON 1987; ELLIS 1988).

Given the strong social values in which economic decisions are embedded in subsistence economies, research often doesn't focus on individual decision makers, as does classical economics, but on larger social units (households with complex productive and reproductive functions, families, groups, clans or villages). SCOTT (1976) talks about "moral economies" for the mix of economic calculus and social embeddedness which is included in any transaction.

- 2) In the frame of a seminar of agricultural economists, one would think that a more precise definition would be easier to find. We exclude purely behavioural definitions and look at the facts – the distribution of agricultural production between market and farm/household consumption. If a certain minimum or maximum share is exceeded, we talk about subsistence orientation. But even for such a seemingly simple concept the definitional problems do not end. This stems from the fact that subsistence intrinsically links production and consumption issues. But there is a fundamental difference between the subsistence orientation of household consumption and that of production.

According to whether share of self-produced goods in the household's total consumption is taken as the measure of subsistence, or the share of production which is sold, subsistence agriculture can describe completely

different situations. A small example may illustrate this (Table 1): A relatively large mechanised Asian monoculture rice farmer (A) who can cover 50% of his family's food consumption with only 10% of his production is in a clearly different position from a manually operating African farm family (B) which needs two thirds of its diversified production to cover more or less 50% of its consumption needs, and from an East European part-time (C) farmer who satisfies 50% of his family's consumption needs by 100% of his Datscha food production but who (or his wife) disposes of a basic salary for the satisfaction of non-food consumption.

Table 1: Degree of Subsistence Dependence According to Whether Measured by Production, Consumption or Income for Three Example Farm/Households

	Aa	Ab	B	C
Value of Subsistence Production/Consumption	10,000	10,000	10,000	10,000
Value of Sales	90,000	90,000	5,000	0
Value of Total Production	100,000	100,000	15,000	10,000
Value of Inputs and Hired Labour	40,000	80,000	0	0
Cash Farm Income	50,000	10,000	5,000	0
Off-farm Income	0	0	10,000	10,000
Total Income	60,000	20,000	25,000	20,000
Subsistence Consumption as % of Total Production Value	10	10	67	100
Subsistence Consumption as % of Total Income = Consumption	17	50	40	50

Source: Own design.

Farmer A is subsistence-oriented as far as food consumption is concerned, but not if measuring the share of production sale. Whether he is a subsistence farmer with respect to income will depend on the use and costs of external inputs – in case Aa he has a relatively low input/output relation and would be classified as market-oriented, whereas in case Ab his high input costs would reduce his total consumable income to such a degree that his self-produced consumption would qualify him as a subsistence farmer. In cases B and C, classification as subsistence essentially depends on the amount of off-farm income.

All three farmers will have rather different reactions toward market signals, internal and external input use, credit utilisation or innovation adoption. It has been argued that probably the share of external in total input use is a better indicator for subsistence decision making than output indicators because it better grasps the dependency on external markets, risk of failure and indebtedness and other key issues (MIRACLE 1968).

- 3) The third major source of misunderstanding in the discussion about subsistence economies is already introduced above – subsistence is not equal to autarky. Since the first beginnings of trade in the stone-age there has existed an almost universal continuum of dependency between self-produced versus market exchanged consumption. Almost no peasant farmer today does

not rely at least partially on trade, be it by barter, monetary barter or real open market exchange. In consequence, subsistence agriculture is not a categorical classification but one of dimension and pattern of exchange.

Another issue of importance is the variability of subsistence degree. Particularly in rain fed agriculture, yields fluctuate strongly, to the order of several hundred percent, and in developing countries with little market integration prices also vary widely both within a year and across years. Price changes may be related to national production but often are determined by reasons outside the national agricultural sector (sector, trade and macro policies, foreign countries' production and trade policies, etc.). Thus, the degree of subsistence for any chosen indicator will strongly vary over the years.

Finally, the mode of market production is an important analytical issue. MIRACLE (1968) argues that there is an evident difference in the decision making situation between a farmer who sells a production surplus in 4 out of 10 years averaging 20% in the long run, and one who plans to and actually sells 20% each year. The first one would be badly advised to use a production credit as long as it is not assured that even during the worst years he can produce at least the extra-crop to repay his debt, whereas for the second the question of external input is less problematic.

Consequently, one could suppose that there is a continuum of decision logic between subsistence and market-oriented farming. This is, indeed, sometimes argued for (UPTON 1987; SCOTT 1976) when describing the decisions for food versus cash crops or other market productions¹. This mix of rationales makes empirical analysis very difficult since many actions can be interpreted from the point of view of both "worlds". As will be argued in Annexes 2 and 3, it can be assumed that subsistence behaviour is determined not by average year.s outcomes but by extremely bad years.

To summarize the unclear nature of the concept, one could conclude as MIRACLE (1968) does, that the term "subsistence" should be abolished. DOPPLER (1992) for example, labels only farmers with less than 10% market production "subsistence farmers", whereas between 20% and 90% he uses the term "transitory". Of course, this merely displaces the classification problem into this transitory class of farm/households for which diversity is at least as big as if using the 50% subsistence level, but it has the benefit of avoiding the co-notions implied by the term "subsistence". Only location-specific definitions and the transparent development of multiple indicator indices can help to make useful classification and analysis of farm/household systems with strong subsistence components.

¹ Similarly, women's reproductive and social roles for a household's survival within modern economy can be interpreted as a partial continuation of subsistence economy (MESMER 1986).

ANNEX 2

Exposé: Risk in Development

An essential feature of developing countries is their extreme insecurity and risk exposure. Risk not only concerns production and price but also most other factors of decision making – imperfect farm and non-farm, input and consumer commodity markets, off-farm employment and wages, contracts and institutions themselves. We think that risk and risk aversion are probably the most determining factors for explaining subsistence production in transition countries.

In their model (see Figure 2 of main text), DE JANVRY and SADOULET (1992) take into account the effects of production and price risks as changing the effective sale and purchase prices. When assuming risk aversion, which is typical for human beings with high stakes at risk, they come to the following conclusions: "Uncertainty in both production and price compound in inducing a decline in production for all categories (of farm/households), except for the net buyers with large purchases. A higher correlation between price and quantity, which occurs in segmented markets, corrects this adverse effect in inducing higher production. The mechanisms by which this occurs are, however, markedly different for different types of producers."

Thus, already for a restricted set of risk sources and assumptions it can be shown that risk reduces market production and fosters subsistence orientation. We want to make clear here that the dimensions of risk for low income people in developing countries are extreme and severe:

- The often assumed negative correlation between production and prices (e.g., LELE 1982), which implies a relatively reduced income variability compared to both pure price and production variability, may be true for aggregated production and segmented markets, but for an individual farm/household production is certainly much less correlated with prices because it depends on many household-internal factors. Hence, correlation between individual production and aggregate price level tends to be low;
- Relying on off-farm employment and related wage payments are themselves a source of considerable risk for households. Delayed wage payments and lay-offs are observed in both transition and developing countries. Infrastructure deficiencies may impede job execution and cause further wage layoffs. Beyond a certain limit households will consider dependency on wages as a survival risk;
- Input, output, service and credit markets often fail;
- Insurance systems are unreliable or absent;
- Policy and its impact on the above mentioned factors is unpredictable and a major source of uncertainty. The institutional environment is often inadequate and fragile (markets and their institutions, property rights, cooperative law, financial institutions, etc.) and the macroeconomic

environment is unstable (inflation, exchange regime and rate, government budgets, tax regimes, etc.). The civil society is not yet strong enough to prevent policy from making erratic changes which can completely turn upside down own plans.

It is generally accepted that risk and risk aversion reduce the efficiency of production through the attempts to reduce the negative effects of risky outcomes. Examples are high crop diversification, reduced levels of investment, inputs, and innovations, lower credit demand (for an overview of the numerous issues of risk in agriculture, see HARDAKER et al. 1997).

ANNEX 3

Exposé: Modelling Risk Behaviour

Two basically different models of risk aversion are competing variability reduction and disaster avoidance.

Variability reduction is the more elaborate and more widespread concept of risk averse behaviour analysis, with the expected utility theory of NEWBERRY and MORGENSTERN (1943) as its centre piece. It is based on several assumptions, the most crucial of which in our context is that for every distribution of a risky outcome an individual is supposed to have a secure level with the same utility. We would argue that for a situation where survival of the household is at stake and where subsistence production offers effective protection this axiom does not hold. In this case, a risk-neutral decision maker would not win on average if survival is endangered on negative deviations of production below the minimum existence level. Such decision makers would, thus, simply not survive in the long run. Even if it is not sheer survival that is at risk but "only" hunger periods or the sale of (productive or other) assets, farmers may subjectively judge such outcomes to be unacceptable. Indeed, risk aversion elicitation games and tests repeatedly show that risk aversion increases with the level of risk involved, and that particularly for extreme probabilities and outcomes people do not classify decisions according to utility theory (TVERSKY and KAHNEMANN 1982; SHOEMAKER 1982; BRÜNTRUP 1997).

The most uncompromising disaster avoidance behaviour is the "Maximum" decision strategy. It arranges production in a way that assures the maximum possible outcome in the most adverse of possible situations. This is a conservative decision rule with a substantial loss of efficiency over time. However, there are other more flexible formulations of disaster prevention risk strategies such as lexicographic ranking with subsistence production first, minimum regret, Hurwicz and Laplace rules, focus loss or penalisation of negative deviation (UPTON 1987; HAZELL and NORTON 1986).

Subsistence agriculture is thus to a large extent a protection of the household against the above mentioned unpredictable risks. The implications at stake for an

unfavourable event (income loss, lack of food provision, lack of basic social security – in effect risk of hunger and starvation) are so far reaching that they justify extremely risk averse behaviour. Subsistence agriculture may be inefficient in terms of return to labour, investment or other factor input, but it assures survival and a basic standard of living without, however improbable, disastrous conditions (Linkages in Figure 1: All elements are concerned).

REFERENCES

- AZAM, J.P., BESLEY, T. (1991): Peasant Supply Response under Rationing: The Role of the Food Market, *European Journal of Political Economy*, Vol. 7, pp. 331-343.
- BENNHOLDT-THOMSEN, V. (1981): Subsistence Production and Extended Reproduction, in: YOUNG, K., WOLKOWITZ, C., MCCULLAGH, R. (eds.): *Of Marriage and the Market: Women's Subordination in International Perspective*, CSE Books, London, pp. 16-29.
- BINSWANGER, H.P. (1980): Attitudes Towards Risk: Experimental Measurement in Rural India, *American Journal of Agricultural Economics*, Vol. 62, pp. 395-407.
- BOSC, P.-M., FREUD, E.L. (1996): Agricultural Research and Innovation in West and Central Africa: Insights from a Filière Approach, Paper Presented at the International Symposium on "Food Security and Innovations: Successes and Lessons Learned", March 18-22, at the University of Hohenheim, Stuttgart-Hohenheim.
- BRÜNTRUP, M. (1997): Agricultural Price Policy and its Effect on Production, Income, Employment, and the Adoption of Innovations: A Farming Systems Based Analysis of Cotton Policy in Northern Benin, *Development Economics and Policy*, Vol. 9, Lang, Frankfurt am Main.
- BROMLEY, D.W., CHAVAS, J.-P. (1989): On Risk, Transactions, and Economic Development in the Semiarid Tropics, *Economic Development and Cultural Change*, Vol. 37, No. 4, pp. 719-736.
- COLLINS, J., LAPPÉ, F.M. (1977): *Vom Mythos des Hungers*, Frankfurt am Main.
- DE JANVRY, A., SADOULET, E. (1994): Structural Adjustment under Transaction Costs, in: HEIDHUES, F., KNERR, B. (eds.): *Food and Agricultural Policies under Structural Adjustment*, Seminar of the European Association of Agricultural Economists, Hohenheim 1992, Lang, Frankfurt am Main, pp. 137-165.
- DELGADO, C.L. (1995): Agricultural Diversification and Export Promotion in Sub-Saharan Africa, *Food Policy*, Vol. 20, No. 3, pp. 225-244.
- DOMMEN, A.J. (1988): *Innovation in African Agriculture*, Westview Press, Boulder.
- DOPPLER, W. (1992): *Landwirtschaftliche Betriebssysteme in den Tropen und Subtropen*, Stuttgart.
- DURRENBERGER, E.P. (1984) (ed.): *Chayanov, Peasants, and Economic Anthropology*, Academic Press, New York.
- ELLIS, F. (1988): *Peasant Economics, Farm Household and Agrarian Development*, Cambridge Univ. Press, Cambridge.
- ELWERT, G., FETT, R. (1982) (eds.): *Afrika zwischen Subsistenzökonomie und Imperialismus*, Campus-Verlag, Frankfurt am Main.

- FAFCHAMPS, M. (1992): Solidarity Networks in Preindustrial Societies: Rational Peasants with a Moral Economy, *Economic Development and Cultural Change*, Vol. 41, No. 1, pp. 147-174.
- FALCON, W.P. (1996): Commentary: Food Policy Really Matters, Falcon Says in 20th Anniversary Lecture, *IFPRI Report*, Vol. 18, No. 1, pp. 1-4.
- FALGON, C. (1988): Politiques de prix et d'intervention sur les marchés agricoles en Afrique FAO, Rome.
- GHAI, D.P., SMITH, L.D. (1987): Agricultural Prices, Policy, and Equity in Sub-Saharan Africa, Boulder, Colorado.
- GROH, D. (1986): Strategien, Zeit und Ressourcen. Risikominimierung, Unterproduktivität und Mussepräferenz – die zentralen Kategorien von Subsistenzökonomien, *Schweizerische Gesellschaft für Wirtschafts- und Sozialgeschichte*, Vol. 5, No. 5, Jahreskongress 29. November 1985, Lausanne, pp. 1-37.
- HARDAKER, J.B., HUIRNE, R.B.M., ANDERSON, J.R. (1997): Coping with Risk in Agriculture, Wallingford and New York.
- HAZELL, P.B.R., NORTON, R.D. (1986): Mathematical Programming for Economic Analysis in Agriculture, Macmillan, New York.
- HEIDHUES, F., WEINSCHENCK, G. (1989): Rural Finance Profiles in African Countries – Cameroon, *The Credit Markets of Africa Series*, Vol. 2, Finafrica, Milan.
- HIRSCHMAN, A.O. (1958): The Strategy of Economic Development, Yale Univ. Press, New Haven.
- JOHNSTON, B.E. (1970): Agriculture and Structural Transformation in Developing Countries. A Survey of Research, *Journal of Economic Literature*, Vol. 3, No. 2, pp. 369-404.
- JOHNSTON, B.E., MELLOR, J.W. (1961): The Role of Agriculture in Economic Development, *American Economic Review*, Vol. 51, No. 4, pp. 566-593.
- JUNG, K.-H. (1987): Sparverhalten von Landwirten in Kamerun, *Entwicklung und ländlicher Raum*, Vol. 27, No. 3, pp. 85-97.
- LELE, U. (1982): Agrarpreispolitik, in: VON BLANCKENBURG, P. (ed.): Handbuch der Landwirtschaft und Ernährung in den Entwicklungsländern, Ulmer, Stuttgart, pp. 243-260.
- LEWIS, W.A. (1954): Economic Development with Unlimited Supplies of Labor, *Manchester School of Economic and Social Studies*, Vol. 22, No. 2, Blackwell, Oxford, pp. 139-191.
- LITTLE, I.M.D. (1982): Economic Development: Theory, Policy, and International Relations, Basic Books, New York.
- MAXWELL, S., FERNANDO, A. (1989): Cash Crops in Developing Countries: The Issues, the Facts, the Policies, *World Development*, Vol. 17, No. 11, pp. 1677-1708.
- MELLOR, J.W., MUDAHAR, M.S. (1992): Agriculture in Economic Development: Theories, Findings, and Challenges in an Asian Context, A Survey of Agricultural Economics Literature, Vol. 4, Agriculture in Economic Development, University of Minnesota Press.
- MESMER, B. (1986): Risikominimierung, Unterproduktivität und Mussepräferenz: Einige Bemerkungen zu den Thesen Dieter Grohs, in: SCHWEIZERISCHE GESELLSCHAFT FÜR WIRTSCHAFTS- UND SOZIALGESCHICHTE (ed.): Strategien von Subsistenzökonomien, Jahreskongress 29. November 1985, Lausanne, pp. 43-48.

- MIES, M. (1995): Zur Geschichte des Subsistenzansatzes (On the History of the Subsistence Approach), in: EVANGELISCHE AKADEMIE BAD BOLL (ed.): Subsistenz-Ökonomie, Ein Neues – Altes – Konzept in der Entwicklungspolitik, Reader on a Seminar of the Same Title in Bad Boll, June 19 – 25, Bad Boll, Germany.
- MIRACLE, M.P. (1968): Subsistence Agriculture: Analytical Problems and Concepts, *American Journal of Agricultural Economics*, Vol. 50, No. 2, pp. 292-310.
- PLATTEAU, J.P. (1991): Traditional Systems of Social Security and Hunger Insurance: Past Achievements and Modern Challenges, in: AHMAD, E., DREZE, J., HILLS, J., SEN, A. (eds.): Social Security in Developing Countries, Oxford, pp. 112-170.
- PÜTZ, D. (1991): Agricultural Supply Response in the Gambia: A Sectoral, Household and Intra-Household Analysis, Rheinische Friedrich-Wilhelms-Universität, Bonn.
- QUISUMBING, A. (1993): Gender Differences in Agricultural Productivity: A Survey of Empirical Evidence, World Bank, Washington, D.C.
- ROGERS, E.M. (1970): Motivations, Values, and Attitudes of Subsistence Farmers: Toward a Subculture of Peasantry, in: WHARTON C.R. (ed.): Subsistence Agriculture and Economic Development, Cass, London, pp. 111-135.
- RUTHERFORD, S. (2000): The Poor and Their Money, Oxford Univ. Press, Oxford.
- RUTTAN, V.W. (1987): Cultural Endowments and Economic Development: What Can We Learn from Anthropology?, *Economic Development and Cultural Change*, Vol. 36, No. 3, pp. 247-271.
- SCHULTZ, T.W. (1964): Transforming Traditional Agriculture, Yale Univ. Press, New Haven.
- SCOTT, J.C. (1976): The Moral Economy of Peasants, Yale Univ. Press, New Haven/London.
- SEAVOY, R.E. (2000): Subsistence and Economic Development, Westport, Connecticut, London.
- SHARIF, M. (1986): The Concept and Measurement of Subsistence: A Survey of the Literature, *World Development*, Vol. 14, No. 5, pp. 555-577.
- STAATZ, J.M., EICHER, C.K. (1998): Agricultural Development Ideas in Historical Perspective, in: EICHER, C.K., STAATZ, J.M. (eds.): International Agricultural Development, Baltimore, pp. 8-38.
- THORNER, D., KERBLAY, B., SMITH, R.E.F. (1966): A.V. Chayanov on the Theory of Peasant Economy, Homewood/Illinois.
- TVERSKY, A., KAHNEMANN, D. (1982): Judgement Under Uncertainty: Heuristics and Biases, in: TVERSKY, A., KAHNEMANN, D., SLOVIC, P. (eds.): Judgement Under Uncertainty, New York.
- UDRY, C., HODDINOTT, J., ALDERMAN, H., HADDAD, L. (1995): Gender Differentials in Farm Productivity: Implications for Household Efficiency and Agricultural Policy, *Food Policy*, Vol. 20, No. 5, pp. 407-424.
- UPTON, M. (1987): African Farm Management, Cambridge Univ. Press, Cambridge.
- VON NEUMANN, J., MORGENSTERN, O. (1944): Theory of Games and Economic Behaviour, Princeton University Press, Princeton.
- WHARTON, C.R. (1970): Subsistence Agriculture: Concepts and Scope, in: WHARTON, C.R. (ed.): Subsistence Agriculture and Economic Development, London, pp. 12-20.

ZELLER, M., SCHRIEDER, G., VON BRAUN, J., HEIDHUES, F. (1997): Rural Finance for Food Security for the Poor: Implications for Research and Policy, *Food Policy Review, Vol. 4*, IFPRI, Washington, D.C.

INSTITUTIONS AND TECHNOLOGIES FOR SUBSISTENCE AGRICULTURE: HOW TO INCREASE COMMERCIALIZATION

ZVI LERMAN

1 INTRODUCTION

THE ONLINE EDITION OF ENCYCLOPEDIA BRITANNICA defines subsistence farming as "a form of farming in which nearly all of the crops or livestock raised are used to maintain the farmer and his family, leaving little, if any, surplus for sale or trade... Subsistence farms usually consist of no more than a few acres, and farm technology tends to be primitive and of low yield."

This definition generalizes the long experience of agricultural economists in the under-developed countries of Africa, Asia, and Latin America. And yet it is closely echoed in what we see in the individual farming sector in transition countries. Box 1 portrays individual farms as a subsistence sector, and although written with Kyrgyzstan in mind, it reflects the prevailing view of individual farming in all transition countries.

Box 1: Subsistence Agriculture in Kyrgyzstan

Most village families practice subsistence agriculture and are allocated small parcels of land to produce food for their families. These plots are often barely sufficient to feed each family, and the purchase of seed and fertilizer is often too expensive. Even if a surplus can be produced, it is difficult to transport it to markets. The lack of machinery means that the labour is mainly carried out by family members. Most villages lack basic facilities to process wool, preserve fruit, and add value to their crops.

Source: KYRGYZSTAN COMMUNITY BUSINESS FORUM.

The above profile suggests that subsistence farms are small, use mainly family labor, lack machinery, face difficulties in purchasing inputs and marketing their products (assuming that they generate a marketable surplus), and do not add value to primary commodities. For our purposes, the overriding characteristic of

subsistence farms is that they produce food for the family and have no commercial orientation. This is the vicious circle that we need to break: how can individual farmers in transition countries start producing a sizable surplus that can be sold for cash or traded for manufactured goods?

2 IS THERE SUBSISTENCE AGRICULTURE IN TRANSITION COUNTRIES?

Survey results indicate that on the whole, individual farms in transition countries are far from pure subsistence operations. The majority of farms categorized as individual – household plots and independent peasant farms – sell at least some of their output. The proportion of output sold by these farms is quite significant, averaging between one-third and one-half of total production (Table 1). In a sense, this is a continuation of trends established during the Soviet period, when farm products from household plots were always sold in local town markets. No data are available for a rigorous comparison of individual farm sales before and after 1990, yet intuition suggests that the level of commercialization of individual farms has increased. In the pre-transition era, common wisdom said that "one-third of household plots sell one-third of their production," while Table 1 suggests that today the formula is "two-thirds of household plots sell one-half of their production." A higher proportion of individual farms sell a larger proportion of their output.

Table 1: Level of Commercialization in the Individual Sector

	Percent of "Sellers"	Percent of Output Sold by "Sellers"
Armenia	80	40
Georgia	64	40
Moldova – Small Private Farms	83	48
– Household Plots	60	31
Ukraine – Household Plots	60	50
Belarus – Household Plots	76	22
Poland	72	52

Source: WORLD BANK SURVEYS (1998-2000).

Some would disagree with the interpretation of Table 1 as being a picture of commercial orientation of individual farms in transition countries. These critics would claim that 30%-40% of "non-seller" farms is a very high proportion and actually proves a subsistence orientation. They would further argue that only 50% of farm output is sold, so families largely consume the food produced on their farms, instead of purchasing food in the marketplace. So is the glass half full or half empty? Individual farms in transition countries are certainly far from the level of commercial operation as we understand it in market economies. But having said that, we must acknowledge that their commercial activities are not negligible and that on the whole, the picture that emerges from Table 1 is definitely different from that described in Box 1 or in the *ENCYCLOPEDIA BRITANNICA* definition of subsistence agriculture.

Figure 1: Commercialization of Household Plots and Small Individual Farms in Moldova

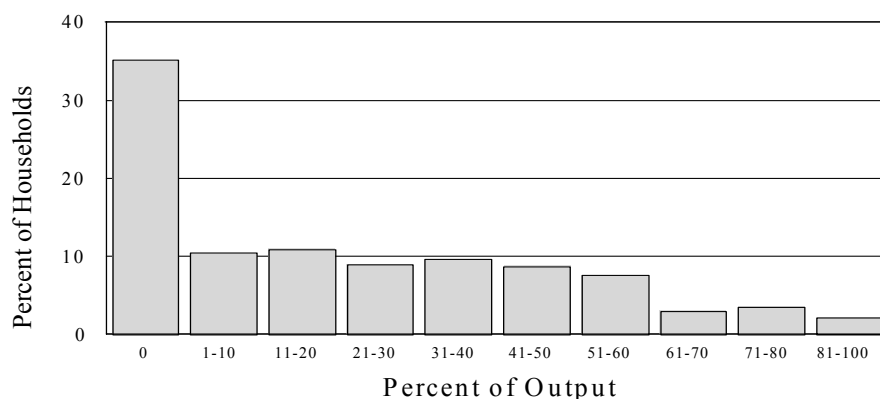

Source: LERMAN (2001).

Individual farms in transition economies span the whole organizational spectrum, from pure subsistence operations which sell no farm products to fully commercial operations that sell more than 80% of their output. Figure 1 shows the distribution of farms in Moldova by the percentage of output sold. The figure represents the level of commercialization of small individual farms that are typically regarded as subsistence operations: these are the household plots and the small- or medium-sized registered peasant farms with up to 100 hectares (data is from a WORLD BANK SURVEY conducted in the autumn of 2000; for details see LERMAN (2001)). Consistent with the data in Table 1, only one-third of the farms do not report any sales. Most of the remaining farms show a fairly uniform distribution of commercialization level, ranging from 10% to 60% of output sold, and a substantial percentage of farms report sales of more than 60% of output.

The focus of our discussion is thus how to increase the readiness of individual farms to sell and increase the percentage of output sold among the "sellers". Figure 2 is a standard input-output diagram adapted to farming. We will examine what needs to be done with the main input streams – land, purchased inputs, machinery, credit, know-how – if the objective is to increase the share of output that goes through the commercial sales channel.

Figure 2: A Schematic Input-Output Diagram for Farms

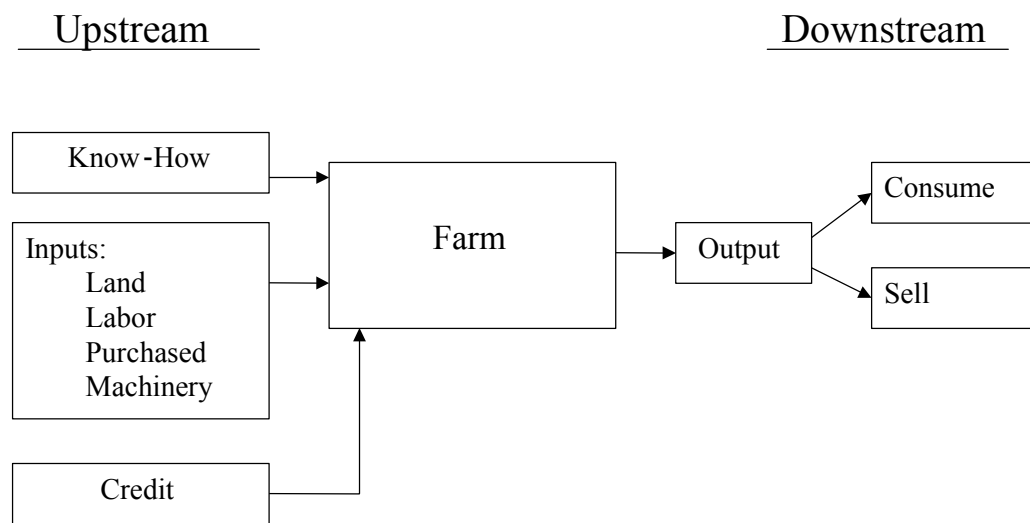

Source: Own depiction.

3 MORE LAND MEANS HIGHER COMMERCIALIZATION

We have used farm survey data from a number of Commonwealth of Independent States (CIS) countries to analyze the determinants of the decision to sell among individual farmers. MATHIJS and NOEV (2002) carried out a similar analysis of individual farms in four Central and Eastern European countries (CEECs). Table 2 is one of the outputs of this type of analysis, and presents the comparative profiles of "seller" and "non-seller" farms in Armenia, where large corporate farms do not exist and agriculture is entirely comprised of smallholders. The Armenian smallholders are conventionally regarded as subsistence farmers, although we have seen in Table 1 that fully 80% engage in commercial sales.

The sellers are characterized by larger land holdings, a larger amount of fertile irrigated land, and more animals. Sellers also command a larger pool of potential family labor, and a significantly higher percentage of the heads of household work full time on the family farm. Finally, sellers allocate much larger amounts of money to payment for mechanical field services (both in absolute terms and per hectare). Interestingly, some variables that a priori would appear relevant to the decision to sell are not significantly different between the two categories of households. For example, the average distances to the main delivery location or point of sale and the average road conditions are virtually identical for sellers and non-sellers. Moreover, the product mix is practically the same and the educational endowment is not different. The picture emerging from the profiles of Table 2 is confirmed by logistic regression: the probability that a household is a "seller" increases with the amount of land endowment, the number of animals, the number of family members, and the number of farm workers per hectare.

Table 2: Armenia: Comparative Characteristics of Sellers and Non-sellers

	Sellers (1,104)	Non-sellers (264)
Land, ha	2.3	1.4
Irrigated Land, ha	0.44	0.24
Animals, standard head	2.2	1.0
Family Size	5	4
Number of Farm Workers	4	3
Full Time Occupation on Farm, in percent	63	45
Annual Cost of Mechanical Field Services, dram/ha	19,500	8,900
Per cent Crops in Product Mix	60	59
Household Heads with Higher Education, in percent	13	12
Household Heads with Secondary Education, in percent	59	62

Source: LERMAN and MIRZAKHANIAN (2001).

The specific profile components and regression results vary from country to country, not only because of local differences, but also because of differing availability of particular variables. Thus, no data on farm machinery were available in Armenia, whereas in Moldova this proved to be one of the significant factors in the decision to sell. While geographical location had no impact in Armenia, it was found to be a highly significant factor in Moldova, where commercialization declined rapidly with the distance from the capital. The product mix was the same for "sellers" and "non-sellers" in Armenia, whereas in Moldova we witnessed a distinct adjustment of the cropping pattern in "seller" farms (more sunflower, grapes, and vegetables as the main cash crops). Yet farm size as measured by land emerges clearly and consistently in all countries as the major determinant of the decision to engage in the sale of farm products. Seller farms are larger and use greater inputs of productive resources. They accordingly produce more output and have a greater saleable surplus after satisfying the family's consumption needs. Small farms produce just enough to satisfy family consumption: to have saleable surplus output, the farm must be larger than some minimum size.

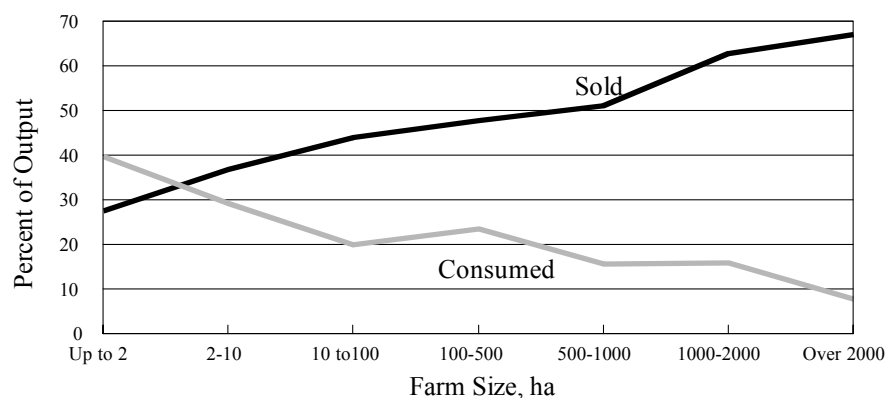
Figure 3: Share of Output Sold and Consumed, by Farm Size in Moldova

Source: LERMAN (2001).

Figure 3 demonstrates the relationship between the level of commercialization and farm size for a sample of individual farms in Moldova that participated in a WORLD BANK SURVEY in the autumn of 2000 (LERMAN 2001). The sample included household plots and a wide range of registered peasant farms, spanning a wide range of sizes, from a few tenths of a hectare to more than 500 hectares in exceptional cases. The level of commercialization consistently increased with the increase of farm size: the proportion of output sold rose from less than 15% for the smallest farms up to 1 hectare, to 45%-50% for farms of more than 100 hectares. The percentage of output consumed by the farmer's family correspondingly declined from nearly 60% for the smallest farms to about 20% for the largest entities (the two proportions do not add up to 100% because some of the output is used as intermediate inputs on the farm and some is stored for future consumption and sales).

The very fact that sellers engage in additional income-generating commercial activities leads to a striking difference in level and composition of family income. Sellers enjoy much higher total incomes, and the difference is basically attributable to cash earned from sales of farm products. In Moldova, net farm sales (revenues less costs) contribute 290 USD to "seller" families, and their average income is 1,240 USD per year, compared with 980 USD for "non-seller" farms (LERMAN 2001). In Poland, farms larger than 50 hectares selling a high proportion of their output generate family incomes of about 100,000 zloty per year, compared with 20,000 zloty for farms of up to 10 hectares that sell a much smaller proportion of their output (CSAKI and LERMAN 2002). As a result, the importance of the farm for family welfare increases markedly with the increase in the level of commercialization observed in larger farms. This effect is illustrated in Figure 4 (Moldova) and Figure 5 (Poland), which show how the share of income from farm sales in total family income increases in larger farms, which are characterized by higher commercialization.

Figure 4: Structure of Family Income by Farm Size in Moldova

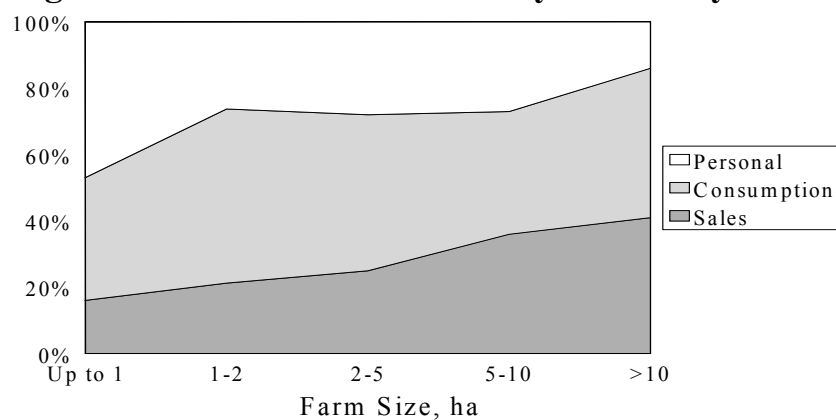

Source: LERMAN (2001).

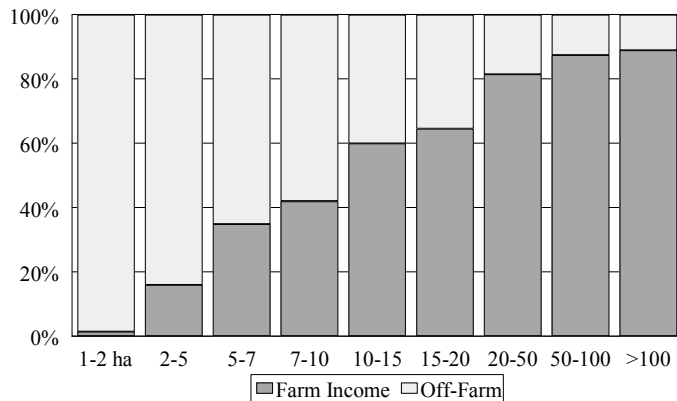
Figure 5: Structure of Family Income by Farm Size in Poland

Source: CSAKI and LERMAN (2002).

Individual farmers apparently recognize the advantages of operating a larger farm. WORLD BANK SURVEYS in transition countries reveal a clear pattern of willingness to increase farm size. In Armenia, 20% of individual farmers expressed the desire to double their land holdings from 2 hectares to 4 hectares. In Moldova, 58% of rural households would similarly like to double their plots to somewhere between 1-6 hectares, and another 13% would like to operate more than 6 hectares (an increase of 5 to 10 times the current size). In Poland, 11% of farms actually increased their holdings by nearly 40% on average between 1997 and 1999 (from 19 hectares to 27 hectares).

4 LAND MARKET INSTITUTIONS NEEDED FOR FARM ENLARGEMENT

We have shown that, among individual farmers, farm size has a strong positive impact on the degree of commercialization and on family incomes. Everywhere in the world, farm sizes are increased through land market transactions, which include buying and selling and, no less importantly, leasing of land. The land markets enable land to flow from passive to active owners, (e.g., from pensioners to farmers) or from less efficient to more efficient producers, thus increasing the overall productivity of this resource and improving farm efficiency.

Relatively little empirical information is available on the development of land markets in transition economies. The legal framework for land transactions is generally in place, but in many countries the buying and selling of land is restricted by various legal provisions which are not conducive to the emergence of vigorous markets for land sales. PROSTERMAN and HANSTAD (1999) provide a detailed review of these restrictions in some transition countries. Although there is definite evidence of the buying and selling of land in all transition countries, including the CIS, the overall impression is that agricultural land markets are very thin, with relatively small and infrequent transactions. According to very rough (and probably highly subjective) estimates prepared for the European Union (DALE and BALDWIN 1999), the frequency of land transactions is around

2.5% in Hungary and around 1% in the Czech and Slovak Republics, Latvia, Poland, and Slovenia (this percentage is the ratio of titles transferred to the total number of titles in cadastral registries). These estimates of transaction frequencies are substantially lower than the EU average transfer rate of 7%. A recent survey by SCHULZE and TILLACK (1998) estimates that farmers' buy-and-sell transactions in 1995-1996 entailed about 1.7% of farm land in Poland, 0.15% in the Czech Republic, and 0.25% in Slovakia. Although a 1998 Phare ACE survey in Hungary found that a substantial proportion of land in individual farms was actually acquired through purchase transactions¹, only 5% of Polish farmers in a 2000 WORLD BANK SURVEY report buying or selling land in the last five years (CSAKI and LERMAN 2002). CIS farmers interviewed in numerous WORLD BANK SURVEYS have thus far failed to provide any positive indication of buy-and-sell transactions in land. Even in Armenia, where buying and selling land has been completely legal since 1992, two large surveys covering 6,000 farms in 1996 and 1998 did not detect any significant transfers of land ownership through market mechanisms.

But land market transactions are not limited to the buying and selling of land. Land leasing and other forms of transferable use rights are important components of land markets throughout the world, and they acquire particular prominence in transition economies in view of administrative and political restrictions on buy-and-sell transactions. Thus, in Russia, land leasing appears to be much more common than buying and selling: according to Goskomstat national surveys, 33% of peasant farmers report the existence of land leasing transactions, while only 6% have knowledge of buy-and-sell transactions of land.

In developed market economies, many farmers are "operators" and not "landowners": they cultivate land that they do not own. Thus, farmers in Belgium, France, and Germany rent more than 60% of the land they cultivate, while the overall "tenancy rate" in the 15 countries of the European Union is 40% (LERMAN et al. 2002). In Canada, 30% of farmed land is not owned by the farmers, and in the USA, only one-third of farmed land is fully owner operated: another 55% is a mixture of own land with land leased from others and 10% is cultivated by farmers who do not own any land. In both Europe and North America, land leasing is definitely conducive to larger farms. In Europe, the average farm size is almost 40 hectares in countries where farms operate with more than 30% of leased land, compared with 18 hectares in countries where farms have less than 30% of leased land; in Canada farms with leased land are 40% larger than farms operating with owned land (224 ha and 164 ha, respectively); and in the USA, farms operating with a mixture of owned and

¹ MATHIJS, E. (without year): Private Communication.

leased land are more than three times as large as farms that use owned land only (358 ha and 112 ha, respectively).

Leasing also emerges as a mechanism for the augmentation of individual farms in transition countries (Table 3). Although the percentage of individual farms that lease land is relatively small, farms reporting some leased land are significantly larger than farms that rely entirely on owned land. This is consistent with the experience of market economies described above.

Table 3: Leasing of Land by Individual Farmers in Transition Countries

	Percent of Farms	Total Size, ha	Leased Land, ha	Farms Without Leased Land, ha
Armenia	14	2.6	1.0	1.3
Georgia	2	8.7	7.8	0.7
Moldova 1996	6	16.9	13.5	2.8
2000	51	196	191	3.7
Romania	7	4.1	1.7	3.0
Bulgaria	9	4.8	3.3	1.1
Hungary	8	19.6	8.8	3.4
Poland	17	25.7	11.9	7.3

Sources: WORLD BANK SURVEYS for Armenia, Georgia, Moldova, Romania, and Poland; Phare ACE surveys conducted by the Catholic University of Leuven for Bulgaria and Hungary (LERMAN et al. 2002).

The state should desist from restricting the development of land transactions, be it buying and selling or leasing. The role of the state is to create an institutional and technical framework that supports land markets. The impact of a conducive framework is clearly shown in the case of Moldova in Table 3: the changes in the legal and political environment between two WORLD BANK SURVEYS (1996 and 2000) increased the frequency of land leasing among individual farmers from 6% to 50%. The rule of law, or more specifically, the availability of contract enforcement mechanisms, is probably the most important component of the framework required for the development of land markets in general and land leasing in particular. Individuals will be understandably reluctant to lease out their land unless there are strong guarantees that they will retain their ownership rights even though they do not cultivate the land personally. Leaseholders, on the other hand, will not necessarily take the best care of the leased land if they may lose it at any time through arbitrary administrative actions. In addition to contract enforcement, the state should provide adequate registration and titling arrangements to ensure the existence of proper ownership and transfer records, including records of lease agreements and mortgages where necessary. These records are necessary to support any contract-enforcement mechanism. Last but not least, the state should ensure maximum simplicity and transparency of all procedures related to land transactions: excessive red tape and rigid bureaucratic attitudes, so deeply embedded in the socialist heritage, should be eliminated.

5 MARKET SERVICES FOR COMMERCIAL OPERATION

However important it may be, land is only one component of the operating environment that encourages commercialization. Given land, farmers should be able to produce, which requires channels for the delivery of knowledge, inputs, and machinery to the farms (see Figure 2). Once the harvest is in, farmers should be able to sell it, which requires access to marketing channels.

In the past, the traditional individual sector – household plots – was generously supported by the local collective or cooperative enterprise, which actually provided all upstream and downstream services. In this way, the large farm enterprise substituted for the missing market channels and enabled the "one-third" commercialization level of the household plots. The traditional role of the collective farm in relation to the household plots is illustrated in Table 4, which is based on the latest farm survey for Belarus. Belarus has remained frozen in time among the transition countries, and still provides a faithful picture of the pre-1990 situation with regard to household plots in the socialist world.

Table 4: Traditional Role of Collective Farm vis-à-vis Household Plots

	Percent of Farm Enterprises
Help with Fieldwork on Household Plot	91
Plowing, Tillage	67
Inputs	
Fertilizers, Pesticides, Herbicides	15-20
Seeds, Feed, Young Animals, Veterinary Services	60-70
Marketing	56
Extension: Access to Specialists	n.a.

Source: WORLD BANK SURVEY in Belarus, 1999 (CSAKI et al. 2000).

Although some of the deep symbiosis between household plots and local farm enterprises still persists (SCHREINEMACHERS 2001), the individual sector today largely has to fend for itself in the new market environment, however imperfect. WORLD BANK SURVEYS in CIS provide consistent evidence that the individual sector – both household plots and peasant farms – is shifting its business from farm enterprises and state-affiliated channels to private traders, wholesalers, and retail markets. This observation is equally valid for both product sales and farm supply purchases.

The main difficulties that individual farmers experience in their attempts to sell farm products are documented in Table 5. Farmers universally complain of low prices received; they often complain of the difficulties of finding a buyer for their products; they experience serious problems with transporting their products to the market (except in Poland); and, in the two countries where asked, individual farmers indicate that their output is too small to sell. With regard to farm inputs, the universal complaint is that the prices are too high, although physical availability as such (i.e., finding a supplier) is not a problem.

Table 5: Marketing Difficulties Reported by Individual Farmers (Average Scores Over All Commodities)

	Armenia	Georgia	Moldova	Poland
Low Prices	42	36	75	51
No Buyer	34	20	30	14
Transport	38	48	25	3
Untimely Payments	15	8	17	15
Meeting Quality Standards	13	n.a.	12	8
Small Volume	n.a.	n.a.	30	16

Source: WORLD BANK SURVEYS (1998-2000).

All these are typical problems of smallness (Box 2). They are not unique for transition countries: family farmers all over the world experience similar problems, although admittedly they are less acute in a functioning market environment. In addition to difficulties with sales and inputs due to lack of bargaining power (prices) or restricted physical access to markets (finding a buyer, transport), the problems of smallness are also reflected in the shortage of machinery (which is too expensive to buy for a small farmer) and restricted access to credit (lack of collateral, high transaction costs for small loans).

Box 2: Smallness is a Universal Problem, Not Only in Transition

- Buying inputs – higher prices for small quantities; small quantities not always available at any price; shipping small quantities complicated; no bargaining power to negotiate better terms.
- Selling to processors – hard to sell in small quantities; difficult to meet quality standards; no bargaining power to negotiate better terms.
- Physical access to markets – transport to markets sometimes impossible, difficult meeting entry threshold (either formal or informal).
- Buying machinery – too expensive for a small producer; cost-ineffective for a small farm.
- Negotiating credit – lack of collateral, high transaction costs on small loans, high interest rates.

5.1 Service Cooperatives and Machinery Pools

The standard solution for the problems of smallness in market economies is to establish a farmers' service cooperative. Both theory and world experience suggest that service cooperatives are established to correct for market failure, i.e., when private entrepreneurs are reluctant to enter into a particular area for various reasons (spatial dispersion, remoteness, narrow product requirements) and as a result, farmers are faced with missing services (COBIA 1989). Service cooperatives cure the problems of smallness by endowing small individual farmers with the benefits of collective operational size; they assure access to supplies and markets for their members; and achieve market power through size.

Cooperative machinery pools relieve the individual farmer from the pressure of purchasing their own equipment. Service cooperatives also achieve overall risk reduction through portfolio diversification effects (ZUSMAN 1988). This improves their credit standing vis-à-vis the banks, thereby enabling them to negotiate access to loans and lower interest rates for their members.

These advantages of joint action through cooperation in services (as opposed to cooperation in production) are borne out by long-term experience all over the world. In market economies, cooperatives are not the only institutional tool that farmers use. Many functions and services are handled competitively by private entrepreneurs, obviating the need for service cooperatives. In transition economies where the market environment is still underdeveloped and not fully functional, the benefits of cooperation appear to be self-evident. There is, however, a strong psychological resistance to cooperation bred from years of abuse of the whole concept by socialist regimes:

The use of the word "co-operative" in Central and Eastern Europe will not only create the wrong impression, it will also create barriers to progress. The old style of co-operative or collective has no relevance in the new free-market approach (PLUNKETT FOUNDATION 1995).

Despite this resistance, we are witnessing the emergence of new forms of cooperation among individual farmers in transition countries (Table 6). This is voluntary cooperation, often informal and sporadic, that stands in a stark contrast to the all-pervasive mandatory cooperation of the socialist era. Cooperation is quite strong in many areas, with the notable exception of processing and credit. Consistent with theoretical considerations, the level of cooperation is lower in Poland, where the market environment is substantially more developed than in the other countries (compare the difficulties with transport in Poland versus the other countries in Table 5).

Table 6: Cooperation Among Private Farmers

	Russia	Ukraine	Belarus	Armenia	Moldova	Poland
Some Forms of Cooperation, in percent	74	82	60	44	30	20
Consulting	58	64	33	9	10	8
Marketing	33	24	13	10	11	8
Input Supply	30	20	7	1	7	5
Machinery	43	45	37	19	19	7
Production Services	27	34	17	10	11	6
Processing	8	6	0	1	7	2
Credit	37	16	10	0	2	2

Source: WORLD BANK SURVEYS (1994-2000).

Machinery is understandably one of the major areas of cooperation among individual farmers in transition countries. Through cooperation, the actual access of individual farmers to machinery and machinery services is much higher than that suggested by machinery ownership rates. Thus, in Armenia only 14% of farmers own farm machinery (either individually or jointly with their

relatives and neighbours). Machinery pools and service cooperatives, however, ensure that fully 80% of individual farmers in this country have access to machinery or mechanical field services (LERMAN and MIRZAKHANIAN 2001). In Moldova, less than 30% of peasant farmers participating in the 2000 WORLD BANK SURVEY (LERMAN 2001) have their own machinery; another 40% have access to machinery through joint ownership (a kind of low-level cooperation) or rental; finally, over 30% buy mechanical field services (Figure 6). It is not clear how much of the machinery rentals and custom machinery services originate from cooperatives and how much from private rental companies (we have seen in Table 6 that about 20% of farmers have cooperation in machinery). Either channel provides an adequate solution to the problems of smallness and fixity, which prevent widespread ownership of farm machinery by individual farmers. If private entrepreneurs provide competitive machinery rentals and services, so much the better. If such services are not available from private companies, cooperatives can be established to fill the gap.

Figure 6: Sources of Machinery for Individual Farmers in Moldova

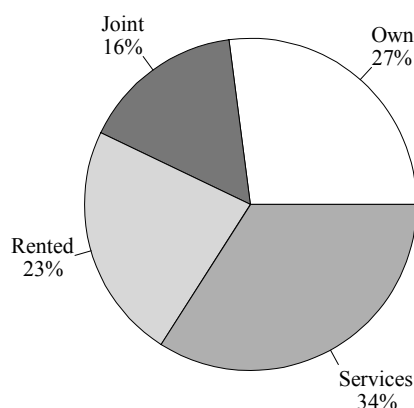

Source: LERMAN (2001).

5.2 Access to Credit

In principle, farms, like all business entities, need access to two types of credit: long-term credit to finance investments in fixed assets and short-term credit to finance working capital requirements (i.e., to bridge the temporary gap between production costs and sales receipts). Conventional wisdom is that individual farmers in transition countries suffer from a severe shortage of credit, which is an obstacle to normal and efficient operation. To what extent this is true, and whether the borrowing of farmers in transition countries is different from the borrowing of comparable farmers in market economies cannot be empirically determined. To put the problem of credit into perspective, the writer can only cite one piece of evidence from personal experience. When a few years back the writer spoke to a commercial crop farmer in Texas, USA, about his borrowing and his relations with the banks, the answer was, "I finance everything out of cash". However anecdotal, this evidence is consistent with the worldwide view

of small farmers being highly conservative and risk-averse individuals who do not wish to borrow. If this is the case in market economies, should we continue to emphasize the deficiencies of farm credit in transition countries?

In any event, the incidence of borrowing among individual farmers varies widely from country to country (Table 7). What is common to all countries is that borrowing is mainly short-term and predominantly informal (from friends and relatives). Naive estimates of farmers' demand for credit based on simple survey questions about how much they would like to borrow reveal a very healthy appetite for future borrowing. The expressed demand for credit is four to five times the present level of borrowing and, most surprisingly, two to three times the present level of sales (Table 7). The latter ratio suggests that the credit demand estimates may be exaggerated. Another point to bear in mind is that farmers primarily signal a need for investment credit – there is no indication that they would like to borrow for current production expenses, i.e., for working capital.

Table 7: Do You Need Credit for Next Year?

	Moldova	Georgia	Armenia
Yes, in percent	60	50	53
Amount, USD	1,300	3,000	1,000
Sales, USD	450	1,250	400
Desired Term, years	1-5	1-2	1-2
Desired Rate, in percent	8	12-24	1-6
Today's Borrowing			
Frequency, in percent	20	1	50
Amount, USD	250	800	200
Term	short	3 months	6-24 months
Annual Rate, in percent	30	n.a.	2-10
Credit from Relatives, Friends, in percent	96	100	94

Source: WORLD BANK SURVEYS (1996-1998).

Investment financing is a problem for farmers all over the world. But experience in market economies shows that farmers do not rush to the banks to finance every investment instantly with debt. Farmers wait until they have accumulated enough savings to buy or build, as needed. When credit is easily available through (generally subsidized) government sources, farmers, like everybody else, fall into the moral hazard trap of soft-budget constraints: they over-borrow, over-invest, and end up in serious trouble. There are plenty of examples of this all over the world, and the 1986 farm debt crisis in Israel is just one of them (KISLEV et al. 1991). To facilitate investment, farmers should be encouraged to be profitable and save "out of cash."

If farmers are profitable and are willing to save money, working capital financing should not be a serious problem either. In any event, the maximum that is needed is a short-term loan to cover one year's production costs, repayable in full from the next season's sales receipts. In market economies, such loans are very often handled through channels that do not involve bank

borrowing. First, there is the natural suppliers' credit that all farms use. Second, short-term financing can be raised through a variety of product-credit interlinkage arrangements: the farm pledges its future harvest against a bridging loan for working capital. Interlinkage arrangements are universally practiced by service cooperatives, which supply inputs and extend credit to their members in return for the promise of future delivery of members' harvest.

A more sophisticated non-cooperative interlinkage scheme involves contract production, whereby a farmer undertakes to produce and deliver a certain crop to a marketer or a processor in return for a working-capital loan or inputs supplied in kind. There is evidence of such contractual arrangements in Romania, Poland, Moldova, Ukraine, and Russia, where the buyer-financier is usually a large foreign corporation with a special interest in gaining a market share for its products (farm inputs) or securing a source of farm commodities for its marketing or processing operations (grain, grapes, vegetables).

A very popular solution for rural credit problems advocated by international donors involves the establishment of credit unions. These are small specialized credit cooperatives that rely on mutual guarantee and strong peer pressure for successful operation. Their operation is not interlinked with input supply or product marketing: their charter is to lend money to their members for business needs (including farming). There are large numbers of such credit unions in Armenia, Georgia, Moldova, and the Baltics, and efforts are underway to extend the network to Ukraine and Russia. The problem is that, by their nature, they are designed to make very small loans: somewhere between 50 USD and 100 USD. This is nowhere near what farmers perceive as their credit needs in Table 7, even if we discount their wishes by half. Credit unions may be an excellent solution for the development of small cottage industries or, indeed, for the support of subsistence farming. But they are too small for the purpose of moving from subsistence to commercialization.

5.3 Extension and Education

In the discussion of the profile of "commercial" farmers in Armenia (Table 2), we have noted that the farmer's formal education does not have a significant effect on the decision to sell. A similar result is observed in other countries (Moldova, Ukraine). This curious result is probably attributable to the generally low variability in the educational attainment of farmers who grew up during the Soviet period, with its universal and free access to schooling. Education and human capital in general are extremely important for the successful operation of a farm, especially when our thesis is that individual farms should be encouraged to grow in the interest of commercialization. After all, farms in market economies grow until the owner reaches the limit of his or her managerial capacity, which is clearly determined by a combination of personal intelligence, experience, and education.

Table 8: Areas Where Small Farmers Need Technical Advice, in percent

	Get Today	Want More
Business Planning, Farm Management	48	31
Agronomy and Livestock	49	62
Processing Technologies	13	7

Source: WORLD BANK SURVEY in Moldova, 2000 (LERMAN 2001).

Farmers express a clear need for instruction and advice related to the preparation of business plans and farm management practices (Table 8). There is clearly nothing in their background that prepares them for these specific tasks that are essential in a market-oriented environment. Yet somewhat surprisingly, farmers also express a very strong need for technical extension services related to straightforward crop and livestock production. They seek advice concerning seed selection, fertilizer and pesticide application, crop rotation, and animal health. This clearly emerges from Table 8, which although based on a farm survey in Moldova is indicative of the needs of farmers in CIS and probably in other transition countries as well.

In the past, household plots received all their technical advice and extension services from the large team of agro-specialists in the local farm enterprise. This mechanism does not function any more, and field visits in transition countries indicate that the delivery of extension to the farm level has indeed suffered considerably. Partial solutions include the establishment of private advisory services by former collective-farm specialists. A more comprehensive solution to instruction, technical advice, and extension services could be found in local cooperative frameworks. After all, member education is one of the traditional subsidiary tasks of farm cooperatives in all market economies. Yet we cannot ignore the fact that education and information are public goods, and governments certainly should play an active role in the rehabilitation and reanimation of the agricultural extension systems in transition countries.

As with credit, however, the need for extension and education has to be put into proper perspective. Small farmers in transition countries are not illiterate peasants; they are educated people who spent all their lives working on large farms. Even if their formal job was a tractor driver or a milking-machine operator, they gained valuable multi-faceted experience from many years of work on the household plot. They essentially know how to farm even under the new conditions, without the strong traditional backing of the old farm enterprise. Extension can help to improve their performance and raise their profitability. In this way, extension should be conducive to greater commercialization. Yet small farmers in transition countries will continue to operate and develop even if extension systems are not fully in place for some time to come.

6 CONCLUSION

The concluding section prioritizes the various tasks that have been discussed in this paper. The absolute top priority is allowing farms to increase their size. Larger farms will produce more surplus, and this surplus will find its way to the markets. Farm enlargement requires an environment conducive to land markets and land transactions. This means the elimination of all restrictions on transferability of land, moral and legal support for contract enforcement, and finally land registration and titling systems.

As a second priority, it is necessary to pay attention to the development of functioning market services, including input supply channels, product marketing, and processing. These tasks can be effectively handled through the establishment of service cooperatives until private entrepreneurs dare to step into the breach.

As a third priority, we need to look at the question of farm finances in general, and rural credit in particular. Emphasis on profitability and savings provides a natural solution to financing the needs of small farms. Various interlinkage arrangements and contract production can provide an additional source of working capital for farms. The natural role of service cooperatives as interlinkage agents should not be forgotten. Programs for the full-scale revamping and development of functioning rural credit systems take a very long time and should be allowed to proceed in the background while other less comprehensive but more pragmatic solutions are being implemented.

Finally, governments should start playing an active role in the provision of extension services. Cooperatives can provide a supportive shell for the delivery of these services with assistance and partial funding from the government. Modern agriculture cannot develop efficiently without science and research. Farmers cannot optimize their operations without information and professional education. Although less urgent than the other tasks enumerated above, extension and education are essential components for the future success of commercial agriculture in transition countries.

REFERENCES

- CSAKI, C., LERMAN, Z. (2002): Land and Farm Structure in Transition: The Case of Poland, *Eurasian Geography and Economics*, Vol. 43, No. 4, pp. 305-322.
- CSAKI, C., LERMAN, Z., SOTNIKOV, S. (2000): Farm Sector Restructuring in Belarus: Progress and Constraints, *World Bank Technical Paper 475*, World Bank, Washington, D.C.
- COBIA, D. (Ed.) (1989): *Cooperatives in Agriculture*, Prentice Hall, Englewood Cliffs, NJ.
- DALE, P., BALDWIN, R. (1999): The Development of Land Markets in Central and Eastern Europe, *ACE Project P2128R*, November.
- ENCYCLOPEDIA BRITANNICA (Online Edition): Subsistence Farming, [http://www.britannica.com/eb> \(search "subsistence farming"\)](http://www.britannica.com/eb> (search \).

- KISLEV, Y., LERMAN, Z., ZUSMAN, P. (1991): Recent Experience with Cooperative Farm Credit in Israel, *Economic Development and Cultural Change*, Vol. 39, No. 4, pp. 773-789.
- KYRGYZSTAN COMMUNITY BUSINESS FORUM (Web Site), Subsistence Agriculture, <http://www.kyrgyzstancbf.org/Community/Subsistence_Agriculture/subsistence_agriculture.html>.
- LERMAN, Z. (2001): Moldova: Baseline Farm Survey October-November 2000 (Part I. Survey of Farm Managers: Corporate Farms and Peasant Farmers; Part II. Survey of Rural Families with Household Plots), Electronic Version at <<http://departments.agri.huji.ac.il/economics/lerman-main.html>>.
- LERMAN, Z., CSAKI, C., FEDER, G. (2002): Land Policies and Evolving Farm Structures in Transition Countries, *Policy Research Working Paper 2794*, The World Bank, Washington, D.C., Electronic Version at <<http://econ.worldbank.org/>> (click on "Working Papers").
- LERMAN, Z., MIRZAKHANIAN, A. (2001): Private Agriculture in Armenia, Lexington Books, Lanham, MD.
- MATHIJS, E., NOEV, N. (2002): Commercialization and Subsistence in Transition Agriculture: Empirical Evidence from Albania, Bulgaria, Hungary and Romania, *World Bank Annual Conference on Development Economics*, World Bank, April, Washington, D.C.
- PLUNKETT FOUNDATION (1995): Review of 1994 Activities, Plunkett Foundation, Oxford.
- PROSTERMAN, R., HANSTAD, T. (1999): Legal Impediments to Effective Rural Land Relations in Eastern Europe and Central Asia: A Comparative Perspective, *World Bank Technical Paper 436*, World Bank, Washington, D.C.
- SCHREINEMACHERS, P. (2001): From Subsistence to Commerce in Russian Agriculture, *Conference on Subsistence Agriculture in Central and Eastern Europe*, IAMO, May, Halle (Saale).
- SCHULZE, E., TILLACK, P. (1998): Development of Land Markets in Some European Transition Countries, CCNM/EMEF/CA(98)11, Emerging Market Economy Forum, Forum on Agricultural Policies in Non-Member Countries, OECD, Paris.
- WORLD BANK SURVEYS (1994-2000).
- ZUSMAN, P. (1988): Individual Behavior and Social Choice in a Cooperative Settlement, Magnes Press, Jerusalem.

POLICY OPTIONS TO OVERCOME SUBSISTENCE AGRICULTURE IN THE CEECS

JOACHIM VON BRAUN, DANIELA LOHLEIN¹

1 WHY POLICIES FOR THE SUBSISTENCE AGRICULTURE SECTOR?

The transformation of the political and economic systems in Eastern Europe and the Former Soviet Union (FSU) was driven by the desire to combine political freedom with improved living conditions. Market-oriented reform is the essence of transformation for the former socialist planned economies. However, considerable segments of Eastern European and the FSU economies are not moving swiftly toward market integration; instead, barter exchange, home production and subsistence continue to play important roles, especially in low income economies, a decade after the transition process began. This paper addresses the issue of subsistence agriculture, argues that it should be an area of policy attention and discusses policies that may be considered to increase efficiency in this smallest-scale agricultural sector.

The sub-sector is marginal in terms of output and size per unit of holding and even total land allocation. In many Central and Eastern European Countries (CEEC), however, it is very significant in terms of aggregate output and allocation of labor resources. Subsistence agriculture is a characteristic feature of developing, low income countries. Perhaps this is why it is surprising that it is a feature of the rural sector in almost every Central and Eastern European country, many of which are middle- rather than Low-income Developing Countries (LDC).

When devising policy options it is tempting to simply replicate the same policy advice that is given to developing countries, but this would be too simplistic. Subsistence agriculture in CEEC differs from that of LDC, most importantly in the reasons for it. Moreover, even within the CEEC there are large differences in

¹ The authors would like to thank Sophia Davidova, Csaba Forgacs, Gertrud Schrieder and Ludwig Striewe for their kind assistance in the preparation of this paper.

the prevalence of subsistence agriculture, the factors promoting subsistence cultivation, and the constraints faced by those who wish to commercialize their production.

In the early phase of economic transformation, market inefficiencies and market failures adversely affected food availability in many regions of the transforming economies, and even when they did not occur, populations perceived such food risks to exist. The scale of that production can be assumed to be driven by:

- the usual household demand determinants (income, prices),
- household resources (labor, access to land, and capital) and,
- the real or perceived risk of food insecurity households are facing.

Estimating probabilities of scarcity has been difficult for households, owing to information deficiencies and a lack of experience with market systems. This may be one underlying cause of a significant part of the population continuing to produce some of their own food parallel to the market, which is not yet "trusted".

In addition to the short term shock events resulting from price liberalization, parts of Eastern Europe and the FSU experienced the well-known long and drawn-out economic transformation process. Average real incomes declined for many, inequality rose and the employment situation worsened. The traditional social security system has malfunctioned due to budget constraints, and the poor are often not reached by the system due to ineffective targeting criteria. For a broad segment of the Eastern European and FSU population, insurance against risks has become more and more a matter of individual and family action. Diversification of income sources through multiple job holding and own food and agriculture production and marketing has risen in importance.

However, home production should not be viewed just as a short-term transition phenomenon. It has a long tradition in parts of Eastern Europe and the FSU (TSCHAJANOV 1923), but in the past it had often been constrained for various ideological and strategic reasons. There is no reason to discuss subsistence agriculture from an ideological perspective today. It is an economic reality and a function of underlying economic conditions in markets and social systems. So why consider policies for overcoming subsistence agriculture? Because in comparison to a well-functioning market economy there is reason to suspect that subsistence production entails significant misallocations of resources, especially of human time. However, such a "well-functioning market economy" is not yet a reality in many parts of the food and agriculture sector. So, what strategies and policies should be followed under these circumstances? There are two alternatives:

1. A *Laissez-faire* approach: leave subsistence agriculture alone, let the market and economic transformation process take care of inefficiency problems,

2. An active engagement approach: take an active public policy position, addressing market failure problems and providing public goods that enhance efficiency.

We will take the second position. However, in so doing, we shall argue that it is not "overcoming", but rather it is increasing efficiency in the subsistence sub-sector which should be a policy goal. Increased efficiency may partly result in overcoming subsistence agriculture. Also, it will not and should not be understood to overcome small-scale agriculture. We will conclude that policies addressed to that sub-sector are needed, but larger economic policy issues beyond the sub-sector will have to be considered too, in order to broadly increase economic efficiency.

There are some 41 million subsistence farms in the CEEC and New Independent States (NIS) according to our rough estimates². This sub-sector deserves policy attention, because it is important from an economy-wide perspective for general market efficiency, for agricultural growth and stabilization, for insurance and for employment and leisure. All these factors differ a great deal among the CEEC. In recognition of this diversity, this paper will begin with a brief overview of the extent and structure of subsistence agriculture before discussing the various policy options available to rationalize and increase efficiency in small-scale subsistence agriculture.

2 LOW-INCOME COUNTRIES' EXPERIENCE

It is interesting to note that the policy and academic debate about the commercialization of subsistence farming took a very different route in developing countries than it currently does in most transition economies. Some of the related research and debate is still relevant for transition economies.

Today, about 440 million farmers in developing countries still practice subsistence production to a significant extent.³ In a global sense, due to unrealized gains from trade and specialization, this is a large enduring misallocation of human and natural resources, and, due to population pressure and natural resource constraints, it is becoming less and less viable.

The general reasoning is that subsistence production for home consumption is chosen by farmers because it is subjectively the best option, given all their constraints. For the low income countries it can be concluded that specialization and commercialization of farming households within a more diversified economy is part of the development process. But there are concerns that the process bypasses the poor.

² In this paper, the definition of a subsistence farm is a farm which has 1 ha or less of land.

³ Estimation from J. VON BRAUN, E. KENNEDY (eds.) (1994): *Agricultural Commercialization, Economic Development and Nutrition*, Johns Hopkins, Baltimore, p. 3. This section is very much based on sections of the above-mentioned book.

The debate in developing countries, especially in the 1980s, asked, as commercialization takes place how are higher average incomes distributed among various economic and social groups? And, does higher household income necessarily lead to improved consumption for all household members? It was argued in a large body of literature that the commercialization of agriculture has mainly negative effects on the welfare of the poor. Reviews of related research by VON BRAUN and KENNEDY (1994) found that many of the studies from which these generalizations were extrapolated were conceptually flawed. Furthermore, comparative studies often disregarded potentially confounding factors, and just compared nutrition with and without cash crops, or were based on very small potentially biased samples.⁴ Despite these shortcomings, this literature had considerable impact on development strategy thought. Nevertheless, some important research and policy issues remain. While specialization and the development of markets and trade that characterize commercialization are fundamental to economic growth, concerns and suspicions about adverse effects on the poor from the commercialization of subsistence agriculture persist and indeed influence policy. The principle advantages of market-oriented policies and the powerful forces of trade for development are unquestionable. However, the risks of policy and market failures, and household-level complexities are real, too, and need to be recognized as potential determinants of inefficiencies and inequities.

Even with well-functioning factor and product markets, it is easy to construct scenarios in which some poor producers in low income countries lose due to commercialization. Such scenarios include the "agricultural treadmill", late access to new commercialization and technical options, and a host of "bad policies". Increased market supply facing highly inelastic demand is one such scenario in which some producers lose. The resulting agricultural treadmill – increased supply leading to lower prices – is a reality with important regional and international dimensions. However, its potentially serious damage is often diluted by in-built compensating effects. In particular, the favorable effects for consumers – especially given that the majority of the poor are net purchasers of food – should be taken into account when weighing the disadvantages of the agricultural treadmill for small non-adopters. Assessing the effects of commercialization and technical change from the perspective of producers only is misleading. Once the consumption effects and other general equilibrium effects are included in the assessment, the treadmill effects are usually seen to be diffused (BINSWANGER and VON BRAUN 1991). Commercialization and specialization are usually introduced for commodities whose demand is elastic, often as a means of bypassing the problem of inelastic demand faced by traditional commodities. It is, therefore, difficult to construct scenarios in which

⁴ For example, LAPPÉ, F.M., COLLINS, J. (1977): *Food First: Beyond the Myth of Scarcity*, Houghton Mifflin Co, Boston.

commercialization by itself – unaided by failures of institutions, policies, or markets – has adverse consequences.

General lessons for the study of subsistence farming can certainly be shared at a methodological level. Modeling the commodity side of the transition process from subsistence- to market-orientation requires: (1) introducing the distinction of subsistence and market production at the level of resource use, including labor, (2) specifying the underlying causal determinants, such as risk aversion, preferences for tasks, and habits that may motivate a household to maintain a certain degree of self-sufficiency even at the cost of market income foregone, and (3) to assign a common non-monetary utility index to non-marketable household goods and services as well as market goods.

As principle driving forces of commercialization, macro and trade policies, market reform, rural infrastructure improvement, and the development of a legal and contractual environment in which farmers and processors may operate were identified. Policies related to these driving forces will very much influence the nature and impact on the poor of the agricultural commercialization process. High risks of farm households in poverty and high transaction costs are the basic reason for the high prevalence of subsistence farming. A general conclusion is that when subsistence farming will be phased out in many low-income countries due to developmental progress in the "driving forces", policy must facilitate a transition which does not unduly replace (old) subsistence-related production risks with (new) market and policy failure risks, the profiles of which the poor may be much less able to estimate. Avoidance of trade shocks and concern for appropriate scheduling of input and output market reform are important considerations in this respect.

In summary, the set of policy issues that has been found important in LDC for maximizing the potential benefits and minimizing risks from agricultural commercialization include the following:

- promotion of technological change in subsistence food crops along with commercial crop production for household food security in areas with risky food markets;
- improvement of market infrastructure for food, non-food goods and services, especially in remote areas where a change in production towards non-foods may lead to a net food import balance and thereby drastic price changes;
- effective integration of the smallest farm households into cooperative schemes for commercialization and technological change;
- attention to land tenure and resulting land allocation problems when net returns to land increase substantially;
- establishment of effective rural financial institutions to generate savings and make credit available not only to scheme participants but also to the community as a whole.

Some of these issues, especially the attention to market infrastructure, land tenure, and rural finance, are also highly relevant for transforming small-scale subsistence farming into viable economic units of part-time farming in transforming economies of Central and Eastern Europe.

3 SUBSISTENCE AGRICULTURE IN CENTRAL AND EASTERN EUROPE TODAY

3.1 The Big Picture

Sociologists often define subsistence as minimum for survival, given certain standards. Economists view subsistence as a relative concept, in which consumption is related to own production. The commercialization of subsistence agriculture can take many different forms. It can occur on the output side of production with increased marketed surplus, but it can also occur on the input side with increased use of purchased inputs. Commercialization is not restricted to just "cash crops": the traditional food crops are frequently marketed to a considerable extent, and the so-called cash crops are retained, to a substantial extent, on the farm for home consumption. Finally, the commercialization of agriculture is not identical with the commercialization of the rural economy. The deviation between these two processes becomes all the more obvious when off-farm nonagricultural employment already exists to a large extent in a certain setting.

Ideally, we would like to have information on the two types of subsistence ratios – i.e., from a consumption and an input perspective – based on household surveys. However, they exist only for a few specific settings for particular years and are thus not designed to permit comparative studies. Therefore, we use changes in the number and size of small-scale farms over time as a rough approximation of subsistence farming and its trends. We use these approximations due to a lack of better data. The statistical services in CEEC should certainly pay more attention to the size and productivity of this sub-sector.

Subsistence agriculture is not a new feature of CEEC. During the socialist period, households engaged in agriculture frequently had access to small subsidiary household plots, which they could cultivate to supplement their own diets and use for their leisure. It was widely expected that, with transition to a market economy, the need for such subsidiary plots of rural households, and garden plots of urban families would disappear, as would their use. Instead, in most countries the prevalence of subsistence agriculture has actually increased in comparison to 1990 (for details see Table A in the Appendix).

- Taking the amount of agricultural land devoted to subsistence agriculture as an indicator of prevalence, we find that subsistence production has increased in size in all countries except Bulgaria.

- If the number of subsistence farms is taken as a measure of prevalence, however, a different picture emerges; subsistence agriculture has increased only in Georgia, Kazakhstan, Romania, the Ukraine and Uzbekistan, while all other countries experienced a decline in the number of subsistence farms.

The first trend may indicate some gradual intensification. The latter trend may signal a mixed pattern of continued use of home production as a household mechanism to cope with risks, but it may also just result from different land policies. From just these two measures we see that there are different trends with respect to the development of subsistence agriculture which must be considered in the formulation of policy options. Certainly, the prevalence of subsistence farming did not change fast in most CEEC. Apparently, the sub-sector is rather resilient to the dynamics of transition.

3.2 Different Trends of Subsistence Agriculture in Central and Eastern Europe

In order to establish a more concrete picture of the nature and driving forces of subsistence agriculture in the region as a whole and for specific countries, we seek to answer three questions:

1. Is the prevalence of the subsistence sector strongly related to levels of national per capita income?
2. Is the change in prevalence of subsistence agriculture affected by economic growth trends, i.e., will growth lead to quickly overcoming the sub-sector?
3. Have trends in the prevalence of subsistence agriculture been driven by land reform?

Tendencies illuminating these three questions are derived from Table A (Appendix). We thus compare the prevalence of subsistence farming among countries, taking note of a country's position and trajectory on the typically U-shaped transition curve (state and change of the economy), as well as the period of time during which land reforms occurred.

Question 1: Level of per capita Income and Prevalence of the Subsistence Sector

As subsistence agriculture is a feature of the developing, rather than the developed world, it is not unreasonable to expect a correlation between Gross National Product (GNP) per capita and the prevalence of subsistence agriculture. The greater GNP per capita is, the smaller we would expect the subsistence sector to be. In order to test this, two indicators of the prevalence of the subsistence sector were devised:

1. number of subsistence farms per 1,000 of the population,
2. amount of subsistence land per capita.

At first glance there appears to be little relation between these two indicators. Countries with a high number of subsistence farms do not necessarily have a larger amount of subsistence land per capita than countries with relatively few subsistence farms. To some extent this 'contradiction' can be explained by differing population densities, and differing amounts of agricultural land resources. The contradiction between the two indicators is reflected in the differing scatter-graphs produced when plotted against GNP per capita. While the number of subsistence farms appears to be negatively related to GNP per capita (see Figure 1 and Table 1), no strong relationship between GNP per capita and the amount of subsistence land can be established for the range of income observed here. Taking an unweighted average of countries above GNP per capita of 2,500 USD gives 76 farms per 1,000 of the population, while it is about twice as much (149) for those below 2,500 USD.⁵ This may indicate that in the long run at higher income levels, the sub-sector would shrink, but large variance exists across income levels today. Land per capita in these farms, however, does not differ by national income levels: it is 0.11 in the countries above 2,500 USD and 0.15 – in the poorer group of countries.

Table 1: Prevalence of Subsistence Agriculture and GNP per capita, 1999

Country	GNP per capita in 1999 USD ¹	No. of Subsistence Farms per 1,000 People	Subsistence Land per capita (in ha)
Slovenia (1997) ²	9,890	0.2	-
Hungary (1996) ³	4,650	97	0.02
Poland (1997) ⁴	3,960	26	0.03
Estonia (1997) ⁵	3,480	89	0.15
Belarus ⁶	2,630	149	0.14
Lithuania (1997) ⁷	2,620	93	0.2
Latvia (1997) ⁸	2,470	70	0.35
Russia ⁹	2,270	105.6	0.04
Romania ¹⁰	1,520	187	0.4
Bulgaria (1997) ¹¹	1,380	187	0.05
Kazakhstan ⁴	1,230	141	0.03
Ukraine ¹²	750	230	0.12
Uzbekistan ¹³	720	86	0.02
Georgia ¹⁴	620	185	0.16

Note: Number of subsistence farms per 1,000 people and subsistence land per capita were calculated using the data sources listed below. Please also refer to Table A in the Appendix.

Sources: ¹ WORLD BANK (2000); ² EUROPEAN COMMISSION (1998h); ³ HUNGARIAN MINISTRY OF AGRICULTURE AND REGIONAL DEVELOPMENT (2000); ⁴ EUROPEAN COMMISSION (1998f); ⁵ EUROPEAN COMMISSION (1998b); ⁶ OECD (1998); ⁷ EUROPEAN COMMISSION (1998e); ⁸ EUROPEAN COMMISSION (1998d); ⁹ GOSKOMSTAT – various years; ¹⁰ ROMANIAN MINISTRY OF AGRICULTURE AND FOOD (2000); ¹¹ EUROPEAN COMMISSION (1998a); ¹² UKRAINIAN STATE COMMITTEE OF STATISTICS – various years; ¹³ KHUSANOV (2000); ¹⁴ GEORGIAN STATE DEPARTMENT OF LAND MANAGEMENT AS IN RESAL (1999).

⁵ Slovenia is not included.

Figure 1: Number of Subsistence Farms per 1,000 of the Population and GNP per capita, 1999

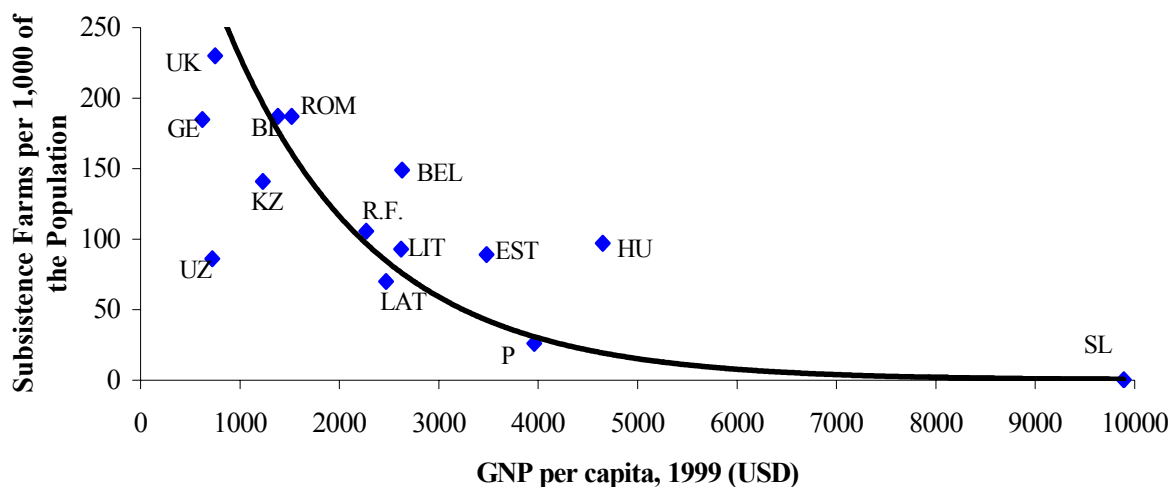

Source: Own calculations using data in Table 1, above.

Question 2: Subsistence Agriculture and Economic Growth Trends

The data on the whole does not point towards a distinctive relationship between a country's position on the transition curve in the late 1990s and trends in the subsistence sector. The strongest relationship evidenced is between economic growth and the number of subsistence plots (Table 2). Countries that were on a recovery path with respect to GDP indices in 1999 and exhibit stability in the number of subsistence farms include Uzbekistan, Kazakhstan, Georgia and Bulgaria. Lithuania and Belarus experienced both economic growth and a decline in the number of subsistence plots, as would be expected. However, in the Ukraine, which was subject to economic decline in the late 1990s, the number of subsistence plots has not changed, while in Russia their number has actually declined.

The relationship between the proportion of agricultural land devoted to subsistence and economic growth trends is more ambiguous. Only one country that experienced recent growth also had a decline in the proportion of agricultural land, Bulgaria. Belarus, Kazakhstan and Uzbekistan exhibit no change in the proportion of land used for subsistence, whilst Georgia actually experienced an increase. The situation is by no means clarified with reference to those countries experiencing economic decline: while in Romania the proportion of land increased, as expected, in the Ukraine and Russia the proportion of land remained unchanged.

As the economic situation improves we might expect the size of subsistence farms to increase, but this occurred only in one of the countries reviewed, Kazakhstan. This is consistent with the earlier cross-sectional comparisons in Table 1. Bulgaria experienced a decline in the average size of subsistence farms, while there was no change in Belarus, Lithuania and Uzbekistan. Indeed, the average size of subsistence farms does not appear to be greatly affected by

economic trends, with farm size in Romania, Russia and the Ukraine remaining stable in the latter half of the nineties. It appears, therefore, that economic growth exerts an influence on the absolute number of subsistence farms, but its influence on subsistence farm size and the proportion of land taken up by them is marginal at best.

Table 2: Trends in the Number of Subsistence Plots

Country	Economic Growth ¹		Subsistence Plots ²	
	1990-94	1995-99	1990-94	1995-99
Belarus	-	+	↔	↓
Bulgaria	-	+	↓	↔
Georgia	-	+	↑	↔
Lithuania	-	+	↓	↓
Kazakhstan	-	+	↑	↔
Russia	-	-	↔	↓
Ukraine	-	-	↑	↔
Uzbekistan	-	+	↑	↔

Notes: ↔ < +/- 2 %; ↑ > +2%; ↓ > -2%

Source: ¹ EBRD, Transition Report 2000, p. 65;

² Own calculations based on various data, see Table A in Appendix for details.

Table 3: Trends in the Percentage of Agricultural Land Devoted to Subsistence Production.

Country	Economic Growth ¹		% Agricultural Land ²	
	1990-94	1995-99	1990-94	1995-99
Belarus	-	+	↑	↔
Bulgaria	-	+	↔	↓
Georgia	-	+	↑	↑
Kazakhstan	-	+	↑	↔
Romania	-	-	↑	↑
Russia	-	-	↑	↔
Ukraine	-	-	↑	↔
Uzbekistan	-	+	↑	↔

Notes: ↔ < +/- 2 %; ↑ > +2%; ↓ > -2%

Source: ¹ EBRD, Transition Report 2000, p. 65;

² Own calculations based on various data, see Table A in Appendix for details.

Table 4: Trends in the Mean Size of Subsistence Farms

Country	Economic Growth ¹		Mean Size ²	
	1990-94	1995-99	1990-94	1995-99
Belarus	-	+	↑	↔
Bulgaria	-	+	↔	↓
Lithuania	-	+	↑	↔
Kazakhstan	-	+	↔	↑
Romania	-	-	↑	↔
Russia	-	-	↑	↔
Ukraine	-	-	↑	↔
Uzbekistan	-	+	↑	↔

Notes: ↔ < +/- 2 %; ↑ > +2%; ↓ > -2%

Source: ¹ EBRD, Transition Report 2000, p. 65;

² Own calculations based on various data, see Table A in Appendix for details.

Question 3: Land Reform and Trends in Subsistence Agriculture

Land reform occurred in virtually every country of Central and Eastern Europe, even if it only involved the distribution of paper shares. The redistribution of land that took place in the CEEC can be expected to have had a profound effect on the subsistence sector, increasing the number of people with access to land and increasing peoples' land shares, thereby enabling them to leave the subsistence sector. Certainly, as the cut-off point for subsistence farming in our data set was 1 ha, even a small increase in farm size would lead to these farms being graduated from the subsistence sector defined in this way. Hence, a strong correlation between land reform and changes in the subsistence sector seems reasonable to expect.

The comparison of trends in subsistence agriculture with the occurrence and implementation of land reform reveals correlations between the two. In the majority of countries, the prevalence of subsistence agriculture tended to increase, or decrease, during the same period that land reform occurred. Although, with respect to the proportion of agricultural land under subsistence cultivation, these changes often occurred with a time lag. Indeed, in Bulgaria only the number of subsistence farms changed in the same period that land reform occurred. The lag between land reform and changes in the extent of subsistence farming can be attributed to delays in the implementation of reform.

Thus, although land reform clearly had a great influence on the direction of trends in the subsistence sector, which is reflected in the stability of the sector in the latter half of the nineties, it cannot tell the whole story. Clearly, other factors also play a role; a role that will become more important over time as the effects of land reform fade.

Table 5: Trends in the Number of Subsistence Plots and Land Reforms

Country	Land Reform		No. Subsistence Plots ¹	
	1990-94	1995-99	1990-94	1995-99
Belarus ²	√		↔	↓
Bulgaria ³	√		↓	↔
Georgia ²	√	√	↑	↔
Kazakhstan ⁴	√	√	↑	↔
Lithuania ³	√		↓	↓
Russia ²	√		↔	↓
Ukraine ²	√		↑	↔
Uzbekistan ⁵	√		↑	↔

Note: This refers only to land reforms which had an impact on the subsistence sector, i.e., the 1993 reform in Belarus which affected household plots is included, but land reform in Russia is excluded as this has had a minimal impact on the extent of subsistence agriculture.

Sources: ¹ Based on various data, see Table A in Appendix for details.
Land Reform: ² LERMAN (1997); ³ SWINNEN and MATHIJS (1997); ⁴ GRAY (2000); ⁵ KHUSANOV (2000).

3.3 Overcoming Subsistence Agriculture – A Stated Policy Goal?

We argued at the outset that policy approaches toward the subsistence sector could be distinguished into a "Laissez-faire approach" and "Active engagement approach". Reality seems to suggest that the former dominates. In some countries the extent of subsistence agriculture is so small to be almost negligible, e.g., Slovenia. Thus, policies aimed at overcoming subsistence agriculture may be redundant. In other countries, for example Hungary, subsistence agriculture is seen to be declining, and TANIC (2000) argues that over time subsistence farming will disappear of its own accord. Whether or not to introduce policies aimed at overcoming subsistence agriculture may, therefore, be a matter of the significance of the sector, national preferences and priorities. In a third group of countries, the need to commercialize small-scale agriculture is much more evident. In both Georgia⁶ and Romania, land reform resulted in an agricultural sector dominated by small-scale subsistence farms. If these countries want to improve the performance of their agricultural sectors in general, they will have to implement measures which will assist in the commercialization of these farms.

Before we go on to consider the major constraints to increasing efficiency in subsistence agriculture and possible policy solutions, a further distinction must be introduced. Just as the extent of subsistence agriculture is not uniform across Central and Eastern Europe, the nature of subsistence agriculture too varies between and within countries. In the countries of the former Soviet Union, two distinct types of subsistence agriculture exist:

- the urban population which have recourse to *dacha* gardens, and
- rural people who utilize their subsidiary household plots.

The latter tend to be much larger than *dacha* gardens (0.36 ha compared to 0.08 ha, GOSKOMSTAT 1999) and accordingly play a much greater role in food production. While significant in terms of calorie production and time allocation (THO SEETH 1998), the significance of *dacha* food production as a survival strategy has been questioned by CLARKE (1999). Using household data from three sources CLARKE et al. (1999) shows that *dacha* food production contributes only a small amount to overall household food resources, which is worth 8% of the total expenditure on food. Moreover, there was no evidence that households lacking access to *dacha* gardens spent either a larger proportion of income, or a greater amount of money, on food. Research conducted by THO SEETH (1998) shows that while gardening is significant for urban populations it is the middle class who gain the most from this, as the poor generally do not have access to garden plots and are thus poor in terms of subsistence agriculture,

⁶ In Georgia the vast majority of large-scale agricultural enterprises have collapsed, thus individual farms dominate production despite their relatively small share of agricultural land (DIDEBULDIZE 1997).

too. In consideration of this, in the discussion below we will focus on subsidiary household plots.

4 POLICY OPTIONS FOR ENHANCING EFFICIENCY IN SUBSISTENCE AGRICULTURE

4.1 Conceptual Overview

Subsistence agriculture is generally driven by three sets of forces:

- food demand (income, prices, and taste),
- labor opportunity costs,
- missing markets in insurance, asset market malfunctioning and banking risk.

Food demand is not the main driving force in transition economies: Risk (perceptions) and a lack of insurance probably play greater roles. On the whole, however, interactions between the four components shape the development of subsistence agriculture (see Figure 2). Thus, any policy framework which seeks to enhance efficiency in subsistence agriculture must consider all four of these factors.

Figure 2: Conceptual Links Between Driving Forces and Policies

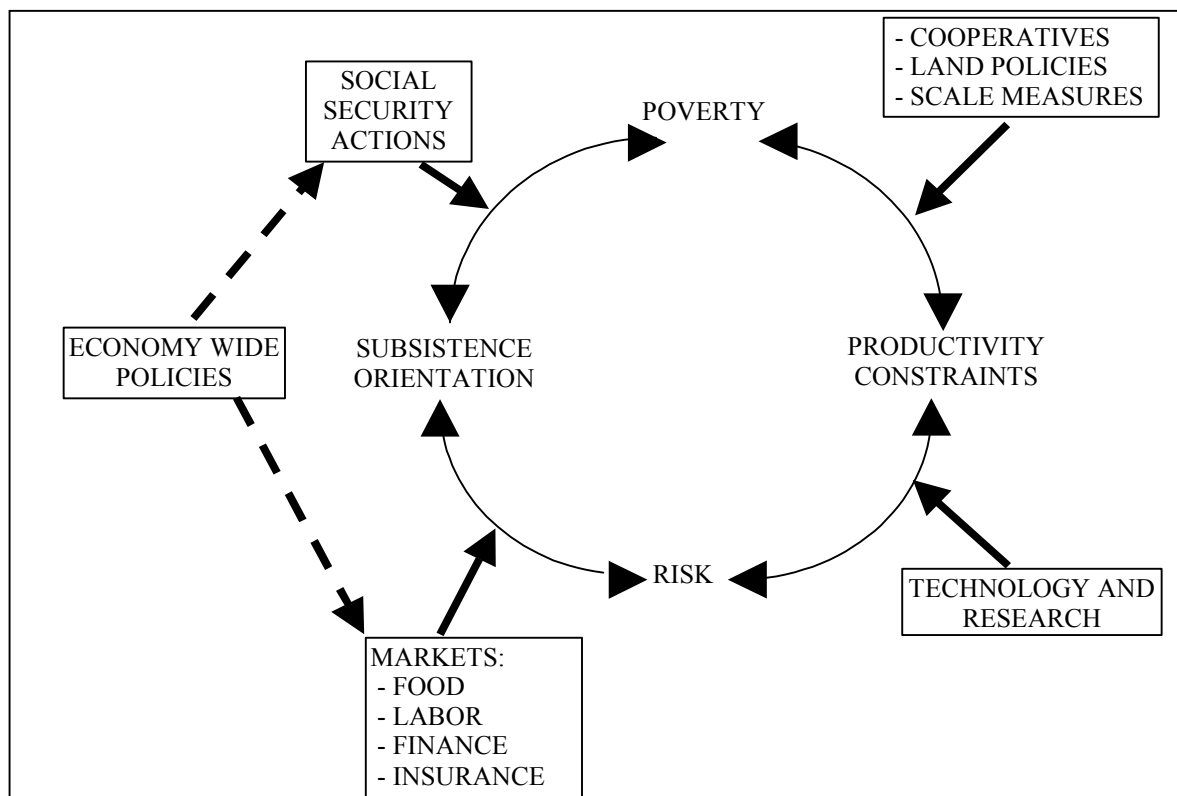

Source: Authors' own design.

The question of whether or not subsistence agriculture should be overcome must be economically evaluated. Such an evaluation has to focus on efficiency, including scale economies. Going back to T. W. SCHULTZ (1964), we argue that if farms are small, efficient (but poor) – given current resource endowments –

then it is indeed high time to overcome subsistence agriculture. The policy measures to be considered broadly include investment in technological change and market integration. They may be grouped into the following four policy areas:

1. Policies that decrease risks of markets (especially for labor) and rationalizing taxation;
2. measures to facilitate scale economies, either through cooperation in input and output markets or rural finance;
3. land market-related actions, including the facilitation of land purchases and leasing, through land ownership and land rental laws and financial market actions;
4. technology and research-based support forms the fourth vital component of a policy framework seeking to address efficiency in subsistence agriculture.

4.2 Decreasing the Risks of Markets and Rationalizing Taxation

Much of the appropriate policy actions are outside actions directly aimed at the subsistence sector. These relate to measures to decrease the risk of the food, labor and insurance markets. They are particularly needed in the low income countries, including Romania, Bulgaria, Russia, the Ukraine and Georgia. Here, liberalization policies significantly increased household exposure to risk, which in turn increased their dependence on subsistence plots. The resilience of subsistence agriculture in Europe can largely be attributed to the economic crisis that CEEC experienced at the beginning of the Transition. As industrial output declined, unemployment grew and the social security system failed, people had to develop their own survival strategies; thus, they resorted to subsistence agriculture.

Governments should develop policies that create alternatives to subsistence as a coping strategy. Such alternatives include market-related institution building and information, and strengthening labor laws to overcome non-payment of wages. In addition, taxation policies should be reviewed to eliminate disincentives to turn to the market. A few examples may illuminate the related problems and policy deficiencies:

In a 1998 Russian survey about perceived effectiveness of household coping mechanisms, 35% of households considered "growing more on the land plot" as a very helpful strategy and 60% as somewhat helpful, which ranked this among the top three out of 16 alternative strategies.⁷

According to KOSTOV (2001), subsistence agriculture in Bulgaria is the buffer that protects the population from the effects of economic collapse, as manifested

⁷ RLMS survey, as reported by LOKSHIN and YEMTSOV (2001, p. 20).

in the collapse of industrial employment, low wages and limited job opportunities. Secondary agriculture is the most important survival strategy in Bulgaria, with 28% of non-agricultural workers being involved in it and home production accounting for 23% of income in 1996 (CLARKE 1997a).

In Romania too, subsistence agriculture has become a substitute for the now non-existent social security net. The small plots of land owned by the majority of the Romanian population are currently their only means to secure housing and food needs, according to BREITSCHOPF (2001).

This situation contrasts sharply with that of Poland. Here, both the extent of poverty and subsistence farming are much smaller, a fact that may be attributed partly to the continued functioning of the social security system. The value of pensions, for example, has been maintained (CLARKE 1997b), thus pensioners have no need to resort to subsistence agriculture in order to secure their livelihoods.

In light of the above, economic development and institutional innovation has the potential to substantially reduce subsistence agriculture in some CEEC through the strengthening of the social security net. The creation of both industrial and rural non-agricultural employment opportunities could do much to reduce reliance on the subsistence sector. High unemployment has resulted in a labor shift from industry to agriculture in many transition economies. The creation of rural non-agricultural employment opportunities is needed to decrease dependence on small holdings and increase rural incomes, thereby allowing some people to move out of agriculture, and others to expand production.

Rigidities in labor markets can contribute to the entrenchment of subsistence production by limiting access to alternative sources for subsistence and risk coping. A recent study by FRIEBEL and GURIEV (2000), found that the practice of payment-in-kind acts to reduce labor mobility in Russia, as it effectively limits workers' ability to save sufficient cash to migrate. This line of argument can easily be extended to wage delays, another practice that is widespread in Russia. However, these practices do not only act to bind workers more tightly to enterprises, but also encourage subsistence agriculture. Under conditions of wage arrears and in-kind payments, the reliance of workers on home production of food increases substantially, and this reliance in itself can reduce labor mobility. Even when workers have saved sufficient cash to finance a move, they may not do so, as moving would entail the loss of the subsistence plot and the related investments made in it. In a risky employment environment there are no guarantees that in the new place of employment wage arrears would not occur, and in such a situation the migrant would be worse off than before as he/she has no opportunity to revert to subsistence agriculture.

Tax incentives can have a substantial effect on the productivity and commercialization of small-scale agriculture, and, at the same time, government

tax revenues may increase. This can be illustrated by the case of Georgia, where a tax system that effectively reduces farmers' incentives to expand production has been in operation since January 1999. Farmers are liable to a range of taxes consisting of Value Added Taxes (VAT), income tax, property tax, a traffic fund fee and a land ownership fee. These taxes amount to 56% income for a typical 1 ha farm, according to calculations made by the Fund for Georgian Private Farmers Assistance (KIRVALIDZE 1998). The tax burden is even larger for farms of 2 ha or more. These farms may need to hire labor, in which case they are liable to additional tax payments in the form of social insurance, medical insurance and an unemployment fund fee. Owing to the high total taxation burden, small farmers have little incentive to increase farm size, as a large proportion of the additional income earned will accrue to the government rather than themselves. Farmers' response to such heavy taxation has been bribery of tax officials to avoid paying the full complement of taxes. Alternative tax systems have been proposed which would reduce the overall level of taxation of small-scale agriculture. The Fund for Georgian Private Farmers Assistance proposed that small-scale agriculture should be exempt from all taxes except a land tax, which should be calculated according to the quality of land and its location (KIRVALIDZE 1998).

In both Russia and the Ukraine the tax system is different, but once again it reduces farmers' incentives to move into the 'formal' agricultural sector i.e., transform their household plots into market-oriented farms. In the Ukraine, household plots operate under privileged tax conditions compared to the rest of the agricultural sector: VAT is not paid on produce sold, nor are deductions made to cover social security; however, private farms are liable to both (PUHACHOV 1999). Thus, expanding a household plot into a private farm involves considerable costs, and reducing these costs would presumably encourage more people to leave the subsistence sector. How to achieve this is not as clear cut; PUHACHOV (1999) argues that removing taxes from private farms is not the answer, but it is doubtful whether making household plots liable to tax is. In Russia, the problem is similar to that in the Ukraine, but complicated by the fact that household plots can be expanded to a maximum of 6-12 ha by using one's land share to expand the household plot (OECD 1998). In Russia, household plots are practically exempt from income tax, and only have a small land tax levied on them, whereas independent farms are liable to a range of taxes, with the overall level of taxation being high (KALUGINA 2000). A shift of household farms from the informal to the formal sector would thus result in heavy tax liabilities. This, in conjunction with the cessation of aid from collective enterprises, significantly increases a farm's exposure to risk. As it is possible to cultivate up to 12 ha of land in the informal sector, there are no incentives to move production from the formal to the informal sector. Reforming the tax system so that it provides incentives rather than disincentives to move

into the market has the potential to transform those household farms producing not only for subsistence.

The broad-based policies to increase efficiency in subsistence farming should be embedded in comprehensive rural development strategies that give due attention to rural education, infrastructure and other public goods.

4.3 Measures to Facilitate Scale Economies Through Cooperation and Rural Finance

In addition to the highly relevant indirect policy measures to increase efficiency of subsistence farming discussed above, direct measures are also called for.

Lack of access to input and output markets is a problem faced by smallholders in all CEEC, but one that is particularly pronounced in low income countries with a relatively large subsistence sector, e.g., Georgia and Romania. This somewhat paradoxical situation arises from the fact that both in Russia and the Ukraine many household plots still receive inputs from the agricultural enterprise they were formerly attached to. On the basis of a recent survey AMELINA (2000), examines the benefits that Russian peasants receive from associations with collective farm enterprises. She finds that from the point of view of the household, the benefits derived from association with a less-restructured enterprise are no less than the value of cash payments received by employees in a more restructured enterprise. The benefits of in-kind payments are primarily derived from the price-differential between the internal prices of in-kind compensations and their market price. Employees maximize their profits by using these in-kind transfers for private agricultural production. However, the situation with respect to output markets is slightly different. In Russia and the Ukraine, as well as Georgia and Romania, access to output markets is, for various reasons, low. In Russia marketing costs are high and inhibit market performance and domestic trade (KUHN 2001).

Cooperative systems, which in principle could go a long way in addressing scale economy problems, are largely neglected in the smallest scale farming sector. This is particularly so in the countries of the FSU, and thus seems to be more a product of privatization strategies and the Soviet legacy than income levels and the prevalence of subsistence agriculture. In Russia and the Ukraine, agricultural privatization involved the distribution of paper shares rather than physical plots of land. As a consequence, the agricultural sector has not been subjected to deep reform and most agriculture effectively remains collectivized. In the Ukraine these collectives are largely managed by traditional centralized means, and little has changed for the members themselves (LERMAN and CSAKI 1998). In these two countries the majority of rural subsistence plots are still tied, in some way or another, to a particular collective enterprise. To withdraw land from the collective in order to join a cooperative does not seem sensible in such a situation.

In Georgia the situation is very different. Here, physical plots of land were distributed and the former collective enterprises collapsed. The farms created by the reform are extremely small, on average 0.8 ha, but despite the obvious advantages, which could be achieved by forming cooperatives, there appears to be little inclination to do so. This is largely due to the negative experiences gained from Soviet collectives. In other countries which have experienced a growth in small-scale agriculture, the creation of cooperatives has occurred. For example, in Romania private households are pooling their resources by forming farm associations without legal title – note that the number of these farms has declined considerably in the last 4 years from 15,000 to 6,000 today (SCHRIEDER et al. 2000). For many of these diverse circumstances, however, a fresh approach toward building truly independent cooperative systems bottom up should be considered in order to capture economies of scale in the subsistence sector, at least on the input market side. The need for cooperation also relates to financial systems for the small holders.

The lack of access to credit through inadequate financial markets constrains increased production as farmers lack the capital to invest in new technologies and improved seeds. In Romania, most small rural enterprises, both agricultural and non-agricultural, lack access to credit due to high collateral requirements. Collateral requirements reflect the high transaction and risk costs incurred by financial intermediaries operating in rural areas; in Romania they are currently as high as 160% of the value of the loan (BREITSCHOPF 2001). In practice, this means that a loan contract requires almost all farm assets as security. As the vast majority of Romanian smallholders are subsistence farmers, dependent on their farms for their livelihoods, even a very small probability of failure leads to a refusal of a loan contract by the farmer (BREITSCHOPF 2001).

In some transition economies, state credits funds still form the major source of agricultural credit. However, this does not tend to increase smallholders' access to credit. In Russia, for example, the rural state credit system serves only large-scale agricultural enterprises (YANBYKH 2000). Only a very small number of private farms receive subsidized loans from the Special Credit Fund, largely because the banks chosen for disbursing the funds have little experience in providing credit to small farms. As in Romania, collateral requirements are a big problem, between 120 and 150% of the value of the loan (YANBYKH 2000). Such requirements are too high for the majority of small farmers, let alone for those engaged in subsistence production.

A possible solution to the rural credit problem could be rural credit cooperatives. The absence of a legal base for their development is, however, an effective constraint on their proliferation in some countries, e.g., Russia; for the undeveloped nature of rural credit cooperatives' legal base denies them access to central bank credits, contributing to their under-capitalization and inhibiting their proliferation.

4.4 Land Market Related Actions

Lack of access to land is one of the classical constraints to the commercialization of subsistence agriculture. It can arise through a physical lack of land (due to population pressure), the concentration of land in the hands of a few, and non-functioning land and lease markets. In the CEEC and NIS, lack of access to land tends to be the result of inadequate land and lease markets. Lack of access to land seems to characterize all of the lower income economies regardless of the size of the subsistence sector. For example, in the Ukraine recent surveys indicate that some 5-8% of the rural population wish to take up private farming, i.e., potentially 150,000 additional private farms could be created (PUHACHOV 1999). This is a substantial number considering the small number of private farms currently operating in the Ukraine, 35,500. However, the lack of access to land inhibits the creation of private farms, and the expansion of already existing private farms (half of these are under 10 ha). Lease markets in particular are under-developed mainly due to the low profitability of leasing. The July 1992 Law on Payment for Land states that lease payments are not allowed to exceed the amount of tax on the corresponding plot of land (LERMAN and CSAKI 1998). This is a major disincentive for private owners to lease land as they will collect only just enough to cover their tax obligation. Removing this constraint would enable farms to achieve scale economies by increasing in size.

Small-holder agriculture in Georgia provides a good illustration how a lack of access to land can have negative consequences for the entire agricultural sector. Land reform in Georgia resulted in the distribution of physical plots of land to 1 million families, or 73% of the population (DIDEBULIDZE 1997). However, the newly created farms are too small for commercial production with an average size of just 0.84 ha. This is partly due to the substantial size of the non-reformed sector, 40% of which intensively uses agricultural land, and partly a result of the large number of reform beneficiaries. In order to produce crops for the market these small farms need access to additional land, but such access is currently constrained by the absence of a land market and the non-transparency of the lease market. Land markets currently do not function in Georgia, as sale requirements include possession of a land title. But distribution of these titles is still incomplete, having only begun in mid-1999. Therefore, in the short to medium term, farmers must turn to lease markets in order to obtain additional land for cultivation. Lease markets are primarily concerned with state land, i.e., land not distributed in the land reform, and the amount paid for leasehold is low, consisting, in general, of the land tax levied on the leased plot. So why do the majority of smallholders complain of a lack of access to land? This is at least partly the consequence of the non-transparent nature of the lease process. In order to lease land farmers must make an application to the village council. If the proposal is approved, it is submitted to the District Administration for final

approval. The exact procedure followed varies between regions, with some requiring a business plan and others relying on the applicant's reputation. However, in all regions applications are vetted by the village council, a procedure which is currently non-transparent (RESAL 1999).

Issues of land leasing and idle land are growing in importance in the region. In principle, no specific land policy for the smallest farm sub-sector should be considered; instead the issue should be addressed by general ownership and property rights policies. Furthermore, clearly defined land market policies are needed to integrate this sector into the market economy, and security of land tenure is fundamental for efficiency in this sub-sector. Otherwise, long-term investment and attention to production will not be so forthcoming.

4.5 Technology and Research Based Support

While almost all low income countries of the world benefit from a substantial set of organizations that assist with public goods provisioning for the small holder sector, this is largely absent in CEEC. The subsistence farm sector remains the most under-researched sub-sector in CEEC. This applies especially to technology research that might benefit the sector. Public research that, for example, helps to identify crop varieties, plant protection, backyard livestock production, input use, market services, and information systems is virtually absent. The traditional national and sub-regional agricultural research systems continue to focus on the large scale sector and are in disarray in many CEEC.

One of the few lessons that may be drawn from the experiences of subsistence farming in developing countries is that public research, and the institutional and technological innovation created by it, can facilitate growth in this sector. A fundamental re-direction of public agricultural research and extension systems in CEEC is called for. Such research should quickly develop a capacity for intelligent borrowing from experiences with small holder productivity enhancement elsewhere in the world. A productive and vibrant part-time farm sector that plays a key role parallel to the large-scale sector could be the long-run policy objective for many CEECs.

5 CONCLUDING REMARKS

Home production of food, being a highly relevant mechanism through which many Eastern European and FSU rural and urban households attempt to cope with transformation risks, has largely been bypassed by public services and agricultural policy. Market integration will only slowly facilitate increased efficiency in the current subsistence sector in CEEC.

A laissez-faire approach that would leave subsistence agriculture alone, and expects the market and economic transformation processes to take care of inefficiency problems in this sub-sector is here rejected. The basic scale economy

problem preventing small holders from investing at optimal levels in efficiency can be addressed in part by increasing public goods, such as applied research, technology, market information and rural institutions. However, these will not be forthcoming without policy actions.

Therefore, an active engagement approach is advocated, one which takes an active public policy position, addressing market failure problems, and providing public goods that enhance efficiency. While taking this position, we must recognize that overcoming inefficiency in the subsistence sector will largely be a matter of economy-wide policies and comprehensive rural development actions.

Still, the sector itself also can and must be addressed with direct policy actions. Otherwise, the misallocation of land and labor resources will prevail. The idea that this sub-sector of the rural and urban economy would vanish quickly in the context of a possibly re-invigorated economic growth process in Eastern Europe and the FSU seems misleading. Given the current conditions prevailing in Eastern Europe and the FSU, and the related economic risks for households, an increase in opportunity costs (wages) would reduce time allocation to subsistence farming only by a small portion, at least in the low income regions of CEEC. Household plot-based agriculture will remain a long-term reality in many parts of CEEC, and not only where per capita income is low. Part-time small-scale farming is a stable factor in agriculture all over the world. The CEEC will be no exception. Measures for productivity growth in that sector should be considered in the areas of

- rural institution building;
- policies that decrease risks of markets (especially for labor);
- policies that rationalize taxation;
- measures to facilitate scale economies through cooperation in input and output markets and rural finance;
- land market related policies, including the facilitation of land purchases and leasing through land ownership and land rental laws, must give attention to this sector; and
- technology and research-based support provided by re-directed agricultural research systems, that give due attention to this sub-sector.

APPENDIX

Table A: Trends in the Development of Subsistence Agriculture in Some Central and Eastern European Countries

Country	1989/1990			1994/1995			1999/2000		
	% Ag. land	Number	Av. size	% Ag. land	Number	Av. Size	% Ag. land	Number	Av. size
Belarus ¹	6.4	1 549 900	0.41 ha	15.3	1 532 000	0.94 ha	15.6	1 506 300	0.97 ha
Bulgaria ²	10	1 783 800	0.4 ha	10.5	1 555 000	0.42 ha	6.2	*1 535 200	0.25 ha
Estonia ³	n	n	n	n	n	n	**18	130 000	1.7 ha
Georgia ⁴	7	729 000	0.29 ha	25	~1 000 000	n	**30	1 019 800	0.84 ha
Hungary ⁵	6	1 400 000	0.25 ha	16.8	978 101	0.2 ha	n	n	n
Kazakhstan ¹	0.11	2 093 400	0.1 ha	0.17	2 232 821	0.1 ha	**0.16	2 149 501	0.2 ha
Latvia ⁶	2.5	250 172	0.4 ha	N	n	n	**37	173 280	4.9 ha
Lithuania ⁷	8.8	413 138	0.55 ha	23.4	378 412	2.2 ha	**n	342 700	2.2 ha
Poland ⁸	3.6	n	n	N	n	n	*6.5	1 019 000	1.3 ha
Romania ⁹	12	n	0.5 ha	56.4	*3 625 758	2.3 ha	67	4 221 015	2.35 ha
Russia ¹⁰	1.5	16 300 000	0.2 ha	2.9	16 581 721	0.37 ha	3.0	15 500 000	0.4 ha
Slovenia ¹¹	n	n	n	N	n	n	1.2	8448	< 1ha
Ukraine ¹²	6.5	9 206 000	0.29 ha	13	11 057 000	0.48 ha	15	11 700 000	0.5 ha
Uzbekistan ¹³	0.6	1 500 000	0.18 ha	1.6	2 080 000	0.25 ha	1.6	2 080 000	0.25 ha

Notes: * Data from 1996, ** Data from 1997.

Sources: ¹ OECD (1998) CEECs/NIS Agricultural Indicators Database;

² EUROPEAN COMMISSION (1998a);

³ EUROPEAN COMMISSION (1998b);

⁴ State Department of Land Management as in RESAL (1999);

⁵ EUROPEAN COMMISSION (1998c); HUNGARIAN MINISTRY OF AGRICULTURE AND REGIONAL DEVELOPMENT (2000), Table 6;

⁶ EUROPEAN COMMISSION (1998d);

⁷ EUROPEAN COMMISSION (1998e);

⁸ EUROPEAN COMMISSION (1998f);

⁹ EUROPEAN COMMISSION (1998g); ROMANIAN MINISTRY OF AGRICULTURE AND FOOD (2000);

¹⁰ GOSKOMSTAT, STATISTICAL YEARBOOK OF RUSSIA – various years;

¹¹ EUROPEAN COMMISSION (1998h);

¹² UKRAINIAN STATE COMMITTEE FOR STATISTICS – various years;

¹³ KHUSANOV (2000).

REFERENCES

- AMELINA, M. (2000): Why Russian Peasant Remain in Collective Farms: A Household Perspective on Agricultural Restructuring, *Post-Soviet Geography and Economics*, Vol. 41, No. 7, pp. 483-511.
- BINSWANGER, H., VON BRAUN, J. (1991): Technological Change and Commercialization in Agriculture: The Effect on the Poor, *The World Bank Research Observer*, Vol. 66, (January), pp. 57-80.
- BREITSCHOPF, B. (2001): Rural Financial Markets in Romania, Supply and Demand of Credit, PhD Thesis, Stuttgart, University of Hohenheim, Department of Development Theory and Agricultural Policy in the Tropics and Subtropics, forthcoming.
- CLARKE, S. (1997a): Poverty in Bulgaria, Report prepared for the Department of International Development, UK.
- CLARKE, S. (1997b): Poverty in Poland, Report prepared for the Department of International Development, UK.
- CLARKE, S., VARSHAVSKAYA, L., YAROSHENKO, S., KARELINA, M. (1999): The Russian Dacha and the Myth of the Urban Peasant, <<http://www.csv.warwick.ac.uk/fac/complastuds/russia/employ.html>>.
- DIDEBULIDZE, A. (1997): Agriculture and Rural Development in Georgia: Problems and Prospects, *UNDP Discussion Paper Series 5*, UNDP, Tbilisi.
- EBRD (2000): Transition Report 2000, London, EBRD.
- EUROPEAN COMMISSION (1998a): *Agricultural Situation and Perspectives in Central and Eastern Europe: Bulgaria*, European Commission, Directorate-General for Agriculture, Brussels.
- EUROPEAN COMMISSION (1998b): *Agricultural Situation and Perspectives in Central and Eastern Europe: Estonia*, European Commission, Directorate-General for Agriculture, Brussels.
- EUROPEAN COMMISSION (1998c): *Agricultural Situation and Perspectives in Central and Eastern Europe: Hungary*, European Commission, Directorate-General for Agriculture, Brussels.
- EUROPEAN COMMISSION (1998d): *Agricultural Situation and Perspectives in Central and Eastern Europe: Latvia*, European Commission, Directorate-General for Agriculture, Brussels.
- EUROPEAN COMMISSION (1998e): *Agricultural Situation and Perspectives in Central and Eastern Europe: Lithuania*, European Commission, Directorate-General for Agriculture, Brussels.
- EUROPEAN COMMISSION (1998f): *Agricultural Situation and Perspectives in Central and Eastern Europe: Poland*, European Commission, Directorate-General for Agriculture, Brussels.
- EUROPEAN COMMISSION (1998g): *Agricultural Situation and Perspectives in Central and Eastern Europe: Romania*, European Commission, Directorate-General for Agriculture, Brussels.

- EUROPEAN COMMISSION (1998h): *Agricultural Situation and Perspectives in Central and Eastern Europe: Slovenia*, European Commission, Directorate-General for Agriculture, Brussels.
- FRIEBEL, G., GURIEV, S. (2000): *Should I Stay or Can I Go? Worker Attachment in Russia*, Paper presented at the Global Development Network Conference, Tokyo, Japan, December 2000.
- GOSKOMSTAT STATISTICAL YEARBOOK OF RUSSIA – Various Years, Moscow, Goskomstat.
- GRAY, J. (2000): Kazakhstan: A Review of Farm Restructuring, *World Bank Technical Paper No. 458*, World Bank, Washington, D.C.
- HUNGARIAN MINISTRY OF AGRICULTURE AND REGIONAL DEVELOPMENT (2000): Supplement to National Agricultural and Rural Development Plan 2000-2006, available at <<http://www.fvm.hu/english/english.html>>.
- KALUGINA, Z. (2000): Paradoxes of Agrarian Reform in Russia, in: NORSWORTHY, L.A. (ed.): *Russian Views of the Transition in the Rural Sector*, The World Bank, Washington, D.C.
- KHUSANOV, R. (2000): Policy Reforms and Food Security in Uzbekistan, in: BABU, S., TASHMATOV, A. (eds.): *Food Policy Reform in Central Asia: Setting the Research Priorities*, IFPRI, Washington, D.C., pp. 137-142.
- KIRVALIDZE, D. (1998): Taxation on Primary Agricultural Activities in Georgia, Brief Notes for Agricultural Policy Makers, The Fund for Georgian Private Farmers Assistance, Tbilisi.
- KOSTOV, P. (2001): Assessing and Measuring the Importance of Small-Scale Subsistence Farming in Bulgarian Agriculture, PhD Thesis, University of Newcastle, forthcoming.
- KUHN, A. (2000): Handelskosten und regionale (des-)Integration: Russlands Agrarmärkte in der Transformation, PhD Thesis, University of Bonn, Center for Development Research, forthcoming.
- LERMAN, Z. (1997): Experience of Land Reform and Farm Restructuring in the Former Soviet Union, in: SWINNEN, J.F.M., BUCKWELL, A.E., MATHIJS, E. (eds.): *Agricultural Privatisation, Land Reform and Farm Restructuring in Central and Eastern Europe*, Aldershot, Ashgate, pp. 311-333.
- LERMAN, Z., CSAKI, C. (1998): Land Reform in Ukraine: The First Five Years, *World Bank Discussion Paper No. 371*, World Bank, Washington, D.C.
- LOKSHIN, M., YEMTSOV, R. (2001): Household Strategies for Coping with Poverty and Social Exclusion in Post-Crisis Russia, *World Bank Policy Research Paper No. 2556*, World Bank, Washington, D.C.
- OECD (1998a): *Review of Agricultural Policies: Russian Federation*, OECD, Paris.
- OECD (1998b): CEECs/NIS Agricultural Indicators Database.
- PUHACHOV, M. (1999): Appraisal of the Private Agricultural Sector, Agrarian Policy Analysis Unit, Inter-ministerial Commission for Agrarian Reform, Kyiv, Ukraine.
- RESAL (1999): Food Security Policy: Policy for Rural Land Registration, Ownership and Market, Working Paper, European Commission Food Security Programme in Georgia, Tbilisi.
- ROMANIAN MINISTRY OF AGRICULTURE AND FOOD (2000): News Bulletin 12/2000.

- SCHRIEDER, G., MUNZ, J., JEHLE, R. (2000): Rural Regional Development in Transition Economies: The Case of Romania, *Europe-Asia Studies*, Vol. 52, No. 7, pp. 1213-1236.
- SCHULTZ, T.W. (1964): *Transforming Traditional Agriculture*, Yale University Press.
- SWINNEN, J.F.M., MATHIJS, E. (1997): Agricultural Privatisation, Land Reform and Farm Restructuring in Central and Eastern Europe: A Comparative Analysis, in: SWINNEN, J.F.M., BUCKWELL, A.E., MATHIJS, E. (eds.): *Agricultural Privatisation, Land Reform and Farm Restructuring in Central and Eastern Europe*, pp. 333-373.
- TANIC, S. (2000): The Impact of Land Laws and Legal Institutions on the Development of Land Markets and Farm Restructuring in Hungary, Lithuania, Poland and Romania, in: CSAKI, C., LERMAN, Z. (eds.): *Structural Change in the Framing Sectors in Central and Eastern Europe*, *World Bank Technical Paper No. 465*, World Bank.
- THO SEETH, H., CHACHNOV, S., SURINOV, A., VON BRAUN, J. (1998): Russian Poverty: Muddling Through Economic Transition with Garden Plots, *World Development*, Vol. 26, No. 9, pp. 1611-1623.
- TSCHAJANOW, A.W. (1923): *Die Lehre von der bäuerlichen Wirtschaft, Versuch einer Familienwirtschaft im Landbau*, P. Parey Verlag.
- UKRAINIAN STATE COMMITTEE FOR STATISTICS, *STATISTICAL YEARBOOK – Various Years*, Kyiv.
- VON BRAUN, J., KENNEDY, E. (1994): *Agricultural Commercialization, Economic Development, and Nutrition*, Johns Hopkins University Press, London.
- WEHRHEIM, P., WOBST, P. (2001): Modelling Subsistence Agriculture in Russia: Effects of Total Productivity Changes and Reduction of Marketing Margins, Paper presented at the EAAE Seminar "Subsistence Agriculture in Central and Eastern Europe: How to Break the Vicious Circle?".
- WEHRHEIM, P., FROHBERG, K., SEROVA, E., VON BRAUN, J. (eds.) (2000): *Russia's Agro-food Sector: Towards Truly Functioning Markets*, Kluwer Academic Publishers, Boston.
- WORLD BANK (2000): <<http://worldbank.org/data/databytopic/keyrefs.html>>, 03.01.03.
- YANBYKH, R. (2000): Credit Markets in Rural Russia, in: WEHRHEIM, P., FROHBERG, K., SEROVA, E., VON BRAUN, J. (eds.): *Russia's Agro-food Sector: Towards Truly Functioning Markets*, Kluwer Academic Publishers, Boston.

DECISION MAKING PATTERNS OF SUBSISTENCE FARMERS IN BULGARIA

PLAMEN MISHEV, PHILIP KOSTOV¹

1 INTRODUCTION

Bulgaria began the transformation of its agricultural sector early in the reform process. The chosen path of land reform was radical and aimed at restoring the status quo enjoyed half a century ago. The outcome of this slow and complicated process was a very fragmented structure of land ownership and farming structure dominated by a large number of small private family farms.

Reforming land ownership rights to the status of fifty years ago created a dualistic farming structure of individual and commercial farms. Within the category of individual farms, there are a large number of small subsistence farms, most of which belong to elderly people. At the beginning of reform, they were considered as concomitant structures, stemming from pre-reform household plots with limited influence on the formation of the sector. However, with the prolonged land reform, missing land markets and difficult processes of creating the infrastructure of a market economy, it was realised that subsistence farming in Bulgaria was not a temporary phenomenon.

Until recently, the considerable importance of the subsistence sector, not only in Bulgaria, but also in Central and Eastern Europe in general, was neglected. This, together with the prevailing market-theory biased rhetoric of the policy makers, ensured that applied agricultural policy remained focused on the commercial agricultural sector.

However, the results of these policies over the transition period have been rather disappointing. This should indicate that the considerable relative size of subsistence agriculture exerts significant effects on agriculture overall, and can modify the impact of agricultural policy measures. Indeed, such is the

¹ The Authors are grateful to Jonathan Baron and an anonymous referee for helpful comments on earlier versions of this paper. All remaining errors are, however, our own responsibility.

conclusion of a number of quantitative simulation studies, which explicitly model the subsistence sector, collected in MERGOS (2002). The current dualistic farm structure with a few large commercial producers on the one hand and a very large number of small-scale farmers on the other hand, is generally perceived as inefficient and non-viable for a medium-term solution or even on the long run (SARRIS et al. 1999). Another important and explicitly stated aim is the claim that the major emphasis in agricultural policy during a pre-accession period should be to support the emergence of medium scale, commercially-oriented private farmers (OECD 1999).

The situation is therefore somewhat of a paradox. Subsistence farmers are unwanted guests in the agricultural policy framework in Bulgaria, as well as in other CEECs. They are nevertheless an important constraint and underlying factor in the process of agricultural development.² To put it simply, in spite of all the market economy rhetoric and the all-but-obvious reluctance to consider the problems posed by existing subsistence agriculture, it still re-emerges in the domain of agricultural policy as something to reckon with.

Research into this area has been far from satisfactory. Alongside recognition of the existing problem (SARRIS et al. 1999; KWASNIEWSKI 1999; OECD 1999), quantitative studies which model the sector are based on very different behavioural assumptions (BECKMANN and PAVEL 2000; MISHEV et al. 2002; WERHEIM and WOBST 2001) and therefore their results can be directly traced to the assumptions made. This illustrates just how little we know about the subsistence sector. Directly extrapolating results and conclusions from studies of the same phenomena in the LDCs seems rather dubious as well. In spite of their similarities, subsistence in transition countries and the same phenomenon in developing countries are dissimilar (O'BRIEN et al. 2000) and may even be driven by very different motivations (KOSTOV and LINGARD 2002).

If we want to learn something about the likely behaviour of subsistence farmers, we need to find out what their motivation consists of, how they see their situation and what alternative ways of behaviour they envisage. It is therefore necessary to step up research on the motivation of subsistence farmers and to investigate the constraints they face in order to initiate and speed up the development process. In this way, we leave the area of normative theory prescriptions, which postulate how people should behave and define them as irrational if they do not behave in the prescribed way. One of the reasons for the inconsistent results of applied agricultural policies in Bulgaria in recent years is this unfilled gap in understanding the behavioural patterns of subsistence farmers.

² OECD (1999) even used the term 'threat'.

2 METHODOLOGY

Since our aim is to study the behaviour of Bulgarian subsistence farmers, we ought to find out how they perceive the economic realities, i.e., how they 'see' the world around them. This is the main determinant for future actions. While the most widespread concept of economic rationality – the substantive one – refers to the outcome of economic action, the motivation and the feasibility of economic choices in general can only be studied using the procedural form of rationality, which refers to the 'nuts and bolts' of decision making. In studying the mechanisms of subsistence farmers' decision making processes, we need therefore to somehow describe and assess the way they perceive economic realities. The tool we employed to investigate the limits and characteristics of the subsistence type of economic behaviour in Bulgarian agriculture is the concept of mental accounting. Mental accounts were first introduced by THALER (1980, 1985), with reference to the general concept of integration. This concept refers to the influence of some outcomes on the evaluation of present decisions. The essence of mental accounts is that they are used to record gains and losses, and if information of two events is recorded in one mental account, it will be integrated in the process of decision making. This integration can be temporal and spatial. Temporal in this case means that temporally different results will be taken into consideration; spatial means the case in which different aspects of a problem are considered at the same time, or one at a time. Mental accounting is governed by the principles of categorisation (HENDERSON and PETERSON 1992). The principles of mental accounting were incorporated at a very general level in the Behavioural Life-Cycle Theory (SHEFRIN and THALER 1988, 1992). They define three main types of mental accounts to categorise monetary assets: current income, current assets and future income. These facts are assumed to have a decreasing propensity to consume in the above-mentioned order. These three main types are in fact real accounts. However, they are mentally labelled in order to demonstrate the psychological constraints that they impose on consumption. Their use can be seen as a general strategy for resolving the inconsistency between short and long-term preferences or, as it is more popular, for self-control. The latter inconsistency is a well known problem in economics. STROTZ (1956) demonstrated this problem in a dynamic context: the continuance of consumption, which is necessary for the consistency of preferences, is often violated. THALER (1981) presents further empirical evidence on this topic. Self-control strategies to solve this problem have been introduced and analysed by HOCH and LOEWENSTEIN (1991).

It is important to note that in contrast to TVERSKY and KAHNEMAN (1981), where mental accounts depend on a special case and have a specific use, the consumption of life-cycle theory done by SEFRIN and THALER (1988, 1992) are seen as more stable cognitive structures. Although not exhaustive, the above classification of monetary assets can be further developed by differentiating sub-

accounts. The self-restraining effect of the use of mental accounts is a logical expression of the development of calculation agencies. The latter point is confirmed by the stimulating analysis of ZELIZER (1998) on the evolution of money "earmarking".

3 GENERAL IMPLICATIONS OF MENTAL ACCOUNTING MODELS FOR AN AGRICULTURE IN TRANSITION

Economic transition represents a major alteration of an economic environment. It increases instability and provides for a difficult future. Considering the current income, which is the monetary element with the highest propensity to consume, the general fall in incomes under transition leads to decreasing consumption compared to the previous period. Due to egalitarian income policies in the pre-transition period and high inflation at the early stages of transition, the importance of current assets as a source of consumption declines. The future income prospects are difficult to grasp from an individual point of view in conditions of high uncertainty. In general, transition leads to decreased consumption. KOSTOV (2002) argues that the effects of high uncertainty and institutional instability accompanying transition are expressed in disintegrated social structures, including markets for agricultural products. Following the same line of argument, one could assert that since mental accounts are socially established constructs, the effects of transition processes on them will be similar. In other words, transition necessarily results in the increased segregation of categories classified in different mental accounts. With regard to consumption, the facts mentioned above cause current income, current assets and future income to become segregated. Therefore, consumption is confined mainly to current income. SELLART et al. (1997) suggested after extensive experimentation that the influence of mental accounts is directed toward buying decisions, whereas their effect on general consumption is indirect. Therefore, the mentioned study by ZELIZER (1998) provides indirect empirical support. The lower monetary propensity to consume makes small-scale farmers more orientated to self-sufficiency and dependent on household production.

The influence of uncertainty on consumption and buying decisions is twofold. First, it influences the propensity to consume. Higher uncertainty implies an urge to consume by increasing the importance of current income and belittling future income. Current assets are seen as a buffer for contingency situations and thus consumption is anchored to current income. Moreover, there are numerous institutional constraints on the use of current assets (KOSTOV 2002). Secondly, uncertainty makes it impossible for people to clarify the future, which leads to a smaller importance of future income. In other words, great uncertainty obliterates the differences between market and self-sufficiency-oriented farmers, thus acting as a driving force for agricultural de-commercialisation. Another effect of uncertainty is the higher dynamic of changes and hence increased time

pressure on decision makers. KAPLAN et al. (1993) argues that time pressure induces a shift in focusing the information processing from external to internal sources, such as stereotypes and institutions. The economic hardship of transition has led to transforming agriculture into a social buffer, which is a sector that provides some, although insufficient, income and employment. Consequently, agriculture became dominated by aged persons who are less motivated to find alternative sources of livelihood. Aged persons have stronger links to the institutions of the former planned economy and refuse to "unlearn" these stereotypes. PEJOVICH (1996) suggests that aged persons in general feel threatened by the ongoing economic changes because of the responsibility for their families which was institutionalised in Eastern European "shortage" economies. The greater conservatism of aged persons leads to increased status-quo effects (SAMUELSON and LECKHAUSEN 1988), while responsibility drives them towards escalation of their commitment to outdated stereotypes and courses of action (BROCKNER 1992). Overall, aged people are less likely to adapt to the changing environment and thus prefer to reduce their risk exposure by insulating themselves from the markets, which are more subsistence-oriented. The standard economic interpretation of the latter is the tendency of higher uncertainty to increase risk aversion. It is important to note that this conclusion about the greater subsistence orientation of aged persons is a result from the analysis of transition economies, which defines which stereotypes are activated and thus does not necessarily apply to aged persons in general.

The above discussion can lead us to formulating certain hypotheses about the behavioural characteristics of subsistence farmers. First, the degree of perceived uncertainty has an impact on the degree of commercialisation of agricultural activities. Suitable measures of perceived uncertainty could be (the instability of) agricultural prices, unclear property rights and problems in market access. The age structure of subsistence farmers could also define their choices. The latter can be investigated by 'mapping' the perceived problems and relating them to age characteristics.

4 DATA DESCRIPTION

The data were collected in the framework of the Study of Urban and Peri-Urban Agriculture (SUAPUA) Copernicus project, executed in 2000-2001. The study was done in two regions – around Sofia and Troyan. Sofia is the capital and biggest city of Bulgaria, with a population of over 1 million. It is also the major market for agricultural food products. Troyan is a small town (population 25,260) in the Northwest of the country. It was selected as a representative and typical town for Bulgarian conditions due its geographic location, size, traditional activities and scale of agricultural production. The unemployment rate in Troyan is 11.6% and more than 14% of the population is over 60 years of

age. About 80% of the houses have their own yards³, which are intensively used for agricultural production for family needs. Farming activities are not the basic occupation of the inhabitants; usually they have another job and can only add to their income with the production from the yards.

In the Sofia region 80 farmers were interviewed in the recreation zones around the city and in all nearby villages. In Troyan, 68 interviews were carried out in the town and all surrounding villages. The interviews were conducted systematically. In each village the interviewees were chosen in the following way: from households located on the left- hand side, on first and/or second cross-roads, when looking to the South of the center on the main street of the settlement. Interviews were done with non-farmers, farmers representing successful and unsuccessful examples of economic development and also different types of farming. Semi-structured interviews were carried out, with a formal questionnaire followed by an informal discussion on the issues of agricultural production. Those interviewed were allowed to choose one of the available options in the questionnaire as a first choice and another as a second choice, according to their opinion on the prominence of these. A pilot survey, consisting of only a questionnaire, was used for formulating an appropriate hypothesis about the structure of mental accounts of the interviewed farmers. The latter has been investigated using informal interviews carried out during the main study.

The questionnaires consisted of a socio-demographic part which included questions about the type of household, education, length of residence in the area, main occupation, age, etc., and a part concerned with agricultural production issues. The socio-demographic information was used as an additional check for representativeness of the sample when compared to the characteristics of the region. It was also used in preparing for the informal interviews; potential points of contention with regard to the preliminary hypotheses about the mental accounts structure of the respondents were identified. The part concerned with agricultural production contained questions about the aims of agricultural production, marketing channels, future production plans, intentions regarding financial loans and likely use of the latter, as well as perceived problems related to agricultural production which are discussed below. Other questions that were not explicitly included in the discussion collected data about the type of products, size of the plots, intensity of use of production factors (labour, fertilizers, machinery), use of land quality maintenance practices, water conservation measures and other production characteristics.

³ A plot of land adjoining the property.

5 DISCUSSION OF THE RESULTS

The questions about the primary aim of household production formally included the provision of food for own consumption and its role as a source of income and employment. These two survey elements are clearly related. They were stated by most of the respondents and were chosen by 62% and 21%, respectively, of those interviewed in the Sofia region and 80% and 15% in the region of Troyan. Additionally, they were selected by a further 22% and 26% in the Sofia region and by 10% in both groups in the Troyan region as a second reason for practicing agricultural activities. The latter shows that most subsistence farmers are driven by one of these two motives. However, both can be expressed in terms of income. Employment is a source of income, because producing own food saves income that can be spent on additional needs. However, one could assume that the distinguishing mark between these two options shows the mental constructs employed by the interviewed subsistence farmers.

Emphasising the food aspect, results reveal a mainly subsistence orientation (the need to feed one's self), whereas focusing on income, a market orientation is demonstrated (money will be obtained by this). Moreover, detailed discussion with some of those interviewed revealed that they do not perceive the consumption of own production as an income. The latter refers to the elicitation of stereotypes. Their typical answer to the conventional opportunity costs argument was to state that this is their reference situation. To put it simply, they regard producing as the benchmark situation with which the other alternatives have to be compared. Owing to this, they do not perceive consumption of own production as an income element and consequently segregate it from the income elements of their mental accounts. Only monetary income, that is, the return from sold agricultural produce, is viewed as income from their point of view. When challenged with the example that if they were not producing they would require the monetary means to purchase these products, they either explicitly stated "What else can we do?" or declared that if they were not producing it, they would not consume it at all, thus demonstrating once again the mentioned segregation.

Regarding the above-mentioned facts, one could conclude that current small-scale farmers in Bulgaria are more subsistence- than market-oriented. Moreover, this subsistence orientation seems to be prevalent in typical rural areas rather than in suburban areas. This is in accordance with the general picture presented in MISHEV and KOSTOV (2000), but contradicts the suggestions of KOSTOV and LINGARD (2002) and the detailed analysis of KOSTOV (2001) about the primary market orientation of subsistence farmers in Bulgaria. However, there is no contradiction. KOSTOV (2001) (implicitly) and KOSTOV and LINGARD (2002) (explicitly) speak about forward-looking orientation. The latter is prone to

realisation only if the whole production process, from the planning of production to its sale, is integrated over time.

Owing to the high uncertainty, however, small-scale farmers tend to temporally segregate production and marketing, which results in the current subsistence agriculture (KOSTOV 2002). Therefore, this segregation introduces a bias in interpretation of the question "Why do you produce". In the mental categories which are in the mental accounts held by subsistence farmers', production and marketing are segregated.

Additionally, it is well known that people often cannot objectively express their opinion in a direct way. There is vast marketing and psychological literature on this topic. The answer of the question "Why do you produce" involves elicitation of the current situation and evokes memories of the most recent past outcomes which are subsequently integrated in returning a verdict. The answers show mainly subsistence orientation due to the recent emergence and expansion of subsistence agriculture and disintegration of agricultural markets. The higher market orientation in the suburban area of Sofia simply reflects the better market opportunities in the local market. The markets of agricultural products in transition countries are predominantly local. A more appropriate way of inferring the true orientation of subsistence farmers would have been to ask them a question like "If you have an offer for a given product at price X, how much would you sell?"

To confirm the role of the market access, 43% of the respondents in the Sofia area use the central market, 29% sell to relatives and friends and 29% sell directly from the plot or on local markets.⁴ No one uses middlemen. On the other hand, in the area of Troyan, about 1/3 of those who provided an answer to this question claimed to sell to middlemen. Furthermore, the sale to relatives and neighbours is possible only in the area of Sofia, where people who do not practice agricultural activities also live. Overall, in rural areas the main reason for the statistical results showing greater subsistence orientation is restricted market access and the smaller local market.

The access to healthier and safer food as a motive for production was selected by 7% of the Sofia sample as a first choice, and by 30% of the Troyan sample as a second choice. The higher percentage in rural areas may seem surprising at first sight. However, this answer can be interpreted as a preference of own produced food compared to purchasing products. The formation of this preference is probably an outcome of psychological differentiation and consolidation processes (SVENSON 1992) accompanying the recent expansion of subsistence agriculture and, as such, it is better expressed in rural areas. The ranking of this motive in first place by some respondents in the Sofia sample

⁴ Percentages sum exceeds 100% because some farmers use more than one channel for distribution.

may reflect to a certain degree a genuine concern about the quality of the food available on the market. However, the effects of the above-mentioned preference for the behaviour of subsistence farmers is considerable. It denotes a segregation of own production and market food. Simply said, if one produces a certain product, he/she normally would not buy the same product on the market.

This can be confirmed by the elasticity calculations of MISHEV et al. (1996). KOSTOV (2001) provides further quantitative support for this argument, claiming that eggs are probably the only exception. The formed preference for own production provides sufficient differentiation in terms of mental constructs between them and the equivalent products available on the market. Consequently, they are categorised in different mental accounts. However, the latter cannot fully explain why people would not buy the same product as he/she is producing. We found that the purchase of inputs and the sale of own production are positively correlated. However, the sale of agricultural products not only provides financial funds for organising production, it also allows other food to be substituted for products produced in household. A reasonable question would be whether this substitution is feasible the other way around.

The land in our sample has been used very intensively and subsistence farmers produced significant output per unit of land area. Furthermore, a very common perceived problem is the poor soil quality; this was indicated by 20% of the interviewed farmers in the Sofia area and over 58% of them in the Troyan area. This confirms the conclusion of MISHEV et al. (1998) that subsistence agriculture has restricted growth potential. The highest importance for future production was attributed to children – 23% of the overall sample. This percentage may seem low, because less than half of the interviewed answered this question. Since children have been a source of labour for the household farm, "labour capital" (O'BRIEN et al. 2000), the latter shows that subsistence farmers are feeling the pressure of restriction on growth. Therefore, the substitution of own production for purchased food is not feasible under present conditions. Regarding the possible substitution effects, subsistence plays an important role for income and is seen as such. The limits of subsistence types of economic behaviour have been virtually reached and the only change that could be induced is the commercialisation of agriculture.

Regarding subsistence mainly as an income supporting activity raises questions about the future. It suggests that market access and the size of markets for agricultural products play a crucial role in transforming subsistence agriculture (KOSTOV and LINGARD 2000). The present structure of differentiation of consumer goods in the mental accounts, employed by small scale farmers, interferes the commercialisation opportunities (KOSTOV 2002). Therefore, a successful strategy to transform current subsistence agriculture should apply a combination of market promotion and income creating measures.

Farmers' expectations would play an important role in initiating change. Next we review the answers provided to some questions that indirectly reveal farmers' expectations and attitudes.

Asked about future production plans, the majority of farmers (between 60% and 80% for the different subgroups) declared that they do not intend to change their volume of production. Those who did intend to increase production were approximately the same number as those who wanted to decrease or even quit production. The only exception to the above-mentioned results are the owners of temporary houses around Sofia, where only 10% intended to increase, while 40% intended to decrease their production. The willingness to increase production suggests a market orientation for the rural residents, although it can have different reasons for the non-residents. The decision to keep the same level of production may be a strategy of waiting (KOSTOV 2001). We do not reject other explanations for the above shown result, but since most of the farmers have asserted it, the waiting strategy seems convincing: it could increase the adaptive abilities of subsistence farmers to future changes by preserving their production potential.

Another question related to farmers' intention regards whether they would take a loan. Most of them expressed their reluctance to take loans. The only type of credits they were interested in was preferential ones. It would be misleading to treat the above given answer as a typical subsistence orientation. The interest in preferential credits shows that the terms of a loan are very important. Depressed agricultural prices restrict marketing opportunities and hence subsistence farmers do not see any reason to expand their production. However, their intention to remain at the same level demonstrates that they are ready to react to favourable circumstances. In order to get further information, farmers were asked to state the most likely way they would utilise credit resources. The answers may be summarised as equipment and improvements on existing agricultural buildings. This reflects the cautious approach to extending production. Since previous losses, which reflect outcomes that are integrated in the decision making process, lead to risk averse behaviour, it is clear that the strategy of waiting and uneasiness toward credits is an expression of such behavioural changes. The profitability of agricultural production is thus an important prerequisite for changing this situation.

Risk attitudes and market expectations are significant factors influencing the inter-temporal substitution of one type of specific capital for another (KOSTOV 2002); in other words, the substitution of future income for current assets. In fact, high uncertainty and the discounting factor prevent it. Another constraint to take credits is that in Bulgaria land currently cannot be used for collateral. Land is a natural candidate to serve as collateral for agricultural credits, since it is integrated with agricultural production in a sense that they are kept in similar mental accounts. Concerns about the quality of land are a confirmation of the

latter. The use of other current assets for collateral may be prevented by the structure of the employed mental accounts. KOSTOV (2002) lists certain conditions which could allow for the elimination of some of these restrictions, including general stability and opportunities in the area of primal asset use.

The degree of production and marketing segregation is a reliable indicator for the underlying commercial or subsistence orientation. In this respect, the structure of the perceived problems provides valuable information. Except the mentioned facts about soil quality, the following, more important problems have been listed by the interviewed farmers in the Sofia area: lack of labour and time (20%), thefts (20%), lack of capital (19%), insufficient market opportunities or low prices (18%), lack of technical information and advice (4%). On the other hand, in the area of Troyan, the main problems were: lack of inputs (40%), lack of capital (33%), insufficient market opportunities or low prices (28%), lack of technical information and advice (25%), lack of transport (25%). Taking into consideration that the area of Troyan is more rural, the differences in farmers' perceptions are crucially significant. In the latter sub-sample, one could see that the presence of problems that reveal market orientation is considerable. The lack of transport is one of these problems. Also in the Troyan area, the perception of common problems as market opportunities was considerably greater than in the Sofia area. The difference in the perception of capital and technical information also demonstrates the more commercial orientation of the farmers in the Troyan area. Capital and technical information are factors which influence employed technology, and changes in technology are related to greater market orientation. On the other hand, the lack of labour resources and time presumes unchanging technology and thus more of a subsistence orientation. The problem of theft in agricultural production leads to more risk averse and hence more subsistence-oriented behaviour.

6 CONCLUSIONS

Young people are currently reluctant to get involved in agriculture. This is a consequence of their longer planning horizon. They do not see a future in agriculture due to unfavourable market conditions. It was suggested that any successful agricultural commercialisation strategy should involve measures aimed both at increasing market opportunities and creating additional income sources. However, the latter can divert young people who could benefit from the additional income opportunities instead of entering agriculture. The extent to which this could happen depends, of course, on the balance of stimuli and the sequence of changes. However, commercialising agriculture means that in general there will be a free labour force to compete for non-agricultural jobs. Younger people are more likely to be successful in this competition. Regarding this, we could expect that even in future, agriculture would be dominated by aged persons.

Nevertheless, agricultural commercialisation and general income increase should drive out the elder farmers, who are currently striving to survive on their subsistence farm and thus would decrease the average farmers' age from its current level of around 62 years (SARRIS et al. 1999). For example, if the rent for agricultural land is sufficiently high (as a function of agricultural profitability) pensioners may be tempted to exit. The general demographic trend of an ageing population and the lower chances of exit to other jobs compared to younger persons, however, seem to tie aged persons to agriculture. Their commitment to agriculture is higher and hence they are more likely to launch the revival of agriculture. Production requires experience, and marketing products depends on network contacts. Both are more likely to be found with aged persons than in the younger generation.

The choices that subsistence farmers face in transition economies are defined by the unstable economic situation characterised by underdeveloped institutions and a generally high level of uncertainty. In this situation, subsistence agriculture does not contradict economic rationality. KOSTOV and LINGARD (2000) demonstrate that the existence of subsistence agriculture can lead to Pareto improvements at the aggregated level. In the terminology of New Institutional Economics, economic transition induces increases in transaction costs. The latter have substantial impact on economic decisions. Since transaction costs depend on the existing institutional structure, institutional developments are the key to agricultural commercialisation. A view of institutional change is necessarily dynamic. We have used the mental accounts methodology to clarify some categories employed by Bulgarian subsistence farmers. The use of certain categories instead of others channels the way of thinking, which represents the "theoretical" views of decision makers.

The use of the categories "supply", "demand" and "equilibrium" in economics, and the links among them, is an example of the way economic theory is structured. Similarly, in the case of subsistence farmers the structure of their categorical frameworks, that is, the system of mental accounts they employ, defines their choices.

Investigating the structure of mental accounts, and particularly the degrees of integration and segregation, helps us to identify the boundaries of their economic behaviour. In a certain sense, this is a use of the concept of bounded rationality. Unrestricted economic rationality refers to a situation in which all mental accounts are fully integrated across time and space. Since the latter is impossible, segregation imposes certain restrictions. The type of economic behaviour that results is evidently inconsistent with the postulates of economic orthodoxy. For example, preferential ordering in a system of mental accounts that is not fully integrated can be only partial. With partial instead of full preferential orderings, however, economic behaviour may be inconsistent. Explaining the foundations of the economic behaviour of subsistence farmers

can identify their likely response to agricultural policies and the needed measures to introduce the required institutional changes.

We would like to stress that institutional changes are not only changes in legislation and organisational structure of the economy, but also changes in the relevant rules and routines of economic behaviour. It is true that legislation and organisational structure influence the process of formation of these rules. Nevertheless, they do not "create" these rules. The farmers will only adopt such rules that are consistent with their views, which means with their mental accounts.

REFERENCES

- BECKMANN, V., PAVEL, F. (2000): The Logic and Future of Subsistence Farming in Transition Economies: The Case of Bulgaria, 70th EAAE Seminar "Problems and Prospects of Balkan Agriculture in Restructuring Environment", June 9-11, 2000.
- BROCKNER, J. (1992): The Escalation of Commitment to a Failing Course of Action: Toward a Theoretical Progress, *Academy of Management Review*, Vol. 12, pp. 39-61.
- HENDERSON, P., PETERSON, P. (1992): Mental Accounting and Categorisation, *Organisational Behaviour and Human Decision Processes*, Vol. 51, pp. 92-117.
- HOCH, S.J., LOEWENSTEIN, G.F. (1991): Time-inconsistent Preferences and Consumer Self-control, *Journal of Consumer Research*, Vol. 17, pp. 492-507.
- KAPLAN, M.F., WANSULA, L.T., LANNA, M.P. (1993): Time Pressure and Information Integration in Social Judgement, in: SVENSON, O., MAULE, A.J. (eds.): Time Pressure and Stress in Human Judgement and Decision Making, Plenum, New York.
- KEY, N., SADOULET, E., DE JANVRY, A. (2000): Transaction Costs and Agricultural Supply Response, *American Journal of Agricultural Economics*, Vol. 82, No. 2, pp. 245-259.
- KOSTOV, P. (2002): Transition, Agricultural Decommmercialisation and their Implications for Quantitative Modelling, ACE Discussion Paper Series, Phare ACE, Brussels.
- KOSTOV, P. (2001): Assessing and Measuring the Importance of Small-scale Subsistence Farming in Bulgarian Agriculture, Unpublished PhD Thesis, Dept. of Agricultural Economics and Food Marketing, University of Newcastle.
- KOSTOV, P., LINGARD, J. (2000): Modelling the Effects of Subsistence on Bulgarian Agricultural Performance, AES Annual Conference, Manchester.
- KOSTOV, P., LINGARD, J. (2002): Subsistence Farming in Transitional Economies: Lessons from Bulgaria, *Journal of Rural Studies*, Vol. 18, No. 1, pp. 83-94.
- MERGOS, G. (ed.) (2002): EU Enlargement and the CAP. A Quantitative Analysis for Slovenia and Bulgaria, Wissenschaftsverlag Vauk, Kiel.
- MISHEV, P., IVANOVA, N., KOSTOV, P. (2002): Agricultural Policy Options Distinguishing a Subsistence Subsector in Bulgaria, in: MERGOS, G. (ed.): EU Enlargement and the CAP. A Quantitative Analysis for Slovenia and Bulgaria, Wissenschaftsverlag Vauk, Kiel, pp. 135-170.

- MISHEV, P., KOSTOV, P. (2000): Subsistence Farming in Bulgaria – Trends and Prospects, Scientific Conference "Subsistence Production in Central and Eastern Europe", 7th East-West Agricultural Forum, Berlin.
- MISHEV, P., TZONEVA, M., IVANOVA, N. (1998): Food Demand in Bulgaria over the Transition Period, in: MERGOS G. (ed.): Agricultural Price Reform under Transition in Bulgaria, Romania, and Slovenia, *Options Mediterraneennes, Serie B, No. 22*, pp. 109-119.
- MISHEV, P., TZONEVA, M., IVANOVA, N. (1998): The Supply Response of Bulgarian Agriculture over the Transition Period, in: MERGOS G. (ed.): Agricultural Price Reform under Transition in Bulgaria, Romania, and Slovenia, *Options Mediterraneennes, Serie B, No. 22*, pp. 147-154.
- O'BRIEN, D.J., PATSIORKOVSKI, V.V., DERSHEM, L.D. (2000): Household Capital and the Agrarian Problem in Russia, Ashgate, Aldershot.
- OECD (1999): Agricultural Policies in Emerging and Transition Economies, Paris.
- PEJOVICH, S. (1996): The Market for Institutions Versus the Strong Hand of the State: The Case of Eastern Europe, in: DALLAGO, B., MITTONE, L. (eds.): Economic Institutions and Competition: Centralisation and Decentralisation in the Transformation of Economic Systems, Edward Elgar, Cheltenham, pp. 111-125.
- SELLART, M., KARLSSON, N., GÄRLING, T. (1997): Self-control and Loss Aversion in Intertemporal Choice, *Journal of Socio-Economics, Vol. 26*, pp. 513-524.
- SHEFRIN, H., THALER, R. (1988): The Behavioural Life-cycle Hypothesis, *Economic Inquiry, Vol. 26*, pp. 609-643.
- SHEFRIN, H., THALER, R. (1992): Mental Accounting, Saving and Self-control, in: LOEWENSTEIN, G., ELSTER, J. (eds.): Choice over Time, Russell Sage Foundation, New York, pp. 287-330.
- SAMUELSON, W., LECKHAUSEN, R. (1988): Status Quo Bias in Decision Making, *Journal of Risk and Uncertainty, Vol. 1*, pp. 7-59.
- STROTZ, R.H. (1956): Myopia and Inconsistency in Dynamic Utility Maximisation, *Review of Economic Studies, Vol. 23*, pp. 165-180.
- SVENSON, O. (1992): Differentiation and Consolidation Theory of Human Decision Making: A Frame of Reference for the Study of Pre- and Post-decision Processes, *Acta Psychologica, Vol. 80*, pp. 143-168.
- THALER, R.H. (1980): Toward a Positive Theory of Consumer Choice, *Journal of Economic Behavior and Organisation, Vol. 1*, pp. 39-60.
- THALER, R.H. (1981): Some Empirical Evidence on Dynamic Inconsistency, *Economic Letters, Vol. 8*, pp. 201-207.
- THALER, R.H. (1985): Mental Accounting and Consumer Choice, *Marketing Science, Vol. 4*, pp. 199-214.
- TVERSKY, A., KAHNEMAN, D. (1981): The Framing of Decisions and the Psychology of Choice, *Science, Vol. 211*, pp. 453-458.
- WERHEIM, P., WOBST, P. (2001): Modelling Subsistence Agriculture in Russia: Effects of Total Productivity Changes and Reduction of Marketing Margins, 73rd EAAE Seminar "Subsistence Agriculture in Central and Eastern Europe: How to Break the Vicious Circle?", Halle (Saale), May 6-8, 2001.

ZELIZER, V.A. (1998): The Proliferation of Social Currencies, in: CALLON, M. (ed.): *The Laws of the Markets*, Blackwell Publishers, Oxford, pp. 58-68.

COMMERCIALISATION OF SUBSISTENCE AGRICULTURE IN TRANSITION ECONOMIES: ON IMPERFECT COMPETITION, MARKET DEVELOPMENT AND SUPPORT POLICIES

ERNST-AUGUST NUPPENAU

1 INTRODUCTION

From the point of view of promises made ten years ago, the transition of the food sector of many Central and Eastern European Countries (CEECs) is considered weak and somehow disappointing (MACOURS and SWINNEN 2000). The development of the agricultural sector as the domestic raw material producer for food processing is hampered by a syndrome of weak market development and increased subsistence production. Many reasons for this development are put forward. In essence, a vicious cycle of structural deficits that consist of a limited number of emerging new farms on one hand and limited marketing opportunities on the other has been identified as a major reason (SARRIS et al. 1999). This development expresses itself in an even more noticeable duality of the farm sector; few emerging small-scale farms compete with many persistent, large-scale, bankrupt farms (most noticeable in former Commonwealth of Independent States (CIS) countries), and subsistence farming is on the rise. In particular, the share of the small-scale subsistence farm sector in agricultural production, land occupation and labour allocation has increased considerably in many countries. For example, in Russia potatoes are now produced by 90% of household subsistence plots (1996) compared to 61% before transition (1985; CASKIE 2000). Similar observations are made in meat production (51% in 1996 and 26% in 1985; CASKIE 2000). Even aside from extreme cases such as Russia, farmers are reorienting themselves towards subsistence production. For instance, in Romania and Bulgaria, where farms have emerged from land privatisation, they tend to continue subsistence farming (SARRIS et al. 1999).

These observations are contrary to expectations that existed at the beginning of transition. It was expected that market development, even in the short run, would lead to many prosperous medium-scale, commercially-oriented farms which would become increasingly efficient over time. It was also expected that farms would invest in modern technology and accumulate capital and land; thus out-migration from rural areas could be stopped because new farms could provide jobs, income and food security improvements, etc. Instead, the number of new farms that are today commercially-oriented and produce marketed surpluses is stagnant (SEROVA 2000). This phenomenon is not only confined to countries that lag behind in privatisation. Rather, the agricultural sector of most CEEC countries, for instance Estonia, (KIVISTIK 2000), that have undergone institutional changes such as full privatisation and redistribution of land, face similar problems in developing the agricultural sector. It appears much more difficult to achieve efficient farm structures than expected from liberalisation. Even defining what is efficient is an emerging problem, because efficiency might strongly depend on structural factors.

There seems to be even more problems involved in market development and transition of the whole food sector. Transition from a formerly state-controlled to a viable private farm sector in CEECs is no independent process. Policies involved cannot simply focus on a single aspect such as land redistribution and wait for results; integrated policies might be more fruitful. What is missing is an investigation into the links between market development, the potential for market driven restructuring of the agricultural and food processing sectors, and integrated policies (LYONS et al. 1998; YASTREBOVA 2000). It is the objective of this paper to contribute to the debate by developing a model that reconsiders market imperfections, development needs, and the restructuring of the agricultural sector.

In the model we will analyse the following aspects: First, we look into economic conditions that influence households to become subsistence farmers. In particular, we will touch on high transaction and processing costs in the food processing sector of CEECs. High transaction costs result in low sales prices and high food prices, encouraging home production and processing. Home production is recursively labour demanding and hence labour market opportunities need to be considered. Second, with respect to subsistence labour, we will look at "off-farm" employment on large farms that can locally exercise market power in wage determination. We hypothesise that low wages have forced households into subsistence farming. Third, in the model, potential land title transfers from the "old", large-scale sector (already privatised) to an emerging small-scale farm sector will depict commercialisation (we distinguish commercialisation from privatisation). Fourth, this transformation is driven by government investment in technology and knowledge on farming which is

injected into emerging farms. Knowledge acquisition is enabled by extension and access to reasonably priced inputs.

Fifth, since food prices play a key role, we investigate the potential of cost reduction in the processing sector as a result of less market imperfections and a reduction in processing costs. In this context, the model portrays the imperfect competition between a large-scale, dominant firm (CARLTON and PERLOFF 1994) that has access to foreign capital and can therefore exploit economies of scale, and small-scale processors that are residual suppliers of food (LYONS et al. 1998). Small-scale processors are limited in development but might play an important role in closing the gap between local raw product demand and processed product supply. To obtain locally low food prices is an intermediate objective. Finally, the government is modelled as a key player that can use extension services, taxes for various sectors, and subsidies as instruments to encourage dynamic behaviour. Apparently, investments by a dominant processor shall result in the growth of a commercially-oriented medium-scale farm sector, because processing creates a demand for raw products. There seems to be a role for the government and it is the objective of the paper to provide arguments for beneficiary government intervention in case of a vicious cycle. The question is whether this government is benevolent or subject to lobbying? In the paper, the suggested policy will be a mix of a welfare maximising, social cost-benefit analysis-oriented government and a government that is subject to political influence facing constraints in finance. The analysis will include urban consumers that live close to rural areas and are interested in low food prices. The relevant market shall essentially be defined by the dominant firm that serves local food consumption and might also be a foreign direct investing firm.

The paper is organised in five sections. After this brief introduction (section 1), we discuss the problem of subsistence orientation in section 2. In section 3 we provide objective functions for various players. In section 4 balances between players (sectors) are introduced and dynamic conditions for policy are outlined. Then, in section 5, we will present a dynamic model of policy descriptions. This model can serve as a benchmark or reference for actual policies.

2 SUBSISTENCE ORIENTATION, DIVISION OF LABOUR AND PERFORMANCE MEASUREMENT

Optimal resource allocation between different user categories is an important criterion for determining the economic performance and efficiency of the food chain. The general perspective of neo-classical economic theory is that the market allocates resources between sectors and even within sectors, i.e., the market allocates people or working hours to enterprises and creates employment opportunities on the basis of wage differentials. Where labour is mobile and looks for the highest wages, market allocation results in the best allocation of the scarce human labour resource. This can lead to migration between the farm and

the industrial sectors, as well as to migration between rural and urban areas. Weak points in this theory are economies of scale, imperfect competition and information deficits on returns of various job opportunities that may lead to short term allocation deficits. In the long term, provided liberal institutions exist, competition will solve all allocation problems and no government intervention is needed (sic!). However, the crucial question is whether the tendency of agricultural labour to enter subsistence agriculture (for instance, described in Russia by SURINOV and SHASHNOV 2000) can be fully appreciated by this theory and whether subsistence agriculture is really a good solution. For instance, one question is what determines transaction costs, which are not considered in the narrow version of that theory. But for the moment fundamental questions are excluded; nevertheless, they should be kept in mind for further evaluation of the food chain at a later stage of the conceptual development. In the beginning, we should focus on labour mobility. We assume that, in the current stage of development in many transition economies, an increase in subsistence farming means low returns on labour, which results in less labour for surplus farming, less labour for the processing sector and less labour migrating to other sectors of the economy. Labour reallocation takes place over time. Hence the intended model is dynamic and explicitly reckons labour reallocation over time. In the short run, the various actors (Figure 1) are subsistence farmers, emerging commercial farmers, large-scale farms, small-scale processors, the rest of the economy, etc. Subsistence farmers are labour constrained. Since it is intended to model labour movement as being explicitly driven by the decision making of the large-scale sector, a dominant firm and emerging commercial farms, and as determined by costs of migration, the processing margin for food, food and raw product prices determine labour transfer.

Also, from a dynamic perspective land allocation is a crucial factor. In the given version, land is with the large-scale sector (privatisation has been in favour of large-scale farming). In the short, run emerging small-scale farmers are land constrained; only in a medium term perspective will land be reallocated from the large-scale sector to an emerging small-scale sector (CIS-countries). It will be transferred according to transaction costs imposed by the government, anticipated returns of the sectors and determined by sales opportunities (Figure 1). In an alternative version, after slight changes, the model can also be redesigned for a land transfer from the subsistence sector to the emerging commercial small-scale sector (privatisation in favour of small-scale subsistence farms). Depending on the initial distribution of land, the model structure is flexible in describing reallocation processes, as only slight changes are needed.

Figure 1: Links and Mechanisms to Reverse the Vicious Cycle of Subsistence Farming

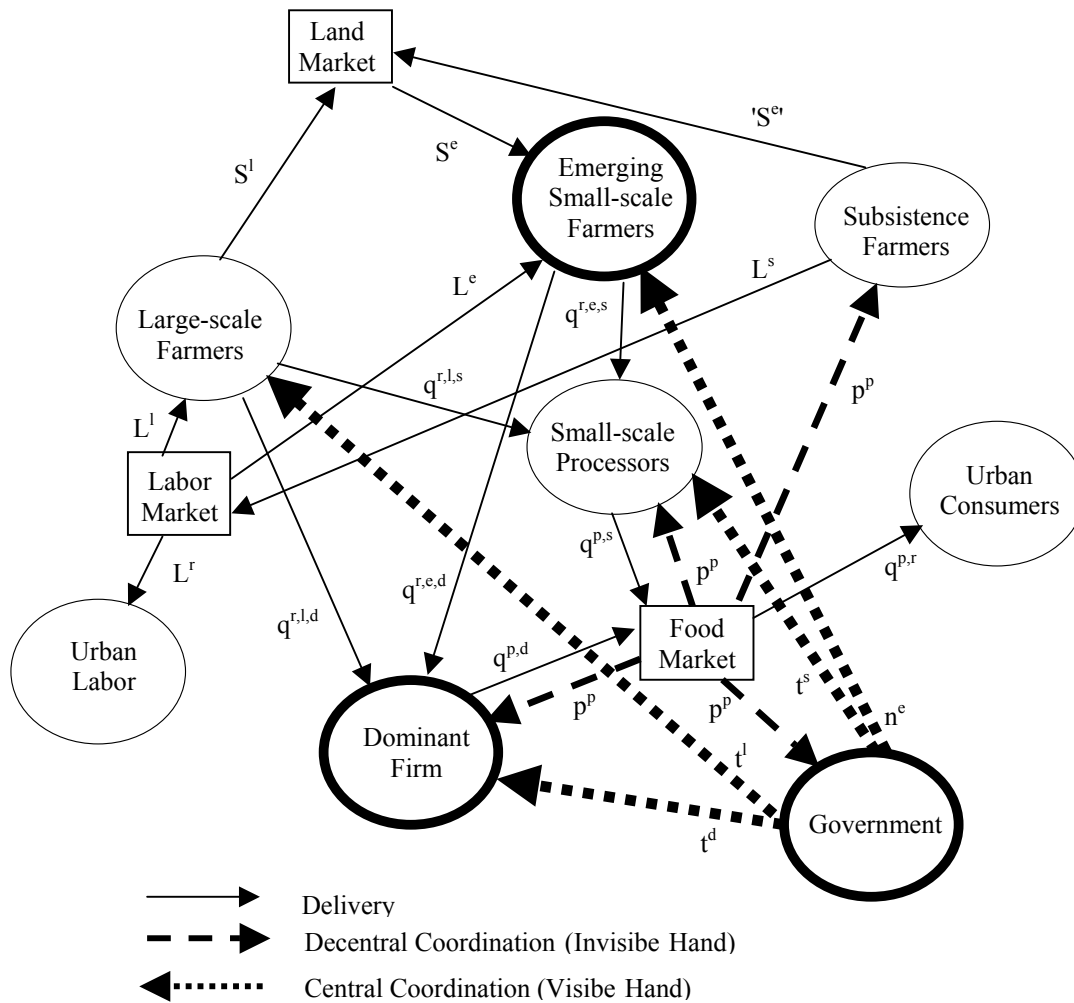

Notes: With structural inputs:
 S^l : Land from large-scale farms.
 S^e : Land to emerging small farms.
 $'S^{e'}$: Potential land from subsistence farms.
 L^l : Labour to large-scale farms.
 L^s : Labour from subsistence farms.
 L^e : Labour to emerging farms.
 L^r : Labour to rest of the economy.

With prices:
 p^p : Price of processed food.
 p^r : Price of raw material (corresponds to the delivery on raw products).

And quantities: from...product to...user:
 $q^{r,l,d}$: Raw from large to dominant.
 $q^{r,l,s}$: Raw from large to processor.
 $q^{r,e,d}$: Raw from emerging to dominant.
 $q^{r,e,s}$: Raw from emerging to processor.
 $q^{p,r}$: Processed to urban, etc.
 $q^{p,d}$: Processed from dominant to market.
 $q^{p,s}$: Processed from small to market.

And with instruments:
 n^e : Extension; knowledge on farming.
 t^l : Taxing of large-scale farms.
 t^s : Taxing of small-scale processors.
 t^d : Subsidy for investment of firms.

Source: Own design.

In the next step labour reallocation (by migration) determines demand for processed food in rural and urban areas. By definition, subsistence farms do not buy processed food, whereas the volume of sales of the food processing industry is determined by the division of labour. This aspect of an anticipation of increased market volumes for food drives the demand side. This is crucial for the presented analysis and offers dynamic aspects that go beyond a static neo-classical analysis. It is suggested that a large-scale investor in food processing (a new dairy factory, a slaughter house, etc.) make his investment decisions depending on sales forecasts. The investor (mostly a foreign investor or joint venture conglomerate; LYONS et al. 1998) considers himself as a dominant firm and calculates sales volumes as estimated on per head consumption multiplied by the population to be reached, minus residual supply from small-scale vendors. The procurement is given by land allocation and availability of raw material.

In essence, a dual market structure emerges in which the dominant firm sets prices, considering own sales as a residual of small-scale processing or local home production. In contrast, eventual supplementary purchases of subsistence farmers increase the market. Currently, increasing subsistence agriculture has three "negative" effects: First, consumers that otherwise demand "industrially processed" food are missing (and vice versa, an increased division of labour reduces the volume of home produced substitutes as well as the commercial success of a dominant firm which is dependent on large volumes of food sales). Second, more labourers in subsistence agriculture creates shortages in the work force of commercially-oriented farms. Converting the current contraction of commercial labour markets into a new commercialisation will create multiple dividends for both sectors, the processing industry and in subsistence-caught small farmers. Third, a low exploitation of economies of scale results in high food margins and subsistence is therefore preferable. Declining average costs in processing are an intermediary objective and an indicator of success.

The question is if we have a concept for reversal? Such a concept can be observed in Figure 1. Also, from a modelling point of view, a dynamic model should result in positive multipliers. Hence, Figure 1 provides arguments for multipliers. It must be noticed that the interaction of indicators for market development as used by the various actors in transition creates a positive self-enforcing cycle. Hence, we will consider commercialisation of agriculture and food processing as a dynamic game involving strategic interactions. We will show how interdependent and sequenced decision-making allows to investigate the necessary behaviour of participants. We will focus on investment decisions of the processing industry to capture benefits from economies of scale. Moreover, since it is a dynamic game, short term benefits from increasing the market volume of the dominant firm will result in long term societal benefits. Since competition from small vendors will partly guarantee a competitive

environment, this will bring margins down, so that finally less subsistence agriculture will occur.

In this dynamic game the government will be assigned the role of a promoter of technology for commercial farmers, a promoter of competitiveness for small-scale vendors and a promoter of investments for large-scale processing firms. Any government activity should be grounded in a cost-benefit analysis of the government. Moreover, to make it a game that is analytically accessible, we have to decide on sequencing and to qualify what behavioural equations are inputs for superior decision-making. First, on sequencing we start with modelling subsistence behaviour. Second, temporal decision-making of large farm operations will provide the ground for joint interaction on labour and land markets. Third, we will look into the small-scale processors' short-term decision-making. Fourth, the dominant firm decision-making on investment will provide necessary investment dynamics. Altogether, resulting residual behavioural equations are used to show how a government can build a policy for promoting commercialisation and market development. Note that government decisions are dependent on the correct anticipation of effects which result from incentives. The government also anticipates potential developments of the non-agricultural sector as a reference for internal decision making. It should be further noted that it is crucial to decide on a relevant objective function of the government: Will it be a benevolent dictator or a partial government favouring vested interests?

3 BEHAVIOUR AND OBJECTIVE FUNCTIONS

To ground the government's objective function on individual objective and interest functions, we will outline the relationship between involved parties (structure), their objective functions (performance) and behavioural equations (conduct) and adjust it to parties that are not active players. Some are incentive takers rather than incentive providers. Primarily subsistence households, small-scale vendors and the rest of the economy are modelled in this second step.

3.1 Household Food Production and the Large-scale Sector

The subsistence-oriented household food production sector (briefly, the subsistence sector) produces most of its food on its own (by definition), but subsistence is only an orientation. This means that lower processed food prices will impose a redirection towards the reduction of subsistence crop production, and subsistence farmers will engage more in labour and food markets.

$$\begin{aligned}
 & V^s(p^p, p^x, w^l L^l, w^r, [L^{s,*} - L^r(w^r) - L^l]) = \\
 (3.1) \quad & \gamma_{110} p^p + \gamma_{120} p^x + \gamma_{130} [w^l L^l] + \gamma_{140} [L^{s,*} - L^r(w^r) - L^l]^2 + .5\gamma_{111} p^p{}^2, \\
 & + \gamma_{121} p^p [w^l L^l] + \gamma_{122} p^p [L^{s,*} - L^r(w^r) - L^l] + \gamma_{123} p^x L^l + \gamma_{214} w^r L^l
 \end{aligned}$$

whereas: $p^p(t)$: Price of processed food,
 $p^x(t)$: Price of other commodities,
 $w^l(t)$: Wage at large-scale farm,
 $w^r(t)$: Wage in the rest of the economy,
 $L^l(t)$: Labour demand of large-scale farms, periodical,
 $L^{s,*}(t)$: Labour in subsistence agriculture, changes between periods,
 $L^r(t)$: Labour demand of the rest of the economy, periodical at time (t) .

From equation (3.1), the subsistence objective function, we can receive demand functions for food depending on prices and income. Equation (3.1) implies a supply function of labour to the farm sectors, which depends on structural variables, prices of processed food, and total labour. For instance, the labour supply can be used to describe the relationship of the subsistence sector with a large-scale farm sector. This relationship is characterised by a principal agent relationship which means that the labour supply function of the subsistence sector

$$(3.2) \quad \gamma_{130}w^l + \gamma_{140}[L^{s,*} - L^r(w^r) - L^l] + \gamma_{121}p^p w^l + \gamma_{122}p^p + \gamma_{123}p^x + \gamma_{214}w^r = 0$$

$$\Leftrightarrow w^l = \gamma_{130}^{-1} [\gamma_{140}[L^{s,*} - L^r(w^r) - L^l] + \gamma_{121}p^p w^l + \gamma_{122}p^p + \gamma_{123}p^x + \gamma_{214}w^r],$$

enters as a behavioural equation (3.2) the objective function of a well-established large-scale sector. The large-scale sector relies on labour from the subsistence sector for profit maximisation, whereas its objective function is normally specified, with the exception that land is constrained. Initially, though, the constraint is only marginal with a low shadow price:

$$(3.3) \quad \begin{aligned} \Pi(p^r, w^l, L^l, S^l) = & p^r q^{r,l} - w^l L^l - t_t^l S_t^l - C(q^{r,l}, L^l, S^l) = p^r q^{r,l} - w^l L^l \\ & - t_t^l S_t^l - \gamma_{210}q^{r,l} - \gamma_{220}L^l + 0.5\gamma_{211}q^{r,l2} + .5\gamma_{221}L^l2, \\ & + .5\gamma_{232}S^l2 + \gamma_{212}q^{r,l}L^l + \gamma_{212}S^l q^{r,l} + \gamma_{212}S^l L^l \end{aligned}$$

new: $S^l(t)$: Land with commercial large-scale farms,
 $t^l(t)$: Tax on land,
 $q^{r,l}(t)$: Quantity of raw products by the large-scale sector.

From equation (3.2) we receive endogenous wages which enter the objective function of large-scale farms. After the insertion of (3.2), a profit function such as that of a principal appears:

$$\begin{aligned}
(3.3') \quad \Pi(p^r, w^r, L^l, S^l, L^{s,*}) = & p^r q^{r,l} - t_l^l S^l - \gamma_{130}^{-1} [\gamma_{140} [L^{s,*} - L^r(w^r) - L^l] + \gamma_{121} p^p w^l + \gamma_{122} p^p \\
& + \gamma_{123} p^x + \gamma_{214} w^r] L^l - \gamma_{210} q^{r,l} - \gamma_{220} L^l - \gamma_{220} S^l + 0.5 \gamma_{211} q^{r,l2} \\
& + 0.5 \gamma_{221} L^l{}^2 + 0.5 \gamma_{232} S^l{}^2 + \gamma_{212} q^{r,l} L^l + \gamma_{212} S^l q^{r,l} + \gamma_{212} S^l L^l]
\end{aligned}$$

According to equation (3.3') the large-scale sector determines labour demand and wage. It determines a Nash equilibrium for labour from the food subsistence sector.

Thus, we finally have a new "objective" function of the subsistence farm sector (3.4) that includes the behaviour of the large-scale sector. It will be the relevant function for policy makers that have anticipated the conditions and potential of subsistence agriculture.

$$\begin{aligned}
(3.4) \quad V^s(p^p, p^x, w^l L^l, w^r, [L^{s,*} - L^r(w^r) - L^l(p^r, L^l, S^l, \dots)]) = & \gamma_{110} p^p + \gamma_{120} p^x + \gamma_{130} [w^l L^l] \\
& + \gamma_{140} [L^{s,*} - L^r(w^r) - L^l]^2 + .5 \gamma_{111} p^p{}^2 + \gamma_{121} p^p [w^l L^l] + \gamma_{122} p^p [L^{s,*} - L^r(w^r) \\
& - L^l] + \gamma_{123} p^x L^l + \gamma_{214} w^r L^l
\end{aligned}$$

The new objective function of the household food production (subsistence) sector includes the repercussions from the current labour exchange between this unit and large-scale farms. Land and labour in the function are derived from allocation decisions within the large-scale farms. At this point we can obtain a new food demand function, that depends on job opportunities and payment in the large-scale sector, as we calculate the first derivative of the price for processed food. Constraints can be lifted only periodically, and the off-farm demand for labour is:

$$(3.5) \quad L^r(w^r) = \gamma_{000} + \gamma_{00} w^r \dots,$$

Dots "..." express that other factors of the complete function are included; a brief form. Then

$$(3.6) \quad q^{p,s,d} = \gamma_{110} + \gamma_{111} p^p + \gamma_{121} S^l + \gamma_{122} [L^{s,*} - \gamma_{000} + \gamma_{00} w^r] + \gamma_{123} p^x S^l + \gamma_{214} w^r \dots,$$

defines food demand. We will need this function (3.6) to determine sales of a dominant firm. For the raw material procurement we will also need the supply function of large-scale farms.

Note that the profit function of the large scale sector now includes components of the subsistence sector due to labour market interactions. Representing only cross components, we receive:

$$\begin{aligned}
(3.7) \quad \Pi(p^r, w^r, L^l, S^l, L^{s,*}) = & p^r q^{r,l} - t_l^l S^l - \gamma_{210} q^{r,l} - \dots + .5 \gamma_{211} q^{r,l2} + \gamma_{212} q^{r,l} \gamma_{130}^{-1} \\
& [\gamma_{121} p^p \dots + \gamma_{122} p^p + \gamma_{123} p^x + \gamma_{214} w^r] + \dots + \gamma_{212} S^l q^{r,l} + \dots L^{s,*} \dots
\end{aligned}$$

and in order to define raw material supply of large-scale farms the first derivative offers:

$$(3.7') \quad q^{r,l,s} = \gamma_{211}^{-1} [p^r - \gamma_{210} - \gamma_{212} \gamma_{130}^{-1} [\gamma_{121} p^p \dots + \gamma_{122} p^p + \gamma_{123} p^x]] + \gamma_{212} S^l \dots L^{s,*} \dots$$

This supply of raw material (3.7) is periodical and contains $L^{s,*}$, the labour caught in subsistence farming, as a structural variable. For linking sub-sector behaviour, the subsistence sector will offer labour for emerging small-scale farms, which are the major focus of the analysis.

3.2 The Emerging Commercially Oriented, Small-scale Sector

The objective function of the emerging small-scale sector recognises value added from own labour and the fact that this group also has to buy food from the market. Hence, it has an indirect utility function which reflects food purchases and raw product sales prices in a joint function. "Own labour" is based on former labour from the subsistence sector. One of the major differences between subsistence and emerging small-scale farmers has to be seen in the responsiveness of emerging small-scale farmers to knowledge dissemination by extension services. Moreover, land has to be acquired from a market that is not a spot market, but includes specific transaction costs. Land and labour enter as structural variables to be lifted temporally:

$$\begin{aligned} V^e(p^p, p^r, [p^r q^{r,e} - C(q^{r,e}, h(\dots), L^{e,*}, S^{e,*}, s^e, l^e)]) = \\ \gamma_{410} p^p + \gamma_{420} [p^r q^{r,e} - C(q^{r,e}, h(\dots), \dots)] + \gamma_{430} L^{e,*} + \gamma_{440} S^{e,*} + \gamma_{140} L^{e,*2} \\ + .5\gamma_{411} p^{p2} + \gamma_{421} x^e [p^r q^{r,e} - C(q^{r,e}, h(\dots), \dots)] + \gamma_{421} p^p [p^r q^{r,e} - C(q^{r,e}, h(\dots), \dots)] \end{aligned}$$

with

$$(3.8) \quad \begin{aligned} C(q^{r,e}, h(\dots), L^{e,*}, S^{e,*}, s^e, l^e) = \gamma_{4110} q^{r,e} - \gamma_{4120} L^{e,*} - \gamma_{4120} S^{e,*} + .5\gamma_{4111} q^{r,e2} \\ + .5\gamma_{4121} L^{e,*2} + .5\gamma_{4132} S^{e,*2} + \gamma_{4112} q^{r,e} L^{e,*} + \gamma_{4112} S^{e,*} q^{r,e} + \gamma_{212} S^{e,*} L^{e,*} \end{aligned} ,$$

and

$$h(\dots) = \gamma_{4210} L^{e,*} - \gamma_{4220} N^e$$

$$\text{Note : } L^{e,*} = [L - L^{e,*}] \quad \text{and} \quad S^e = [S - S^l]$$

- new:
- $S^{e,*}(t)$: Land with emerging small-scale farms, S equals total land as $S = S^{e,*}(t) + S^{l,*}(t)$,
 - $L^{e,*}(t)$: Labour with emerging small-scale farms, L equals total initial labour $L = L^{e,*}(t) + L^{l,*}(t)$,
 - $x^e(t)$: Input prices,
 - $q^{r,e}(t)$: Quantity of raw production by the emerging small-scale sector,
 - $N^e(t)$: Knowledge of the emerging small-scale sector,

$q^{r,e}(t)$: Quantity of raw production by the emerging small-scale sector.

Particularly the representation (3.8) of the small-scale sector offers a linear supply function of raw material for the processing industry, if the first derivative towards quantity is calculated.

$$(3.9) \quad q^{c,s} = [\gamma_{211}^*]^{-1} [\gamma_{420} + \gamma_{121}^* p^r - \gamma_{212} L^{e,*} + \gamma_{212} S^{e,*} + \gamma_{121} p^p + \gamma_{510} x^e - \gamma_{520}^* N^e \dots].$$

The emerging, commercial, small-scale farms should be the central focus of the structural adjustments intended by a transition policy geared towards modernisation. Knowledge " N^e " is pivotal for long term success on labour and land markets. The implications of a need for knowledge acquisition and dynamics are discussed in a later chapter on system evolution and policy.

3.3 Food Processing and Distribution Sector

The food processing sector shall be a dual sector. It comprises a large-scale processing firm that can exhibit market power and many small firms. The large firm or agglomerate of processing units (*abattoirs*, etc.) has the control over large parts of the raw product due to economies of scale and it shall behave like a dominant firm. It may be that it is a group of investors, local ministry controlled food processing units etc. But market power is limited due to existing and emerging small-scale processors and retailers. The level of market shares is determined by differences in cost functions. Very similar cost functions mean nearly perfect competition.

On efficiency in the processing sector, the small-scale sector by definition remains small-scale business and changes in the margin are not accomplished by the introduction of better technologies. Whereas the large-scale sector can attract foreign investment and costs of processing are subject to technology acquisition and use of economies of scale (LYONS et al. 1998). Indeed, it would be no problem having only large firms in the processing sector and just a reconstruction of previously state run factories if these firms could not exercise market power. There is a trade-off between large firms implementing advanced technologies and regional exercise of market power, especially where transport cost are high. Then the small-scale processors play an important role in providing the competitive environment in which dominant firms operate. Investors will analyse their potential in achieving market shares on regional output markets to become price leaders, forecast volumes of sales to reap economies of scale, and investigate procurement and raw product prices to assure commercial survival.

From a governmental point of view, fostering competition within the food processing sector should mean to create a viable small-scale sector. Simultaneously, recognition of profitable investments in the large-scale sector is also necessary. This strategy requires a double focus of public policies:

governments have to demonstrate how subsidies for investments in the large scale sector impact the efficiency of dominant food processing firms and how gains in efficiency can be transmitted to emerging commercial farmers, for instance, in terms of higher raw product prices. They have to show how moderate taxing in small-scale processing encourages growth in the sector and contributes to competition within the sector, thereby reducing margins. We will argue for a doubly-oriented strategy of increasing competition and efficiency.

3.3.1 Small-scale Processors

Before we can start to optimise the behaviour of the dominant firm as the strategic player, we have to reconsider the objective function (3.10) of small-scale processing firm; primarily in order to determine the market share of the dominant firm. This also implies deciding on marketing channels chosen by the various units, whereas products shall be fungible substitutes.

$$(3.10) \quad \Pi^s(p^p, p^r, w^x) = p^p q^{p,s} - p^r q^{r,s} - C(q^{p,s}, q^{r,s}, w^x) - t^s q^{p,s},$$

new: $w^s(t)$: Other input prices of small-scale processors,
 $q^{p,s}(t)$: Sales quantity of processed produce by small-scale processors,
 $q^{r,s}(t)$: Purchased quantity of raw production by small-scale processors,
 $t^s(t)$: Tax imposed on small-scale processors (variable and positive if tax-exemptions are introduced).

Note that the small-scale sector pays sales taxes. As an instrument, we may include exemptions from sales taxes " t^s ". Next, for simplification we consider a Leontieff technology in processing food from raw products within cost functions. That enables us to limit decisions of small-scale processors to a single quantitative decision on the volume of processing in this sector.

3.3.2 Dominant Firm

In a dynamic context, a dominant firm is confronted with two serious judgements. First, it has to anticipate market volumes on procurement and sales markets in particular regions. On both markets it competes with small-scale firms. Second, it decides on investment in processing.

$$\begin{aligned}
\Pi^d(p^p, p^r, w^r, L^{e,*}, S^{e,*}, L^{l,*}, S^{l,*}, I^d, i^d) = \\
p^p q^{p,d}(\dots) - p^r q^{r,d}(\dots) - C(q^{p,d}(\dots), q^{r,d}(\dots), w^d, I^d) - i^d [r^d - t_t^d] \\
\Pi^d(p^p, p^r, w^r, L^{e,*}, S^{e,*}, L^{l,*}, S^{l,*}, I^d, i^d) = \\
(3.11) \quad p^p q^{p,d}(\dots) - p^r q^{r,d}(\dots) - \gamma_{610} q^p q^{p,d}(\dots) - \gamma_{620} q^{r,d}(\dots) + \gamma_{630} w^c \\
+ \gamma_{640} I^d + .5\gamma_{611} I^{d2} - \gamma_{621} I^d q^{p,d}(\dots) - \gamma_{632} I^d q^{r,d}(\dots) + \gamma_{612} I^d w^d + \gamma_{612} I^d i^d,
\end{aligned}$$

where behavioural equations from market anticipation are :

$$q^{p,d} = q^{p,d}(p^p, p^r, w^r, L^{e,*}, S^{e,*}, L^{l,*}, S^{l,*}, N^e, t^l, t^s, \dots)$$

$$q^{r,d} = q^{r,d}(p^p, p^r, w^r, L^{e,*}, S^{e,*}, L^{l,*}, S^{l,*}, N^e, t^l, t^s, \dots)$$

- new: $w^d(t)$: Other input prices of small-scale processors,
 $q^{p,d}(t)$: Sales quantity of processed production by dominant firm,
 $q^{r,s}(t)$: Purchased quantity of raw production by dominant firm,
 $i^d(t)$: Investment of the dominant firm,
 $t^d(t)$: Subsidy (inverse tax) for investment of the dominant firm,
 $I^d(t)$: Capital accumulated in the dominant firm.

The function (3.11) has to be maximised under the dynamic constraint that investments, as accumulated capital, deteriorate under normal circumstances, and has to be renewed with a certain volume every year. Capital is a stock variable and investment is a flow i_t^e . Then we have:

$$(3.12) \quad \dot{I}_t^d = \gamma_{060} I_t^d - \gamma_{061} q^{r,d} + i_t^e.$$

Also, for simplification as in the small-scale processing sector, we assume a linear relationship between processed food and raw material, which reduces the number of decision variables of the large scale sector to processing volume, investment and price behaviour. In essence, the large-scale sector might use a dynamic optimisation for investment decisions. In that optimisation the volume of capital invested I^e is endogenously determined and prices are simultaneously determined. Technically dynamic optimisation can be presented by a continuous integral over a planning period (optimisation is a time dependent category; TU 1991).

$$\begin{aligned}
\int_0^T e^{-\rho t} \{ [p_t^p - p_t^r \xi_2 - \xi_2 \gamma_{220} - \gamma_{210}] q_t^{p,d} - i_t^e \xi_2 q_t^{p,d} + \gamma_{230} w_t^d q_t^{p,d} + \gamma_{240} I_t^d \\
+ .5\gamma_{211} I_t^{d2} - \gamma_{221} I_t^d q_t^{p,d} - \gamma_{232} I_t^d \xi_2 q_t^{p,d} \} dt \\
(3.13) \quad \text{s.t.}
\end{aligned}$$

$$p^p = \gamma_{6110}^* + \gamma_{6111}^* q^{p,e} + \gamma_{6121}^* S^c + \gamma_{6122}^* L^{s,*} + \gamma_{6123}^* S^c + \gamma_{6114} w^r + \gamma_{6115} t^l + \gamma_{6116} t^l + \gamma_{6117} N^e \dots$$

$$p^r = \gamma_{6210}^* + \gamma_{6211}^* q^{p,e} + \gamma_{6221}^* S^c + \gamma_{6222}^* L^{s,*} + \gamma_{6223}^* S^c + \gamma_{6214} w^r + \gamma_{6215} t^l + \gamma_{2116} t^s + \gamma_{2117} N^e \dots$$

Dynamic control theory offers a mode for solving the problem (3.13) analytically (TU 1991). This finally results in a Hamilton function (3.14) which contains as decision variables the investment behaviour of the dominant firm, I_t^d , i_t^d , and the production capacity $q_t^{p,d}$. The coefficients in equation (3.14) are condensed coefficients and are calculated from coefficients of the underlying supply and demand functions. They reckon market equilibrium and technological conditions. Furthermore equation (3.14) contains "exogenous" incentive variables:

$$(3.14) \quad H^d = e^{-\rho} \{ \xi_{60}^* - \xi_{61}^* q_t^{p,d} + [\xi_{621}^* t_t^l + \xi_{622}^* t_t^e + \xi_{623}^* t_t^d + \xi_{624}^* N_t^e + .5 \xi_{625}^* q_t^{p,d}] \xi_{61}^* q_t^{p,d} - i_t^e \xi_6^* q_t^{p,d} \\ + \gamma_{630}^* w_t^d q_t^{p,d} + \gamma_{640}^* I_t^d + .5 \gamma_{611}^* I_t^{d2} - \gamma_{621}^* I_t^d q_t^d - \gamma_{232}^* I_t^d \xi_2^* q_t^{p,d} + \lambda_t^d [\gamma_{010}^* I_t^d - \gamma_{010}^* q_t^{p,d} + i_t^d] \}$$

After optimisation, the dominant firm reveals its contingency of conduct (investment) on market structures and performance of participating players in an investment game. Contingency is given by the dependency of the solution on "incentive variables" such as subsidising new investments of the dominant firm, taxing large-scale farms, or small-scale processors. For the political support and calculation of "optimal temporal paths", in a final step to be presented, the resulting optimal dynamic behaviour is a solution from optimising (3.14). It provides a dynamic constraint (3.15) for government behaviour. This constraint includes endogenously the investment behaviour of the large-scale dominant firm, being dependent on subsidies, extension, and market performance. Market performance is recursively dependent on the necessary accumulation of knowledge and land for farming by the emerging small-scale farms. Competitiveness of small-scale processors, as dependent on margins, indirectly determines the behaviour of the dominant firm. We receive a dynamic constraint which is the residual of an internally solved anticipation of market development as judged by the dominant firm.

$$(3.15) \quad \dot{I}_t^e = \gamma_{710} + \gamma_{711} I_t^e + \gamma_{712} L^{l,*} + \gamma_{713} S^{l,*} + \gamma_{714} L^{e,*} + \gamma_{715} S^{e,*} \\ + \gamma_{716} N^e + \gamma_{711} t^l + \gamma_{718} t^s + \gamma_{510} t^i + \gamma_{510} x^r \dots$$

For the interpretation of repercussions we have the following: Government announces its potential behaviour to the large dominant firm and, if they have the same perception on market performance, a residual game (joint projections) enables both to benefit from the commercialisation of subsistence agriculture.

3.4 Consumption and the Rest of Economy

To close the model, we need consumer behaviour in the rest of the economy. This means that the specification of the production sector is supplemented by a residual sub-sector that caters for non-rural food demand. Though the model has a major focus on household food production (subsistence), large-scale farms, the potential for commercial small-scale processing, and processing in a dominant

firm, the measurement of achievements is evaluated through benefits from increased food consumption. The demand of the rest of the economy is derived from an indirect utility function. The indirect utility function reflects consumer surplus:

$$(3.16) \quad V^r(p^p, y^r) = \gamma_{810} p^p + .5\gamma_{811} p^{p2} + \gamma_{821} p^p y^r.$$

This type of function provides both a linear demand function for food and a closure of balances in food consumption, and it serves as the consumer surplus in the cost-benefit analysis.

4 BALANCE AND CONSTRAINTS

In addition to the constraints and balances that have to be considered on sub-sector levels, the government faces sector balances and constraints. These conditions have to be recognised in the specification of the objective function and the conditions for government optimisation.

4.1 Periodical Balances

So far, we have introduced the objective functions of various groups that participate passively and actively in the commercialisation of subsistence agriculture. To proceed, we need to reduce the number of variables and redirect the model at market and policy analysis. Basically, the balance of supply and demand, as well as iterative procedures of processing and farm technology will help us to specify variables as given in market categories. First, the output market will be served by the small-scale processing sector and the dominant firm and products are bought by the rest of the economy and the household production sector (rural labourers):

$$(4.1.1) \quad q^{p,s,s} + q^{p,d,s} = q^{s,d} + q^{r,d}.$$

Second, the procurement of the small-scale processing sector and the dominant firm from large-scale farms and emerging small-scale commercial farms has to be balanced accordingly:

$$(4.1.2) \quad q^{r,d,d} + q^{r,s,d} = q^{r,e,s} + q^{r,l,s}.$$

This brings about a determination of residual markets for the dominant firm on both sales and procurement markets. It is up to the analyst to decide on the level of knowledge of the dominant firms on related markets. Technically, we could use the information on structural conditions and economic variables for each participant, as gathered in the previous sections, and include them in the conditional decision making of any participant. The question is, whether participating firms really have all the necessary information. We may compromise and presume that some variables are strictly observable whilst others are less important and neglected by a dominant firm. We need a focus on

market explorations that capture information. Third, labour and land markets shall be balanced, which endogenously determines input prices.

4.2 Financial Balance

Within the given framework of potential government intervention, a balance between expenditures and revenues of governments might be of interest. A balance means that revenues raised from taxing large-scale farms via a land tax and taxes from small-scale processors, equals expenditures. Then the money is used for subsidising investment of the dominant firm and for expenditures on extension services, now offered to emerging, small-scale farmers.

$$(4.2.1) \quad t_t^l S_t^l + t_t^s q_t^{p,s} = i_t^d t_t^d - t_t^s q_t^{p,s} + n_t^c.$$

Going along this route, the number of variables for government intervention is reduced to two.

4.3 Dynamic Constraints

In chapter three, we have already identified constraints (3.15) for public policy, which is now:

$$(4.3.1) \quad \dot{I}_t^e = \gamma_{710} + \gamma_{711} I_t^e + \gamma_{712} L^{l,*} + \gamma_{713} S^{l,*} + \gamma_{714} L^{e,*} + \gamma_{715} S^{e,*} + \gamma_{716} N^e \\ + \gamma_{711} t^l + \gamma_{718} t^s + \gamma_{510} t^i + \gamma_{510} x^r \dots$$

It links investment decisions on large-scale processing in a dominant firm to the structural conditions of that sub-sector. It can be influenced by a government that contributes, through policy to structural change, to deciding on instrument variables such as subsidies and taxes. But the government has not only this constraint for consideration: Knowledge acquisition of emerging small-scale farmers has to be considered a dynamic function (ARROW 1992). It links government efforts $n(t)$ to knowledge (extension) and knowledge accumulates on farm level.

$$(4.3.2) \quad \dot{N}_t^e = \gamma_{510} N_t^e + \gamma_{510} n_t^r.$$

The function (4.1.2) directly relates to policy. Furthermore, we have land transactions s_t^l . Land is transferred between the inefficient large-scale and emerging small-scale farm sector in:

$$(4.3.3) \quad \dot{S}_t^{l,*} = s_t^l.$$

Finally, labour and migration between occupations receives special attention, where l_t^l is the number of subsistence farmers that newly start farming as emerging small-scale farmers.

$$(4.3.4) \quad \dot{L}_t^{s,*} = l_t^s.$$

Note that we make a distinction between labour as a stock variable which is necessary to conduct food production in both farm sectors and migration, or exchange of labour between sectors as a flow variable. The optimisation depends on the costs of migration which are recognised in the individual objective function when we enter into dynamic considerations. Note also that due to definition, an increase of land and labour in the emerging small-scale sector is accompanied by a similar decline in the large-scale sector for land and subsistence for labour.

The dynamic conditions (4.3.1 to 4.3.4; note four equations and four state variables) are expressed in a differential equation system:

$$(4.1) \quad y(t) = \Psi y(t) + N u(t) + \Gamma e(t),$$

where $y(t)$ is a vector of the state variables $y(t) = [L(t), S(t), N(t), I(t)]$ and $u(t)$ is a vector of control variables $u(t) = [n(t), t^d(t), l(t), s(t)]$. For interpretation: The system (4.1) represents the development of desired and achievable "states" $y(t)$ as subjected to the action $u(t)$ of the government contingent on behavioural and technical aspects of a food production system. This dynamic constraint will be used with the public objective function for policy evaluation.

5 GOVERNMENT BEHAVIOUR

Until now the food sector has been analysed given a particular market structure that hampers structural changes. Structural changes that may be the result of policies are: labour to be transferred from household food production to emerging small-scale farms (i.e., foundation of family farms) and land transfer from large-scale farms to emerging, commercially-oriented, small scale-farms (land reform). The model explicitly includes knowledge of emerging farms and other controllable "state" variables. Control or support variables are taxing and subsidising as well as extension for knowledge accumulation; all steering the system as a result of government activity. Private investment of a dominant processing company is endogenous; missing is a derivation of the public objective function for a dynamic cost-benefit analysis.

5.1 Government's Objective Function

In designing support policies, the government needs an objective function. Equation (5.1) provides an objective function of a benevolent government that is identified as a benevolent one. It does not prefer particular groups involved in food production, processing and consumption; rather (5.1) is a non-weighted summation of private objective functions over all participants.

$$\begin{aligned}
(5.1) \quad W = & \int_0^T e^{-\alpha t} [\Pi^l(p_t^r, w_t^l, L_t^l, S_t^l) + V^s(p_t^p, p_t^x, w_t^l, L_t^l, w_t^r, [L_t^{s,*} - L_t^r(w_t^r) - L_t^l]) \\
& + V^e(p_t^p, r_t^x, [p_t^r q_t^e - C(q_t^e, h(N_t^e, \dots), L_t^e, S_t^e, s_t^e, l_t^e))] + \Pi^d(p_t^p, p_t^r, w_t^r, L_t^{e,*}, S_t^{e,*}, L_t^{l,*}, S_t^{l,*}, I_t^d, i_t^d) \cdot \\
& + \Pi^s(p_t^p, p_t^r, w_t^x) + V^r(p_t^p, y_t^u)] dt
\end{aligned}$$

As has been discussed in NUPPENAU and BADIANE 2000, such an objective function can be empirically derived from elaborating on functional forms and corresponding estimations. Essentially, it is feasible to describe the objective function (5.1) in matrix notation and preserve the structure of state and control variables. An objective function that is simulated by equation (5.1) can be reduced to a vector of long term adjustments with state variables as above in the system evolution: i.e., remaining labour in subsistence agriculture, land in large-scale farms, knowledge of emerging small-scale farms, investment of a dominant firm ($y(t)=[L(t), S(t), N(t), N(t)]$), and so-called control variables: i.e., extension services, subsidies for investment in processing, land reallocation as ownership transfer and the land in newly emerging farms ($u(t)=[n(t), t^d(t), l(t), s(t)]$). Then the optimisation of the objective function is subject to the dynamic constraint (4.1). The government uses a similar framing of market structure, conduct and performance as the dominant firm. In the game of reversing the cycle of subsistence farming, a government has the role of a master player while the firm is the follower of incentives.

5.2 Technical Aspects in Modelling of Dynamic Optimisation of a Benevolent Government

The objective function (chapter 3 and equation 5.1), together with the dynamic constraint (chapter 4, equation 4.1), specifies the dynamic control problem. This implies the use of a Hamilton function presentation. The Hamilton function includes the time dependency of the objective functions of participants. For construction of the coefficients from individual functions, see the Appendix. Part 1 is the constrained welfare function (5.1), and part 2 is the dynamic system. Technically, the Hamilton function (TU 1991) depends on state variable $y(t)$, control variable $u(t)$ and a constraint assessment $\lambda(t)$ that can be seen as a Lagrange factor:

$$\begin{aligned}
(5.2) \quad H(t) = & \exp\{\omega * t\} [0.5 y(t)' \Pi_1 y(t) + y(t)' \Pi_2 u(t) + u(t)' \Pi_3 u(t) + z(t)' \Pi_4 y(t) + z(t)' \Pi_5 u(t) \\
& + \pi_0' y(t) - w' u(t) + \lambda'(t) [\Psi y(t) + Nu(t) + \Gamma e(t)]
\end{aligned}$$

Such a system satisfies the concept of an optimal control problem (TU 1991). If the curvature of the objective function is correct, equation (5.2) can be directly used for policy evaluation. The right features of the curvature are theoretically satisfied if general economic assumptions on profit functions, i.e., normality, semi-definiteness, etc., are given. For its solution (TU 1991), a control theory problem has to fulfil certain conditions to obtain a maximum:

$$H_y = -\dot{\lambda} \quad (5.2.a), \quad H_u = 0 \quad (5.2.b), \quad H_\lambda = \dot{y} \quad (5.2.c).$$

These conditions are applied to the stated Hamilton function. By that we get for $y(t)$, $u(t)$, $\lambda(t)$:

$$(5.3.a) \quad \Pi_1 y(t) + \Pi_2 u(t) + \Pi_4 z(t) + \Pi_6 p^w + \pi_0 + \Psi' \lambda(t) = -\dot{\lambda}(t) - \omega(t) \lambda(t),$$

$$(5.3.b) \quad \Pi_2' y(t) + \Pi_3 u(t) + \Pi_5 z(t) + N' \lambda(t) + w = 0,$$

$$(5.3.c) \quad \Psi(t) + N u(t) + \Gamma e(t) = \dot{y}(t),$$

for comparison see EHUI and HERTEL (1989), who also show how to evaluate steady states. The conditions are rearranged to solvable differential equations in a system if equation (5.3.c) is

$$(5.3.c') \quad u(t) = N^{-1} \dot{y}(t) - N^{-1} \Psi y(t) - N^{-1} \Gamma e(t).$$

Inserting in (5.3.a) results in

$$(5.4.a) \quad [\Pi_1 - \Pi_2 N^{-1} \Psi] y(t) + [\Psi' - \omega] \lambda(t) + \Pi_4 z(t) - \Pi_2 N^{-1} \Gamma e(t) + \Pi_6 p^w + \pi_0 = -\dot{\lambda}(t) - \Pi_2 N^{-1} y(t),$$

$$(5.4.b) \quad [\Pi_2' - \Pi_3 N^{-1} \Psi] y(t) + N' \lambda(t) + \Pi_5 z(t) - \Pi_3 N^{-1} \Gamma e(t) + w = -\Pi_3 N^{-1} \dot{y}(t).$$

System (5.4) is a set of dependent differential equations and offers the optimal path of policy.

For confirmation: Applying techniques of solving multiple differential equations, the path of endogenous variables in the vectors, $y(t)$ and $\lambda(t)$, can be mathematically obtained. Technically speaking, equations in system (5.4) are used to come up with a combined set of time dependent variables $\lambda(t)$ and $y(t)$ and correspondingly $u(t)$ is given (using equation (5.3.c')). Generally speaking, the solution $u(t)$ describes the optimal choice on policy variables in the system, i.e., choices in the subsistence combating strategy: Indirectly the path of $i^d(t)$, the investments, is given by knowledge generation, $n(t)$, subsidies $t^d(t)$ and $s(t)$, land transfer, etc. Importantly, the specific path of $l(t)$ describes the creation of a commercial farm sector; i.e., $u(t) = [n(t), t^d(t), l(t), s(t)]'$ are endogenously determined. Recursively, the state variable vector $y(t)$ reflects government's desires to improve the performance of the food sector and can be projected.

APPENDIX

As an explanation for empirical evaluation, for instance, the objective function in chapter 3 may correspond to quadratic objective functions. A quadratic outline of $V^e_i(...)$, as applied to the emerging small-scale farmers and as based on knowledge, land labour, etc., can be written in matrix form as:

Figure 2: Functional Form and Objective Presentation

$$V^e(S^e_t, L^e, h(N_t, \dots), p^p_t, p^r_t, s^e_t, l^e_t, x^e_t) = 0.5 \begin{bmatrix} S^e(t) \\ L^e(t) \\ N^e(t) \\ l^d(t) \end{bmatrix}' \begin{bmatrix} \pi^{i^1}_{1,1} & \pi^{i^1}_{1,2} & \pi^{i^1}_{1,3} & 0 \\ \pi^{i^1}_{2,1} & \pi^{i^1}_{2,2} & \pi^{i^1}_{2,3} & 0 \\ \pi^{i^1}_{3,1} & \pi^{i^1}_{3,2} & \pi^{i^1}_{3,3} & 0 \\ 0 & 0 & 0 & 0 \end{bmatrix} \begin{bmatrix} S^e(t) \\ L^e(t) \\ N^e(t) \\ l^d(t) \end{bmatrix} + \begin{bmatrix} q^{re}(t) \\ l^e(t) \\ s^e(t) \\ t^d(t) \end{bmatrix}'$$

$$\begin{bmatrix} \pi^{i^2}_{1,1} & \pi^{i^2}_{1,2} & \pi^{i^2}_{1,3} & 0 \\ 0 & 0 & 0 & 0 \\ \pi^{i^2}_{3,1} & \pi^{i^2}_{3,2} & \pi^{i^2}_{3,3} & 0 \\ 0 & 0 & 0 & 0 \end{bmatrix} \begin{bmatrix} S^e(t) \\ L^e(t) \\ N^e(t) \\ l^d(t) \end{bmatrix} + 0.5 \begin{bmatrix} q^{re}(t) \\ l^e(t) \\ s^e(t) \\ t^d(t) \end{bmatrix}' \begin{bmatrix} \pi^{i^3}_{1,1} & 0 & \pi^{i^3}_{1,3} & 0 \\ 0 & 0 & 0 & 0 \\ 0 & 0 & 0 & 0 \\ 0 & 0 & 0 & 0 \end{bmatrix} \begin{bmatrix} q^{re}(t) \\ l^e(t) \\ s^e(t) \\ t^d(t) \end{bmatrix} + \begin{bmatrix} q^{re}(t) \\ l^e(t) \\ s^e(t) \\ t^d(t) \end{bmatrix}' \begin{bmatrix} 1 & \dots \\ \dots & \dots \\ \dots & \dots \end{bmatrix} \begin{bmatrix} p^r(t) \\ p^p(t) \\ \dots \\ \dots \end{bmatrix} y_1 + \begin{bmatrix} q^{re}(t) \\ l^e(t) \\ s^e(t) \\ t^d(t) \end{bmatrix}'$$

$$\begin{bmatrix} \pi^{i^5}_{1,1} & \dots \\ 0 & \dots \\ 0 & \dots \end{bmatrix} x^e_t \Leftrightarrow$$

$$V^e = .5y(t)' \Pi_1^{(V^e)} y(t) + u(t)' \Pi_2^{(V^e)} y(t) + u(t)' \Pi_3^{(V^e)} u(t) + z(t)' \Pi_4^{(V^e)} y(t) + z(t)' \Pi_5^{(V^e)} u(t),$$

where $\pi^i, l_{i,i}$ coefficients in $\Pi_i(V^e)$ expressed in matrix notation, are coefficients as derived from an econometric supply analysis of behaviour. In dual theory, the first derivative of the profit function provides linear functions and coefficients are derived from regressing product supply to prices and constraints. Later on, prices become endogenous in formulation of the objective function from a sectoral point of view. The coefficients can also be interpreted as elasticities of supply response. In the same vein, the other profit and surplus functions of the temporal cost benefit analysis are established:

Figure 3: Addition of Coefficients

$$\Pi_1 = \Pi_1^{(I^h)} + \Pi_1^{(I^s)} + \Pi_1^{(I^e)} + \Pi_1^{(I^f)} + \Pi_1^{(I^r)} + \Pi_1^{(I^v)}$$

$$\Pi_2 = \Pi_2^{(I^h)} + \Pi_2^{(I^s)} + \Pi_2^{(I^e)} + \Pi_2^{(I^f)} + \Pi_2^{(I^r)} + \Pi_2^{(I^v)}$$

....

as coefficients in equation (5.2).

REFERENCES

- ARROW, K.J. (1992): The Economic Implications of Learning by Doing, *Review of Economic Studies*, Vol. 29, pp. 155-173.
- CARLTON, D.W., PERLOFF, J.M. (1994): Modern Industrial Organization, Second Edition, New York, pp. 157ff.
- CASKIE, P. (2000): Back to Basics: Household Food Production in Russia, *Journal of Agricultural Economics*, Vol. 51, No. 2, pp. 196-209.
- EHUI, S., HERTEL, T.S. (1992): Deforestation and Agricultural Productivity in the Cote d'Ivoire, *American Journal of Agricultural Economics*, Vol. 71, No. 4, pp. 703ff.
- KIVISTIK, J. (2000): Stand der Internationalen Wettbewerbsfähigkeit der Estnischen Agrar- und Ernährungswirtschaft, in: ALVENSLEBEN, R.V., KOESTER, U., LANGBEHN, C. (eds.): Wettbewerbsfähigkeit und Unternehmertum in der Land- und Ernährungswirtschaft, Jahrestagung der GEWISOLA, Münster-Hiltrup, pp. 349-353.
- LYONS, R., GOODHUE, R., RAUSSER, G., SIMON, L. (1998): A Dynamic Model of the Food Processing Sector in the New Market Economies of Central Europe, Paper Presented at the Annual Meeting of the AAEA 1999: <<http://www.AAEA.org/>>.
- MACOURS, K., SWINNEN, J. (2000): Agrarian Transition and Productivity Patterns: Synthesis of Experiences in Eastern Europe, the Former Soviet Union and East Asia, in: Tomorrow's Agriculture: Incentives, Institutions, Infrastructure and Innovations, XXIV International Conference of Agricultural Economists, IAAE 2000, Berlin, Plenary Paper, CD-ROM of Plenary Papers, Berlin.
- NUPPENAU, E.-A., BADIANE, O. (2000): Modeling Public Goods Provision in Agriculture, in: TILBURG, V., MOLL, H., KUYVENHOVEN, A. (eds.): Agricultural Markets Beyond Liberalization, Boston, Dordrecht, London, pp. 279-298.
- SARRIS, A.H., DOUCHA, T., MATHIJS, E. (1999): Agricultural Restructuring in Central and Eastern Europe, *European Review of Agricultural Economics*, Special Issue: Plenary Papers of the IXth Congress of the European Association of Agricultural Economics, Warsaw, August 24-28, pp. 305-329.
- SEROVA, E.V. (2000): Russia's Agro-food Sector: State of the Art, in: WEHRHEIM, P., SEROVA, E.V., FROHBERG, K., VON BRAUN, J. (eds.): Russia's Agro-food Sector, Towards Truly Functioning Markets, Boston, pp. 81-106.
- SURINOV, A., SHASHNOV, S. (2000): The Role of Household Plots in Rural Areas, in: WEHRHEIM, P., SEROVA, E.V., FROHBERG, K., VON BRAUN, J. (eds.): Russia's Agro-food Sector, Towards Truly Functioning Markets, Boston, pp. 232-332.
- TU, P.V. (1991): Introductory Dynamic Optimization, New York.
- YASTREBOVA, O. (2000): Evolving Food Marketing Chain, in: WEHRHEIM, P., SEROVA, E.V., FROHBERG, K., VON BRAUN, J. (eds.): Russia's Agro-food Sector, Towards Truly Functioning Markets, Boston, pp. 237-358.

DEVELOPMENT PERSPECTIVES OF SUBSISTENCE FARMS IN SOUTHEASTERN POLAND: SOCIAL BUFFER STOCK OR COMMERCIAL AGRICULTURE?

MARTIN PETRICK, EWA TYRAN

1 INTRODUCTION¹

In this paper we discuss the developmental perspectives of subsistence agriculture in the wider framework of structural change within an entire economy. We put forward the proposition that subsistence agriculture in South-eastern Poland must largely be understood and interpreted as one single stage of a mid- to long-term process that is called the 'agricultural transformation' (TIMMER 1988). This structural transformation of the agricultural sector has been observed in many countries during the course of economic development. Its principal direction is toward *specialisation* and *market participation at the producer level* (TOMICH et al. 1995, p. 36); it is characterised by an integration of agriculture into the whole economy, accompanied by a decline of the relative importance of this sector and a gradual dissolution of subsistence. The latter is understood as the fact that farm households consume a substantial share of their own-produced food themselves. As observed in maturing economies, factors previously employed in the primary sector are reallocated in the industrial or service sectors. Through the development of efficient factor markets that link sectors and regions, this is supposed to induce overall economic growth.²

¹ The authors are indebted to S. ABELE, H. HOCKMANN, Z. LERMAN, P. WEINGARTEN, and an anonymous reviewer for helpful comments on earlier versions of this paper. The usual disclaimer applies.

² The major determinants of the agricultural transformation in a given country are usually of a long-term nature and encompass elements such as the population-resource ratio, income and demand structure over time, technological change, and the institutional environment (HEIDHUES 1976). In the following, an economic way of analysis is pursued that leaves aside a number of important sociological and anthropological issues, such as the impact of behavioural norms, social stratification in villages, or generally peasants' value systems, which all may well affect the pace and intensity of agricultural development (and which are discussed with regard to Poland e.g., by NAGENGAST 1991 and ZBIERSKI-SALAMEH 1999).

As a consequence, we apply a *factor market approach* to the problem of subsistence farming versus market integration. We believe that the further development of peasant farms in Southeastern Poland crucially depends on their participation in efficient factor markets and their ability to realise a substantial growth of (particularly) land and labour productivity in order to meet future income needs. In a mutually reinforcing process, this will also result in increasing commercialisation and participation in product markets. In the longer term, the peasant society may thus differentiate into larger commercial farms on the one hand, which are partly based on rented land, and rural employee households on the other, which may still be landowners but cultivate at best a gardening plot.

The paper's discussion contains four steps. In the second chapter, we give an overview of the development of subsistence agriculture in Poland and its current problems. In the third chapter, we investigate how subsistence production can theoretically be understood in the process of structural change and we derive hypotheses on mutual relationships. The fourth chapter examines whether these considerations are supported by empirical data gathered in a farm survey carried out in former Tarnów and Rzeszów *voivodships* (now parts of the newly created Małopolska and Podkarpackie *voivodships*). The final chapter concludes with some general remarks on the relationship between mechanisms of structural change and subsistence agriculture in the Polish context.

2 POLISH SUBSISTENCE AGRICULTURE IN THE PROCESS OF STRUCTURAL CHANGE

The proposition of the dependence of subsistence on long-term structural change is based on the fact that subsistence agriculture in Southeastern Poland is primarily *not a transitory phenomenon* triggered by the economic hardships of transition to a market system. Instead, the existence of a subsistence-oriented peasantry in Southeastern Poland is largely the result of emancipation movements during the affiliation of the region with the Habsburg Empire in the mid-nineteenth century (NAGENGAST 1991). Furthermore, peasant farmers successfully resisted several attempts of collectivisation during the socialist period. There is thus a considerable difference between the Polish situation and subsistence farming in other former socialist countries. In the former Soviet Union, for example, private part-time farms were largely dependent on *kolkhozes* or *sovkhozes*, and their existence was subject to directives of the central planning authority (SCHINKE 1983) and not the result of a historically evolved farming structure as in Poland.

As a consequence, the rural population in many parts of Poland was never fully integrated into the overall economy. Nevertheless, in a study of structural change in Polish agriculture between 1960 and 1985, QUAISSER (1987) showed that farm structure in fact responded to relative price changes. Very roughly

speaking, improved employment opportunities outside of agriculture during the 1960s and 70s induced a shift of smaller farm households towards off-farm employment, while larger farms managed to maintain their incomes by productivity increases and growth. At the beginning of the 80s, a relative improvement of living conditions in agriculture compared to other sectors, the result of the overall economic crises, dampened this development (p. 91). It can be assumed that during this whole period quite a significant number of farm households still lived in relative autarchy and mainly relied on their self-produced diet (WOJCIECHOWSKA-RATAJCZAK 1999). At the end of the 80s, Poland therefore still had a comparatively small-structured peasant agriculture sector (see Table 1).

Table 1: Characteristics of Individual Farms in 1988 and 1996

		Poland		Former Tarnów Voivodship		Former Rzeszów Voivodship	
Characteristics		1988	1996	1988	1996	1988	1996
No. of Individual Farms (ths.)		2167.6	2041.4	71.7	69.8	73.7	72.3
Average Farm Size (ha)		6.25	6.99	3.53	3.39	3.31	3.15
Purpose of Production (%):	Non-Producing or Prod. Value Not Determined	n.a.	10.1	n.a.	19.0	n.a.	22.6
	Producing Solely for Own Consumption	n.a.	10.9	n.a.	12.9	n.a.	12.6
	Producing mainly for Own Consumption	n.a.	33.1	n.a.	47.8	n.a.	46.0
	Producing mainly for the Market	n.a.	45.9	n.a.	20.2	n.a.	15.1
Activity of People of Working Age Living on Individual Farms (%):	Working Solely On-farm	63.7	71.7	58.0	70.1	51.2	68.1
	Working Both On- and Off-farm	23.2	21.6	25.7	24.4	35.2	28.0
	Working Solely Off-farm	13.1	6.7	16.3	5.4	13.6	3.8

Notes: n.a. = not available. 'Non-producing' farms may include land-owning households that have registered as farms in order to skim off certain public benefits. In fact they do not produce anything at all because they live on off-farm sources.

Sources: Own calculations based on data of National Census 1988 and Agricultural Census 1996 according to GUS (1998, p. 188) and GUS (1999, pp. 37; 111).

Structural change and subsistence orientation seem to have been relatively slightly affected by the Polish transition to a decentralised market system. This again is in contrast to the situation in the former Soviet Union, where subsistence production substantially increased by a strong intensification of home gardening and the new creation of small private farms (see THO SEETH et al. 1998). For 1996, we have for the first time reliable data on the stated purpose of production of Polish peasant farms: Table 1 shows that more than 40% of all Polish farmers produced solely or mainly for own consumption. Unfortunately, there is no comparable statistic for the pre-transition period, so we cannot quantify the impact of the transition process. The total number of peasant farms only slightly decreased during these years, but a marked concentration process did not resume as a result of the economic liberalisation. For the former

voivodships of the study area, the average size of farms even declined (see Table 1). This apparent standstill is supposed to be the result of two opposite tendencies, which seemingly offset each other so far.

Increased pressure on farm incomes constitutes the first tendency. In the course of transition, liberalised markets caused a further reduction of the agricultural terms of trade (see Figure 1). Although there was a recovery in 1994 and 1995, this implied a general reduction of net farm incomes compared to the pre-transition period since there was no compensation by productivity increases (KOWALSKI 1993; WOŚ 1999). Though the physical output of agriculture after transition was relatively slightly affected by these circumstances, the increased price-cost squeeze can be seen as an important push factor that potentially reinforces structural change in Polish agriculture. With regard to impending EU integration, fears loom large that increased competition on product markets might have further negative consequences for the income situation of Polish farmers, although the effects of EU accession will very much depend on the specific form of direct payments and price policies implemented. Generally, it seems that EU integration merely accelerates structural adjustment processes that would have been inevitable anyway.

Figure 1: Agricultural Terms of Trade 1970-1999 (1990=100)

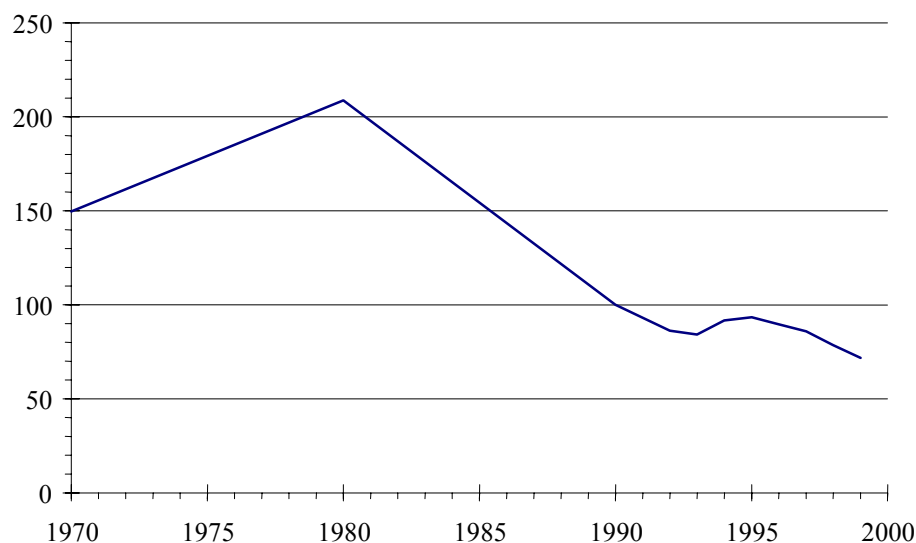

Notes: Output-/input-price ratio for individual farms. A changing weighting system was used. For details, see the source below. Prior to 1992 the figure is interpolated from the data-points of 1970, 1980, and 1990.

Source: GUS (2000, p. XLII).

A contrary tendency can be observed with regard to the labour force on peasant farms. The number of people of working age living on peasant farms significantly increased during recent years because of job cuts and dismissals in both state farms and rural industries. This labour force inflow clearly reduced labour productivity on farms and aggravated the income situation in agriculture. The latter is particularly true since on-farm activity does not provide merely an

additional safeguard against the risks of participating in the off-farm labour market. In fact, the labour force increase only concerns the group of people that spend *all of their working time* on the farm, while the importance of both part-time farming and full-time off-farm activity dropped (Table 1). This trend was accompanied by a growing reliance on public transfers such as old age and disability pensions. According to FRENKEL and ROSNER (1999), the share of peasant households with pensions as the main source of income increased from 18.7 to 29.6% between 1988 and 1995.

As a result, it is asserted that structural transformation has still to be accomplished by most farmers, both in Poland in general and in the study areas, and that the liberalisation of the economy after the demise of socialism has boosted forces that both bring about *and* hinder structural change. The aim of the following chapters of this paper is thus to look more closely at the conflicting forces at work in the rural economy. Furthermore, the objective is to investigate how likely the current state of affairs in the agricultural sector makes an intensified structural change in the near future. Based on a theoretical analysis we first put forward some testable hypotheses. After that we investigate in how far these hypotheses are supported by the empirical evidence.

3 A THEORETICAL ANALYSIS OF SUBSISTENCE AGRICULTURE AND STRUCTURAL CHANGE

We group our further analysis into two parts. First, we present some general considerations on subsistence and agricultural change, and second we derive some hypotheses on the relationship between both.

3.1 Basic Considerations

For the following analysis we define subsistence as the fact that a farm household is only to a limited extent integrated in product markets because a significant share of output is consumed by the producers themselves. Based on this definition we make two assumptions about subsistence households. First, we assume that the degree of subsistence is inversely correlated with the relative surplus over the amount of output the household members consume themselves. Second, we assume that production and consumption decisions, and decisions on factor use within or without the farm household are each theoretically separable (HANF 1996). This is justified by the fact that the average farm in our sample sells around 75% of its production output to the market (see below) and that markets exist for all factors. It is thus more appropriate to speak of *semi-subsistence farms*.

The assumption of theoretical separability allows to analyse agricultural change as largely induced by relative market prices, which determine decisions on production and factor allocation. Increasing prices of capital as opposed to

relatively decreasing prices of labour lead to an increasing labour intensity with respect to capital and vice versa. These adjustment processes tend to result in the *efficient allocation* of factors. The force to efficiently allocate factors will be particularly pronounced in cases of strong *income pressure*. This income pressure may for example be the consequence of deteriorating agricultural terms of trade as observed in Poland in the course of transition (see Figure 1). A semi-subsistence farmer principally has two major options when faced with increased income pressure (BRANDES 2000):

1. He may decide to seek employment of his factors *outside agriculture*. The core determinant of this decision is the remuneration of factors in other sectors of the economy, hence their *opportunity costs*. If other sectors develop more rapidly, relatively higher factor remuneration may imply a significant suction that forces factors into uses outside agriculture. This is particularly valid for capital and labour, and results in the creation of rural employee households or urban migration. As a consequence, the household may still consume most of his own-produced food, but the farmer's major income now is from non-agricultural sources.
2. In case the first option is blocked by certain exit barriers, which are to be discussed below, the farmer may choose to stay within agriculture and attempt to compensate the reduced factor incomes by rationalising existing production activities, shifting to more remunerative activities, or increasing his factor stocks via lease or acquisition. An increase of factor productivity can principally be achieved by realising technical progress, e.g., by mechanisation, introduction of new plant varieties or artificial insemination, or adoption of new management techniques. Technical progress is usually implemented by investment in human and/or physical capital. This developmental path can thus be characterised as *commercialisation*.

The paper's central hypothesis is that the degree of subsistence will diminish as structural change induced by these exit-or-stay decisions progresses. As we have seen, the decision on which developmental path to choose is highly determined by the factor incomes that can be achieved in other sectors. If these incomes are low, a semi-subsistence farm might be forced to either commercialise or accept income losses. However, even in the case of high opportunity costs for labour and/or capital, a number of other *exit barriers* may seriously delay any adjustment processes.³ In the following, we refer to the problem of quasi-fixed assets in agriculture, as well as the effects of the use of factors that do not require permanent payment (GARDNER 1992).

The notion of quasi-fixed assets draws on the following observation: many assets used for agricultural production exhibit the property of their salvage value

³ This has motivated some authors to speak of an 'evolutionary' theoretical approach as opposed to the frictionless neoclassical paradigm, where adjustment processes occur without any delay or cost (BRANDES 2000; HANF 1996).

being much lower than their acquisition value, particularly buildings and specialised machinery. With regard to opportunity costs, this is also valid for human capital. The bulk of the acquisition value therefore counts as sunk costs and must not be regarded in decisions on the continuation of production. Although an increased price-cost squeeze may make further investment in the sector unprofitable, it does not force current producers out of business because their assets are largely immobile (i.e., cannot be reallocated to other, more productive uses). This path-dependency may result in long-lasting delays of structural adjustment if producers with old equipment continue to operate although the profitability of their units does not justify any further investment, while growing enterprises which have to account for the whole costs of investment cannot bid them out of the market.

A similar problem arises if production factors such as owned land, family workforce, or farmers' equity do not require permanent payment. In this case, owner-producers have an advantage over those who have to lease land and labour or rely on external finances, because the latter continually need to generate sufficient profits to pay these factors. In times of deteriorating product prices, this implies a significant chance of survival for subsistence farming based on owned factors.

In the subsequent analysis we thus empirically explore the following two related issues:

1. What are the prospects for semi-subsistence households to leave the agricultural sector?
2. In the group of agricultural producers, is there an observable inverse dependency of subsistence on structural change?

In dealing with the first question we will primarily look at the relative remuneration of factors within and without the agricultural sector. In times of high rural unemployment it will be instructive to see whether effective off-farm employment opportunities do in fact constitute significant opportunity costs for farm family members. Generally, if factor allocation has fully adapted to existing price relations, the marginal factor income should be equal in all uses. Although we observe only the average income, this should be close together if structural change has come to an equilibrium, and significantly different if to a large extent change still has to be accomplished.

The second question is investigated by testing several hypotheses on the relationship between degree of subsistence and structural change, which are presented in the following subchapter.

3.2 Hypotheses on the Dependence of Subsistence on Structural Change

If subsistence is dependent on the progress of structural change, the following hypotheses must hold:

First, profits from agriculture should generally be larger for less subsistence-oriented producers. This is due to the simple notion that autarchy in production implies the renunciation of trade and specialisation benefits. Market integration in turn should result in increased efficiency of factor allocation and production and thus in higher profits as compared with self-sufficiency. The expectancy of increased profits also provides the principal *incentive* for subsistence producers to commercialise and to participate in markets.

Second, subsistence should be positively correlated with the participation of family members in non-agricultural labour markets. A large proportion of off-farm income implies that the household has in fact left the agricultural sector. However, at least for the rural households investigated here, we hypothesise that consumption of self-produced food temporarily remains important as an insurance mechanism. Our sample does not contain households that do not pursue any food production at all or that have migrated to urban areas.

Third, we expect that the active participation in all markets for factors other than labour is associated with a low degree of subsistence. Subsistence employee households are unlikely to act as a purchaser on land and capital markets. For land and capital, this concerns both sale and rental markets. Empirically it can be observed as a share of rented land, the degree of financial leverage, and as investment outlays on land purchases. At early stages of structural change, subsistence farms are also unlikely to let their land to others, since this implies that own consumption needs cannot be met anymore. This in turn means that commercial farms may have difficulties in acquiring land.

Fourth, as a result of negligible engagement on factor markets, we also hypothesise that subsistence is inversely correlated with land and capital stocks. This relation may however be much less pronounced with regard to labour resources. Furthermore, the lower the degree of subsistence is, the more we expect a higher degree of mechanisation and a more favourable age structure of equipment. Commercial farms are likely to show higher levels of investment in productive assets such as farm buildings or agricultural machinery. Therefore they also have a higher capital intensity with regard to land as compared with subsistence farms, at least if commercial farms have more difficulties in acquiring land than in acquiring machinery. As a consequence, mechanisation as measured in hp per ha may also be higher. In addition, commercial farms are assumed to modernise their equipment more frequently. An interesting aspect is to look at investment in alternative income generating activities in rural areas such as agrotourism. Subsistence farms may also pursue these as an alternative strategy for generating cash revenue.

Fifth, the value added per agricultural labour unit should be lower, the higher the degree of subsistence is. According to our considerations on capital and land stocks, subsistence production is likely to be associated with low capital and land intensity with regard to labour. As a consequence, labour incomes in

subsistence agriculture are low, which does not necessarily hold for the remuneration of land and capital. In turn, commercially-oriented farms may show a high remuneration of labour and a lower return on capital and land.

Sixth, we expected that all individual factors that support productivity enhancement in agriculture will be negatively correlated with the degree of subsistence. This is due to the notion that increased productivity is likely to result in a surplus above the family needs which can be sold to the market. We only mention those individual factors that seem most important. First, we assume that people with a higher degree of formal agricultural education will also be more actively engaged in structural change and be more able to manage productivity enhancement in agriculture. Second, this is likely to be accompanied by a more intensive use of advisory services. Third, farmers who show more innovative behaviour with regard to agriculture are presumably those who are more commercially-oriented. The opposite is true for individual risk aversion: more risk-averse farmers are likely to be reluctant to implement technical progress and probably prefer a more self-sufficient mode of production. Finally, older farmers might be less open to change than younger ones.

4 SUBSISTENCE AND STRUCTURAL CHANGE IN FORMER TARNÓW AND RZESZÓW VOIVODSHIPS

In the following, these relationships are studied at the micro level by evaluating the results of a cross-sectional farm survey conducted in the former Tarnów and Rzeszów *voivodships* in the year 2000. The empirical analysis is based on a geographically stratified random sample of farms in the database of the official extension service ODR (*Ośrodek Doradztwa Rolniczego*, Extension Centre of Agriculture), which contains approximately 25% of all farms identified by the Central Statistical Office (*Główny Urząd Statystyczny*, GUS). The sample consists of farms that show at least some degree of commercialisation and market integration and that account for the bulk of the traded agricultural produce in the research area. We measure the degree of subsistence as the proportion of self-consumed food in relation to the value of total agricultural output. For further details on the survey see PETRICK (2001).

A first inspection of the farm sample revealed that the degree of subsistence in fact ranges from 0 to 100%. This large variation alone already suggests that differentiation processes have already started up, and that different farms are on different time points on their developmental paths. In order to test the relationship between subsistence and structural change more rigorously, Table 2 and Table 3 show the results of a mean value comparison for two subgroups of our sample. We divided the sample into two equally-sized groups according to their degree of subsistence being above or below the median value (= 17.3%) of the total sample. In Table 2, along with some general statistics on the farm households as such, the statements are grouped according to factors of

production and the criteria of resource stocks, mobility, which largely means activity on factor markets, and remuneration. In general, for profit calculations, we do not make any allowances for owned factors. As stated above, even in the longer term, these factors do not require permanent payment and thus may not be relevant for decision making at the margin.

We start the analysis with the hypotheses on structural change. We see that most of our hypotheses on the relationship between factor reallocation processes and subsistence production are supported by the data in Table 2. Specifically, we observed that subsistence farmers are those with lower profits, smaller resource stocks of land and capital, and in general a less pronounced participation on factor markets. On the other hand, the group of commercially-oriented farms in fact participates in these markets and exploits gains of trade and specialisation. However, their average farm size is still rather small and growth has apparently been possible only to a limited extent.

Factor remuneration on commercially-oriented farms is generally around twice as high as on subsistence farms (though not always significant), which reveals the benefits of increased efficiency of factor allocation. With regard to land and capital, these benefits apparently by far outweigh the supposed higher labour intensity on subsistence farms. This implies that commercial farms will in principle be able to bid subsistence farms out of the land market. The fact that farm growth so far has been limited and that even subsistence farms have some, though significantly less, land rented suggests that additional exit barriers as discussed above are very relevant. These may be due to comparatively older farmers and older machinery which point to quite low opportunity costs for human and physical capital. Furthermore, a lower degree of financial leverage means that subsistence farming is based more on equity capital, which in turn does not require permanent payment.

Astonishingly, land rents paid to lessors are on average smaller for commercial farms, and are substantially lower than the value added per ha (although this indicator still includes remuneration of family labour and equity). A possible explanation for this phenomenon could be that the land rental market is generally thin and that land rent is determined by other factors than relative scarcities alone. For example, commercial farms might be in a better bargaining position than subsistence farmers.

With regard to the share of family labour force with off-farm employment, we observed that it is not significantly different for both types of farms. Across both groups, on average, every fifth member of the family is engaged full-time in non-agricultural activities, which is approximately identical to the corresponding value for all farms in the region (see Table 1). This is a first indication that differentiation processes have not yet become visible on the labour market. Two explanations may be possible: First, subsistence households may have difficulties to find more extensive off-farm employment, or second, commercial

farms may still be dependent on non-agricultural sources to meet their income needs because productivity enhancement has not yet resulted in sufficient extra profits.

Table 2: Stocks, Mobility, and Remuneration of Factors of Sample Farm Households (Mean Values in 1999)

Reference	Criterion	Variable	Subsistence-oriented Farms (N=162)	Commercially-oriented Farms (N=162)	Significance
Farm Household		Degree of Subsistence (Own-consumed Goods in % of Total Value of Production) **	40.0	6.6	<.001
		Total Farm Profit After Interest and Taxes (zł) ^a *	4,089.7	12,695.1	.049
		No. of Household Members incl. Children	5.0	4.7	.068
Land	Resources	Total Land Cultivated (ha) **	8.0	14.3	<.001
		Share of Rented Land (% of Total Land Cultivated) **	10.7	25.8	.003
	Mobility	Share of Land Let to Others (% of Total Land Owned)	.3	.5	.494
		Investment Outlays on Land Purchases 1997-99 (zł per Farm) **	400.0	2,045.1	.003
	Remuneration	Value Added in Agriculture (zł per ha) ^a	688.2	1,883.2	.103
		Land Rent Paid to Lessors (zł per ha)	139.9	108.2	.284
Labour	Resources	Labour Force Capacity Living in Farm Household (Labour Units) ^b	3.6	3.6	.589
		Age of Farmer (Years) **	45.9	42.9	.006
	Mobility	Share of Workers (Labour Units in % of Family Labour Force) **	.4	2.6	.016
		Share of Family Labour Force with Off-farm Employment (%)	22.1	20.6	.622
	Remuneration	Value Added in Agriculture (zł per Family Labour Unit Engaged On-farm) ^b	2,137.0	5,823.4	.237
		Income from Off-farm Activity (zł per Family Labour Unit) *	3,424.9	8,236.7	.031
		Share of Income from Public Transfers (%) **	21.2	7.8	<.001
Capital	Resources	Capital Stock of Farm (ths zł) **	175.1	282.7	<.001
		Age of Latest Tractor Acquired (Years) **	12.3	10.5	.024
		Tractor Power (hp per ha of Total Land Cultivated)	5.7	6.6	.216
	Mobility	Leverage (Farm Debt in % of Capital Stock) **	5.4	9.1	.003
		Savings (Household Savings in % of Capital Stock)	2.9	4.1	.127
	Remuneration	Return on Equity (%) ^a **	3.9	9.0	.007
		Cost of Farm Debt (Annual Interest in %) **	12.1	7.1	.013
	Interest on Savings (Annual in %) ^c	10.0	10.0	-	

Notes: Missing values were row-wise excluded; 4.227 zł = 1 € (annual average 1999); * Mean values are significantly different at 95% according to two-tailed *t*-test; ** Different at 99%; ^a Value of self-consumed goods is included in profit calculation; ^b 1 labour unit = 270 days per adult household member; ^c Statements of National Bank of Poland on interest rates of 12-month deposits by major commercial banks.

Source: Authors' calculations based on IAMO Poland farm survey 2000 (except for interest on savings, see note ^c).

The figures on labour remuneration shed more light on this issue. First, the difference of value added per labour unit between both subgroups supports the hypothesis of higher capital and/or land intensity on commercial farms. It is,

however, not significant at 95%. Second, average income from off-farm sources is generally higher than value added in agriculture for both subgroups. However, the reported off-farm income is biased upwards, since the opportunity costs for those that do not participate in the off-farm labour market are not observed and are assumably much lower. Bearing this in mind, any difference could still be interpreted as an insurance premium producers implicitly pay for the security to keep an at least basic living standard on their farm. In this case, the conclusion would be that the labour market is in equilibrium and that there is little need for adjustment.⁴ It is, however, sobering to see that the off-farm income per labour unit generated by members of subsistence farms is *only at 17% of the national and 19% of the voivodship average wage* (average wage of all sectors in 1999 according to GUS 2000, *voivodship* data as unweighted average of new Małopolska and Podkarpackie *voivodships*). This means that, although there is a supply of jobs that are substantially higher paid than engagement on subsistence farms, people on these farms are not able to get these jobs and their effective opportunity costs are thus very low. Even on the regional level there is thus a highly segmented labour market. We assume that this segmentation is mainly due to individual characteristics such as education or age structure, which is supported by the observation of much higher off-farm income per person on commercial farms.

The official unemployment rates of a relatively modest 10.2% in Małopolska and 14.5% in Podkarpackie *voivodships* in 1999 (national average: 13.1%; see GUS 2000) do not allow the conclusion that a *lack* of job offers is the only reason for low opportunity costs of the subsistence farm labour force. A more plausible reason could be that *in the relevant market segment* (i.e., less sophisticated and with agricultural background) salaries are substantially below the average wage. Nevertheless, in comparison with the national and regional average, remuneration and productivity of the workforce on subsistence farms is quite low. This is usually labelled as *hidden unemployment*. The comparison reveals that subsistence farms in fact 'store' a substantial amount of unproductive labour force. Opposed to that, commercial farms with an already higher value added per labourer are, due to higher opportunity costs, much more likely to lose a part of their workforce in the future.

The divergence, mainly in terms of quality, between labour supply of subsistence farms and employment opportunities in rural areas must thus be regarded as a major bottleneck for structural change in agriculture. Considering the recent increase of the share of people working solely on-farm (see Table 1), it becomes evident that the unfavourable situation on rural labour markets has not only halted but even reversed structural change.

⁴ As indicated above, the decisive criterion to assess the need for adjustment is of course the *marginal* revenue generated by the last unit (the last hour) of labour force. It is well possible that, at least for the subsistence group, this is close to zero both on- and off-farm.

The current lack of sufficient income generating opportunities in rural areas is partly cushioned by public transfers, particularly by the agricultural social insurance scheme KRUS (*Kasa Rolniczego Ubezpieczenia Społecznego*), which is highly subsidised by the government. Table 2 shows that subsistence farms receive a significantly higher share of income from these transfers.

Return on equity is significantly higher than the cost of farm debt for commercial farms and vice versa for subsistence farms. Under the assumption of diminishing returns on capital use, this means that commercial farms might still need to expand their capital stock, while subsistence farms are already over-equipped. With regard to capital intensity, there hence seems to be still significant need for adjustment. However, two facts qualify this statement: First, return on equity as shown in Table 2 does not include payment of family labour and management. As a result, it can be assumed that even commercial farms may generate little more return than the required interest on credit if allowances for family labour were made. Second, due to their cross-sectional nature, we generally cannot prove how robust these numbers are over time, and return on equity may be particular sensitive to annual fluctuations in revenue.

It is important to notice that agricultural credit in Poland is highly subsidised by the government as well. This results in the fact that costs of farm debt are lower than the interest on savings, at least for commercial farms, which apparently have comparatively better access to these subsidised credit sources. The difference between these farm groups raises doubts that subsidies are allocated equitably among farms, and the reported difference between credit and savings interest bears lively testimony to the major economic distortions induced by this subsidy. If commercial interest rates were charged to farmers, probably few agricultural activities would qualify for credit funding.

Interestingly, the savings rate of subsistence households is not significantly different from that of the commercial farms. This can be taken as an indication that the former do not suffer from worse access to savings services as opposed to the latter, although subsistence farms face higher credit costs.

Table 3 illustrates the relationship between degree of subsistence and factors that accelerate productivity enhancement in agriculture. As before, the data supports the notion that the diminishing importance of subsistence production is accompanied by intensified structural change. Commercially-oriented farmers are better educated, use advisory services more frequently (though not significantly), exhibit more innovative behaviour and are less risk averse. Furthermore, they invest more both in total and with respect to productive assets in agriculture, which corresponds with their better access to subsidised credit. However, although nominal differences are high, it is puzzling to see that, with the exception of farm building renovation, differences between subsistence and commercial farm households are not statistically significant at 95%. This is assumed to be caused by the relatively small number of non-zero observations

with regard to these items (e.g., only 116 in total for investment in tractors and machinery).

The observation that subsistence farms invested more in telecommunication may be more due to the fact that they still have a lot of individual infrastructure to catch up on rather than being an expression of innovative behaviour. Commercial farms, however, invested more in guestrooms for agrotourism (although on a low level), which indicates an innovative strategy of non-agricultural income generation.

Further instructive information on the future plans of both subgroups of farms is also shown in Table 3. Four observations are of particular importance: First, today's commercial farms plan to grow and specialise further in the future to a much larger extent than subsistence farms. Second, in contrast, relatively many more subsistence farms attempt to exit farming and find off-farm employment. Third, the wish to pass on the farm to later generations is much more pronounced on subsistence farms, although the objective chances to be able to do so seem to be comparatively smaller. This may be an expression of a particularly conservative and traditional attitude in general. Fourth, roughly one third of both types of farms do not plan any changes at all. This probably also indicates a rather conservative and fatalistic, or even apathetic, state of mind among a significant proportion of farmers since people have apparently accepted their comparatively poor income situation without resistance.

5 CONCLUSIONS

In the analyses of the previous chapters we have shown that there are strong linkages between structural change in terms of factor reallocation and productivity enhancement processes on the one hand, and the extent of subsistence production on the other. The empirical facts provide evidence for the proposition that subsistence agriculture in Southeastern Poland will diminish as structural change in the agricultural sector progresses. Furthermore, it was ascertained that structural change has already started up and that – according to statements of farmers – it is likely to continue in the near future. Subsistence agriculture in the sense that a substantial share of total agricultural output in a given region is consumed by the farm households themselves is therefore unlikely to persist in the long run.

Table 3: Human Capital, Current Investment, and Future Plans of Sample Farm Households (Frequencies or Mean Values in 1999)

Factor	Variable		Subsistence-oriented Farms (N=162)	Commercially-oriented Farms (N=162)	Significance
Human Capital	Formal Education of Farmer (Frequencies)	Primary School (%)	11.7	9.9	-
		Vocational School (%)	50.6	42.6	-
		Liceum/Technical School (%)	32.7	39.5	-
		University (%)	4.9	8.0	-
		Use of Advisory Service (Times in 1999)	12.3	14.2	.137
		Innovator in Agriculture (on Ordinal Scale 0=min to 4=max) ^a **	.8	1.2	.005
	Risk Aversion (on Ordinal Scale 0=min to 7=max) ^b **	4.0	3.0	<.001	
Current Investment	Investment (Annual Average of 1997-99)	Total (zł per Farm)	20,042.1	104,093.7	.133
		Renovate Farm Buildings (zł per Farm) *	3,554.4	11,217.7	.032
		Buy Tractors and Agricultural Machinery (zł per Farm)	5,325.4	58,751.5	.270
		Modernise Telephone Network (zł per Farm)	406.9	290.7	.483
		Establish Guestrooms for Agrotourism (zł per Farm)	.0	432.1	.169
Future plans	Future Plans (Frequencies)	Increase Farm (% of Cases)	21.2	40.4	-
		Specialise in Certain Branches (% of Cases)	34.2	54.3	-
		Exit Farming and Find Off-farm Employment (% of Cases)	13.0	7.9	-
		Invest in Certain Assets (% of Cases)	14.4	26.5	-
		Pass on Farm to Next Generation (% of Cases)	37.0	29.1	-
		Don't Plan Any Changes (% of Cases)	39.0	31.1	-

Notes: Missing values were row-wise excluded; * Mean values are significantly different at 95% according to two-tailed *t*-test; ** Different at 99%; Differences of frequencies were not tested; ^a Measured as frequency of implementing certain innovative activities; ^b Measured as willingness to pledge certain assets as collateral.

Source: Authors' calculations based on IAMO Poland farm survey 2000.

However, the future pace of this structural transformation will crucially depend on the functioning of factor markets that efficiently channel the allocation of resources within the economy. With regard to the three basic factors of production, the situation can be summarised as follows:

- The major bottleneck on the *labour market* is represented by the poor employment opportunities of the subsistence farm labour force. Labour productivity is comparatively low both on- and off-farm if there are any off-farm job offers at all. The opportunity costs of labour thus are low, although the average income generated outside agriculture by members of subsistence households is less than one fifth of both the regional and national average salary, which implies substantial hidden unemployment. In the course of transition, the inflow of a redundant work force into the farm sector probably even temporarily reversed structural change. As long as this situation persists, subsistence agriculture will continue to be the labour force buffer of the whole Polish economy.

- This has important repercussions on the *land market*. A persistently 'stored' labour force on comparatively inefficient subsistence farms also acts as a regional land buffer that impedes the development of commercially-oriented farms. Due to this lock-in situation, farm growth has so far been modest. As a result, even commercially-oriented farms are forced to generate a substantial share of their income from off-farm sources, although their overall economic performance in agriculture is substantially better than that of the subsistence group.
- The *market for capital* is highly distorted by interest subsidies the government grants on agricultural credit, which drives credit interest below the market rate for savings. These subsidies are accompanied by remarkable investment outlays for productive assets in the group of more commercially-oriented farms, while subsistence-oriented farms seem to be less able to exploit the subsidies. Generally, interest subsidies ensure that the relatively low capital remuneration achieved in the agricultural sector is still sufficient to attract bank credit. Consequently, also with regard to capital, the farm sector stores resources that could be used more efficiently in other sectors of the economy.

It is therefore concluded that rural factor markets currently are not able to bring about rapid structural change in Southeastern Poland. The paucity of productive employment opportunities for the rural labour force prevents the reallocation of land and capital towards more efficient uses, which in the case of capital is actively supported by the government policy. Subsistence production can be regarded as merely the visible symptom of this inefficient resource allocation.

While the key to the problem clearly lies in the rural labour market, possible cures are hard to find. Keeping in mind the prospect of the currently hidden unemployed protesting on the streets against their situation even makes the government support policy of subsidising credit and pensions understandable. It does, however, not address the actual issue.

REFERENCES

- BRANDES, W. (2000): Wettbewerb in der Landwirtschaft aus Sicht der evolutarischen Ökonomik, *Agrarwirtschaft*, Vol. 49, pp. 279-290.
- FRENKEL, I., ROSNER, A. (1999): Prospects for Change in the Employment Structure of the Rural Population, *Więś i Rolnictwo*, supplement to No. 2, Vol. 103, pp. 65-74.
- GARDNER, B. (1992): Changing Economic Perspectives on the Farm Problem, *Journal of Economic Literature*, Vol. 30, pp. 62-101.
- GŁÓWNY URZĄD STATYSTYCZNY – GUS (1998): Systematyka i charakterystyka gospodarstw rolnych, Powszechny spis rolny 1996, *Seria Wydawnicza Narodowy Spis Powszechny*, GUS, Warszawa.
- GŁÓWNY URZĄD STATYSTYCZNY – GUS (1999): Rocznik Statystyczny Rolnictwa 1998, GUS, Warszawa.

- GLÓWNY URZĄD STATYSTYCZNY – GUS, (2000): Rocznik Statystyczny Rzeczypospolitej Polskiej 2000, GUS, Warszawa.
- HANF, C.-H. (1996): Beziehungen zwischen Haushalt und Betrieb in der Landwirtschaft, in: HAGEDORN, K. (ed.): Institutioneller Wandel und politische Ökonomie von Landwirtschaft und Agrarpolitik, Festschrift zum 65. Geburtstag von Günther Schmitt, Campus Verlag, Frankfurt (Main), pp. 47-66.
- HEIDHUES, T. (1976): Change: A Permanent Phenomenon in Agriculture, *European Review of Agricultural Economics*, Vol. 3, pp. 151-162.
- KOWALSKI, Z. (1993): Back to Market: Polish Family Farming in the 1990s, *Canadian Journal of Agricultural Economics*, Vol. 41, pp. 349-356.
- NAGENGAST, C. (1991): Reluctant Socialists, Rural Entrepreneurs. Class, Culture, and the Polish State, Westview Press, Boulder.
- PETRICK, M. (2001): Documentation of the Poland Farm Survey 2000, *IAMO Discussion Paper No. 36*, Halle (Saale), IAMO, <<http://www.iamo.de/no36.pdf>>, 14.11.2003.
- QUAISSER, W. (1987): Agrarpreispolitik und bäuerliche Landwirtschaft in Polen, *Giessener Abhandlungen zur Agrar- und Wirtschaftsforschung des Europäischen Ostens*, Bd. 150, Duncker & Humblot, Berlin.
- SCHINKE, E., unter Mitarbeit von HUŇÁČEK, Z. (1983): Der Anteil der privaten Landwirtschaft an der Agrarproduktion in den RGW-Ländern, *Giessener Abhandlungen zur Agrar- und Wirtschaftsforschung des Europäischen Ostens* Bd. 127, Duncker & Humblot, Berlin.
- THO SEETH, H., CHACHNOV, S., SURINOV, A., VON BRAUN, J. (1998): Russian Poverty: Muddling Through Economic Transition with Garden Plots, *World Development*, Vol. 26, pp. 1611-1623.
- TIMMER, C.P. (1988): The Agricultural Transformation, in: CHENERY, H., SRINIVASAN, T.N. (eds.): Handbook of Development Economics, Vol. I, Elsevier Science Publishers B.V., Amsterdam, pp. 275-331.
- TOMICH, T.P., KILBY, P., JOHNSTON, B.F. (1995): Transforming Agrarian Economies, Opportunities Seized, Opportunities Missed, Cornell University Press, Ithaca.
- WOJCIECHOWSKA-RATAJCZAK, B. (1999): Basic Economic Conditions and Directions of Structural Policy Towards Rural Areas and Agriculture in Poland, *Wiś i Rolnictwo*, supplement to No. 2, Vol. 103, pp. 42-53.
- WOŚ, A. (1999): Polish Agriculture in the System Transformation Period (1989-1997), *Zagadnienia ekonomiki rolnej*, supplement to No. 2-3, pp. 3-31.
- ZBIERSKI-SALAMEH, S. (1999): Polish Peasants in the "Valley of Transition": Responses to Postsocialist Reforms, in: BURAWOY, M., VERDERY, K. (eds.): Uncertain Transition. Ethnographies of Change in the Postsocialist World, Rowman & Littlefield, Lanham, pp. 189-222.

THE MARKET POTENTIAL AND PATTERNS OF CONTEMPORARY AGRICULTURE IN ROMANIA'S NORTHWESTERN PLAIN

CSABA M. KOVÁCS

1 INTRODUCTION

Romanian Agriculture went through major transformations after the political changes of December 1989, due especially to the structural reorganization of land ownership. Agrarian reform, started in 1990 with the liquidation of the socialist cooperatives and regulated by the new land ownership law (No. 18/1991), along with a whole series of other laws and government decrees, triggered a process of transformation which could be best characterised as chaotic and painful both for the farmers and for the consumers.

The main feature of the land ownership structure that resulted from this is the high degree of fragmentation of the property, the great majority of the former co-operative lands being tended today by farmers whose property is small, usually between 1 and 5 ha or even less. Although part of these farmers are associated with small agricultural enterprises, their weight in the whole structure of private land property is minor (less than a third), they usually cultivate a small number of crops, do not raise livestock and achieve mediocre results. The private commercial societies which were formed after 1990 cultivate a larger number of crops, enjoy a higher degree of productivity, but seldom raise livestock. The state enterprises, reorganised as shareholding societies (stock companies), still retain an important amount of agricultural land, are waiting for new privatisation laws and usually have serious financial problems.

The proportion of the agricultural workforce in Romania rose after 1989 (from 27% to about 35% today), due especially to the major crisis of manufacturing industries. This phenomenon further contributed to the fragmentation of land property and to the pauperisation of the farmers. The chronic lack of financial resources became visible in the high amount of manual and animal labour force, and is also the main cause of the low level of productivity. On the other hand,

small properties cultivate a large variety of crops (though cereals are predominant) and usually raise a small number of livestock, just enough for self-sufficiency. In these conditions, the degree of specialization is very low and an important part of the agricultural households are mainly subsistent. A small part of the farmers (usually in villages next to urban centers) are capable of producing and selling surpluses, formed essentially of vegetables, fruits and animal products. The food processing industry of these towns is mainly supplied by the commercial societies (either private or state-owned).

A major problem of analysing the importance of Romanian subsistence-agriculture is that there are no available statistics concerning either the quantities of sold products or the amount of financial revenues resulting from the sale of these products, especially for the small farmers who paid no revenue taxes in the nineties (they paid only a lump sum relating to the extent of their property). That is why we had to find a method which could indirectly delimit the territorial units where agriculture has better market access from those who are essentially subsistence-oriented.

2 ANALYTICAL APPROACH

2.1 The Study Region

The agricultural region targeted in this study is the Someş Plain, situated in northwestern Romania and representing the northern third of the Pannonian Plain positioned east of the Hungarian border. The plain is limited to the north-east by the volcanic range of Oaş-Gutâi Mountains, to the east by the Western Hills, to the south by the Barcău river, to the west and the north by the border with Hungary and Ukraine. This area includes 50 communes (basic administrative units in Romania) of which 5 are urban. The urban center of the region and the biggest town is Satu Mare (the capital of the same county, with more than 130,000 inhabitants), followed by Carei (about 26,000); there are three other small towns (with around 10,000 inhabitants each) and 8 communes belonging to Bihor county (with Oradea as capital).

2.2 Database and Methodology

The database taken into consideration in order to establish the relative market potential mainly examines three categories: the population (demographic potential), the land-ownership structure (the property potential) and the transportation infrastructure (the communication potential). Though these parameters cannot substitute the weight of merchandise production expressed in monetary units, they can offer a starting point for analysing the level of market access for each administrative unit.

The demographic potential was determined as a result of agricultural density and the weight of non-agricultural manpower. The agricultural density expresses

the number of inhabitants who are supported by agricultural land, in other words, the amount of potential consumers for the agricultural products. From this point of view the biggest consumers are obviously urban centers, but the rural population (whose proportion in the Someș Plain is 48.5%) also has its needs and therefore they potentially consume half of every kind of product. The weight of non-agricultural manpower reflects, on the one hand, the importance of secondary or tertiary economic activities and on the other hand the higher or lower need for agricultural manpower as a consequence of the mechanization level. In this sense, a lower level of agricultural manpower is a positive feature, as it shows a higher variety of economic profile and the degree of economic development, and thus of the purchasing power of the inhabitants.

The property potential is a result of the average weight of the private associations and of the average dimension of agricultural exploitations, and expresses the level of property-organisation and fragmentation. The average weight of the private associations and societies expresses the proportion of private agricultural land owned by associations and private commercial societies, and it shows the propensity of the farmers to organise themselves after 1990 into bigger properties than individual households. Though this kind of organisation apparently offers advantages from the financial and productivity points of view, and thus for the market competition, their weight is still low (22% in average). The average dimension of agricultural exploitation represents the average surface of privately owned agricultural land (individually, in associations or in commercial societies) divided by the number of households. This shows mainly the degree of fragmentation of the private land property and has an average value of 2.6 ha in the Someș Plain (usually between 1 and 6 ha).

The communication potential was calculated as an average between the dotting of the geographic distance from the urban centres (the positioning potential) and that of the transportation infrastructure (the transportation potential). The positioning potential was calculated as a ponderate average of the road distances from each commune centre to the urban centres, including the capitals of two neighbouring counties (Oradea and Baia Mare) and the town of Marghita, situated in the north of Bihor county (the ponderation of the averages was made according to the total population of these towns). The transportation potential is expressed by the sum of dots resulting from the number and rank of roads and railroads entering into each centre of commune.

In order to make these parameters comparable, in each case we converted their values into a scale from 0 to 10, designating 0 points as the minimum and 10 points for the maximum value of each of them (Figure 1).

Figure 1: The Calculated Parameters of the Market Potential



Source: Own depiction.

This method made it possible not only to compare the six analysed parameters but also to cumulate them; the final parameter obtained as the sum of the previous three being defined as the market potential (Figure 2).

Figure 2: The Values of Market Potential in the Communes of the Someş Plain

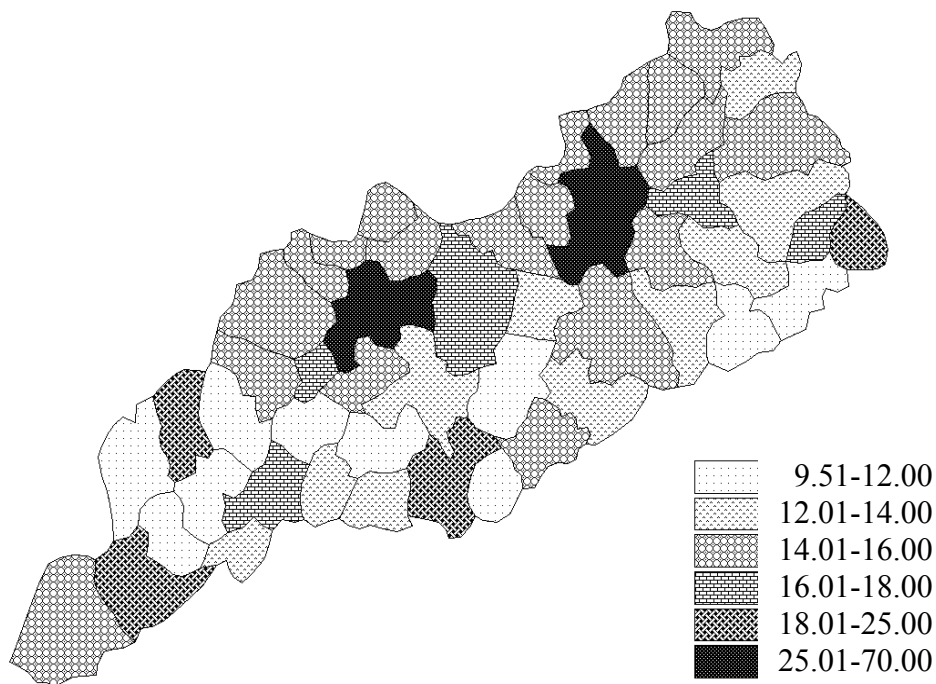

Source: Own depiction.

3 CLASSIFICATION OF REGIONS

3.1 Market Orientation

The agriculture of the Someş Plain can be classified by administrative units into four main categories (Figure 3):

- Subsistent agriculture with the values of the market potential below 14 points;
- Intermediate agriculture where the market potential is between 14 and 18 points;
- Quasi-commercial agriculture with a potential between 18 and 25 points;
- Commercial agriculture, where the market potential is above 25 points.

Figure 3: The Categories of Agriculture in the Someş Plain, According to the Market Potential of the Communes

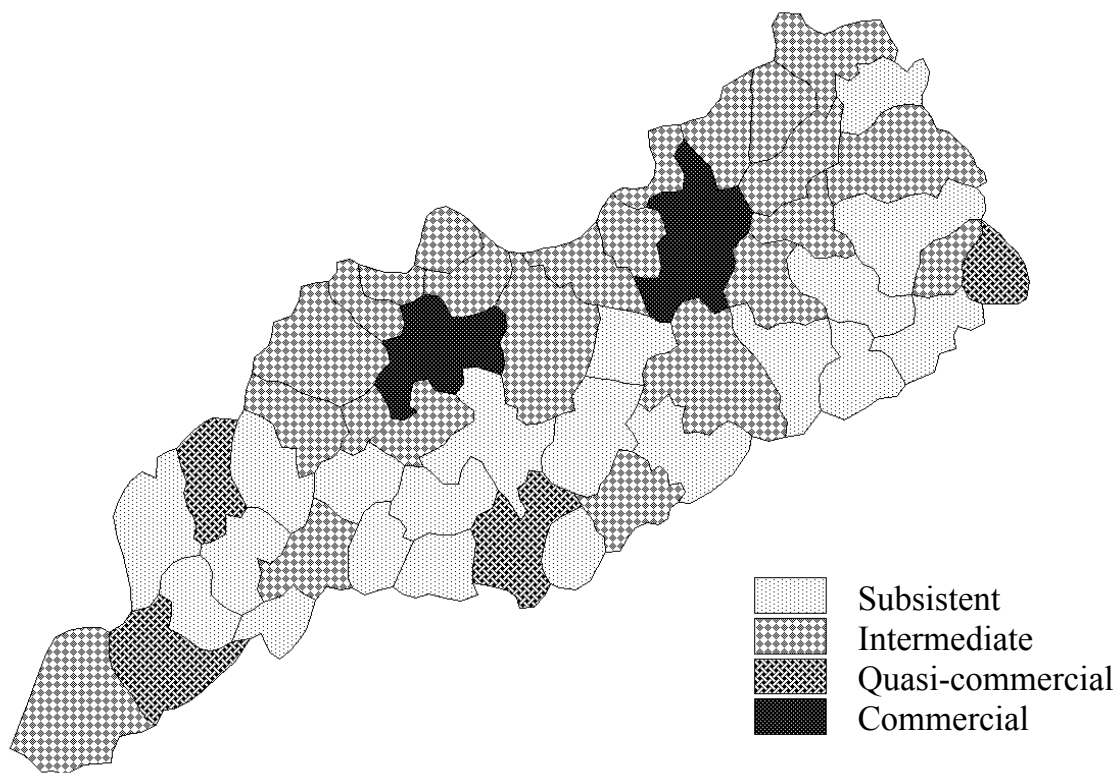

Source: Own depiction.

3.2 Classification According to Production Patterns and Commercialisation

The territorial differences of agriculture can also be emphasized by the values of the crops/livestock balance, calculated according to the relative importance of the crop or animal production for each commune (KOVÁCS 2002). The market potential related to the crops/livestock balance allows the identification of several types of agriculture characteristic of larger areas within the Someş Plain and which are thus appropriate for establishing the main patterns of agriculture. These patterns can be further divided into sub-patterns either by their geographic position, or by their natural features, or by the profile of agriculture (Figure 4).

Figure 4: The Patterns and Sub-patterns of Agriculture in the Someș Plain

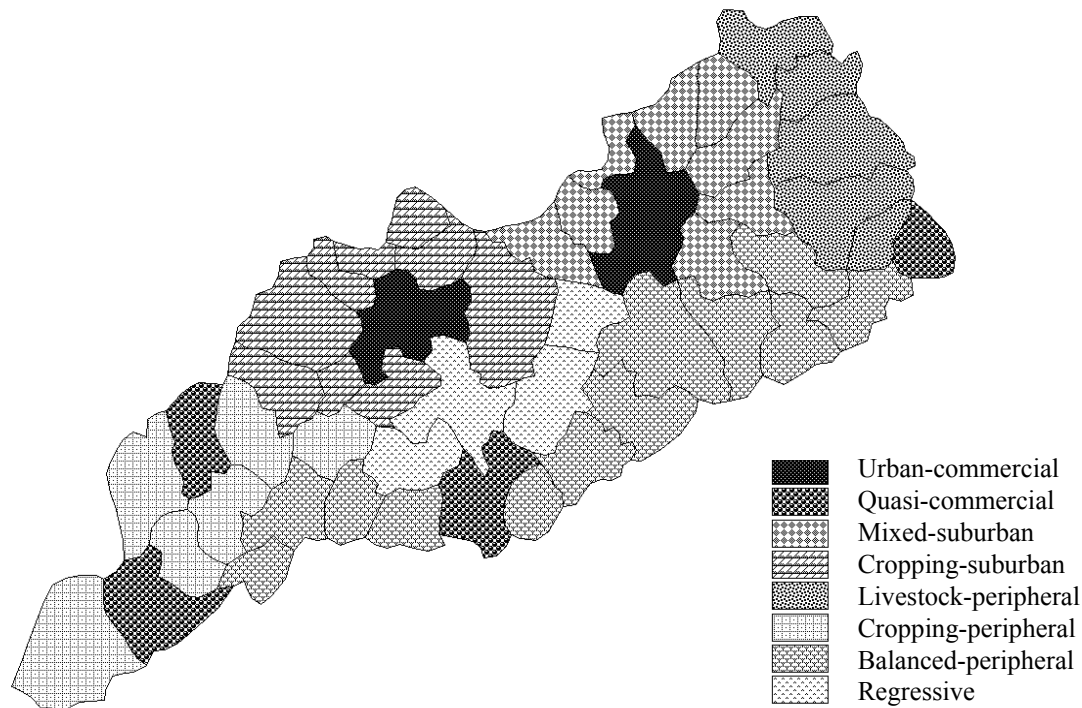

Source: Own depiction.

The established patterns and sub-patterns are:

1. The commercial pattern is represented in the Someș Plain by only six units, from which five are urban and one is an urbanized rural commune. The market potential is the highest in these cases (above 18 points) shown especially by the high demographic potential and the best communication potential. The crops/livestock balance inclines to the animal sector in the northeastern towns and to the cropping sector in the western half of the plain.

The urban-commercial sub-pattern, represented by the two major urban centres (Satu Mare and Carei) which are the only cases of typically commercial agriculture, is characterized by the highest population density, a negligible proportion of agricultural manpower, the most important industrial processing capacities and the highest level of transportation infrastructure. The agriculture practiced in the suburban zones of these towns is dominated by livestock raising and vegetable farming and is almost exclusively oriented towards the nearby urban consumers, represented either by the food-processing factories or by the free market.

The quasi-commercial sub-pattern is characteristic for smaller towns whose economic profile is agro-industrial; consequently, they have certain industrial processing capacities, though not comparable to that of the bigger cities. The higher market potential (between 18 and 25 points) is given both by the high demographic potential (a high agricultural density and a high proportion of non-

agricultural manpower) and a good communication potential (these towns are all situated on the main road and railroad axes, and generally have a good transportation infrastructure).

The suburban pattern is generally spread around the two major urban centres of the plain and is usually intermediate concerning their market or subsistence character, with a market potential between 14 and 18 points. Though the two towns that represent their primary centres of attraction are not similar in size, the difference is rendered neglectable by a more important food industry-capacity in the case of the smaller town (Carei). This difference has an impact on the crops/livestock balance and natural conditions. Moreover, the land ownership structure around the two towns are quite different, which induces further differences in the agriculture's profile; this is why such a pattern can be divided into two subpatterns:

The suburban-mixed sub-pattern is characteristic for the communes situated around Satu Mare which are not very ecologically favourable (poor soils), but they can still make a profit from their direct vicinity to the biggest town in the plain. This is especially visible in their high communication potential, which offers them good market access, and thus a higher market potential. The profile of agriculture is balanced, with the livestock raising being dominated by a few intensive farms (dairy, pork and poultry) and completed by the small private farms, while the cropping sector's most important branches are the cereals, vegetables and fodder cultivation.

The suburban-cropping sub-pattern includes the communes around Carei and is unique in the plain mostly because of its high ecologic potential (especially due to very rich soils), very favourable to crops such as cereals, industrial plants and vegetables. This is why the crops/livestock balance here usually inclines towards the cropping sector, though the animal raising, dominated by swine, is still important. These villages also have the highest proportion of organised farmers. The highest specific production levels obtained in these villages are mostly absorbed by an important food-processing capacity (edible oil production, textile processing, the milling industry, the meat industry, tobacco processing, and canneries) in Carei.

The peripheral pattern groups the communes situated a larger distance from the main urban centres and thus with less favourable market access, visible in the usually lower market potential. The geographic situation in more peripheral areas of the plain also cause a larger spread of the cases belonging to this pattern, reflected in a larger variety of the natural landscape and potential, the agricultural profile, a generally lower demographic potential and a lower quality of transportation infrastructure. According to the geographic position and to the agriculture's profile, we can separate these into three sub-patterns:

The livestock-peripheral sub-pattern is characteristic for the northeastern extremity of the plain and presents common features concerning the natural potential, the demographic potential, the structure of the land property and particularly the profile of the agriculture. The determining ecologic characteristic is the slightly cooler and wetter climate caused by the proximity of the mountains, combined with a very flat terrain which encourages stagnating water, thus rendering the soils poor. These features lead to a higher proportion of pastures and meadows, thus to an orientation of agriculture towards livestock, especially cattle; this sub-pattern is the closest to what is known as dairy farming. The average dimension of the exploitation is low and the weight of private associations and societies very low, so the property/potential is reduced, but the demographic potential and the communication potential are higher than in the case of the other peripheral sub-patterns, as is the market potential.

The cropping-peripheral sub-pattern concerns cases found in the southwestern extremity of the plain (situated in Bihor county), near the border with Hungary. These communes generally have superior natural potential, but are far away from the major urban centres, have a low quality transportation infrastructure, a high proportion of agricultural manpower and low property-potential; thus their market potential (with one exception) is usually low. The rich soils and the variety of natural landscape allow the cultivation of a great variety of crops (cereals, industrial plants, fodder, vegetables, fruits, vineyards), which easily incline the crops/livestock balance towards the cropping sector, but also impede the specialization of agriculture, emphasizing its subsistent character.

The balanced-peripheral sub-pattern is represented by the communes situated on the southeastern borderline of the plain, abutting the low hills of Crasna. This position provides a high variety of natural landscape which, combined with a generally low demographic and property potential, gives a dominantly subsistent character to agriculture. The relatively long distances to the urban centres, and with few exceptions, the low level of transportation in these villages, further reduces the market potential even if some of the villages have certain industrial processing capacities. Given the fact that a large number of crops are cultivated and there is also an important amount of pastures and meadows which favour animal farming, the profile of the agriculture is balanced.

The regressive pattern is given by the cases with less favourable conditions for agriculture, represented by four communes from the inner-central part of the plain. They have as common features the lowest natural and demographic potential and isolation from the main axes of communication, which gives them a low market potential in spite of the relatively central geographic position within the plain. These villages are situated on very flat terrain with mediocre and poor soils, have a very sparse and aged population, predominantly agricultural manpower and a very poor transportation infrastructure which emphasizes their isolation. The average dimension of the exploitations is higher

than anywhere else in the plain due to the low agricultural density, but the weight of private associations and societies is low. Though important surfaces are used as pastures and meadows, they are usually situated on the poorest soils, which is why the animal density is also low, which has led to semi-extensive cattle breeding.

4 CONCLUSION

The main patterns described are also characteristic for other regions in the plains and lower hills of Romania, (even if they present specifically local features) so they can be considered as general patterns for the actual state of Romanian agriculture. The correspondents of these patterns and sub-patterns can be found especially in the Transylvanian provinces, where the elements of natural potential and socio-historical development of agriculture were quite similar to those of northwestern Romania, and where the actual trends of evolution are also very similar: beyond the general crisis which is characteristic for the whole of Romanian agriculture, the last decade has shown an increase in the territorial contrasts between the more favourably positioned villages with better market access and the isolated, profoundly rural settlements where agriculture remains predominant and essentially subsistent.

REFERENCES

- GÖNCZI, I. (1982): Gyakorlati kalkulációk a mezőgazdaságban (Practical Calculations in the Agriculture), Mezőgazdasági könyvkiadó, Budapest.
- KOVACS, CS. (1996): Modèles agroéconomiques et l'homogénéité des régions agricoles dans la Plaine du Someş, *Studia Universitatis Babeş-Bolyai, Geografie*, No. 1-2, Cluj-Napoca.
- KOVÁCS, CS. (1996): The Agroeconomic Potential and the Agricultural Patterns of the Someş Plain. *Studia Univ. Babeş-Bolyai, Geografie*, No. 1-2, Cluj-Napoca.
- KOVACS, CS. (2002): Typologies bidimensionnelles et pluridimensionnelles de l'agriculture dans la Plaine du Someş, *Studia Univ. Babeş-Bolyai, Geografie*, No. 2, Cluj-Napoca.
- PILIS, P. (1978): Mezőgazdasági modellek (Agricultural Models), *Közgazdasági és Jogi Könyvkiadó, Budapest*.

SUBSISTENCE FARMING IN BULGARIA: BETWEEN TRADITION AND MARKET REQUIREMENTS

DIANA KOPEVA, NIVELIN NOEV

1 INTRODUCTION

Subsistence agriculture is a phenomenon that is presently encountered not only in developing countries, but also in the Central and Eastern European transition countries (CEECs). The various land reforms implemented in Eastern Europe have led to differences in the land tenure and farming systems and have influenced the access to land and capital and farms' productive efficiency.

The Bulgarian land reform of 1991 changed the economic behaviour of the rural population. It created new visions, a new environment and possibilities for the development of rural households, and took them to a decision-making crossroads: to continue working in agriculture or to leave it; to enter the agricultural sector or to stay out of it; to change or leave unaltered their economic, social and environmental preferences. As a consequence of all these decisions, an imbalance in the agricultural sector emerged.

Subsistence farming in Bulgaria has played a huge social role in the last decade due to long-lasting economic reforms and macro-economic instability during the first years of transition. In the last few years it has been used as an instrument for smoothing consumption by providing the necessary means for rural households to overcome their budget constraints. However, it does not lead to optimal allocation of resources, increases in welfare or to economic growth. The current large number of subsistence farmers in Bulgaria is a temporary situation which will continue to exist in the future, but in smaller dimensions. Importantly, current and future agricultural policy should focus not on the support of this farming system, but rather on reducing the level of subsistence, on the transformation of existing subsistence farms into commercialised farms, and on improving their competitiveness and efficiency.

This paper describes the development of individual farm structures in Bulgaria during the last century and the role of subsistence farms in agriculture. Using official and household survey data, we analyse the current state of subsistence farming in rural areas and determine its importance for agricultural development.

The paper is organised as follows. The second section presents an overview of some theoretical definitions of subsistence farming. An analysis of the current state of subsistence agriculture in Bulgaria appears in section three. Section four discusses the implications from our empirical analysis and provides insights to (future) rural development and agricultural policy. The last section concludes the paper.

2 THEORETICAL BACKGROUND OF SUBSISTENCE AGRICULTURE

The abundant set of economic, social, psychological, environmental and natural characteristics of the CEECs, which generally differ from that which characterises the Developing Countries (DCs), results in a differentiation of the existing subsistence farm types. However, the research on subsistence farming in the DCs could be used as a basis for developing a policy framework and strategies for coping with the negative outcomes from subsistence farming in transition.

Farming systems consist of resources (land, labour, capital) used in activities (crops, livestock, off-farm) to produce a flow of outputs (food, raw materials, cash). A farming system is a unit consisting of a group (household) and the resources it manages in its environment involving direct production. Factors such as climate, weather, land tenure, land quality and socio-economic variables are included (BEETS 1990).

Subsistence farming is a production process directed to the fulfilment of the household's basic needs. It neglects existing market conditions and usually applies non-optimal use of resources under certain constraints.

Subsistence farming, mostly referred to as smallholder farming, implies producing enough food for the needs of the farmer and his family (SPEDDING 1979). It leads to low labour productivity, low land productivity, soil erosion, ecological damages, food shortages, rising food prices and an economic environment which has shown itself uncongenial to accelerated mechanised farming (ATTA-KONADU 1974).

Subsistence agriculture is a complex farming system where owners of small amounts of land and/or livestock take a higher risk in production, and through the low use of external inputs, produce insufficient output for the market. Following BEETS (1990) three types of farming could be recognised: (i) resource-poor, largely subsistence agriculture; (ii) intensive subsistence agriculture; and (iii) commercial/market-oriented agriculture.

HAINES (1982) considers the primary objective of subsistence agriculture to be maximising crop output by converting it into human and animal food with minimum waste. He argues that once this level is achieved, the farmer becomes less interested in maximising physical output than in maximising his income, and this may tempt him to reduce output in the hope of raising the prices. Moreover, while the main objective of the largely subsistence farms is to increase the produced quantity of food, intensive subsistence farms produce near the limit of sustainable production and their target is to maintain that level of production.

3 SUBSISTENCE FARMING IN BULGARIA

3.1 Historical Overview

Subsistence farming in Bulgaria is not a phenomenon that has appeared as a result of the ongoing reform processes. It has its traditional roots in the years preceding the communist period, and thus we cannot get into its core by neglecting the past.

The late start of the country's development (after 1880) and the land reform carried out at that time brought into the scene a large number of landowners possessing small parcels of land. Land owned by the rural households was extremely insufficient in quantity, or just enough, for the usually large-sized households, to produce the food which would satisfy their needs. Different types of land tenure systems existed mainly based on the cultivation of small, dispersed parcels of land. Subsistence farming was sustained through the low level of education, the lack of capital, the slow industrial growth, the legislation framework, the large-sized families in rural areas and the adverse living conditions. Attempts to reduce the significance of the problem and shift agricultural production from subsistence levels to market-oriented were made in the beginning of the 1920's when the first cooperatives were established. This allowed farmers to apply new techniques and new manners of land cultivation through mechanisation, and hence to enter the agricultural market.

According to official data, in 1897 about 20.9% (19.3% in 1908) of the farms were below 0.5 ha. Another 11.3% (12.2% in 1908) were between 0.5 and 1 ha, or in total, 32.2% of all farms were smaller than 1 ha. In 1926 and in 1934, the situation changed and only 11.9% and 13.5%, respectively, of the farms were smaller than 1 ha.

After the collectivisation process in 1950-1960, large-scale agriculture replaced the existent individual household farms. This drastically changed the situation in the sector and the small-sized subsistence farms vanished, replaced by co-operatives and state farms. The only feature of subsistence farming that

remained viable was the cultivation of household plots¹ where different crops were grown, mostly maize, vegetables and permanent crops (grapes, plums, etc.).² Later on, in the beginning of the 1980's, the state started a policy for the self-sufficiency of the rural population. According to the policy, each household had the right to cultivate small parcels of land (up to 0.1 ha) and/or to look after certain maximum of livestock heads (e.g., maximum 5 sheep, etc.). At that time, following the state policy, the co-operatives started to give parcels of land of up to 0.1 ha to the rural households (so-called "personal use" land), letting them cultivate the land and choose the crops they wanted to grow.³ This specific feature of the socialist land tenure system in Bulgaria was successfully passed on to the present day, no matter the land restitution process, and currently, in many villages the cultivation of this "personal use" land represents the way in which subsistence farming operates and exists.

3.2 Socio-economic Characteristics of Rural Households in Bulgaria

Several factors play an important role in determining the social and economic position of rural households and cause a strong social differentiation between them:

- Lack of favourable market conditions;
- Lack of efficiently working rural institutions;
- Macro-economic instability during the first 9 years of the transition period;
- Lack of sufficient investments in agriculture;
- Lack of a well-functioning land market;
- Underdeveloped output markets;
- Limited opportunities for off-farm employment;
- Lack of favourable legislation framework for development and growth in the rural areas.

The combined influence of all these factors separates the rural households, according to their financial situation, into four groups: successfully-developed rural households, households with stable development, subsisting households and impoverished. According to a representative responsible for the country household survey on social household characteristics (see KOZHUHAROVA 1999), in 1998 only 6% of the households in the rural areas belonged to the group of successful households, about 26% were considered stable, 47% were determined to be subsisting and 21% impoverished.

¹ A household plot includes all the agricultural land cultivated by the household (usually up to 0.5 ha at that time), together with the house yard.

² The cultivation of the household plots is, however, something traditional for the Bulgarian society. A century ago, household plots were considered as a sign of wealth. Nowadays, because of economic changes, it is used only as an additional source of food and/or cash income.

³ No permanent crops were permitted to be grown on such land (e.g., grapes, peaches, etc.).

The subsistence farms' development and their transformation into market-oriented producers are strongly connected with labour resources and the supply of labour in the rural areas. Transition countries, and particularly Bulgaria, face a two-sided labour problem. On the one hand, there are insufficient disposable labour resources in the rural areas, and on the other hand there are no incentives that could stimulate the unemployed agricultural specialists (often landowners) to move from the cities to the villages. Importantly, the unemployed rural population is ready to make big compromises just to become employed: 67.2% of the households are ready to receive lower-than-average wages for the area and 69.0% are willing to work even under bad working conditions. Rural household members prefer to be employed in non-agricultural activities, while land cultivation remains a source of additional income. Nevertheless, all those who are unemployed rely on their land. Sixty seven percent farm their land in situations of long-term unemployment and/or after spending all accumulated financial means. Importantly, about 40% of the Bulgarian villages are without non-agricultural employment. These are mostly small villages, 80% of them with a population of less than 500 people, with an average age per inhabitant of over 50 years.

3.3 Household Consumption and Income

To estimate the number of subsistence households, we use data from a representative national survey conducted in 1998 financed by the European Commission⁴. As Table 1 shows, subsistence households account for a large share of all households in the rural areas. Importantly, 65.5% of all rural households produce food only for their own consumption. The share of subsistence farmers from all farms smaller than 0.5 ha is 68.4%. From those farms between 0.5 and 1.5 ha, some 76.1% are subsistence farmers and their share declines with the increase of the farm size (58.5% of those with farms of 1.5-5 ha and 21.3% of those who run farms larger than 5 ha). This may also suggest that a large part of the land in the large-sized farms is left abandoned by the farmers. Interestingly, only 7.2% of the rural households consume between 70% and 100% of their own production.

Figure 1 reveals a trend of declining share of income from household plots in the total household income. This trend has been stable since 1997, and in 2000, the share was 51.5% less than in 1992. This proves our hypothesis that the importance of subsistence farming will decline in the future and will not count for a large share.

⁴ The survey was conducted under the framework of the Phare ACE (Action for Cooperation in the fields of Economics) Programme 1996 project No. P96-6090-R.

3.4 Land Reform and Individual Farming in Bulgaria

The Bulgarian land reform of 1991 was focused on the restitution of land properties to their pre-communist owners, and its main objective was to make possible the establishment of new, private, competitive individual farms. These farms had to fill in the gap left after the liquidation of the collective farms. It was also claimed in the beginning of land reform that the development of the rural areas should be a copy of the model that existed between the two world wars and that the backbone of Bulgarian agriculture should be the individual farms. The potential of agriculture as a source of income and a source for employment was expected to revive the rural areas, to create new job opportunities and to solve the problems of depopulation.

However, what was expected to happen in agriculture, namely the emergence of well-functioning, market-oriented individual farms, did not happen. On the contrary, as we can see from Table 1, two-thirds of the individual farmers are subsistence – they do not produce for the market. Land ownership fragmentation, weak internal consumer demand, as well as low farm-gate prices all contribute to keep them vital. Moreover, the insufficient development of road infrastructure in the under-developed rural areas, poor market information, and the lack of competitive markets additionally strengthen their existence.

The land and structural reforms in Bulgaria created a situation in agriculture similar to the one before the communist period in terms of land ownership fragmentation. The average farm size in 1998 was 3.92 ha, which is the smallest average size for a period ranging one hundred years (Figure 2). Moreover, the share of fallow and unused land from the average cultivated land per household was very high (29.9%), which shows the negative externalities from the implemented land reform (KOPEVA et al. 2000).

According to our estimations, the number of parcels in Bulgaria in 1998 reached some 8,007,000 (Figure 3), which is even higher than the number of parcels in 1897 (7,980,000). After 1999, the process of land sub-division between the heirs of former owners accompanied land restitution, and as a consequence the number of parcels has been permanently increasing. On average, small-sized farms are located on two parcels, while middle-sized and large-sized farms cultivate, 3.1 and 2.6 parcels on average, respectively (Table 2). However, in 1998, the average size of a parcel was 0.6 ha, still higher than those of the past (Figure 4).

The total number of individual farms in Bulgaria has fluctuated between 1,700,000 and 2 million over the last seven years⁵ (Table 3).

⁵ The last official census of individual farms was conducted by the National Statistical Institute (NSI) in 1995. In July 1996, the NSI repeated the results from 1995.

Different households require different amounts of land to satisfy their needs. Usually, subsistence farms are equated with small-sized farms, which however, does not represent the exact share of households not producing for the market.

For the purpose of our analysis, we divide the individual farms into three groups according to their size (see Table 3). The first group (up to 1 ha) comprises 86% of the individual farms and 26% of the total land area cultivated by individual farmers. The farmers in this group, mostly pensioners, produce mainly for their own consumption, and with time, their number has been gradually diminishing.

The second group, the group of the so-called marginal farms (1-5 ha), which play a buffer role between the small-sized, mostly subsistence farms and the large, market-oriented farms, consists of 13% of all individual farms. They cultivate about 26% of the land under individual farming.

The third group, large market-oriented farms, includes about 1% of the newly-established individual farms (larger than 5 ha), which cultivate 7% of the area under individual farming. Farms larger than 10 ha comprise only 0.2% of all individual farms. Importantly, these large farms cultivate more than 41% of the land farmed by individuals.

Interestingly, from 1992-1998 there was a considerable decline in the number of households owning land up to 0.3 ha. While in 1992, about 50% of the households possessed up to 0.12 ha, in 1994 the same percent of households owned up to 0.68 ha, and in 1998 up to 1.4 ha. In 1998, some 27.8% of the rural households cultivated land of 0.1 ha, 14.0% between 0.1 and 0.2 ha, and 8.5% cultivated between 0.2 and 0.3 ha, i.e., 50.3% from rural households cultivated land no larger than 0.3 ha (including house yards).

4 AGRICULTURAL POLICY AND SUBSISTENCE FARMING

As transition is characterised by macro-economic instability, a high share of unemployment and limited access to capital, cultivation of small house yards remains a reliable source of food provision. Moreover, in the regions where off-farm employment opportunities are limited, it remains the main income source.

Subsistence farming impedes the development of rural areas, the implementation of new technologies for land cultivation and does not provide conditions for competition on the output markets. Furthermore, it negatively influences, in a direct or indirect way, the performance of commercialised farmers. According to HAINES (1982), the long-term policy towards subsistence farming is a necessity caused by: (i) the relatively low incomes in agriculture compared to the other sectors of the economy; (ii) the maintenance of domestic agriculture; and (iii) the contribution of agriculture to economic growth and common welfare.

After the end of the land reform in Bulgaria (2001), one particular question has come to the fore: Where to place the focus of agricultural policy in order to reduce the number of rural households living at the subsistence level?

As long as (off-farm) income is low, subsistence farming will continue to be a significant part of the agricultural system. In some regions, as it is in the Northwestern part of Bulgaria, the lack of off-farm activities and high unemployment keep subsistence farming vital. However, income gains can be achieved through easing access to land and capital and increasing their use. The lack of well-functioning land sales and land rental markets in Bulgaria creates an environment that impedes the possibility of more efficient land use. Hence, the importance of an agricultural policy oriented towards the development of land rental markets and their stabilisation, including land consolidation, is obvious.

The share of subsistence farming also depends on farmers' location. In specific semi-mountainous and mountainous areas, certain constraints and/or resource availability problems may lead to a certain dominance of a particular farming system.

Adequate credit supply also plays an important role in transition agriculture. Constrained access to capital impedes farms' development and reduces the efficient use of resources. During the first ten years of transition, financial institutions stayed away from agricultural loans because of their riskiness, inefficiency, fragmentation and disrupted links between the downstream and upstream sectors. The current interest rates imposed by the banks vary between 22% and 26%, with a collateral requirement of over 150% of the loan, which makes loans unavailable for small- and middle-sized farmers. In addition, the state policy is limited to the activities of the State Fund "Agriculture" (SFA). However, the credit programs provided by the SFA still have high collateral requirements towards a loan's security (130% of the loan), although land is accepted as a backup. As a consequence, low-income rural households stay away from the credit schemes and there is no positive effect on subsistence. Hence, direct and/or social payments, and application of schemes for micro-crediting could have a stimulating role in easing the access to capital and could reduce the role of the informal output markets and subsistence production. Furthermore, policies protecting farmers' incomes deserve attention. Even if a subsistence farmer becomes commercialised, the output markets and insolvent demand for agricultural products will constrain his/her possibilities for expanding and escaping from subsistence.

In addition, the state has to ease the activities, through changes in the legislative framework, improved access to information and education and training facilities, of non-government organisations which are ready to provide financial and training support to subsistence farmers and to poor households in the rural areas.

Building up a stimulus for leaving agriculture, and particularly the level of subsistence, is an important instrument. If incentives for leaving agriculture are created, the implementation of land consolidation programmes will be considerably eased. However, such a policy remains currently inapplicable in Bulgaria due to two important reasons. First, is the strict fiscal regulations and lack of financial resources, as the state is under a Currency Board. And second, the preferences of new landowners for cultivation of the land they have received from restitution.

Farm specialisation, together with contracting and strong vertical integration, are another remedy for subsistence farmers, as it increases the knowledge of the farmers as well as the farms' efficiency, and leads to the improvement of their welfare and social status. The development of a system clarifying the role of the intermediates in the food chain and their relationships with farmers and retailers has to be enhanced. The various and huge number of intermediates (physical and legal entities) in the food system at the moment absorb a disproportionately large share of the price margins, pressing down farms' profits and increasing consumers' costs. Currently, no state requirements are imposed on the quality of the intermediates' services and no specific regulations on their work and activities are legally enforced. As a consequence, disturbances in the food chain caused by the low quality of the services provided by the intermediates, cheating and payment delays are very often displayed.⁶ In addition, farmers face difficulties when selling their produce due to the stagnation of the domestic markets and the collapse of the former trading system.

The creation of possibilities for storing agricultural production can give stimuli to the farmers to increase their efficiency and profits. Improving, renovating and maintaining the road systems can ease access to the farms, reduce transport costs and make the whole community in a certain area better off.

5 CONCLUSIONS

This paper investigated the development of the farm structures and the role of subsistence farming in Bulgaria. It focused on the historical roots of subsistence agriculture and presented a detailed analysis of the current state of subsistence farming in the rural areas.

Our results show that about 65.5% of the rural households in Bulgaria remain at the level of subsistence, which impedes the development of the rural areas and does not provide conditions suitable for competition on the output markets.

⁶ Payment delays in Bulgaria are still often presented and they have never been adjusted for inflation between the time when the products have been delivered and when products are paid, as noticed also by GOW and SWINNEN (1999).

An agricultural policy which encourages the reduction of the number of subsistence farms, in the view of the future EU enlargement, should focus on land market development, the creation of off-farm opportunities and better access to complete market information, as well as on infrastructure development. State-specific regulations regarding the quality of the provided services of the intermediates in the food chain, and their activities, should be legally enforced. Strategies and rural development programs whose main thrust is the level of household income and its improvement are crucial and should be implemented if the role of subsistence farming is to be considerably reduced.

APPENDIX

Table 1: Distribution of Individual Farmers in Bulgaria According to their Farm Size and Share of Consumed Production from Total Output, 1998

Farm Size	Individual Farmers Consuming Less than 70% of their Output	Individual Farmers Consuming (70-100%) of their Output	Individual Farmers Consuming 100% of their Output
Up to 0.1 ha incl.	28.3	2.5	69.2
0.1 - 0.2 ha	22.9	12.7	64.3
0.2 - 0.3 ha	17.4	2.3	80.2
0.3 - 0.4 ha	32.3	12.3	55.4
0.4 - 0.5 ha	18.8	6.3	75.0
First Sub-group, 0.01 - 0.5 ha	24.7	6.9	68.4
0.5 - 0.6 ha	18.6	2.3	79.1
0.6 - 0.7 ha	12.5	2.5	85.0
0.7 - 0.8 ha	10.0	6.7	83.3
0.8 - 0.9 ha	16.0	4.0	80.0
0.9 - 1.0 ha	27.3	6.1	66.7
1.0 - 1.1 ha	3.7	0.0	96.3
1.1 - 1.2 ha	23.1	3.8	73.1
1.2 - 1.3 ha	23.8	4.8	71.4
1.3 - 1.4 ha	21.4	7.1	71.4
1.4 - 1.5 ha	61.9	9.5	28.6
Second Subgroup, 0.5 - 1.5 ha	21.0	2.9	76.1
1.5 - 2.0 ha	34.0	10.0	56.0
2.0 - 3.0 ha	18.6	11.4	70.0
3.0 - 4.0 ha	48.6	5.7	45.7
4.0 - 5.0 ha	33.3	19.1	47.6
Third Subgroup, 1.5 - 5.0 ha	30.7	10.8	58.5
Fourth Subgroup, more than 5.0 ha	61.3	17.3	21.4
Total for all Households	27.3	7.2	65.5
Total Number of Observations	1085		

Source: Own calculations.

Table 2: Average Number of Parcels Possessed by a Farm, 1897-1998

Year	Small Farms (up to 1 ha)	Middle-scaled Farms (1-5 ha)	Large Farms (over 5 ha)	Average for the Country
1897	1.92	8.84	19.59	9.98
1908	1.88	8.51	21.63	10.58
1926	2.77	11.61	22.60	15.29
1934	3.00	11.03	20.43	13.41
1998	2.00	3.08	3.68	2.62

Sources: NSI for 1897-1934; KOPEVA (1999) for 1998 (KOPEVA et al. 2000).

Table 3: Bulgaria: Individual Farms in Bulgaria, 1992-1995

Year	Groups of Farms by Land Area (ha)					Total
	0 - 1	1 - 2	2 - 5	5 - 10	over 10	
Arable Land (hectares)						
1992	n.a.	n.a.	n.a.	n.a.	n.a.	1438000
1993	400003	328934	264097	98007	143581	1234622
1994	652147	371567	407180	160361	467290	2058545
1995	631139	312184	342145	168421	1008362	2462251
Number of Farms						
1992	1783808	128874	42520	8608	580	1964390
1993	1537462	248772	91980	15195	4045	1897454
1994	1555090	342340	93568	15762	4201	2010961
1995	1535111	156092	68429	13483	4007	1777122
Average Farm Size (hectares)						
1992	n.a.	n.a.	n.a.	n.a.	n.a.	n.a.
1993	0.26	1.32	2.87	6.45	35.50	0.65
1994	0.42	1.09	4.35	10.17	111.23	1.02
1995	0.41	2.00	5.00	12.49	251.65	1.39

Source: NSI.

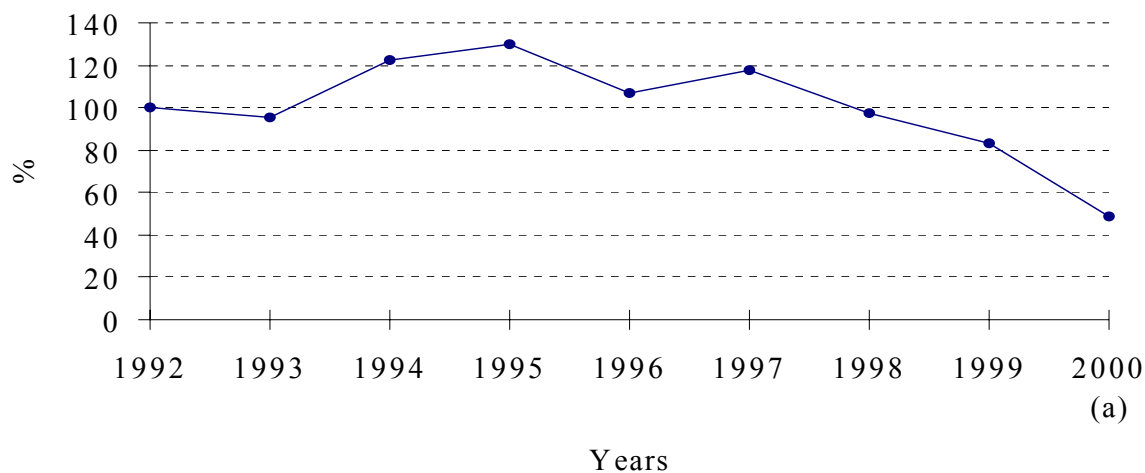
Figure 1: Bulgaria: Change in the Income Share from Household Plot in the Total Household Income, 1992-2000

Note: Data for year 2000 is preliminary.

Source: Own calculations.

Figure 2: Bulgaria: Average Size of Farms, (ha), 1897-1998

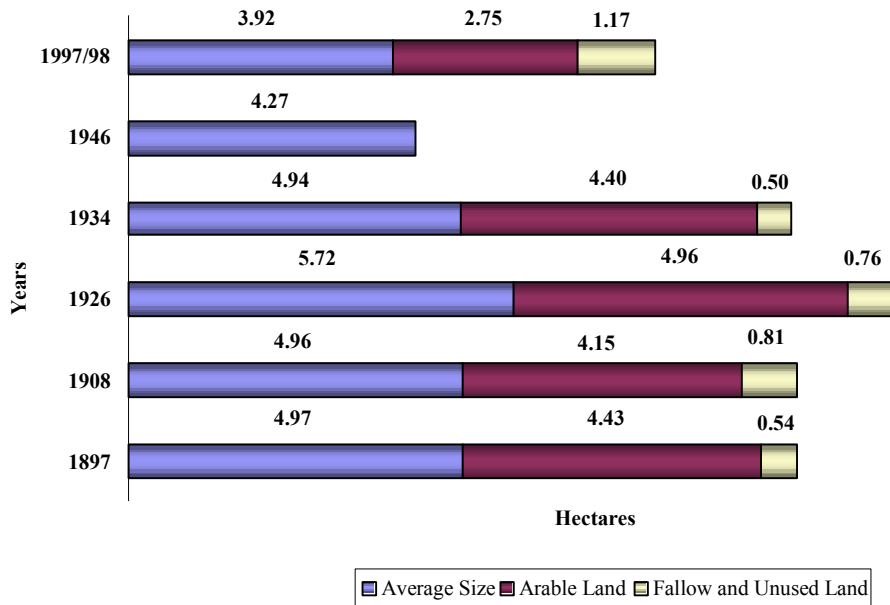

Note: In 1946 there is no data for the share of the arable land and the share of fallow and unused land.
 Sources: NSI and KOPEVA (1999), (KOPEVA et al. 2000).

Figure 3: Bulgaria: Number of Parcels of Arable Land, 1897-1998

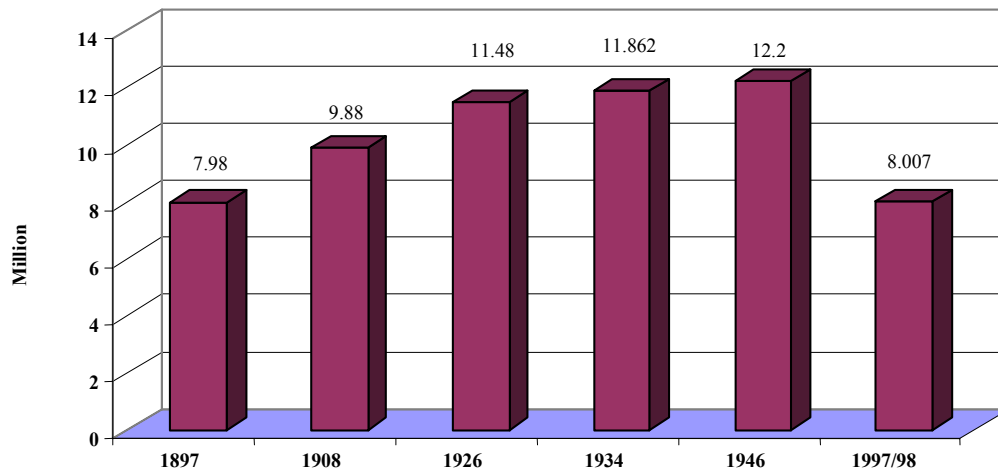

Source: NSI and own calculations.

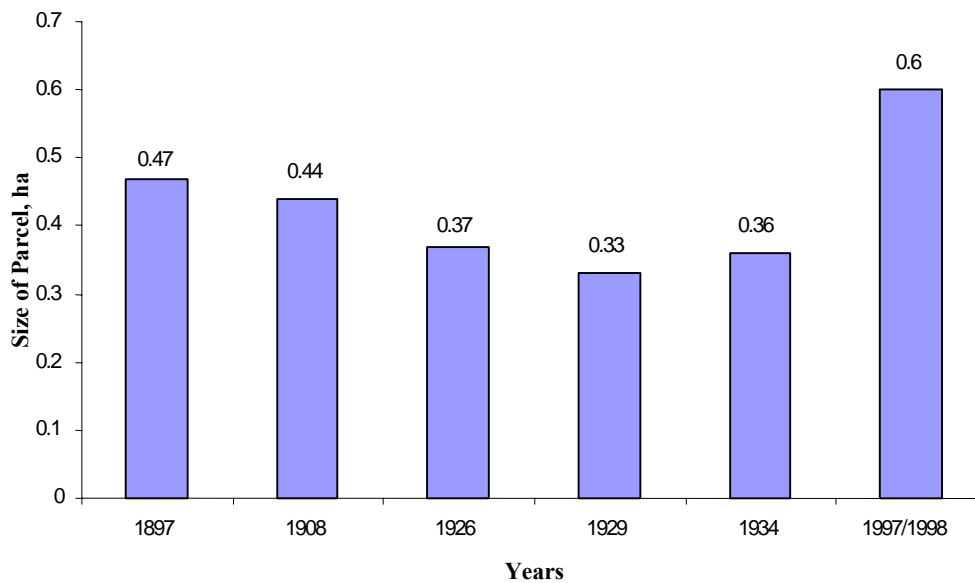
Figure 4: Bulgaria: Average Size of Parcel, (ha), 1897-1998

Sources: NSI and KOPEVA (1999), (KOPEVA et al. 2000).

REFERENCES

- ATTA-KONADU, Y.KW. (1974): Economic Optima in Resource Allocation for Smallholder Subsistence Farming in Ghana, UMI, USA.
- BEETS, W. (1990): Raising and Sustaining Productivity of Smallholder Farming Systems in the Tropics, AgBe Publishing, Holland.
- ELLIS, F. (1993): Peasant Economics. Farm Households and Agrarian Development, Cambridge University Press, UK.
- HAINES, M. (1982): An Introduction to Farming Systems, Longman, UK.
- KOPEVA, D., NOEV, N., EVTIMOV, VL. (2000): Aspects of Land Consolidation in Bulgaria, FAO, 122 pages.
- KOPEVA, D. (1999): Farm Restructuring in Bulgaria, Working Paper, ACE PHARE, Project P96-6090-R.
- KOZHUHAROVA, V. (ed.) (1999): The Bulgarian Village and Late Modernity, Bulgarian Society for Rural Sociology, Institute of Sociology, Alia Press, Sofia, Bulgaria.
- SPEDDING, C. (1979): An Introduction to Agricultural Systems, Applied Science Publishers LTD, London, UK.
- GOW, H., SWINNEN, J.F.M. (1999): Agricultural Credit Problems and Policies During the Transition to a Market Economy in Central and Eastern Europe, *Food Policy*, Vol. 24, No. 1, pp. 21-47.

THE SIGNIFICANCE OF SUBSISTENCE FARMING IN GEORGIA AS AN ECONOMIC AND SOCIAL BUFFER

HANNAH KEGEL

1 INTRODUCTION

The aim of this contribution is to show what official data are available and what statements can be made concerning the importance of subsistence farming in Georgia. Combining the official figures with observations of the Georgian situation provided insight to the significance of subsistence farming for the Georgian society.

It is obvious that subsistence farming plays an important role when considering Georgia's economic situation. Trying to get hold of this importance in figures requires a definition of subsistence farming and a comparison of this definition with the categories used in the Georgian statistics.

The contribution takes a general look at agriculture's share in the Georgian economy, then discusses land reform as a precondition for the present structure. By using official Georgian statistics, we attempt to approximate the importance of subsistence agriculture, even though this category as such does not exist in these statistics.

By describing the Georgian context, we put forward how subsistence agriculture should be defined for this specific case. Criteria for subsistence agriculture are discussed, leading to the issue of subsistence agriculture as a social and economic buffer. Having discussed the issues on a general and national level, the district (raion) level is focussed on, presenting detailed data from a case study conducted by the author. The data presented lead to the concluding remarks on the importance of subsistence agriculture in Georgia and its role in future.

2 AGRICULTURE'S IMPORTANCE AS ECONOMIC SECTOR IN GEORGIA

Agriculture has always contributed a substantial share to the Georgian Gross Domestic Product (GDP). But in times of economic collapse agriculture's importance increased dramatically. In terms of GDP-share, agriculture became the largest sector in the economy during the nineties. Due to this fact it is of interest to analyse to what extent the agricultural sector consists of subsistence farming.

Table 1: GDP Share of Agriculture, in percent

1990	1991	1992	1993	1994	1995	1996	1997	1998
29.7	26.5	54.5	66	64.4	41.7	31	28.2	24.8

Source: SDS (1999b).

Agriculture in 1990 was dominated by large collective and state farms that specialised in products for export to the other Soviet Republics. In 1998, agriculture was characterised by small family farms and production was orientated towards local consumption.

Because of the total collapse of the economy, even though total agricultural production drastically declined, agriculture's share in the GDP reached its peak in 1993/94. In the extremely difficult years of 1993/94, which were characterised by a total collapse of law and order, household plots became essential for survival. In the rural areas, the opportunity to produce for own consumption is still vital, as there has been no economic recovery in rural areas during the past years.

3 GEORGIAN LAND REFORM

In 1992 land reform started with the physical distribution of land to all rural families, even to families where none of the members were employed in agriculture. In land distribution, the maximum a family could receive as private property was 1.25 ha – this includes the household plot the family cultivated prior to reform. This maximum applies to families only where a member was employed in agriculture, whereas others received less land. In the mountains the maximum was raised to 3 ha. In densely populated villages the families received less land than the maximum.

The decision to implement this type of reform was substantially influenced by the important role household plots played in Georgia throughout the Soviet period. In Georgia, private farming i.e., household plots – which at their largest size measured half a hectare – held the highest share of production in the whole Soviet Union. In 1988 they officially produced 40% of the total Georgian agricultural production, whereas at the same time they only cultivated 6.3% of the agricultural land (SAKARTVELOS SSR STATISTIKURI SACHELMZIPO KOMITETI 1989). The non-agricultural rural population with their household plots also participated in agricultural production, just as did part of the urban population

with their gardens. A substantial proportion of the rural population was engaged in non-agricultural spheres of labour without migrating to urban areas (GACHECHILADZE 1995). After land distribution, these plots have been enlarged. For most rural households cultivating their land has become essential for survival.

Looking back, the measure of land distribution has often been criticised for having fragmented the land and having been started without proper preparation (DIDEBULIDZE 1997), but it has to be mentioned that in the years of turmoil from 1992 to 1995, land distribution had a stabilising effect on food security and on the political situation; wide-spread hunger in the rural areas was avoided and a tendency for spontaneous privatisation which would have led to an increased destabilisation on the local level was defused.

4 STATISTICS

The paper now focuses on the structure of post-reform agriculture as it is presented in the Georgian statistics, first by looking into the terms used in the Georgian statistics and then by looking at data on land ownership and agricultural production.

4.1 Terms Used in the Official Georgian Statistics

Concerning the types of farms in the statistics there exist two categories: households and, in contrast to them, agricultural enterprises. In the English translations of Georgian publications, sometimes instead of "household" the confusing term "private farms" is used. In Georgian the term family farms "ojachuri meurneobebi" and agricultural enterprises "sasoplo sameurneozarmoebi" are used.

Adding to the confusion are the categories privatised land and land belonging to the state fund. These two divisions are not necessarily congruent. Although privatised land is nearly exclusively in the hands of family farms, there are cases where an agricultural enterprise rents privatised family farm land. It is quite common that a tenant of state funded land is not registered as an agricultural enterprise. Does this mean that his production is attributed to the family farms? In cases which cannot be clearly classified in the existing categories – it is not an agricultural enterprise, but it uses state land – the district level seems to decide in which category the farm will be included. This fact causes a lack of standardisation on the national level.

The term private farm – resulting from privatised land – instead of household or family farms is confusing, because the majority of agricultural enterprises are private according to their legal status (companies of limited liability, joint liability, joint stock companies, co-operative farms, individual farms), but they rent their land from the state.

Despite these classification problems the Georgian statistics give an impression of the size of the family farms and their importance.

4.2 Land Ownership

In the 1999 Statistical Yearbook of Georgia, only 32% of all agricultural land and 54.6% of arable land were classified as privatised (as in Table 2). In these statistics Abkhazia and South Ossetia are included, even though at present they are not under the control of the Georgian government. In both regions agricultural reform has not taken place. If only Georgia is considered, the privatisation rate is higher.

Table 2: Land and its Distribution by Categories of Ownership as of January 1, 1999

	Agricultural Lands	Arable Land	Perennial Plantations	Meadows	Pastures
Privatised, in thsd. ha	750.1	431.7	181.8	39.6	77.6
Privatised, in percent of Total	32	54.5	67	27.7	4.2
State Property, in thsd. ha	2,313.4	360.2	88	103.1	1,762.1

Note: Lower rates of privatisation because Abkhazia and South Ossetia where no privatisation has taken place included.

Source: SDS (1999b), own calculations.

Regionally, the overall percentage of privatised land differs significantly. These differences can be attributed to factors like population density, cropping patterns (tea plantations were excluded from privatisation in the beginning) and the composition of land (pastures have hardly been privatised).

The average size of family farms obviously shows strong regional variation. To illustrate this I would like to refer to the 1997 household survey of the STATISTICAL DEPARTMENT (SDS 1998). In this survey the average size of land that rural agricultural households own is differentiated by mchare (regions), the average ranging from 0.96 ha at the upper, to 0.39 ha at the lower end. Densely populated villages with little land show even lower averages.

What we should keep in mind from these statistics is the fact that more than half the arable land and more than two thirds of all the perennial plantations are privatised land that has been distributed to the population and is most likely to be cultivated by family farms with an average of less than 1 hectare.

4.3 Production Data

In the 1999 Statistical Yearbook of Georgia the term family farm is used in Georgian, while in English the confusing term private farm is used. Let us stick to the term family farm. The share family farms have in agricultural production has increased for all products in the last ten years in part due to the decline of production of the agricultural enterprises. The share of the family farms for 1998 is shown in Table 3.

Table 3: Share of Family Farms in percent of Total Harvest of Agricultural Crops and Animal Production in 1998

Crop Production				
Crop	Harvest Share	Crop	Harvest Share	
Winter Wheat	73	Vegetables	87	
Maize	94	Melons	62	
Pulses Total	98	Fruit	99	
Sunflower Seeds	69	Citruses	98	
Soy Beans	82	Grapes	97	
Potatoes	90	Tea Leaves	45	
Animal Production				
	Meat, Slaughter Weight	Milk	Eggs, in Million Pieces	Wool
Total Production, in thsd. Tons	104.1	634.7	380.4	1.7
Share of Family Farms, in percent	99.4	98.8	99.1	94.1

Source: SDS (1999b).

From these data the importance of family farms for production is obvious. Nearly all animal products are produced in family farms. The same can be said for the production of fruit, grapes, citruses, maize and legumes. Only in the case of the production of tea leaves is the share of the family farms less than half of the total production. This is simply due to the fact that at the beginning it was excluded from land distribution for strategic reasons (tea was exchanged against gas with Turkmenistan). Agricultural enterprises often concentrate on those crops where they can employ their machinery, for example wheat.

The households – about 700,000 – have become the main producer of agricultural output. In 1997 and 1998 their share of total agricultural output amounted to 80% (SDS 1999a).

5 SUBSISTENCE AGRICULTURE IN THE GEORGIAN CONTEXT – DEFINITION AND CRITERIA

5.1 Definition of Subsistence Agriculture

In the literature one often finds the division between subsistence agriculture, subsidiary farming and non-agricultural households with garden plots. For the case of Georgia, it is nearly impossible to make such distinctions.

In Georgia's specific case – where all rural households have small plots of land at their disposal, and hardly any off-farm employment possibilities exist in rural areas – the differences between subsistence agriculture, subsidiary farming and non-agricultural households with garden plots have become so small that it is often impossible to decide to which category a household belongs. Therefore the term subsistence agriculture is used in a broad sense to include all types of family farms except those that are definitely market orientated.

But subsistence agriculture is not only found in the tiny family farms, there are also agricultural enterprises which at a closer look satisfy all criteria of subsistence agriculture.

5.2 Criteria

What criteria should be used to describe whether a family farm or an agricultural enterprise is engaged in subsistence agriculture? Below the following criteria are discussed: market orientation, share of self-consumption, size, percentage of household/enterprise income from sale of agricultural goods and self-assessment. Moreover, family farms as well as agricultural enterprises are examined.

5.2.1 Market Orientation

The Georgian statistics offer no data on this complex question. Various surveys (BATESON 2000; DERSHEM 2000; SDS 1998b) as well as the preliminary results of the present case study come to the same conclusion: The majority of family farms are not market orientated. Their priority is to supply the family with a sufficient amount of food and sell their surplus produce. But when deciding what to cultivate they are clearly orientated towards their family needs.

Those family farms which are market orientated often are located in the vicinity of large towns. For example, they engage in flower production – as prior to reform – and also in the production of milk and milk products (mazoni – a kind of yoghurt). The production of fresh herbs for the markets of the large towns is also a typical specialisation of market-oriented farms.

Agricultural enterprises substantially differ in size from family farms. Here, a market orientation should be expected, but there exist many cases where the total production of the enterprise just suffices to pay the workers in kind and barter for necessary inputs to keep the farm going and avoid liquidation. In some cases the enterprise lacks the resources to till all the land it has rented from the state fund, so that land is sublet.

It has become difficult to market agricultural goods, especially those products in which Georgia was specialised and supplied the other republics with like tea, fruit and wine. The formerly important food processing industry totally collapsed and only very few enterprises are again functioning. Agricultural producers may sell directly to the consumer, take the products to the market or sell them to the retail organisations. Producers, especially family farms, suffer from insufficient price and market information.

5.2.2 Self-Consumption of Produce

Most family farms consume the majority of their produce themselves, selling or bartering surplus produce. As mentioned above, some agricultural enterprises consume all their produce to pay their wages in kind or barter for inputs.

5.2.3 Size

The size of a family farm or an agricultural enterprise is not decisive for its market orientation. As mentioned above, there exists a small percentage of small family farms which are definitely market orientated and specialise in the cultivation of products they do not consume themselves. But the majority of family farms are engaged in subsistence farming.

Compared to family farms, agricultural enterprises are more likely to have the intention of selling or exchanging their production. But cases like the one mentioned above, with low productivity and little sales, are quite common. Often, these are large farms in direct succession of the collective and state farms.

Agricultural enterprises that are newly set up more often have the clear goal of obtaining cash or goods through the sale or barter of their produce in addition to producing for the needs of the family.

5.2.4 Percentage of Household Income from Agriculture

For the rural population the sale of agricultural products is the largest source of cash inflow. This shows that a certain amount is sold, which in general is surplus produce. According to the 1999 statistical yearbook (SDS 1999b) these sales provide up to 49% of the average monthly cash income of rural households (Table 4).

Table 4: Average Monthly Cash Income of Rural Households in 1998, in percent

Sales of Agricultural Products	49
Contractual Employment	22
Self Employment	11
Pensions, Stipends, Family Allowances	11
Remittances from Abroad	3.6
Remittances from Relatives	3.6
Total, in Lari	85.5

Note: In 1998 the exchange rate for 1 USD was between 1.32 and 1.55 Lari.

Source: SDS (1999b).

The data shows the very low level of cash income in rural households. As a result of this lack of cash, many households have difficulties paying their land tax. Tax collection started in 1997, the first five years after distribution being tax free.

For agricultural enterprises, the sale of agricultural products is not necessarily the main source of income. The majority of agricultural enterprises own machinery, and tillage services are often offered to the population. Buildings are let and an involvement in trade is also quite common. This corresponds with the preconditions for leasing land from the state fund that were found in the author's case study: in general the tenants have technical and/or financial resources at their disposal, and last but not least they often have good connections to the local administration.

5.2.5 Self-Assessment

In the present case study of one district, it was found that most (over 80%) households interviewed – especially those whose members were formerly employed in other fields – do not consider themselves to be farmers. They regard farming as a temporary necessity to help them survive until finding employment.

6 SOCIAL AND ECONOMIC BUFFER

Subsistence agriculture has an important social and economic function. It helps the rural population survive in very difficult times. It cannot stop the migration from rural areas to the towns altogether, but it reduces the impact. Many younger people leave the villages to try to find work in the towns or abroad. Due to this, the age structure of the rural population has shifted towards pensioners, thus increasing the importance of pensions as a component of the household income. In the past years all state benefits have regularly been paid with great delay, if they were paid at all.

6.1 Employment

Looking into the question of employment, or rather of unemployment, one finds that in 1997 58.6% of the economically active population were officially employed in agriculture. At the same time, the rural population accounted for 44.4% of the population (SDS 1999b). This means that more or less all of the economically active people in rural areas are employed in agriculture. This employment is in the majority self-employment, i.e., family farms. Even if the people consider themselves unemployed, officially they are self-employed (changes in the law on employment 12.11.1997 state that everyone owning one hectare of land or more is to be considered employed). Obviously, subsistence agriculture is a buffer for the dramatic unemployment that results from the breakdown of the economy. "Agriculture's overwhelming contribution to the number of self-employed (86% in 1999) merely reflects the crisis in other sectors of the economy and the inherent difficulties of finding employment. The absence of monetary income for a large group of self-employed people

contributes to the perpetuation of non-monetary economic relations in rural areas" (UNDP 2000).

There exist hardly any possibilities of employment. Nearly all factories are shut down. Where large farms still function, wages are often paid in kind. Families who, prior to the changes in the nineties, found their income elsewhere, now have to rely on agriculture. The priority of the majority of family farms is to produce sufficient food for the family and to sell or exchange surplus produce.

6.2 Food Security

The Georgian state is not able or willing to take on the responsibility of ensuring food security for its citizens; instead it passed the responsibility to the rural inhabitants themselves by giving them small patches of land. Driven by low levels of security and the lack of sufficient capital, the majority of family farms, but also many agricultural enterprises, function according to the motto "low input – low output".

"With the collapse of the formal economic system, for most households in Georgia the ability to produce their own food is a major factor in reducing food vulnerability. It is not an exaggeration to state that one of the main welfare systems in Georgia today is self-provision, especially when it comes to household food security" (DERSHEM 2000).

Thanks to their agricultural activity, rural households have a caloric surplus (BATESON 2000).

As a conclusion from the above discussed facts, subsistence agriculture is the main factor ensuring food security in rural areas.

7 KHASHURI CASE STUDY

In this chapter, some facts will be illustrated in more detail by presenting data from the Khashuri district where the case study was conducted. The study concentrates on agricultural enterprises, but the data gathered also include aspects concerning the role of family farms (data have been collected since 1996). The Khashuri district belongs to the region (mchare) shida kartli. With 585 km², it is a fairly small district with no high mountains (lower than 1,400 m). The town Khashuri lies 130 km to the west of the capital Tbilisi. With 71,200 inhabitants in 1998, i.e., 121 pers./km², it is one of the more densely populated regions of Georgia. 65% of the population lives in urban and 35% in rural settlements. The rural population lives in 81 villages which are grouped in to 11 administrative units called *sakrebulo*.

The large share of urban population indicates the former employment structures. Light industry was prominent in the Khashuri district. A high percentage of villagers worked in the service sector and in factories. Nowadays, these factories

stand still and the former workers, as well as those who were employed in the service sector, mainly work the land they received during land distribution.

Land distribution was quick in comparison with other districts as Khashuri's former head of district administration (gamebeli) actively supported the measure. More than half the agricultural land has been privatised. Of the land remaining in the state fund, about one third consists of pastures. Perennials (87%) and arable land (75%) are now mainly privately owned (More details are shown in Table 5).

Table 5: Distribution of Agricultural Land in Khashuri District 1989 and 1999 Compared, in ha and in Terms of Ownership

	Situation 1989	Situation 1999
Public Sector Land in State Fund	19,253	9,322
Household Plots (Sakarmidamo)	2,022	2,022
Privatised Land (Samamulo)	-	9,931
Status of Privatisation 1999		
	Area, in ha	Per cent of Privatised Land
Agricultural Land Total	19,253	
Of Which Privatised	9,931	51
Arable Land Total	9,627	
Of Which Privatised	7,242	75
Perennials Total	3,080	
Of Which Privatised	2,689	87
Meadows/Pastures Total	6,546	
Not Privatised	0	0

Sources: SAKARTVELOSSR STATISTIKIS KOMITETI (1989); DEPARTMENT OF AGRICULTURE, KHASHURI (1999), DEPARTMENT OF AGRICULTURE, KHASHURI (1999).

A regional commission leases the state land to individuals, cooperatives, firms and so on. Eighty-seven leasing contracts were in force in 1999. These tenant farms vary extremely in size and profile. Two farms lease more than 200 ha of state land each. The 10 largest farms (> 90 ha) work 53% of the total state land leased (7 farms are in direct succession from the state and collective farms, with 2 of these belonging to the Ministry of Agriculture). More than half of these large farms can in a way be characterised as subsistence farms. The harvest is just sufficient to pay the labour in kind – a widespread practice – and to barter for necessary inputs. When looking at the large farms it should be recalled that an incentive to keep profits low lies in the tax system, where agricultural enterprises with a profit of 24,000 Lari or more have to pay a profit tax of 20% additional to Value Added Taxes (VAT), a result of which is an increase of informal activities. But the lack of financial resources in most of these farms makes them live from their reserves, with no necessary repairs and investments taking place, minimal inputs result in minimal output, keeping the farms undercapitalised.

Among the 77 smaller (< 90 ha) farms, at least 9 can be classified as market orientated. Here the decisive factors are existing labour, access to technical and financial resources and last but not least connections.

Let us now look in detail into the situation of the household/family farms in the Khashuri district.

Animal husbandry is totally in the hands of the households. It is difficult to fix the amount produced, but the data on livestock have proved to be quite reliable. Almost every family owns at least one cow. In the late eighties this was an exception in the densely populated villages of the low lands. Looking at the livestock data it is interesting to observe that the urban population also sees the necessity to keep livestock (as shown in Table 6).

Table 6: The Population's Share of Livestock, Khashuri District

	1996 Total	1996 % Owned by Family Farms	1996 % of Which Urban	1997 Total	1997 % Owned by Family Farms	1997 % of Which Urban
Cattle	13,967	96.4	16.6	15,071	97.8	18.8
Of Which Cows	7,426	97.8	20.1	7,559	99.4	23.5
Pigs	6,362	98.9	28.5	6,697	99.3	19.6
Sheep/Goats	2,616	99.5	22.5	3,901	99.7	35.5

Note: Livestock as on the 1.1.1996 and 1.1.1997.

Source: DEPARTMENT OF AGRICULTURE, KHASHURI (1998).

This data is of course only a snapshot, but it quite vividly illustrates the importance of the family farms and in particular shows to what extent the urban population in the regions is also involved in agriculture. Due to the possibility of leasing land, the situation has changed slightly in the last few years. Several tenant farms are increasing their livestock, in particular in one sakrebulo where land was distributed quite evenly. The 24 tenants have an average of 20.5 ha and no tenant has more than 100 ha. To mention the other extreme, a sakrebulo with the same amount of agricultural land in the state fund leased all the land (427 ha) to one tenant farm.

For plant production there exists information of the amount of land farmed by the households. But the validity of the official data that exists on what is cultivated on this land and in particular how much is produced by these households, has been shown to be questionable.

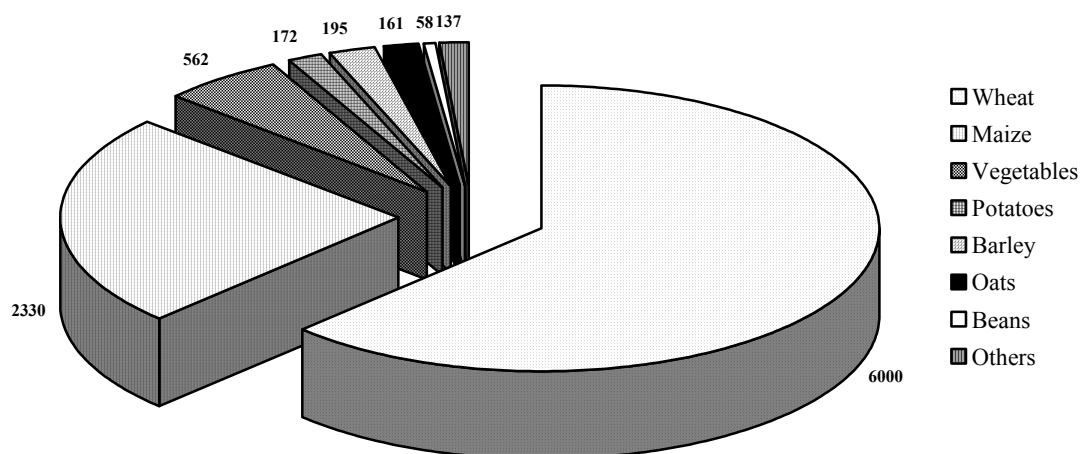
Figure 1: Crops Cultivated in Khashuri District 1998

Source: SDS (1999a).

Mixed cropping is common to household farms. This creates difficulties in determining the exact amount of hectares cultivated by a certain crop. The most important crop is wheat, which according to the official statistics accounts for 62%, followed by maize with 24% of the cultivated arable land. The production of vegetables which formerly took up approximately 20% of the arable land has been reduced in favour of wheat and maize that can easily be stored, and are essentials for human consumption. An incentive to produce wheat was the fact that wheat functioned as a currency between 1994-1998.

In 1998, the Department of Statistics started to collect household data on the sakrebulo level. In every sakrebulo the data of 10 households is collected every 3 months. Using some of this data and complementing it with interviews with some of the families whose data the household survey consists of, as well as observance and interviews with members of other households, a short description of the average situation of a household in the Khashuri region is given (Table 7). Of course, such an average household can neither reflect the broad variation between the 11 sakrebulos, which are mainly due to the differing natural conditions and the differences in population density, nor the variation inside each sakrebulo, which mostly depends in the composition and resources of the individual household.

Table 7: Household Farm Khashuri District 2000

Family Workforce ¹⁾	3.7
Of Which Pensioners	1.8
Livestock	
Cattle	4
Of Which Cows	1.6
Pigs ²⁾	0.85
Sheep and Goats ³⁾	0.71
Poultry	10.4
Bees ⁴⁾	0.1
Land Use, in percent of Household's Arable Land Cultivated	
Maize	47
Vegetables	7.3
Potatoes	5.4
Wheat	4.6

Notes: ¹⁾ Lowest average on sakrebulo level 2 – highest 5.5;

²⁾ Most pigs are slaughtered in winter;

³⁾ Data of 4 sakrebulo show no sheep or goats;

⁴⁾ 1 sakrebulo had 10 beehives.

Source: DEPARTMENT OF STATISTICS, KHASHURI, household data Quartal I and II 2000, N=110, 10 families from every sakrebulo; data from Interviews 1998, 1999, 2000.

The high proportion of pensioners among the family work force indicates the age structure and the fact that in many families at least one family member is absent for longer periods trying to find a source of income in a large town or abroad.

Because the household data from Quartal I and II is used, variations over the year are not caught. This is in particular the case with pigs. The households usually buy piglets in the spring or summer and slaughter them in winter, so the data over the whole should be higher, about 1-1.2 pigs per household.

According to the data, self-consumption is higher for most products than the amount sold or exchanged (beans, onions, garlic and beef are the exceptions). But this changes in Quartal III where during harvest time substantially more products leave the households. All households mention giving a large amount of produce to relatives and friends as well as bartering. Giving agricultural products as gifts to relatives, friends and acquaintances helps to foster relationships, which are so essential in the Georgian society. This is not a new phenomenon (s. DRAGADZE 1988).

8 CONCLUSION

From the statistics and surveys discussed above it does not seem unrealistic to state that at least two thirds of total agricultural activity in Georgia should be classified as subsistence agriculture. It can be concluded that subsistence agriculture is the most important economic and social factor in the rural areas, enabling the rural population to survive in this time of transition. In agriculture, the transition from large state or cooperative farms to tiny household farms was

very fast. The process of developing a new market and export orientated agriculture will need more time. In the meanwhile, the main problem is the population's lack of purchasing power, which makes them dependent on their own produce.

Taking the employment situation and the dominant role of subsistence agriculture in agriculture today into account, it seems reasonable to predict that widespread subsistence agriculture will be a long term phenomenon in Georgia.

REFERENCES

- BATESON, W. (2000): Rapid Appraisal of Agriculture in Guria, Imereti and Samegrelo Regions of West Georgia, Save the Children, Georgia.
- DEPARTMENT OF AGRICULTURE, KHASHURI (1998): Information Given to the Author During Interviews in August 1998.
- DEPARTMENT OF AGRICULTURE, KHASHURI (1999): Information Given to the Author During Interviews in August 1998.
- DEPARTMENT OF STATISTICS, KHASHURI (2000): Data from Household Survey.
- DERSHEM, L. (2000): Household and Small Commercial Agriculture, Save the Children, Georgia.
- DIDEBULIDZE, A. (1997): Agriculture and Rural Development in Georgia: Problems and Prospects, *UNDP-Georgia Discussion Paper Series*, Tbilisi.
- DRAGADZE, T. (1988): Rural Families in Soviet Georgia, Routledge.
- GACHECHILADZE, R. (1995): The New Georgia, Space, Society, Politics, UCL London.
- SAKARTVELOSSR STATISTIKURI SACHELMZIPO KOMITETI (1989): Sakartvelos ssr Regionebis Sozialur-ekonomikuri Ganvitareba, Statistikuri Krebuli, Tbilisi.
- STATE DEPARTMENT FOR STATISTICS OF GEORGIA (SDS) (1998a): Agriculture of Georgia, Statistical Abstract, Tbilisi.
- STATE DEPARTMENT FOR STATISTICS OF GEORGIA (SDS) (1998b): Sakartvelos Shinameurneobebi 1997 Zels, Ekonomikuri-statistikuri Krebuli, Tbilisi.
- STATE DEPARTMENT FOR STATISTICS OF GEORGIA (SDS) (1999a): Georgian Agriculture 1998, Statistical Abstract, Tbilisi.
- STATE DEPARTMENT FOR STATISTICS OF GEORGIA (SDS) (1999b): Statistical Yearbook of Georgia 1999, Tbilisi.
- UNDP (2000): Human Development Report 2000, Tbilisi.

AGRARIAN REFORM AND SUBSISTENCE AGRICULTURE IN RUSSIA¹

VLADIMIR YEFIMOV

1 SOVIET INSTITUTIONAL HERITAGE OF RUSSIAN AGRICULTURE²

Three of the most important Russian agrarian institutions are the subsistence household farm (personal auxiliary farm), the collective farm, and the district administration.

Before collectivisation, the Russian peasant farms were primarily subsistence farms. Each peasant farm had two types of land plots: a farmstead plot and field plot(s). After 1917 the land belonged to the state but the village community possessed the land around the village and distributed and redistributed field plots between households according to the numbers of people in the family ('eaters'). Collectivisation did not totally liquidate subsistence peasant farms; it collectivised field plots and diminished the number of animals allowed for each household to a subsistence minimum. For most of the Russian peasant households, the number of personal animals kept by a family did not diminish because before collectivisation they kept just this subsistence minimum³. Later, in order to underline the priority of the work on collectivised fields and auxiliary character of the work in household farms, the latter were called Personal Auxiliary Farms (PAF). Stalin started the mass collectivisation not exclusively for ideological reasons, but rather for a pragmatic purpose of extracting resources from the countryside, which was primarily subsistence-oriented⁴.

¹ This paper is based on the PhD dissertation of the author (YEFIMOV 2002).

² An analysis of the "dependence path" of the Russian agriculture is made in (YEFIMOV 2001, 2002).

³ The most important legislative act concerning Soviet agriculture (Standard Statute of Kolkhozes of 1969/1980) determined the limits for household farms in the following way: farmstead plot – 0.5 ha, one cow with a calf younger than one year, one head of fattening cattle younger than two years, one sow younger than three months or two fattening hogs, ten sheep or goats, bees, poultry and rabbits. The average Russian peasant farm as it was just before the collectivisation is characterised in the Table 1 of the Appendix.

⁴ See the Table 2 of the Appendix.

The subsistence character of Russian peasant farms before and after collectivisation is their "genetic" feature. M. SAHLINS (1972) generalised survey results for Russia undertaken at the beginning of the last century⁵ as the "Chayanov rule", according to which "the bigger labour capacity of a household, the less its members work efficiently" because their aspiration levels are low and correspond to a subsistence minimum. My surveys in collective farms of Northern Kazakhstan in 1996-1997 and in Samara province in 1997-1998 witnessed a subsistence-orientation of rural dwellers. They indicated the same number of animals in their PAF answering two different questions: 1. How many animals it is necessary to keep in your PAF just to survive? 2. How many animals it is necessary to keep in your PAF in order to live well? If I tried to convince my respondents that a bigger number of animals would increase the well-being of the family they reacted by saying that if they had more animals they would have to work too hard.

The nature of the institution of collective farms (*kolkhoz*) cannot be understood properly without PAF. The PAFs are the direct continuation of Russian peasant subsistence farms from the pre-collectivisation period. Before the 1960's, the PAF were the only source of survival for Russia's rural population. Even during the most favourable stages of the post-collectivisation period, the share of PAF in incomes of members of collective farms did not drop below 20%⁶. This helped to provide enough potatoes, vegetables, meat, milk and eggs to them. In the 1990's, this share increased in many former collective farms up to 100%. Currently, this is almost the only source for many rural families. The Russian collective farms have never been, and are still not agricultural enterprises (businesses). They served as state control mechanisms of the distribution and usage of agricultural products, and at the same time as mechanisms of survival for the rural population (resources of collective farms could be used for PAF only by members of collective farms). In the 1990's, the first function of collective farms almost disappeared and the second drastically increased. PAFs as subsistence household farms are known to be unable to exist without links with a large neighbouring farm. That is where (often unofficially) most of the fodder for personal livestock comes from. In case of a real, not imaginary privatisation, an end will be put to this situation. Animals of typical PAF are fed not from farmstead plots (0.25 ha – 0.5 ha), but from collective farm produce. A typical PAF would need a 'field plot' of 3 ha – 6 ha to feed them⁷. The rural

⁵ See Tables 3 and 4 of the Appendix.

⁶ See Table 5 of the Appendix.

⁷ A French agricultural economist 40 years ago aptly described collective farm – household farm relations in the USSR: "Un kolkhozien qui a, comme c'est le cas au Kouban, une vache, deux jeunes bovines, une truie et six porcelets et une cinquantaine de poules, n'utilise pas seulement une parcelle de 0.25 hectare, mais aussi la surface nécessaire pour nourrir les animaux puisque les aliments du bétail lui sont fournis en nature par le kolkhoze. On peut dire que son exploitation couvre effectivement de 3 à 6 hectares suivant la qualité du sol. On retrouve tout à fait la consistance des petites exploitations de subsistance en France." (DE CHOMBART LAUWE 1961, pp. 140-141).

dwellers accept it because the work on collective fields is totally mechanised and the most of the work in PAF is manual.

The connection between subsistence household farms and a *kolkhoz/sovkhov* was not limited to receiving feed only. *Kolkhoz/sovkhov* was more than a workplace for countrymen; it was the habitat. It provided a great variety of services. It is now increasingly hard for *kolkhoz/sovkhov* (or former *kolkhoz/sovkhov*) to do so due to a lack of money.

There is a myth about the efficiency of PAFs. They often say that PAFs occupy 3% of agricultural land and produce more than 50% of the volume of the agricultural production of the country. As we have just remarked, the livestock in many PAFs is fed by forage produced in collective farms. The leading role of PAFs in some sectors of crop production is explained not by higher yields (in 1998 yields of potato in PAFs were 9.6 t/ha and in collective farms – 9.7 t/ha), but by the fact that collective farms occupy, for certain crops (for example potato), less land than PAFs. The increase of the share of PAFs in Russian agricultural production comes primarily from the drop in production of collective farms. The growth of PAF production in 1998 in comparison with 1990 was 12.6%, but the livestock production in PAF 1998 decreased by 10% in comparison with 1990. This decrease is determined by the dependency of the PAF livestock production on collective farms fodder production, which have now weaker potential than before. In the 1990's, the subsistence character of PAFs became stronger than before. In 1991, 28.5% of potatoes produced by PAFs were sold on the market; in 1998 they sold only 10.2%. The same tendency is seen in PAF livestock production: meat – 30.1% in 1991, and 22.4% in 1998; milk and dairy products – 25.1% in 1991 and 18.3% in 1998⁸.

Sometimes, opinions are raised that the PAFs serve as a school for private farming for members of collective farms. I do not share this opinion in the case of Russia. The PAF experience, where most of the work is done not by men but by women, does not suit private agricultural businesses for several reasons. First of all, the PAFs are not agricultural businesses but subsistence farms and the family consumes most of its produce. Owners of PAFs are not used to making transactions about inputs and outputs of their farms. They 'take' inputs from collective farms. In the past, they also sold their products to the collective farm, but now most collective farms have stopped this practice. Now, intermediaries coming to the village buy, at a very low price, most of the PAFs products oriented for sale. Many trials to create marketing and other types of co-operatives for the owners of PAFs have failed. The primitive technologies used in PAFs are incompatible with competitive businesses.

⁸ These judgements are made on the basis of the Russian official statistics (see Tables 6 – 12 of the Appendix). It is necessary to take in account that their exactness could be doubtful.

In their current form, the agricultural enterprises essentially remain Soviet *kolkhozes/sovkhazes* (collective state farms), whatever one calls them (partnerships, co-operatives, joint stock companies, etc.). These large-scale farms are not efficient because of diseconomies of scale and, not least, because of the inefficient property structure, where workers and pensioners of the farm own the farm on a quasi-egalitarian basis. These old-fashion Soviet-type agricultural enterprises tolerate and even need the agrarian administrative system. On the other hand, this administrative system would automatically lose most of its power upon the radical reform of agricultural enterprises.

A very significant difference between the management in Soviet agriculture and that in Soviet industry was its direct stewardship by communist party committees at regional levels. The first secretary of the district (*rayon*) communist party committee was the main decision maker in this branch of the Soviet economy. The district's department of agriculture helped him to make decisions, but never made them in his stead.

Current district administrations coming to substitute the "Party and Soviet organs" with the help of their departments of agriculture fulfil, in many respects, the same functions as in the Soviet past, among them: the distribution of subsidies and inputs provided in credit (fuel, fertilisers, and seeds). In many cases, these credits, as in Soviet times, are not paid back. Because most of the agricultural enterprises are bankrupt and their current bank accounts are blocked, district administrations participate in the development of financial schemes to provide cash for collective farms.

2 OBJECTIVES AND LEGISLATION OF AGRARIAN REFORM IN POST-SOVIET RUSSIA

The objective of post-Soviet agrarian reform in Russia was transition to western-style agriculture. Two legislative acts provided the basis of this reform: the Decree of the President of Russian Federation of December 27, 1991, "On urgent measures of accomplishment in land reform in the Russian Federation" (PASHOV 1999), and the Resolution of the Government of Russian Federation of December 29, 1991 "On the rules of the reorganisation of collective and state farms" (PASHOV 1999).

The Decree of the President provided that the state and collective farms were obliged in 1992 to undergo reorganisation. They were to put their juridical status in conformity with the Law "On the enterprises and entrepreneurial activity", in which such forms of enterprises as collective farms and state farms were not stipulated. The local bodies of the executive authority were recommended to ensure the control of realisation of the right of the members of collective farms and workers of the state farms for an unobstructed exit from these farms for the creation of private peasant farms. The collectives of *kolkhozes* and *sovkhazes*

using the land with the right of permanent use according to this Decree had to take the decision before March 1, 1992 on transition to private individual, collective-shared and other patterns of ownership. The local administrations had to supply the citizens becoming the proprietors of land appropriate certificates on the land property rights. The Decree laid under obligation the heads of collective and state farms to allocate land shares to the workers and members of their families within one month from the date of submission of the application for the creation of a peasant farm. The property shares were also simultaneously with land shares. In the case of delay with the allocation of land and property shares, the heads of farms were fined at a rate of three monthly salaries by local bodies of the Committee on land reform and land resources. The same Decree granted peasant farms the right of land mortgage in banks, and banks were allowed to allot credits under the land mortgage.

The provisions of the Decree of the President were developed in the Resolution of the Government. In addition, the Resolution contains norms which were not present in the Decree. So, by this Resolution, collective and state farms were authorised to transfer objects of the social spheres such as residential houses, inter-farm roads, energy supply systems, water-supplies, gas supplies, telephone lines and other objects to the property of the Rural Councils. The Resolution envisaged such radical measures as the liquidation of collective and state farms, which had no financial resources for servicing the debt of wages and credits. According to this Resolution, they had to be announced insolvent (bankrupts) by February 1, 1992 and the liquidations and reorganisation had to take place during the first quarter of 1992.

It is interesting to note that two months after the publication of this Resolution, an important update was introduced to its text, which cancelled the compulsion for collective and state farms to put their status in conformity with the Law "On the enterprises and entrepreneurial activity". They were allowed to stay collective state farms if approved by assemblies of their labour collectives, and if the former juridical form of managing decisions about preservation of the land was fixed to them according to the current legislation. In practice, no collective farms declared bankruptcy.

Agrarian reform, the frame of which was determined in the Decree of the President of December 27, 1991, and the Resolution of the Government of December 29 of the same year, did not proceed according to the prescriptions the President and the Government. The Decree and the Resolution were either not executed at all, or were executed only formally by changing signboards without any essential or real changes in the functioning of agrarian institutions of the Soviet type.

The Decree of the President of the Russian Federation of October 27, 1993 "On regulation of land relations and the development of agrarian reform in Russia" (PASHOV 1999), was to substitute and act instead of the absent radical land law.

Following the idea of its authors, it should have loosened the deadlock of agrarian reform in Russia. Among other things, this Decree provided that the proprietors of land shares have the right, without the consent of other joint owners, to assign a land lot in kind for management of a peasant farm, which they can mortgage and lease. They can also use it for the extension, up to the established norm, of a plot used for a personal household farm. This Decree allowed the proprietors of land shares, without the consent of other proprietors, to sell land shares to other members of the collective, and also – and it was a serious innovation – to other citizens and legal persons for agricultural production.

At this time, an experiment in the Nizhniy Novgorod province was undertaken with technical assistance from the International Finance Corporation of the World Bank. Within the framework of this experiment, auctions for the sale and purchase of land shares and property shares took place inside some farms (IFC 1995). The government approved this experiment in the Resolution of April 15, 1994 "On the practice of agrarian transformations in the Nizhniy Novgorod province" (PASHOV 1999). A little later, on July 27, 1994, the government accepted a new Resolution "On reforming the agricultural enterprises taking into account the practice of Nizhniy Novgorod province" (PASHOV 1999). The rules of realisation for auctions distributing land and property inside farms for the reorganisation of agricultural enterprises were supplemented into this Resolution.

On 1st February 1995, in the Resolution "On the procedure of realisation of the rights of proprietors of land shares and property shares" (PASHOV 1999), the Government approved two documents enclosed in this resolution. They were "the Recommendations for preparation and issue of the documents about the right to land shares and property shares" and "the Recommendations about the order of disposal of land shares and property shares". These recommendations concretised the provisions already stated in the earlier accepted resolutions of Government on the agrarian reform.

In 1996 it had already become clear that agrarian reform in Russia, as determined at the end of 1991 in the Decree of the President and Resolution of Government, had failed. The Decree of the President of March 27, 1996 "On the realisation of the constitutional rights of the citizens for land" (PASHOV 1999) is an implicit confession of it. It repeated once again what was already stated in the Decrees of 1991 and 1993, but which was not actually realised, and clarifications of the previous norms were offered so that they at last would begin to work.

All above-mentioned legislative acts are founded on a certain theoretical basis. This basis is liberal neo-classical economic theory. According to this theory, an economy and its sectors, including agriculture, consist of independent actors: producers and consumers. All these actors produce, consume, buy and sell. Producers maximise their profits and consumers make their choices according to their consumer preferences. No structure or institutional framework (rules) for

transactions between actors are envisaged in this theory⁹. Advocates of the neo-classical theory believe that those market structures or institutions are created rapidly by the introduction of new rules providing maximum freedom for these transactions¹⁰ or even by themselves in the process of transactions. The most important statement of the neo-classical theory is the following: if both types of actors (producers and consumers) make decisions in such a way as described above, then the market forces ('The Invisible Hand') inevitably establish so-called equilibrium prices and bring the allocation of scarce resources to the most efficient actors. From the point of view based on this theory, an initial allocation of resources among actors does not play an important role because market forces will change the situation rapidly in favour of the most efficient actors. Besides, in the liberal neo-classical theory, there is no state, and many advocates of this theory believe that the less state, the better.

Agrarian privatisation in Russia was executed on an egalitarian basis. It meets the criteria of justice, but it does not at all exhibit the criteria of efficiency. But the authors of land reform legislation did not worry about that because they were neo-classical economists. They estimated that the most important thing is the right of owners of land and asset shares to buy and sell them. According to them, the inclusion of this right into legislation is sufficient to start a process of creation of viable agricultural enterprises on the land of former collective and state farms, with the subsequent concentration of land and other assets in the hands of the most efficient farmers. The reformers did not pay any attention to such an institution as PAF.

An alternative to the neo-classical approach is the institutional approach. Actors in this theory are not independent and are not only producers and consumers. Instead, the state is one of the most important actors. Transactions between these actors are not spontaneous and are structured by formal and informal rules (institutions). The introduction of new legislation (formal rules) does not automatically change human behaviour. Informal rules rooted in traditions can continue to determine human behaviour and new formal rules can be rejected or not followed, or their application distorted, especially if they contradict interests of actors. The new legislation needs to be enforced (NORTH 1990).

3 IMPEDIMENTS TO RUSSIAN AGRARIAN REFORM IN THE 1990'S

We think that the current state of the Russian agrarian reform is a direct result of ignoring the nature of agrarian institutions inherited from Soviet times and the application of a liberal neo-classical approach in the law making process¹¹. The

⁹ Many neo-classical economists think that these transactions are spontaneous.

¹⁰ This point of view is shared not only by neo-classical economists but also by many lawyers (PROSTERMAN and HANSTAD 1999) and political scientists (WEGREN 1998).

¹¹ The same conclusion can be made concerning agrarian reforms in other former Soviet republics (YEFIMOV 1997).

most important problem which presents impediments to agrarian reform is the role of collective farms as the mechanisms of survival for rural communities.

Rural dwellers understand very well that if former collective and state farms were substituted by real private enterprises, then they would lose the only source of survival they have: PAF or Subsistence Household Farm (SHF). They also understand that only a minority of them could create agricultural businesses and the majority would lose access to fodder from collective farms and would not be employed in the new private agricultural enterprises. That is why they resist any transformation of their collective state farms. They resist not as individuals, but as a community. So members of the community who wish to create private enterprises are under pressure from the community worried about subsistence household farms. Agrarian reform legislation provided rural dwellers with a very powerful tool for this resistance: privatisation of collective state farms by members of these farms on an egalitarian basis¹².

Egalitarian land distribution and the absence of alternatives to collective farms' survival mechanisms is the second impediment for agrarian reform in Russia. My multiple interviews with members of collective farms prove that they consider their land share certificates not as certificates of the right for decision-making and dividends, but as certificates of their membership in the community for which the collective farm is a survival mechanism. They expect from the collective farm just the continuation of support for their PAFs and some other services, as was the case before the 1990's. For rural dwellers, to sell land shares means psychologically and administratively to be excluded from the community, and it is impossible for those who continue to live in the village (the absolute majority). Even when a collective farm is dismantled, and in this way the economic basis of the village community is disorganised, villagers look to be attached to some new community (sub-community of the old one) using their land shares. A pensioner perceives the leasing of her land share by a private farmer not really as a land transaction but as her affiliation to a community where the private farmer is the chief. The vital necessity for rural dwellers to be affiliated to a community for the provision of resources for their households and the role of collective farms as economic and organisational basis of the community is the main cause of the absence of land shares market. Workers of collective farms continue to work on these farms in spite of the fact that they are not paid for months and sometimes years. They do so in order to have access to

¹² French sociologist HENRY MENDRAS 25 years ago foresaw a transformation of Soviet collective farms into a producer of fodder for household animals in the case of the transfer of decision-making power to their members: "Aujourd'hui (1976) le kolkhoze comporte une exploitation collective fréquemment consacrée à la culture des céréales facilement mécanisables... tandis que les lopins individuels des kolkhoziens sont spécialisés dans les cultures maraîchères et arboricoles et dans l'élevage... Si la coopérative est gérée par l'assemblée de ses membres, une tendance naturelle se manifesterait chez ces derniers d'utiliser l'exploitation collective au profit de leurs cultures et de leurs élevages individuels, et notamment de nourrir leur bétail avec des céréales détournées de la production commune..." (MENDRAS 1995, p. 54).

the resources of the farm to maintain their PAF – the most important factor of their survival.

The last but not least impediment to agrarian reform is the absence of a sufficient number of candidates prepared for private farming activity. The authors of the Russian agrarian reform legislation did not ask themselves who would become a private farmer cultivating his own land. They thought that a sufficient number of candidates prepared for private farming activity already existed in villages and cities. At the beginning of the 1990's, 3/4 of the creators of private family sized farms were city dwellers. Many of them left their farms quite rapidly. A large amount of money provided to them by the Russian government in the form of soft credits did not bring many results. After ten years of the private farming experience in Russia, empirical evidence says that the most efficient owners of private family agricultural businesses are former managers, especially chairmen and directors, of collective state farms. This is partially the result of their affiliation with local informal business and administrative networks, but it is also due to their entrepreneurial capacities, including communication. Ordinary members of former collective state farms are usually unable to run a business farm because of their insufficient educational, and more generally, cultural background. The requirements for private farmers in Russia to be successful are higher than in Europe because of a more complex and difficult to manage business environment, and because of the absence of adequate advisory services for private farmers.

From the point of view of the medium- and long-term perspectives, maybe the most important mistake of Russian agrarian reform policy and legislation is the conservation of the orientation of agricultural education and training for a collective farm system. A very important part of the modernisation programmes of agriculture in European Union countries was always agricultural education and training. It is possible to say that Russia has already lost almost 10 years in making progress in this domain.

Surveys undertaken by the author between 1997-2000 in seven Russian provinces among rural civil officers, farms' heads, collective farms' workers, and also among professors and students of agricultural universities and colleges have revealed that the majority of those who are connected with agriculture share a common set of ideas and beliefs of a mythical nature. The most important statements of the dominant agrarian ideology oriented to support the inefficient Soviet style agricultural system are the following:

- The state must control and finance agriculture as well as buy a large share of agricultural production, and supply to farms a large share of their needs for inputs;
- Land is the people's public good, and cannot be sold or purchased;
- In the West, private property is not important, and most Western farmers are tenants;

- Russians have worked in collectives for centuries; they are collectivists; they can work only in collective farms;
- Large collective farms are potentially more efficient than family farms because they can more successfully use the achievement of technological progress;
- In the West, family farms are disappearing and large corporate farms produce most of the agricultural production;
- The cause of non-profitability of collective farms is the disparity of agricultural and industrial product prices and the absence of sufficient support of agriculture by the Russian government;
- All forms of farm enterprises, collective farms under different juridical forms, family farms, personal auxiliary farms, must be equal in rights and require support from the government.

It is quite easy to refute all these statements.

4 INCOMPATIBILITY OF CURRENT DOMINANT RUSSIAN AGRARIAN INSTITUTIONS WITH A MARKET ECONOMY

The incompatibility of current Russian agrarian institutions with a market economy comes from the economic inefficiency of collective farms and universal theft and corruption as inherent features of the current Russian agricultural regime.

The economic inefficiency of collective farms was obvious in the Soviet period when these farms were plunged into a favourable environment of the state control-input supply-output procurement. In the Soviet period, collective farms were low yield and/or high cost farms, but all of a farms' losses were covered by the state. Now that the state is no longer the only owner of all branches of the Russian economy, it is unable and unwilling to do so. Weak revenues of urban dwellers and the presence on the market of cheap imported food do not allow farm gate prices to grow. So collective farms are condemned to non-profitability. An immediate consequence of this non-profitability is the degradation of farm machinery and equipment. The latter creates the situation that the collective farm is able to produce minimally just to provide fodder to household animals. In this way the whole branch is becoming subsistence-oriented.

In the Soviet period, three main institutions of the collective state farm system (collective farms, household farms and regional administrations) had coherent interaction between themselves. In pre-reform Russia, rural inhabitants lived to a large extent by producing food in their subsistence household farms. The livestock of household farms was fed by fodder produced in collective farms. Collective farms were obliged to follow their "first commandment": "to hand over grain (and other produce) to the state". The owner of all farms was the state

and regional authorities, as representatives of the state in the region, controlled as much as they could the functioning of farms. Key decisions concerning farms were made not on farms but at the regional (district) level by communist party bureaucrats. But at the same time, regional authorities organised input supplies to farms and output procurement from them. All levels of authorities were responsible for the results of farms' functioning towards their superiors. Theft and corruption took place at that time, but could not surpass a certain level because of the existence of strong hierarchical control systems.

The situation radically changed when Russia undertook transition to a market economy. The communist party, as a ruling core of the Russian society and economy, has disappeared. At the same time, all collective state farms have been formally privatised. The Soviet state was a bad owner of farms, but with the beginning of the transition, the collective farms were left without any owner at all. Afterwards, these farms were plunged into an unfavourable, and inadequate for them, environment of a market economy. Private traders, private farmers, household owners, all of them took advantage of the absence of a real owner of collective farms. Private traders buy farm products at a lower price than the market price by bribing the farm director. Private farmers 'buy', for a bottle of vodka, the fuel from a tractor driver of a collective farm. Practices which previously existed in the Soviet Union, '*nesunstvo*' (taking), or of stealing (taking) fodder for household (personal auxiliary) farms' animals from collective state farms – have assumed a larger scale than before. Regional (district and province) authorities are no longer responsible for the results of a farms' functioning towards their superiors. They also take advantage of this situation and of the absence of real owners of collective farms to enrich themselves through large-scale corruption. They get bribes from private companies and force collective farms to accept unprofitable conditions of input supplies and output sales. In this way, all three main institutions of the state/collective farms' system – collective farms, household farms and regional (district and province) administrations – are involved in illegal activities which destroy Russian agriculture.

Collective farms and personal auxiliary farms connected closely with the former together makeup the dominant agrarian structures in Russia. The preservation of these structures in the market economy environment inevitably contributes to the degradation of the Russian agriculture, its growing primitivism, and increasing orientation to self-consumption by the village population. It is becoming inevitable because of the increasing wear of engineering inherited from the Soviet times. The latter provokes a gradual decrease of cultivated surface. Not only are poor lands abandoned. During my recent survey in the Kursk and Rostov provinces (black soil areas), local experts told me that 1/3 of agricultural land is not used and official statistics hide it by including it in the category

"fallow". At the same time, these experts witness that this unused land is not accessible to the people outside of collective farms.

5 A WAY FROM THE DEADLOCK

The standstill in Russian land reform can be explained by a tacit but strong resistance to reform not only from the agrarian bureaucracy, but also from the totality of the rural population. They understand that the majority of them will not be employed by commercially-oriented agricultural enterprises and with real privatisation by efficient owners, they will lose access to resources that maintain their SHF – the only source of their survival.

In order to find a way out from this deadlock, it is necessary to divide business and social support functions. Business farms do not have to fulfil social functions. These functions should be exercised by special non-commercial organisations. Forms of these organisations could be agricultural consumers' co-operatives and municipal enterprises. The establishment of agricultural consumers' co-operatives or municipal community support enterprises in each village might help to solve the above-mentioned problems.

Agricultural consumers' co-operatives and municipal community support enterprises should be created to execute the following functions:

- Production of fodder, including green pastures and a free supply of fodder to SHF in the minimum quantities required for one rural family;
- Production of food grain, bread baking and a free supply to countrymen at predetermined norms;
- Supply (for fee) of fodder to personal farms above the amounts supplied free of charge;
- Delivery of paid services for selling SHF produce;
- Transport and other paid services for members of the community;
- Financial support of certain social infrastructure facilities.

Subsistence household farms and agricultural consumer co-operatives (municipal community support enterprises) that back them are not the most efficient forms of organisation for agricultural production. The creation of agricultural consumer co-operatives (municipal community support enterprises) is a forced measure required in order to mitigate the difficulties of efficient market transition experienced by the countrymen. It also creates opportunities for the more painless implementation of real privatisation and restructuring of former *kolkhozes/sovkhozes* when efficient private agricultural commercial ventures are created on their lands not being used for the organisation of agricultural consumers' co-operatives or municipal community support enterprises. In this case the rural community will be far less resistant to the creation of private enterprises because there is a guarantee of free fodder supply

for the community members' SHF by agricultural consumers' co-operatives or municipal community support enterprises.

Some calculations show that approximately 1/3 of the land of former *kolkhoze/sovkhoze* (depending on density of population and soil fertility) is necessary for the creation of such agricultural consumer co-operatives (municipal community support enterprises). This also corresponds to expert estimates made by certain heads of collective farms in the Samara province that 1/3 of the resources of the collective farm serves to support the SHF. In fact, in many other provinces of Russia, especially in the non-*chernozem* zone, the share of resources used to support the SHF is approaching 100%. A rational organisation of agricultural consumers' co-operatives or municipal community support enterprises does not need all the collective farm's land. Much land would remain for the creation of real private agricultural enterprises, including business-oriented family farms.

Current Russian legislation permits the creation of such agricultural consumers' co-operatives in each village by every family wishing to join in the consumer co-operative of the village contributing a part of their land and assets shares. Similar procedures can be applied for the creation of municipal community support enterprises by giving this part to local administration. Every version of the community support enterprise has its pluses and minuses, however, especially taking into consideration the ongoing difficulties in Russia of the self-organisation of rural dwellers; the version of municipal enterprise therefore has more chance for success.

If the choice is made in favour of a consumer co-operative, then the following principles must be applied:

- The chairman and the director of the co-operative are different persons. The first one is a representative of the community with the task to supervise the functioning of the co-operative in the interests of its members. The second is a professional manager employed by the co-operative;
- Members and workers in consumer co-operatives are, in principle, also different persons. Members of the co-operative have rights for free and paid services irrespective of whether or not they work in the co-operative. Workers of the co-operative are much less numerous than members and can, in practice, be employed from outside of the community;
- A consumer co-operative is not a profit-oriented organisation. Such co-operatives don't have to pay income tax because their income is returned in one form or another to its members. Special favourable tax conditions must be created for this kind of enterprise.

Fixed assets of agricultural consumer co-operatives and municipal community support enterprises can be created to a large extent by assembling a part of land

and assets shares of community members. Working capital should be provided by the State under the form of gift and soft credits.

We suggest that Russian legislators enact a special law on the communal rural community support enterprise and to make necessary amendments to the law on agricultural co-operation concerning specific consumers' co-operatives described above.

In order to create favourable conditions for the emergence of efficient private farming businesses on the lands left over on collective farms after the organisation of agricultural consumer co-operatives or municipal community support enterprises (2/3 of agricultural lands), adequate legislation and institutions must be put in place.

APPENDIX

Table 1: Average Russian Peasant (Household) Farm in 1924/1925

	Number of Persons in the Household	Agricultural Land, ha	Arable Land, ha	Horses	Oxen	Cows	Total Cattle Converted in Adult Units
Zone of Consumption	6.01	6.5	3.46	0.98	0.00	1.69	3.73
Zone of Production	6.10	9.46	7.68	0.92	0.09	1.19	3.51
North-Caucasus	6.05	10.3	7.35	1.06	0.92	1.64	5.63

Source: CHAYANOV (1928, p. 199).

Table 2: Table from Nemchinov's Memorandum to Stalin (1928)

	Grain Production		Marketable Grain		% of Marketability
	Mln. Puds	%	Mln. Puds	%	
Before the War					
Landlords	600	12.0	281.6	21.6	47.0
Kulaks	1,900	38.0	650.0	50.0	34.0
Middle/Poor Peasants	2,500	50.0	369.0	28.4	14.7
Total	5,000	100	1,300.6	100	26.0
After the War (in 1926/1927)					
Sovkhozes/Kolkhozes	80.0	1.7	37.8	6.0	47.2
Kulaks	617.0	13.0	126.0	20.0	20.0
Middle/Poor Peasants	4,052.0	85.3	166.2	74.0	11.2
Total	4,749.0	100	630.0	100	13.3

Source: STALIN (1952, p. 194).

Table 3: Chayanov's Survey of 1910 in the Volokolamsk District of Moscow Province

Eaters/Workers Ratio	1.01 – 1.20	1.21 – 1.40	1.41 – 1.60	1.61 – ∞
Production per Worker in Rubles	131.9	151.5	218.8	284.4
Number of Working Days per Worker	98.8	102.3	157.2	161.3

Source: CHAYANOV (1966).

Table 4: Chayanov's Survey of 1912-1913 "Production per Worker in Rubles"

Eaters/Workers Ratio	1.00 – 1.15	1.16 – 1.30	1.31 – 1.45	1.46 – 1.60	1.61 – ∞
Starobelsk District of Kharkov Province	68.1	99.0	118.3	128.9	156.4
Vologda District of Vologda Province	63.9	79.1	84.4	91.7	117.9
Velsk District of Vologda Province	59.2	61.2	76.1	79.5	95.5

Source: CHAYANOV (1966).

Table 5: Share of Incomes from PAFs in Households' Incomes of Kolkhozes' Members

1970*	1980*	1980	1985*	1985	1990	1991	1992
35.1	27.5	25.1	26.2	21.8	21.5	30.0	41.6

Note: * data for the USSR.

Sources: Russian Federation in 1992, Goscomstat, Economy of the USSR in 1988, Goscomstat.

Table 6: Parts of Different Types of Farms in Russian Agricultural Production, in percent

	1985	1990	1991	1992	1993	1994	1995	1996	1997	1998	1999
"Agricultural Enterprises"	76.9	73.7	68.8	67.1	57.0	54.5	50.2	49.0	46.5	38.7	40.3
Households' Farms	23.1	26.3	31.2	31.8	39.9	43.8	47.9	49.1	51.1	59.2	57.2
"Peasant Farms"	0	0	0	1.1	3.1	1.7	1.9	1.9	2.4	2.1	2.5

Source: Agriculture in Russia, Goscomstat (1998, 2000).

Table 7: Distribution of Agricultural Lands Between Different Types of Farms, in percent

	1985	1990	1991	1992	1993	1994	1995	1996	1997	1998	1999
"Agricultural Enterprises"	98.4	98.1	91.2	85.2	82.8	82.4	81.7	81.4	80.4	83.7	81.9
Household Farms	1.6	1.8	2.6	4.0	4.2	4.4	4.7	4.7	4.9	5.4	6.0
Personal Gardens	0.2	0.4	0.7	0.8	0.9	0.9	0.9	0.8	0.8	0.8	0.8
Personal Auxiliary Farms	1.4	1.3	1.9	3.0	2.6	2.7	2.5	2.6	2.7	3.0	2.8
"Peasant Farms"	-	0.1	0.6	3.1	4.6	4.8	5.0	5.2	5.7	6.6	6.9
Communal Pastures*	-	-	5.6	7.2	7.7	7.7	8.3	8.3	8.4	4.0	4.9

Note: *Author's estimates.

Source: Agriculture in Russia, Goscomstat (1998, 2000).

Table 8: Personal Auxiliary Farms (Rural Household Farms)

	1985	1990	1991	1992	1993	1994	1995	1996	1997	1998	1999
Number, Millions	15.7	16.3	17.1	19.3	16.6	16.6	16.3	16.3	16.4	16.0	15.5
Middle Size, ha	0.2	0.2	0.27	0.35	0.35	0.37	0.36	0.36	0.36	0.4	0.4

Source: Agriculture in Russia, Goscomstat (1998, 2000).

Table 9: Evolution of Production Indices of Household Farms

	Previous Year = 100%						Year 1990 = 100%				
	1990	1995	1996	1997	1998	1999	1995	1996	1997	1998	1999
Potatoes	103	120	97	97	85	100	176	171	166	141	141
Vegetables	95	129	99	103	99	113	260	270	270	270	300
Meat	104	96	98	98	99	96	112	110	108	106	104
Milk	102	100	100	99	100	100	122	122	121	121	121

Sources: Agriculture in Russia, Goscomstat (1998, 2000); Agricultural activity of households in Russia, Goscomstat (1999).

Table 10: Herd Size in Household Farms, Thousands of Heads

	1990	1995	1996	1997	1998	% in National Herd	
						1990	1998
Cattle Total	9,866	11,394	10,901	10,425	9,919	17.3	34.8
Cows	5,235	6,705	6,483	6,238	5,979	25.5	44.4
Pigs	7,076	7,556	7,246	6,963	7,393	18.5	42.9
Sheep	13,584	11,030	9,426	8,487	4,339	24.6	54.7
Goats	2,510	2,398	2,214	2,073	1,951	87.1	91.0
Horses	274	765	799	827	820	10.5	45.5
Rabbits	3,692	1,437	1,250	1,116	1,065	80.3	92.8
Poultry*	195	161	151	143	139	29.5	39.0
Bees**	2,771	3,107	2,911	2,837	2,887	61.5	82.0

Notes: * in millions of heads, ** in thousands of beehives.

Source: Agricultural activity of households in Russia, Goscomstat (1999).

Table 11: Comparison of the Evolutions of Yields in Household Farms and National Average Yields

	Households' Farms					National Average Yields				
	1990	1995	1996	1997	1998	1990	1995	1996	1997	1998
Potatoes, c/ha	113	120	116	113	96	104	117	114	111	97
Vegetables, c/ha	148	161	154	151	147	167	148	145	147	141
Beef, kg/head	188	156	151	156	161	121	93	88	96	103
Pork, kg/head	300	202	191	195	202	118	99	96	109	120
Milk, kg/cow/year	2,582	2,388	2,412	2,462	2,558	2,731	2,153	2,144	2,239	2,381

Sources: Agriculture in Russia, Goscomstat (1998, 2000); Agricultural activity of households in Russia, Goscomstat (1999).

Table 12: Comparison of Evolutions of Marketability of Household Farms and Agricultural Enterprises (Former Kolkhozes/Sovkhozes), in percent

	Households' Farms					"Agricultural Enterprises"				
	1991	1995	1996	1997	1998	1991	1995	1996	1997	1998
Potatoes	28.5	12.2	10.2	10.0	10.2	42.9	32.5	34.7	38.7	43.5
Vegetables	16.7	8.8	8.8	9.5	9.5	92.2	71.3	73.8	72.0	83.0
Meat	30.1	23.0	23.2	22.9	22.4	97.4	100	100	100	99.8
Milk	25.1	18.4	18.4	18.3	18.3	90.4	78.8	78.3	80.3	78.5

Sources: Agriculture in Russia, Goscomstat (1998, 2000); Agricultural activity of households in Russia, Goscomstat (1999).

REFERENCES

- CHAYANOV, A.V. (ed.) (1928): Results of the Decade of Soviet Power in Figures 1917 – 1927, Moscow.
- CHAYANOV, A.V. (1966): The Theory of Peasant Economy, Richard D. Irwin, Homewood, Ill.
- DE CHOMBART LAUWE, J. (1961): Les paysans soviétiques, Editions du Seuil, Paris.
- IFC (1995): Land Privatization and Farm Reorganization in Russia, The World Bank, Washington, D.C.
- MENDRAS, H. (1995): Les sociétés paysannes, Editions Gallimard, Paris.
- NORTH, D. (1990): Institutions, Institutional Change, and Economic Performance, Cambridge University Press, Cambridge.
- PASHOV, M.C. (ed.) (1999): Agrarian Legislation of the Russian Federation, Collection of Legislative Acts and Documents, Yurist, Moscow, (in Russian).
- PROSTERMAN, R., HANSTAD, T. (eds.) (1999): Legal Impediments to Effective Rural Land Relations in Eastern Europe and Central Asia, *The World Bank Technical Paper, No. 436*, The World Bank, Washington, D.C.
- SAHLINS, M. (1972): Stone Age Economics, Aldine-Alderton, New York.
- STALIN, J. (1952): Questions of Leninism, Politizdat, Moscow.
- WEGREN, S.K. (1998): Agriculture and the State in Soviet and Post-Soviet Russia, University of Pittsburgh Press, Pittsburgh.

- YEFIMOV, V. (1997): Approche institutionnelle de l'analyse de la transition (le cas de l'agriculture du Nord-Kazakhstan), *Revue d'études comparatives Est-Ouest*, Vol. 28, No. 2, Paris.
- YEFIMOV, V. (2001): Continuité et recomposition des régimes agraires russes dans le siècle, *Economie et Société, Série: Développement, croissance et progrès, Développement – III*, No. 9-10, ISMEA, Paris, pp. 1439-1476.
- YEFIMOV, V. (2002): Transformations agraires en Russie (Idéologies, législations, fonctionnement des institutions), PhD dissertation, IUED, Geneva University, 2002.

ECONOMIC BACKGROUND AND DEVELOPMENT OPPORTUNITIES OF INDIVIDUAL SUBSIDIARY HOLDINGS IN THE UKRAINE: SOME EMPIRICAL EVIDENCE

ANDRIY NEDOBOROVSKYY

1 INTRODUCTION

Individual Subsidiary Holdings (ISH) are a special form of 'cooperation' between rural households and large agricultural enterprises (LAE). Although cultivating only 13% of Ukrainians agricultural land, ISH manage to produce almost 60% of gross agricultural output. It is evident that the production of these ISH relies to a large extent on inputs obtained from LAE. This can be seen as a form of external financing of ISH through LAE.

This case study attempts to explain the large share of the output of ISH in the total agricultural production in the Ukraine, and considers their development opportunities. Concurrently, the following questions should be answered:

1. What are the main sources of production inputs for the ISH?
2. How do the ISH pay for these inputs and what is the actual value of the inputs?
3. What is the margin between revenues from sales and production costs?
4. What is the probable future development of the ISH?

The study is based on a survey of ISH members in three regions of Zhytomyr Oblast, the Ukraine. In the survey, 90 ISH that were linked to 17 large agricultural enterprises were considered. Data on the LAE were obtained from the Zhytomyr Department of Agriculture. The interviews were conducted between March and August 2000.

2 ECONOMIC BACKGROUND OF AGRICULTURE IN THE UKRAINE

During transition, many Ukrainian agricultural enterprises found themselves in a deep economic crisis. Generally, the privatisation and restructuring of the enterprises was merely formal. Agriculture mainly suffers from an adverse

overall economic situation, liquidity problems, and poor infrastructure. In the 1990s the accumulated decline of agricultural output was 51%. In 2000, total agricultural output was recovering, as it increased by 9%, whereas the decline of livestock production continued (Figure 1). Over 43% of the agricultural large-scale enterprises were still not profitable in 2000.

Figure 1: Ukrainian Agricultural Production, 1990 = 100%

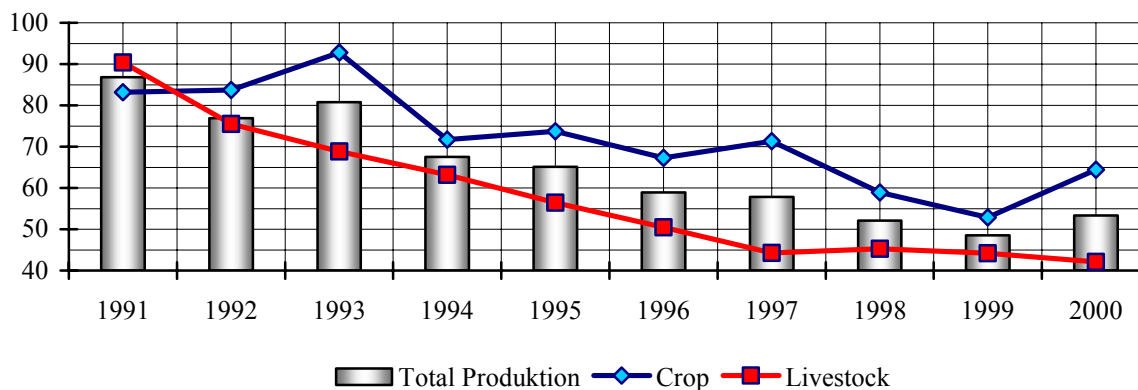

Source: THE STATE COMMITTEE OF STATISTICS OF UKRAINE (1999).

At the same time, the role of the ISH in agricultural production increased substantially. In fact, during the economic crisis, they became the most important agricultural producers in the Ukraine. Although the ISH' share of total agricultural production did not change in absolute terms, their relative share increased significantly, mainly because of the pure performance of the LAE (see Figure 2).

Figure 2: Agricultural Output in Public and Private Sectors, UAH mln (in Constant Prices of 1996)

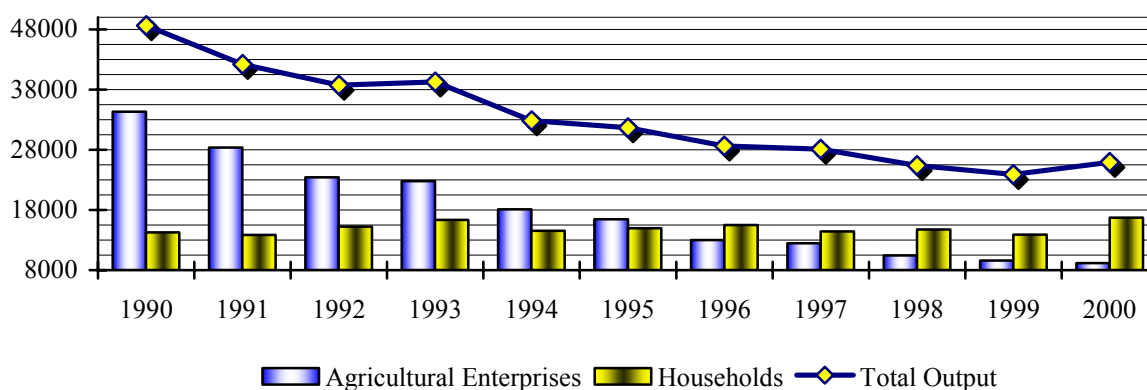

Source: THE STATE COMMITTEE OF STATISTICS OF UKRAINE (2001).

Gradually, agricultural production has shifted from the public to the private sector. This can be shown in the case of livestock production: There was a strong decline in the number of cows and pigs in the public sector from 1990-1999 (pigs down to 29% and cows to 38%), and the growth in the ISH (by 11% and by 34%, respectively). At the same time, in spite of the general decrease of

poultry, the reduction in the ISH was not that strong as in LAE (80% of LAEs in comparison to 16% in ISH).

The main reason for the increasing importance of the ISH is the necessity of securing food consumption of households. Moreover, the ISH provide additional income (in most cases, the ISH are the only income source) and to improve the living standards of the rural population. Currently, the ISH are also an important and growing supplier of agricultural products to the markets; this is due to the insufficient payment of wages in large agricultural enterprises.

3 DEVELOPMENT AND EFFICIENCY OF INDIVIDUAL SUBSIDIARY HOLDINGS IN THE UKRAINE

3.1 Hypothesis of the Study

This study will test the following hypothesis:

Members of LAE are interested in allocating a significant share of their income from the LAE as production inputs to their own ISH. Without these inputs, most ISH would hardly be able to survive in the future. This is due to the fact that the benefits from making part of the transaction (here: inputs) within the hierarchy of ISH-LAE are higher than from making the transaction on markets, as purchasing prices on markets are significantly higher than the prices within this hierarchy.

The ISH are of high importance in rural economies. As the large agricultural enterprises defer the payment of wages, the ISH remain the main sources of income. The efficiency of the ISH strongly depends on the opportunity to receive inputs for their households. Further analysis will show that the main sources of inputs are ISH' own production, and inputs from large agricultural enterprises that are either free of charge or distributed at lower prices than market prices. This statement is also supported by STRIEWE et al. (2001, p. 26).

3.2 Sample Characteristics

The data on labour endowment of the ISH is shown in Table 1. The interviewed ISH have, on average, 2.8 members with and average age of 43.5 years.

Table 1: Size and Age Structure of ISH

	Number of Members	Age	
		Male	FEMALE
Maximum	4	76	76
Minimum	1	24	22
Average	2.8	43.5	43.5

Source: Own presentation based on NEDOBOROVSKYY (2000).

In summer, labourers mainly spend 3 to 6 working hours (4.4 hour per day on average) in their ISH and approximately 2 to 4 working hours (3.9 hours per day on average) in winter. This is a half of an average working day in LAE. In addition, the ISH work on average 1-3 times week overtime to sell their products.

Table 2: Household's Time for Sales and Purchase of Inputs

	Number of Households Who Sell Products; Hours per Day in:		Inputs Purchase, Hours/Year
	Winter	Summer	
Minimum, Hours	1	1	100
Maximum, Hours	8	8	480
Average, Hours	1.0	1.1	296
Median, Hours	1.0	1.1	240

Source: Own presentation based on NEDOBOROVSKYY (2000).

The high level of unemployment in rural areas explains the huge proportion of working time which can be spent for selling products and purchasing inputs. In the Ukraine, labour opportunity costs in rural areas are considerably low due to high unemployment and the lack of other income sources. Normally, employees of LAE are paid for 8 working hours per day, but usually they do not spend the whole time at the enterprise. Thus, being fully paid and working only part-time in the enterprise due to a lack of independent management control, the households are highly motivated to allocate a large part of their labour force to the ISH.

In general, private households are not well equipped with farm machinery. Capital endowment of ISH is very poor. Only 30% of the ISH (27 households) have a car and only 1% of the ISH have a tractor. One third of the ISH have a horse carriage. The share of the ISH that have their own machinery varies from 30% to 46%. The fact that only one third of the ISH have their own equipment strengthens the assumption of their dependency on employment in large agricultural enterprises.

Nevertheless, the labour productivity of ISH is higher than the average of Zhytomyr Oblast and the Ukraine's LAE (see Table 3).

Table 3: ISH, Oblast Zhytomyr and Ukrainian LAE Labour Productivity

	ISH	Oblast Zhytomyr LAE	LAE of Ukraine
Labour Productivity, in UAH per Worker¹	3,337	2,551	3,171
Input on Labour per 1,000 UAH of Gross Income	207	449	290

Sources: Own presentation based on NEDOBOROVSKYY (2000); SABLUK et al. (2001); DEPARTMENT OF AGRICULTURE (1999); MINISTRY OF AGRICULTURAL POLICY OF UKRAINE (1999); own calculations.

¹ Calculated as (Gross Income – Production Costs)/ workers.

Household capacity for cattle and sows is completely used. On the other hand, only 87.5% of the available capacity for pigs is used. That leads to the conclusion that the ISH still has the opportunity to increase pork production in the short-term under favourable market conditions.

Current data of crop and livestock yields gained in the ISH and the LAE in Zhytomyr Oblast are shown in Table 4.

Table 4: Crop and Livestock Productivity Indicators in ISH and Large Agricultural Enterprises of Zhytomyr Oblast

	Min.	Max.	Median	Average of Large Agricultural Enterprises for Oblast Zhytomyr, 1999
Milk Yield, kg per Cow	1,169	6,375	3,488	1,387
Cattle's Weight Gain, Gram per Day	200	700	390	232
Pig's Weight Gain, Gram per Day	100	600	421	120
Egg Yield	90	345	242	N/A.
Crop Yield: Grain, 100 kg	5	80	21	18
Potatoes, 100 kg	18	360	89	53
Sugar Beet, 100 kg	30	857	260	162
Vegetables, 100 kg	16	750	200	87

Sources: Own presentation based on NEDOBOROVSKYY (2000); DEPARTMENT OF AGRICULTURE (2000).

Table 4 shows that the average yields of the ISH are much higher than in the LAE. One possible explanation is that (1) the ISH use cheap inputs (especially compound animal feed) from the LAE, while thus decreasing the productivity of large agricultural enterprises. (2) livestock products such as milk, milk products, eggs, pork, and beef are an important income source due to the sale on market. As the increase of yields directly improves households' welfare, ISH have high motivation to properly manage their enterprise, which may not be for the case in the large collective farms. (3) ISH seem to specialise in production systems which are not subject to economies of scale. Rather, they run labour intensive systems that cannot be easily mechanised. This can also be shown for grain production where economies of scale can be exploited through mechanisation, and thus the gap between ISH and LAE is smaller.

Additionally, it is interesting to consider the main sources of inputs and their prices (calculated as the actual wage-in-kind² from the large agricultural enterprises) (see Tables 5 and 6).

² The interviewed households did not receive wages in cash for many months. The only type of payment they received was so-called "wage-in-kind".

Table 5: Structure of Input Sources, in percent

	Market	Agricultural Enterprise	Middleman	State	Private Individuals	Own Production
Fattened Calf	2	20			7	71
Young Pigs	33	52				15
Growers	4				4	92
Potato Seeds	2				6	92
Grain Seeds	4	33			2	61
Vegetable Seeds	92	2			2	4
Grass Seeds	17	83				
Fertiliser	2	57				41
Plant Protection Products	93	7				
Fuel			93	7		
Compound Feed	9	82			9	
Feed Grain	7	89			2	2
Other Feed	9	69		9	13	
Insemination Services		97		3		
Veterinary Services		18		77	5	

Source: Own presentation based on NEDOBOROVSKYY (2000).

The main input sources are set in bold in Table 5. The table clarifies that the main input sources of the ISH are own production. These inputs are free of charge and as they are own-produced, opportunity costs of the ISH are lower than when buying them from enterprises or the market. The other source are the LAE themselves, especially concerning compound feed – 82% (of the total input purchase), feed grain – 89% and other feed – 69% that is purchased not at the market price, but under the production cost level. Inputs from this source were acquired as a wage-in-kind or free of charge (stolen) from the LAE. Vegetable seeds and products, as well as fuel, are purchased mainly on the markets or from intermediaries for cash, as there are still no alternatives for these input sources.

Table 6 shows that average prices for compound feed and feed grain offered by large enterprises are much lower than the respective market prices. This observation offers two conclusions, both supporting the hypothesis stated at the beginning of the paper: first, relatively high livestock productivity in the ISH in comparison to the LAE (due to extreme low feeding costs, comp. Table 5), and secondly, the high dependency of ISH members on employment in the LAE. Overpricing of sugar, butter, and vegetable oil is explained by the 'institutional force' over most households: either accept more expensive products as a wage-in-kind payment or receive no wages at all. By using barter as a means of commercial transactions, the LAE receive processed products from processing plants as an exchange for production inputs (sugar beet, milk, sunflower seeds) and transfer these products to their employees, thereby devaluating their real wages.

Table 6: ISH Purchase Prices, in percent of the Market Prices

	Minimum	Maximum	Average
Grain	0,3	143	79
Compound Feed	0,01 ³	70	23
Milk	66	120	105
Meat	75	125	91
Vegetable Oil	82	82	82
Butter⁴	120	120	120
Sugar	71	132	105

Source: Own presentation based on NEDOBOROVSKYY (2000).

3.3 Efficiency of Individual Subsidiary Holdings in the Ukraine

Table 7 presents data that strengthen the hypothesis. It was not possible to calculate the rate of farm profitability for ISH applying the methodology commonly used in the Ukraine (Profit*100/Total Costs), because of the absence of some data such as labour input costs, own consumption of the ISH and their repayments. Instead, only revenues from sale and production costs were compared in order to test the hypothetical response of ISH on the price rise and to define, based on current economic conditions, whether the ISH could represent an alternative production form to the LAE. Therefore, it must be assumed that the amount of own-consumed products (which are not sold on markets) is higher than zero. To calculate the figures presented in Table 7, the production inputs used by the ISH were valued twice: on the one hand, using the actual purchase prices and on the other hand, the average market prices. In our study we only considered the constant market prices, because the continuously changing prices could induce an adjusting reaction of the ISH, which is difficult to predict.

Differences between revenues from sales and production costs are shown in Table 7. The data used in this table stress that only in cases where ISH are purchasing from LAE do the sales value outperform production costs. Otherwise, the costs of inputs at market prices exceed the revenues from sales by 11%.

³ See explanations in the text.

⁴ Max. and min. prices are equal because data were received from only one large agricultural enterprise.

Table 7: Production Costs Versus Revenues from Sales⁵

	Average
1. Revenues form Sales, UAH	228,581
2. Costs of Inputs, UAH	82,822
3. Costs of Inputs at Market Prices, UAH	253,588
4. Costs of Inputs /Revenues from Sales*100, in percent	36
5. Costs of Inputs at Market Prices /Revenue from Sales*100, in percent	111

Source: Own presentation based on NEDOBOROVSKYY (2000).

But not all of the households demonstrate a low level of cost/revenue relation. To prove this statement the cash flow revenue rate (CFRR) ((Revenue from Sales – Variable Costs)/Variable Costs*100) was calculated. In this case, the difference between households at the actual input prices is presented in Figure 3.

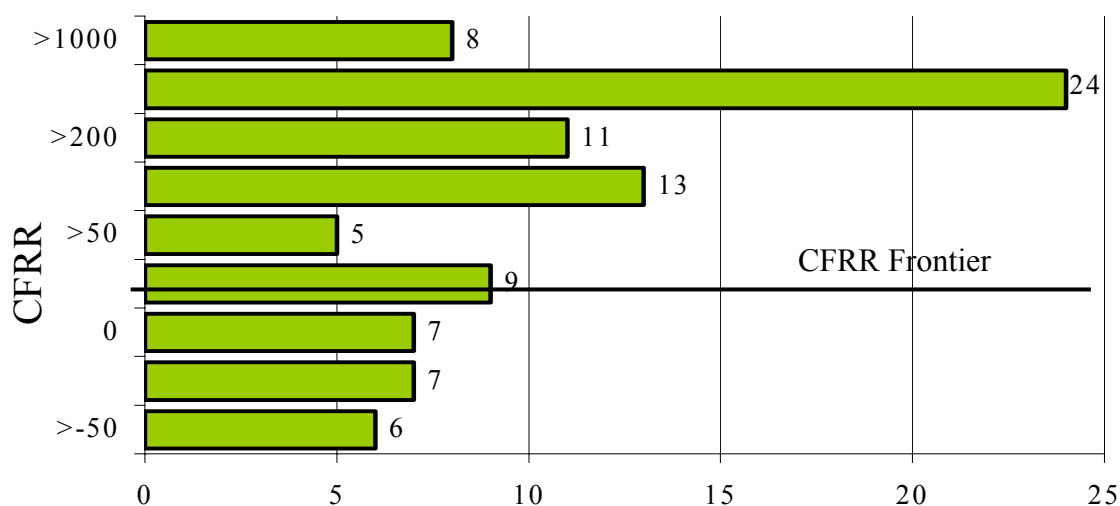
Figure 3: Cash Flow Revenue Rate at the Actual Input Prices Dispersion

Source: Own presentation based on NEDOBOROVSKYY (2000).

Figure 3 shows that most of the ISH are located significantly above the calculated cash flow revenue rate frontier. Thus, one could conclude that the ISH work exclusively efficiently. But if the inputs used in the ISH operations are estimated at market prices the picture changes entirely. Two thirds of the ISH move to the negative side (see Figure 8). The initial "positive" cash flow revenue rate, thus proved to be illusory in most cases.

⁵ These are the sum of revenues and costs according to all 90 households of the sample.

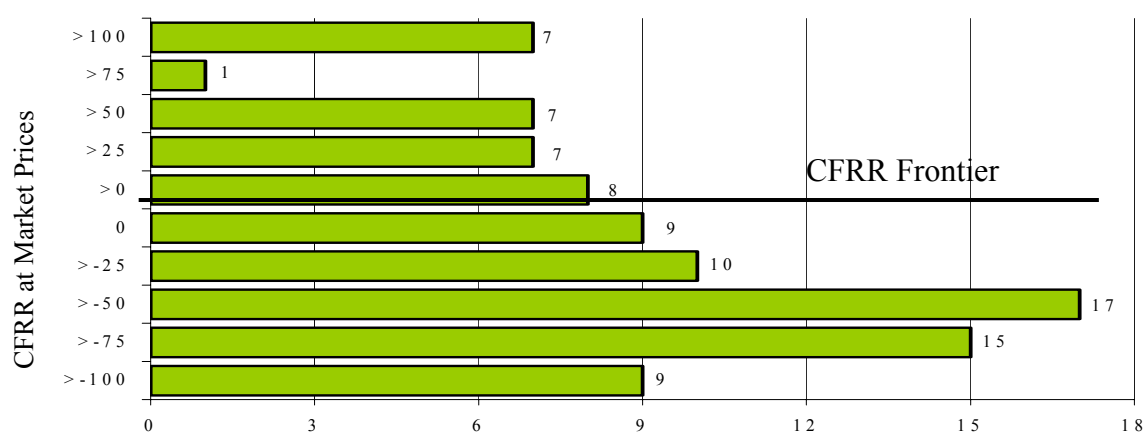
Figure 4: Cash Flow Revenue Rate at Market Prices Dispersion

Source: Own presentation based on NEDOBOROVSKYY (2000).

This means that when purchasing their inputs on markets instead of taking them from LAE, only those ISH which are above the cash flow revenue rate frontier (see Figure 4) could operate under market conditions. The other ISH mainly depend on employment at LAE. In future, in the case of increasing input prices, lower on-farm production of inputs (compounded feed, grain) and the improvement of control-management in LAE, the output production in the ISH could significantly dwindle, although exact forecasts are difficult. It may be expected, as far as there are no income alternatives and employment possibilities in rural areas, the ISH will specialise in labour-intensive production such as animal keeping and vegetable production.

4 CONCLUSIONS

The conclusions can be summarised as follows:

- The ISH are the most important source of agricultural products for the rural population.
- The large amount of labour employed by the ISH points to the high hidden unemployment in LAE.
- Household income depends on the income of the ISH up to 100%. Currently, the ISH are the most important (and to a large extent the only) source of cash income in rural areas.
- The efficiency of ISH is strongly affected by employment in LAE. These enterprises act as a source of low-cost inputs for the ISH.
- Over 66% of the households prove a low cash flow revenue rate when calculated under market conditions.

REFERENCES

- DEPARTMENT OF AGRICULTURE (1999): Zhytomyr Oblast Annual Farm Accounting Report, State Zhytomyr Oblast Administration.
- MINISTRY OF AGRICULTURAL POLICY OF UKRAINE: Annual Aggregated Accounting Reports of the Public Farms in Ukraine, different issues.
- NEDOBOROVSKYY, A. (2000): Questionnaires for Members of the Agricultural Enterprises in the Ukraine, IAMO, Halle (Saale), (unpublished).
- STATE STATISTICAL COMMITTEE OF THE UKRAINE (1999): Agricultural Yearbook, Kyiv.
- SABLUK, P., MESSEL-VESELYAK, V., LUSAN, V. (2001): Efficiency of Agricultural Production in ISH, Institute of Agricultural Economics, Kyiv, p. 357.
- STRIEWE, L., VON CRAMON-TAUBADEL, S., SIRIN, K. (2001): Financing Problems in Ukrainian Agriculture: Diagnosis and Possible Solutions, in: BOSTYN, F., BOYTSUN, A. (eds.): Agricultural Reform in Ukraine, *ICPS Policy Studies, No. 15*, Kyiv, (January), pp. 25-39.

MODELING SUBSISTENCE AGRICULTURE IN RUSSIA: EFFECTS OF TOTAL PRODUCTIVITY CHANGES AND REDUCTION OF MARKETING MARGINS

PETER WEHRHEIM, PETER WOBST¹

1 THE CHANGING ROLE OF SMALL-SCALE AGRICULTURE IN RUSSIA'S TRANSITION PROCESS

The transition process in Russia, which started vigorously at the beginning of the 1990s, has yielded negative economic growth rates for almost a decade, with the exceptions of 1997 and 1999. Agriculture and domestic food industries in particular have suffered from the ongoing transition process and the associated restructuring of the economy. During the first transition decade the share of agriculture in Gross Domestic Product (GDP) declined from more than 16% in 1990 to about 7% in 1998. Structural and institutional changes have significantly altered the performance of Russia's agriculture in the past and will continue to do so in the years to come. In the 1990s, for instance, the economic performance of the former *kolkhozi* and *sovkhozi*, the former collective and large-scale farms, deteriorated significantly. In fact, only 'soft budget constraints' exercised by regional administrations kept many of the large-scale crop and livestock farms alive at the end to the 1990s. Parallel to the decline of the large-scale sector, a shift in agricultural production has taken place towards private subsidiary plots (in Russian they are called *Lichnie Podsobnie Khozyaistva* (LPH)), the subsistence-oriented production units of the rural populace. By 1998, about half of Russia's agricultural production was produced by this sector.

Output contraction in the domestic agro-food sectors stabilized or even stopped in 1997 but continued in most sectors in 1998 due to the financial crisis. The devaluation of the ruble following the crisis in mid-1998 opened a 'window of

¹ Research fellows at the Centre for Development Research (ZEF), University of Bonn, and International Food Policy Research Institute (IFPRI), Washington, D.C., respectively. WEHRHEIM acknowledges financial support for the project by the Volkswagen-Foundation, Germany. Thanks are due to an anonymous referee for helpful comments.

opportunity' by increasing the competitiveness of domestic industries (SEROVA et al. 1999). In fact, the degree of import substitution following the devaluation was greatest in industries that produce consumer goods and was particularly true for food products.

However, despite the fact that a major share of today's gross agricultural output is produced on private subsidiary plots, agricultural policy makers in Russia tended to understate the relevance of household production for income generation and food consumption in the late 1990s (VON BRAUN and QAIM 1999). Agricultural policy in Russia resisted enhancing the production possibilities of this sector through state interventions. However, in June 1999, the GOVERNMENT OF RUSSIAN FEDERATION (2000) acknowledged the importance of the small-scale sector by discussing potential steps to stimulate the commercialization of this sector.

Against the background of the increased relative importance of subsistence agriculture in Russia with respect to production, consumption, and its improved recognition by policy makers, it is of interest to include this sector into quantitative policy analysis. Specifically, we are interested in how exogenous shocks like the financial crisis and the concomitant real devaluation have affected the economic situation of large-scale and subsistence agriculture. By addressing this question we will also discuss the specific relationship between subsistence agriculture and the formal economy. Ever since GADDY and ICKES (1999) presented a formal, theoretical model of the virtual economy in Russia, this issue has been much debated. While we do not attempt to model the whole virtual economy in our model, we specifically focus on the inclusion of subsistence agriculture into a formal and applied model of the Russian economy. The objective is to address the effects of the poor commercialization of subsistence agriculture in Russia within the logic of such an economy-wide modeling framework. We intend to look at the effects of past economic events and forward-looking economic events on subsistence agriculture. We will discuss these questions within an applied Computable General Equilibrium (CGE) model, specified for 1994.

The structure of the paper is as follows: Chapter 2 provides a non-technical description of the modeling framework. In particular, those features of the model will be stressed which turn it into a structural CGE model that allows unemployment to occur. Chapter 3 discusses the data base and puts emphasis on the steps involved in the compilation of the data for the various agricultural sectors and how the distinctive features of the various types of agricultural producers are reflected in the data base. Chapter 4 presents the results of four sequential and path-dependent simulations. We combine an improvement in total factor productivity in agriculture, a devaluation of the exchange rate, and a reduction in various marketing margins reflecting institutional change and

reductions of transaction costs. In Chapter 5 we discuss the policy and research conclusions that can be drawn from the results obtained.

2 NON-TECHNICAL DISCUSSION OF THE MODELING APPROACH

2.1 The Core Elements of the Model: Producers, Consumers, the Government, and Prices

The CGE-model for Russia is developed along the lines of models as described in DEVARAJAN et al. (1994). To reflect some of the features characteristic for the Russian economy in transition, we have modified the standard model by reducing the full mobility of all economic resources such that it represents a structural rather than a neoclassical model economy. The most essential features of the model follow.

2.1.1 Supply Side

Producers minimize their costs under the conditions of a neoclassical production function (see Figure A-1). All intermediates are used according to sectorally specified and fixed Input Output Coefficients (IOC) for each unit of output; due to that the empirical determination of the IOC from the IO table is essential. Substitution between different types of labor and capital is specified with a Constant Elasticity of Substitution (CES) function. Value-added prices are determined as the difference between unit sectoral revenues and unit costs for intermediates. Furthermore, it is assumed that producers maximize their revenues from domestic sales and exports under the restriction of a Constant Elasticity of Transformation (CET) function.

2.1.2 Demand Side

The commodity markets are specified as CES functions that allow for substitution between imported and domestic products to form composite goods (see Figure A-1). Domestic prices for imported commodities are determined by respective world market prices, the exchange rate and tariffs. The model assumes a perfectly elastic import supply (small country assumption). Consumer prices are the weighted average of domestic product and import prices. Consumers maximize their utility over the composite good of each sector under the restriction of a budget constraint. Own-household consumption and marketed household demand for all goods is determined through a Linear Expenditure System (LES) using fixed minimum expenditure quantities and fixed marginal expenditure shares.²

² The model does not allow for direct substitution between own-household consumption and marketed consumption. However, depending on relative producer and consumer prices at which the two consumption categories are valued respectively, their relative quantities shift towards the more favorable category.

2.1.3 Government

Government receives revenues from import tariffs, export taxes, and indirect production taxes, as well as direct income taxes. Government demand is determined using fixed shares of aggregate real spending, respectively; the budget surplus is defined as the difference between revenues and government demand for goods.

2.1.4 Prices

World market prices are exogenous and domestic import and export prices depend on world market prices, tariff and export tax rates, as well as the exchange rate; prices for the composite demand and output goods are determined by the weighted prices for imports and domestic goods and for exports and products for the domestic market. Changes in relative prices and substitution possibilities determine supply, demand and trade. If relative prices change because the model is shocked, substitution can take place between factors of production, export supply and domestic supply, imports and domestically produced imperfect substitutes, and different commodities in demand. Export demand is price elastic, which is particularly important for Russia's energy exports. Export prices depend on the fob-price in foreign currency (USD), the export subsidy and the exchange rate. All prices in the model are determined as relative prices and no monetary market is explicitly modeled. Out of n prices in each sector (e.g., import price, producer price, etc.) $n-1$ prices are linear dependent from other prices. Hence, prices have to be defined in relation to some exogenously determined price. Generally, any price can be used as an exogenously predetermined numeraire. Here, the domestic sales price index is kept constant and used as the numeraire.

2.2 Structuralist Features of the Model

2.2.1 Factor Market Closures

The Russian economy in transition reveals several structural rigidities which would not be taken into account in a purely neoclassical CGE model. Therefore, we modified the modeling framework by changing the degree of mobility of primary factors. Labor and capital are the primary factors – land is part of capital in the agricultural sectors. On the one hand, sectoral capital stocks are held constant, reflecting the relatively weak intersectoral mobility of capital during the transition period. The capital stock of agriculture used in the pre-transition period, for instance, could not be transferred from large-scale to small-scale agriculture. On the other hand, we allow for unemployment in labor markets. Nominal wage rates are fixed and excess supply of labor permits to hire (release) labor if the profitability in a sector increases (decreases). Hence, total

employment is determined by demand, instead of being determined exogenously as it is the case in the neoclassical fixed (full) employment specification.

2.2.2 Closure Rules

The model is completed by supply-demand balances for commodities, factors and foreign exchange, the government budget constraint and the savings-investments identity. The commodity markets are cleared if total (domestically and imported) supply equals demand. The equilibrium variables are sectoral prices. Domestic demand comprises household and government demand, intermediate demand, as well as investment demand. With a perfectly elastic supply of labor at given nominal wages, total employment is determined endogenously by labor demand. Government consumption and investment demand are fixed shares of total absorption, which implies that final household demand is a fixed share of absorption as well. This so-called "balanced" closure is particularly desirable for the kind of analysis conducted here for the following reason: private, government, and investment demand are forced to share the economic burden (change in total absorption) of the imposed policy shock. Consequently, this helps to avoid extreme behavior, for example, that total household demand decreases, while government spending increases. To keep the savings-investments identity balanced the marginal propensity to save of nongovernmental domestic institutions (enterprises and households) adjust proportionately. Finally, the trade balance has been kept constant reflecting Russia's limited access to foreign capital. In our base closure specification, we have a flexible exchange rate that adjusts in order to keep the current account balance/trade balance fixed. However, depending on the experiment design this closure can be changed to represent a fixed exchange rate model with adjusting foreign trade balance.

3 THE DATA BASE OF THE MODEL

3.1 Major Differences in the Data Base in Comparison to Older Model Versions

The data base of the model is based on a consistent data set for 1994. It is an update of an earlier version of the model in which Input-Output-Coefficients (IOC) were calculated based on an Input-Output-Table (IOT) from 1990, while the data for the macro-economic totals referred to 1994 (WEHRHEIM 2000). In comparison to the earlier version of the model, a second major change is the fact that the agricultural sector has been disaggregated. In the data set used for previous model simulations, 17 sectors were distinguished, among them only one agricultural sector. In our data base we distinguish a total number of 20 sectors, among them four different agricultural sectors, or, more specifically, two small-scale sectors and two large-scale agricultural sectors. Furthermore,

this model is different from older applications by making an explicit distinction between the sectoral 'commodity' and 'activity' accounts. While the activity account can be perceived as an account for the 'production unit' of the respective sector, the commodity account can be perceived as the 'market place' through which the output of the respective sector is channeled from the producer to consumption. Hence, this feature allows to model one important behavioral peculiarity of the subsistence sector: the commodity produced in the small-scale agricultural sector and consumed by households does not reach the market, represented by the commodity account, but households directly 'buy' the commodity. In our model they get it directly from the activity account. Thus, no marketing wedge comes between the activity and the consumption location in the case of the good produced by the subsistence-oriented, small-scale agricultural sector, which, therefore, can be consumed directly by households.

3.2 Overview of the Structure of the Economy

Tables A-1 to A-3 (see Appendix of the paper) provide a snapshot of the structure of the Russian economy in the base period of the model. Table A-1 shows the share of the individual sectors in GDP at factors costs, in total national production, the sectoral share in the total labor force, and in the total capital stock available in the economy. The distribution of GDP and of total production indicates the high importance of the two service sectors. Second most important is the construction sector, followed only in fourth place by the fuel industry, which represents the raw energy-extracting sector. The four agricultural sectors together contribute only a share of about 10% to GDP and an even lower share to total domestic production (8%).

The distribution of the labor force among the different sectors of the economy follows a similar pattern. The two service sectors together employ roughly 50% of the total Russian labor force and slightly less than 40% of total capital available in the economy. The construction sector is also still very labor-intensive and employs about 18% of the national labor force. While the figures indicate that the industrial sectors have relatively low labor intensities, the capital share employed by the fuel industry reveals a high demand for capital-intensive equipment needed by this sector. The primary agricultural sectors together employ a share of about 8% of the national labor force and about 11% of the capital available in the economy.

Table A-2 reveals the trade structure and the structure of total absorption in our model. A first view indicates that there are some non-tradable sectors in the Russian economy. The construction sector imports but does not export. The service sector, the animal feed sector, and the two small-scale agricultural sectors are pure non-tradable sectors. This is relevant because in a comparative static model a switch from a non-trade to a traded sector cannot occur.

With more than 40% of total exports, the fuel industry was Russia's major exporting sector in 1994. In fact, this sector was responsible for most of the current account surplus of the Russian Federation in the 1990s. The food industries and agriculture together contributed only 4%, and hence only a minor share of total national exports. The reverse holds true for imports, even though these are generally more evenly spread over various sectors. The total share of imports in agriculture and the food industries was, with almost 40% of total imports, very high and reflects the high import dependence of these sectors in the transition period.

The spread of absorption over all sectors is even more distinct. However, the figures in Table A-2 indicate that the two service sectors, the construction sector, and all industrial sectors have higher shares in total absorption than any single agro-food sector. Hence, the total share of all agro-food sectors is only 17%.

Table A-3 reveals some additional structural features of each sector. The second and third columns show the share of labor and capital in total use of primary production factors, respectively. The fourth column indicates the share of intermediates in the total production costs of each sector. The labor share is relatively low in the raw material industries, while it is highest in the construction sector. It is also very high in the service sector and in the large-scale livestock sector. A surprisingly low share of labor is revealed for the agricultural subsistence-sector (Agri-LPH), with only 23%. In contrast, this sector uses a very high share of capital, which reflects the fact that the economic rent extracted from this sector are profits rather than formal wage payments. Furthermore, it is worth mentioning that the capital share is above average in all food industries, indicating that these sectors need substantial capital to produce the sectoral good. At the same time, the food industries are very dependent on intermediates from other sectors; the share of intermediates used is above average in each food industry.

The production elasticities are shown in the fifth column of Table A-3. They are synthetic in as far as they were not estimated empirically, but instead are based on values used in other studies for comparable countries. They are lowest in the raw material producing industries and highest in the machinery, light manufacturing industry and in the construction sector. An average value of 1.2 has been chosen for all other sectors.

Finally, the last three columns of Table A-3 show the sector-specific marketing margin coefficients. Similarly to the production elasticities, these coefficients were not estimated empirically. In contrast to the production elasticities, they were not based on other studies but are estimates based on our background knowledge of the country. Again, more precise empirical information on the respective values is missing; therefore they are open to discussion – more so than any other parts of the data.

These margins effectively drive a wedge between the producer price and the price of either the good which is exported or sold domestically, or in the case of imports, a wedge between the cif-import price and the domestic consumer price. They directly relate to the good which in previous model versions was provided as a homogenous good from the 'trade and transport' no matter what kind of transactions were involved (*cf.* WEHRHEIM 2000).

We now differentiate between marketing activities on domestic markets, import, and export markets. Because of the size of the domestic market, about 80% of the value of the goods in previous model versions were allocated to domestic trade activities. Therefore, depending on the relative weight we attributed to the specific marketing components, sectorally different coefficients were obtained (Table A-3).³ For instance, the coefficient for imports in the food industries and in agriculture is much lower than the one for the domestic good in the same sector, which effectively discriminates against domestically produced commodities. This distinction was chosen because of the observation that institutional impediments hinder the marketing of domestic food products while it has been much easier for importers to ship imported food commodities to the most peripheral consumers within Russia. Hence, these margins can also be interpreted as transaction costs. Another interesting stylized fact that can be incorporated into the model with this mechanism is the impediments to commercialization of the small-scale agricultural sectors. Both sectors are discriminated against with the highest domestic marketing margin (of 0.39) when marketing their sectoral output to the domestic markets.

3.3 Disaggregation of Agriculture into Large-scale and Small-scale Sectors

As mentioned above, the empirical representation of the agricultural sector in the current version of the Russian model was adjusted in comparison to older versions of the model to more realistically represent the subsistence sector in the data base for 1994. Therefore, we distinguish four agricultural sectors in the 1994 model version. This is still much lower compared to other CGE country studies which focus on agriculture, but it is restricted by the limited availability of data for the various sub-sectors of Russian agriculture.⁴

To better address the issues linked with self-subsistence agriculture in Russia, the agricultural sector has not been disaggregated by products but according to farm types. More specifically, the following four sectors are represented in the model: one crop and one livestock sector, each representing the Large Agricultural Enterprises (LAE) and, hence, the former collective farms. The LAE were highly specialized during the era of central planning and in most

³ Here we follow an approach which WOBST (2000) has also applied to a CGE-model for Tanzania.

⁴ WOBST (1998) presented a micro-SAM for Tanzania in which 21 out of 56 sectors belonged to agriculture. Such a high level of disaggregation is useful if the underlying data set reveals sufficient variation between the different sectors specified.

cases continued to produce either livestock or crop products during the transition period. Additionally, we represent the two other types of agricultural producers that have become relevant in the transition period: the household sector and privatized farms. In the following, we will elaborate on how we arrived at the specific representation of these four sectors in our model.

We started out with the data that represented the aggregate sector 'agriculture' in the 1990 version of the model. The respective IO coefficients were calculated with the data from a 1990 IO table. The IO coefficients for the agricultural sector were split into the four above-mentioned agricultural sub-sectors according to their shares in total agricultural output in 1994, as reported by Goskomstat. While large-scale agricultural enterprises produced approximately 80% of total agricultural output in 1990, this share dropped to about 53% in 1994 (GOSKOMSTAT 1999b). By 1994, the subsistence-oriented small-scale producers, mostly referred to as household plots or private subsidiary plots (LPH), produced another major share of agricultural output (approximately 44%). The total number of such small-scale agricultural producers in Russia was 16.5 million in 1994 (GOSKOMSTAT 1999b, p. 217).

Additionally, most urban households maintain a private individual family garden on the outskirts of the cities, the well-known *datchas*, where substantial amounts of food are produced. Nevertheless, Goskomstat does not consider this production when calculating total agricultural output, as production from these private gardens is used purely for the self-subsistence of urban families. According to official GOSKOMSTAT (1999b, p. 217) estimates, the total number of such family gardens in 1994 was about 22.4 million. In fact, the number of households running small-scale plots varies significantly across regions in Russia and across towns of different sizes. In a household survey of three Russian *oblasts* (Orel, Pskov, and Rostov), the share of households with access to a private garden in the capital of the region was much lower (77, 36, and 30%, respectively) than in other urban dwellings in the region (87, 58, and 54%). In rural areas, almost all households had either access to a household plot or a private garden in all three regions (99, 97, and 100%) (SEETH 1997, p. 140).

A third type of relevant agricultural producers in Russia emerged from reforms in the early transition period: the fully privatized and newly created private farms, 270,000 of which were operating mostly as family farms in 1994 (GOSKOMSTAT 1999a).⁵ In the IO table, its share in total national output reached less than 1%. In fact, after 1994 the number of private farms stagnated, which meant that the officially reported share of private farms in gross agricultural

⁵ The restructuring of Russia's farm sector has received much attention and is discussed in various publications. Background information on the early pattern of agricultural restructuring can be found, for instance, in BROOKS and LERMAN (1994).

output also remained at about the same level it had already reached in 1994 (3%).

3.4 Specific Features of Subsistence Agriculture in the Data Base of the Model

After splitting up the original input-output quantities between the four agricultural sectors, they had to be adapted to the situation in 1994. The underlying data is again synthetic in that it originates from various primary and secondary data sources and was adapted to make it economically consistent. The input-output structures of the two sectors representing the large agricultural enterprises relate closely to those presented in the IO table for 1990. While the absolute value of expenditures for single intermediates was reduced in proportion to the decline in output of the LAE, the structure of the IOC remained more or less constant.

The definition of input-output relations for the two small-scale sectors has been driven by the following observations. The small-scale subsistence or the LPH sector is not only typical for Russia but also for other CIS countries such as the Ukraine. AMELINA (2000) showed that in Russia overt and covert benefits explain why Russian peasants remain in collective farms. KOESTER and STRIEWE (1999) argue that LPH producers in the Ukraine are actually 'cross-subsidized' because they obtain industrial and on-farm inputs from the collective farms in substantial amounts. For Russia, this close link has been confirmed with case-study surveys of LPH producers in three Russian *oblasts* (Pskov, Orel, and Rostov). In fact, the close link between the private subsidiary plots and the large agricultural enterprises is one of the most distinct features of Russian agriculture in the transition period. A stylized representation has been used to indicate the input-output-relations between the four farm types, departing from the revealed input-output structure in the IO table for 1990: both sectors representing the LAE make significant payments to the LPH sector. For crop-producing LAE, these expenditures make up 6.6% of the sector's total production costs, while these transfers amount to almost 10% in the case of an LAE specialized in livestock production. The idea is to represent one obvious feature of Russia's rural economy in transition in the data base: while the LAE crop producers make payments in kind to their associated private subsidiary plots by leasing machines, transferring fertilizer and seeds, the LAE livestock producers are using feed as one major form of payment in kind to reimburse their workers for foregone cash income. These expenditures are a burden on the LAE and are likely to contribute to the high share of unprofitable LAE. Such expenditures are normally based on informal contracts between the two parties: the recipients are in many cases both workers and members of the LAE, many of which have 're-registered' as cooperatives. While average wages for agricultural workers are among the lowest compared to all other sectors in the Russian economy, LAE

use payments in kind to their workers as compensation. It is this inter-relationship that is represented with the respective IOC.

There are a few other distinct features of the four agricultural sectors in the Russian model that have been taken into account in the compilation of the individual sectors' IOC. In general, the share of intermediates is much higher in the two sectors representing the LAE. This reveals the fact that these enterprises are more market-oriented, also with respect to inputs, at least when compared to the small-scale producers in the household sector and the private farms, which often suffer from insufficient access to input-markets due to various market imperfections (e.g., for the Ukraine: PERROTTA 1999). At only 20%, the share of intermediates in total production costs is the lowest in the LPH sector. In addition, about half of the intermediate inputs (10.9% of total production costs) used in this sector's production process stem from the sector itself. This high dependence on inputs produced within the same sector reveals the fact that this sector is to a considerable extent a self-subsistence sector and hardly relies on commercial inputs, for which the household plot owners would need to pay with cash they do not have. In contrast, there are at least some private farms that attempted early on in the transition period to improve their efficiency by buying inputs and new machines from the market. This is indicated with the respective values of the IOC of the private farm sector for inputs originating from the chemicals industry, light manufacturing, and mechanical engineering sectors as well as from the power industry. In addition to the distinct sectoral input relationships of these four agricultural production sectors, they also use rather different marketing channels for selling their product. The sugar industry receives 45% of its raw materials, in monetary terms, from the LAE crop sector. The meat processing industry buys substantial amounts of the raw materials it processes from the LAE livestock sector (amounting to 36% of its expenditures for intermediates). The share of inputs the meat processing industry is able to collect from the household plot sector makes up only 6% of the sector's total expenditures for intermediates, despite the fact that this sector represents more than 40% of total agricultural output in the model's data base and in fact produces substantial shares not only of crop but also of livestock products.

Summing up, the agricultural sector in the Russian model is represented by four types of producers, each of which has a characteristic production structure and/or typical levels of market orientation with respect to both inputs and outputs. While we differentiate between two small-scale agricultural sectors, we refer to the LPH-sector as being the only sector that is predominantly a subsistence-oriented sector. The forward and backward linkages of this sector reveal the lowest degree of commercialization of this sector compared with all other primary agricultural sectors.

3.5 Household Demand

Macroeconomic reforms in the transition process have had substantial microeconomic repercussions. Liberalization of prices and trade, for instance, resulted in a significant restructuring in the composition of household demand. Additionally, high inflation and declining real wages induced a restructuring of expenditure patterns. One of the most distinct features is the increase in the average share of total expenditures Russian households spend on food. The data in the IO table for 1990 shows a share of approximately 37% of total household expenditures spent on food. Data from the household survey carried out in three Russian oblasts in 1995 indicates that the average Russian household's share of food expenditure increased significantly in the transition period (*cf.* VON BRAUN and QAIM 1999). Taking into consideration market demand for food products only, the share of household expenditures for food averaged about 56%. If subsistence production is taken into consideration, this share increases to almost 80%. Official Russian statistics indicate for 1995 (1996) a share of 49% (47%) of total expenditures spent on food (GOSKOMSTAT 1998).

Therefore, household demand had to be updated to more realistically represent households' behavior in the model. The structure of private consumption was adjusted to the revealed expenditure shares for market demand only as they were obtained from the household survey. However, in some cases this data cannot be considered fully representative for Russia as a whole.

The share of expenditures for food in the 1994 IO table is significantly higher as compared to the respective share in the IO table for 1990 (51.1% versus 36.8%). It still seems to be rather low if it is compared to the respective expenditure share that has been calculated from the household survey. However, it has to be borne in mind that it is very difficult to take subsistence production in Russia and, hence, one part of the 'virtual economy' with all the associated difficulties of evaluating non-monetary transactions, fully into account in the model's data base. A second feature of household expenditures in the 1994 IO table is the major share of food households 'buy' from small-scale and, hence, from subsistence agriculture. In our model a share of 10.5% of total household expenditures and thereby a share of 20% of total expenditures used for the purchase of food products stems from the LPH sector.

Furthermore, because of the distinction we made between activities and commodities, households have two choices for where to get agricultural commodities from: Households can consume the good from formal markets (i.e. 'marketed household consumption') or they can consume the good from subsistence production (i.e., 'own-household consumption') and hence, from the activity account directly.

3.6 Consistency Tests of the Model

The complex structure of the model means that inconsistencies cannot be excluded a priori when the model is calibrated and solved. Hence, it seems to be a requirement to carry out various tests with such models. A test for homogeneity can be a simple but powerful device, as it quickly reveals whether the theoretical and empirical parts of the model are consistent. This test is a first simulation with the model in which the central price index, in our case the GDP deflator, is – ceteris paribus – altered exogenously. Here, it was raised by 10%. The underlying concept of homogeneity implies that all real variables are homogenous to the degree 0 with respect to price changes. Additionally, it has to be expected that all endogenous prices are changing to the same extent, while relative prices do not change. Indeed, the solution of this experiment yielded changes in all prices and nominal variables by 10%. All real and all exogenously determined variables (depending on closure rules, for instance factor supply, total government demand, etc.) remained constant.

Another essential check for theoretical and empirical consistency of the model is to ensure that the model is "square". "Theoretical squareness" refers to Walras' law, which stipulates that the number of equations in the model is the same as the number of variables.

Furthermore, sensitivity tests are commonly carried out to test whether the model is sensitive to changes in the base run of the model. Therefore, sensitivity tests can generally consist of two different alterations: either changes in the data base or changes in the economic features of the model. We restricted our sensitivity tests to one commonly used option: changing the value of trade parameters. The sensitivity tests showed that the model responds adequately to changes in the value of trade elasticities (CES and CET). Furthermore, the sensitivity tests indicated that the higher the elasticity values, the higher is the degree of restructuring that follows exogenous shocks.

Finally, validity tests are based on the question as to what extent the model can actually replicate the economy-wide effects of real world developments ex post. The underlying idea is to ask whether the model is able to replicate ex post economic developments that were observed in the past as a result of external shocks. For instance, we will expose the model exogenously to some shocks that have occurred in the 1990s and contributed to structural changes in Russia's agricultural sector. We will then ask how realistic the model responses are and if these responses comply with real world developments.

The model is comparative static; parameters such as trade elasticities are set exogenously low. Therefore, and because of the specific factor market and closure rules which determine the key behavior of the model, the results should be interpreted as reflecting short run responses, which is another feature typical for a structural modeling framework.

4 SIMULATION RESULTS

4.1 Experiment Design

With the model discussed above, we are now in a position to carry out various simulations addressing some of the economic changes which have been observed in the course of Russia's transition process. We simulated three types of rather different economic changes which together affected the economic situation of both large-scale and subsistence agriculture in the 1990s. The transition process did not take place in a planned manner and, consequently, the sequencing of reforms and related economic events was sub-optimal. We attempt to replicate some of the most influential economic developments, which have had an effect on the various agricultural sectors in the past decade and combine these backward-looking experiments with forward-looking experiments.

Experiment 1. One of the most typical results of the transition process for Russian agriculture has been the output decline in large-scale agriculture and the increasing importance of subsistence agriculture. We replicate this development in Experiment 1 by simulating a negative (inward) shift of the production function in both large-scale agricultural sectors and a positive (outward) shift of the production function in the subsistence-oriented LPH-sector. This shift of the supply curve is simulated by decreasing (increasing) the total factor productivity in large-scale (subsistence-oriented) agricultural sector by 10%.

Experiment 2. With the second experiment we add another important economic event which affected Russia's agricultural sector in the recent past. In the aftermath of the Asian financial crisis the real exchange rate of the ruble was strongly devalued. Therefore, we expose the economy to a 10% devaluation of the real exchange rate in this consecutive (cumulative) second experiment.

Experiments 3 and 4. In the third and fourth experiment the previous two experiments are combined with two forward-looking simulations assessing the effects of an economy wide 25% decline in foreign trade and domestic marketing margins. Because the absolute importance of the domestic margins is much higher, a change of the same relative magnitude as in the foreign trade margins should yield higher changes of various economic indicators.

4.2 Discussion of Results

The effects of the four simulations on various macroeconomic indicators are shown in Table A-4. The effects on quantities in the four primary agricultural sectors are shown in the consecutive table (A-5). In the second column of these tables the absolute value of the respective indicator in the base period is shown. The values in the following columns that report the experiment results give the percentage change of the respective indicator with respect to its base value. However, the experiments are cumulative in as far as the previous experiment's

equilibrium solution is the initial equilibrium for the following experiment. Therefore, to identify the marginal change caused by each experiment one needs to deduct the percentage change reported for the previous experiment.

Experiment 1. The two counter-acting productivity changes for large-scale and small-scale agriculture simulated in Experiment 1 result in a 0.5% decrease of GDP at factor costs (Table A-4) which implies that the output increase in the subsistence sector is not sufficient to compensate for the declining output in the two large-scale agricultural sectors (Table A-5). In fact, this replicates the restructuring of Russian agriculture that took place in the 1990s. Because of the slight devaluation, which is induced by the contraction of the economy, we observe some restructuring of foreign trade and slightly more exports than before. Because we keep foreign savings constant in this experiment, imports have to increase as well to preserve the existing trade balance. The economic contraction reduces total commodities available in the economy (absorption) because of which government consumption and investments demand decline accordingly. The relative increase of the government budget deficit is with about 3% more pronounced.

Table A-5 shows that total household consumption increases by 0.8%. Prices increase slightly for both exports and imports for the goods traded by the two large-scale sectors. Exports plummet in the large-scale crop sector (-26.9%) while imports increase in both large-scale agricultural sectors (6.7% and 8.6%, for crops and livestock, respectively). These effects on agricultural trade are induced by the declining factor productivity and the associated output decline in both large-scale sectors. The decrease of domestic production in the two sectors increases their domestic supply and export prices. Consequently, restructuring takes place towards the internationally traded substitutes which in fact are one of the developments that were observable for most of the transition period in the 1990s.

Effects on agriculture. The overall effect on small-scale production is positive (1.2%) although the 10% increase in total factor productivity is dampened substantially. Table A-3 shows that the input share of the LPH sector is only 23.6% and thus a 10% increase in total factor productivity would-ceteris paribus-lead to a 7.6% increase in production (this is $[100.0-23.6]*0.1$). However, general equilibrium effects account for inelastic national demand as well as labor shifts into the larger agricultural sectors that suffer from a productivity decrease. Consequently, value-added prices in small-scale agriculture decline drastically (29.1%). Hence, we observe a more moderate positive development of production, while 'wages' in this sector fall. On the consumption side, we observe an over-proportional increase in marketed household consumption of the small-scale agriculture commodity. Although total household income declines by 1.3%, overall consumption of small-scale agriculture increases by approximately 1.2%. However, this total increase

comprises a 1.0% increase in own-household consumption and a 6.9% increase of marketed consumption, which constitutes 11.5% of the combined own-household and marketed consumption of small-scale agriculture in the base.

Experiment 2. With this experiment an additional event was simulated exogenously which, in the course of transition, overlapped with the changes discussed in Experiment 1. While the financial crisis coincided with a nominal devaluation of the Russian ruble of about 80% and a real devaluation of more than 50% we are not attempting to replicate the extent of this shock but only its direction-imposing a 10% devaluation of the real exchange rate. The devaluation causes GDP at factor costs to decline by an additional 1.8% with respect to the base to an overall decline of 2.3% for Experiment 1 and 2 combined.⁶ This decline is only possible because the economy in our structural model world can release labor (employment declines by 4.0% [-4.8%]). This is in spite of significant restructuring of domestic production towards exports and away from producing for the domestic market, which is induced by the real devaluation. In fact, exports increase by 11.7% and the increase of import prices, which is caused by the devaluation results in a parallel decline of imports of 8.6%. However, this restructuring is not significant enough to induce domestic growth. Part of the explanation for this reaction is the fact that under a flexible capital account system, a significant part of the marginal profit that is obtained from export expansion is exported to the rest of the world, or putting it more bluntly, results in significantly increased capital flight (129%). This response can be seen as a validation of the model because such behavior in fact has been observed in the 1990s in Russia, when the earnings from the raw material exports were not reinvested into domestic industries but instead were withdrawn from the Russian economy and invested elsewhere. If the flexibility within the economy would be greater, the incentives to invest into import substituting domestic industries should have been bigger.

Effects on agriculture. The response of the agricultural sectors to the real devaluation is mixed. The increased competitiveness of domestic production does not result in sufficient restructuring that would induce overall growth in agricultural sectors. Given the short run response of our model, only the large-scale crop sector benefits, in as far as it can expand export production.⁷ The

⁶ For Experiment 2, 3, and 4 we report on the incremental changes caused by the respective experiment in percent of the base values (not with respect to the previous experiment solution). Cumulative results (as percentage change from the base) are reported in Tables A4 and A5 and occasionally in parentheses, e.g., in the case of GDP at factor costs in Experiment 2 the incremental decline is 1.8% while the cumulative effect is [-2.3%], i.e., 0.5% decline from Experiment 1 plus a 1.8% decline from Experiment 2. This allows us to report on the effects of the current experiment and the overall effect of the experiment series up to the experiment under consideration simultaneously.

⁷ A related argument, however, referring to the real appreciation of the ruble prior to the crisis is put forward in an empirical paper by DYNNIKOVA (1999). She presents results of cointegration analysis for the RF on the causality between the exchange rate, imports, and domestic production of various (food) commodities. The analysis suggests that the month-to-month real appreciation of the ruble between 1993 and 1997 which made

marginal effect of this experiment on domestic production, however, is negative in all four agricultural sectors. The positive effects on the subsistence sector of the increased factor productivity (output increase of 1.2% in Experiment 1) are overcompensated by the negative effects in Experiment 2 which results in an output decline of 2.7% [-1.5%]. The major force driving this output decline is the reduction in national income and the concomitant decline in total private consumption of 7.1 [-7.8%]. This shift in demand has been the immediate response to the real devaluation simulated in this experiment. The total income decline of 1.0% [-2.3%] fed into a reduction of consumption of both, marketed and non-marketed commodities from all four agricultural sectors. Because of the increase in marketed household consumption from subsistence agriculture in Experiment 1 the cumulative effect of Experiment 1 and Experiment 2 was a decline in marketed consumption in this sector by 2.2% only. For the same reason (the increase of own household consumption by 1% in Experiment 1) the cumulative effect of both experiments on own household consumption is nil, while it declined in all other sectors. However, the incremental changes of households' consumption from formal and non-formal markets, as well as the incremental changes of domestic output in Experiment 2 are most significant in the case of the subsistence sector when compared with all other agricultural sectors. This result is driven by the different exposure of subsistence agriculture and large-scale agriculture to foreign trade. The large-scale crop and livestock agricultural sectors benefit to some extent from the devaluation and increase in exports by 28.4 and 2.3%, respectively [1.5 and -0.9%]. This is a partial compensation for the decline in domestic demand because of which output prices in both large-scale sectors decline more moderately than in the subsistence sector. In contrast, the subsistence-oriented agricultural sector suffers from overall income decline and, therefore, is hit most by the devaluation, which was simulated in Experiment 2. In fact, in the aftermath of Russia's financial crisis in 1998 and the concomitant devaluation of the ruble, the large-scale agricultural sector increased output, while output from subsistence agriculture remained more or less constant.

However, one important question that arises from the results obtained in Experiment 2 is how the overall negative effect of the devaluation on domestic agricultural sectors could be reversed, given the high inflexibility of the Russian economy? To explore this question we carried out the following two simulations.

Experiment 3. A 25% reduction of the foreign trade margins has a positive effect on GDP (0.8%) and employment (2.0%) but does not turn the negative effects of

imported goods cheaper, induced an additional short-run increase in non-CIS imports, but only for meat, which crowded out at least parts of the increase in domestic meat production. In contrast, the adjustment in other markets was rather weak.

Experiment 1 and 2 into growth. Reducing import and export trade margins favors both total imports and total exports, which increase by 3.0% and 2.6%, respectively.

Effects on agriculture. Sectorally, effects are significant for the large-scale agricultural sectors in which the reduction of the trade margin yields 6.6% export growth in the crop sector [8.1%] and overcompensates for the negative effects on exports in the livestock sectors, which were caused by the output in total factor productivity simulated with Experiment 1 (3.1% [2.2%]). However, it is obvious that the absolute size of trade effects on large-scale agriculture are very limited in this short run model, particularly because of the low level of agricultural exports in the base-period. Similar to Experiment 2, this openness to trade in the large-scale agricultural sectors results in a positive output increase in the large-scale agricultural crop sector (3.5%). However, the positive effect of this experiment on total national income (1.6%) also yields significant effects on all agricultural sectors. While the incremental increase in income does not affect own household consumption from all four agricultural sectors significantly, it feeds into higher demand for all agricultural commodities from formal markets. The respective incremental increase in demand is, with 1.9%, lowest in the case of the large-scale crop sector, followed by the large-scale livestock sector (2.1%), and is highest for marketed products from the subsistence sector. First, this is due to the fact, that in the base period the share of household expenditures for marketed household consumption from the subsistence sector has been highest. Secondly, relative price changes explain these differences. While the increased export demand for the goods from the large-scale crop sector results in a slight increase in the domestic composite commodity price the respective price for the goods marketed by the subsistence sector remains stable.

Summing it up, the effects of reducing foreign trade margins yielded overall positive effects for the Russian economy. Subsistence agriculture also benefited from the reduction in trade margins because of the associated overall income gains, which fed into increased demand for the good subsistence producers are selling in formal markets. The next interesting question is how a reduction in the domestic marketing margin of the same magnitude would change the results.

Experiment 4. Because of the size of the domestic market, the major share of the marketing margin (79.3%) applies to domestic and not to foreign trade-related transactions. Therefore, it is not surprising that a 25% reduction of the domestic marketing margin yields much higher positive effects on the Russian economy. In fact, this exogenously introduced shock increases overall economic output and yields an incremental increase in GDP and total employment of 2.8% and 7.6%, respectively. This increase in GDP and employment leads to a 5.8% increase of total national income. The positive effects of reducing the domestic marketing costs finally overcompensates for the negative effects of productivity

decrease and devaluation leading to a 1.4% GDP at factor costs growth with respect to the base period at 4.8% increased employment.

Effects on agriculture. Effects of this reduction in domestic costs of marketing are particular positive for all agricultural sectors because of the relative importance of marketing costs for the bulk commodity produced by each of these sectors. This simulation indicates that large-scale and small-scale agricultural sectors alike would benefit from measures that reduce the domestic marketing margins. The marginal increase in output is, with more than 9%, most distinct in the two large-scale agricultural sectors. The LPH-sector also increases output by about 8%, while the respective increase is more moderate in the small-scale private farm sector (3.8%). In other words, the effects on subsistence agriculture are quite significant if the domestic trade margins are reduced. Again, this is due to demand side factors. On the one hand, demand of households for the subsistence good from this sector increases by 0.9% in comparison to the base and by 0.7 percentage points in comparison to Experiment 3 only. However, because of the overall positive effect on the economy, the demand of households for the marketed product from this sector increases by almost 12% against the base and 11.5 percentage points compared to Experiment 3. In fact, the goods from the LPH-sector, which are mostly consumed directly (in a subsistence manner), shifts towards the marketed economy because of the reduction in the domestic marketing margin. Obviously, this is the result of the model set-up: marginal budget shares for the subsistence part of the LES demand system are relatively small, which more or less locks total sectoral subsistence consumption to its initial minimum consumption. In contrast, the marginal budget shares of the marketed consumption in the LES are much bigger and, therefore, marketed consumption of small-scale agriculture produce is much more responsive to relative price changes.

5 POLICY AND RESEARCH CONCLUSIONS

We analyze some characteristic developments of Russia's economic transition period in the mid- to late-1990s applying a trade-focused general equilibrium model. The agricultural sector in this model is disaggregated such that the effects of various economic changes on the subsistence-oriented agricultural sector can be traced. The transition process in Russia did not take place in a carefully-planned fashion; because of this we simulated a sequence of four path-dependent exogenous economic changes. We started out with an increase (decrease) of total factor productivity in small-scale (large-scale) agriculture; subsequently, we simulated a real depreciation of the ruble and then added an exogenous reduction of foreign trade margins, as well as domestic marketing margins. The latter is meant to simulate a reduction of transaction costs, which would follow efficiency-enhancing institutional changes.

All these experiments were simulated under the assumption of a relatively inflexible and short run model economy in which production was not able to restructure in a neoclassical way to exogenous shocks. Instead, this structural model specifies unemployment permitting the increase and decrease of the initial labor force given by the base data. Consequently, demand side responses to the economic shocks imposed are relatively more important as compared with pure neo-classical models.

This model specification permitted to simulate economic developments of the Russian economy during the 1990s related to structural and institutional changes. These experiments yielded distinct responses that were actually observable during the economic transition period:

- We showed how to replicate the response of subsistence agriculture in Russia in the transition period with a formal and applied economic model: the increased production in small-scale agricultural yields increased subsistence consumption in spite of overall economic contraction (Experiment 1). In fact, this backs the view of other studies, which have stressed that the increased consumption from subsistence production has been one important buffer against more severe poverty in Russia in the 1990s (THO SEETH et al. 1997; STONEMAN 2000). At the same time, the analysis highlights that the relative importance of Russia's small-scale agriculture is not sufficient to fully compensate for the losses in the large-scale agricultural sectors. Hence, a forward-looking agricultural policy strategy would need to address both small-scale and large-scale farms.
- A 10% real devaluation of the ruble was not sufficient to induce economic growth by itself (Experiment 2). In our simulations the overall income decline following the devaluation affected output in all agricultural sectors negatively. However, because of the openness to trade both large-scale agricultural sectors were able to redirect parts of their production towards exports. In contrast, the negative income effects of the devaluation were not buffered in the case of the two small-scale agricultural sectors. The low flexibility with which the Russian economy adapts to exogenous shocks contributes to the insufficient restructuring towards import substituting economic activities which could induce overall economic growth. This indicates that macroeconomic adjustments such as exchange rate alterations by themselves will not be sufficient to enhance the long run growth potential of either Russia's agro-food sectors or the economy as a whole. Instead such macroeconomic reforms should be complemented by urgently needed institutional reforms (SEROVA et al. 1999; BERGLÖFT and VAITLINGAM 1999).
- A reduction in domestic marketing margins is likely to be more beneficial compared to a reduction of marketing margins related to foreign trade activities (Experiment 3 and 4). In agriculture the latter would induce substantial export growth in the crop sector only, while domestic output of all

agricultural sectors would either decline or remain at its previous levels. A reduction in domestic marketing margins would induce substantial overall growth in the Russian economy. The additional income in the economy would translate into higher domestic demand for the goods from all four agricultural sectors that are marketed through formal channels. Small-scale and large-scale agricultural sectors alike would benefit more than proportionately from any policies, which contribute to a reduction in domestic marketing margins. Again, these results imply that institutional reforms which reduce transaction costs and foster the efficiency of the food marketing system should receive high priority in Russia. This objective could be reached by general measures such as enhancing contract security, but also by sector-specific policy-measures such as improved food wholesale and retail marketing facilities, which need to be provided on a regional level. Furthermore, the simulations indicate that a reduction of domestic marketing margins would be particularly beneficial for subsistence agriculture, as it would stimulate the commercialization of this important segment of Russia's agricultural sector to a significant extent.

The discussion of the simulation results shows that the presented model can be a helpful tool for analyzing the links between Russia's subsistence-oriented agriculture and the rest of the economy. However, one remaining research task will be to estimate the effects of specific institutional mechanisms, particularly the reduction in marketing costs, which were determined in our simulations ad hoc, by means of microeconomic analyses. While we were able to show the economy-wide effects such changes might have, the objective of this paper was not to address the 'how' and 'why' these changes came about. In fact, this remains an open and promising field for future research.

APPENDIX

Table A-1: Structure of the Russian Economy by Activity, in 1994, in percent

Sectors ^{a)}	GDP at Factor Costs	Total Production	Labor Force	Capital
	in % of National Total			
1 Aeleepower	3.4	3.7	1.1	5.3
2 Afuelindu	9.4	7.8	3.1	14.4
3 Ametallin	2.7	5.7	1.5	3.6
4 Achemical	1.8	3.0	1.5	2.0
5 Amachinei	7.8	11.5	9.2	6.7
6 Awoodindu	2.1	2.6	2.1	2.1
7 Alightman	3.7	7.1	3.2	4.1
8 Aconstruc	12.1	11.9	17.6	7.9
9 Ashugarref	0.1	0.2	0.1	0.2
10 Aflourmil	0.3	1.8	0.3	0.4
11 Ameatproc	0.3	1.7	0.2	0.5
12 Adairypro	0.8	1.0	0.4	1.1
13 Aotherfood	1.4	2.4	0.8	1.9
14 Aanimfeed	0.1	0.4	0.0	0.1
15 AagriCrop	2.6	2.2	2.7	2.5
16 Aagrilive	2.0	2.1	2.8	1.3
17 AAgriLPHs	4.8	3.5	2.5	6.7
18 AagriPriv	0.3	0.3	0.3	0.3
19 AtradeAgc	17.7	12.9	13.9	20.6
20 Aservices	26.6	18.2	36.9	18.5
TOTAGR^{b)}	9.7	8.1	8.3	10.8
TOTAL	100.0	100.0	100.0	100.0

Notes: a) Names of Sectors: 1 Electric power; 2 Fuel industry; 3 Metal industry; 4 Chemicals industry; 5 Mechanical engineering; 6 Wood industry; 7 Light manufacturing; 8 Construction; 9 Sugar refinery; 10 Flour milling; 11 Meat processing; 12 Dairy processing; 13 Other food industry; 14 Animal feed; 15 Large-scale farms: crop production; 16 Large-scale farms: livestock production; 17 Small-scale farms: private subsidiary plots (LPH); 18 Small-scale farms: private farmers; 19 Trade & transportation; 20 Services;

b) TOTAGR Total share of primary agricultural sectors.

Source: Own calculations from underlying SAM structure.

Table A-2: Trade Structure of the Russian Economy in 1994 by Commodity in percent and Elasticities

Sectors ^{c)}	Composition (%) ^{a)}			Ratios (%) ^{b)}		Elasticities	
	Exports	Imports	Absorp.	Exports	Imports	CES	CET
1 Celecpowe	3.5	0.5	3.4	12.9	2.7	3.0	0.6
2 Cfuelindu	40.2	4.8	7.6	70.2	17.2	3.0	0.6
3 Cmetallin	18.2	4.9	5.7	43.5	15.5	3.0	0.6
4 Cchemical	13.7	11.5	4.0	63.3	53.4	3.0	0.6
5 Cmachinei	12.8	19.2	13.1	15.3	20.6	3.0	0.6
6 Cwoodindu	4.0	1.7	2.6	21.4	9.5	3.0	0.6
7 Clightman	2.6	13.9	8.4	5.1	22.2	3.0	0.6
8 Cconstruc	0	2.5	10.9	--	--	--	0.6
9 Csugarref	0.1	6.7	0.9	4.2	78.4	3.0	1.5
10 Cflourmil	0.2	7.7	2.5	1.3	31.4	3.0	1.5
11 Cmeatproc	0.2	8.4	2.3	1.5	38.1	2.0	1.5
12 Cdairypro	0.1	7.2	1.7	2.0	47.8	3.0	1.5
13 Cothefood	2.9	6.0	2.8	17.2	25.2	3.0	1.5
14 Canimfeed	0	0	0.3	--	--		
15 CagriCrop	0.4	1.5	2.4	2.4	8.6	3.0	1.1
16 Cagrilive	0.3	2.0	2.2	2.0	13.0	3	2
17 CAgriLPHs	0	0	1.5	--	--	--	--
18 CagriPriv	0	0	0.3	--	--	--	--
19 CtradeAgc	0.8	1.5	10.8	0.8	1.5	0.7	0.5
20 Cservices	--	--	16.3	--	--	--	--
Totagro-food ^{d)}	4.2	39.5	16.9				
Total	100.0	100.0	100.0	--	--	--	--

Notes: a) Shares of sectoral exports (imports, absorption) in national total;
b) Ratios indicate the share of exports (imports) in total sectoral production (absorption);
c) See notes on Table A-1 for names of sectors;
d) Cumulative share of agricultural sectors and food industries.

Source: Own calculations from underlying SAM structure.

Table A-3: Composition of Sectors and Marketing Margins, in 1994

Sectors ^{a)}	Composition of Sectors				Marketing Margin Coefficients		
	Labor	Capital	Input	Elast-p	Domestic	Exports	Imports
	In % of Total Factor Costs		In % of Total Costs				
1 Aeleepowe	14.5	85.5	48.5	0.8	0.09	0.05	0.08
2 Afuelindu	14.3	85.7	33.5	0.8	0.07	0.05	0.12
3 Ametallin	24.0	76.0	74.2	0.8	0.08	0.05	0.12
4 Achemical	37.7	62.3	66.4	0.5	0.08	0.05	0.12
5 Amachinei	51.7	48.3	62.5	1.5	0.13	0.08	0.19
6 Awoodindu	43.9	56.1	53.8	0.5	0.13	0.10	0.19
7 Alightman	37.5	62.5	70.5	1.5	0.13	0.14	0.18
8 Aconstruc	63.5	36.5	43.8	1.5	0.08	--	--
9 Asugarref	20.2	79.8	70.4	1.2	0.22	0.15	0.05
10 Aflourmil	38.5	61.5	90.1	1.2	0.22	0.15	0.05
11 Ameatproc	25.3	74.7	88.6	1.2	0.13	0.15	0.05
12 Adairypro	23.9	76.1	58.1	1.2	0.13	0.15	0.04
13 Aothefood	24.2	75.8	67.8	1.2	0.13	0.14	0.05
14 Aanimfeed	28.1	71.9	90.6	1.2	0.04	--	--
15 AagriCrop	45.9	54.1	41.9	1.2	0.22	0.12	0.04
16 Aagilive	62.9	37.1	55.6	1.2	0.13	0.30	0.03
17 AAgriLPHs	22.6	77.4	23.6	1.2	0.39	--	--
18 AagriPriv	38.7	61.3	39.7	1.2	0.39	--	--
19 AtradeAge	34.5	65.5	24.1	1.2	--	--	--
20 Aservices	60.9	39.1	19.2	1.2	0.09	--	--
AVERAGE	43.9	56.1	56.1				

Note: a) See notes on Table A-1 for names of sectors.

Source: Own calculations from underlying SAM structure.

Figure A-1: Theoretical Structure of the Model

Supply Side

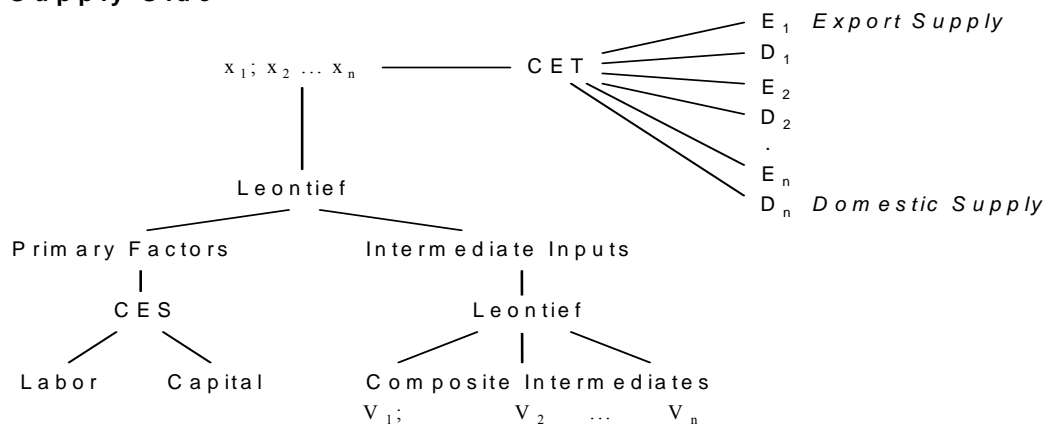

Demand Side

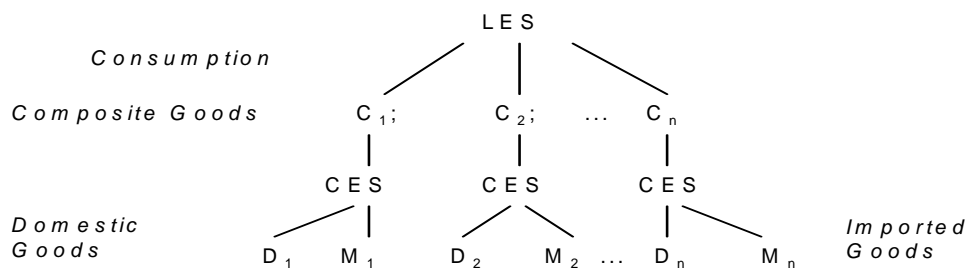

Source: WEHRHEIM (2003).

Table A-4: Macroeconomic Results of Experiments, Changes Relative to Base, in percent

	Base Period Value in Trillion Ruble	TFP Shock	Devaluation	Foreign Marketing Margins	Domestic Marketing Margins	Incremental Change in Percentage Points (Exp. 4 w-r-t Exp. 3)
		(Cumulative) Change in Comparison to Base in %				
		EXP. 1 ^{b)}	EXP. 2	EXP. 3	EXP. 4	
GDPfc ^{a)}	611.7	-0.5	-2.3	-1.5	1.4	2.8
EXPORTS	152.4	0.4	12.1	14.7	18.0	3.3
IMPORTS	130.0	0.5	-8.1	-5.1	-1.2	3.9
PRVCON	227.1	0.8	-7.8	-5.7	1.4	7.0
INV	181.6	-1.1	-7.6	-5.5	1.9	7.4
GOVCON	173.4	-1.5	-7.1	-5.3	1.8	7.1
NETITAX	12.5	1.1	-7.3	-4.2	-0.4	3.9
GDPMP1	604.5	-0.5	-2.4	-0.5	6.4	6.9
Macro Variables						
CPIXP	1.136	0.2	2.3	1.9	0.6	-1.2
DPIXP	1.000					
EXRXP	1.000	0.3	10.4	10.1	12.3	2.2
EGXP	173.4	-1.3	-7.5	-5.8	-0.1	5.8
GSAVXP	-66.7	-2.8	-20.9	-19.3	-13.1	6.1
FSAVXP	-22.4		129.4	129.4	129.4	0.0
IADJXP	1.0	-1.1	-7.6	-5.5	1.9	7.4
MPSXP	0.5	-0.1	5.0	4.8	4.6	-0.2
QFSXP FCAP	343.3	fixed	fixed	fixed	fixed	--
QFSXP FLAP	268.4	-0.8	-4.8	-2.8	4.8	7.6
Household Indicators						
QHTTXP	200.4	0.7	-7.8	-5.7	1.4	7.0
QAHTTXP	30.1	0.8	-0.1	0.1	0.8	0.7
QHTTTXP	230.6	0.7	-6.8	-4.9	1.3	6.2
YIXP	611.7	-1.3	-2.3	-0.7	5.1	5.8

Notes: a) TFP = Total Factor Productivity. GDPFC = GDP at factor costs; PRVCON = Private consumption; INV = Investment demand; GOVCON = Government consumption; NETTAX = Net tax revenues; GDPMP = GDP at market prices; CIP = Consumer price index; DPI = Domestic sales price index; EXR = Real exchange rate; EG = Government expenditure; GSAV = Government savings; FSAV = Foreign savings; IADJ = Fixed investment scaling factor; MPS = Marginal propensity to save of households; QFSXP FCAP = Factor supply capital; QFSXP FLAB = Factor supply labor; QHTT = Total consumption of all commodities by households; QAHTT = Consumption of all activities by households; QHTTT = Total consumption of households; YIXP = National income. b) Experiment 1: shift of the supply curve by decreasing (increasing) the total factor productivity in large-scale (subsistence-oriented) agricultural sector by 10%. Experiment 2: the economy is exposed to a 10% devaluation of the real exchange rate in this consecutive (cumulative) experiment. Experiment 3: 25% decline in foreign trade margins. Experiment 4: 25% decline in domestic trade margins.

Source: Results from policy scenarios.

Table A-5: Quantity Effects of Experiments for Agricultural Sectors, Changes Relative to Base, in percent

Variables	Sectors ^{a)}	Base Priod Value in Trillion Ruble	TFP Shock	Devalua- tion	Foreign Marketing Margins	Domestic Marketing Margins	Marginal Change in Percentage Points (Exp. 4 w-r-t Exp. 3)							
								(Cumulative) Change in Comparison to Base in %						
								EXP. 1	EXP. 2	EXP. 3	EXP. 4			
Exports	CagriCrop	0.5	-26.9	1.5	8.1	13.6	5.5							
	Cagrilive	0.4	-3.2	-0.9	2.2	13.2	11.0							
Imports	CagriCrop	2.3	6.7	-6.0	-3.1	2.1	5.2							
	Cagrilive	3.4	8.6	-11.4	-8.7	-9.4	-0.7							
Domestic Output	CagriCrop	24.4	-2.8	-3.7	-0.2	7.1	9.1							
	Cagrilive	23.2	-1.8	-2.7	-1.2	8.3	9.5							
	CagriLPHs	14.6	1.2	-1.5	0.1	7.9	7.8							
	CagriPriv	2.7	-0.4	-2.1	-1.3	2.4	3.8							
	CtradeAgc	143.3	-0.4	-2.4	-4.9	-15.5	-10.5							
Domestic Sales	CagriCrop	26.2	-1.5	-4.0	-2.3	6.5	8.8							
	Cagrilive	26.2	-0.5	-3.9	-2.3	5.8	8.1							
	CagriLPHs	14.6	1.2	-1.5	0.1	7.9	7.8							
	CagriPriv	2.7	-0.4	-2.1	-1.3	2.4	3.8							
	CtradeAgc	144.6	-0.4	-2.6	-5.1	-15.8	-10.7							
Marketed Households Consumption	CagriCrop	1.6	-1.3	-8.9	-7.0	-0.3	6.6							
	Cagrilive	5.1	-0.5	-8.5	-6.4	0.7	7.2							
	CagriLPHs	3.1	6.9	-2.2	0.5	11.9	11.5							
	CagriPriv	0.1	0.9	-7.1	-4.8	4.7	9.5							
Own- households Consumption	AagriCrop	0.1	-0.2	-0.9	-0.8	-0.3	0.5							
	Aagrilive	0.6	-0.1	-0.9	-0.7	0	0.6							
	AagriLPHs	24.2	1.0	0	0.3	0.9	0.7							
	AagriPriv	0.3	0.1	-0.7	-0.5	0.1	0.6							

Note: a) See notes on Table A-1 for names of sectors.

Source: Results from policy scenarios.

REFERENCES

- AMELINA, M. (2000): Why Russian Peasants Remain in Collective Farms: A Household Perspective on Agricultural Restructuring, *Post-Soviet Geography and Economics*, Vol. 7, pp. 483-511.
- BERGLÖFT, E., VAITILINGAM, R. (eds.) (1999): Stuck in Transit: Rethinking Russian Economic Reform, Centre for Economic Policy Research (CEPR), London.
- BROOKS, K., LERMAN, Z. (1994): Land Reform and Farm Restructuring in Russia, *Discussion Paper No. 233*, The World Bank, Washington, D.C.
- DEVARAJAN, S., LEWIS, J.D., ROBINSON, S. (1994): Getting the Model Right: The General Equilibrium Approach to Adjustment Policy, Draft Manuscript, World Bank, Washington, D.C.
- DYNNIKOVA, O. (1999): Real Appreciation and Output – Russia 1993-1997, Economics Education and Research Consortium (EERC), *Working Paper Series, No. 99/13*, Moscow.

- GADDY, C., ICKES, B. (1999): An Accounting Model of the Virtual Economy in Russia, *Post-Soviet Geography and Economics* (formerly *Post-Soviet Geography*), Vol. 40, No. 2, pp. 79-97.
- GOSKOMSTAT – Statistical Office of the Russian Federation (1998): Statistical Yearbook, (in Russian: Rossiskij Statisticeskij Eshegodnik), Official Publication, Moscow.
- GOSKOMSTAT – Statistical Office of the Russian Federation (1999a): Russian Agriculture, (in Russian: Selskoje chosjajstvo v Rossij), Official Publication, Moscow.
- GOSKOMSTAT – Statistical Office of the Russian Federation (1999b): Russia in Figures, (in English) Official Publication, Moscow.
- GOVERNMENT OF THE RUSSIAN FEDERATION (2000): Basic Trends in Agrarian and Food Policy of the Russian Federation for 2001-2010, Minutes No. 27, Session on June 27th, Moscow.
- KOESTER, U., STRIEWE, L. (1999): Huge Potential, Huge Losses – The Search for Ways Out of the Dilemma of Ukrainian Agriculture, in: SIEDENBERG, A., HOFFMANN, L. (eds.): Ukraine at the Crossroads: Economic Reforms in International Perspectives, Physica Publishers, Heidelberg/New York.
- PERROTTA, L. (1999): Individual Subsidiary Holdings – The Micro-economics of Subsistence in Ukraine, Center for Privatization and Economic Reform in Agriculture, *Occasional Paper No. 12*, Kyiv.
- SEETH, H.T., CHACHNOV, S., SURINOV, A., VON BRAUN, J. (1998): Russian Poverty: Muddling Through Economic Transition with Garden Plots, *World Development*, Vol. 26, No. 9, pp. 1611-1623.
- SEROVA, E., VON BRAUN, J., WEHRHEIM, P. (1999): Impact of Financial Crisis on Russia's Agro-food Economy, *European Review of Agricultural Economics*, Vol. 26, No. 3, pp. 349-370.
- STONEMAN, R. (2000): The Prospects for Economic Growth and the Consequences for Poverty in Russia. Mimeo, Russian European Centre for Economic Policy (RECEP), Moscow.
- VON BRAUN, J., QAIM, M. (1999): Household Action in Food Acquisition and Distribution under Transformation Stress, in: HARTMANN, M., WANDEL, J. (eds.): Food Processing and Distribution in Transition Economies: Problems and Perspectives, Vauk Academic Publishers, Kiel.
- WEHRHEIM, P. (2000): The Role of the Agro-food Sector in the Macro-economy: General Equilibrium Effects, in: WEHRHEIM, P., FROHBERG, K., SEROVA, E., VON BRAUN, J. (eds.): Russia's Agro-food Sector: Towards Truly Functioning Markets, Kluwer Academic Publishers, Boston/Dordrecht/London, pp. 155-179.
- WEHRHEIM, P. (2003): Modelling Russia's Economy in Transition, Ashgate Publishing Company.
- WOBST, P. (1998): A 1992 Social Accounting Matrix (SAM) for Tanzania, Trade and Macroeconomics Division Discussion Paper Series 30, International Food Policy Research Institute, Washington, D.C.
- WOBST, P. (2000): Devaluation under Decreasing Marketing Margins Through Infrastructure Investment, Paper presented at the XXIV International Conference of Agricultural Economists, Berlin, August 2000.

- Vol. 1 **The Importance of Institutions for the Transition in Central and Eastern Europe with Emphasis on Agricultural and Food Industry**
ed. by Klaus Frohberg and Witold-Roger Pogonietz
1998, 137 pages, ISBN 3-8175-0258-3
- Vol. 2 **The Significance of Politics and Institutions for the Design and Formation of Agricultural Policies**
ed. by Klaus Frohberg and Peter Weingarten
1999, 254 pages, ISBN 3-8175-0289-3
- Vol. 3 **Food Processing and Distribution in Transition Countries. Problems and Perspectives**
ed. by Monika Hartmann and Jürgen Wandel
1999, 349 Seiten, ISBN 3-8175-0293-1
- Vol. 4 **Die private Nachfrage nach Nahrungsmitteln im Transformationsprozeß Tschechiens und Polens**
Stephan Brosig (PhD)
2000, 171 Seiten, ISBN 3-8175-0319-9
- Vol. 5 **Integrating Estonia into the EU: Quantitative Analysis of the Agricultural and Food Sector**
Achim Fock (PhD)
2000, 286 pages, ISBN 3-8175-0320-2
- Vol. 6 **Competitiveness of Agricultural Enterprises and Farm Activities in Transition Countries**
ed. by Peter Tillack and Frauke Pirscher
2000, 216 pages, ISBN 3-8175-0322-9
- Vol. 7 **Конкурентоспособность сельскохозяйственных предприятий и фермерской деятельности в странах переходного периода**
под редакцией Петера Тиллака и Фрауке Пиршер
2000, 253 страницы, ISBN 3-8175-0324-5
- Vol. 8 **Perspectives on Agriculture in Transition: Analytical Issues, Modelling Approaches, and Case Study Results**
ed. by Witold-Roger Pogonietz, Alberto Zezza, Klaus Frohberg and Kostas G. Stamoulis
2000, 433 pages, ISBN 3-8175-0323-7

- Vol. 9 **Land Ownership, Land Markets and their Influence on the Efficiency of Agricultural Production in Central and Eastern Europe**
ed. by Peter Tillack and Eberhard Schulze
2000, 485 pages, ISBN 3-8175-0325-3
- Vol. 10 **Landwirtschaft und Industrie in Russland – der Transformationsprozeß in der Ernährungsindustrie**
Jürgen Wandel (PhD)
2000, 361 Seiten, ISBN 3-8175-0334-2
- Vol. 11 **Food Consumption in Russia. An Econometric Analysis Based on Household Data**
Karin Elsner (PhD)
2001, 256 pages, ISBN 3-8175-0335-0
- Vol. 12 **Alexander Wasiljewitsch Tschajanow – die Tragödie eines großen Agrarökonomen**
hrsg. u. übers. von Eberhard Schulze
2001, 192 Seiten, ISBN 3-8175-0342-3
- Vol. 13 **Analysis of Food Consumption in Central and Eastern Europe: Relevance and Empirical Methods**
ed. by Stephan Brosig and Monika Hartmann
2001, 253 pages, ISBN 3-8175-0349-0
- Vol. 14 **Wettbewerbsprozesse und Firmenwachstum in der Transformation am Beispiel der polnischen Fleischindustrie**
Agata Pieniadz (PhD)
2002, 291 Seiten, ISBN 3-8175-0360-1
- Vol. 15 **Agricultural Enterprises in Transition: Parallels and Divergences in Eastern Germany, Poland and Hungary**
ed. by Ludger Hinnens-Tobrägel and Jürgen Heinrich
2002, 455 Seiten, ISBN 3-8175-0366-0
- Vol. 16 **Agricultural Technology and Economic Development of Central and Eastern Europe. Results of the Workshop in Halle, 2nd – 3rd July 2001**
ed. by Peter Tillack and Ulrich Fiege
2002, 160 Seiten, ISBN 3-86037-199-1
- Vol. 17 **Региональные аспекты аграрных преобразований: политика, реструктуризация, рыночная адаптация**
под редакцией Петера Тиллака и Виталия Зиновчука
2003, 236 страницы, ISBN 3-928466-55-0

- Vol. 18 **Alexander Vasilievich Chayanov – the Tragedy of an Outstanding Agricultural Economist**
ed. by Eberhard Schulze
2003, 188 Seiten, ISBN 3-86037-201-7
- Vol. 19 **Development of Agricultural Market and Trade Policies in the CEE Candidate Countries**
by the Network of Independent Agricultural Experts in the CEE Candidate Countries
2003, 72 Seiten, ISBN 3-86037-212-2
- Vol. 20 **Large Farm Management**
ed. by Alfons Balmann and Alexej Lissitsa
2003, 396 Seiten, ISBN 3-86037-213-0
- Vol. 21 **Success and Failures of Transition – the Russian Agriculture between Fall and Resurrection**
ed. by Eberhard Schulze, Elke Knappe, Eugenia Serova, Peter Wehrheim
2003, 521 Seiten, ISBN 3-9809270-1-6
- Vol. 22 **Subsistence Agriculture in Central and Eastern Europe: How to Break the Vicious Circle?**
ed. by Steffen Abele and Klaus Froberg
2003, 233 Seiten, ISBN 3-9809270-2-4

In der Schriftenreihe *Studies on the Agricultural and Food Sector in Central and Eastern Europe* werden durch das IAMO Monographien und Tagungsberichte herausgegeben, die sich mit agrarökonomischen Fragestellungen zu Mittel- und Osteuropa beschäftigen. Wissenschaftlern, die in diesem Bereich forschen, steht die Schriftenreihe als Diskussionsforum offen.

In its series *Studies on the Agricultural and Food Sector in Central and Eastern Europe* IAMO publishes monographs and proceedings focusing on agricultural economic issues specific to Central and Eastern Europe. This series offers a forum to researchers studying this area.

ISSN 1436-221X
ISBN 3-9809270-2-4