

Schüler, Martin

Working Paper

The threat of systemic risk in banking - evidence for Europe

Research Notes, No. 3a

Provided in Cooperation with:

Deutsche Bank Research, Frankfurt am Main

Suggested Citation: Schüler, Martin (2002) : The threat of systemic risk in banking - evidence for Europe, Research Notes, No. 3a, Deutsche Bank Research, Frankfurt a. M.

This Version is available at:

<https://hdl.handle.net/10419/40286>

Standard-Nutzungsbedingungen:

Die Dokumente auf EconStor dürfen zu eigenen wissenschaftlichen Zwecken und zum Privatgebrauch gespeichert und kopiert werden.

Sie dürfen die Dokumente nicht für öffentliche oder kommerzielle Zwecke vervielfältigen, öffentlich ausstellen, öffentlich zugänglich machen, vertreiben oder anderweitig nutzen.

Sofern die Verfasser die Dokumente unter Open-Content-Lizenzen (insbesondere CC-Lizenzen) zur Verfügung gestellt haben sollten, gelten abweichend von diesen Nutzungsbedingungen die in der dort genannten Lizenz gewährten Nutzungsrechte.

Terms of use:

Documents in EconStor may be saved and copied for your personal and scholarly purposes.

You are not to copy documents for public or commercial purposes, to exhibit the documents publicly, to make them publicly available on the internet, or to distribute or otherwise use the documents in public.

If the documents have been made available under an Open Content Licence (especially Creative Commons Licences), you may exercise further usage rights as specified in the indicated licence.



June 26, 2002

No. 3

Research Notes

Working Paper Series

The threat of systemic risk in banking – evidence for Europe

This paper attempts to answer the question whether the threat of systemic risk in banking exists only on a national or on a European level. Following De Nicolo and Kwast (2001), mean rolling-window correlations between bank stock returns are used as a measure for interdependencies among European banks, and hence for the systemic risk potential in Europe. National influences on stock returns are eliminated by estimating a return-generating model. There is some evidence that interdependencies among European banks have increased over the past 15 years and that the potential of systemic risk has shifted from a national level to a European level. (page 1)

Martin Schüler

Centre for European Economic Research (ZEW), Mannheim

How integrated are the European retail financial markets? A cointegration analysis

With the introduction of the euro, a single European money market has emerged. Further wholesale financial markets are considered to be highly integrated within the European Union. However, integration in retail financial markets is less advanced. For measuring financial market integration this distinction between wholesale and retail markets becomes crucial. There is a wide literature relating to integration of wholesale financial markets but just a few studies that try to measure integration in European retail markets. This paper, in a first step, gives a systematisation of the literature on measuring financial market integration with a focus on the distinction between wholesale and retail financial markets. In a second step, bivariate and multivariate cointegration techniques are used to assess the degree of integration in four loans and two deposit markets in the European Union. Finally, based on this analysis obstacles to financial market integration are discussed. (page 31)

Martin Schüler and Friedrich Heinemann

Centre for European Economic Research (ZEW), Mannheim



Advisory Committee

Dr. Peter Cornelius,
World Economic Forum

Prof. Soumitra Dutta,
INSEAD

Prof. Dr. Michael Frenkel,
WHU Koblenz

Prof. Dr. Helmut Reisen,
OECD Development Centre

Prof. Dr. Norbert Walter,
Deutsche Bank Research

Deutsche Bank Research

Frankfurt am Main
Germany

Internet: www.dbresearch.com

E-mail: marketing.dbr@db.com

Fax: +49 69 910-31877

Managing Directors

Axel Siedenberg
Norbert Walter

The threat of systemic risk in banking – evidence for Europe

Martin Schöler*

Abstract

This paper attempts to answer the question whether the threat of systemic risk in banking exists only on a national or on a European level. Following De Nicolo and Kwast (2001), mean rolling-window correlations between bank stock returns are used as a measure for interdependencies among European banks, and hence for the systemic risk potential in Europe. National influences on stock returns are eliminated by estimating a return-generating model. There is some evidence that interdependencies among European banks have increased over the past 15 years and that the potential of systemic risk has shifted from a national level to a European level.

JEL-Classification: G21, F34

Keywords: systemic risk, banking, contagion, Europe

* *Centre for European Economic Research (ZEW), P.O. Box 103443, D-68034 Mannheim, Germany, Phone: +49/621/1235-148, Fax: +49/621/1235-223; E-mail: schueler@zew.de. The author is also affiliated with WHU, Koblenz.*

***Acknowledgement:** The author gratefully acknowledges financial support by the German Science Foundation (DFG), Bonn. I am indebted for helpful comments and discussion to Friedrich Heinemann and Jürgen Weigand. Comments and suggestions from Felix Hüfner, Norbert Janz, and Michael Schröder are also appreciated. Research assistance was provided by Dirk Guennemann and Sebastian Walter. All remaining errors are my own.*

Non-Technical Summary

Banking activities are regulated and supervised throughout the industrial countries. In general, the reasons for this regulation and supervision are controversial. “A central issue in this controversy is the extent to which a negative event, occurring at a specific bank, that implies an increase in the probability of its failure, generates negative externalities for the banking system.” (Slovin et al., 1999: 198) This is what is often referred to as systemic risk in banking.

The analysis in this paper attempts to answer the question whether the threat of systemic risk in banking is a national threat or rather a Europe-wide threat. Following De Nicolo and Kwast (2001), mean rolling-window correlations between bank stock returns are used as a measure for the interdependencies among European banks, and hence for the systemic risk potential in Europe.

At first, weekly rolling-window correlations are calculated between stock returns of the 60 largest European banks without controlling for national factors. These give evidence that interdependencies have increased within the last two decades. However, since national factors determine to a large extent stock returns this result can only be seen as preliminary.

Thus, in the second part of the analysis we estimate – on a monthly basis – a return generating model in order to eliminate national influences from bank stock returns. The national market returns and the European market return as well as the change in national interest rates are used as the regressors. The unanticipated change in interest rates is calculated using an ARIMA model. The return generating model is estimated for every country in a panel with fixed effects using least squares. Based on the residuals from these regressions the part of the bank stock returns that is not due to national influence is calculated.

Thereafter, rolling-window correlations are calculated using the adjusted bank stock returns. Again, we find evidence that interdependencies among European banks have increased over the last 15 years. This indicates that the potential for systemic risk at the European level has risen and that there may have been a shift in the systemic risk potential from a national level to a European level.

The evidence on the rise in systemic risk potential found for Europe provides an argument in favour of Europe-wide banking regulation and supervision. Whether the existing forms of cooperation between the national authorities is an appropriate way in securing financial stability or whether a single European supervisor is needed is up to further research.

1 Motivation

Banking activities are regulated and supervised throughout the industrial countries. In general, the reasons for this regulation and supervision are controversial. “A central issue in this controversy is the extent to which a negative event, occurring at a specific bank, that implies an increase in the probability of its failure, generates negative externalities for the banking system.” (Slovin et al., 1999: 198) This is what is often referred to as systemic risk in banking.

In Europe banking regulation and in particular supervision is organised at a national level. There is nothing such as a European Financial Services Authority (FSA). However, there may be the need for such a single European banking supervision authority since the threat of systemic risk may have shifted from the national level to the European level.¹ Integration of financial markets in Europe has increased rapidly not just since the introduction of the Euro. This development may have increased interdependencies among financial institutions of different countries which in turn may have led to a rise in the potential of cross-border contagion, i.e. systemic risk at a European level. If this is true a bank failure in one country could potentially trigger further failures not only in the same country but also in other countries. The danger of the current nation-based system is that a national banking supervisor would possibly undervalue or even disregard such a cross-border contagion effect. Thus, a single European supervisor or at least strong coordination among national supervisors could be needed.²

There are many theoretical studies on systemic risk in banking, however, hardly any empirical work exists – at least not for Europe. In particular there are no studies that focus on the trans-border aspect of systemic risk in banking and the consequences for banking supervision in Europe. Closely related is the financial crisis literature that looks at cross-border contagion, however, there the focus is primarily on currency and debt crisis. This paper aims to assess the threat of systemic risk in European banking. Following De Nicolo and Kwast (2001),

¹ There are a number of different measures employed in order to contain systemic risk in banking that are often part of banking supervision and regulation. The main measures are lender of last resort, deposit insurance, disclosure requirements and capital regulation. See, for example, Davis (1992), Bartholomew and Whalen (1995), Kaufman and Scott (2000), Canoy et al. (2001).

² The question that arises is whether the potential of systemic risk may be even world-wide and not just Europe-wide. The analysis in this paper is motivated from banking supervision that – at least in the short and medium run – will not be organised at a world-wide level. Thus, we merely analyse the potential of systemic risk at the European level and do not ask whether there may be also contagion between European and non-European banks.

rolling-window correlations among bank stock returns are used as an indication for the development of interdependencies among banks over time and hence for the systemic risk potential. Beforehand, national factors determining bank stock returns are eliminated by estimating a return generating model.

The paper is organised as follows. Section 2 defines systemic risk and gives a brief review of the (empirical) literature. Section 3 attempts to assess the systemic risk potential in Europe. Section 3.1 gives some first insights using descriptive methods. Sections 3.2-3.6 describe our correlation analysis both with and without controlling for national factors determining bank stock returns. Finally, section 4 concludes.

2 Systemic risk

2.1 What is systemic risk?

No uniform definition of systemic risk exists in the literature. Loosely speaking, systemic risk means “the risk or probability of breakdowns in an entire system, as opposed to breakdowns in individual parts or components” (Kaufman and Scott, 2000: 1). Beyond dispute is that systemic risk can occur in banking as well as in other parts of the financial sector, e.g. in payment and settlement systems or in securities markets – in financial markets in general. Furthermore, there is consensus on the existence of different channels through which systemic risk can occur in banking. Instead of giving a comprehensive definition of systemic risk these different channels are discussed in order to explain the concept of systemic risk in banking.³

There are two ways in which systemic risk can occur in the banking market (Staub, 1999). First, a macro shock can simultaneously have averse effects on several banks. Such a macro shock can either be a cyclical downturn or other aggregate shocks like interest rate or exchange rate shocks or a stock market crash.

Second, systemic risk can occur as a result of contagion in the banking market, i.e. an initial shock causes one bank to fail which subsequently leads to the failure of other banks (“micro channel”). Such contagion in banking can work through two channels (de Bandt and Hartmann, 2000): the exposure channel and the information channel. The former results from real exposures in the interbank market and/or in payment systems. Thus, insolvency problems of one bank can

³ The definitions for systemic risk given so far all refer to one or more parts of this whole concept of systemic risk. For a comprehensive definition of systemic risk see de Bandt and Hartmann (2000).

trigger a chain reaction leading to other bank failures. This channel refers to the so called “domino effect”. The information channel, in contrast, refers to ways through which bad news from one bank lead to the conclusion in the market that other banks are also in trouble. This will lead to adjustments of contracts with other partners or – on the depositor level – to contagious withdrawals (bank runs). A central concept of this channel is that depositors and also other counterparties have only imperfect information about (a) the type of shocks hitting a bank, i.e. whether it is idiosyncratic or systemic and (b) the real exposures to other banks.

In this paper the focus is on the micro channel of systemic risk. Thus, in the context of this paper a macroeconomic shock that causes several banks to fail is not regarded as systemic risk. As a consequence the terms systemic risk and contagion risk are used interchangeably. This view is in line with the definitions of systemic risk given, for example, by Kaufman (1995)⁴ or the Bank for International Settlements (BIS).

In general the banking or the financial sector is viewed as more vulnerable to contagion than other industries since banks are viewed as more susceptible to failures (Kaufman 1995, 1996, Goodhart et al., 1998, de Bandt and Hartmann, 2000). In this sense, banks are special for several reasons:

One reason lies in the structure of the banks. Banks are vulnerable to runs due to fractional reserve banking, i.e. in the case of high withdrawals the banks may not be able to fulfil deposit obligations. Furthermore, banks are highly leveraged, i.e. they have a low capital-to-assets ratio. Thus there is only little room for losses. In addition, they exhibit low cash-to-assets ratios which may require the sale of earning assets to meet deposit obligations. Furthermore banks are highly interconnected through direct exposures in the interbank money market, the large-value payment and security settlement systems.

2.2 Review of literature

There is a wide theoretical literature on systemic risk starting from the classical bank run models following Diamond and Dybvig (1983) and extensions of these models of single banks’ fragility to models of multiple bank systems, leading to the modern bank contagion literature.⁵

⁴ Kaufman (1995: 47) defines systemic or contagion risk as “the probability that cumulative losses will occur from an event that sets in motion a series of successive losses along a chain of institutions or markets comprising a system.”

⁵ For a good survey on the theoretical as well as the empirical literature on systemic risk see de Bandt and Hartmann (2000).

Also, there are empirical studies on systemic risk and contagion in the banking sector that utilise several different approaches. The predominant part of these studies examine specific bank failures of the past either by looking at intertemporal correlations of bank failures or by doing event studies.⁶ Since today – i.e. in times of deposit insurance's and lenders of last resort – bank runs and accumulated bank failures do not actually occur in industrial countries such methods can not be applied in order to empirically examine systemic risk. Also the use of historical data – for example from the free banking era in the United States – is not appropriate when assessing the actual threat of systemic risk and contagion in banking. Hence, an indicator for the potential of systemic risk is needed.

Focusing exclusively on the potential threat stemming from interbank lending, i.e. on the exposure channel of systemic risk one approach is to directly examine exposures in the interbank market and simulate contagious effects following the hypothetical failure of one bank. There are some studies for the US that use this approach utilising data, for example, from the Federal Reserve's large-value transfer system, Fedwire, or the Clearinghouse Interbank Payments System (CHIPS) (Kaufman, 1994, Humphrey, 1986, Furfine, 1999). For Europe, Michael (1998), reports some exposures from London interbank markets, Angelini et al. (1996) from the Italian netting system, and Sheldon and Maurer (1998) base their simulations on accounting data drawn from banks that operate in Switzerland. All of these studies report a relatively small threat to financial market stability from the failure of one bank.

Unfortunately, for whole Europe data on interbank lending is only available on an aggregate level which does not allow for statements concerning contagion risk between individual banks. Nevertheless, such an analysis on an aggregate basis is made in section 3.1 in order to gain a first insight.

Contrary to former studies this study attempts to assess the threat of systemic risk in banking in an international context.⁷ In particular, this paper attempts to answer the question whether systemic risk in Europe can be regarded as a country specific threat – or if it should rather be regarded as a Europe-wide threat. To answer this question is of crucial importance for banking regulation and supervision. We attempt to answer this question using correlations among bank stock returns as a measure for the interdependencies – and hence the potential for systemic risk among banks. Before correlations are calculated a

⁶ See, for example, Aharony and Swary (1983), Swary (1986), Schoenmaker (1996), Slovin et al. (1999), Bessler and Nohel (2000), Akhigbe and Madura (2001).

⁷ Of course there is the financial crisis literature that looks at cross-border contagion (see, e.g., Dornbusch et al., 2000). But their focus is primarily on currency or debt crisis.

return generating model is estimated in order to control for national factors determining bank stock returns.

3 The threat of systemic risk in European banking

3.1 Some insights from cross-border banking

When focusing on the exposure channel of systemic risk the claims and liabilities among banks in the interbank market give evidence on the systemic risk potential. Unfortunately, such data is not available on a bank-to-bank basis at the European level. However, the BIS International Banking Statistics contains aggregate data on the international claims of reporting banks on individual countries.⁸ Table 1 shows a matrix containing these claims as a percentage of total assets of Monetary Financial Institutions (MFI's)⁹ (as of end June 2001). Claims vis-à-vis one country above 5 % are indicated by grey highlighting.

⁸ Bank for International Settlement, Quarterly reviews, Table 9B.

⁹ The definition of MFI's conforms to that of reporting banks by the BIS.

Table 1 – Consolidated international claims of reporting banks on individual countries as a percentage of total assets of MFI's
(amounts outstanding as of End June 2001)

Country B	Country A													Total
	AT	BE	DK	FI	FR	DE	IE	IT	NL	PT	ES	SE	CH	
AT	0.00741	0.00065	0.00033	0.01141	0.12966	0.00076	0.00678	0.00873	0.00050	0.00298	0.00156	0.01106	0.01491	0.19673
BE	0.00099	0.00165	0.00015	0.04568	0.05873	0.00082	0.01420	0.03211	0.00036	0.00936	0.00331	0.01884	0.01733	0.20353
DK	0.00136	0.00950	0.02008	0.00640	0.05239	0.00169	0.00249	0.01771	0.00019	0.00195	0.01850	0.00978	0.01463	0.15667
FI	0.00253	0.01109	0.04283	0.02202	0.09473	0.00222	0.00348	0.01193	0.00028	0.00525	0.06235	0.00871	0.01912	0.28653
FR	0.00039	0.00909	0.00027	0.00008	0.02805	0.00036	0.00625	0.00565	0.00053	0.00310	0.00062	0.00608	0.01072	0.07119
DE	0.00251	0.00593	0.00080	0.00038	0.01260	0.00069	0.00347	0.00763	0.00030	0.00292	0.00125	0.00772	0.00794	0.05416
GR	0.00331	0.01963	0.00037	0.00102	0.05461	0.10463	0.00000	0.01073	0.02589	0.00206	0.01180	0.01264	0.02420	0.27196
IE	0.00430	0.02808	0.00083	0.00057	0.02122	0.08507	0.01023	0.00988	0.00152	0.00380	0.00274	0.00764	0.03434	0.21021
IT	0.00173	0.02258	0.00006	0.00053	0.03841	0.06692	0.00104	0.02039	0.00052	0.00626	0.00088	0.01366	0.02306	0.19603
LU	0.00227	0.01866	0.00590	0.00016	0.02259	0.12717	0.00028	0.03221	0.00836	0.00199	0.00320	0.01244	0.01032	0.24743
NL	0.00178	0.02477	0.00102	0.00021	0.03072	0.07058	0.00098	0.00975	0.00090	0.00698	0.00214	0.01233	0.02342	0.18557
NO	0.00092	0.00492	0.00842	0.00676	0.00678	0.03998	0.00047	0.00192	0.00871	0.00014	0.00085	0.01858	0.01446	0.11952
PT	0.00110	0.01148	0.00066	0.00051	0.01347	0.05345	0.00000	0.02638	0.01005	0.01483	0.00071	0.00343	0.01522	0.15129
ES	0.00026	0.00857	0.00035	0.00012	0.02070	0.04243	0.00083	0.00550	0.00663	0.00288	0.00022	0.00526	0.00945	0.10320
CH	0.00129	0.00510	0.00084	0.00010	0.01879	0.03483	0.00013	0.00262	0.00592	0.00063	0.00133	0.00097	0.00745	0.08000
UK	0.00156	0.01427	0.00311	0.00067	0.02099	0.06485	0.00549	0.00833	0.01798	0.00109	0.00657	0.00430	0.03001	0.17924

Reports cross-border claims of banks in country B vis-à-vis country A as a percentage of total assets of MFI's in country B

Source: Bank for International Settlement, ECB, own calculations; Note: AT = Austria, BE = Belgium, DK = Denmark, FI = Finland, FR = France, DE = Germany, GR = Greece, IE = Ireland, IT = Italy, LU = Luxembourg, NL = The Netherlands, NO = Norway, PT = Portugal, ES = Spain, SE = Sweden, CH = Switzerland, UK = United Kingdom; Claims vis-à-vis one country above 5 % are indicated by grey highlighting.

The figures in table 1 indicate that international bank lending takes only a very small portion of total assets. For almost all countries international claims do not exceed 5 % – often not even 1 % of total MFI assets. Only vis-à-vis Germany some countries have international claims of above 5 %. These figures do not give evidence for substantial international bank lending relative to total assets.

However, the significance of these figures for systemic risk should not be overestimated. The figures contain international claims on individual countries, i.e. not just on banks in that country but also on government and private households. Furthermore, these figures do not tell us anything about the bank-to-bank exposures that are one main channel for contagion in banking. Thus, despite the low interdependencies on the aggregate level there may be substantial interbank lending on a bank-to-bank basis which causes systemic risk at the European level.

3.2 Correlations of bank stock returns

De Nicolo and Kwast (2001) argue that estimation of the systemic risk potential may be achieved using a measure of the interdependencies of financial institutions. For an economic shock to become systemic a negative externality must exist, i.e. a negative shock at a single bank must be highly likely to have contagious effects on other financial institutions. Only if the financial institutions are interdependent in some way such an externality exists – i.e. there is the threat of systemic risk. Such interdependencies can be either direct, i.e. through direct exposures or indirect, i.e. they arise from correlated exposures to non-financial sectors and financial markets.

De Nicolo and Kwast (2001) measure total interdependencies by the correlations of stock returns of large and complex banking organisations (LCBOs).¹⁰ Since stock prices reflect market participants' collective evaluation of a firms prospects in the future they also include the impact of the firms interdependencies with other institutions.¹¹ Consequently one can assume that an observed increase in correlations among bank stock returns signals an increase in systemic risk potential. No change in correlations or a decrease would therefore lead to the conclusion that the potential of systemic risk has not increased or has declined.

There are several problems that limit the interpretation of correlations among bank stock returns in regard to the potential for systemic risk:

¹⁰ In the United States LCBOs are identified by the Federal Reserve supervisors. For details see De Nicolo and Kwast (2001: 4-5). To my knowledge such a classification does not exist for Europe. Thus, we merely use the group of the largest European banks according to total assets.

¹¹ A quite similar consideration was already made by Pozdena (1991) who regressed the stock returns of various individual banks on each other in each period in order to get evidence for contagious effect.

- In general variations in correlations between returns can have manifold reasons (see e.g., Goetzmann et al., 2001). For example, observed correlations can be higher in periods of high stock return volatilities than when measured in periods of low stock return volatilities even though the underlying correlation is constant (Boyer et al., 1997). As a consequence, De Nicolo and Kwast (2001) estimate a GARCH constant conditional correlation model (Bollerslev, 1990, Longin and Solnik, 1995) with a time trend and test for the significance of the time trend as an indication of an increase in interdependencies – and hence in the systemic risk potential.
- The correlation structure may be sensitive to extreme events such as the October 1987 stock market crash. However, such one-time events will cause only a temporary increase in correlations.
- An increase in the mean correlation in the European sample may be due to a change in investors behaviour in the sense that with the introduction of the Euro investors have started to operate Europe-wide in general.
- An additional problem occurs when using correlations between bank stock returns in an international context, since there are many national factors determining the stock prices and hence the correlations. Thus, on the one hand, high correlations may simply be due to the co-variation in national stock indices or in fundamental economic variables such as interest rates and dividend yields. On the other hand, different developments of national influences may cause lower correlations between stock returns leading falsely to the conclusion that interdependencies have decreased.¹² Consequently, in an international context one needs to control for national determinants of stock returns.

Despite these shortcomings and in consideration of the lack of appropriate data and other analysis tools mentioned above, the analysis of correlations of bank stock returns seems to be an appropriate tool for giving some indication concerning the potential for systemic risk in European banking.

In a first step mean weekly rolling-window correlations of bank stock returns¹³ are calculated for several samples without controlling for national factors. In a further step a return generating model is estimated to control for national factors and

¹² For example, the new law concerning capital profits in Germany will probably lead to a temporary increase in the stock returns of German banks causing higher correlations between German banks whereas at the same time correlations in the European sample will decline.

¹³ More precisely speaking, pairwise rolling-window correlations between weekly bank stock returns are calculated and then for each weekly observation the mean is calculated over these pairwise correlations.

residuals are calculated that do not contain the part of stock returns that is due to national influences. Rolling-window correlations among these adjusted bank stock returns are then taken as a measure for the interdependencies and the systemic risk potential.

This approach addresses most of the above listed problems. By comparing the results for the banking sector to other industries the problem with investors behaviour can to some extent be eliminated. Estimation of the return generating model before calculating correlations eliminates national influences from bank stock returns. Furthermore, this will partially control for events such as the 1987 stock market crash.

3.3 Mean weekly rolling-window correlations of bank stock returns

To start with, correlations between bank pairs from 1980 to 2001 are calculated for a European sample and several national sub-samples using a 52-week rolling window.¹⁴ In this first step no adjustments are made concerning national determinants of stock returns. The samples include the 60 largest European banks according to total assets. For a list of the banks included in the sample see table A1 in the appendix.¹⁵ Thus for the “European” sample that includes all possible pairwise combinations the mean weekly rolling-window correlation was calculated out of 1770 pairwise correlations. The “Europe cross-border only” sample includes only correlations between banks of different countries which gives a number of 1545 pairwise combinations. The mean rolling-window correlations for these two samples are shown in Figure 1a. Figure 1b shows mean rolling window correlations for six national samples.

¹⁴ Weekly stock prices P are taken from Thomson Financial Datastream and returns R calculated by subtracting the logarithmic stock prices, i.e. $R_t = \log(P_t) - \log(P_{t-1})$.

¹⁵ Note that not all bank stock series are available from 1980 on. For the starting dates of the series see also table A1.

*Figure 1a – Mean rolling-window correlations of bank stock returns
(52-week rolling window) – European samples*

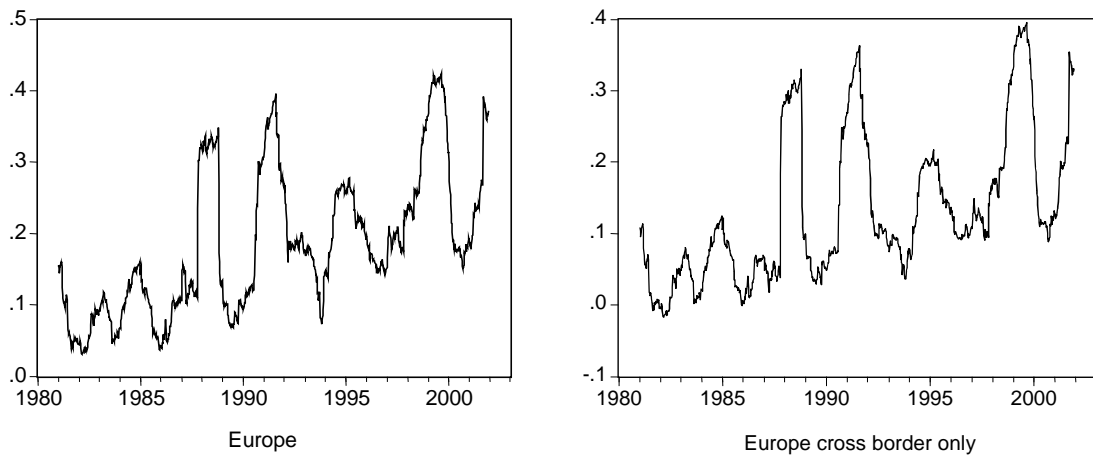

*Figure 1b – Mean rolling-window correlations of bank stock returns
(52-week rolling window) – national samples*

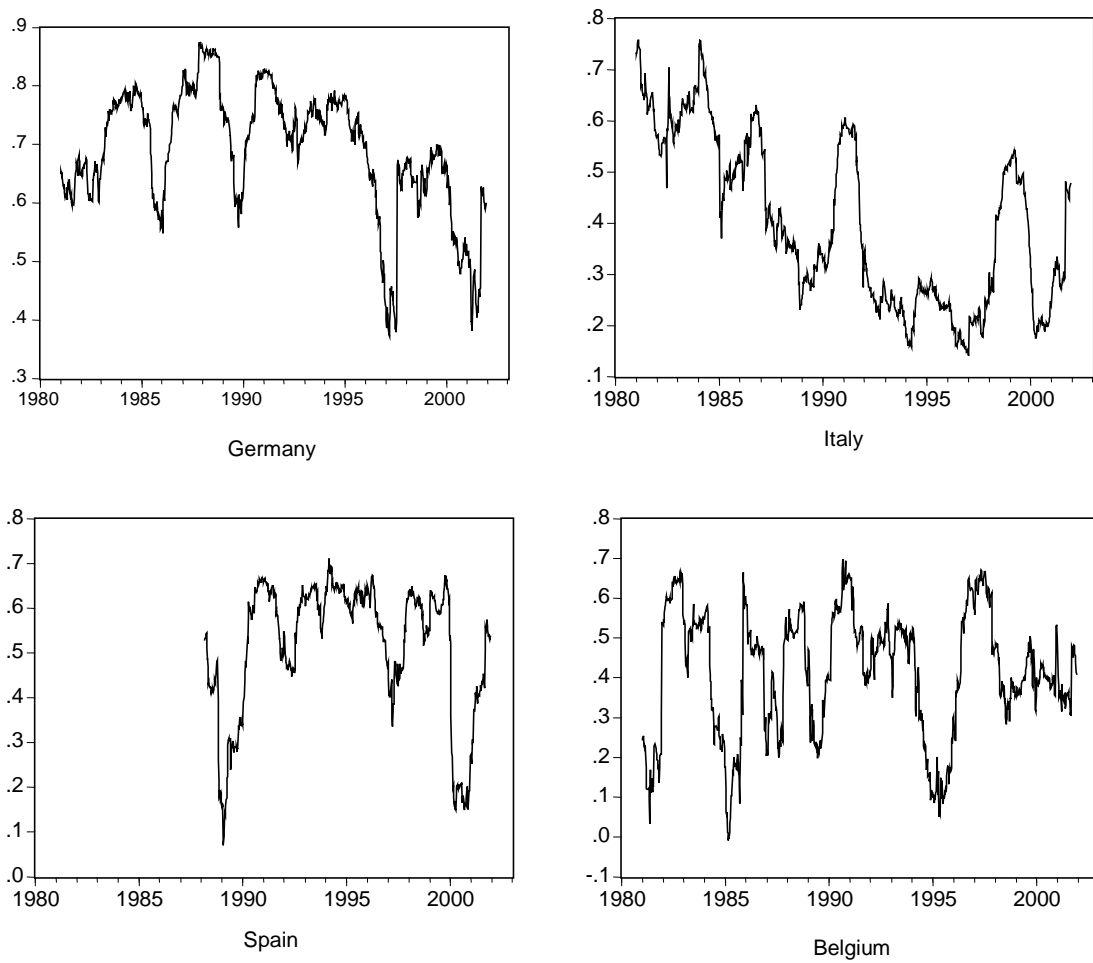

*Figure 1b – Mean rolling-window correlations of bank stock returns
(52-week rolling window) – national samples – continued*

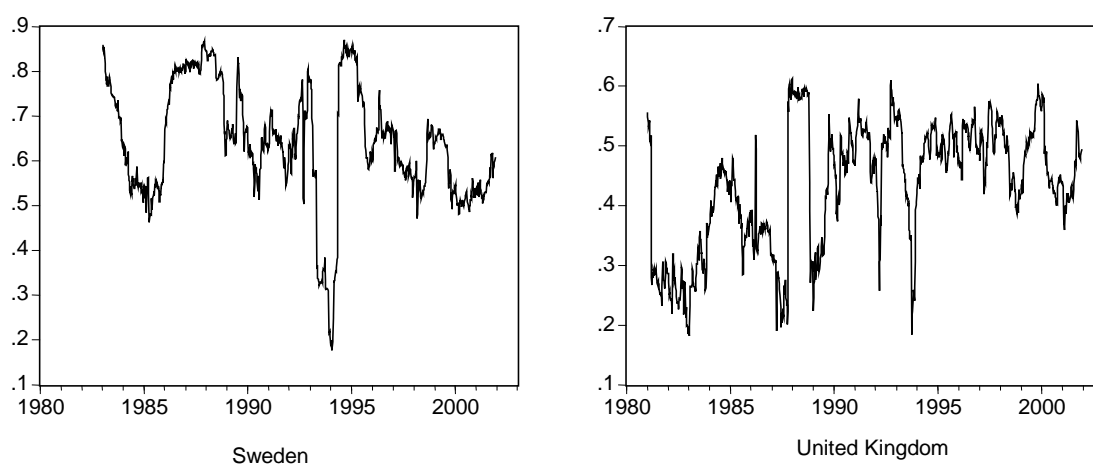

As can be seen from the figures, mean correlations vary heavily over time. Not surprisingly, there are substantial increases in mean correlations in all samples in the time following the stock market crash in 1987. Other peaks can be seen in the beginning and the end of the 1990s which might be due to the Scandinavian banking crisis and the near-failure of the hedge fund Long-Term Capital Management (LTCM) in September 1998 following the Russian crisis, respectively.

The mean correlations in both European samples are substantially lower than in the national samples, especially low are the correlations in the “Europe cross-border only” sample. This is probably due to the fact that national factors determine to quite an amount stock prices and hence returns.

For the European sample the average correlations clearly increase over time, whereas for the national samples the average correlations don’t seem to change over time – or in the case of Germany and Italy they even decrease over time. This indicates increasing interdependencies among European banks and hence gives some preliminary evidence that the potential for systemic risk in European banking may have increased during the last two decades.

Table 2 shows the means of average correlations for the different samples calculated separately for the period before and after the introduction of the Euro.¹⁶

¹⁶ Note that in May 1998 the exchange rates between the EMU member countries were irrevocable fixed. Thus, this date is taken as the starting date of the Euro, although the Euro was officially introduced on January 1, 1999.

Table 2 – Mean correlations of bank stock returns

Period	Europe	Europe cross- border only	Germany	Italy	Spain	Belgium	Sweden	United Kingdom
1980:01 – 1998:04	0.1620	0.1104	0.7117	0.4074	0.5361	0.4178	0.6571	0.4259
1998:05 – 2001:11	0.2887	0.2406	0.5818	0.3652	0.4471	0.3893	0.5677	0.4663

For almost all national samples the mean correlation calculated over the EMU period is lower or at least not higher than the mean correlation calculated over the pre-EMU period. In contrast, the mean correlation of the European samples increased substantially after the introduction of the Euro. This indicates that the Euro and the accompanied financial market integration has led to an increase in correlations among banks at the European level which may indicate an increase in interdependencies among European banks. Possibly, as mentioned above, this increase in correlations may simply be due to a change in investors behaviour. However, looking at figure 1a shows that mean correlations increase over the whole sample period and not just after 1999. In this context comparing the results for the banking sector with other industries may provide additional insight.

Figure 2 shows mean rolling-window correlations between the leading European firms in the consumer goods industry and the car industry, respectively.

Figure 2 – Mean rolling-window correlations of stock returns of other industry firms (52-week rolling window)

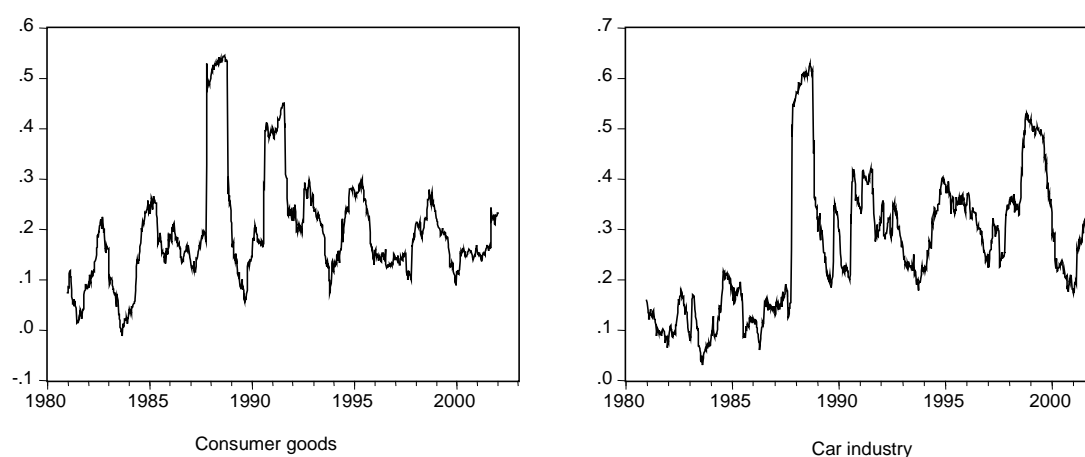

Again, there are relatively high correlations directly after the stock market crash in 1987. Apart from that mean correlations are relatively low over the whole sample period. In contrast to the European banking sample mean correlations do not

increase substantially over time – for the car industry at least not after the peak in 1987.

Up to this point our analysis gives some preliminary evidence that interdependencies among European banks have increased over the past years, and hence that systemic risk potential in Europe has increased.

However, as mentioned above, there is an interpretation problem when correlations are calculated between stock returns without controlling for national influences. Since the aim is to measure systemic risk in a European context controlling for national influences becomes necessary. Ignoring such influences could result, for example, in increasing mean correlation over time that is simply due to increasing correlations of the underlying national determinants of stock returns.

3.4 Further proceeding and methodology

In the following a two step approach is employed: First, to control for national factors influencing stock returns a return generating model is estimated. The return on the aggregate market portfolio and the unanticipated interest rate change are used as determining factors. From these regressions, residuals are calculated that contain the part of the returns that cannot be explained by national factors. Hence, these residuals should contain the part of returns that is priced in due to international influences.

Second, pairwise rolling-window correlations are calculated between these residuals and the mean is calculated over all pairs as an indicator for the interdependencies among European banks, and hence for the systemic risk potential in Europe.

The return generating model – eliminating national influences

Empirical research by, among others, Stone (1974), Flannery and James (1984a,b), Aharony et al. (1986), Sweeney and Warga (1986), Yourougou (1990), Benink and Wolff (2000) has shown that the inclusion of an interest rate factor adds substantial explanatory power to the single-factor market model when explaining bank stock returns. The interest rate variable is important for the valuation of stocks of financial institutions because the accounting returns and costs of financial institutions are directly dependent on interest rates.¹⁷ The interest rate sensitivity depends on the characteristics of the bank's asset and liability positions. In the literature the following two-factor return generating model is usually estimated:

¹⁷ An additional argument in favour of the inclusion of the interest rate variable is that within EMU the convergence – and after the introduction of the Euro the equality – of money market rates would lead to an increase in the correlations of unadjusted stock returns.

$$R_{it} = \beta_{oi} + \beta_{mi}MR_t + \beta_{li}UI_t + \varepsilon_{it}. \quad (1)$$

Where R_{it} is the rate of return on the stock of bank i at time t , MR_t is the rate of market return, UI_t the unexpected change in interest rate levels, and ε_{it} the error term.

The unexpected change in interest rates serves as the second factor in the model since in efficient financial markets, the expected value of the relevant interest variable will have already been reflected in asset values and returns. Hence, only the unexpected component should have an effect on asset returns (Choi et al., 1992). The forecasting error from an ARIMA model is used as the unexpected change in interest rate.

The aim of the estimation of the return generating model in the context of this paper is to exclude all national influences on bank stock returns that may limit interpretation of the following correlation analysis. If the model is estimated according to (1), i.e. bank stock returns are regressed on a respective national stock market index and a national interest rate, European influences that effect national indexes are also excluded. However, such influences, for example, common shocks, may cause systemic risk at the European level. The residuals from equation (1) do not contain such European influences.

Therefore the following adjustment to the above two-factor model are made. Equation (1) is extended by the return of a European index (European market return: EMR). Thus, the following return generating model is estimated:

$$R_{it} = \beta_{oi} + \beta_{mi}MR_t + \beta_{ei}EMR_t + \beta_{li}UI_t + \varepsilon_{it}. \quad (2)$$

As a consequence, the coefficient β_{ei} represents the influence of the European market on the individual bank stock return and therefore this influence is excluded from the national market return.¹⁸

The part of the bank stock return that is not due to national influence is calculated as

$$\tilde{R}_{it} = R_{it} - \beta_{oi} - \beta_{mi}MR_t - \beta_{li}UI_t \quad (3)$$

¹⁸ Clearly, there exists multicollinearity between the regressors MR_t and EMR_t . However, this only limits hypothesis testing but does not influence our proceeding since we are only interested in eliminating national influences from stock returns.

In a following step pairwise rolling-window correlations between these residuals \tilde{R}_{it} are calculated as a measure for the interdependencies among European banks, and hence as an indication for the potential of systemic risk in Europe.

The data

For a list of the banks included in the sample see table A1 in the appendix. Unfortunately, for Greece and Denmark interest rate data and data on market returns were incomplete. Thus, banks from these countries were dropped from the sample of the 60 largest European banks. This reduces the sample size to 54 banks from the countries Germany, France, the Netherlands, Spain, Italy, Ireland, Austria, Belgium, Portugal, Sweden, Switzerland, Norway, and the United Kingdom.

Bank stock prices are taken from Thomson Financial Datastream – more precisely the return indexes are used that show a theoretical growth in value of a share holding, assuming that dividends are re-invested to purchase additional units of an equity. Returns R_{it} are then calculated as the logarithmic differences between two values of the return index.

National market returns MR_t are calculated using the MSCI National Stock Indexes that can be downloaded from the MSCI webpage. The European index EMR_t is also taken from the MSCI database. All indexes used are performance indexes, i.e. their calculation corresponds with the return indexes taken for the bank stocks. The unanticipated change in interest rates UI_t is calculated using the money market rate taken from the IMF's International Financial Statistics.

In contrast to the correlation analysis in section 3.3 monthly data is used since the MSCI National Stock Indexes are only available on a monthly basis for longer periods. The sample period is between January 1980 and July 2001.

3.5 Estimation

Estimation of unanticipated changes in interest rates

In order to generate the monthly observations of unexpected changes in the interest rate UI_t for every country an ARIMA($p, 1, q$) methodology of the general form

$$\Phi(B)\Delta I_t = \mu + \Theta(B)z_t \quad (4)$$

is used. Where ΔI_t represents the first difference of the money market interest rate series I_t and z_t is a shock term.¹⁹ B is the back-shift operator and $\Phi(B)$ and $\Theta(B)$ represent the autoregressive (AR) and moving average (MA) components, respectively.

The particular orders p and q of the AR and MA components, respectively, were chosen according to the minimum Schwarz-criterion. The particular ARIMA models estimated for every country with the respective estimation results are shown in table A2 in the appendix.

The unexpected component of the interest rates is determined by subtracting the predicted values in equation (4) from the actual values. Hence,

$$UI_t = I_t - E(I_t) \quad (5)$$

where $E(I_t)$ is the expected interest rate, predicted by the ARIMA model.

Estimation of the return generating model

Since for most of the countries there is more than one bank in the sample estimation of equation (2) can be accomplished in different ways. Obviously, a single equation framework would disregard the fact that bank stock returns are interrelated. On the European level these interdependencies contribute to the systemic risk potential that is assessed by calculating rolling-window correlations. To control for these interdependencies in the estimation procedure would therefore not be appropriate in the context of this paper. However, it should be controlled for such interdependencies among banks within one country. Thus, for every country equation (2) is estimated in a panel with fixed effects using least squares.²⁰ The estimation results for these regressions are shown in table 3.

¹⁹ Unit root tests indicated that all money market rates are I(1) series.

²⁰ As a consequence, there is a fixed effect coefficient β_{oi} estimated for every bank (which is not reported in table 3) and one coefficient on the national market return, the European market return and the interest rate change for every country, respectively. Note that estimation was done with the computer package Eviews, that computes the fixed effects by subtracting the “within” mean from each variable and estimating OLS using the transformed data.

Table 3 – Estimation results of the return generating model for every country

Country	Number of banks included in the panel	β_{mi}	β_{ei}	β_{li}	adj.R ²	DW
Germany	4	1.002 (23.094)**	0.068 (1.241)	-0.002 (-0.367)	0.59	2.12
France	2	1.148 (7.319)**	0.001 (0.004)	0.010 (1.062)	0.48	2.06
The Netherlands	1	1.322 (6.469)**	-0.037 (-0.181)	0.000 (0.016)	0.58	2.23
Spain	4	0.904 (16.874)**	0.097 (1.282)	0.003 (0.908)	0.55	2.21
Italy	18	0.677 (26.243)**	0.142 (3.613)**	0.022 (7.609)**	0.33	2.04
Ireland	2	0.920 (11.949)**	0.127 (1.300)	0.000 (0.057)	0.48	2.06
Austria	1	0.759 (4.006)**	0.052 (0.225)	-0.039 (-0.665)	0.36	2.05
Belgium	3	0.908 (17.267)**	0.004 (0.067)	-0.005 (-1.964)	0.49	2.24
Portugal	2	0.774 (11.057)**	-0.016 (-0.160)	-0.002 (-0.453)	0.41	2.16
Sweden	4	0.598 (7.728)**	0.226 (1.779)	-0.003 (-3.654)**	0.25	1.81
Switzerland	2	1.043 (13.259)**	0.241 (2.830)**	0.000 (0.117)	0.53	2.17
Norway	2	0.467 (3.188)**	0.078 (0.370)	-0.039 (-5.313)**	0.25	1.98
United Kingdom	9	0.681 (7.671)**	0.309 (3.120)	-0.001 (-0.310)	0.28	1.98

Fixed effects panel estimation of the model $R_{it} = \beta_{oi} + \beta_{mi}MR_t + \beta_{ei}EMR_t + \beta_{li}UI_t + \varepsilon_{it}$ using least squares. The fixed effect coefficients β_{oi} are not reported. *t*-statistics are indicated between parentheses. One (two) asterisk(s) indicate significance at the 0.05 (0.01) level.

As expected the coefficient on the national market return β_{mi} is highly significant for every country. It usually lies between 0.6 and 1.0 which indicates a moderate impact on the return of the respective national market index on bank stock returns. The coefficient associated with the interest rate change β_{li} is insignificant in most of the cases. Only for Italy, Sweden and Norway β_{li} is significantly different from zero.

This is partly in line with former research that found for the US decreasing interest rate sensitivity of bank stock returns in the late 1980s and early 1990s (Choi and Elyasiani, 1996, Benink and Wolff, 2000).

The coefficient on the European market return is – with the exception of Italy and Switzerland – insignificant for all countries. However, since our aim is not to explain bank stock returns but rather to eliminate all national influences the insignificance of this coefficient is not decisive.²¹ Also, adjusted R-squares are relatively low compared to multi-factor-model regressions in the literature (Flannery and James, 1984a, 1984b, Sweeney and Warga, 1986, Yourougou, 1990, Saunders and Yourougou, 1990). Again, with respect to the aim of the regressions this is irrelevant.

In a further step the estimation results of the return generating model are used to calculate the part of the bank stock returns \tilde{R}_{it} that could not be explained by national factors (see equation (3) above).

3.6 New Evidence for systemic risk potential in Europe – Correlation results

In the second step of the analysis, rolling-window correlations between the adjusted stock returns \tilde{R}_{it} of the 54 European banks are calculated over the whole sample period from March 1980 to July 2001.²² A 12-month backward looking window is used. From these 1431 pairwise rolling-window correlations the mean is calculated as an indication for the development of the interdependencies among European banks, and hence of the potential for systemic risk in European banking. Figure 3a shows this mean rolling-window correlation for the whole sample of 54 banks. Figure 3b shows the mean of all pairwise rolling-window correlations between banks of different countries, i.e. the mean cross-border correlation.²³ Unfortunately, prior to 1986 bank stock return data is relatively scarce. As a consequence, the mean correlation is dominated by a few outliers, which leads to some peaks that cannot be explained by economic reasoning. Thus, we report in figures 3a and 3b mean rolling-window correlations for the time after 1986.

²¹ Note that low t-statistics may also be a result of the multicollinearity between MR_t and EMR_t , that can cause high variances of the OLS estimates.

²² Some data at the beginning of the sample period are lost due to the ARIMA estimations.

²³ In this “cross-border only”-case the mean correlation is calculated on the basis of 1216 pairwise rolling-window correlations.

Figure 3a – Mean 12-month-rolling-window correlations of European bank stock returns after controlling for national factors – whole sample of 54 banks

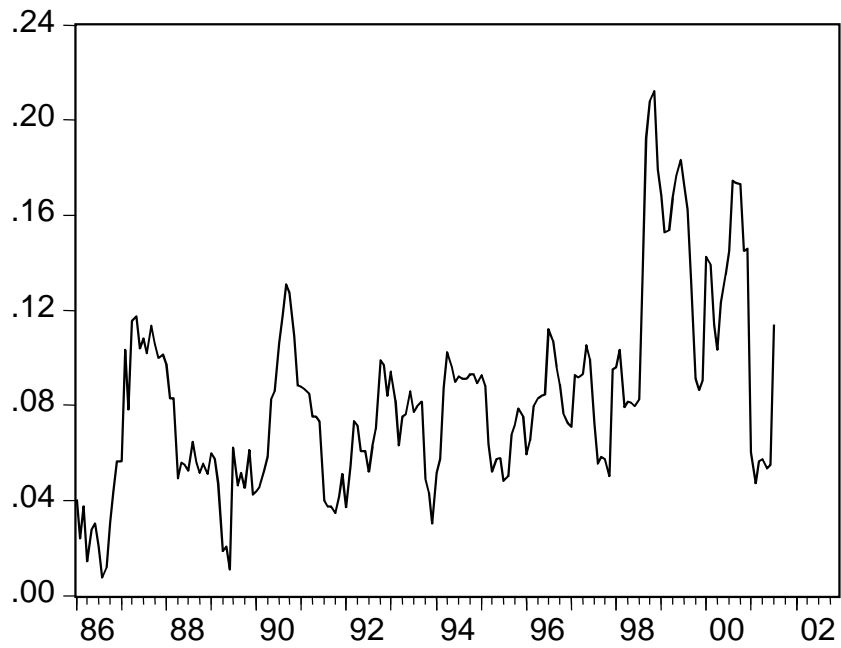
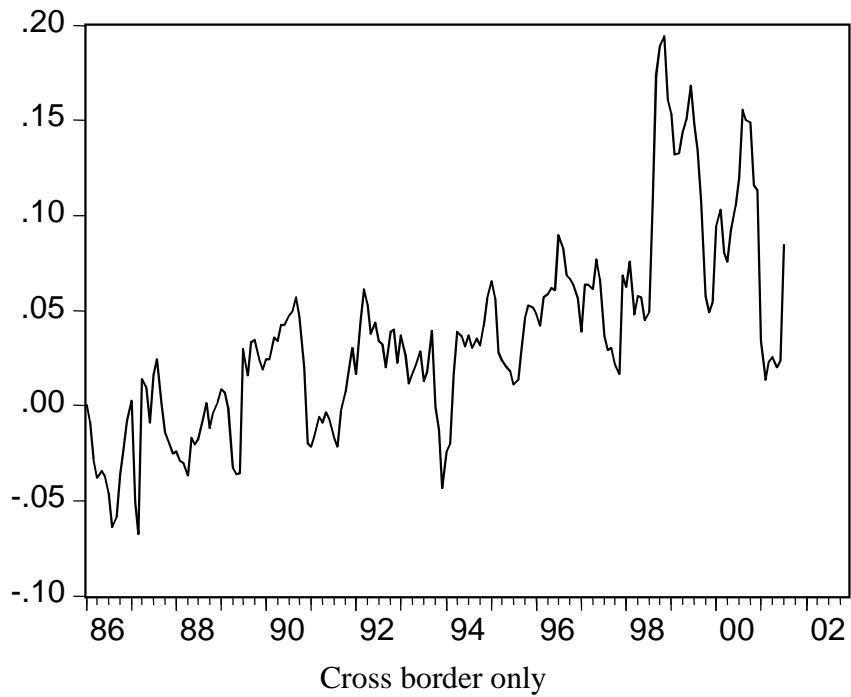

Figure 3b – Mean 12-month-rolling-window correlations of European bank stock returns after controlling for national factors – only cross-border correlations included



After controlling for national factors mean correlations vary less heavily over time. Not surprisingly, correlations in the sample where only cross-border correlations are taken into account (figure 3b) are smaller than in the sample with all pairwise correlations. As expected, the increase in mean correlation in response to the stock market crash in 1987 is less pronounced, since the respective national market return in the return generating model controls for this event.

The temporary increases in mean correlations in the early 1990s are probably due to banking crisis in some European countries: Norway 1987-93, Sweden 1990-93, Finland 1991-94 and Italy 1990-94 (Demirgüç-Kunt and Detragiache, 1998). These peaks are less pronounced in the “cross-border only”-sample which shows that the increases are mainly due to high correlations between stock returns of banks within one country. This indicates that at the beginning of the 1990s the threat of contagion across countries was relatively moderate.

A substantial increase in mean correlations can be observed around 1999. This is probably a result of the near-failure of the hedge fund Long-Term Capital Management (LTCM) in September 1998 that followed the Russian crisis. This peak is also considerable in the “cross-border only”-sample which indicates that in the late 1990s the threat of contagion across countries existed to a greater amount than at the beginning of the 1990s.

Overall there is evidence that mean correlations have increased in the past 15 years. Table 4 shows the results of a simple least squares regression of the mean correlations on a constant and a time trend.

Table 4 – Regressions of mean correlations on a constant and a time trend

<i>Sample</i>	<i>Number of pairwise combinations</i>	<i>Sample period</i>	<i>Intercept</i>	<i>Time trend</i>
Whole sample	1431	1986:01 – 2001:07	0.0236 (3.185)**	0.0004 (8.462)**
Cross border correlations only	1216	1986:01 – 2001:07	-0.0732 (-9.829)**	0.0007 (15.467)**

t-statistics are indicated between parentheses. One (two) asterisk(s) indicate significance at the 0.05 (0.01) level.

For both samples the coefficient associated with the time trend is highly significant. For the sample where the mean was calculated from cross-border correlations only, the time trend coefficient is even higher than for the sample where correlations between banks of the same country were also taken into account.

In summary this analysis provides some evidence that interdependencies among European banks of different countries have become stronger within the past 15 years. Thus, the potential for systemic risk in banking has increased at the European level.

However, absolute mean correlations among stock returns of European banks from different countries still are relatively low compared with correlations in the national samples (see figure 1b). At the European level (figure 3b) mean correlations range from a low of -0.068 to a high of 0.194 with a mean of 0.035. For the national samples mean correlations often reach values of up to 0.7 or even as high as 0.9. This indicates that the threat of systemic risk is still higher at a national level than at the European level. Unfortunately, we cannot make a more exact statement concerning the absolute threat of systemic risk at the European level compared to the national level. Nevertheless, the analysis above provides evidence that the potential for systemic risk in European banking has increased within the past 15 years. This indicates that at least to some extent a shift of systemic risk from the national level to the European level has occurred.

4 Conclusion

The analysis in this paper attempts to answer the question whether the threat of systemic risk in banking is a national threat or rather a Europe-wide threat. Following De Nicolo and Kwast (2001), mean rolling-window correlations between bank stock returns are used as a measure for the interdependencies among European banks, and hence for the systemic risk potential in Europe. At first, weekly rolling-window correlations are calculated between bank stock returns without controlling for national factors. These give evidence that interdependencies have increased within the last two decades. However, since national factors determine to a large extent stock returns this result can only be seen as preliminary.

Thus, in the second part of the analysis we estimate a return generating model in order to eliminate national influences from bank stock returns. Thereafter, rolling-window correlations are calculated using the adjusted bank stock returns. Again, we find evidence that interdependencies among European banks have increased over the last 15 years. This indicates that there has been a shift in the systemic risk potential from a national level to a European level.

However, there are several caveats of our study. Mainly, there are a number of shortcomings of the correlation approach that limit interpretation. Furthermore, no direct comparison can be made between the potential of systemic risk at the national level and the European level. The analysis allows merely for statements concerning the development of the threat of systemic risk over time. Nevertheless, recalling the

lack of empirical studies in particular for Europe and the lack of data available on interbank lending at an international level the analysis in this paper is appropriate.

The evidence on the rise in systemic risk potential found for Europe provides an argument in favour of Europe-wide banking regulation and supervision. Whether the existing forms of cooperation between the national authorities is an appropriate way in securing financial stability or whether a single European supervisor is needed is up to further research.

References

- Aharony, J., A. Saunders and I. Swary (1986), The Effects of a Shift in Monetary Policy Regime on the Profitability and Risk of Commercial Banks, *Journal of Monetary Economics* 17, 363-377.
- Aharony, J. and I. Swary (1983), Contagion Effects of Bank Failures: Evidence from Capital Markets, *Journal of Business* 56 (3), 305-322.
- Akhigbe, A. and J. Madura (2001), Why do contagion effects vary among bank failures?, *Journal of Banking & Finance* 25, 657-680.
- Angelini, P., G. Maresca and d. Russo (1996), Systemic risk in the netting system, *Journal of Banking & Finance* 20, 853-868.
- Bartholomew, P. F. and G. W. Whalen (1995), Fundamentals of systemic Risk, in Kaufman, G. (ed.), *Banking, Financial Markets, and Systemic Risk*, Greenwich, 3-18.
- Benink, H. and C. Wolff (2000), Survey data and the interest rate sensitivity of US bank stock returns, *Economic Notes* 29 (2), 201-213.
- Bessler, W. and T. Nohel (2000), Asymmetric information, dividend reductions, and contagion effects in bank stock returns, *Journal of Banking & Finance* 24, 1831-1848.
- Bollerslev, T. (1990), Modelling the Coherence in Short-Run Nominal Exchange Rates: A Multivariate Generalized Arch Model, *The Review of Economics and Statistics* 72 (3), 498-505.
- Boyer B. H., M. S. Gibson and M. Loretan (1999), Pitfalls in Tests for Changes in Correlations, Board of Governors of the Federal Reserve System International Finance Discussion Papers No. 597, Washington DC.
- Canoy, M., M. van Dijk, J. Lemmen, R. de Mooij and J. Weigand (2001), *Competition and Stability in Banking*, CPB Document No 015, The Hague.

- Choi, J. J. and E. Eyasiani (1996), Derivate Exposure and the Interest Rate and Exchange Rate Risks of U.S. Banks, University of Pennsylvania Working Paper No. 96-53, Pennsylvania.
- Choi, J. J., E. Eyasiani and K. J. Kopecky (1992), The sensitivity of bank stock returns to market, interest and exchange rate risks, Temple University, Philadelphia.
- Davis, E. P. (1992), *Debt, Financial Fragility, and systematic Risk*, Oxford.
- De Bandt, O. and P. Hartmann (2000), Systematic Risk: A Survey, ECB Working Paper No. 35, Frankfurt.
- De Nicolo, G. and M. L. Kwast (2001), Systemic Risk and Financial Consolidation: Are they related?, The Federal Reserve Board Financial and Economic Diskussion Paper No. 33, Washington DC.
- Demirgüç-Kunt, A. and E. Detragiache (1998), The Determinants of Banking Crises in Developing and Developed Countries, *IMS Staff Papers* 45 (1), 81-109.
- Diamond, D. W. and P. H. Dybvig (1983), Bank Runs, Deposit Insurance, and Liquidity, *The Journal of Political Economy* Vol. 91(3).
- Dornbusch, R., Y. C. Park and S. Claessenes (2000) Contagion: How it spreads and how it can be stopped, Forthcoming World Bank Research Observer 2000.
- Flannery, M. J. and C. M. James (1984a), The Effect of Interest Rate Changes on the Common Stock Returns of Financial Institutions, *The Journal of Finance* 39 (4), 1141-1153.
- Flannery, M. J. and C. M. James (1984b), Market Evidence on the Effective Maturity of Bank Assets and Liabilities, *Journal of Money, Credit and Banking* 16 (4.1), 435-445.
- Furfine, C. H. (1999), Interbank Exposures: Quantifying the Risk of Contagion, BIS Working Paper No. 70.
- Goodhart, C., P. Hartmann, D. Llewellyn, L. Rojas-Suárez and S. Weisbrod (1998), *Financial Regulation: Why, how and where now?*, London.
- Goetzmann, W. N., L. Li and K. G. Rouwenhorst (2001), Long-Term Global Market Correlations, Yale School of Management Paper, New Haven.
- Humphrey, D. B. (1986), Payments Finality and Risk of Settlement Failures, in Saunders, A. and L. White (eds.), *Technology, and the Regulation of Financial Markets; Securities, Futures, and Banking*, Lexington, 97-120.
- Kaufmann, G. G. (1994), Bank Contagion: A Review of the Theory and Evidence, *Journal of Financial Services Research* 17 , 123-150.
- Kaufmann, G.G. (1995), Comments on Systemic Risk, in Kaufman, G. (ed.), *Banking, Financial Markets, and Systemic Risk*, Greenwich, 47-54.

- Kaufmann, G. G. (1996), Bank Failures, Systematic Risk, and Bank Regulation, *The Cato Journal* 16 (1).
- Kaufmann, G. G. and K.E. Scott, (2000), Does Bank Regulation Retard or Contribute to Systemic Risk?, Stanford Law School Working Paper No. 211, Stanford.
- Longin, F. and B. Solnik (1995), Is the correlation in international equity returns constant: 1960-1990? *Journal of International Money and Finance* 14 (1), 3-26.
- Michael, I. (1998), Financial Interlinkages and Systemic Risk, *Financial Stability Review* 4, Spring, 26-33.
- Pozdena (1991), Is Banking Really Prone to Panics?, *FRBSF Weekly Letter* No. 91-35.
- Saunders, A. and P. Yourougou (1990), Are Banks Special? The Separation of Banking from Commerce and Interest Rate Risk, *Journal of Economics and Business* 42, 171-182.
- Schoenmaker, D. (1996), Contagion Risk in Banking, L.S.E. Financial Markets Group Discussion Paper, No. 239, London.
- Sheldon G. and M. Maurer (1998), Interbank Lending and Systemic Risk: An Empirical Analysis for Switzerland, *Swiss Journal of Economics and Statistics* 134 (4.2), 685-704.
- Slovin M. B., M. E. Sushka and J. A. Polonchek (1999), An analysis of contagion and competitive effects at commercial banks, *Journal of Financial Economics* 54, 197-225.
- Staub, M. (1999), *Aspects of Systematic Risk in Banking: Inter Bank Loans, Optimal Bank Size and the Swiss Regional Bank Crisis*, Basel.
- Stone, B. K. (1974), Systematic Interest Rate Risk in a Two-Index Model of Returns, *The Journal of Financial and Quantitative Analysis* 9 (5), 709-722.
- Swary, I. (1986), Stock Market Reaction to Regulatory Action in the Continental Illinois Crisis, *Journal of Business* 59 (3), 451-473.
- Sweeney, R. J. and A. D. Warga (1986), The Pricing of Interest-Rate Risk: Evidence from the Stock Market, *The Journal of Finance* 41 (2), 393-410.
- Yourougou, P. (1990), Interest-Rate Risk and the Pricing of Depository Financial Intermediary Common Stock, *Journal of Banking and Finance* 14, 803-820.

Appendix

Table A1 – Banks included in the samples

	<i>Name of the bank</i>	<i>Country</i>	<i>Data available since</i>
1	Deutsche Bank	Germany	01/1980
2	HypoVereinsbank	Germany	01/1980
3	Dresdner Bank	Germany	01/1980
4	Commerzbank	Germany	01/1980
5	BNP Paribas	France	10/1993
6	Société Générale	France	07/1987
7	ABN Amro	The Netherlands	09/1990
8	BSCH Santander	Spain	03/1987
9	BBV Argent..	Spain	03/1988
10	Banco Popular	Spain	03/1987
11	Bankinter	Spain	03/1987
12	Intesa BCI	Italy	01/1980
13	Unicredito Italiano	Italy	01/1980
14	San Paolo IMI	Italy	04/1992
15	Banca di Roma	Italy	01/1980
16	Monte die Paschi di Siena	Italy	06/1999
17	Banca Nazionale del Lavro	Italy	09/1998
18	Rolo Banca	Italy	02/1992
19	BIPOP- Carire	Italy	01/1986
20	Banca Popular di Verona	Italy	06/1998
21	Banca Popular di Bergamo	Italy	01/1986
22	Banca Popular di Milano	Italy	01/1986
23	Banca Lombarda	Italy	01/1986
24	Banca Popular di Lodi	Italy	01/1986
25	Banca Popular di Novara	Italy	01/1986
26	Banca Popular dell Emilia Rom.	Italy	12/1991
27	Banca Fideuram	Italy	01/1987
28	Banca Pop. Com. e Industr.	Italy	01/1986
29	Banca Popular di Sondrio	Italy	08/1995
30	Bank of Ireland	Ireland	01/1980

Note: Included are the 60 largest European banks according to total assets in 1999. Source: www.manager-magazin.de. Sorted by country.

Table A1 – Banks included in the samples – continued

<i>Name of the bank</i>	<i>Country</i>	<i>Data available since</i>
31 Allied Irish Banks	Ireland	01/1980
32 Erste Bank	Austria	12/1997
33 Almanij	Belgium	01/1980
34 Dexia	Belgium	11/1996
35 KBC	Belgium	01/1980
36 Banco Comercial Portuges	Portugal	01/1988
37 Banco Espírito Santo	Portugal	10/1992
38 Nordea	Sweden	12/1997
39 SEB	Sweden	01/1982
40 Svenska Handelsbanken	Sweden	01/1982
41 Förenings Sparbanken	Sweden	06/1995
42 UBS	Switzerland	01/1980
43 Julius Bär	Switzerland	10/1980
44 Den Norske Bank (DNB Hldg)	Norway	09/1992
45 Sparbanken Nord-Norge	Norway	09/1995
46 HSBC	United Kingdom	07/1992
47 Royal Bank of Scotland	United Kingdom	01/1980
48 Barclays Bank	United Kingdom	01/1980
49 HBOS (Halifax & Bank of Scotland)	United Kingdom	05/1997
50 Abbey National	United Kingdom	07/1989
51 Standard Chartered	United Kingdom	01/1980
52 Alliance & Leicester	United Kingdom	04/1997
53 Northern Rock	United Kingdom	09/1997
54 Lloyds TSB	United Kingdom	12/1995
55 Den Danske Bank	Denmark	01/1980
56 National Bank of Greece	Greece	01/1988
57 EFG Eurobank	Greece	01/1988
58 Commercial Bank of Greece	Greece	01/1988
59 Bank of Piraeus	Greece	04/1988
60 Alpha Bank	Greece	01/1988

Note: Included are the 60 largest European banks according to total assets in 1999. Source: www.manager-magazin.de. Sorted by country.

Table A2 – Estimation results of the ARIMA(p, I, q) models for the national interest rates

Country	AR components					MA components			
	μ	ϕ_1	ϕ_2	ϕ_3	ϕ_4	ϕ_5	θ_1	θ_2	θ_3
Germany	-0.025 (0.025)	1.292 (0.072)**	-0.698 (0.063)**				-1.162 (0.091)**	0.625 (0.107)**	0.170 (0.070)**
France	-0.041 (0.044)	-1.007 (0.020)**	-0.935 (0.019)**				1.275 (0.067)**	1.181 (0.075)**	0.171 (0.065)**
The Netherlands	-0.027 (0.029)	-0.144 (0.126)	-0.440 (0.111)**				0.145 (0.136)	0.598 (0.102)**	0.220 (0.070)**
Spain	-0.040 (0.057)	0.769 (0.062)**	-0.953 (0.075)**	-0.085 (0.096)	-0.035 (0.073)	-0.119 (0.058)**	-0.988 (0.015)**		
Italy	-0.054 (0.039)	0.188 (0.061)**							
Ireland	-0.045 (0.014)**	0.471 (0.108)**	0.338 (0.124)**	-0.179 (0.092)	-0.036 (0.090)		-1.162 (0.097)**	0.727 (0.153)**	-0.611 (0.092)**
Austria	-0.033 (0.028)	-0.126 (0.287)	-0.443 (0.237)	0.650 (0.268)*	-0.010 (0.061)	0.086 (0.060)	0.076 (0.281)	0.470 (0.216)*	-0.684 (0.285)*
Belgium	-0.033 (0.027)	1.595 (0.174)**	-1.104 (0.247)**	0.397 (0.134)**	-0.256 (0.072)**		-1.981 (0.181)**	1.427 (0.312)**	-0.250 (0.179)
Portugal	-0.050 (0.032)						-0.129 (0.060)*	-0.255 (0.060)**	

Estimation of the ARIMA(p, I, q) model $(1 - \phi_1 B - \phi_2 B^2 - \phi_3 B^3 - \phi_4 B^4 - \phi_5 B^5) \Delta I_t = \mu + (1 - \theta_1 B - \theta_2 B^2 - \theta_3 B^3) z_t$. Where ΔI_t represents the differencing of the money market interest rate series I_t , and z_t is a shock term. B is the back-shift operator and $\Phi(B)$ and $\Theta(B)$ represent the autoregressive (AR) and moving average (MA) components, respectively. Standard errors are given in parenthesis. One (two) asterisk(s) indicates significance at the 0.05 (0.01) level. Cells left blank indicate that the respective AR and/or MA component was not part of the model that was selected according to the minimum Schwarz-criterion.

Table A2 – Estimation results of the ARIMA(p, I, q) models for the national interest rates – continued

Country	AR components					MA components			
	μ	ϕ_1	ϕ_2	ϕ_3	ϕ_4	ϕ_5	θ_1	θ_2	θ_3
Sweden	-0.034 (0.042)						-0.862 (0.031)**		
Switzerland	-0.006 (0.034)	-2.084 (0.083)**	-1.589 (0.136)**	-0.476 (0.065)**			1.774 (0.085)**	0.796 (0.131)**	-0.019 (0.055)
Norway	0.013 (0.055)	0.092 (0.058)	-0.948 (0.057)**	-0.261 (0.051)**	-0.233 (0.054)**		-0.535 (0.037)**	1.078 (0.037)**	
United Kingdom	-0.030 (0.011)**	0.028 (0.094)	-0.068 (0.066)	0.724 (0.056)**	0.142 (0.061)*		-0.198 (0.072)**	0.024 (0.071)	-0.816 (0.064)**

Estimation of the ARIMA(p, I, q) model $(1 - \phi_1 B - \phi_2 B^2 - \phi_3 B^3 - \phi_4 B^4 - \phi_5 B^5) \Delta I_t = \mu + (1 - \theta_1 B - \theta_2 B^2 - \theta_3 B^3) z_t$. Where ΔI_t represents the differencing of the money market interest rate series I_t , and z_t is a shock term. B is the back-shift operator and $\Phi(B)$ and $\Theta(B)$ represent the autoregressive (AR) and moving average (MA) components, respectively. Standard errors are given in parenthesis. One (two) asterisk(s) indicates significance at the 0.05 (0.01) level. Cells left blank indicate that the respective AR and/or MA component was not part of the model that was selected according to the minimum Schwarz-criterion.

How integrated are the European retail financial markets? A cointegration analysis

Martin Schüler^a and Friedrich Heinemann^b

Abstract

With the introduction of the euro, a single European money market has emerged. Further wholesale financial markets are considered to be highly integrated within the European Union. However, integration in retail financial markets is less advanced. For measuring financial market integration this distinction between wholesale and retail markets becomes crucial. There is a wide literature relating to integration of wholesale financial markets but just a few studies that try to measure integration in European retail markets. This paper, in a first step, gives a systematisation of the literature on measuring financial market integration with a focus on the distinction between wholesale and retail financial markets. In a second step, bivariate and multivariate cointegration techniques are used to assess the degree of integration in four loans and two deposit markets in the European Union. Finally, based on this analysis obstacles to financial market integration are discussed.

JEL-Classification: F36, G15

Keywords: Financial Market Integration, Cointegration, European Union

^a Centre for European Economic Research (ZEW), Mannheim, P.O. Box 103443, D-68034 Mannheim, Germany, Phone: +49/621/1235-148, Fax: +49/621/1235-223, E-mail: schueler@zew.de. The author is also affiliated with WHU, Koblenz.

^b Centre for European Economic Research (ZEW), Mannheim, P.O. Box 103443, D-68034 Mannheim, Germany, Phone: +49/621/1235-149, Fax: +49/621/1235-223, E-mail: heinemann@zew.de.

Acknowledgement: The authors gratefully acknowledge financial support from the Financial Services European Roundtable, Brussels. They also thank Michael Schröder, Herbert Buscher (both ZEW, Mannheim) and Jürgen Weigand (WHU, Vallendar) for helpful comments.

Non-Technical Summary

There is a wide literature that tries to measure integration in financial markets. The results of these studies differ substantially. The predominant part of it is concerned with wholesale financial markets such as the money market and the bond market. They find evidence that these markets are integrated to a high degree. Customers in these markets are able to choose offers from different locations quite easily. With the introduction of a single European currency a single European money market emerged, too. However, in retail financial markets the physical distance to a certain bank still determines to a large extent the preference of the customer. Thus, integration in retail financial markets is lacking behind integration in wholesale markets. So far only a few studies have analysed the degree of integration in the European retail financial market. Our study contributes to this discussion. We analyse four lending markets and two deposit markets by testing for bivariate and multivariate cointegration between national interest rate spreads. Namely we examine mortgage loans to households, consumer loans to households, short-term loans to enterprises, medium and long-term loans to enterprises, time deposits, and savings accounts. The study is conducted for Austria, Belgium, Finland, France, Germany, Ireland, Italy, the Netherlands, Portugal, Spain and the United Kingdom, although not all retail rates are available for every country.

European retail financial markets are characterised by heterogeneity across countries that is caused by, for example, risk differences, cultural influences in bank-client relationship, country-specific strategic bank behaviour in order to cope with informational imperfections such as moral hazard or incentive effects. Consequently, prices will not strictly equalise even in fully integrated markets. The law of one price can hold solely for assets that are perfect substitutes across countries. However, pricing in retail banking will be more closely tied together within an increasingly integrating region. Thus, in integrated markets there should exist a certain long-run relationship between interest rates across countries. Cointegration means that there exists such a long-run relationship between two or more time series. Thus, the existence of cointegration is taken as an indicator for financial market integration.

There are differences across the different markets. We found little cointegration in the market for mortgage loans to households. So far there exists no single European mortgage loans market although there is some evidence for integration in Belgium, Germany, the Netherlands and maybe Spain. The market for consumer loans does not show any sign of integration. The slightly higher degree of integration for mortgages may be explained by the fact that in the mortgage market, for example, monitoring is a smaller problem than in the consumer loans market where also personal bank-customer-relationships probably play a major role.

More integrated seems to be the European market for short-term loans to enterprises. We get also evidence that the market for medium and long-term loans to enterprises is to some extent integrated since we found in almost every second case cointegration. In general, enterprises may borrow money from a bank abroad rather than consumers. Thus, cross-border competition in the markets for loans to enterprises probably is higher than in the markets for mortgage or consumer loans. This puts more pressure on banks in the enterprise loans market to pass a decrease in their cost of funds, i.e. the money market rate to the lenders. In this way financial market integration is fostered and this explains our findings of lower integration in the mortgage and consumer loans market than in the loans markets for enterprises.

For the time deposits market we found some evidence that this market is integrated to a large extent. This seems to be plausible since traditionally time deposits are strongly linked to the money market. With the introduction of a single currency a single European money market emerged which in the case of time deposits may have enforced integration. In addition, compared to savings deposits we found little evidence for integration time deposits are predominantly made by wealthier or even institutional investors that may rather invest in a foreign country than a “normal saver”. Thus, also higher cross-border competition may foster market integration. A possible explanation for the lack of integration in the savings deposit market may be that savings deposits are usually made by savers that attach much importance to a personal customer-bank-relationship. Hence, cross-border competition is probably relatively low hindering integration in this market.

1 Motivation

There is a wide literature that tries to measure integration in financial markets. The results of these studies differ substantially. The predominant part of it is concerned with wholesale financial markets. Clearly, in the context of measuring integration the distinction between wholesale capital markets and retail financial markets becomes crucial. It appears that often this dichotomy between wholesale and retail financial markets is not sufficiently taken into account when assessing the degree of financial market integration.

In general, the existing evidence suggests that the wholesale financial markets such as the money market and the bond market are integrated to a high degree. Customers in these markets are able to choose offers from different locations quit easily. With the introduction of a single European currency a single European money market emerged, too. However, in retail financial markets the physical distance to a certain bank still determines to a large extent the preference of the customer. Thus, integration in retail financial markets is lacking behind integration in wholesale markets.

In 1988, the Cecchini-Report (Commission of the European Communities, 1988) gave evidence of substantial fragmentation of the European financial services markets since it found substantial price differentials. In addition, potential benefits arising for the consumers with further integration were estimated. In order to realise some of these benefits the second banking directive was implemented in 1993 and formally a single European banking market was established.

So far only a few studies have analysed the degree of integration in the European retail financial market coming to the result that retail markets are still to a large amount fragmented. Our study contributes to this discussion by extending the study by Sander and Kleimeier (2001). We examine four loans markets and two deposit markets using bivariate and multivariate cointegration techniques.

The paper is organised as follows: Section 2 gives a systematisation of the existing literature for measuring financial market integration in general considering the distinction between wholesale and retail financial markets. In section 3, the degree of integration in six financial retail markets is assessed. Finally, based on the results of the cointegration analyses obstacles to integration in the market for financial services are discussed.

2 Measuring financial market integration – a systematisation

Perfect financial integration is given if national borders do not play any role for cross-border financial transactions. Since the extreme cases of perfect integration and no integration are only of theoretical interest, the aim of the following analysis is to assess the degree to which financial markets are integrated.

Financial market integration can be measured directly or indirectly. Direct approaches target at the identification of regulatory and economic barriers to international capital mobility¹. Indirect approaches relate to the observable consequences of existing barriers and are either quantity or price related.²

Table 1 gives a systematisation of the different approaches to measure financial market integration with regard to the distinction between wholesale and retail financial markets. The contrasting results of existing studies emphasise the importance of this distinction.

2.1 Quantity concepts

The most widely known quantity measure involves looking at correlations between saving and investment proposed by Feldstein and Horioka (1980).³ This test is based on the following idea: In a world with fully integrated capital markets and a single world interest rate, domestic investment is independent of domestic saving since it can be financed by foreign saving. If capital is perfectly mobile a shortfall in domestic saving in one country should not increase the domestic real interest rate or crowd out investment, since borrowing from abroad at the world interest rate is possible. Therefore, low (high) correlations indicate high (low) international capital mobility.

¹ The Annual Report on Exchange Arrangements and Exchange Restrictions of the IMF lists barriers to international capital flows for all IMF member countries. Beside those official restrictions there are, of course, a lot of other barriers, such as differences in language and culture or information asymmetries. To know of such barriers is certainly important when talking about how integrated financial markets are. However, this information is not easily interpreted since the importance of specific barriers is not known (Goldstein and Mussa, 1993).

² Schulze and Ursprung (1999) differentiate in that way when measuring globalisation.

³ For a good discussion of the Feldstein-Horioka-study see e.g. Heinemann and Stirböck (1999).

Table 1: Measuring financial market integration

		Indirect approaches	
Direct approaches		II Price measures	III Quantity measures
I Identification of regulatory and economic barriers			
<p>A Integration of financial markets (focus on wholesale markets)</p>	<p>Barriers relevant for transactions among professional financial market actors, such as existence of capital controls, regulatory impediments, information costs, transaction costs (IMF, The Annual Report on Exchange Arrangements and Exchange Restrictions)</p>	<p>Price equalisation for financial market assets (law of one price)</p> <ul style="list-style-type: none"> - <i>Interest rate parity conditions</i> (Frankel, McArthur, 1988, Frankel, 1993, Lemmen/Eijffinger, 1993, Eijffinger/Lemmen, 1995, Lemmen/Eijffinger, 1995) - <i>Cointegration of interest rates</i> (Centeno/Mello, 1999) - <i>Stock Market Integration</i> using <ul style="list-style-type: none"> - <i>Uncovered interest parity</i> (Fratzschner, 2001) - <i>Arbitrage pricing theory</i> (Ferson/Harvey, 1991, Bekaert/Harvey, 1995, Dumas/Sohnik, 1995, Hardouvelis et al., 1999) - <i>Distance between sets of stochastic discount factors</i> (Chen/Knez, 1995, Ayuso/Blanco, 2000) 	<ul style="list-style-type: none"> - <i>Saving-Investment-Correlations</i> (Feldstein/Horioka, 1980, Feldstein, 1982, Obstfeld, 1985, Sumner, 1988, Sinn, 1992, Taylor, 1994, 1996, Lemmen/Eijffinger, 1995) - <i>Consumption-Correlations</i> (Obstfeld, 1989, 1994 1995, Mace, 1991, Lemmen/ Eijffinger, 1995, Bayoumi/MacDonald, 1995, Olivei, 2000)
<p>B Integration of financial services markets (focus on retail markets)</p>	<p>Barriers relevant for transactions between financial enterprises and private consumers , such as existence of capital controls, regulatory impediments, information costs, transaction costs (IMF, The Annual Report on Exchange Arrangements and Exchange Restrictions)</p>	<p>Price equalisation for financial services (law of one price)</p> <ul style="list-style-type: none"> - Cecchini-Report - <i>Cointegration of interest rates</i> (Centeno/Mello, 1999, Kleimeier/Sander, 2000, Sander/Kleimeier, 2001) - <i>"Antitrust-Literature"</i> (Stigler/Sherwin, 1985, Keeley/Zimmerman, 1985, Berger/ Hannan, 1989, Hannan, 1991, Hannan/ Berger, 1991, Neumark/Sharpe, 1992, Jackson, 1992, Rhoades, 1992, Radecki, 1998, 1999, Heitfield, 1999) 	<ul style="list-style-type: none"> - <i>"Micro Home Bias Literature"</i> (Tesar/Werner, 1992, Lewis, 1999, Hess/Shin, 2000)

Another quantity approach looks at correlations between consumption across countries (Obstfeld, 1989).⁴ When markets are fully integrated individuals are able to ensure themselves against unexpected changes in their income streams stemming from regional shocks by diversifying their portfolio holdings. A high correlation between domestic and foreign consumption indicates a high degree of cross-border capital mobility and a high degree of financial market integration.⁵

By looking at correlations between saving and investment or between consumption across countries studies usually find evidence for relatively low degrees of capital mobility and subsequently low financial market integration. However, there are a number of studies (Tobin, 1983, Murphy, 1984, Obstfeld, 1985, Summers, 1988, Bayoumi, 1990, Taylor, 1994) that point out several shortcomings of the Feldstein/Horioka-test arguing that this criterion measures more than financial capital mobility alone since high correlations between saving and investment do not necessarily contradict international capital mobility.⁶ Thus, quantity measures à la Feldstein-Horioka do not seem very promising in assessing the degree of financial market integration.

2.2 Price measures

The basic idea behind price measures is that in a perfectly integrated financial market arbitrage should safeguard that prices of identical assets traded in different markets are equal, i.e. the law of one price holds. Hence assessing the degree of financial market integration implies measuring the degree to which capital flows equalise expected returns on comparable assets traded in different countries and possibly denominated in different currencies (Eijffinger and Lemmen, 1995). According to Frankel (1992, 1993) and Lemmen and Eijffinger (1993) there are three different concepts of defining perfect capital mobility, that fit into the price approach.⁷ Those are well known as the interest parity conditions, namely covered nominal interest parity (CIP), ex ante uncovered interest parity (UIP), and ex ante real interest parity (RIP).⁸ Obviously, the introduction of a single European currency

⁴ This approach also refers to the so called “risk-sharing” hypothesis.

⁵ On the micro level there is numerous evidence that consumers within countries, i.e. within an area of high capital mobility, do not fully smooth out consumption. Consumers clearly prefer shares and bonds issued in the home country. This lack of interregional risk diversification is widely known as the so called home bias in investment portfolios (e.g. Tesar and Werner, 1992, Lewis, 1999, Hess and Shin, 2000).

⁶ For a useful survey of the criticism of the Feldstein-Horioka criterion see for example Lemmen and Eijffinger (1995).

⁷ A fourth method of measuring capital mobility is the Feldstein-Horioka-criterion discussed above.

⁸ For a description of the interest parity concepts see for example Frankel (1992, 1993), Lemmen and Eijffinger (1995).

has removed the existence of an exchange risk premium within the European Union. As a result, tests for interest parity in order to assess the degree of financial market integration within EMU make no sense.

Usually, studies employing interest parity conditions focus on money market rates or other wholesale interest rates. Besides, there is a wide literature that tries to assess the degree of stock market integration. These studies use, for example, uncovered interest parity (e.g., Fratzschner, 2001) or some specification of the arbitrage pricing theory (APT) (e.g., Bekaert and Harvey, 1995, Dumas and Solnik, 1995, Ferson and Harvey, 1991, Hardouvelis et al., 1999).

2.3 Measuring integration in retail financial markets

Clearly, the above approaches aim on measuring integration in wholesale financial markets such as the money, the bond, or the stock market. Most of the studies considering wholesale financial prices lead to the conclusion that the degree of financial market integration is quite high. Obviously, since the introduction of a single currency on January 1, 1999, there is a single money market in the euro zone and also the integration of other wholesale financial markets can be considered to be far advanced. However, the retail financial markets seem to remain quite fragmented in Europe and so far not much research work has been undertaken on this issue.

There are a number of studies that incorporate price data in order to measure integration in retail financial markets in the US.⁹ These studies were often motivated from an antitrust point of view as they tried to quantify the regional extension of the market for financial services. If banking markets are non-local – i.e. “integrated” in our terminology – then local supply and demand conditions would not be relevant in the evaluation of the competitive effects of any given local merger (Rhoades, 1992).

However, there are only a few studies that try to measure integration in the European retail financial markets. In 1988 the Cecchini-Report (Commission of the European Communities, 1988) gave evidence of substantial fragmentation of the European financial services markets since it found substantial price differentials. Price differentials were based on the percentage differences in prices of standard financial service products for each country compared with the average price for the four lowest-priced countries. In a second step, Cecchini estimated potential benefits arising for consumers from financial market integration, i.e. the gains in consumer surplus resulting from price reductions. The obvious problems with this kind of studies¹⁰ are the big difficulties to find completely homogeneous financial products

⁹ Table 1 refers to this strand of literature as the “Antitrust-Literature”.

¹⁰ Gardener and Teppett (1995) replicate the microeconomic methodology of the Cecchini study and reveal other shortcomings.

and the fact that absolute prices for not strictly homogeneous products are not comparable (Zimmerman, 1995).

Besides Cecchini, to our knowledge, only Centeno and Mello (1999), Kleimeier and Sander (2000) and Sander and Kleimeier (2001) focus on the European retail financial sector. All of them use cointegration techniques in order to measure financial market integration.

2.4 The cointegration approach

European retail financial markets are characterised by heterogeneity across countries that is caused by, for example, risk differences, cultural influences in bank-client relationship, country-specific strategic bank behaviour in order to cope with informational imperfections such as moral hazard or incentive effects (Sander and Kleimeier, 2001). Consequently, prices will not strictly equalise even in fully integrated markets. The law of one price, i.e. interest rate parity can hold solely for assets that are perfect substitutes across countries such as government bonds or money market instruments.

However, pricing in retail banking will be more closely tied together within an increasingly integrating region (Kleimeier and Sander, 2000). Thus, in integrated markets there should exist a certain long-run relationship between interest rates across countries. Certainly, this relationship does not require rates to equalise. And obviously, in the short-run retail rates will deviate from this long-run equilibrium but this existing long-run relationship limits divergence of rates in an integrated market. Therefore, the concept of cointegration can be employed to assess the degree of integration in retail financial markets. Cointegration means that there exists such a long-run relationship between two or more time series.

Centeno and Mello (1999) use cointegration techniques to test for financial market integration in six EU member states. They find money market rates to be closely linked across countries but the European bank loans market to be rather segmented.

Kleimeier and Sander (2000) also apply cointegration tests in order to assess the extent to which interest rate linkage in Europe might have become stronger over time. They apply the cointegration tests to lending rates, for what they choose the respective national prime rates, and to interest rate spreads, which they calculate by using the money market interest rate as a proxy for the deposit rate. They find prime rates and spreads not to be co-integrated for most of the European countries in the period between 1993 and 1997. This lack of cointegration could imply either that two markets are not linked at all or that convergence is under way since structural breaks in the standard cointegration tests can wrongly lead to the rejection of cointegration. Kleimeier and Sander (2000) infer an increase in the degree of financial market integration in the post-1993 period.

Using data from the ECB's National Retail Interest Rate Statistics, Sander and Kleimeier (2001) (SK from here on) perform cointegration tests for three retail rates: the mortgage loan rate charged to households (N2), the consumer loans rate charged to households (N3), and the short-term lending rate charged to the corporate sector (N4).¹¹ They find some tendencies for a more integrated corporate lending market, while consumer lending markets are still rather fragmented.

In this paper we choose a similar cointegration approach in order to assess the degree of integration in the European retail financial market. We also use data from the ECB's National Retail Interest Rate Statistics but extend SK by an additional lending rate, namely the rate for medium and long-term loans to enterprises (N5) and two deposit rates, namely for time deposits (N8) and savings accounts (N9).

SK test for cointegration between the national retail rate and the average interest rate among the remaining Euroland countries. Using the average seems to be problematic because it imposes implicitly a severe restriction on the cointegration equation. Also, interpretation seems to be irritating: what exactly means cointegration between one country and the EU average? Hence, we test for cointegration between every possible pair of national retail rates. By doing so, we try to get some kind of pattern of countries that are integrated for every retail rate. Additionally to this bivariate approach, we conduct multivariate cointegration tests.

Usually, in the cases where cointegration is found a vector error correction model is estimated. SK do so in order to assess the degree of market integration. Such an error-correction specification allows to estimate how fast retail rates are driven back to their long-run equilibrium. SK argue that the faster the adjustment process, the stronger is integration of the national market (with the average of the rest of the countries) which allows primarily for a comparison of the degree of integration across countries within one market. However, it seems to be more interesting to draw comparisons concerning the degree of integration among the different European retail markets. In this paper we test for bivariate cointegration between every possible pair of countries and take the relative number of cointegration relationships found in a certain retail market as an indication for the degree of integration. An additional estimation of the error correction model would not give any further information concerning the degree of integration – it would not make sense to compare the degree of integration between two pairs of countries. Consequently, we do not estimate a vector error correction model and stop the analysis after having assessed integration by testing for bivariate and multivariate cointegration.

¹¹ N2, N3, N4, N5, N8 and N9 refer to the numbers of the series as reported by the ECB.

Furthermore, compared to SK we use a somewhat different definition of integration underlying the cointegration approach. SK do not differentiate between integration that is due to the single European currency and integration that is due to factors such as deregulation or technical progress since they use interest rate levels and do not adjust for exchange rate fluctuations before the introduction of the Euro. We regard this approach as problematic since the result of increasing integration in this type of analysis could simply be caused by the end of exchange rate volatility. This finding, however, does not say much about integration of retail markets. In order to allow for more meaningful results we instead adjust for exchange rate related interest differentials by using spreads between the national retail rate and the national money market rate. In the case of long-term lending rates, i.e. the mortgage rate we subtract the bond yield.¹² Hence, the cointegration equation can be written as

$$S_{it} = a + bS_{jt} + u_t$$

where S_{it} and S_{jt} is the spread between the retail rate and the money market rate (or the bond yield) of country i and j at time t, respectively. u_t is an error term.

If cointegration between the interest rate spreads is found, this means that markets are tied together by a long-run relationship, i.e. markets are integrated. In the short-run, however, deviations from this relationship can occur. Such deviations should be corrected over time by cross-border lending or increasing international competition (Sander and Kleimeier, 2001): When banks shift their lending activities to countries where lending rates are the highest and consumers or firms borrow in countries where rates are lowest, this international arbitrage process leads to a correction of deviations from the long-run equilibrium. Furthermore, increasing international competition – or as to the theory of contestable markets, the threat of it – lead to similar pricing behaviour of banks. With an already fully integrated European money market this should lead to a harmonisation of retail prices, since banks should pass changes in the underlying cost of funds onto consumers in the same way across countries.¹³

¹² These spreads can be interpreted as the bank margins. However, since the ECB statistic contains aggregated rates there may be differences in the term structure between lending rates and market rates that curtail this kind of interpretation. Consequently, spreads may also be negative over some periods – as figures 1a and 1b beneath reveal.

¹³ However, so far interest rate pass-through in Europe is still heterogeneous (Heinemann and Schüller, 2002).

3 Integration in the European retail financial market

3.1 The data

As mentioned above we examine four lending rates and two deposit rates, that are taken from the ECB's National Retail Interest Rate Statistics. Namely this is interest rates for mortgage loans to households (N2), consumer loans to households (N3), short-term loans to enterprises (N4), medium and long-term loans to enterprises (N5), time deposits (N8), and savings accounts (N9). Unfortunately, a problem of the database is that interest rates are not harmonised. However, as mentioned above, using cointegration analysis takes somewhat care of this problem since rates are not expected to fully equalise even when markets are fully integrated.

A second problem results from the fact that the introduction of the Euro may have lead to a structural break in the cointegration relationship (e.g., Sander and Kleimeier, 2001). SK account for this structural break by dividing the data into a "pre-euro period" and a "Euro period". However, cointegration analysis requires data over long periods of time. In addition, the time period for which data for all European countries is available simultaneously is limited. Therefore, we choose not to account for structural breaks explicitly. Possibly, using interest rate spreads instead of levels may weaken this disregard.

Another source for a structural break may have been the Second Banking Directive which was adopted in 1989, implemented on January 1, 1993 and completed formally the single European banking market. Also, by the beginning of 1993 in all EU countries consumer interest rates were completely deregulated (Guardia, 2000). In order to account for this potential structural change, we use monthly data beginning in January 1993. For this period for almost all countries data are available and even in the rare cases where series start in 1995 cointegration results are comparable.¹⁴

In the following we use nominal rates because consumers and firms look at nominal rates when borrowing or investing money. Inflation in the foreign country, and thus, real interest rates do not matter to them.

Interest rate spreads are calculated by subtracting the long-term-government bond yield from the mortgage rate. For all other lending rates the 3-month-money market rate is used, as well as for the time and savings deposit rates. The bond yields and the money market rates are taken from the IMF's International Financial Statistics.

¹⁴ All retail rates for Austria and the United Kingdom, as well as the mortgage rate and the time deposit rate for Italy are only available from 1995 on. For Germany the medium and long-term loans rate to enterprises starts in 1996.

The study is conducted for Austria (AT), Belgium (BE), Finland (FI), France (FR), Germany (DE), Ireland (IE), Italy (IT), the Netherlands (NL), Portugal (PT), Spain (ES) and the United Kingdom (UK), although not all retail rates are available for every country.

The analysis proceeds as follows: Before testing for cointegration some descriptive statistics are presented. Then the spread series are tested for unit roots and in a first step we test for bivariate cointegration. Based on patterns obtained from this bivariate analysis, in a second step, multivariate cointegration tests are conducted.

3.2 Stylised facts

Before testing for cointegration some simple descriptive statistics are presented. Figure 1a and 1b show exemplary the evolution of the interest rate levels and the spreads for mortgage loans to households. Clearly, a convergence of the mortgage interest rates has occurred. However, the convergence of spreads is not as obvious, indicating that the convergence in levels may be largely due to the removal of exchange rate risk. This confirms our proceeding of using interest rate spreads instead of levels when testing for cointegration, since before 1999 the relationship between interest rate levels is biased due to exchange rates fluctuations. Basically the same holds true for the other retail interest rates, although convergence is not that obvious for all rates.

Figure 1a: Interest rates for mortgage loans

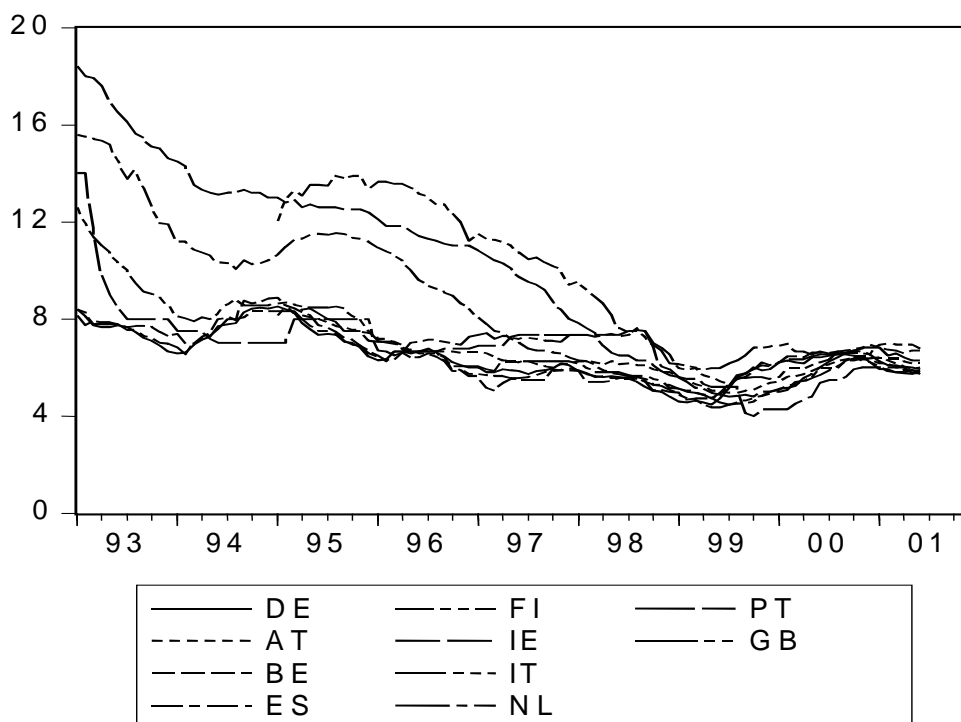
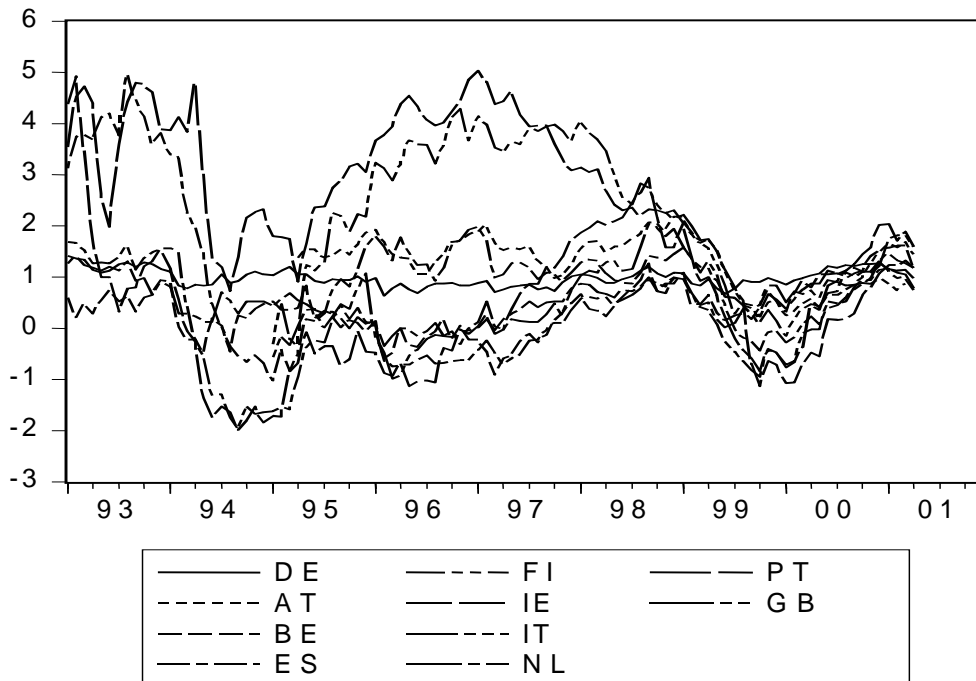

Figure 1b: Spreads between mortgage rate and the long-term-government bond yield



To get a first impression how strong interest rate spreads are linked correlation coefficients are calculated. Table 2 shows average correlations for the different countries for the six retail markets. The whole available sample period from January 1980 to Mai 2001 is divided into three sub-periods: the period before completion of the single banking market which was achieved by the Second Banking Directive in January 1993, the pre EMU period, and the EMU period.

Table 2: Average correlation coefficients between national interest rate spreads

Period	DE	AT	BE	ES	FR	FI	IE	IT	NL	PT	UK	Total
Mortgage loans to households												
1980-2001	0.25	0.32	0.24	0.43	N.A.	0.54	0.43	0.14	0.25	0.20	0.34	0.31
1980-1992	0.42	N.A.	0.49	0.24	N.A.	N.A.	0.40	N.A.	0.38	0.53	N.A.	0.41
1993-1999	0.37	0.27	0.31	0.48	N.A.	0.57	0.52	0.10	0.43	0.07	0.43	0.35
1999-2001	0.45	0.66	0.59	0.76	N.A.	0.79	0.59	0.72	0.54	0.79	0.58	0.65
Consumer loans to households												
1980-2001	0.68	0.86	0.54	0.54	N.A.	0.61	N.A.	N.A.	N.A.	0.32	0.82	0.62
1980-1992	-0.18	N.A.	N.A.	-0.05	N.A.	0.10	N.A.	N.A.	N.A.	-0.39	N.A.	-0.13
1993-1999	0.69	0.75	0.42	0.48	N.A.	0.53	N.A.	N.A.	N.A.	0.38	0.73	0.57
1999-2001	0.68	0.86	0.54	0.54	N.A.	0.61	N.A.	N.A.	N.A.	0.32	0.82	0.62
Short-term loans to enterprises												
1980-2001	-0.06	0.14	-0.04	-0.05	0.12	N.A.	-0.10	0.01	-0.16	0.07	N.A.	-0.01
1980-1992	-0.10	N.A.	0.11	-0.08	0.15	N.A.	-0.03	0.10	-0.02	0.11	N.A.	0.03
1993-1999	0.09	0.19	-0.01	-0.03	0.17	N.A.	0.03	-0.08	-0.22	0.08	N.A.	0.02
1999-2001	0.66	0.67	0.28	0.47	0.50	N.A.	0.42	0.37	0.34	0.57	N.A.	0.47
Medium and long-term loans to enterprises												
1980-2001	0.39	N.A.	0.18	0.19	0.38	0.13	0.06	0.33	N.A.	N.A.	N.A.	0.24
1980-1992	N.A.	N.A.	0.00	0.21	0.23	-0.12	0.36	N.A.	N.A.	N.A.	N.A.	0.14
1993-1999	0.39	N.A.	0.17	0.22	0.49	0.25	0.00	0.30	N.A.	N.A.	N.A.	0.26
1999-2001	0.33	N.A.	0.20	0.53	0.45	0.14	0.52	0.58	N.A.	N.A.	N.A.	0.40
Time deposits												
1980-2001	0.30	0.45	0.26	0.20	0.10	0.34	N.A.	0.22	0.19	-0.11	-0.06	0.19
1980-1992	0.06	N.A.	0.21	0.12	0.17	0.24	N.A.	N.A.	0.22	0.18	N.A.	0.17
1993-1999	0.36	0.24	0.32	0.25	0.01	0.16	N.A.	0.30	0.27	0.22	-0.33	0.18
1999-2001	0.76	0.77	0.77	0.67	0.25	0.72	N.A.	0.76	0.43	0.77	0.38	0.63
Savings deposits												
1980-2001	0.50	N.A.	0.59	N.A.	0.43	N.A.	0.16	N.A.	N.A.	N.A.	0.04	0.34
1980-1992	0.03	N.A.	0.12	N.A.	0.00	N.A.	0.21	N.A.	N.A.	N.A.	N.A.	0.09
1993-1999	0.38	N.A.	0.45	N.A.	0.30	N.A.	0.27	N.A.	N.A.	N.A.	-0.30	0.22
1999-2001	0.87	N.A.	0.85	N.A.	0.88	N.A.	0.87	N.A.	N.A.	N.A.	0.56	0.81

Average of bilateral correlation coefficients of a country's retail rate with all other countries' retail rates.

Due to the lack of availability of data for a number of countries in the 1980's the coefficients for the period before the completion of a single banking market should not be taken too seriously. Comparing the coefficients for the periods before and after the introduction of the Euro shows that correlation for all countries has become stronger. In general, no consistent statement is possible concerning which market exhibits the higher correlations. Hence, table 2 does not reveal which market may be more integrated. In the next section tests for cointegration are conducted in order to assess the degree of integration.

3.3 Testing for cointegration – the bivariate case

Before testing for cointegration, tests for the existence of a unit root in the time series of interest rate spreads were conducted. In the following, all series of spreads are treated as $I(1)$ processes.¹⁵ The results of the augmented Dickey-Fuller (ADF) and the Kwiatkowski, Phillips, Schmidt and Shin (KPSS) unit root tests are available upon request from the authors.

Cointegration is tested using the Johansen procedure. We use a model with an intercept in the cointegration equation but not in the vector autoregression part and with no deterministic trend as the data series exhibit such characteristics (first differences of the series fluctuate around zero). As for the lag structure in the model, an unrestricted vector autoregression model in first differences is estimated and the lag length is chosen according to the Akaike-criterion which makes sure that the residuals in each equation of the model are uncorrelated.

The results for the four lending rates and the two deposit rates are reported in tables 3a to 3f. The tables display the lag length used for testing for bivariate cointegration and – according to the Trace statistic – if cointegration was found. One star indicates that cointegration was found at the 5% – two stars at the 1% significance level. More detailed results are available from the authors.

¹⁵ Only in the following cases we had problems to reject the null hypothesis of stationarity: for the mortgage rate and the short-term business lending rate for Ireland, for the time deposit rate for Belgium, Spain and France.

**Table 3a: Results of bivariate cointegration tests: Existence of cointegration
(optimal lag length in brackets): Mortgage loans to households (N2)**

	AT	BE	ES	FI	IE	IT	NL	PT	UK
DE	no (2)	yes* (4)	yes* (3)	no (3)	no (5)	no (1)	yes** (1)	no (7)	no (5)
AT		no (2)	no (1)	no (1)	no (1)	no (1)	no (1)	no (1)	no (1)
BE			yes* (10)	no (3)	no (5)	no (1)	yes** (1)	yes* (8)	no (3)
ES				no (1)	no (10)	no (9)	no (4)	no (4)	no (4)
FI					no (1)	no (1)	yes* (3)	no (4)	no (4)
IE						no (1)	no (6)	no (10)	no (4)
IT							no (1)	no (1)	no (1)
NL								no (7)	no (3)
PT									no (1)

/: Trace statistic of Johansen test indicates cointegration with 5%/1% level of significance*

Table 3b: Consumer loans to households (N3)

	AT	BE	ES	FI	PT	UK
DE	yes** (10)	no (1)	no (2)	no (3)	no (4)	no (1)
AT		no (4)	no (1)	no (1)	no (1)	no (1)
BE			no (2)	no (5)	no (1)	no (1)
ES				no (10)	no (5)	no (1)
FI					no (9)	no (5)
PT						no (3)

Table 3c: Short-term loans to enterprises (N4)

	AT	BE	ES	FR	IE	IT	NL	PT
DE	no (1)	yes* (1)	yes* (1)	no (7)	yes** (8)	no (1)	no (1)	no (7)
AT		no (1)	no (5)	no (3)	no (1)	no (1)	no (1)	no (2)
BE			no (5)	no (10)	no (10) ¹⁶	yes* (10)	no (1)	no (10)
ES				no (7)	yes** (8)	no (4)	no (1)	no (8)
FR					yes* (10)	yes* (9)	no (7)	no (9)
IE						yes** (5)	yes** (5)	yes** (10)
IT							no (1)	yes** (10)
NL								no (7)

Table 3d: Medium and long-term loans to enterprises (N5)

	BE	ES	FR	FI	IE	IT
DE	no (1)	yes** (6)	yes** (1)	no (2)	no (1)	yes** (1)
BE		yes** (10)	no (9)	no (5)	yes* (9)	no (1)
ES			no (10)	no (10)	yes** (10)	yes* (1)
FR				no (10)	yes** (10)	no (5)
FI					yes* (9)	yes* (2)
IE						no (1)

¹⁶ In this case two cointegration equations were found. When two cointegration equations are found in the bivariate case this indicates that the series are stationary. Indeed, we had problems to reject stationarity for Ireland whereas the Belgium series clearly is I(1).

Table 3e: Time deposits (N8)

	AT	BE	ES	FI	FR	NL	IT	PT2	UK
DE	no (3)	yes** (3)	yes** (10)	no (5)	yes** (9)	no (2)	no (1)	yes** (7)	no (2)
AT		no (1)	no (4)	no (2)	yes** (2)	no (1)	no (1)	no (2)	no (1)
BE			yes** (10)	yes** (10)	yes** (7)	yes** (3)	no (2)	yes** (8)	no (1)
ES				yes* (10)	yes** (10)	yes** (10)	yes** (2)	yes** (10)	no (2)
FI					yes** (7)	no (4)	no (2)	no (9)	no (1)
FR						yes** (9)	yes** (3)	yes** (10)	yes** (3)
NL							no (1)	no (8)	no (1)
IT								yes** (1)	yes* (2)
PT2									no (1)

Table 3f: Savings accounts (N9)

	BE	FR	IE	UK
DE	no (10)	yes** (3)	no (6)	no (1)
BE		yes** (10)	no (9)	no (1)
FR			yes* (10)	no (1)
IE				no (1)

Clearly, there are differences across the different markets. Looking at the relative numbers of cointegration relationships found, there is some evidence for integration in the market for short-term as well as for medium and long-term loans to enterprises, and also in the time deposits market. In the markets for mortgage loans and consumer loans to households as well as in the market for savings deposits only a few cointegration relationships are found, giving some indication that those markets are rather fragmented.

Looking in closer detail, in the market for *mortgage loans to households* in only 7 out of 21 possible combinations cointegration was found. Only the spreads for mortgage loans between Germany and the Netherlands, and the spreads between Belgium and the Netherlands were co-integrated at the 1% significant level. All in all there were 4 cointegration relationships found for Belgium, 3 for Germany and the Netherlands, 2 for Spain, and 1 for Finland and Portugal. No cointegration was found for Austria, Ireland, Italy and the United Kingdom. These numbers indicate that so far there exists no single European mortgage loans market although there is

some evidence for integration in Belgium, Germany, the Netherlands and maybe Spain. Figure 2 illustrates this pattern. The lines indicate that a bivariate cointegration relationship was found between the two countries, respectively.

Figure 2: Cointegration relationships in the mortgage market

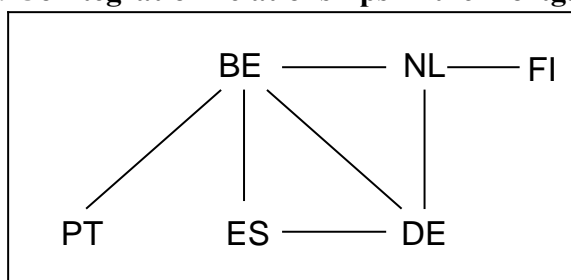

In the *consumer loans* market only 1 cointegration relationship was found, indicating that only the markets of Germany and Austria are integrated. This gives some evidence that there exist substantial obstacles to the integration of the European markets for consumer loans to households.

Hence, whereas the market for consumer loans does not show any sign of integration for the mortgage loans market there is at least some evidence for integration although there exists no single European mortgage market. This result seems to be plausible since in the mortgage market, for example, monitoring is a smaller problem than in the consumer loans market where also personal bank-customer-relationships probably play a major role.

More integrated seems to be the market for *short-term loans to enterprises*. In 11 out of 36 possible combinations cointegration was found. For Ireland 6 cointegration relationships were found, 4 for Italy, 3 for Germany, 2 for Belgium, Spain, France and Portugal, and 1 for the Netherlands. Only in the case of Austria no cointegration was found. Figure 3a illustrates the bivariate cointegration relationships in the case of short-term loans to enterprises. It seems that Ireland builds something like a centre that links a number of other national markets. However, we had problems with the rejection of stationarity for the spread series for Ireland which may be a explanation for the high numbers of cointegration relationships found for Ireland. When dropping Ireland from the sample in 5 out of 28 possible combinations bivariate cointegration is found. Figure 3b illustrates this case which reveals some evidence for integration among Italy, Portugal, France, Belgium, Germany and Spain.

Figure 3a: Cointegration relationships in the market short-term loans to enterprises

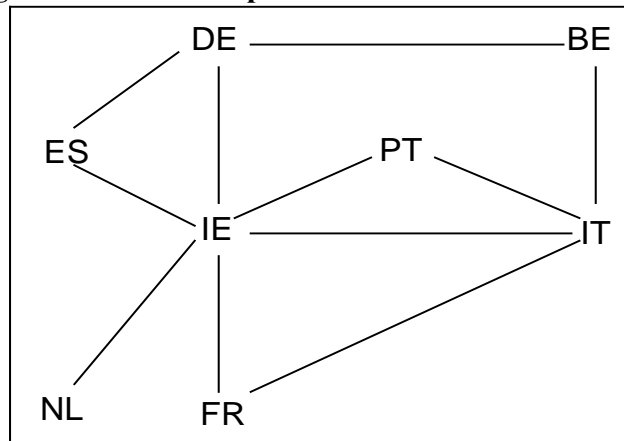
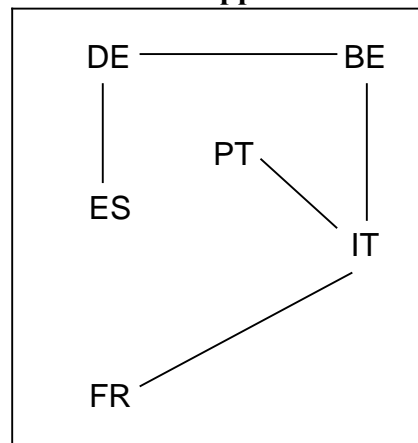
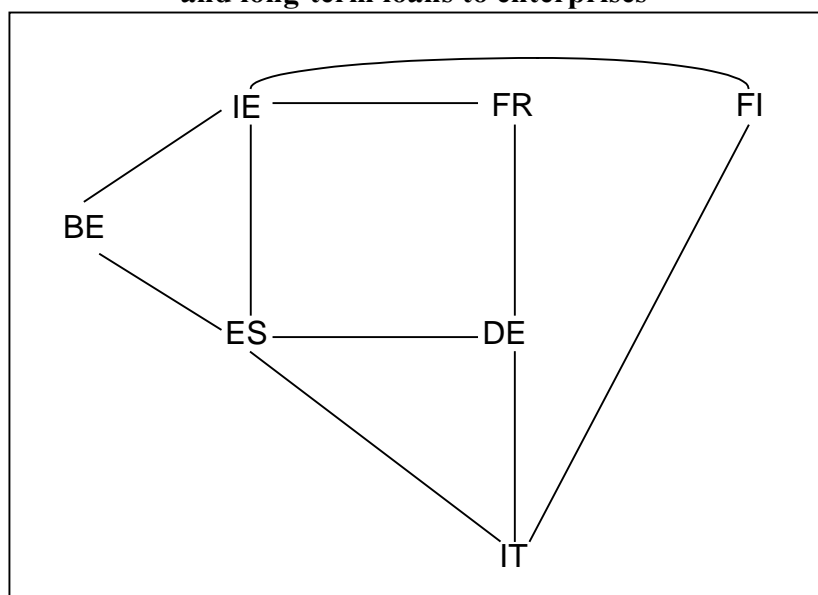

Figure 3b: Cointegration relationships in the market short-term loans to enterprises when Ireland is dropped from the sample



Also we get evidence that the European market for *medium and long-term loans to enterprises* is to some extent integrated since we found in almost every second case cointegration (10 out of 21). We found 4 cointegration relationships for Spain and Ireland, 3 for Germany and Italy, and 2 for Belgium, France and Finland. Figure 4 illustrates the bivariate cointegration relationships in the case of medium and long-term loans to enterprises.

Figure 4: Cointegration relationships in the market for medium and long-term loans to enterprises



In general, enterprises may borrow money from a bank abroad rather than consumers. Thus, cross-border competition in the markets for loans to enterprises probably is higher than in the markets for mortgage or consumer loans. This puts more pressure on banks in the enterprise loans market to pass a decrease in their cost of funds, i.e. the money market rate to the lenders. In this way financial market integration is fostered and this explains our findings of lower integration in the mortgage and consumer loans market than in the loans markets for enterprises.¹⁷

In the *time deposits* market in 22 out of 45 possible combinations cointegration was found giving some evidence that the market is integrated to a large extent. This seems to be plausible since traditionally time deposits are strongly linked to the money market. With the introduction of a single currency a single European money market emerged which in the case of time deposits may have enforced integration. In addition, compared to, for example, savings deposits time deposits are predominantly made by wealthier or even institutional investors that may rather invest in a foreign country than a “normal saver”. Thus, also higher cross-border competition may foster market integration. However, in this case we had problems to reject stationarity for some spread series, namely for Belgium, Spain and France. Clearly, this limits interpretation.

¹⁷ Our finding that the firms loans market is more integrated than the households loans market is basically in line with Sander and Kleimeier (2001). However, they found evidence that the consumer loans market is somewhat more integrated than the market for mortgage loans market.

There seems to be little evidence for integration in the European *savings deposit* market since we found only in 3 cases cointegration. It looks like France is integrated with Germany, Belgium and Ireland whereas no other cointegration relationships were found. A possible explanation for this lack of integration in the savings deposits market may be that savings deposits are usually made by savers that attach much importance to a personal customer-bank-relationship. Hence, cross-border competition is probably relatively low hindering integration in this market. Unfortunately, the number of countries for which interest rate data on savings deposits is available is small compared with the other markets so that comparisons have to be interpreted with caution.

To summarise, we find evidence that integration in the markets for mortgage and consumer loans to households is relatively low. The markets for short-term as well as medium and long-term loans to enterprises seem to be integrated at least to some extent. Concerning deposits, our results indicate that the time deposit market is to quite an amount integrated whereas the markets for savings deposits are rather fragmented.

3.4 The multivariate case

Based on the patterns obtained from the bivariate case (see figures 2 to 4) we test for multivariate cointegration. The bivariate case ignores that there may exist integration of two markets through a third market, i.e. there may exist a long-run, cointegration relationship that ties several markets together whereas such a relationship is not found between two markets alone (Harris, 1995). So we look for samples of countries that exhibit one – and only one – cointegration equation. All countries in such a sample are tied to this one cointegration equation in the long-run which gives evidence for financial integration of these countries. When taking cointegration as evidence for market integration more than one cointegration equation economically does not make sense (Kremer, 1999). Therefore, when a sample of countries exhibits more than one cointegration equation we search for other samples that exactly have one cointegration equation.

Again, cointegration is tested using the Johansen procedure and prior the lag length is chosen according to the Akaike criterion from a unrestricted vector autoregression model in first differences. The detailed test results can be obtained upon request.

In the market for *mortgage loans to households* the sample of countries including Germany, Belgium, the Netherlands, and Spain exhibits exactly one cointegration equation. This confirms our findings from the bivariate cointegration tests illustrated in figure 2. Although there exists no single European mortgage market there is some evidence that markets in Germany, Belgium, the Netherlands, and Spain are to some extent integrated.

In regard to the *consumer loans* market our finding from the bivariate case that there are no signs for integration are also confirmed in the multivariate case. The sample with all countries for which data is available reveals no cointegration. The same holds true when the United Kingdom as a non-Euroland country is dropped from the sample as well as for any other multivariate combination of countries.

For the *medium and long-term loans to enterprises* we find one cointegration equation for the sample including Spain, Germany, Italy, Ireland and Belgium. Looking at figure 4 reveals that this finding confirms to some amount the results of the bivariate analysis. However, taking France and/or Finland into the sample one gets more than one cointegration relationships. This points to an integrated “core” of countries, namely Spain, Germany, Italy, Ireland and Belgium to which France and Finland have some link.

Concerning the *savings deposits* market we find one cointegration equation for the sample of all Euroland countries for which data is available, i.e. Germany, Belgium, France and Ireland indicating market integration for these countries. However, this evidence is rather weak since the trace statistic allows only for a rejection of the null of no cointegration relationship at the 5% level and the max-eigenvalue test even indicates no cointegration among these countries. As mentioned above, bearing in mind that only for five countries data is available this result has to be interpreted with care anyway.

In regard to the European *time deposits* market we tested a number of possible combinations of countries for multivariate cointegration. We found for the sample including Germany, Belgium, Spain, France and Italy one cointegration equation. These countries were together with Portugal the countries for which the most bivariate cointegration relationships were found. Taking Portugal into the sample we found more than one cointegration equation. These findings indicate that there exists a “core” including the biggest European economies that have integrated markets for time deposits and that countries like Portugal, the Netherlands, Finland and Austria are linked through bivariate relationships to this “core”. All in all the findings from the multivariate analysis – like the ones from the bivariate analysis – can be taken as evidence that the European time deposit market is to quite an amount integrated.

For the market for *short-term lending to enterprise* the results of the multivariate analysis are not presented as neither the results of the bivariate analysis are confirmed nor other reasonable patterns are obtained.

4 Obstacles to integration in retail financial markets

The analyses in the previous section give some evidence that although there are some signs for integration so far a single European retail financial market does not exist. This holds true especially for the loans markets to consumers, i.e. the mortgage and the consumer loans market, and for the savings deposit market. But also the loans market to enterprises seems to be not fully integrated. Thus, the question emerges of what are the reasons for this lack of integration, i.e. what are the obstacles to retail financial market integration.

In general, fragmentation in markets for financial services can either be due to policy-induced or to natural factors. Policy-induced obstacles are regulation and taxes, in particular, obstacles that can be reduced by policy-makers. As opposed to this, natural obstacles are independent of political actions at least in the short and medium-run. Such barriers to financial market integration are, for example, preferences and confidence of consumers, differences in culture and/or language, and distance.

SK cite Tommaso Padoa-Schioppa with the words “proximity is an intrinsic characteristic of the retail market with or without the emergence of a currency embracing a wider area” (Sander and Kleimeier, 2001, p 1). In regard to loans to consumers the previous analyses somewhat confirm this assessment. In the mortgage market only between Germany and the Netherlands, and between Belgium and the Netherlands cointegration was found at a 1% significant level. In the consumer loans market only Germany and Austria were co-integrated. The closer links between neighbouring and common language countries indicate that for those markets distance and maybe also language may constitute natural obstacles to integration. However, this assessment is not confirmed for the other retail markets since there cointegration is found also for countries that are far away from each other. And even, when taking not just cointegration at the 1%-level distance seems to play no major role in the mortgage market.

In general, factors like distance, the presence of a common language, and a common legal system influence the information costs associated with bank lending. The presence of information costs hinders direct cross-border bank lending which means lower financial market integration (Buch, 2000). In particular, this should be essential for financial services that are not standardised and where monitoring plays a major role like with consumer loans or small business lending. Market segmentation that results from information costs can hardly be reduced by policy actions.

In addition to these natural obstacles to market integration there are policy induced obstacles –regulations in particular. Buch (2000) finds evidence that the EU’s Single

Market program and the Basle Capital Accord have had a positive impact on cross-border banking activity. On the other side, factors like the still high cost for cross-border transfers and lack of consumer protection may impair consumers in opening an account for time or savings deposits at a foreign bank. This includes issues such as cross-border redress and price transparency. Such obstacles should be addressed by policy makers and, to some extent, policy action has been taken or is underway.¹⁸

The revolution in information technology and in particular the internet is often said to overcome borders and in the context of financial retail markets to foster integration. Due to the technical advances, consumers are no longer bound to national or regional firms, they are able to shop around at all companies worldwide that provide services online. As a consequence, information costs are reduced and cross-border competition is enhanced which fosters financial market integration. However, due to factors like the preference of consumers for domestic suppliers overcoming fragmentation in retail financial markets remains hard to achieve (Schüler, 2002).

In summary, the cointegration analyses in the previous sections allows only for limited statements concerning the obstacles to integration of the European retail financial markets. For the loans markets to consumers there is some evidence that distance matters whereas for the loans markets to enterprises and the deposit markets this assessment is not confirmed. This seems to be quite plausible – firms rather than households may look for a cheaper credit at a foreign bank.

5 Conclusion

With the introduction of a single European currency a fully integrated European money market emerged and also other wholesale financial markets are generally regarded as highly integrated. In spite of this single wholesale financial market European retail financial markets still reveal substantial fragmentation. We analysed four lending markets and two deposit markets by testing for cointegration between national interest rate spreads. Comparing the markets in particular, we find evidence that the markets for loans to households are less integrated than the enterprise loans markets. In regard to lending to households we found more integration for mortgages than for consumer credit where almost no signs for integration were found at all. This may be explained by lower information costs for the mortgage credit since it is secured by real estate. We found evidence that the European time deposit market is to quite an amount integrated which is probably due to the fact that

¹⁸ For a more detailed description of the policy action that has been taken to strengthen consumer protection in cross-border financial business see Schüler (2002).

time deposits are traditionally strongly linked to the money market. For the savings deposit market the analyses showed a relatively low degree of integration.

Of course, the analyses in this paper can give just some evidence to the question of financial market integration since there remain problems with the data and also with the cointegration approach. For example, in periods of convergence cointegration tests may misleadingly reject cointegration (Kleimeier and Sander, 2000). However, as section 2 has shown measuring financial market integration has been a difficult task – particularly for retail financial markets where the availability of useful data is strongly limited.

All in all the analyses have shown that retail financial markets seem to be far from being truly integrated. Thus, there is potential for further integration in retail financial markets. Clearly, a single European market for financial services would improve households and firms financing possibility. However, considering the underlying obstacles to integration that are at least to some extent natural, eventually in the short and medium-run, national retail financial markets will remain segmented to a certain degree.

References

- Ayuso, J. and R. Blanco (2000), Has Financial Market Integration Increased During the 1990s?, *BIS Conference Papers* No.8, Basle.
- Bayoumi, T. (1990), Saving-Investment Correlations: Immobile Capital, Government Policy, or Endogenous Behavior? *IMF Staff Papers* Vol. 37 (2), 360-387.
- Bayoumi, T. and R. MacDonald (1995), Consumption, Income, and International Capital Market Integration, *IMF Staff Papers* Vol. 42 (3), 552-576.
- Beckaert, G. and C. R. Harvey (1995), Time-Varying World Market Integration, *Journal of Finance* Vol. 50 (2), 403-444.
- Berger, A. N. and T. H. Hannan (1998), The Price-Concentration Relationship in Banking, *The Review of Economics and Statistics* Vol. 71 (2), 291-299.
- Buch, C. (2000), Information or Regulation: What is Driving the International Activities of Commercial Banks?, Kiel Working Paper No. 1011, Kiel.

- Chen, Z. and P. J. Knez (1995), Measurement of Market Integration and Arbitrage, *Review of Financial Studies* Vol. 8 (2), 287-325.
- Centeno, M. and A. S. Mello (1999), How integrated are the money market and the bank loans market within the European Union?, *Journal of International Money and Finance* 18, 75-106.
- Commission of the European Communities (1988), European economy: The economies of 1992, no 35, March, Brussels: Commission of the European Communities.
- Dumas, B. and B. Solnik (1995), The World Price of Foreign Exchange Risk, *Journal of Finance* Vol. 50 (2), 445-479.
- Guardia, N. D. (2000), Consumer Credit in the European Union, European Credit Research Institute, ECRI Research Report No.1, Brussels.
- Eijffinger, S. C. W. and J. J. G. Lemmen (1995), Money Market Integration in Europe, *Swiss Journal of Economics and Statistics* Vol. 131 (1), 3-37.
- Feldstein, M. and C. Horioka (1980), Domestic Saving and International Capital Flows, *The Economic Journal* 90, 314-329.
- Feldstein, M. (1982), Domestic Saving and International Capital Movements in the Long Run and the Short Run, NBER Working Paper No. 947, Cambridge.
- Ferson, W. E. and C. R. Harvey (1991), The Variation of Economic Risk Premiums, *The Journal of Political Economy* Vol. 99 (2), 385-415.
- Frankel, J. A. (1992), Measuring International Capital Mobility: A Review, *The American Economic Review* Vol. 82 (2), 197-202.
- Frankel, J. A. (1993), Quantifying International Capital Mobility in the 1980s, in: Bernheim, D. (Ed.), *National Saving and Economic Performance*, Chicago, 227-260.
- Fratzscher, M. (2001), Financial Market Integration in Europe: On the Effects of EMU on Stock Markets, *ECB Working Paper* No. 48, Frankfurt.
- Gardener, E. P.M. and J. L. Teppett (1995), A Select Replication of the Cecchini Microeconomic Methodology on the EFTA Financial Services Sectors: A Note and Critique, *The Service Industries Journal* 15, 74-89.
- Goldstein, M. and M. Mussa (1993), The Integration of World Capital Markets, IMF Working Paper WP/93/95, Washington.
- Hannan, T. H. (1991), Bank Commercial Loan Markets and the Role of Market Structure: Evidence from Surveys of Commercial Lending, *Journal of Banking and Finance* 15, 133-149.
- Hannan, T. H. and A. N. Berger (1991), The Rigidity of Prices: Evidence from the Banking Industry, *The American Economic Review* Vol. 81 (4), 938-945.

- Hardouvelis, G., D. Malliaropulos and R. Priestley (1999), EMU and European Stock Market Integration, CEPR Discussion Paper No. 2124, London.
- Harris, R. (1995), *Using Cointegration Analysis in Econometric Modelling*, London.
- Heinemann, F. and M. Schüller (2002), Interest Rate Pass-Through and Imperfect Integration of EU Markets for Financial Services, mimeo.
- Heinemann, F. and C. Stirböck (1999), Capital Mobility within EMU, ZEW Discussion Paper No. 99-19, Mannheim.
- Heitfield, E. A. (1999), What Do Interest Rate Data Say About the Geography of Retail Banking Markets?, *The Antitrust Bulletin* (Summer), 333-347.
- Hess, G. D. and K. Shin (2000), Risk Sharing by Households Within and Across Regions and Industries, *Journal of Monetary Economics* 45, 533-560.
- International Monetary Fund (2000), *Annual Report on Exchange Arrangements and Exchange Restrictions 2000*, Washington.
- Jackson III, W. E. (1992), Is the Market Well Defined in Bank Merger and Acquisition Analysis?, *The Review of Economics and Statistics* Vol. 74 (4), 665-661.
- Keeley, M. C. and G. C. Zimmerman (1985), Determining Geographic Markets for Deposit Competition in Banking, *Economic Review – Federal Reserve Bank of San Francisco*, 25-45.
- Kellermann, K. und C.-H. Schlag (1999), Eine Untersuchung der Ersparnis-Investitions-Korrelation in Deutschland, *Zeitschrift für Wirtschafts- und Sozialwissenschaften (ZWS)* 119, 99-119.
- Kleimeier, S. and H. Sander (2000), Regionalisation versus globalisation in European financial market integration: Evidence from cointegration analyses, *Journal of Banking and Finance* 24, 1005-1043.
- Kremer, M. (1999), Die Kapitalmarktzinsen in Deutschland und den USA: Wie eng ist der Zinsverbund? Eine Anwendung der multivariaten Kointegrationsanalyse, Diskussionspapier 2/99, Volkswirtschaftliche Forschungsgruppe der Deutschen Bundesbank.
- Lapp, S. (1996), The Feldstein-Horioka Paradox: A Selective Survey of the Literature, Kiel Working Paper No. 752, Kiel.
- Lemmen, J. J. G. and S. C. W. Eijffinger (1993), The Degree of Financial Integration in the European Community, *De Economist* 141 (2), 189-213.
- Lemmen, J. J. G. and S. C. W. Eijffinger (1995), Financial Integration in Europe: Evidence from Euler Equation Tests, Working Paper, Tilburg University, Tilburg.
- Lewis, K. K. (1999), Trying to Explain Home Bias in Equities and Consumption, *Journal of Economic Literature* Vol. 37, 571-608.

- Mace, B. J. (1991), Full Insurance in the Presence of Aggregate Uncertainty, *The Journal of Political Economy* Vol. 99 (5), 928-956.
- Murphy, R. G. (1984), Capital Mobility and the Relationship Between Saving and Investment Rates in OECD Countries, *Journal of International Money and Finance* (3), 327-342.
- Neumark, D. and S. A. Sharpe (1992), Market Structure and the Nature of Price Rigidity: Evidence from the Market for Consumer Deposits, *Quarterly Journal of Economics* Vol. 107 (2), 657-680.
- Obstfeld, M. (1985), Capital Mobility in the World Economy: Theory and Measurement, NBER Working Paper No. 1692, Cambridge.
- Obstfeld, M. (1989), How Integrated Are World Capital Markets? Some New Tests, in: Calvo, G., R. Findlay, P. Kouri and J. Braga de Macedo (Eds.), *Debt, Stabilization and Development*, Oxford, 134-155.
- Obstfeld, M. (1994), Are Industrial-Country Consumption Risks Globally Diversified?, in: Leiderman, L. and A. Razin, *Capital Mobility: The Impact on Consumption, Investment and Growth*, Cambridge, 13-44.
- Obstfeld, M. (1995), International Capital Mobility in the 1990s, in: Kenen, P. K., *Understanding Interdependence: The Macroeconomics of the Open Economy*, Princeton, 201-261.
- Olivei, G. P. (2000), Consumption Risk-Sharing Across G-7 Countries, *New England Economic Review* (March/April), 3-14.
- Radecki, L. J. (1998), The Expanding Geographic Reach of Retail Banking Markets, *FRBNY Economic Policy Review* (June), 15-34.
- Radecki, L. J. (1999), Bank Restructuring and Financial Stability in the United States, *BIS Conference Papers* Vol. 7, Basle, 319-340.
- Rhoades, S. A. (1992), Evidence on the Size of Banking Markets from Mortgage Loan Rates in Twenty Cities, *Board of Governors of the Federal Reserve System Staff Studies* No. 162, Washington.
- Schulze, G. G. and H. W. Ursprung (1999), Globalisation of the Economy and the Nation State, *The World Economy* 22, 295-352.
- Sander, H. and S. Kleimeier (2001), Towards a Single Retail Banking Market? New Evidence from Euroland, forthcoming in: *Australasian Journal of European Integration*.
- Schüler, M. (2002), Integration of the European Market for E-Finance – Evidence from Online Brokerage, mimeo.
- Sinn, S. (1992), Saving-Investment Correlations and Capital Mobility: On the Evidence from Annual Data, *The Economic Journal* 102, 1162-1170.

- Summers, L. H. (1988), Tax Policy and International Competitiveness, in: Frenkel, J. (Ed.), *International Aspects of Fiscal Policies*, Chicago, 349-386.
- Stigler, G. J. and R. A. Sherwin (1985), The Extent of the Market, *Journal of Law & Economics* Vol. 28, 555-585.
- Taylor, A. M. (1994), Domestic Saving and International Capital Flows Reconsidered, NBER Working Paper No. 4892, Cambridge.
- Taylor, A. M. (1996), International Capital Mobility in History: The Saving-Investment Relationship, NBER Working Paper 5743, Cambridge.
- Tesar, L. L. and I. M. Werner (1992), Home Bias and the Globalization of Securities Markets, NBER Working Paper No. 4218, Cambridge.
- Tobin, J. (1983), Comments 'Domestic Saving and International Capital Movements in the Long Run and the Short Run' by M. Feldstein, *European Economic Review* 21, 153-156.
- Zimmermann, G. C. (1995), Implementing the Single Banking Market in Europe, Federal Reserve Bank of San Francisco Economic Review, No. 3, 35-51.

All our publications can be accessed, free of charge, on our website www.dbresearch.com. You can also register there to receive our publications regularly by e-mail.

© 2002. Publisher: Deutsche Bank AG, DB Research, D-60272 Frankfurt am Main, Federal Republic of Germany, editor and publisher, all rights reserved. When quoting please cite „Deutsche Bank Research“.

The information contained in this publication is derived from carefully selected public sources we believe are reasonable. We do not guarantee its accuracy or completeness, and nothing in this report shall be construed to be a representation of such a guarantee. Any opinions expressed reflect the current judgement of the author, and do not necessarily reflect the opinion of Deutsche Bank AG or any of its subsidiaries and affiliates. The opinions presented are subject to change without notice. Neither Deutsche Bank AG nor its subsidiaries/affiliates accept any responsibility for liabilities arising from use of this document or its contents. Deutsche Banc Alex Brown Inc. has accepted responsibility for the distribution of this report in the United States under applicable requirements. Deutsche Bank AG London being regulated by the Securities and Futures Authority for the content of its investment banking business in the United Kingdom, and being a member of the London Stock Exchange, has, as designated, accepted responsibility for the distribution of this report in the United Kingdom under applicable requirements. Deutsche Bank AG, Sydney branch, has accepted responsibility for the distribution of this report in Australia under applicable requirements.

Printed by: HST Offsetdruck Schadt & Tetzlaff GbR, Dieburg

Print: ISSN 1610-1502 / Elektr.: 1610-1480 / Internet: ISSN 1610-1499