

Sell, Friedrich L.

Working Paper

Optimism, pessimism and the unforeseen: Modelling an endogenous business cycle driven by strong beliefs

Diskussionsbeiträge, No. 2002,1

Provided in Cooperation with:

Bundeswehr University Munich, Economic Research Group

Suggested Citation: Sell, Friedrich L. (2002) : Optimism, pessimism and the unforeseen: Modelling an endogenous business cycle driven by strong beliefs, Diskussionsbeiträge, No. 2002,1, Universität der Bundeswehr München, Fachgruppe für Volkswirtschaftslehre, Neubiberg

This Version is available at:

<https://hdl.handle.net/10419/32823>

Standard-Nutzungsbedingungen:

Die Dokumente auf EconStor dürfen zu eigenen wissenschaftlichen Zwecken und zum Privatgebrauch gespeichert und kopiert werden.

Sie dürfen die Dokumente nicht für öffentliche oder kommerzielle Zwecke vervielfältigen, öffentlich ausstellen, öffentlich zugänglich machen, vertreiben oder anderweitig nutzen.

Sofern die Verfasser die Dokumente unter Open-Content-Lizenzen (insbesondere CC-Lizenzen) zur Verfügung gestellt haben sollten, gelten abweichend von diesen Nutzungsbedingungen die in der dort genannten Lizenz gewährten Nutzungsrechte.

Terms of use:

Documents in EconStor may be saved and copied for your personal and scholarly purposes.

You are not to copy documents for public or commercial purposes, to exhibit the documents publicly, to make them publicly available on the internet, or to distribute or otherwise use the documents in public.

If the documents have been made available under an Open Content Licence (especially Creative Commons Licences), you may exercise further usage rights as specified in the indicated licence.

Universität der Bundeswehr München
Institut für Volkswirtschaftslehre



Friedrich L. Sell

**Optimism, Pessimism and the
Unforeseen: Modelling an Endogenous
Business Cycle Driven by Strong
Beliefs**

Dissonanz

Optimism, Pessimism and the Unforeseen: Modelling an Endogenous Business Cycle Driven by Strong Beliefs

Friedrich L. Sell[#]

Universität der Bundeswehr München

[#] Institut für Volkswirtschaftslehre, insb. Makroökonomik und Wirtschaftspolitik, Werner-Heisenberg-Weg 39, 85577 Neubiberg, e-mail: friedrich.sell@unibw-muenchen.de.

Content

1	INTRODUCTION	2
2	CLEARING KEY NOTIONS: CONFIDENCE VERSUS SUSPICION; SCEPTICISM/PESSIMISM VERSUS OPTIMISM	4
3	THE MODEL	9
4	A SIMULATION EXERCISE	21
5	EMPIRICAL EVIDENCE?	25
6	SOME CONCLUSIONS AND THE SCOPE FOR FUTURE RESEARCH	26
	REFERENCES	27

Abstract

Indicators of "trust", "confidence", "optimism" or "sentiment" among consumers and/or investors, are published continuously in the mass media. More importantly, these indices seem not only to reflect how the state of the real economy is perceived by private agents, but can also help predict the future course of the business cycle. Moreover, in econometric analyses they have even been found to "cause" business activity. In this paper, we first make an attempt to clear all of the above mentioned notions and to interpret their economic content. We thus intend to provide a theoretical foundation for how "pessimism" and "optimism", in conjunction with estimation errors committed by private agents, can drive the real economy. Furthermore, the model presented is capable of incorporating the revision of expectations of private agents through Bayesian updating, to create a fully endogenized business cycle. The results achieved in simulation experiments confirm the possibility of constant, rising and declining oscillations in the growth rate of consumption and income.

Key words: Business Cycles, Rational Beliefs, Bayesian Updating, Consumer Behaviour.

Die wirtschaftliche Fachpresse und die Massenmedien berichten kontinuierlich über die Entwicklung von Indikatoren, welche Auskunft geben sollen über das "Vertrauen", die "Zuversicht", den "Optimismus" oder schlicht die "Gefühlslage" bei Konsumenten und/oder Investoren. Diese Indikatoren scheinen nicht nur die Ansicht der privaten Akteure über den Zustand der Ökonomie widerzuspiegeln, sondern können auch dazu verwendet werden, den Verlauf des Konjunkturzyklus zu prognostizieren. Ökonometrische Analysen haben gezeigt, daß sie in der Lage sind, den Verlauf der wirtschaftlichen Entwicklung zu "verursachen". In diesem Beitrag sollen zunächst eine Reihe der o. a. Begriffe geklärt und ihr ökonomischer Gehalt interpretiert werden. Anschließend unternehmen wir den Versuch, den Gang der wirtschaftlichen Entwicklung im Zyklus durch das Zusammenspiel von "Optimismus" bzw. "Pessimismus" einerseits und das Auftreten bestimmter Erwartungsfehler andererseits zu erklären. Das Modell bedient sich eines Bayesianischen Lernprozesses und kreiert einen völlig endogenen Konjunkturzyklus. Numerische Simulationen zeigen, daß durch das Modell konstante, zunehmende sowie abnehmende Oszillationen des Konsum- und des Einkommenswachstums erzeugt werden können.

Schlagworte: Konjunkturzyklus, Rationale Überzeugung, Bayesianisches Lernen, Konsumverhalten.

JEL-Klassifikation: E32, E37, E21, E27

*"Then I saw her face
Now I'm a believer
Not a trace of doubt in my mind
I'm in love
I'm a believer
I couldn't leave her if I tried"
(Neil Diamond, 1966)*

1 INTRODUCTION

It is fair to say that theories of the business cycle are not really booming in our profession. On the other hand, the business site and the large public group interested in "commercial affairs", are greatly concerned with time series which report on the "business climate" (as the IFO index), "consumers' sentiment" (index of consumer sentiment, ICS, collected and compiled by the University of Michigan Survey Research Center), "consumers confidence" (the index of the US Conference Board and of the EU commission) or likewise, "investors confidence" (Mussler 2001, p. 7). All of these indices intend to grasp the opinions of consumers and investors on the state of the economy and their expectations towards the future, during a business cycle. The notions being used here are mostly located in the semantics of psychology and of subjective judgements rather than in a world of "rational expectations", which cannot be fooled by politicians systematically.ⁱⁱ

The same public does not take much interest in the highly sophisticated theoretical and empirical contributions by professional and academic economists. This state of the art seems to be quite unsatisfactory. The discipline of explaining the business cycle is dominated today by and large, by approaches which have their foundations in the new classical macroeconomics (NCM). Why do not we have a brief look at the NCM and their attempt to contribute to the theory of the business cycle? Interestingly, the early papers of the NCM are in need of so-called "propagation"ⁱⁱⁱ mechanisms" to create a business cycle. This is due to the fact that the Lucas supply function only allows the explanation of real output effects (whether positive or negative), in the consequence of unexpected monetary shocks which, by definition, are stochastic and cannot be anticipated systematically. The induced "real movements are of no longer duration than the duration of the shock" (Lucas 1994, p. 181). If the natural output is associated with a normal usage of capacities, only a downswing or an upswing from here can be explained without recurring to "propagation elements". To explain the business cycle however, the main challenge is to be able to say why and when we have the turning points.

Two main "propagation elements" are found in the business cycle models of the NCM: "one mechanism stems from the presence of costs of firms of adjusting their stocks of capital and labour rapidly. The presence of these costs is known to make it optimal for firms to spread out over time their response to the relative price signals they receive. That is, such a mechanism causes a firm to convert the serially un-correlated forecasts errors in predicting relative prices into serially correlated movements in factor demands and output. A second propagation mechanism is already present in the most classical of economic growth models. Households' optimal accumulation plans for claims on physical capital and other assets convert serially un-correlated impulses into serially correlated demands for the accumulation of real assets" (Lucas/Sargent 1988, p. 313). In later papers, persistence of effects is due to "information lags" and/or "accelerator effects" (Lucas 1994, p. 181). As Piljoo (1992, p. 14) puts it, it is questionable whether, in the Lucas model "suppliers rather than demanders misperceive money shocks for relative price shocks". Generally spoken, the NCM model by and large neglects the information structure on the side of demanders and more precisely, on the side of consumers.

It is striking to see that NCM – as far as it was meant to contribute to the theory of business cycles – though based on "expectations", has been unable to capture the effects of "surprise" and "disappointment" beyond the framework of the Lucas supply function. The strict interpretation of the rational expectation hypothesis (REH) has also prevented authors of NCM to identify the relevance and significance of "optimism" and "pessimism" as priors, or rational strong beliefs of economic agents. There is perhaps one exemption: Burdekin and Langdana (1995, pp. 148-169) make a strong, but in my view, fruitless effort to introduce optimism (which, by the way, they call "confidence", an error in semantics as shown below), into a REH model. Instead of capturing optimism as a strong belief or prior (see below), they pretend that "confidence includes idiosyncratic respondent-specific information, (that is, an idiosyncratic shock, the author) in the current time period in addition to the mathematical forecasts. ... Thus, ... we see 'confidence' as capturing additional information not yet readily available in contemporaneous data" (ibid., p. 147). Obviously, we find here a severe confusion between the belief itself and the way believers learn from new information.

One may argue that NCM went beyond the early contributions of the later Nobel prize winner, Robert E. Lucas Jr. Furthermore, it could be stated that models of "real business cycles" – as in the seminal paper of Long and Plosser (1983) – are of the NCM type, as they work with rational expectations. This argument is somehow misleading; in these models "business cycles arise from technology shocks and intertemporal labor, leisure, and consumption substitutions in response to these surprises" (Kades 1985, p. 22). Technology shocks, as a source for business cycles, follow the tradition of Knut Wicksell's classical contribution,^{iv} although being surprising simple because *no-*

body can expect them. This makes a strong difference to the attitude of agents in the "old" NCM models, where agents are involved in a game against the monetary authority. An authority which, by the way, makes announcements on which it can cheat. Technology shocks cannot raise expectations and are, almost by definition, unexpected. Here, I am afraid, NCM is less accurate than in many other parts of its theory!

There is not much comfort to be gained from other strands of business cycle theory either. While a number of papers "succeeded" in introducing the REH into models of the business cycle routed in Keynesian macroeconomics – as for example Dornbusch's and Fisher's modification (1994) of the political business cycle model of Nordhaus (1975) – "in fact, no existing Keynesian macroeconomic model incorporates ... an economic model of learning" (Lucas and Sargent 1988, p. 316). One should not extend this affirmation cautiously to the whole class of models which do not strictly follow the NCM. It will be the aim of this paper to do the job in this field. We will attempt to reconsider on the one hand, the forces which drove the business cycle in Samuelson's seminal paper of 1939 – consumers' and investors' demand – , taking into account on the other hand, the role also of expectations and of learning in a framework different from and competing with the REH.

The paper is organised as follows: The next section (chapter 2) is devoted to clear the notions of confidence/suspicion on the one hand and of pessimism and optimism on the other. We show how optimism/pessimism have been integrated into the theory of finance and of competition on goods' markets etc. It is also discussed whether optimism (pessimism) can be identified with risk love (aversion) and whether it is due to informational deficiencies and/or asymmetries. Chapter 3 then presents our own model of the business cycle, with private consumption as the main driving force of economic activity. We come up with a difference equation of second order (for consumption and income growth rates instead of income levels) in the tradition of Samuelson's seminal paper (1939), which is complicated by the fact that agents hold different attitudes during alternative phases of the cycle, but are also willing to revise their expectations by applying Bayesian learning/updating. Chapter 4 presents some simulation experiments. Chapter 5 questions the empirical evidence of our thoughts. The final chapter 6 addresses conclusions and opens questions for future research.

2 CLEARING KEY NOTIONS: CONFIDENCE VERSUS SUSPICION; SCEPTICISM/PESSIMISM VERSUS OPTIMISM

In the framework of game theory "trust" or "confidence" can be modelled and/or interpreted as a particular *subjective probability* assigned by the principal in the event that the agent implements the required level of input, care etc., which is the action desired by the principal (Demougin 1999,

p. 305). Both players find themselves in an agency relationship characterised by "moral hazard and adverse selection" (ibid., p. 303) and can be taken to be risk-neutral (see below a brief discussion on the attitude towards risk among optimists and pessimists). It is typical for such a game to find a trade-off for the cheating strategy of the agent; on the one hand the direct (short-term) gain of cheating may exceed the rent of implementing the required input but, on the other hand at the (long-term) risk that the game ends. Hence ex-ante, it is not clear whether the expected present value of cheating dominates vis-à-vis implementing.

In our context, we are more interested in game situations where the players are – excluding exceptions – not in an agency relationship, but confronted with the classical prisoners dilemma in a Kydland/Prescott/Barro/Gordon world. What sort of meaning can trust or confidence have here? Obviously, confidence has to be linked to the issue of expectations. According to the view put forward by Maaß and Sell (1998, p. 520), confidence or likewise *confident expectations*, can persist even if a central bank dares to cheat the public as long as cheating is regarded only as a transitory phenomenon and it implies "the belief by private agents that any actual monetary target deviation by the central bank will be 'healed' by a *compensating* policy in the (near) future so that the medium to long-term achievements in the field of price stability is put in danger" (ibid.).

Yet, confidence or trust is not the opposite to scepticism/pessimism (the first being some sort of weaker pessimism) as some papers tend to argue implicitly, but suspiciously. Accordingly, scepticism or pessimism matches optimism (Allen/Faulhaber 1988, p. 398). As our paper is not concerned with confidence/trust versus suspicion/distrust in the first place, we shall concentrate the following on the notions of *optimism* and *pessimism*. When doing so, we are aware of the fact that a number of papers mention "pessimism" or "optimism" in their title (see for example Drazen 1988 or Tallon 2000), but reading those papers, it soon becomes apparent that they are not really interested in either of these terms.

If one would still be interested to relate the notion of confidence to the attitude of optimism, the answer is straightforward: Contrary to the observation of confidence, where at least one individual has to be confident in someone else, optimism (pessimism) in comparison, has to do with (the lack of) *self-confidence*. Moreover, in the definition of Heifetz and Spiegel (2000, pp. 1 and 2), "optimists overestimate the positive impact of their own actions, pessimists underestimate it, and only realists assess it correctly". An interesting result from game theory is that "an optimist who *overestimates* the return to his actions, behaves more "aggressively" than a realist and chooses a higher level of action". Furthermore, when the actions "of one individual impose a *positive externality* on the payoff of rivals, the aggressive behaviour of the optimist triggers a favourable aggressive be-

haviour from rivals" (ibid.). This mechanism obviously not only has a strong link to the phenomenon of the business cycle, but it also fits nicely into the explanation patterns of the *new growth theory*.

Entrepreneurs, who are unrealistically optimistic about the productivity of their own firms, must not necessarily be forced out of business. As Manove (1995, p. 5) explains, optimism regarding productivity of input factors "creates an incentive for agents to increase their savings rates and work effort which can lead to a larger steady-state income". The mechanism involved works like an inverse Lucas critique effect, where new facts trigger new expectations and hence, an adjusted behaviour of agents. Opposed to this, in the Manove model specific expectations trigger new behaviour, thus new economic facts. A negative side effect of the Manove type of optimism is that entrepreneurs hire too many external resources (negative efficiency effect), which in consequence, will be overutilised (ibid., p. 8). The same applies to their internal resources (effort, savings), but this can be understood as a positive incentive effect.

A number of authors identify the attitude of optimism with the observation "that most people are *overconfident* about their own relative abilities, and unreasonably optimistic about their futures" (Camerer/Lovallo 1999, p. 306).^v As a result, economic agents tend to execute economic decisions – like business and/or market entry – which, without misjudging one's own relative skills, might not have occurred. It seems as if optimism comes in here as sort of illusion and/or missing realism, as the subjects concerned "seem to neglect the fact that they are competing with a reference group of subjects who all think they are skilled too" (ibid., p. 307). Max Weber, by the way, has apparently been a strong opponent to any "naive" optimism among philosophers; as Hennis (2001, p. 17) reports, he blamed some of his colleagues for their attempt to find the road to happiness and justice in science. "Who would believe in that", he is quoted, "only great children on their reading desk or in press rooms" (ibid.).

Statistically spoken, a majority of agents pretend to be above the average in skills, although, if the trait is symmetrically distributed, only half of them can be. Optimists are blamed for not thinking that "everybody else is thinking the same way" (ibid., p. 315). We will demonstrate below that this interpretation of optimism/pessimism gives a rather narrow view of the relevant issue, if at all. Because, if the mechanism cited would not exist, one could hardly explain consumers optimism in a macroeconomic framework.

Another possibility to differentiate between confidence and optimism is put forward by Ripperger (1998): As in the case of hopes, optimism is related to *exogenous* risks with the important implication that in principle no contract can be made with the agent who possibly triggers the uncertain

events. As opposed to this, confidence is related to *endogenous* risks, that is in situations where the risk taken by some agent is dependent of the behaviour of another agent. In principle, a contract can be signed between these two agents (*ibid.*, p. 38). Such a contract (see above) may (but must not) be one between an agent and a principal.

Also econometricians tend to identify optimism (pessimism) with *overestimation* (underestimation); as Rasmusen (1998) explains, "if policies are used more where they are more effective at the margin, then both casual empiricism and ordinary least squares estimates are biased towards optimism about the policies" (*ibid.*, p. 65). The analyst may fail in his predictions if he does not take into account that times and places for a policy are not identical. The hotel tax revenue case serves as a good example: "A state's hotel tax is either high or low, trading off revenue against harm to tourism. In 25 states, the high hotel tax would rise \$ 100 in revenue per capita more than the low tax, and those states adopt the tax. In the other 25 states, the higher tax would so discourage business that the change in tax revenue per capita would be \$ 0. The analyst notices that the 25 states with the high tax have \$ 100 higher revenue per capita, a difference that is statistically significant. He therefore advises all states to impose high taxes, even though, in truth, the added benefit (in the former low tax states, the author) is zero. He has overestimated the benefit of increasing the policy's intensity" (*ibid.*, p. 76).

Yet, to be *overconfident* in the impact of one's own actions, or to *overestimate* the effectiveness of a policy adoption, does not cover all aspects of optimism. There are optimists who do not act at all in the sense of an entrepreneur or of an adviser to the policy-maker, but simply as consumers. In their model, Allen and Faulhaber consider a two-periods-decision problem and they define optimism as an *initial belief* (1988, p. 397) or *prior* (*ibid.*, p. 401), which is the probability assigned by consumers to the quality of a good/quality of the inputs used. If this probability is chosen as one (zero), one can speak of extreme optimism (pessimism) which makes learning impossible, as experience is ignored (*ibid.*, p. 401). But for reasonable values for that probability, consumers have the possibility to observe the performance of the good in period 1 and hence to learn: "observations of the output lead them to revise these beliefs" (*ibid.*, p. 397). This information will then affect their willingness to pay for the good in period 2. Building up the reputation of a firm means, in this framework, having a good first period performance.

Optimism/pessimism and consumers have more in common. The optimism of single consumers will be reinforced – and hence translated into a growing consumer demand on the macroeconomic level – once the well-known bandwagon effects (Sell 1997, pp. 8-10) come into play. What has been used to be framed "*herding*" in modern analysis of international financial crises (Sell 2001), has a corol-

lary in the leader-follower relationship in consumption behaviour. Bandwagon effects can work in both directions and so contribute to understanding why consumers beliefs tend to homogenise during both the upswing and the downswing phase of the business cycle. Burdekin and Langdana (1995, p. 145) conclude that there is an "enhancing catalytic effect of consumer sentiment. Therefore, fluctuations in explanatory variables that are not simultaneously accompanied by fluctuations in sentiment, might have a disproportionately lower effect on overall economic activity".

Cautious optimists or pessimists are, as the model explains, able to learn. Then, they should be capable to avoid the *confirmation bias* which is meant to be "the tendency to seek information that confirms one's own views and overlook evidence that may disconfirm these views" (Heifetz/Spiegel 2000, p. 9). An important conclusion emerges here: Optimists, like pessimists, are not irrational individuals. Rather they make forecasts built on the same past set of information, assigning different weights never the less, to the components of this information. A crucial question, however, is to explain *how* optimists/pessimists learn from (present and future) reality. More precisely, the question has to be raised how the learning process can be modelled in such a way that the "irrationality" of adaptive expectations can be avoided. One proposal states that agents have to correct their initial beliefs by adopting the Bayesian rule of learning (Demougin 1999, p. 307).

In finance, optimism and pessimism can be found being used as terms used to describe specific attitudes on the part of the market participants concerning capital markets. Some authors relate optimism/pessimism to uncertainty, others to risk. To Wakker (1990, p. 459), for example, "a pessimist dislikes uncertainty, hence the reduction of uncertainty through hedging will lead to additional appreciation. An optimist, who expects uncertainty to turn out favourable, will not appreciate the reduction of uncertainty through hedging". Opposing this, Anderson (1986, p. 183) defines "the more optimistic agent (in the sense of higher expected period $t+1$ price conditional on private information)", being someone who "invests more in the risky asset than the less optimistic agent". On the other hand, "an agent being pessimistic about the period $t+1$ price will thus find it optimal to invest his whole wealth in the riskless asset rather than in the risky asset" (ibid.). Anderson also stresses however, that "the most optimistic information (the most pessimistic information, the author) is *not* necessarily the most reliable from a social point of view" (ibid., p. 185). In a recent paper, Kyle and Wang (1997, p. 2074) reach an extraordinary result which somehow hits the REH: In a model of two risk-neutral speculative traders, the "overconfident trader may make a higher expected profit and utility than his rational opponent ... and a higher profit and utility than if he were also rational". Moreover, this outcome is not just short-lived and the "survival of overconfidence is due to the fact that overconfidence acts like a commitment device to aggressive trading" (ibid.), a result which nicely complements the *positive externalities* cited above.

Optimism is an issue in the business of making forecasts on financial markets as well; "the analyst's decision to issue optimistic earnings forecasts is based on a comparison of the costs and benefits of doing so. The benefits are derived primarily from higher brokerage commissions and better management relations; the costs relate to analyst reputation and legal liability. When the costs of issuing an optimistic forecast are high relative to the benefits of doing so, optimism will be less apparent or absent" (Espahbodi et al. 2001, p. 3).

The question as to what may cause these different attitudes arises. Is optimism (pessimism) reflecting a risk-loving (risk-averse) character of agents? Or is it that information is imperfect on the one hand and the access to it asymmetrical on the other? Or is information symmetrical, but the valuation of its content asymmetrical? Basically, we follow the answer given to these questions by Kurz (1994); optimism or pessimism are not hinged upon different levels of information and/or upon an asymmetric access to information: "agents may exhibit drastic differences in beliefs even when they have the same information" (ibid., p. 878). Optimism or pessimism do not reflect – analogously to the modelling of trust in an agency relationship (see above) risk-neutrality can be assigned to every player – different risk attitudes, but the formation of a "conditional probability belief .. about the future sequence of random variables" (ibid., p. 879). Though information on past data is the same for everybody, not all agents "hold the same probability belief and make the same forecasts" (ibid., p. 878). It seems indeed, that valuation plays a major role: "important but infrequent events may be assigned (different, the author) significant probabilities" (ibid., p. 893) by different agents. These probabilities are grounded in "subjective criteria which represent individual theories about the environment" (ibid., p. 894).

The impression one acquires from the enormously rich though heterogeneous literature dealing with strong beliefs like optimism or pessimism, is refreshing and encouraging. Can it be that, based on this type of "correctable irrationality", we may get closer to the clues of business cycles and economic growth?

3 THE MODEL

If we want to profit from the insights the relevant literature has to offer and if we also want to implement in a model of the business cycle an observation of the day-to-day economic behaviour,^{vi} cautious optimists and pessimists should be present in the model. We need their prior attitude to understand upward and downward forces in the economy, but we also need them to be learning individuals who are either surprised (the pessimists) or disappointed (the optimists). Otherwise, we could not explain the core issue in any theory of the business cycle: the turning points! If the stylised fact on business cycles – upswings constitute two thirds, downswings one third of one full cy-

cle – continues to work, optimism is a sufficient and necessary condition for the long-term growth perspectives of modern economies which "pure rationality" could fulfil, at best, to a less degree.

Which are our assumptions? *First*, like in Zorn and Martin (1986, p. 166), "all individuals are assumed to be risk neutral which focuses the analysis on differences in individuals' beliefs rather than their attitudes towards risk".

Second: While it is true that "in practice, society is composed of heterogeneous individuals who may differ from one another in their degree of optimism/pessimism" (Heifetz/Spiegel 2000, p. 19), during an upswing/downswing of the economy, the majority of the individuals will share the same attitude. This assumption comes as a sort of mirror to another assumption made by Zorn and Martin: "the more uncertain an outcome the more heterogeneous are beliefs" (ibid., p. 167). In other words: The more all relevant indicators point at an economic upswing (downswing), the more individuals will "convert" to optimism (pessimism). Likewise, one may say that optimism (pessimism) is endogenized by the business cycle itself.

Third: A German proverb says: 'Optimismus ist ansteckend' (optimism is contagious). This is an essential of the model which can additionally explain why there is a strong tendency to homogenise beliefs during the upswing (downswing) of the cycle. It helps to explain reinforcing effects, but of course it cannot help in explaining the turning points.

Fourth: How are optimistic (pessimistic) beliefs associated to each other? There are only two types of belief, one (P) assigning a high probability to (higher) economic growth (y) and the other, a complementary probability ($1-P$) assigning a low probability to (higher) economic growth. More precisely:

$$(1) \quad \text{If } 0 < P \leq 1 \quad \text{and} \quad 0 < (1 - P) \leq 1 \quad \text{for} \quad P = \text{prob}[y_t > y_{t-1}] \quad \text{and} \\ (1 - P) = \text{prob}[y_t \leq y_{t-1}] \quad \text{where } P, (1-P) \text{ stand for subjective probabilities.}$$

Fifth: As in Grant/Karni (2000, p. 1), we assume that the decisions makers' beliefs (optimism versus pessimism), are represented by these subjective probabilities. Moreover, according to these authors, "the subjective probabilities are the *unique* representation of decision-makers' beliefs" (ibid., p. 3). In our context, those agents which give P values of higher than 0.5, shall be identified as optimists, while those who give P values of less than or equal to 0.5, respectively, are identified as pessimists. The expected income growth given beliefs (Zorn/Martin 1986, p. 166) then is:

$$(2) \quad E[y_t] = y_t^e = P y_t^P + (1 - P) y_t^{(1-P)}$$

This assumption has several implications: All in all, we have to take into account – with regard to the same observation period – three different growth rates. The first is the actual growth rate, y_t . The second is the growth rate assigned to the optimist, y_t^P and the complementary growth rate assigned to the pessimist, $y_t^{(1-P)}$. The third is the expected growth rate, y_t^e computed as given by equation (2) with

$$(3) \quad y_t^P > y_{t-1} \quad \text{and} \quad y_t^{(1-P)} \leq y_{t-1}$$

For convenience, we define:

$$(4) \quad y_t^P = y_{t-1} + \mathbf{s}^P \quad \text{and} \quad y_t^{(1-P)} = y_{t-1} - \mathbf{s}^{(1-P)} \quad \text{with} \quad \mathbf{s}^P > 0; \mathbf{s}^{(1-P)} \geq 0$$

Optimism (pessimism) hence, has always two components: the occurrence of a desired (feared) growth rate on the one hand and the assigned likelihood to that incident on the other. How is the consumption function formalised? Agents decide on the rate of expenditure growth (c_{t+1}) in period 2 ($t+1$), based on past consumption growth (c_t) and on experiences made in period 1, in conjunction with their own expectations regarding income growth ($f[(y_t - y_t^e)]$); expectations, in turn, depend on weighted calculations vis-à-vis to period 0:

$$(5) \quad c_{t+1} = c_t + f[(y_t - y_t^e)] = c_t + f \left[y_t - \left\{ \begin{array}{l} P(y_{t-1} + \mathbf{s}^P) \\ + [(1-P)(y_{t-1} - \mathbf{s}^{(1-P)})] \end{array} \right\} \right]$$

or, centred on period t :

$$(6) \quad c_t = c_{t-1} + f[(y_{t-1} - y_{t-1}^e)] = c_{t-1} + f \left[y_{t-1} - \left\{ \begin{array}{l} P(y_{t-2} + \mathbf{s}^P) \\ + [(1-P)(y_{t-2} - \mathbf{s}^{(1-P)})] \end{array} \right\} \right]^{vii}$$

Collecting terms gives:

$$(7) \quad c_t = c_{t-1} + f[(y_{t-1} - y_{t-1}^e)] = c_{t-1} + f[y_{t-1} - y_{t-2} - P\mathbf{s}^P + (1-P)\mathbf{s}^{(1-P)}]$$

The first term of the consumption function on the right hand side of (7) brings in the so-called "habit persistence hypothesis", introduced first by Brown in 1952 (Sell 1982, p. 49) and provided with empirical evidence in many econometric studies (see for example Lüdeke et al. 1983, pp. 42-50 and, more recently, Dynan 1993). The second term on the right hand side captures (positive)

surprises^{viii} or (negative) disillusion with regard to income growth in the immediate past. In line with Carroll et al (1994, p. 1407), we suspect that "it is no longer clear that all relevant information about the expected current growth rate of consumption should be contained in the lagged growth rate of consumption".

Notice that the consumption function can neither be confounded with a random walk – the second term on the right hand side can never become/be reduced to the error term u_t or a function of it – nor is the implied learning process identical to adaptive expectations. Also, we do not agree with those who make a distinction between "Rule-of-thumb" consumers on the one hand and "Rational life-cycle" consumers (Carroll et al. 1994, pp. 1401/2) on the other. It is hardly conceivable to create two types of rationality in a Lucas-Barro-Sargent-Wallace world (at least, for the vast majority of economists!). As opposed to this, in our framework, optimism and pessimism belong to the same category of (ir)rationality.

Sixth: If a pessimist (an optimist) is surprised (disappointed), the concomitant revision of his expectations can induce the lower (upper) turning point of the business cycle. If a pessimist (optimist) is confirmed by the economic realities, this reinforces the downswing (upswing) of the business cycle.

This assumption should be explained further. The three relevant growth rates mentioned above can be related to each other in the following four^{ix} inequalities:

$$(i) \quad y_t < y_t^{(1-P)} < y_t^e$$

$$(ii) \quad y_t^{(1-P)} < y_t^e < y_t$$

$$(iii) \quad y_t^P > y_t^e > y_t$$

$$(iv) \quad y_t > y_t^P > y_t^e$$

In the first case, "bad news is confirmed", a situation where the overwhelming majority of consumers cannot but refrain from their demand. The second case leads to the lower turning point, as a "positive surprise" will make pessimists rethink their attitude. Most likely, if good news is reproduced several times, they will switch to become optimists. The third case occurs in an optimistic environment and is associated with "disillusion and disappointment" on the side of the optimists. Again, if bad news is reproduced, optimists may switch to become pessimists and the upper turning point of the business cycle is reached. In the last case, "good news is confirmed" and back the judgement of an optimistic environment so that the upswing of the economy will be fostered.

In the following [Table 1](#) we have put together all four cases; as one can see, they are the result not only of different types of errors, but also the consequence of different attitudes. Notice that in principle, a third row dedicated to the "neutrals" exists, who, almost by definition, have rational expectations. Their errors can hence only be due to unforeseen shocks, as it is maintained in the NCM or in "Monetarism II". With these stylised cases we are able to characterise the typical four phases of a full business cycle.

Table 1: Errors Committed by Optimist, Pessimists and Neutrals

Agents \ Type of Error	Overestimation ($y_t < y_t^e$)	Underestimation ($y_t > y_t^e$)
Pessimists $(y_t^{(1-P)} > y_t^e)$	$y_t < y_t^{(1-P)} < y_t^e$ "bad news are confirmed" $y_t^{(1-P)} < y_t < y_t^e$ → recession	$y_t^{(1-P)} < y_t^e < y_t$ "positive surprise" → end of recession
Optimists $y_t^P > y_t^e$	$y_t^P > y_t^e > y_t$ "disillusion and disappointment" → end of boom	$y_t > y_t^P > y_t^e$ "good news are confirmed" $y_t^P > y_t > y_t^e$ → boom
Neutrals $y_t^P = y_t^{(1-P)} = y_t^e$	traditionally: Monetarism II	traditionally: Monetarism II

Source: Own compilation.

Let us make a heuristic numerical example for each of the aforementioned cases and let consumer demand in the past grow at the rate of total income growth; we start (at $y_{t-1} = 0.03$; $y_{t-2} = 0.025$; $c_{t-1} = 0.03$; $P = 0.6$; $(1-P) = 0.4$; $s^P = 0.003$; $s^{(1-P)} = 0$) with the last case (iv), which is located in an upswing phase of the economy (that is, s^P is positive, but small) and agents are optimistic but not euphoric (P is modest):

$$\begin{aligned}
 (8) \quad c_t &= 0.03 + f [0.03 - \{0.6(0.025 + 0.003) + 0.4(0.025)\}] \\
 &= 0.03 + f [0.0032] > 0.028 > 0.0268
 \end{aligned}$$

Remember that in this situation we find ourselves already in an optimistic environment for the consumers, so that the *optimists are confirmed* in their beliefs. That is why the upswing of the economy is backed, or even reinforced.

What, if (iii) the *optimists are disappointed*? This result can be achieved easily (now with $y_{t-1} = 0.03$; $y_{t-2} = 0.025$; $c_{t-1} = 0.03$; $P = 0.9$; $(1 - P) = 0.1$; $\mathbf{s}^P = 0.008$; $\mathbf{s}^{(1-P)} = 0$), whenever the boom of the cycle is almost reached (so that \mathbf{s}^P is positive and high) and agents' optimism is "too strong" (and hence P is very high).

$$(9) \quad \begin{aligned} c_t &= 0.03 + f [0.03 - \{[0.9(0.025 + 0.008)] + [0.1(0.025)]\}] \\ &= 0.03 + f [-0.0022] < 0.0322 < 0.033 \end{aligned}$$

For a numerical example of the last two cases, we have to bear in mind that the economy is now in a recession. At the very bottom of the business cycle, pessimism is deep (means $(1 - P)$ is high) and expected growth is extremely low ($\mathbf{s}^{(1-P)}$ is high). This first relevant situation can be illustrated by the following numbers (suppose the variables/parameters are now $y_{t-1} = 0.025$; $y_{t-2} = 0.025$; $c_{t-1} = 0.025$; $P = 0.1$; $(1 - P) = 0.9$; $\mathbf{s}^P = 0.003$; $\mathbf{s}^{(1-P)} = 0.005$) and leads to the phenomenon that (ii) *pessimists are (positively) surprised*:

$$(10) \quad \begin{aligned} c_t &= 0.025 + f [0.025 - \{[0.1(0.025 + 0.003)] + [0.9(0.025 - 0.005)]\}] \\ &= 0.025 + f [0.0042] > 0.0208 > 0.020 \end{aligned}$$

The last of our cases (i) represents a situation during economic recession, long before reaching the bottom of the cycle (means $(1 - P)$ is moderate and $\mathbf{s}^{(1-P)}$ is low or insignificant) and can substantiate the case where the *pessimists are confirmed* (suppose the numbers are now $y_{t-1} = 0.025$; $y_{t-2} = 0.025$; $c_{t-1} = 0.025$; $P = 0.4$; $(1 - P) = 0.6$; $\mathbf{s}^P = 0.003$; $\mathbf{s}^{(1-P)} = 0$):

$$(11) \quad \begin{aligned} c_t &= 0.025 + f [0.025 - \{[0.4(0.025 + 0.003)] + [0.6(0.025)]\}] \\ &= 0.025 + f [-0.0012] < 0.025 < 0.0262 \end{aligned}$$

Before we proceed to further assumptions, it is worth thinking about the implied density functions which can be assigned to the different subjective probabilities in our four scenarios. Suppose in the first place, that economic growth rates are distributed symmetrically following, by and large, a normal distribution. In [Figure 1](#) we have depicted the cases which stand for agents' optimism, in [Figure 2](#) we have the two cases for pessimism, respectively.

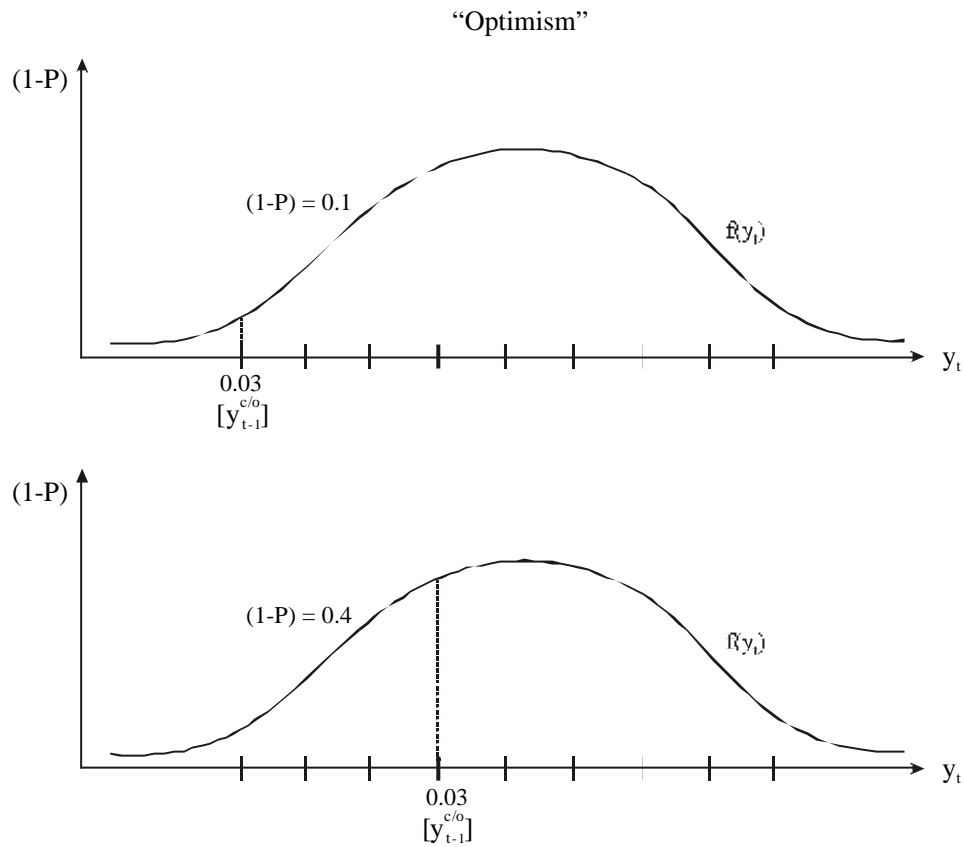
Figure 1: Probabilistic Interpretation of Pessimism

Source: Own compilation.

In each of the Figures, optimism or pessimism is represented geometrically by the surface under the distribution and to the left of the *critical past income growth rates*, $y_{t-1}^{c|j}$, given a pessimistic or optimistic scenario. Notice that $j = o, p$ stand for the optimistic (o) and for the pessimistic (p) situation (the numbers are 0.03 and 0.025 respectively) and c is the superscript standing for "critical". Analytically, the corresponding expression is:

$$(12) \quad \int_{-\infty}^{y_{t-1}^{c|j}} f(y_t) dy_t = \text{prob}[y_t \leq y_{t-1}] = (1-P); \quad j = o, p$$

Figure 2: Probabilistic Interpretation of Pessimism

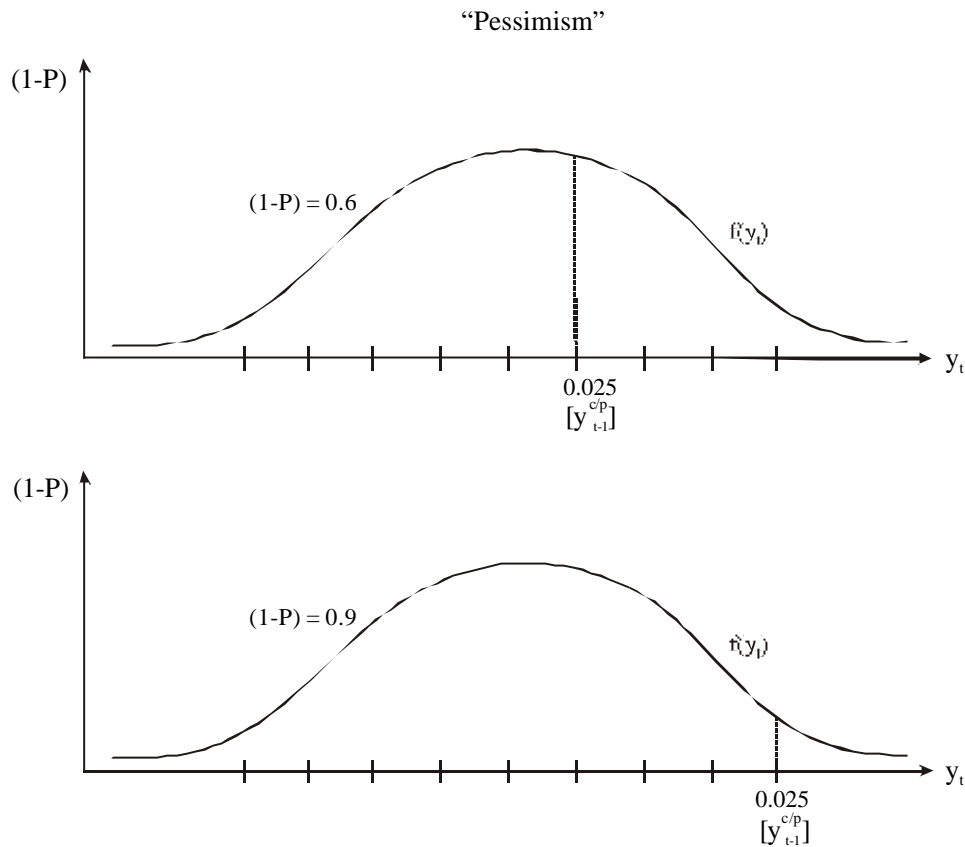

Source: Own compilation.

Seventh: The revision of optimistic or pessimistic expectations follows the rules of Bayesian updating.^x

This is supposed to be the most sophisticated assumption of the model, being, at the same time, completely indispensable. Otherwise, consumers would not be learning and would therefore be affected by what psychologists are used to call "perseverance". First of all it trivially implies that:

$$(13) \quad [P_t, (1 - P_t)] = g(t)$$

In order to learn or, likewise, to update the subjective probabilities, agents have to take into account favourable or less favourable information about the course of the economy; if the information captured is favourable (unfavourable), optimism (pessimism) should be maintained (corrected upwards). What should be the yardstick for a favourable (unfavourable) economic development? Our suggestion is to take the long-run steady state growth rate of the economy, y^* . A simple means to detect a favourable (unfavourable) piece of information^{xi} then is:

$$(14) \quad q_t (y_{t-1}, y^*) = \begin{cases} 1+i & y_{t-1} > y^* \\ 1 & y_{t-1} = y^* ; i > 0 \\ 1-i & y_{t-1} < y^* \end{cases}$$

The actual growth rates of the economy in consideration (y_t) fluctuate around the long-run steady state growth rate of the economy, y^* , as it is depicted in [Figure 3](#). The latter can be derived either from a neo-classical, or from a new growth theory model. Assuming, for convenience, zero population growth in either case, the per capita growth equals the absolute growth rate. The numbers chosen correspond to our numerical example.

Figure 3: Growth Cycles and the Steady State

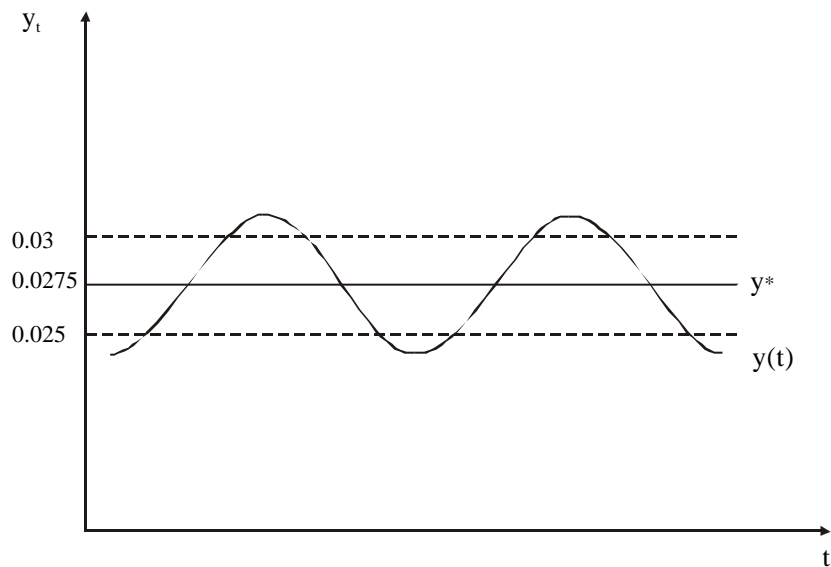

Source: Own compilation.

The upper and lower numbers for economic growth we make use of in [Figure 3](#), are those we already applied in our examples (i) through (iv); the equilibrium or trend growth rate (for income and consumption), y^* , is assumed to be 0.0275 and is located symmetrically between the interim upper and lower bounds. In doing so, we are a little more "conservative" than Lucas (1990, p. 23), who argues with a benchmark value of consumption growth of 0.03. Again, according to him, one standard deviation of the log of consumption, is about 0.013, (two-sigma event $\cong 0.025$) which would imply – in our case – bounding edges in the neighbourhood of 0.0405 and 0.0145 (not marked in [Figure 3](#)).

Bayesian updating then has, for a discrete period, the following form:^{xiii}

$$(15) \quad (1 - P_t) = \frac{q(1 - P_0)}{P_0 + q(1 - P_0)} = \begin{cases} = (1 - P_0) & q = 1 \\ > (1 - P_0) & q < 1 \\ < (1 - P_0) & q > 1 \end{cases} \Rightarrow P_t = \frac{P_0}{P_0 + q(1 - P_0)}$$

If consumers observe the economy all the way to period t , then:

$$(16) \quad (1 - P_t) = \frac{q_t(1 - P_{t-1})}{P_{t-1} + (1 - P_{t-1})q_t} = \begin{cases} = (1 - P_{t-1}) & q_t = 1 \\ > (1 - P_{t-1}) & q_t < 1 \\ < (1 - P_{t-1}) & q_t > 1 \end{cases} \Rightarrow P_t = \frac{P_{t-1}}{P_{t-1} + (1 - P_{t-1})q_t}$$

Pessimism, hence, increases if unfavourable information is observed by private consumers. Not only $P_t, (1 - P_t)$ are time-variant, but are also as our numerical examples tended to support, $\mathbf{s}^P, \mathbf{s}^{(1-P)}$. The most simple approach states (see above) that:

$$(17) \quad [\mathbf{s}_t^P, \mathbf{s}_t^{(1-P)}] = h[t, P_t, (1 - P_t)]$$

As our numerical examples tended to suggest, optimism (pessimism) always has two components: the occurrence of an expected (feared) incident plus the associated probability. These components are not independent, but correlate with each other. In [Figure 4](#), we have depicted this relationship in the first quadrant. The positive correlation may be strong (then the line is steep according to \mathbf{a}) or weak (then the line is flat according to \mathbf{a}'). In each case the line can only start once a minimal probability has been surpassed. In quadrant four the falling line represents a continuum of probabilities, constrained by the adding-up condition. Quadrant three encompasses the 45 degree line, which helps to translate the results of the first and of the fourth quadrant into the second quadrant. The main result of the second quadrant is to show that the subjective probability chosen by the pessimist (optimist), implicitly determines (because, basically, the numbers have to add up) the size of the expected (feared) incident.

$$(18) \quad \mathbf{s}_t^P = -a + bP_t \Rightarrow P_t = \frac{\mathbf{s}_t^P + a}{b}; \quad a, b > 0$$

$$(19) \quad \mathbf{s}_t^{(1-P)} = -c + d(1 - P_t) \Rightarrow (1 - P_t) = \frac{\mathbf{s}_t^{(1-P)} + c}{d}; \quad P_t = -\frac{\mathbf{s}_t^{(1-P)} + c}{d} + 1;$$

$c, d > 0$

From that we can conclude that either:

$$(20) \quad s_t^P = -a + b \left[\frac{d - (s_t^{(1-P)} + c)}{d} \right] \text{ or}$$

$$(21) \quad s_t^{(1-P)} = -c + d \left[\frac{b - (s_t^P + a)}{b} \right]$$

Figure 4: Growth Expectations as a Function of Optimism (Pessimism)

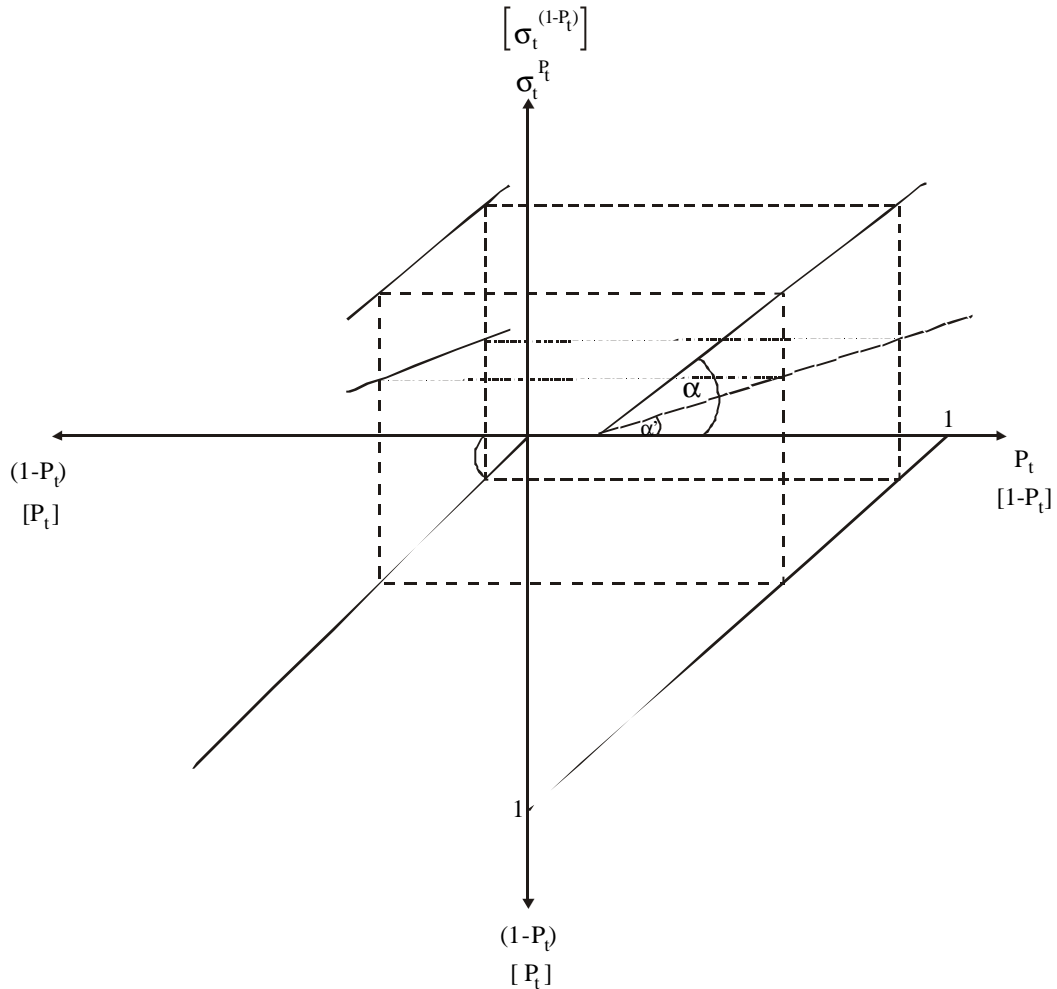

Source: Own compilation.

Before we can proceed to the solution of the model, we should close it. Thus far, we have a tentative explanation of consumer behaviour under the influence of optimism and pessimism. For convenience, we restrict ourselves to a closed economy with private transactions only. The usual definition holds:

$$(22) \quad Y_t = C_t + I_t$$

The model, however, is formulated in growth rates and not in levels. Hence we transform (22) into:

$$(23) \quad y_t = \frac{C_t}{Y_t} c_t + \frac{I_t}{Y_t} i_t$$

If we postulate – as done implicitly above in the numerical examples – that income growth equals consumption growth:

$$(24) \quad y_t = c_t$$

then (23) becomes

$$(25) \quad c_t \left(1 - \frac{C_t}{Y_t} \right) = \frac{I_t}{Y_t} i_t \rightarrow i_t = \frac{\left(1 - \frac{C_t}{Y_t} \right)}{I_t / Y_t} c_t$$

We define:

$$(26) \quad \frac{C_t}{Y_t} = \mathbf{b} ; \quad \frac{I_t}{Y_t} = (1 - \mathbf{b})$$

If both of these shares are assumed constant, we achieve:

$$(27) \quad i_t = \frac{(1 - \mathbf{b})}{(1 - \mathbf{b})} c_t = c_t$$

$$(28) \quad y_t = c_t = i_t$$

As a result, the analysis of short-term and long-term income, or likewise investment development, can be reduced to the analysis of income growth. Given this result, our key equation from above simplifies to:

$$(29) \quad y_t = y_{t-1} + f \left[(y_{t-1} - y_{t-1}^e) \right] = y_{t-1} + f \left[\begin{array}{l} y_{t-1} - y_{t-2} - P_{t-1} \mathbf{S}_{t-1}^P \\ + (1 - P_{t-1}) \mathbf{S}_{t-1}^{(1-P)} \end{array} \right]$$

All in all, the model contains 8 endogenous variables and 3 exogenous variables. When specifying the function $f(\cdot)$ in (29) as a linear function $\mathbf{g}(\cdot)$, introducing (14) into (16) and the latter into (18) and (19) which enter together into (29), equation (29) is an inhomogenous difference equation of the second order. Introducing:

$$(30) \quad -P_{t-1} \mathbf{S}_{t-1}^P = aP_{t-1} - bP_{t-1}^2$$

and

$$(31) \quad (1 - P_{t-1}) \mathbf{s}_{t-1}^{(1-P)} = -c(1 - P_{t-1}) + d(1 - P_{t-1})^2 = -c + cP_{t-1} + d - 2dP_{t-1} + dP_{t-1}^2$$

gives:

$$(32) \quad y_t = y_{t-1} + \mathbf{g} \left[y_{t-1} - y_{t-2} + (d-b)P_{t-1}^2 + (d-c) + (a+c-2d)P_{t-1} \right]$$

From the logic of the model, in equilibrium, the likelihood for pessimism and for optimism should be about the same. Hence,

$$(33) \quad P_0 = P_{t-1} = P^* = 0,5$$

Then, we get, for $y_t = y_{t-1} = y_{t-2} = y^*$:

$$(34) \quad y^* = y^* + \mathbf{g} [0,5a - 0,025b + 0,5c + 0,025d]$$

From (34) we can conclude that the term in brackets necessarily equals zero. Hence,

$$(35) \quad d = b - 20(a + c)$$

As (14) and (16) are formulated as contingent equations, a straightforward solution of the homogeneous problem of (32) is somehow complicated. Therefore, we proceed to a simulation exercise which neither eliminates any important information of the model, nor is a hindering factor for an in-depth analysis of the properties of the cycle. The parameter restriction found in (35) is accomplished in all simulation experiments.

4 A SIMULATION EXERCISE

As Lucas has observed, any sensitive model of the business cycle should not contradict specific regularities which were observed as co-movements among different aggregate time series (1994, p. 217). What about these co-movements in our model? The following experiments have primarily a heuristic aim: First of all we intend to show that the model is able to create – under plausible parameter assumptions – cycles of the real growth rate (consumption or likewise income). Secondly, we shall demonstrate that the model can as well "produce" (i) converging oscillations (both at a higher and at a lower new equilibrium), (ii) exploding oscillations as (iii) permanent oscillations. Figures 5 and 7 are cases for (i), Figures 9 and 10 are cases for (ii), and Figures 6 and 8 are cases for (iii).

Figure 5: Cycles of the Real Growth Rate (Case 1)

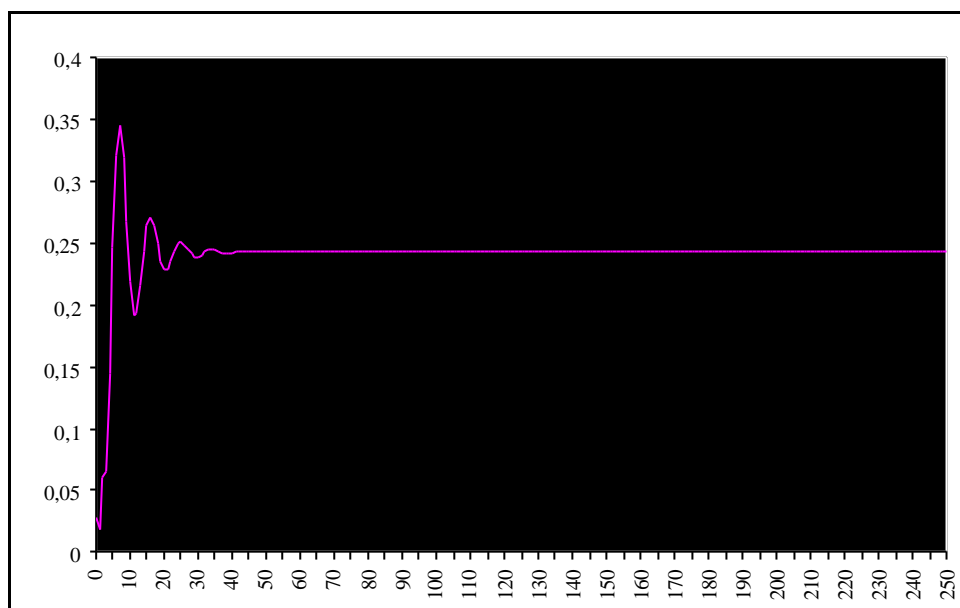

$$g = 0.33; y^* = 0.0275; P_0 = 0.5; i = 0.8; a = -0.02; b = 0.05; c = -0.03; d = 1.05$$

Source: Own calculation.

Figure 6: Cycles of the Real Growth Rate (Case 2)

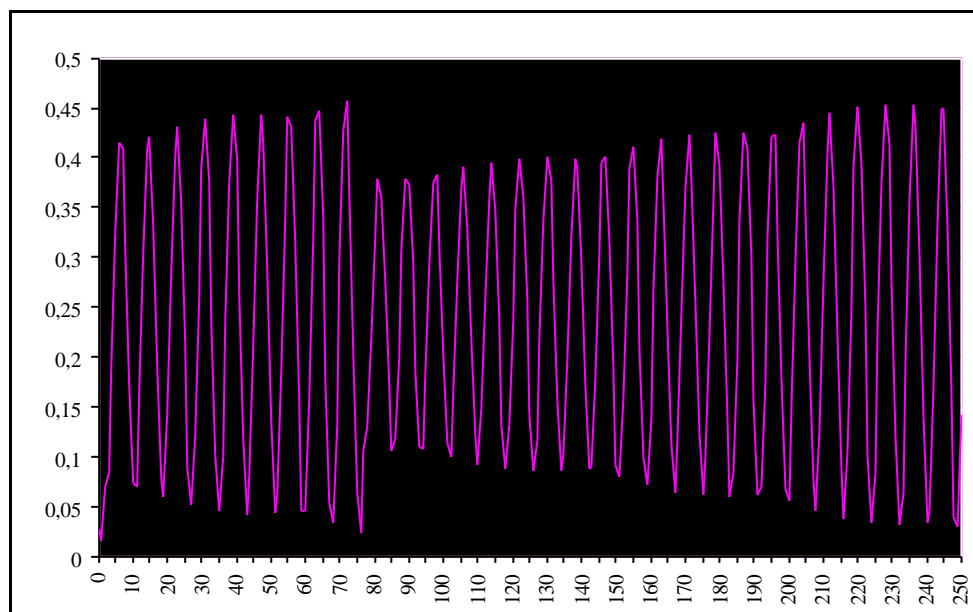

$$g = 0.44; y^* = 0.0275; P_0 = 0.5; i = 0.8; a = -0.02; b = 0.05; c = -0.03; d = 1.05$$

Source: Own calculation.

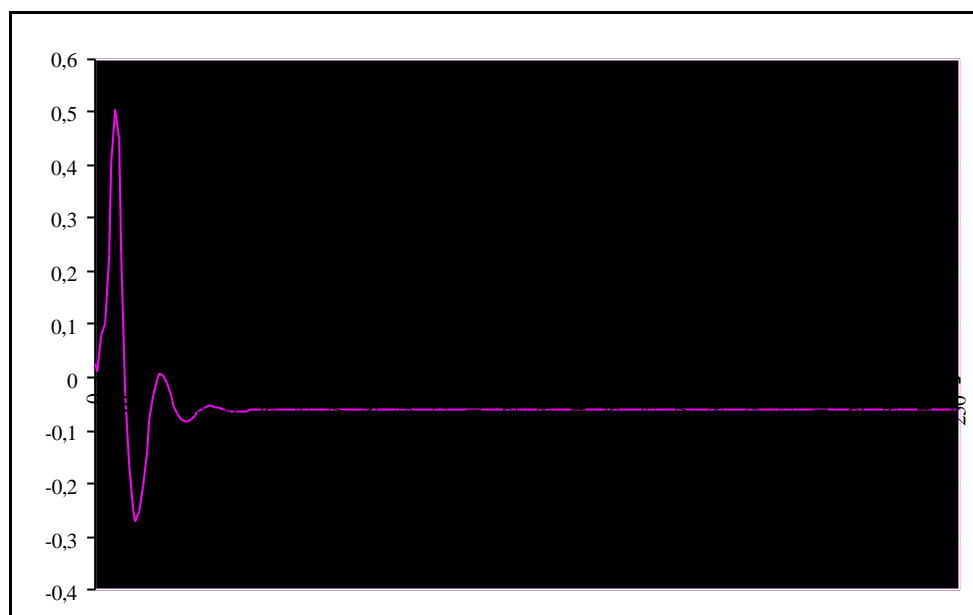
Figure 7: Cycles of the Real Growth Rate (Case 3)

$$g = 0.55; y^* = 0.0275; P_0 = 0.5; i = 0.8; a = -0.02; b = 0.05; c = -0.03; d = 1.05$$

Source: Own calculation.

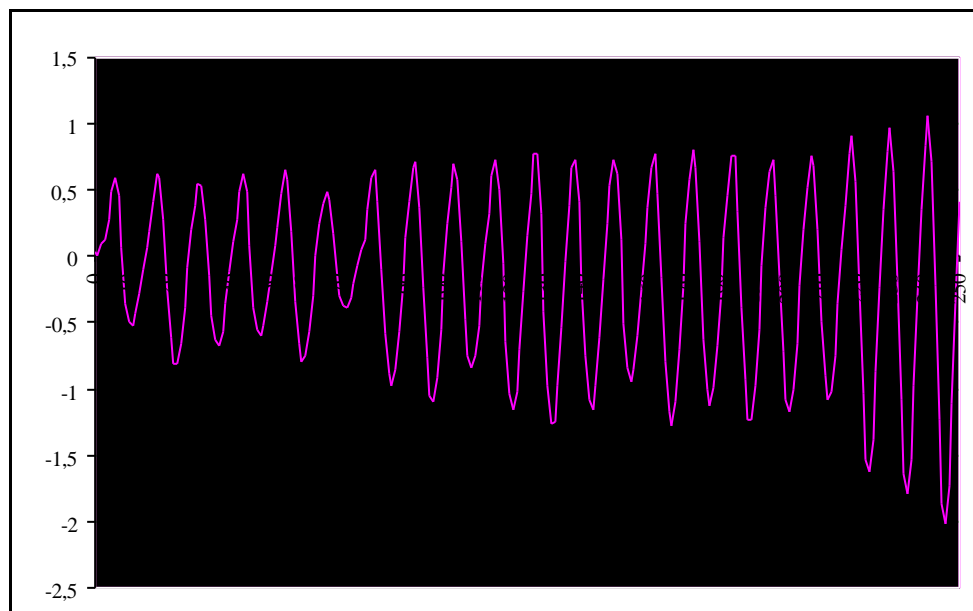
Figure 8: Cycles of the Real Growth Rate (Case 4)

$$g = 0.66; y^* = 0.0275; P_0 = 0.5; i = 0.8; a = -0.02; b = 0.05; c = -0.03; d = 1.05$$

Source: Own calculation.

Figure 9: Cycles of the Real Growth Rate (Case 5)

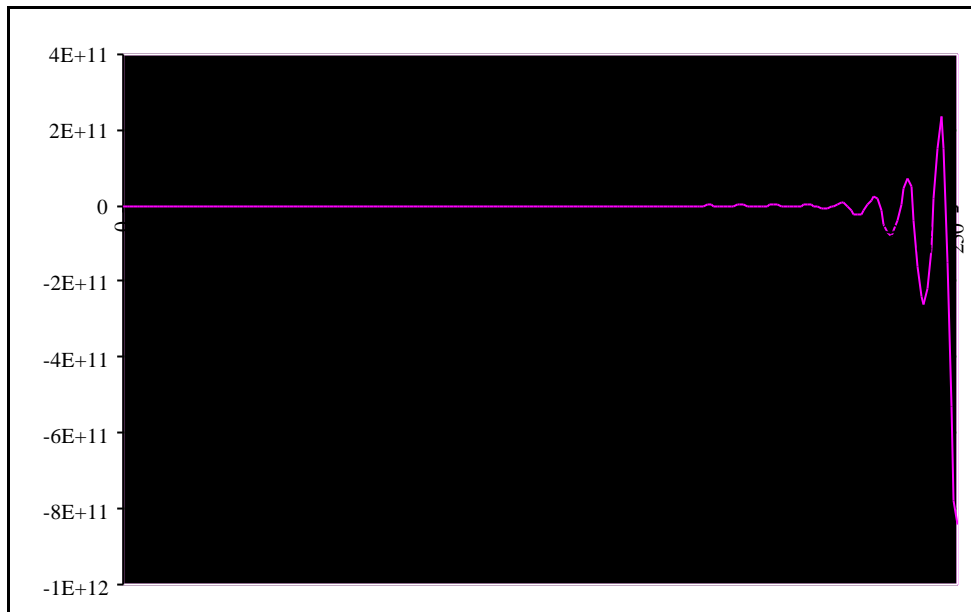

$$g = 0.77; y^* = 0.0275; P_0 = 0.5; i = 0.8; a = -0.02; b = 0.05; c = -0.03; d = 1.05$$

Source: Own calculation.

Figure 10: Cycles of the Real Growth Rate (Case 6)



$$g = 0.88; y^* = 0.0275; P_0 = 0.5; i = 0.8; a = -0.02; b = 0.05; c = -0.03; d = 1.05$$

Source: Own calculation.

In all of the above experiments, we have maintained all parameters constant with the exception of γ ; the latter, we have increased from 0.33 in [Figure 5](#) up to 0.88 in [Figure 10](#).

5 EMPIRICAL EVIDENCE?

The majority of papers intending to make use of indicators which could reflect consumers' beliefs, draw on measures of so-called "*consumer confidence*" (Acemoglu/Scott 1994, p. 1) or "*consumer sentiment*" (Delorme Jr et al. 2001, p. 864). The Gallup-Survey, for example, takes into account (and later averages over them) responses to five questions given by consumers who were asked about their last year experiences with "general economic conditions" and their "household finances", the "expectations of change" in these variables over the next year and, finally about whether "it is a good time to make a major purchase" (Acemoglu/Scott 1994, p. 3). However, computing a simple average of these responses is like comparing apples with pears: Whereas having positive (negative) expectations regarding the future in the forward looking answers reveals, by and large, the size of optimism (pessimism) among the interviewed people, the backward looking answers – and also the answer with regard to the propensity to purchase in the present – give some hint as to what extent people were surprised (disillusioned) in the immediate past. The multidimensionality of combining different attitudes with different types of errors gets lost, if one simply identifies low (high) confidence with "consumers (being) depressed (glad) and pessimistic (optimistic) about the current state of the economy" (Delorme Jr et al. 2001, p. 866). In this simplistic view, pessimism (optimism) is "caused" by a good (bad) expected state of the economy and it is no longer possible to explain the business cycle as being driven by strong private beliefs among private agents and the corresponding updating of these beliefs according to the development of the economy. If agents are either just "pessimistic" or "optimistic", then there is no room for explaining the turning-points in the business cycle.

The ICS (University of Michigan) is based also on the responses to five questions; "among the five questions used to compile the index are two major components: One reflects consumer assessments of current economic conditions; another focuses on expectations about the future" (Kinsey/Collins 1990, p. 206). These two components of the ICS "make up two separate indices called the index of consumer expectations (ICE) and the index of current economic conditions (ICEC)" (ibid.). This separation is an improvement, but still: How are expectations towards the future and the perception of the present related to each other? In a rational expectations framework Kinsey and Collins (1990, pp. 209-214) estimate the ICE as, among other things, a function of the ICEC. This procedure is, if at all, only half way of explaining the disillusion of optimists/positive surprise of pessimists. Rather it is in line with two of our four scenarios in [Table 1](#): "good (bad) news is confirmed".

Notwithstanding these shortcomings, many of those papers come up basically with a correct message: Not only is the state of the economy reflected in consumers' confidence, but also "consumer sentiment causes fluctuations in GNP" (Matusaka/Sboordone 1995, p. 297). Empirical investigations support the presumption that consumer confidence is positively (negatively) correlated with good (bad) news from the real macro-economy (Delorme Jr et al. 2001, p. 866). It can also be shown that indicators of consumers' confidence do work as leading indicators for the change in the consumption of goods (ibid., p. 868). There is also econometric evidence for the hypothesis that "exogenous changes in consumer sentiment have real effects on output" (Matusaka/Sboordone 1995, p. 317). Why this can be and how it can be, were key questions addressed in this paper.

6 SOME CONCLUSIONS AND THE SCOPE FOR FUTURE RESEARCH

It seems as if not only positive or negative "surprises" in a Lucas-Barro-Sargent-Wallace world can induce significant real effects on the (supply side) of the economy. In our model, where the economy is driven by the growth of consumption and investment plays a merely passive role, positive surprises among pessimists and disillusion among optimists, are the keys for the explanation of the turning points during a business cycle. The confirmation of good (bad) news helps to explain the persistence of a boom (recession). This insight is both consistent with the long lasting upswing of the US economy during the Clinton years, as also with the reluctance of the European economy to achieve a more dynamic momentum.

This paper can be understood as only a first step into a broad field of research, both on a theoretical and on an empirical basis. Most likely, we economists should learn more about strong beliefs of economic agents such as "optimism" and "pessimism". It is also more than likely that a discipline such as psychology, can contribute to a better understanding of these human attitudes. In particular, we should analyse in more depth, the preconditions for the likelihood of agents switching from one mood to another. What about persistence and hysteresis effects, which we have not touched at all in our exposition? Also, the indicators mentioned and used in the present by research institutes for the prediction of economic growth and consumption expenditures purposes, should be revised according to a thorough identification of items. Judgements of private agents with regard to the present state of the economy, the future prospects of growth and, finally, with regard to the (expected or unexpected) achievements in the immediate past, should be collected and analysed separately and not be aggregated to a diffuse measure of "confidence".

REFERENCES

- Acemoglu, D./Scott, A.* (1994): Consumer Confidence and Rational Expectations: Are Agent's Beliefs Consistent with the Theory?, in: *The Economic Journal*, Vol. 104, No. 422, pp. 1-19.
- Albert, M.* (1999): Kommentar zu T. Ripperger: Die Effizienz des Vertrauensmechanismus bei der Organisation internationaler Transaktionen, in: K.-E. Schenk et al. (Eds.): *Globalisierung und Weltwirtschaft*, Tübingen, pp. 292-301.
- Allen, F./Faulhaber, G. R.* (1988): Optimism Invites Deception, in: *Quarterly Journal of Economics*, Vol. 103, No. 2, pp. 397-407.
- Anderson, T. M.* (1986): Speculation, Optimism and Differential Information, in: *The Southern Economic Journal*, Vol. 53, No. 1, pp. 170-186.
- Bank of England* (2001): Inflation Reports, Issues of February 2001, URL: <http://www.bankofengland.co.uk/inflationreport/ir01feb.pdf> from 10 December 2001.
- Britton, E./Fisher, P./Whitley, J.* (1998): The Inflation Report Projections: Understanding the Fan Chart, in: *The Bank of England Quarterly Bulletin*, February, pp. 30-37.
- Burdekin, R. C. K./Langdana, F. K.* (1995): *Confidence, Credibility and Macroeconomic Policy: Past, Present, Future*, London.
- Camerer, C./Lovallo, D.* (1999): Overconfidence and Excess Entry: An Experimental Approach, in: *The American Economic Review*, Vol. 89, No. 1, pp. 306-318.
- Carroll, C. D./Fuhrer, J. C./Wilcox, D. W.* (1994): Does Consumer Sentiment Forecast Household Spending? If So, Why?, in: *The American Economic Review*, Vol. 84, No. 5, pp. 1397-1408.
- Delorme Jr, C. D./Kamerschen, D. R./Voeks, L. F.* (2001): Consumer Confidence and Rational Expectations in the United States Compared with the United Kingdom, in: *Applied Economics*, Vol. 33, No. 7, pp. 863-869.
- Demougin, D.* (1999): Kommentar zu T. Ripperger: Die Effizienz des Vertrauensmechanismus bei der Organisation internationaler Transaktionen, in: K.-E. Schenk et al. (Eds.): *Globalisierung und Weltwirtschaft*, Tübingen, pp. 302-310.
- Diamond, N.* (1992): *The Greatest Hits 1966-1992*, Sony Music Entertainment Inc. (02-471502-10).
- Dornbusch, R./Fischer, S.* (1994): *Macroeconomics*, Sixth Edition, New York.
- Drazen, A.* (1988): Self-Fulfilling Optimism in a Trade-Friction Model of the Business Cycle, in: *The American Economic Review*, Vol. 78, No. 2, pp. 369-372.

- Dynan, K. E. (1993): *Habit Formation in Consumer Preferences: Evidence from Panel Data*, Board of Governors of the Federal Reserve System Economic Activity Working Paper No. 143, October.
- Espahbodi, R./Dugar, A./Tehrani, H. (2001): Further Evidence on Optimism and Underreaction in Analysts' Forecasts, in: *Review of Financial Economics*, Vol. 10, No. 1, pp. 1-21.
- Flavin, M. A. (1981): The Adjustment of Consumption to Changing Expectations about Future Income, in: *Journal of Political Economy*, Vol. 89, No. 5, pp. 974-1009.
- Frisch, R. (1933): Propagation Problems and Impulse Problems in Dynamic Economics. *Economic Essays in Honour of Gustav Cassel*, London, pp. 171-205.
- Garrison, R. W. (1991): New Classical and Old Austrian Economics: Equilibrium Business Cycle Theory in Perspective, in: *The Review of Austrian Economics*, Vol. 5, No. 1, pp. 91-103.
- Grant, S./Karni, E. (2000): A Theory of Quantifiable Beliefs, Working Paper No. 427, Department of Economics, John Hopkins University.
- Heifetz, A./Spiegel, Y. (2000): On the Evolutionary Emergence of Optimism, Working Paper No. 24-2000, The Eitan Berglas School of Economics, Tel-Aviv University.
- Hennis, W. (2001): Griechentum und Pessimismus: Max Weber und Thukydides, Mimeo, Freiburg i. Br.
- Kades, E. (1985): New Classical and New Keynesian Models of Business Cycles, in: *Federal Reserve Bank of Cleveland Economic Review*, Vol. 1985, No. 4, pp. 20-35.
- Kinsey, J./Collins, M. I. (1990): The Consumer Sentiment Index: Rational Expectations and Behaviour, in: R. N. Mayer (Ed.): *Enhancing Consumer Choice: Proceedings of the Second International Conference on Research in the Consumer Interest*, American Council on Consumers Interests, Columbia, pp. 205-218.
- Kurz, M. (1994): On the Structure and Diversity of Rational Beliefs, in: *Economic Theory*, Vol. 4, No. 6, pp. 877-900.
- Kyle, A. S./Wang, F. A. (1997): Speculation Duopoly with Agreement to Disagree: Can Overconfidence Survive the Market Test?, in: *The Journal of Finance*, Vol. 52, No. 5, pp. 2073-2090.
- Long, J. B./Plosser, C. I. (1983): Real Business Cycles, in: *Journal of Political Economy*, Vol. 91, No. 1, pp. 39-69.
- Lucas, R. E. (1990): *Models of Business Cycles*, Reprint, Oxford.
- Lucas, R. E. (1994): *Studies in Business-Cycle Theory*, Eighth Printing, Cambridge.

-
- Lucas, R. E./Sargent, T. J. (1988): After Keynesian Macroeconomics, in: R. E. Lucas/T. J. Sargent (Eds.): *Rational Expectations and Econometric Practice*, Fifth Printing, Minneapolis, pp. 295-319.
- Lüdeke, D. et al. (1983): F&T Modell. Freiburger und Tübinger ökonometrisches Vierteljahresmodell, Version 81, Institut für Angewandte Wirtschaftsforschung, Tübingen.
- Maaß, H./Sell, F. L. (1998): Confident Expectations, Rational Expectations and the Optimal Conduct of Monetary Policy, in: *Economic Modelling*, Vol. 15, No. 4, pp. 519-541.
- Manove, M. (1995): *Entrepreneurs, Optimism, and the Competitive Edge*, Working Paper No. 296.95, Institut d'Anàlisi Econòmica, Universitat Autònoma de Barcelona.
- Matusaka, J. G./Sbordone, A. M. (1995): Consumer Confidence and Economic Fluctuations, in: *Economic Inquiry*, Vol. 33, No. 2, pp. 296-318.
- Mussler, W. (2001): Pessimismus im Euro-Raum verstärkt sich, in: Handelsblatt from 3/4 August 2001, No. 148, p. 7.
- Nordhaus, W. D. (1975), The Political Business Cycle, in: *The Review of Economic Studies*, Vol. 2, No. 2, pp. 169-190.
- Odean, T. (1998): Volume, Volatility, Price, and Profit When All Traders are Above Average, in: *The Journal of Finance*, Vol. 53, No. 6, pp. 1887-1934.
- Piljoo, Y. (1992): *Monetary Policy, Real Economic Activity, and New-Classical Macroeconomics*, Diss., Chicago.
- Rasmusen, E. (1998): Observed Choice and Optimism in Estimating the Effects of Government Policies, in: *Public Choice*, Vol. 97, No. 1/2, pp. 65-91.
- Ripperger, T. (1998): *Ökonomik des Vertrauens: Analyse eines Organisationsprinzips*, Tübingen.
- Ripperger, T. (1999): Die Effizienz des Vertrauensmechanismus bei der Organisation internationaler Transaktionen, in: K.-E. Schenk et al. (Eds.): *Globalisierung und Weltwirtschaft*, Tübingen, pp. 257-291.
- Samuelson, P. A. (1939): Interaction Between the Multiplier Analysis and the Principle of Acceleration, in: *Review of Economics and Statistics*, Vol. 21, No. 2, pp. 75-78.
- Schmeidler, D. (1989): Subjective Probability and Expected Utility without Additivity, in: *Econometrica*, Vol. 57, No. 3, pp. 571-587.
- Sell, F. L. (1982): *Der Konsumcharakter der Einkommensentstehung: Zur Interdependenz von Konsum- und Multiplikatortheorie*, Diss., Freiburg i. Br.

- Sell, F. L.* (1997): Political Business Cycles within a (European) Monetary Union, in: *Rivista Internazionale di Scienze Economiche e Commerciali (RISEC)*, Vol. 44, No. 1, pp. 1-22.
- Sell, F. L.* (2001): *Contagion in Financial Markets*, Cheltenham.
- Tallon, J.-M.* (2000): Pessimisme et Absence d'Échange sur les Marchés Financiers, in: *Revue d'Économie Politique*, Vol. 110, No. 2, pp. 231-241.
- Toulet, C.* (1986): Complete Ignorance and Independence Axiom: Optimism, Pessimism, Indecisiveness, in: *Mathematical Social Sciences*, Vol. 11, No. 1, pp. 33-51.
- Wakker, P.* (1990): Characterizing Optimism and Pessimism Directly through Comonotonicity, in: *Journal of Economic Theory*, Vol. 52, No. 2, pp. 453-463.
- Yamane, T.* (1976): *Statistik: Ein einführendes Lehrbuch*, Bd. 1 und 2, Frankfurt a. Main.
- Zorn, T. S./Martin, D. T.* (1986): Optimism and Pessimism in Political and Market Institutions, in: *Public Choice*, Vol. 49, No. 2, pp. 165-178.

ENDNOTES

- ⁱ For valuable comments on an earlier draft, I would like to thank Volker Hofmann, Silvio Kermer and Marcus Mitterdorf. I also appreciate Silvio Kermer's help during the simulation experiments.
- ⁱⁱ The paper of Kinsey and Collins (1990), however, aims at showing that the ICS is consistent with rational consumer behavior.
- ⁱⁱⁱ Notice that Ragnar Frisch (1933) was most likely the first economist interested in the business cycle who strictly differentiated between "impulse and propagation".
- ^{iv} Yet, Garrison (1991, p. 98) finds "more differences than similarities" between the real business cycles theory (RBCT) and Wicksell's contribution, as the interest rate is important for his theory, but not for RBCT.
- ^v Yet, the correlation between optimism (pessimism) and overconfidence, is far from being clear: One may argue that it is not the optimists who misjudge the capabilities of their adversaries, but rather the pessimists. Optimists are not automatically "overconfident about the precision of their knowledge" (Odean 1998, p. 1888). On the contrary, it may be that they transfer a job/task to other agents because they expect *them* to do a great job. They can be optimistic about the outcome, no matter if they themselves or others will be the acting persons. It is definitely not an attitude of optimists to "overestimate the degree to which they were instrumental in bringing it (the positive result, the author) about" (*ibid.*, p. 1893).
- ^{vi} Lucas himself has introduced this criterion as significant for any serious attempt to explain the business cycle (*ibid.*, 1994, p. 225).
- ^{vii} This equation almost seems to fulfil what Lucas finds to be a main qualitative feature of business cycles: "technically, movements about trend in gross national product in any country can well be described by a stochastically disturbed difference equation of very low order" (*ibid.*, 1994, p. 217).
- ^{viii} If anybody would seriously doubt the affirmation that "surprises" always have a positive connotation, he should take a look at a desert menu in a French restaurant.
- ^{ix} In truth, there are two more alternatives (v) $y_t^{(1-P)} < y_t < y_t^e$ and (vi) $y_t^P > y_t > y_t^e$ which, however, are irrelevant for our purpose.
- ^x Notwithstanding the existing methodological critique against Bayesian concepts of decision making (Toulet 1986, Schmeidler 1989), this approach seems to fit best the problem of learning given "prior" subjective probabilities. This view is implicitly backed by Lucas and Sargent (1988, p. 315): "Bayesian learning is vacuous until one ... imputes a prior distribution to agents".
- ^{xi} See for a procedure in the same vein Demougin (1999, p. 305).
- ^{xii} See Yamane (1976, p. 547).