

Hannsgen, Greg

Working Paper

Gibson's paradox, monetary policy, and the emergence of cycles

Working Paper, No. 410

Provided in Cooperation with:

Levy Economics Institute of Bard College

Suggested Citation: Hannsgen, Greg (2004) : Gibson's paradox, monetary policy, and the emergence of cycles, Working Paper, No. 410, Levy Economics Institute of Bard College, Annandale-on-Hudson, NY

This Version is available at:

<https://hdl.handle.net/10419/31582>

Standard-Nutzungsbedingungen:

Die Dokumente auf EconStor dürfen zu eigenen wissenschaftlichen Zwecken und zum Privatgebrauch gespeichert und kopiert werden.

Sie dürfen die Dokumente nicht für öffentliche oder kommerzielle Zwecke vervielfältigen, öffentlich ausstellen, öffentlich zugänglich machen, vertreiben oder anderweitig nutzen.

Sofern die Verfasser die Dokumente unter Open-Content-Lizenzen (insbesondere CC-Lizenzen) zur Verfügung gestellt haben sollten, gelten abweichend von diesen Nutzungsbedingungen die in der dort genannten Lizenz gewährten Nutzungsrechte.

Terms of use:

Documents in EconStor may be saved and copied for your personal and scholarly purposes.

You are not to copy documents for public or commercial purposes, to exhibit the documents publicly, to make them publicly available on the internet, or to distribute or otherwise use the documents in public.

If the documents have been made available under an Open Content Licence (especially Creative Commons Licences), you may exercise further usage rights as specified in the indicated licence.



Working Paper No. 410

**Gibson's Paradox, Monetary Policy,
and the Emergence of Cycles**

by

Greg Hannsgen
The Levy Economics Institute
hannsgen@levy.org

July 2004

* The author wishes to thank Philip Arestis
for helpful comments on a previous draft.

The Levy Economics Institute Working Paper Collection presents research in progress by Levy Institute scholars and conference participants. The purpose of the series is to disseminate ideas to and elicit comments from academics and professionals.

The Levy Economics Institute of Bard College, founded in 1986, is a nonprofit, nonpartisan, independently funded research organization devoted to public service. Through scholarship and economic research it generates viable, effective public policy responses to important economic problems that profoundly affect the quality of life in the United States and abroad.

The Levy Economics Institute
P.O. Box 5000
Annandale-on-Hudson, NY 12504-5000
<http://www.levy.org>

Copyright © The Levy Economics Institute 2004 All rights reserved.

ABSTRACT

Many empirical studies have found that interest rate increases have a positive effect on the price level. This paper pursues an obvious, but neglected explanation: interest payments are a cost of production that is at least in part passed on to customers. A model shows that the cost-push effect of inflation, long known as Gibson's paradox, intensifies destabilizing forces and can be involved in the generation of cycles. An empirical investigation finds that the positive association of interest rates with inflation or the log of the price level is present in data from the 1950s to present.

JEL Classifications: C22, E11, E12, E32, E52

Keywords: Gibson's Paradox, Inflation, Monetary Policy Rules, Nonlinear Dynamics

1. INTRODUCTION

A question that has vexed researchers for over 150 years arises in connection with the empirical observation known as Gibson's paradox. The apparent paradox is that interest rates and the price level are positively correlated. In a conventional Keynesian model, a decrease in interest rates reduces the rate of economic activity and would presumably therefore put downward pressure on inflation rates. Yet a positive correlation between interest rates and prices has been found by researchers going back to some of the earliest studies of price data (Tooke 1838).

A natural explanation for the paradox suggests itself. If interest rates are a cost of production and prices are based on costs, then interest rate rises would be passed along to consumers in the form of higher prices (Pivetti 2001). In much modern thought, this explanation is tied to the notion that interest rates are determined by central bank policy, rather than by liquidity preference or equilibrium in the loanable funds market.

As Taylor (2004) points out, this notion, "that the price level (and, by extension, the inflation rate) depends positively on the interest rate [,] has a checkered history." Thomas Tooke of the 19th century Banking School was perhaps the first to suggest the idea. His point in using the concept was to debunk the theories of the Currency School economists, who argued that increases in the money supply would cause inflation. A member of the Currency School, like a modern monetarist, might expect an increase in the money supply to reduce interest rates, stoking economic activity, which would then lead to inflation. Tooke's finding that price levels were not inversely associated with interest rates casts doubt on this theory.

As most advocates of the theory of interest rate cost-push inflation have recognized, this view has some important potential policy implications. First, high interest rates would be exactly the wrong medicine for inflation. It may be that countercyclical interest rate policy does affect inflation in the expected direction, by regulating the level of economic activity. But this effect would be blunted by a cost-push factor working in the opposite direction. As a result, a much steeper recession would be needed to damp inflation than in the absence of the cost-push effect.

If the cost-push channel of monetary transmission is operative, one might imagine that counterinflationary monetary policy would generate instability: a higher inflation level leads the authorities to increase interest rates. This has the effect of increasing inflation rather than containing it, forcing the authorities to again raise interest rates. If the dynamics of output are

linked with those of inflation, then output could be destabilized as well by the use of counterinflationary policy. This is a cautionary tale at a time when the Federal Reserve is once again considering raising interest rates.

This paper theoretically examines this possibility. In the following sections, a model is developed along the lines suggested by many Keynesian, Sraffian, and Kaleckian scholars. First, prices are determined by costs, plus a markup determined by monetary policy. When prices rise above cost plus the markup, they tend to be driven down by competition. Interest rates are determined by the central bank. In this case, the central bank is assumed to target inflation. Turning to the dynamics of output, a Minskyan effect of interest rates on output is posited (Minsky 1986, esp. Ch. 9; Hannsgen, forthcoming). Firms and individuals tend to “lend long and borrow short.” That is, they finance their activities with short-term loans obtained at an interest rate determined by the central bank. Much of their funds are tied up in long-term, fixed-interest rate government bonds, however. When the cost of short-term funds rises, the gap between the earnings of banks and their interest payments shrinks, causing a worsening of banks’ financial condition and weakening the incentive to invest. Similarly, the existing level of output has an effect on the incentive to invest.

The results confirm the suggestion above that in this scenario, aggressive monetary policy can have a destabilizing effect. When the sensitivity of policy to inflation is high, the equilibrium point becomes unstable. In any event a limit cycle can exist: in inflation-output space there is a closed cyclical path outside of the equilibrium point. The economy is attracted to that cycle from anywhere else except the equilibrium point. A number of factors lead to this form of instability, among them the Gibson effect. So, the Gibson paradox can cause an economy that would otherwise tend to gravitate toward equilibrium to move into a cyclical path. Alternatively, a “corridor of stability” exists, within which the economy tends to move toward the center. This zone of stability shrinks as the flexibility of prices changes, increasing the difficulty of the task of keeping the economy within limits.

An empirical investigation follows the model. The empirical section finds that interest rates and inflation or the price level are positively associated according to various measures. The existence and strength of the relationship depend upon the means used to deal with the trends in both variables. In addition to the problem of trends in the data, one encounters problems with alternative explanations of the posited relationship: interest rate increases may appear to “cause”

inflation when they are in fact a reaction to it. These problems call for further study using more sophisticated multivariable techniques.

2. THE MODEL

We begin by positing a cost-driven price determination mechanism. It is assumed that there are two factors of production: labor and bank loans. The production technology dictates that firms must hire “a” units of labor for each unit of output they want to produce. Moreover, output takes one period, so that entrepreneurs must pay one period’s interest on their labor costs.

Alternatively, firms are run by rentiers who earn a rate of profit equal to the interest rate. In this case, the profit rate is determined by monetary policy (Sraffa 1960; Pivetti 2001). Capitalists will not produce if they can earn a better return on the bond market. Mathematically, these assumptions mean that costs are

$$C=(1+R).a.W$$

Here and in subsequent equations, capital letters indicate variable names. Small letters are positive parameters or function names. Periods indicate multiplication. W is the hourly wage, a is the (fixed) labor/output ratio, R is the interest rate, and C is the cost of production of one unit of output. Note that the term cost is used here in a broad sense to include a normal rate of profit.

Using the approximation that the logarithm of (1+R) is roughly R for small R, the equation for the logarithm C is

$$\ln(C) \approx R + \ln(a) + \ln(W) \quad (1)$$

where the function ln indicates the natural logarithm. The entry and exit of entrepreneurs forces the retail price to adjust toward costs (including the income of rentiers).

$$\Pi = b.(\ln(C) - \ln(P)) \quad (2)$$

where Π is inflation ($(dP/dt)/P$) and P is the price level. Substituting (1) into (2) and differentiating by time, one gets

$$d\Pi/dt = b((dR/dt) + (dW/dt)/W - \Pi) \quad (3)$$

where the approximation is replaced by an equals sign for convenience. To flesh out the details of this equation, one assumes the following. Interest rates are adjusted by the central bank according to its preferences regarding inflation and output levels.

$$dR/dt = c(\Pi - \Pi^*, Y) \quad (4)$$

where Y equals output and $c_{\Pi}, c_Y > 0$, using subscripts to indicate partial derivatives. The central bank raises interest rates when output and inflation are high, and lowers rates in the opposite case. This equation is a very general form of a Taylor rule. It is consistent with the assumption of an endogenous money supply and an exogenous interest rate (Moore 1988).

The wage growth equation is

$$(dW/dt)/W = d(\Pi, Y) \quad (5)$$

$d_{\Pi} > 0, d_Y > 0$. Wages are driven by the power of labor, which is positively affected by a vigorous economy (high Y). (Labor becomes more aggressive in its wage demands when it is easier to find a job. A tight labor market is associated with a high Y because of the fixed technical coefficients assumption.) Also, labor manages to recover some of what is lost to inflation, as indicated by the first argument of the function d . This term can be taken to reflect some form of wage indexation. Note that we do not explicitly model price expectations and assume a direct reaction to actual inflation. Thus, employers do not pay lower wages when workers are “fooled” by higher than expected price increases.

Plugging (4) and (5) into (3),

$$d\Pi/dt = b(c(\Pi - \Pi^*, Y) + d(\Pi, Y) - \Pi) \quad (6)$$

Turning to the real side of the model, growth is negatively affected by the rate of change of the interest rate and positively affected by the existing level of output. (Note the contrast with standard theories that relate output to the *level* of the interest rate.) The former effect has been justified above by the fact that entrepreneurs or banks have “short positions,” following Minsky (1986) and Hannsgen (forthcoming). (Entrepreneurs or banks borrow in short-term markets, such as the commercial paper market, and invest in longer-term projects.)

History offers quite a few examples of this phenomenon. Perhaps one of the most extreme cases is the savings-and-loan crisis of the late 1970s and early 1980s. As Federal Reserve Board Chairman Paul Volcker raised interest rates, savings and loans found themselves losing deposits to instruments with a greater return than deposits. Eventually, savings and loan institutions were able to raise their deposit rates in an effort to retain funds. But, the assets of savings and loan associations were mainly fixed-rate, long-term mortgages. Thus, even as savings and loans paid more for deposits, their income remained largely unchanged. The resulting squeeze was one factor that ultimately led to the loss of all positive net worth of the industry.

The second term in the output equation, the relationship between output and its own derivative, is based upon the idea that the optimism or “animal spirits” of capitalists is favorably affected by high sales. The notion that capacity utilization affects investment can be traced to Steindl (1976) and the importance of cash flow to investment finds supporters among new Keynesians who emphasize capital market imperfections. Putting these ideas together, one gets

$$dY/dt = e(dR/dt, Y) = e(c(\Pi - \Pi^*, Y), Y) \quad (7)$$

In accordance with the argument of the previous paragraphs, $e_{dR/dt} < 0$; $e_Y > 0$

The Jacobian (partial derivative) matrix of the system made up of eqs. 6 and 7 is

$$J = \begin{bmatrix} \alpha & \beta \\ \chi & \delta \end{bmatrix} = \begin{bmatrix} b(c_{\Pi} + d_{\Pi} - 1) & b(c_Y + d_Y) \\ e_{dR/dt} \cdot c_{\Pi} & e_{dR/dt} \cdot c_Y + e_Y \end{bmatrix} \quad (8)$$

This matrix is evaluated at the equilibrium values of the variables, which are assumed to be positive. Based on the assumptions above about the signs of various partial derivatives, the sign pattern of J is

$$\begin{bmatrix} + / - & + \\ - & + / - \end{bmatrix}$$

First, a very general description of the dynamic analysis is in order. For the moment, let us assume that δ is positive, while α is negative. Also, assume that the χ and β are large in absolute value. Under these assumptions, the model fits into a well-known “genus” of cycles, which has recently been explored by Taylor (2004). The product of the roots is equal to the determinant, which is positive under the assumptions. The sum of the roots is equal to the trace of the matrix (the sum of the terms on the principal diagonal), which will depend on the relative strengths of α and δ . If the positive δ is smaller than the negative α in absolute value, the trace is negative and the sum of the roots is negative, indicating two roots with negative real part. The system is then either a stable focus or a stable node, depending upon whether the roots are complex or real. If the trace is positive on the other hand, the two roots have positive real part, and the system is unstable.

As one would expect from this discussion, the proof of the system’s dynamics depends on the trace and determinant of J. The gist of the proposition beginning in the next paragraph is that the system displays local stability for certain values of b . However, there is some critical value of b , the parameter of the price adjustment parameter, designated b^* , such that the system loses local stability when $b > b^*$, or $b < b^*$.

In addition, one of two types of cycles is involved. The first type is a stable limit cycle, depicted in figure 1. (Figures 1–6 are at the back.) This cycle is approached from inside by outward spirals and from outside by inward spirals. The cycle emerges, if at all, for only $b < b^*$ or only $b > b^*$. The figures show the case where instability arises for $b > b^*$. For $b < b^*$, paths around the equilibrium spiral toward the center, as seen in figure 2.

The second type of possible cycle is an unstable one and is shown in figure 3. Paths beginning inside the cycle spiral inward toward the fixed point, rather than outward. Paths beginning outside the cycle move ever outward, instead of approaching the cycle. This sort of cycle exists, either when $b > b^*$ or when $b < b^*$; in the diagram, the latter is assumed. When this

form of unstable cycle exists, the case $b > b^*$ is an unstable focus, from which all paths spiral outward. See figure 4. Unfortunately, there is no way of determining which sort of cycle exists in the model described here. (It depends upon the second and third derivatives of the system, which mostly have no economic interpretation.)

The formalities are as follows and can be skipped:

Proposition: Let $b^ = b_1/b_2 = (-e_{dR/dt} \cdot c_Y - e_Y)/(c_\Pi + d_\Pi - 1)$, where all derivatives are evaluated at the point (Π^e, Y^e) , the fixed point of the system. Suppose $b^* > 0$. Also, suppose $(d_\Pi - 1) \cdot (c_Y + e_Y/e_{dR/dt}) < c_\Pi \cdot (d_Y - e_Y/e_{dR/dt})$ at (Π^e, Y^e) . Then, the system is asymptotically locally stable for $b < b^*$ if $b_1 > 0$ and for $b > b^*$ if $b_1 < 0$. As b reaches the value b^* from below ($b_1 > 0$) or above ($b_1 < 0$), it loses its stability, either through the birth of a stable limit cycle or the death of an unstable limit cycle. (This is known as a Hopf bifurcation; see Gandolfo 1997, p. 475–80.)*

Proof: .

$$\det(J) = b \cdot \det \begin{bmatrix} c_\Pi + d_\Pi - 1 & c_Y + d_Y \\ e_{dR/dt} \cdot c_\Pi & e_{dR/dt} \cdot c_Y + e_Y \end{bmatrix}$$

$$= b \cdot \det \begin{bmatrix} d_\Pi - 1 & d_Y - (e_Y / e_{dR/dt}) \\ e_{dR/dt} \cdot c_\Pi & e_{dR/dt} \cdot c_Y + e_Y \end{bmatrix}$$

through an elementary row operation.

$$= e_{dR/dt} \cdot b \cdot \det \begin{bmatrix} d_\Pi - 1 & d_Y - (e_Y / e_{dR/dt}) \\ c_\Pi & c_Y + (e_Y / e_{dR/dt}) \end{bmatrix}$$

Keeping in mind that the initial derivative in the last equality is negative, the second assumption clearly guarantees that the determinant is positive at the relevant point. The first condition requires that there exists a value of the parameter b , designated b^ , with $b^* > 0$, such that the trace switches from negative to positive as b passes through b^* . The sum of the roots therefore also switches from negative to positive. Therefore stability is lost or gained at that point. It is*

also a well-known exercise to prove the existence of a limit cycle when the trace and determinant are configured as they are here (since the roots are purely imaginary at b^).*

What is the economic meaning of the dynamics? The stability of the system depends upon the flexibility of inflation, given by the parameter b . Depending upon the values of various derivatives at the equilibrium of the system, there may be a value of b above which or below which the system loses or gains stability; if that is the case, some form of cycle may exist. The existence and amplitude of this cycle will depend either positively or negatively upon the flexibility of inflation, given by b . In some cases, flexible adjustment of inflation to cost changes reduces the stability of the system, while rapid adjustment can in other circumstances be associated with instability.

Another implication can be seen from the trace of the matrix in equation 6. The system loses stability when the trace becomes positive. The derivative of the policy function with respect to inflation, c_{π} , is one of the terms in the trace and so contributes to the possible generation of instability. This term represents the sensitivity of the central bank's reaction to deviations of inflation from its target. So, highly responsive policy has a destabilizing effect for some values of the parameters of the system.

The relationship of dynamics of the system to the parameter b are shown in figure 5. Along one axis is b , the parameter of interest. As one moves along that axis, price flexibility changes. The two state variables of the system (Y and Π) are on the other two axes. A horizontal "slice" of figure 3 at a particular value of b (such as figures 1 and 2) shows the dynamics for a particular degree of flexibility. At low values of b , paths are shown spiraling inward toward a central equilibrium on the dashed vertical line. If $b > b^*$, the slice contains a cross section of the "bowl" that broadens as b increases. The outer border of the cross-section is similar in shape to an ellipse. This is the path that the economy will approach from anywhere else in the cross-section.

As stated earlier, the existence of this particular set of dynamics depends upon certain technical conditions, one of which (the transversality condition) is always satisfied. The second condition involves the third-order derivatives of the system and does not have any economic meaning. But there is only one other possible set of dynamic paths that is possible if the second technical condition is not met. This alternative also involves a limit cycle, but in this case the limit cycle is unstable and the equilibrium point at the center is stable. So, any path inside the

limit cycle will lead inward to the central equilibrium. Any point outside the limit cycle will move continually outward. So there is a “corridor of stability.” The corridor is larger for small values of b . So, if b is large, the economy is less able to regain its equilibrium after a shock than if b is small.

This is shown in figure 6. Suppose the economy is originally at the equilibrium point C at the center of the figure. Then the economy receives some sort of shock that pushes it out to D. As figure shows, the economy eventually moves back to the equilibrium point, as shown. But when b is larger, as seen in figure 6, the corridor of stability is smaller or even dimensionless. If the economy starts at A and is then shocked to point B, it does not readjust back to equilibrium, instead spiraling endlessly outward. Notice that this is for a shock equal in size to the one considered earlier. Hence, large b makes it difficult for the economy to recover from large shocks.

Thus, we have two cases. In each case, high (or low) values of b lead to a greater degree of instability. In the first case, shown in figures 1 and 2, high (or low) values of b turn a stable point into a stable cycle. In the second case, shown in figures 3 and 4, the stable basin shrinks as b rises (falls). It is partly because of the “cost-push” effect of interest rates that one comes to this policy conclusion, though other terms are clearly involved in the stability condition. The cost-push phenomenon also lies behind the paradoxical conclusion that aggressive monetary policy can destabilize output and inflation.

3. EMPIRICS OF GIBSON’S PARADOX

Because Gibson’s paradox has been observed over such a long period, it has found its way into a number of strands of empirical literature. In this section, the author looks at the issue using some rather crude techniques. A future paper will investigate the problem using multivariable methods.

The data used are for the federal funds rate and the consumer price index (CPI) for all urban consumers. Because the effects involved are presumed to operate over a fairly long term, the monthly data were averaged over three months to create quarterly data. The federal funds rate is perhaps the most logical rate to use, since it is the most directly controlled by policymakers. All available data (1954–2004) were used.

One problem with this exercise is that the data contain trends. Indeed, both the log of the CPI and the federal funds rate contain unit roots, according to standard Dickey-Fuller (DF) and Phillips-Perron tests.¹ This observation suggests the idea of differencing the data. On differencing the log CPI data, one gets a measure of inflation. The following scatter plot and regression therefore feature inflation and the level of the interest rate.

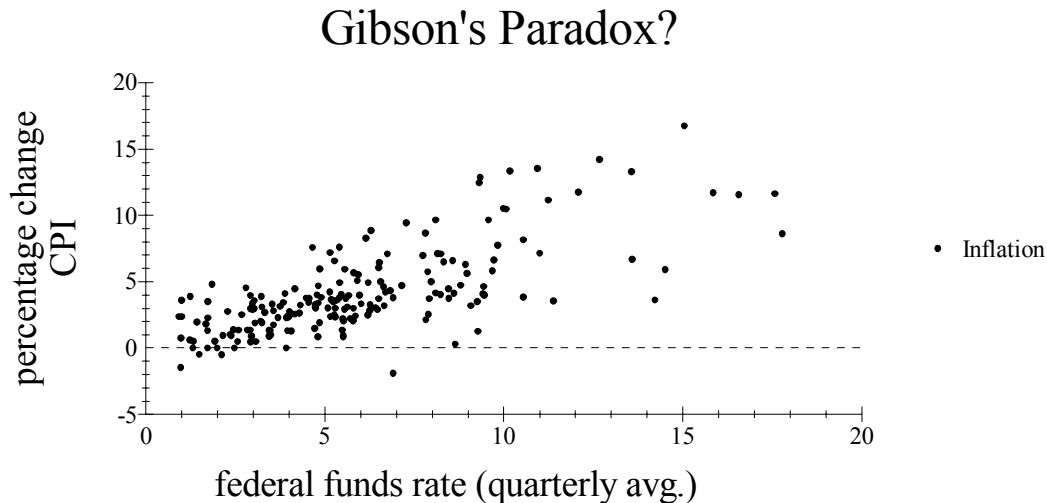

Dependent Variable: Percentage change CPI-au, S.A. (quarterly average)

R-squared: .523

F-stat: 214.79 (.000)

| | <i>Coefficient</i> | <i>T-ratio</i> |
|--------------------------------|--------------------|----------------|
| <i>Regressor: Intercept</i> | -.017 | -.053 |
| <i>FFR (quarterly average)</i> | .693 | 14.656 |

The relationship works in the expected direction, but less than seven-tenths of each percentage point increase in interest rates cost are passed on as inflation. Note that, even with only one explanatory variable, the R-squared exceeds one-half. The Durbin-Watson statistic in this and

¹ For the log of the CPI, the AIC, SBC, and HQC specification tests suggested a DF test augmented with four lags of the differenced variable. The DF test statistic for this specification was approximately -2.23 , well short of the cutoff of -2.88 , preventing the rejection of the null of no unit root. This finding was robust to the inclusion of time trend. The Phillips-Perron test, based on a window of 4 lags, yielded a test statistic of 1.25 , which also fell short of the level needed to reject a unit root in log CPI. For the federal funds rate, no order of ADF test up to 12 rejected the unit root null. For example, a four-lag ADF had a test statistic of -2.09 , as compared with the 2.88 critical value. The Phillips-Perron statistic, which had the same critical value, was -4.8611 .

the other traditional regressions reported here suggests a high degree of autocorrelation, so hypothesis tests should be interpreted with caution.

Alternatively, one can assume a deterministic trend. In the next equation, the log CPI variable was regressed against a constant and a deterministic trend. Then, the residuals (detrended prices) were regressed against the federal funds rate.

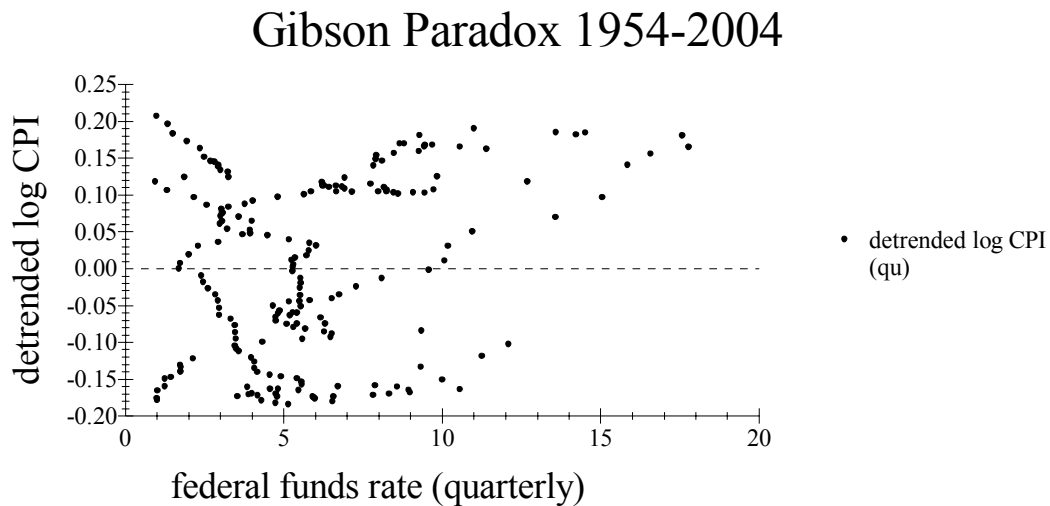

Dependent Variable: Detrended Log CPI-au-S.A. (quarterly average)

R-squared: .079

F-stat: 16.72 (.000)

| | <i>Coefficient</i> | <i>T-ratio</i> |
|--------------------------------|--------------------|----------------|
| <i>Regressor: Intercept</i> | -.058 | -3.552 |
| <i>FFR (quarterly average)</i> | .010 | 4.089 |

In this case, a one-percentage-point increase in the federal funds rate leads to almost exactly a one-percentage point increase in the price index. On the other hand, the R-squared is very low, represented in the scatter plot by the wide spread of the observed values for a given level of the independent variable. This broad range of the data is expected, given that interest rates are only one component of firms' costs.

An effort was made to regress the detrended price data on the differenced federal funds rate series. The resulting coefficient was positive and highly significant, but the R-squared was minute. Although the interest rate data are integrated according to standard tests, they do not exactly fit the description of a nonstationary variable, as they cannot in principle wander without bound. Therefore, a regression involving differenced variables may not be the right approach, anyway. In a yet another regression, following the approach of Kydland and Prescott (1990), both the interest rate and price series were detrended using the Hodrick-Prescott filter. The correlation between the variables, detrended in this way, was .66.

There are two reasons why it might be preferable to use a bivariate autoregression to analyze these results. First, it is clear that lagged values of the variables may be important in this relationship. Second, there is an identification problem: interest rate hikes may be passed along as price increases, and the Fed may respond to price increases (actual or prospective) by increasing the federal funds rate.

In the literature on this issue, which is immense, neoclassical economists have arrived at the solution of using a vector autoregression that includes a commodity price index. The idea is that the central bank raises interest rates when it expects inflation, creating a spurious impression that interest rates drive price increases. The index involved essentially controls for Federal Reserve inflation expectations and averts the result that interest rate shocks have a positive effect on the CPI (Sims 1992). A recent paper has called this interpretation into question by showing that the indices in question are not particularly good predictors of inflation, and that other, more accurate, predictors of inflation do not “correct” the apparently anomalous finding (Hanson forthcoming). Putting to one side issues connected with multivariable techniques, this paper next investigates the bivariate relationships involved.

The Akaike and Schwarz-Bayesian specification criteria both selected a 4-lag specification for the bivariate autoregression. The following were the results.

Vector autoregression. Variables: Federal funds rate, quarterly average; detrended log CPI-au-S.A., quarterly average; constant term. 1955–2004. Four lags of each variable included.

R-squared: .999

F-stat: 27400 (.000)

Null:

F-statistic

Prob.

| | | |
|---------------------------------------|----------------|------|
| <i>FFR does not Granger-cause CPI</i> | (4, 185) 9.562 | .000 |
| <i>CPI does not Granger-cause FFR</i> | (4, 185) 2.868 | .025 |

The meaning of Granger causality tests has been questioned by many econometricians. Some argue that the tests merely determine whether one variable “precedes,” rather than causes another and suffer from a post-hoc-ergo-propter-hoc fallacy (Leamer 1985). Bearing these critiques in mind, one can draw the conclusion that if precedence implies causation, the evidence more strongly supports the notion that the interest rate causes the price level than vice-versa. On the other hand, lagged values of *both* variables are important in this system.

A more direct way of measuring the potential inflationary effect of interest rate increases is to find the ratio of business’s interest costs to the value of their final sales. A conservative way of measuring interest costs is to add up the total value of outstanding business loans, commercial paper, and “other loans and advances.” This sum excludes mortgages, consumer loans, and longer-term debt, such as corporate bonds. The total in question is approximately \$2.1 trillion (Federal Reserve Board 2004). A one-percentage-point rise in interest rates (ignoring compounding) would then impose a cost on businesses of \$20 billion, or .27 percent of the value of private-sector output. A more comprehensive measure of business debt, which includes both long- and short-term borrowing, is the total nonfinancial business credit market debt, which is approximately \$7.4 trillion. A one-percentage-point rise in interest costs would then amount to a “tax” on business of \$74 billion, or approximately one percent of private-sector output. Of course this number is an upper bound, because Federal Reserve policy has little immediate effect on the debt service costs associated with long-term debt.

The empirical exercises of this section show that there are many reasons to believe that the Gibson effect is operative. Because of the difficult issues associated with detrending, it is difficult to measure this effect or find a single conclusive test of its existence.

The implications of the empirical findings are that one must be aware of possible perverse effects in implementing monetary policy. Significantly, in the presence of the Gibson effect, one model shows that cycles develop, and that these cycles become more severe as price flexibility changes. A complicated set of effects is involved, but the key causal chain is that an increase in inflation increases the central bank’s tendency to raise rates, which only exacerbates the original inflationary problem. This latter chain of events can clearly generate instability, whether or not cycles are involved. Other factors leading to cyclical behavior are the dynamics

of wage formation and positive feedback between output and its rate of increase. It is clear that Gibson's paradox, along with Minskyan ideas about the real effects of monetary policy and Sraffian theories about distribution, can be part of an explanation of cycles in modern economies.

REFERENCES

- Dutt, Amitava K. 1990. *Growth, Distribution, and Uneven Development*. Cambridge: Cambridge University Press.
- Federal Reserve Board. 2004. Flow of Funds accounts, Z-1 release, March 4, table L2.
- Flaschel, Peter, Reiner Franke, and Willi Semmler. 1997. *Dynamic Macroeconomics: Instability, Fluctuations and Growth in Monetary Economics*. Cambridge: MIT Press.
- Gandolfo, Giancarlo. 1997. *Economic Dynamics*. Study edition. New York: Springer-Verlag.
- Hannsgen, Greg. Forthcoming. "Minsky's Acceleration Channel and the Role of Money." *Journal of Post Keynesian Economics*.
- Hanson, Michael. Forthcoming. "The 'Price Puzzle' Reconsidered." *Journal of Monetary Economics*.
- Kydland, Finn E. and Edward C. Prescott. 1990. "Business Cycles: Real Facts and a Monetary Myth." *Federal Reserve Bank of Minneapolis Quarterly Review* 14:2: 3–18.
- Leamer, Edward. 1985. "Vector Autoregressions for Causal Inference." *Carnegie-Rochester Conference Series on Public Policy* 22: 255–303.
- Medio, Alfredo and Marji Lines. 2001. *Nonlinear Dynamics: A Primer*. Cambridge: Cambridge University Press.
- Minsky, Hyman P. 1986. *Stabilizing an Unstable Economy*. New Haven, Connecticut: Yale University Press.
- Moore, Basil. 1988. *Horizontalists and Verticalists*. Cambridge: Cambridge University Press.
- Pivetti, Massimo. 2001. "Money Endogeneity and Monetary Non-Neutrality: A Sraffian Perspective." In *Credit, Interest Rates, and the Open Economy*, Louis-Philippe Rochon and Matias Vernengo, eds. Northampton, Mass.: Edward Elgar.
- Sims, Christopher. 1992. "Interpreting the Macroeconomic Time Series Facts: The Effects of Monetary Policy." *European Economic Review* 36:5: 975–1000.
- Sraffa, Piero. 1975 [1960]. *Production of Commodities by Means of Commodities: Prelude to a Critique of Economic Theory*. New York: Cambridge University Press.
- Steindl, Josef. 1976. *Maturity and Stagnation in American Capitalism*. New York: Monthly Review Press.
- Taylor, Lance. 2004. *Reconstructing Macroeconomics*. Cambridge: Harvard University Press.

Tooke, Thomas. 1838. *A History of Prices, and the State of the Circulation, from 1793 to 1837*.
London: Printed for Longman, Orme, Brown, Green, and Longman's.

fig 1

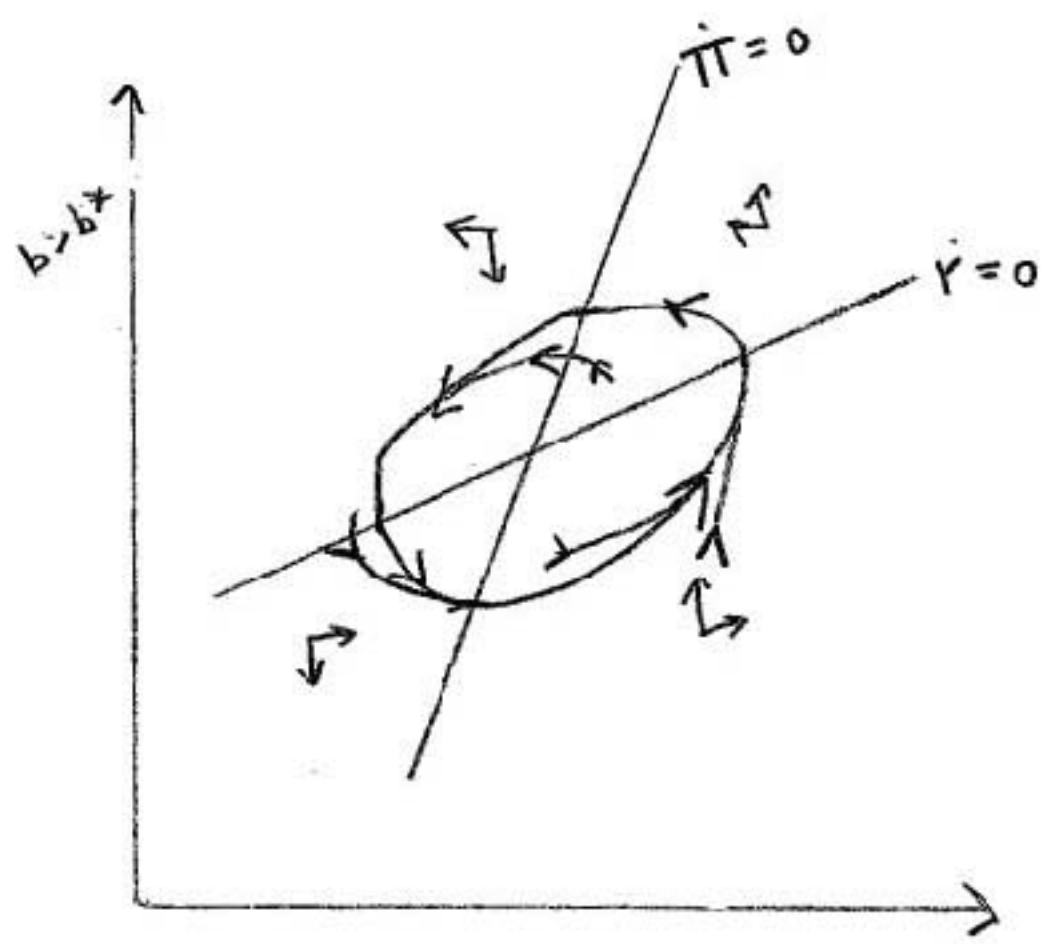

fig 2

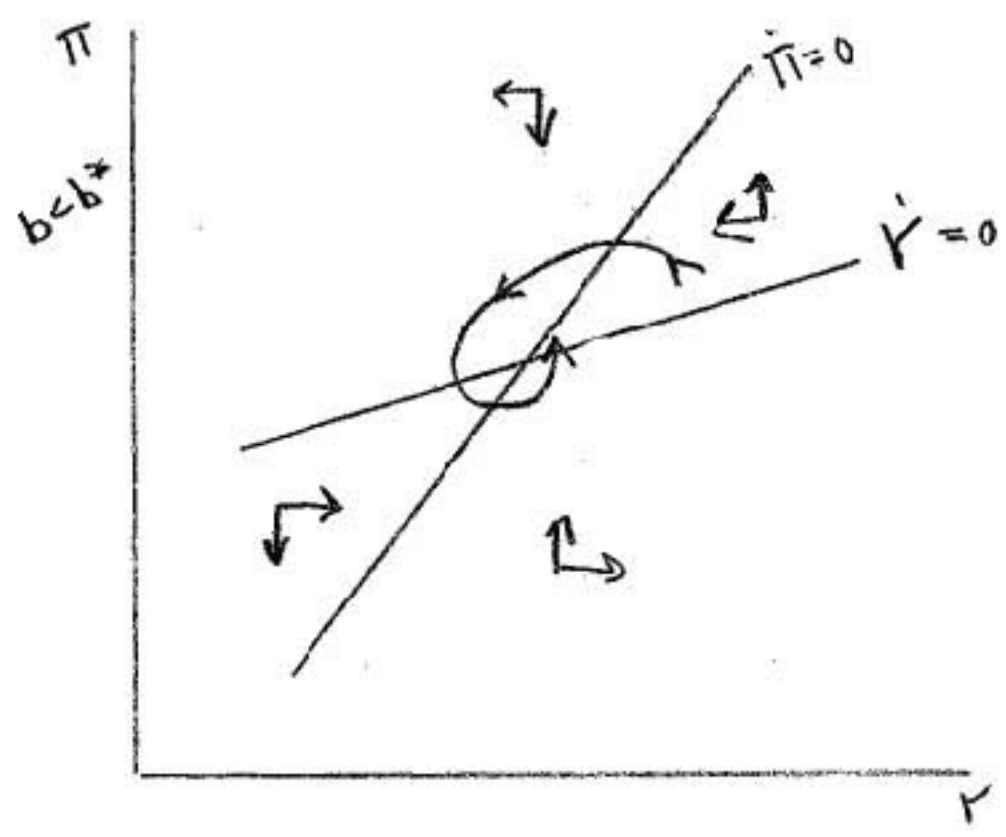

fig. 3

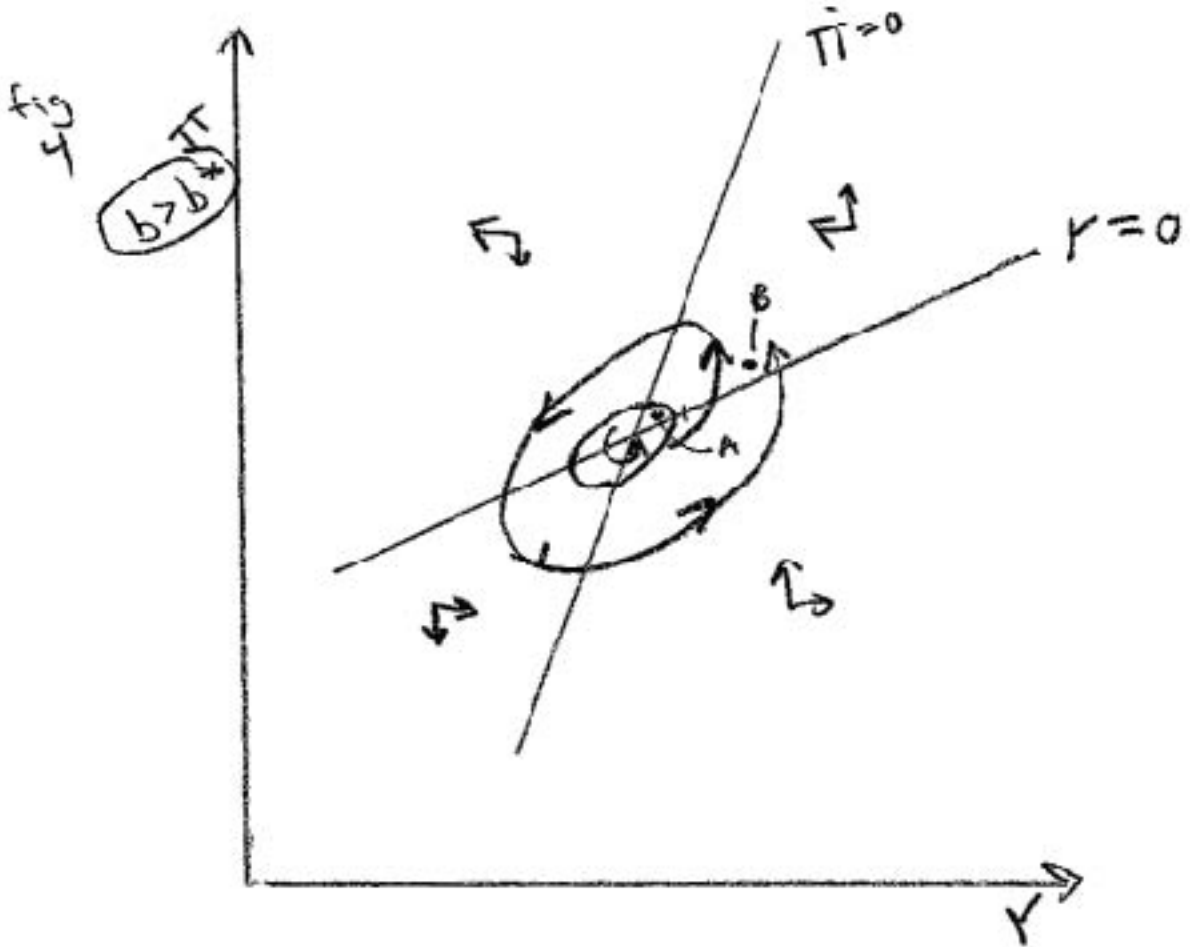
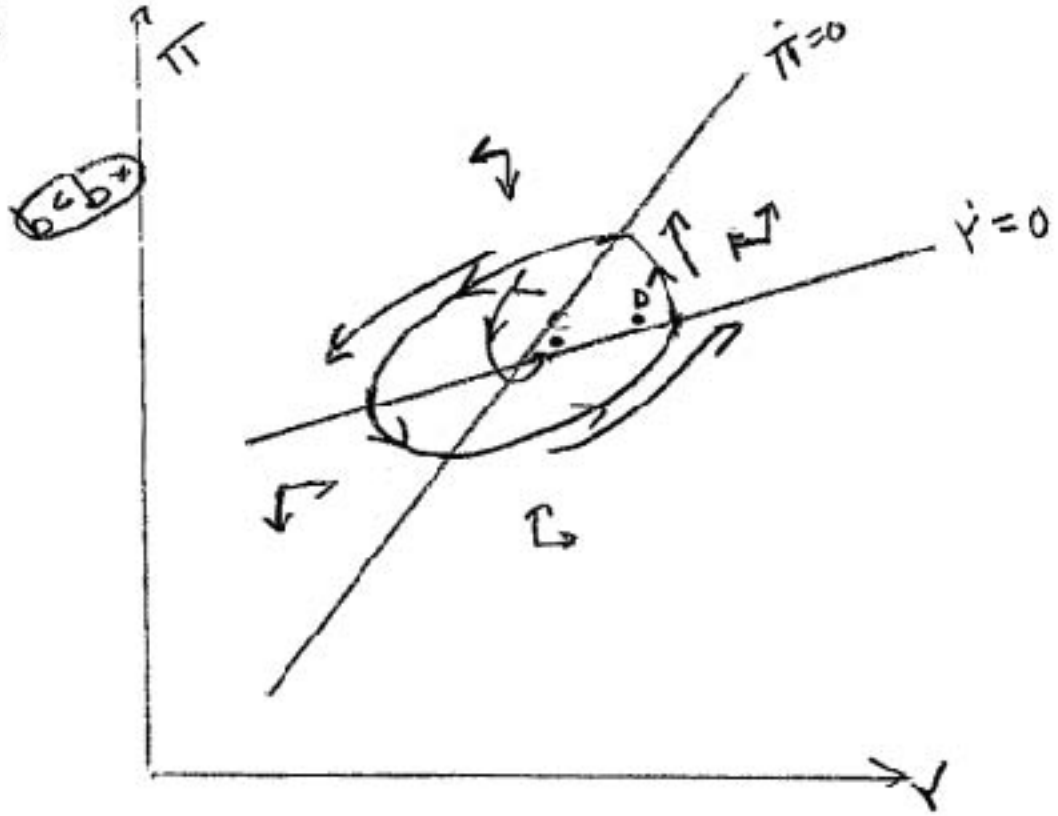

FIG. 5.

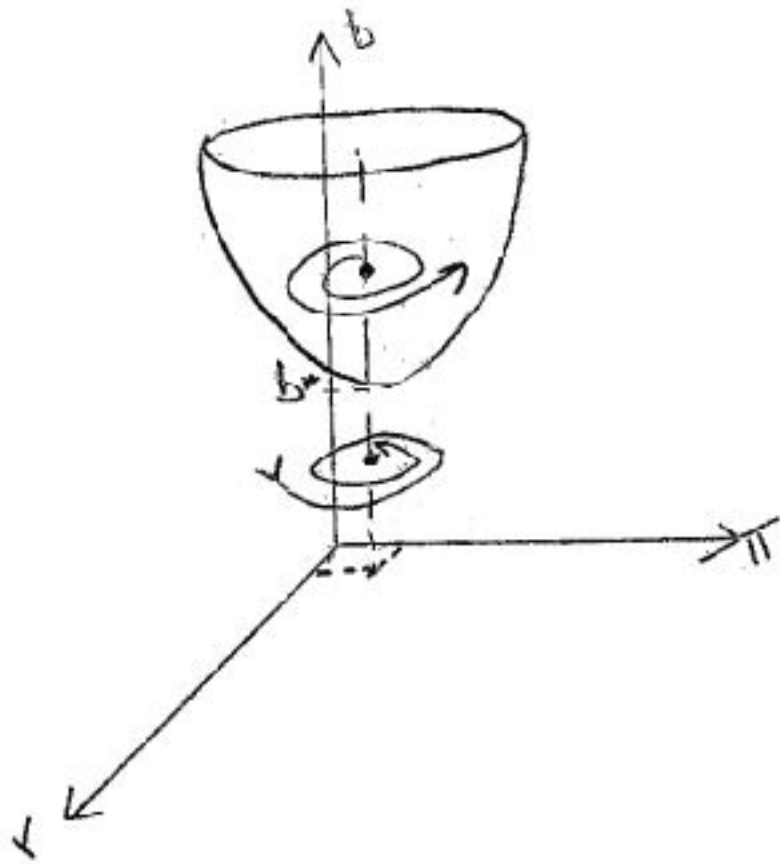

FIG. 6.

