

Friedman, Eric J.; Johnson, Simon; Landsberg, A. S.

Working Paper

The emergence of correlations in studies of global economic inter-dependence and contagion

Claremont Colleges Working Papers, No. 2002-35

Provided in Cooperation with:

Department of Economics, Claremont McKenna College

Suggested Citation: Friedman, Eric J.; Johnson, Simon; Landsberg, A. S. (2003) : The emergence of correlations in studies of global economic inter-dependence and contagion, Claremont Colleges Working Papers, No. 2002-35, Claremont McKenna College, Department of Economics, Claremont, CA

This Version is available at:

<https://hdl.handle.net/10419/31433>

Standard-Nutzungsbedingungen:

Die Dokumente auf EconStor dürfen zu eigenen wissenschaftlichen Zwecken und zum Privatgebrauch gespeichert und kopiert werden.

Sie dürfen die Dokumente nicht für öffentliche oder kommerzielle Zwecke vervielfältigen, öffentlich ausstellen, öffentlich zugänglich machen, vertreiben oder anderweitig nutzen.

Sofern die Verfasser die Dokumente unter Open-Content-Lizenzen (insbesondere CC-Lizenzen) zur Verfügung gestellt haben sollten, gelten abweichend von diesen Nutzungsbedingungen die in der dort genannten Lizenz gewährten Nutzungsrechte.

Terms of use:

Documents in EconStor may be saved and copied for your personal and scholarly purposes.

You are not to copy documents for public or commercial purposes, to exhibit the documents publicly, to make them publicly available on the internet, or to distribute or otherwise use the documents in public.

If the documents have been made available under an Open Content Licence (especially Creative Commons Licences), you may exercise further usage rights as specified in the indicated licence.

The Emergence of Correlations in Studies of Global Economic Inter-dependence and Contagion

Eric J. Friedman*

School of Operations Research and Industrial Engineering,
Cornell University, Ithaca, NY 14853.

Simon Johnson

Sloane School of Management, MIT, Cambridge, MA 02142

A. S. Landsberg

W.M. Keck Science Center, The Claremont Colleges, Claremont, CA 91711

February 8, 2002

Abstract

We construct a simple firm-based automata model for global economic inter-dependence of countries using modern notions of self-organized criticality and recently developed dynamical-renormalization-group methods (e.g., L. Pietronero et al., Phys. Rev. Lett., 72(11):1690 (1994); J. Hasty and K. Wiesenfeld, Phys. Rev. Lett., 81(8):1722, (1998)). We demonstrate how extremely strong statistical correlations can naturally develop between two countries even if the financial interconnections between those countries remain very weak. Potential policy implications of this result are also discussed.

1 Introduction

The observed interdependence between countries poses a major puzzle. Even though trade and capital flows linkages between countries are often quite weak, it is often the case that many countries have recessions at the same time. The best recent example is the “Asian Financial Crisis” of 1997-99, when a set of relatively unconnected emerging markets all suffered

*We would like to thank Argia Sbordonne for helpful comments and discussions. A. S. Landsberg was supported in part by a Pitzer Faculty Research Award. email: friedman@orie.cornell.edu

a severe economic downturn. The simplest explanations for this phenomenon assume there exist correlated exogenous shocks across many countries; however, such exogenous shocks are difficult to observe empirically (e.g., Corsetti et al. 1998, Radelet and Sachs 1998). A second set of explanations comes out of a burgeoning body of literature on so-called contagion theory, which studies connections between countries and the transference of crises between them. (See Claessens and Forbes 2001 for a recent review and references.) One of the most intriguing (and controversial) topics of the contagion literature is the claim that correlations between countries become much stronger during periods of crisis (e.g., Rigobon 2001, Forbes and Rigobon 1999). In particular, the various forms of linkages between countries - e.g., trade links, financial channels, and channels based on beliefs - can undergo shifts, so that links which are weak for small economic events may become stronger during larger events, thereby enhancing correlations. These are sometimes dubbed multiplier effects. (See Claessens, Dornbusch and Park 2001 for a discussion and references.) For example, one set of models assume that there exist multiple equilibria within an economy, so that a shock in one country (which, for instance, might take the form of a sudden change in beliefs, such as pessimism) could cause a shift to a new equilibrium in another country (e.g., Diamond and Dybvig 1983, Masson 1998).

In this paper we suggest a simple model which naturally produces strong statistical correlations between weakly linked countries, without relying on global exogenous shocks, multiplier effects, or special channels. We illustrate this in the context of a model suggested by Krugman (1996), in which each country is modeled as a “self-organized critical” (SOC)

system of the type described by Bak, Chen, Sheinkman and Woodford (1993) and Sheinkman and Woodford (1994), denoted throughout the paper as BCSW.¹ To this basic model we add some weak linkages between countries. Our study will focus on the case of two weakly interacting countries. As noted by Krugman, the intuition behind our model is that since economic events of all sizes are observed within each country (in isolation), it is possible that with the introduction of linkages between countries, a large event in one country might naturally trigger a simultaneous large event in the other country, even when the linkages between countries are extremely weak.

Our analysis confirms this intuition, but surprisingly shows correlations that are much stronger than this simple reasoning would suggest. In particular, we demonstrate that this simple model displays the conditional correlations central to the contagion literature: for “large enough” events, the two countries are nearly perfectly correlated. This results holds irrespective of the strength of the linkages between the countries, and emerges naturally from the model without any special tuning of parameters. In effect, what we show (utilizing mathematical techniques borrowed from physics, including a “dynamical renormalization-group” analysis) is that when one considers economic events on larger and larger length scales, the *effective* interaction strength between two weakly connected countries becomes increasingly strong. Hence, two countries which are seemingly “nearly independent” (by virtue of the weak linkages between them) can nonetheless begin to exhibit unexpectedly strong correlations. This type of phenomenon was dubbed “large-scale synchrony” in Friedman and

¹One characteristic such SOC systems is that economic events of all sizes are possible within the context of the model, where an “event” can signify a financial crisis, a swing in GDP, etc.

Landsberg (2001).

Our results are quite robust, and do not depend on the precise details of the model. In fact, our results even arise for parameter values for which the models do not exhibit “self-organized criticality”, the key aspect studied by BCSW. Our results only demand the existence of local connections between the firms and nonlinearity in their behavior. Moreover, the model we examine is extremely simple, allowing us to easily simulate economies with tens of thousands of firms to numerically check our predictions.

We emphasize that our analysis does not depend on the actual channels by which contagion flows. Rather, we show that with local connections and nonlinearities the signature of contagion will arise independent of the precise details of the model. Our model displays some similarities with those of Allen and Gale (2000) and Lagunoff and Schreft (1999) among others, wherein nonlinearities and local interactions are used to model contagion. However, the building blocks of our model are much simpler, allowing for easy numerical simulations (although our model is far less analytically tractable) and may result in a more robust model.

Our analysis points to a simple prediction: the size of events over which countries become highly correlated should be larger for weakly linked countries (or regions) than for strongly linked ones. It also has an interesting implication: if policy makers are mainly interested in large economic events, then reducing the strength of connections between countries is not as important as might be thought. This suggests that it might be more effective to stabilize individual countries through local reforms, such as strengthened legal systems and more efficient markets. These are discussed more fully in Section 5.

This paper is organized as follows. In Section 2 we review the single-country model of BCSW and then present our two-country model. In Section 3 we present an overview of our main results, while in Section 4 we provide proofs and a detailed analysis. We conclude with a discussion of the results in Section 5.

2 A Simple Automaton Model

We are interested in how correlations develop between two countries containing networks of firms that are all responding to a series of small, local exogenous shocks. For illustrative purposes, we will consider the case where these shocks take the form of random exogenous orders which reduce a firm's inventory and subsequently spur production runs. We then demonstrate that large production runs in one country are highly correlated with production runs in the other even when the two countries are only weakly linked with one another.

We start by briefly reviewing the basic features of a single-country, inventory/production model studied by BCSW, and then describe our main two-country model.

2.1 A Single-Country Model

For a single country we consider a slight generalization of the model studied by BCSW. We assume that a country is made up of a two-dimensional array of firms labeled by (i, j) with $i, j \in \{0, 1, 2, \dots, L - 1\}$, and denote the inventory level of a firm by I_{ij} . The firms operate according to the following rule: A randomly chosen firm receives an (exogenous) order for one unit of a good. Provided its current inventory will not drop below some minimum value (taken here to be zero), the firm simply fills the order and its inventory is reduced by one

($I_{ij} \rightarrow I_{ij} - 1$). If, however, the firm’s inventory is too low (i.e., if $I_{ij} < 1$), then to fill the order the firm first undertakes a production run: It orders one unit from each of its two “upstream” neighbors (sites $(i + 1, j)$ and $(i + 1, j + 1)$) (see Figure 1), and uses those two units it receives to produce $2 + \alpha$ units of inventory. (α may be regarded as the “value added in production.”) The firm then fills the original order. Observe that if one of the two upstream neighbors is itself unable to immediately fill the order due to insufficient inventory, then it initiates its own production run and places orders with its two upstream neighbors, and so on. In this manner, it is possible for a chain reaction to propagate through the network, until it eventually dies out. We refer to the chain reaction of orders that results from a single initial exogenous order as an “event.” Once an event has exhausted itself, a new exogenous order is placed with a randomly selected firm, and the process repeats.

We note that this model is easily modifiable and has broader applicability: For instance, instead of treating small exogenous shocks as ‘orders’ and the subsequent chain reactions as ‘production runs’, one could equally well model an economy whose firms are subject to small ‘crises’ which result in ‘chains of collapse’, where the links between firms could be either goods or financial interdependencies.

The behavior of this model is quite complex. For example, when $\alpha = 0$, this model is an example of a self-organized critical (SOC) system. SOC systems were first introduced by Bak, Chen and Weisenfeld (1987), and have been used to explain several fundamental problems in physics, geology and biology.² In models of this type (see, e.g., BCSW, Dhar and Ramaswamy (1989)) it is well established that small shocks, such as a single exogenous order,

²A nice introduction to SOC may be found in Bak (1996).

can generate events of all sizes, including large events with global economic implications. When $\alpha > 0$, the system is no longer SOC, but it nonetheless still exhibits events of different sizes.³

We emphasize that the results to follow in this paper do not depend strongly upon the specific details of the above model. For instance, one can allow multiple exogenous orders to be placed simultaneously, as in BCSW, or even change the production-run rules: e.g., during a production run, a firm can place orders with one or both of its upstream neighbors according to some probability distribution (see Friedman and Landsberg 2001, Hasty and Wiesenfeld 1998, and Pietronero, Vespignani and Zapperi 1994 for related examples). In fact, the two principal features of this model which are relevant for our purposes are (i) the existence of many local connections, and (ii) the presence of nonlinearity.⁴

2.2 A Two-Country Model

While single-country models like that in the above example are themselves of interest, the purpose of this paper is to describe a surprising effect which arises when two such countries are allowed to weakly interact with one another. We illustrate this with a simple model, constructed as follows: Start with two (independent) countries, A and B , each evolving according to the rules described above. Inventories will be denoted by $I_{c,i,j}$, where c specifies the country ($c \in \{A, B\}$ and i, j the lattice site, with $i, j \in \{0, 1, 2, \dots, L-1\}$). For simplicity

³For SOC systems, the probability of events (e.g., production runs) of different sizes obeys a power-law distribution – the probability that an event involves s firms is proportional to $s^{-\gamma}$ for some $1 < \gamma < 2$ when s is large. For finite-size systems, this distribution has a cut-off at some s_{max} . For infinite-size

systems (to be described later), there is no such cut-off; we observe in this case that the expected size of an event is infinite. For infinite but non-SOC systems ($\alpha > 0$), the expected size of an event is finite and related results suggest that the probability that an event involves s firms falls exponentially when s is large.

⁴This is discussed in detail in BCSW.

we will assume that the countries are identical in size. Visually, it is helpful to picture the two countries, one atop the other, so that for each firm in Country A, there is a corresponding firm on the site below in Country B. (Notationally, if (c, i, j) represents a firm in one country, then (\bar{c}, i, j) will denote the corresponding firm in the other country.) The countries behave as follows. An exogenous order is placed on a randomly selected firm (c, i, j) . If the current inventory is sufficient, then the order is immediately filled and $I_{c,i,j} \rightarrow I_{c,i,j} - 1$. If not, a production run is initiated, wherein the firm orders 1 unit from each of its two upstream firms in its own country (sites $(c, i + 1, j)$, $(c, i + 1, j + 1)$), and ϵ units from each of the two corresponding upstream firms in the other country (sites $(\bar{c}, i + 1, j)$, $(\bar{c}, i + 1, j + 1)$). The firm then takes the $2 + 2\epsilon$ units and produces $2 + 2\epsilon + \alpha$ units of inventory. It then fills the order. As before, if one of the upstream neighbors is unable to immediately fill an order, then it in turn places orders with its upstream neighbors, and so forth. (For technical reasons, it will prove convenient to assume that $\epsilon \geq 0$, $\alpha \geq 0$ are rational numbers, and to impose “periodic boundary conditions” in the horizontal direction, i.e. the firm to the “right” of $(c, i, L - 1)$ is firm $(c, i, 0)$. This last assumption is only relevant for reducing the computational requirements in simulations.)

We refer to the above model as the “ ϵ -linked economies model.” Two special subcases are worthy of note: When $\epsilon = 0$, there is no linkage between the two countries; hence their behaviors are completely independent. The other extreme is the $\epsilon = 1$ case (which we refer to as the “fully-linked-economies” case). Here, the two countries are so completely linked that it no longer is even meaningful to say that a particular firm belongs to one country or

the other. Our central interest will be in the weak-coupling case, where $0 < \epsilon \ll 1$. Our goal is to demonstrate how weak links between countries can naturally produce extremely strong correlations. In particular, we will demonstrate that for large economic events, the behavior of weakly coupled economies becomes virtually indistinguishable from that of fully linked economies case. We refer to this effect as “large-scale synchrony.”

3 Large-Scale Synchrony: Overview

The potential relevance of the type of two-country model we study here was first suggested by Krugman (1996), who conjectured that linked SOC models might serve as good candidates for understanding how a large economic event in one country could potentially lead to a large event in another country. In such SOC models, one would intuitively expect to find some degree of correlation between events in the two countries, even when the linkages are fairly weak. However, the actual correlations that emerge turn out to be surprisingly stronger than one would expect from this basic intuition. In particular, our analysis indicates that when viewed from a “sufficient distance,” any ϵ -linked economies model (with $0 < \epsilon < 1$) is nearly indistinguishable from a fully linked economies model ($\epsilon = 1$). Thus, large economic events will be very strongly correlated between two countries even when the linkages between those countries are extremely weak ($\epsilon \ll 1$). We dub this phenomenon “large-scale synchrony.” In this section, we summarize the central results of this paper; extended discussions and proofs follow in Sect. 4. Note that all results presented below are for the limiting case of infinite country size $L \rightarrow \infty$; details of the limiting procedure are described in Section 4.

3.1 Summary of analytical results

We begin with a key result that describes how an exogenous order placed at one firm influences production runs at other firms. This in turn will provide some basic intuition for even stronger results which follow. Let $\rho_{cij}(c', i', j')$ be the probability that an exogenous order placed at firm (c, i, j) induces a production run at firm (c', i', j') . (We refer to $\rho_{cij}(c', i', j')$ as the *two-firm correlation function*.) Consider the following question: If an order is placed at a firm (i, j) in country c , what is the probability that this will lead to a production run at a given firm (i', j') in country c versus at the corresponding firm (i', j') in the other country \bar{c} ? Our finding is as follows:

Theorem 1 *For any ϵ -linked economies model, for any $j' \geq j$, $i' > i$ where $j' - j \leq i' - i$,*

$$\frac{\rho_{cij}(\bar{c}, i', j')}{\rho_{cij}(c, i', j')} = \frac{1 - \left(\frac{1-\epsilon}{1+\epsilon}\right)^{i'-i}}{1 + \left(\frac{1-\epsilon}{1+\epsilon}\right)^{i'-i}}.$$

[Note that when $j' - j > i' - i$ both probabilities are 0.]

Observe that this ratio approaches unity as $i' - i$ becomes large for any $0 < \epsilon < 1$. Hence, Theorem 1 shows that *an exogenous order placed on a firm in one country is equally likely to cause a production run at a distant firm in the other country as it is (at the corresponding firm) in the same country - even if the two countries are only very weakly linked*. Thus, on a large enough scale, an ϵ -linked economies model with $0 < \epsilon \ll 1$ begins to behave like the fully-linked model in certain respects.

In fact, this correspondence which emerges between a weakly-linked economies model and the fully linked case for large spatial scales is even stronger than the above theorem

would suggest, for not only do the two-firm correlation probabilities converge, but all multi-firm correlations do as well. In particular, consider an “agglomeration” of our model, where instead of focusing on the behavior of individual firms in each country, we group large numbers of neighboring firms together within each country and treat each such “meta-firm” as a single entity. Hence, in this new view, we regard each country as composed of a network of meta-firms. The rules governing the interactions between the meta-firms can be directly deduced from the underlying rules of the original model. (The details of this agglomeration process are described in Sect. 4.) By consideration of such meta-firms, a hidden connection between the weakly linked economies model and the fully linked economies model is revealed. This is encapsulated in Result 1 below (a more formal treatment and analysis of the results of this section are reserved for Sect. 4.)

Result 1 *For any $\epsilon \geq 0$ and any level of accuracy, there exists an agglomeration size for which the agglomerated version of the ϵ -linked model and the agglomerated version of the fully-linked model are approximately equivalent.*

By “approximate equivalence,” we mean that the large-scale behaviors of an ϵ -linked model (with $\epsilon \ll 1$) and a fully linked economies model are indistinguishable, i.e. *weakly linked economies begin to behave like strongly linked economies on large spatial scales*. The precise nature and meaning of this correspondence will be described more fully later. (In the language of renormalization analyses we would say that the two models fall into the same “universality class.”) However, we must note that Result 1 is based on a technique from modern physics known as renormalization, which although well-established as one of

the main tools used in the study of a wide variety of physical problems from magnetism to particle theory to chaos theory, has never been formally proven in general. The particular version of renormalization theory which we use has been studied in detail in Hasty and Wiesenfeld (1998), and Pietronero, Vespignani and Zapperi (1994) and has been applied with great success in models closely related to ours. Nonetheless, the reader may prefer to view the renormalization calculations as heuristics to guide intuition and rely upon the numerical simulations (described below) to confirm the validity of Result 1.

Result 1 describes the general convergence between a weakly linked economies model and the fully linked case for large-scale events. Result 2 below describes an important quantitative consequence of convergence. Specifically, given a single exogenous shock in country c (i.e., an external order for one unit of goods), let S_A be the size of the resulting event in country A and S_B the size in country B , where *size* here refers to the number of firms involved in the production run. (The total size of a given event is thus $S_A + S_B$). This event occurs with some probability $Pr(S_A, S_B|c)$, and we let R_M denote the random variable $(|S_A - S_B|)/(S_A + S_B)$ conditional on $S_A + S_B > M$. R_M represents the fractional difference of the number of firms affected in each country during a given production run of size $> M$. Letting $E[R_M]$, $Var[R_M]$ denote the expectation value and variance of R_M respectively, we then have the following:

Result 2 *For any ϵ -linked model ($0 < \epsilon \leq 1$), $\lim_{M \rightarrow \infty} E[R_M] = 0$ and $\lim_{M \rightarrow \infty} Var[R_M] = 0$.*

In other words, for large events, S_A will be close (in percentage terms) to S_B even if the two countries are weakly linked. This result demonstrates that it is possible for an economic event in one country to directly induce a similar magnitude event in another country even when the linkages between those countries are extremely weak.

Corollary 1 *For any ϵ linked model, the correlation coefficient between S_A and S_B conditionally on $S_A + S_B > M$ converges to 1 as $M \rightarrow \infty$.*

3.2 Numerical results

We have run a series of direct numerical simulations of the two-country model of Sect. 2.2 to verify the above analytical results and to garner further insight into the model's dynamical behavior. We illustrate the results in a series of figures. Figure 2a shows a plot of S_A vs. S_B for the fully linked model ($\epsilon = 1$). Note that, as expected, S_A and S_B are extremely correlated ($S_A \approx S_B$). Figures 2b and 2c show the corresponding graph of S_A versus S_B for a weakly linked model with $\epsilon = 0.1$. In Fig. 2b, we plot only small production runs involving fewer than 50 firms in each country, while in Fig. 2c we include all production runs up to size 1000. Observe that in the former case (Fig. 2b), the numbers of firms affected in each country during a given event are essentially uncorrelated. This is as it should be since the linkages between the countries are weak, and hence small-scale behavior in each country is essentially independent. However, in the latter case involving large events (Fig. 2c), a new trend is clearly seen. Here, very strong correlations similar to that of the fully linked case (Figure 2a) are observed, indicating the onset of large-scale statistical synchrony in the system. Note that the degree to which the two countries are correlated increases with spatial

scale, as is clear from a plot of the root-mean-square fractional deviation $\sqrt{E[(R_M)^2]}$ versus $S_A + S_B$ (Figure 3). Thus, the numerical simulations confirm the analytical predictions of Results 1 and 2, demonstrating that the behavior of a weakly linked economies model approaches that of the fully linked case for large events. We note moreover that if the linkage between two countries is further decreased (e.g. $\epsilon = 0.02$), then the characteristic size at which strong correlations first begin to appear will increase (see Figure 2d).

4 Detailed Results and Analysis

In this section we provide a more formal discussion of our model and the proofs of the preceding claims (Theorem 1, Results 1 and 2).

To begin, first recall that we have assumed for technical reasons that both ϵ (which describes the strength of inter-country connections) and α (“the value added in production”) are rational numbers; hence we may write them as $\epsilon = e/n$ and $\alpha = a/n$, where a, e are integers and n is their least common multiple. Let x_{cij}^t denote the inventory value at site (c, i, j) following the t 'th event; the allowable inventory values at a given site are $X_f = \{0, 1/n, \dots, (2n + 2e + a - 1)/n\}$. The state space for the model is thus given by $X = X_f^{2L^2}$ (L is the lattice size). The initial configuration of the system will be denoted by x^0 , and x^t will denote the configuration that arises once the model has settled down following the t 'th exogenous shock. (Note that since shocks are constrained to propagate down the supply chain and can never double back, the configuration must settle down eventually, so this is well-defined.) The intrinsic dynamics of the system, combined with the random

exogenous shocks, give a probabilistic dynamics on the state space X , and thus this model is a Markov Chain.

By construction (i.e. from the assumption that n is the least common multiple of a, e), it is easy to see that all states are recurrent⁵, and it follows from standard arguments that asymptotically the dynamics has a unique invariant measure on X . (See, e.g., Stokey, Lucas and Prescott, (1989).) Moreover, Dhar (1990) has shown that for a large class of models – of which our model is a member – the invariant measure is flat, i.e., all states are equally likely.

This in turn allows us to extend our model to the limit $L \rightarrow \infty$. The properties of the model for $L = \infty$ will be computed from the invariant measure for which all states are equally likely. Formally, we assume that each x_{cij} is i.i.d. uniformly distributed on X_f and require that all sites are independent. From this we can compute all the relevant statistics.⁶

4.1 Two-point correlation functions

We begin by examining the so-called “two-point correlation function”, $\rho_{cij}(c', i', j')$, defined as the probability that an exogenous order at firm (c, i, j) induces a production run at firm (c', i', j') (this probability is computed with respect to the invariant distribution on the state space X). Using a result proven by Dhar (1990), we will show that this two-point correlation function obeys a certain recursion relation. We will then solve this recursion

⁵Note that this is not true in the model of BCSW since they only allow orders to be placed at firms with $i = 1$, whereas we allow for exogenous orders to arise at any firm. Nonetheless, the asymptotic results are the same in either case.

⁶Note that if we truncate the random variables for the infinite model to be less than L , then we get precisely the random variables which arise for finite L . For example, let (S_A, S_B) be the random variables for the infinite model and (S_A^L, S_B^L) be the random variables for the model of size L . Then $(\min[S_A, L], \min[S_B, L]) \equiv (S_A^L, S_B^L)$.

relation exactly (by relating it to a random walk problem), which in turn leads directly to a proof of Theorem 1 of the preceding section.

Towards this end, let $-\Delta_{cij}(c', i', j')$ be the “local production matrix,” which specifies the number of orders of inventory that site (c, i, j) places directly with site (c', i', j') in the event that site (c, i, j) receives an order that it cannot fill initially. (Note that we consider here only orders that one site *directly* places with another site, not orders that are induced via a chain of events involving intermediate sites.) For our model, $\Delta_{cij}(c, i, j) = 2(1 + \epsilon) + \alpha$, $\Delta_{cij}(c, i + 1, j) = -1$, $\Delta_{cij}(c, i, j + 1) = -1$, $\Delta_{cij}(\bar{c}, i + 1, j) = -\epsilon$, $\Delta_{cij}(\bar{c}, i, j + 1) = -\epsilon$ and $\Delta_{cij}(c', i', j') = 0$ otherwise. (For clarity, we note that Δ is *not* the transition matrix for the Markov chain, nor does it define the transition during an event.) The following lemma was proven by Dhar (1990) for a large class of automaton models (to which ours belongs):

Lemma 1 (Dhar)

$$\sum_{c'', i'', j''} \rho_{cij}(c'', i'', j'') \Delta_{c''i''j''}(c', i', j') = \delta_{cij}(c'', i'', j'')$$

where $\delta_{cij}(c', i', j')$ is the Dirac δ -function, defined by $\delta_{cij}(c', i', j') = 1$ if $(c, i, j) = (c', i', j')$ and 0 otherwise.

For our model, Dhar’s formula leads to the equation

$$\rho_{cij}(c', i' - 1, j') + \rho_{cij}(c', i' - 1, j' - 1) + \epsilon \rho_{cij}(\bar{c}, i' - 1, j') + \epsilon \rho_{cij}(\bar{c}, i' - 1, j' - 1) = (2 + 2\epsilon + \alpha) \rho_{cij}(c', i', j') \tag{1}$$

together with the constraint

$$\rho_{cij}(c, i, j) = 1 / (2 + 2\epsilon + \alpha) \tag{2}$$

(which follows from setting $(c', i', j') = (c, i, j)$).

Our goal is to solve the recursion relation (??) together with (??) for the two-point correlation function $\rho_{cij}(c', i', j')$. This can be done directly. However, we provide a more intuitive proof that is easily generalized to more complex models, by relating the above recursion relation to the properties of a random walk. The proof of Theorem 1 will follow directly from this analysis.

To proceed, consider a random walk on the lattice $\{(c, i, j), (\bar{c}, i, j)\}$ defined as follows: If the walker is currently at site (c, i, j) , then the probability that the walker will step directly to neighboring site $(c, i + 1, j)$ is $1/(2 + 2\epsilon)$, to site $(c, i + 1, j + 1)$ is $1/(2 + 2\epsilon)$, to site $(\bar{c}, i + 1, j)$ is $\epsilon/(2 + 2\epsilon)$, and to site $(\bar{c}, i + 1, j + 1)$ is $\epsilon/(2 + 2\epsilon)$. We then have the following:

Lemma 2 *The random walk process defined above and the production-run recursion relation (??),(??) are equivalent.*

Proof: Let $w_{cij}(c', i', j')$ be the probability that a walker starting at (c, i, j) is at position (c', i', j') after $i' - i$ steps (for $i' \geq i$). Then it is straightforward to see that, by construction, the random-walk process obeys the following relation:

$$\frac{1}{2 + 2\epsilon} [w_{cij}(c', i' - 1, j') + w_{cij}(c', i' - 1, j' - 1) + \epsilon w_{cij}(\bar{c}', i' - 1, j') + \epsilon w_{cij}(\bar{c}', i' - 1, j' - 1)] = w_{cij}(c', i', j'). \quad (3)$$

(Note that, by definition, $w_{cij}(c, i, j) = 1$.) Consider now the transformation

$$\rho_{cij}(c', i', j') = w_{cij}(c', i', j') \left(\frac{2 + 2\epsilon}{2 + 2\epsilon + \alpha} \right)^{i' - i} (2 + 2\epsilon + \alpha)^{-1}. \quad (4)$$

By direct substitution of transformation (??) into (??), one recovers precisely the recursion relation (??) along with the constraint (??), as may be readily verified \diamond

Thus, the probability that a shock at site (c, i, j) causes a production run at site (c', i', j') is directly related to the probability that the random walk defined above starting at (c, i, j) will hit (c', i', j') . Note that the random walk is essentially the reverse of the path followed by a good supplied by firm (c', i', j') . The proof of Theorem 1 now follows from the observation that for a long enough path, a unit of goods (i.e., the random walker) will alternate countries enough times that it “forgets” its country of origin. This insight is quite general and should apply to many different models in which there are many local interactions.

Proof of Theorem 1: Consider a path followed by the random walk. We can project this path into two components: a walk on (i, j) space and the walk back and forth between countries, (c) space. These two walks are independent (by the defining rules of this walk, as described above), and thus we can write $w_{cij}(c', i', j')$ as the product $w_{cij}(c', i', j') = \gamma_c(c'; i' - i)\psi_{ij}(i', j')$, where $\gamma_c(c'; i' - i)$ is the probability that a random walker starting in country c will be in country c' after precisely $i' - i$ steps, and $\psi_{ij}(i', j')$ is the probability the walker starting at (i, j) will arrive at site (i', j') after $i' - i$ steps. We now can compute $\gamma_c(c'; i' - i)$ by constructing the Markov chain describing this random walk between countries, as follows. Let v^t denote a two-component vector whose first (resp. second) component is the probability that the walker is in country A (resp. country B) after t steps. Then

$$v^{t+1} = Mv^t \quad \text{where} \quad M = \begin{pmatrix} \frac{1}{1+\epsilon} & \frac{\epsilon}{1+\epsilon} \\ \frac{\epsilon}{1+\epsilon} & \frac{1}{1+\epsilon} \end{pmatrix}.$$

Assuming a starting configuration $v^0 = (1, 0)^T$, we solve to find

$$v^t = \frac{1}{2} \begin{pmatrix} 1 + \left(\frac{1-\epsilon}{1+\epsilon}\right)^t \\ 1 - \left(\frac{1-\epsilon}{1+\epsilon}\right)^t \end{pmatrix}.$$

From the definition of $\gamma_c(c'; i' - i)$ above and transformation (??), Theorem 1 follows. \square

Note that this shows that when viewed on a large enough scale, the ϵ -linked model (for any $\epsilon > 0$) is symmetric, in the sense that if an order is placed at country A , the effect on firms (c, i', j') and (\bar{c}, i', j') is the same, which is also true of the fully connected model.⁷ If we were able to rigorously prove this about all higher-order correlation functions as well, then our analysis would be complete; however, the analogous formulas (to Dhar's) for higher-order correlations are extremely complex. Thus, in the next section, we use a different line of attack to argue for the same result, using a so-called “renormalization-group analysis.”

4.2 Renormalization

The theory behind Result 1 of Sect. 3 is based on a renormalization result from Friedman and Landsberg (2001) for a related class of models. In that study, a probabilistic version of two-country automaton model was analyzed using an ‘agglomeration’ procedure (alluded to in the previous section), and it was shown that for such systems:

Result 3 (Friedman and Landsberg, 2001) *The dynamics of an agglomerated ϵ -linked model ($0 < \epsilon < 1$) and the corresponding dynamics for a fully-linked agglomerated model ($\epsilon = 1$) converge as the agglomeration size is increased.*

⁷This also implies that in the model with finite L , for $S_A + S_B$ sufficiently large the expectation of $(S_A - S_B)/(S_A + S_B)$ will be close to zero, even if we condition the premise that the initial order was placed at a firm in country A .

This result implies that the ϵ -linked model and the fully-linked model fall into the same universality class, and hence will exhibit the same large-scale behaviors. It can be shown that our deterministic model shares the same behavior as this probabilistic model of Friedman and Landsberg (2001), and hence Result 1 directly follows. We provide below a basic sketch of this result as it applies to our model (and refer the reader to Friedman and Landsberg (2001) for additional details). Once again we note that Result 1 cannot be considered a formal mathematical theorem since it relies on a renormalization-group analysis for which few systematic, analytical theorems exist. Nonetheless, renormalization represents a very well-established, standard tool in mathematical physics and has been successful in analyzing a wide variety of problems. Friedman and Landsberg (2001) used a generalization of a procedure developed by Hasty and Wiesenfeld (1998), which was extensively tested in that paper on a generalized single country model.

The basic idea of renormalization is to repeatedly group together individual firms into larger and larger “meta-firms.” For our model we consider meta-firms of size $2^k \times 2^k$ (for some positive integer k). See Fig. 4. Formally, the set of individual sites making up a particular meta-firm (in a given country) can be expressed as

$$MF_{c,a,b}^{2^k} = \{(c, i, j) \mid i \in [a2^k, a2^k + 2^k], j \in [b2^k, b2^k + 2^k], i - j \in [a - b, a - b + 2^k]\}$$

for all integer vectors (a, b) . The dynamical rules governing the interaction of such meta-firms (i.e., the “meta-dynamics”) can be computed using the procedure described in Friedman and Landsberg (2000).⁸ One finds that the meta-dynamics of an ϵ -linked economies model

⁸Analytically, the process works by first computing the meta-dynamics for groups of 4 firms ($k = 1$) based on the original (microscopic) rules governing individual firms. The rules governing these meta-firms

becomes indistinguishable from that of a fully-integrated economies model as k approaches infinity (Result 3). Thus, the large-scale behaviors of the two models become approximately equivalent.

We next prove Result 2 of the preceding section, showing that approximately equal numbers of firms are affected in each country during a given large event, irrespective of which country the event started in. As described below, this is done by using Result 1 in conjunction with the following lemma:

Lemma 3 *For any fully-linked model, given $\alpha > 0, \beta < 1$, there exists some $M > 0$ such that $Pr[|S_A - S_B|/(S_A + S_B) < \alpha(S_A + S_B) \mid S_A + S_B > M] > \beta$.*

Proof: Note that in the fully linked model there is no difference between firm (c, i, j) and firm (\bar{c}, i, j) in its relationship to other firms. Letting $F = \{(c, i, j)\}$ denote the set of all firms in both countries, with $c \in \{A, B\}$ and $i, j \in \{0, 1, 2, \dots, L - 1\}$, we can define a permutation γ of this set by interchanging a firm (c, i, j) with its opposite-country partner (\bar{c}, i, j) at selected sites in the lattice. Let Γ denote the set of all such permutations.

Consider an event. Let R denote the set of all sites which had production runs during that event. From this we construct a new set $P(R)$, a projection of R , by ignoring which country each firm belongs to, as follows: $P(R) = \{(i, j; n)\}$, where (i, j) specifies a firm's location (irrespective of its country affiliation). Note that if some site (c, i, j) along with its opposite-country counterpart (\bar{c}, i, j) both belong to the set R , then they both get projected onto the same site $(i, j; 2)$ in $P(R)$. We refer to such a pair as a “doublet,” and distinguish it

then provide the basis for computing the meta-dynamics of the new ($k = 2$) meta-firms created in the re-agglomeration process, and so on. See Friedman and Landsberg (2000) for the details.

by the integer label $n = 2$; if only one member of a pair belongs to R (i.e. $(c, i, j) \in R$ but not (\bar{c}, i, j)), then the projection of this “singlet” state is $(i, j; 1) \in P(R)$. For example, if $R = \{(A, 1, 1), (A, 2, 1), (B, 2, 1)\}$ then $P(R) = \{(1, 1; 1), (2, 1; 2)\}$. Note that any permutation of an event, $\gamma(R)$ for $\gamma \in \Gamma$, will have the same projection, i.e. $P(\gamma(R)) = P(R)$. Moreover, since the model is invariant under Γ , then all permutations of an event have the same probability of occurrence. From this we can compute the expected value of $f = |S_A - S_B|/(S_A + S_B)$ over the set of permutations of a particular event R_N , as follows:

Consider f conditioned on a particular projection $p = P(R)$ for some R with $S_A + S_B = N$. For this projection let N_d denote the number of doublets in the set and $N_s = N - 2N_d$ the number of singlets. Note that while all permutations of R have the same N_d and N_s , they differ in how the singlets are distributed among the two countries A and B. In particular, if we consider the set of all permutations of R , since all permutations are equally probable it follows that the singlets will be binomially distributed among the two countries. Letting S_A, S_B denote the total number of toppling sites in countries A, B (respectively), the random variable (S_A, S_B) conditional on $S_A + S_B = N$ with fixed N_d, N_s will be distributed as $N_d + \text{Binomial}(N_s, 1/2)$. Note that this distribution is for all events with projection $P(R)$. Other events of size N will have different values of N_d, N_s (with $2N_d + N_s = N$). For a fixed N , the potential values of N_s lie in the interval $[0, N]$, and it is straightforward to show that the expected fractional deviation above will be maximum for the choice $N_s = N$. Lemma 3 directly follows by setting $N_s = N$ and letting N become large, and noting that the asymptotic properties of the binomial distribution are such that it converges to a normal

distribution with mean 0 and variance proportional to $N^{-1/2}$. Thus, as $N \rightarrow \infty$ the fractional difference between S_A and S_B approaches 0. \square

The above lemma, taking in combination with Result 1 showing that the ϵ -linked and fully linked models behave similarly on large scales, proves Result 2, as desired⁹.

5 Discussion

We have constructed a simple model of intercountry links in which even weak links can lead to high correlations for large economic events. This model displays the hallmark of the contagion literature – weakly linked countries are highly correlated for large events but not for small ones – without the use of any ad-hoc channels or multiplier effects. In particular, our results only depend on local interactions and nonlinearities and not on the detailed structure of the interactions, nor on the precise nature of the channels that mediate the shocks. Moreover, our results do not depend upon the notion of self-organized criticality as does the analysis in BCSW, but neither does it rule it out. (Only when $\alpha = 0$ does our model display self-organized criticality.)

In addition, in our model the size at which correlations arise is directly related to a natural parameter, the strength of the intercountry links. This leads to the prediction that weakly linked countries will exhibit strong correlations only for large economic events, while similar correlations between strongly linked countries will set in earlier (i.e., for smaller economic events). Thus, our model has an interesting policy implication: reducing the strength of

⁹As stated previously, however, the renormalization-group methodology employed in the derivation of Result 1 has not, to date, succumbed to formal mathematical proof, though it is a widely used mathematical tool that has been supported by extensive numerical simulations. Extensive numerical testing of our model strongly supports the validity of Result 1.

linkages between countries will not significantly reduce the probability of large events being correlated across multiple countries.

We (tentatively) suggest that perhaps the more important policy issue is the strength of the markets within the country, which we believe is highly correlated with the strength of the legal system (see e.g., Johnson et. al. (1998) and La Porta et. al (1997) and (1998)). Our argument is based on the idea that large-scale synchronization arises in our model due to the local connections between firms. Such local connections are crucial in countries with weak legal systems, as firms often rely on long-term relationships with suppliers to guarantee quality. In countries with strong legal systems firms can more often purchase goods on the open market. (Even in the case of special-order goods, it is much easier to find a new supplier, since issues of trust are reduced due to the enforceability of contracts.) Thus, we think that our model, and with its emphasis on fundamental instabilities, is much more applicable to countries with weak legal systems and nascent markets than countries with stronger legal systems and established markets, the settings which recently have been most prone to economic crises.

References

- [1] F. Allen and D. Gale. Financial contagion. *Journal of Political Economy*, 108(1):1, 2000.
- [2] P. Bak. *How nature works : the science of self-organized criticality*. Copernicus, New York, 1996.

- [3] P. Bak, K. Chen, J. Sheinkman, and M. Woodford. Aggregate fluctuations from independent sectoral shocks: Self-organized criticality in a model of production and inventory dynamics. *Ricerche Economiche*, 47(1):3, 1993.
- [4] P. Bak, K. Chen, and K Wiesenfeld. Self-organized criticality: an explanation of $1/f$ noise. *Physical Review Letters*, 59(4):381, 1987.
- [5] S. Claessens, R. Dornbusch, and Y. Park. International financial contagion: How it spreads and how it can be stopped. In S. Claessens and K. Forbes, editors, *International Financial Contagion*. Kluwer Academic, Norwell, Massachussets, 2001.
- [6] S. Claessens and K. Forbes. *International Financial Contagion*. Kluwer Academic, Norwell, Massachussets, 2001.
- [7] G Corsetti, P. Pesenti, and N. Roubini. What caused the asian currency and financial crisis? part i: A macroeconomic overview. <http://www.stern.nyu.edu/roubini-asia-AsiaHomepage.html>, 1998.
- [8] Dhar D. Self-organized critical state of sandpile automaton models. *Physical Review Letters*, 64(14):1613, 1990.
- [9] Ramaswamy R Dhar D. Exactly solved model of self-organized critical phenomena. *Physical Review Letters*, 63(16):1659, 1989.
- [10] D. Diamond and P. Dybvig. Bank runs, deposit insurance, and liquidity. *Journal of Political Economy*, 91:401, 1983.

- [11] K. Forbes and R. Rigobon. No contagion, only interdependence: Measuring stock market co-movements. NBER Working Paper No. W7267, July, 1999.
- [12] E. J. Friedman and A. S. Landsberg. Large-scale synchrony in weakly interacting systems. *Physical Review E*, 63: 051303 2001.
- [13] J. Hasty and K. Wiesenfeld. Renormalization group for directed sandpile models. *Physical Review Letters*, 81(8):1722–1725, 1998.
- [14] S. Johnson, E. Friedman, D Kaufmann, and P. Zoido-Lobaton. Corporate governance in the asian financial crisis, 1997-98. *Journal of Financial Economics*, 58:141–186, 2000.
- [15] P. Krugman. *The Self Organizing Economy*. Blackwell Publishers, Cambridge, MA, 1996.
- [16] R. Lagunoff and S. Schreft. Financial fragility with rational and irrational exuberance. *Journal of Money, Credit and Banking*, 31(3):531–60, 1999.
- [17] P. Masson. Contagion: Monsoonal effects, spillovers, and jumps between multiple equilibria. IMF Working Paper, 1998.
- [18] L. Pietronero, A. Vespignani, and S. Zapperi. Renormalization scheme for self-organized criticality in sandpile models. *Physical Review Letters*, 72(11):1690–3, 1994.
- [19] R. La Porta, F. Lopez de Silanes, A. Shleifer, and R. Vishny. Legal determinants of external finance. *Journal of Finance*, 52:1131–1150, 1997.

- [20] R. La Porta, F. Lopez de Silanes, A. Shleifer, and R. Vishny. Law and finance. *Journal of Political Economy*, 106:1113–55, 1998.
- [21] S. Radelet and J. Sachs. The east asian financial crisis: Diagnosis, remedies, prospects. Brookings Papers on Economic Activity, 1998.
- [22] R. Rigobon. Contagion: How to measure it? NBER Working Paper No. W8118, February., 2001.
- [23] J. Sheinkman and M. Woodford. Self-organized criticality and economic fluctuations. *American Economic Review*, 84(2):417–21, 1994.
- [24] N. Stokey, R. Lucas Jr, and E. Prescott. *Recursive Methods in Economic Dynamics*. Harvard University Press, Cambridge MA, 1989.

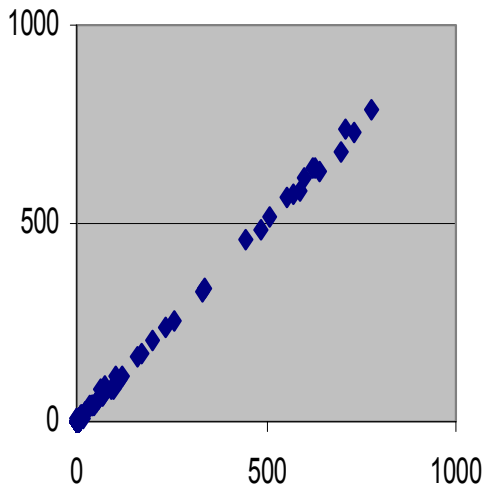

(a) $\epsilon=1$

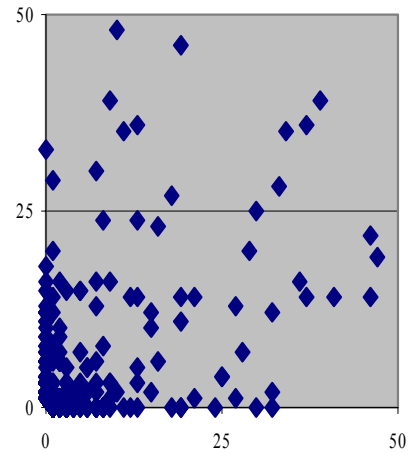

(b) $\epsilon=0.1$

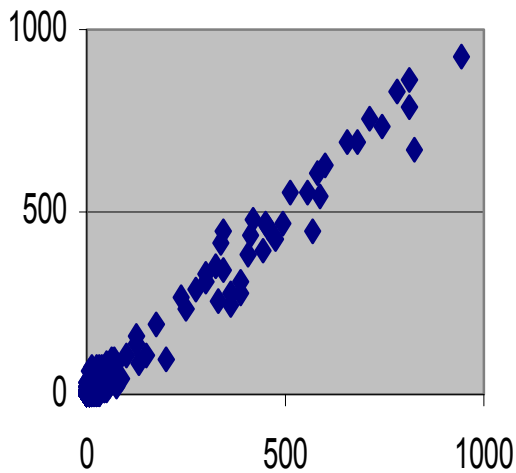

(c) $\epsilon=0.1$

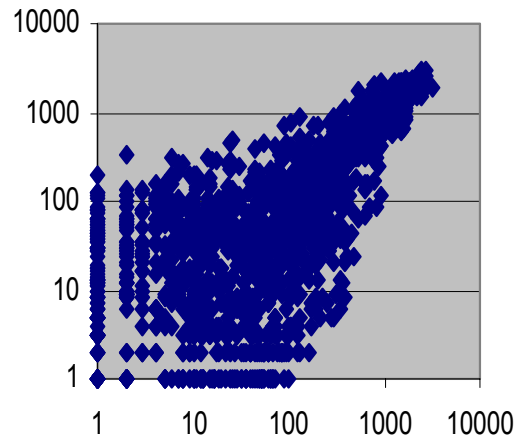

(d) $\epsilon=0.02$

Figure 2: Scatter plots of S_A vs. S_b . (a) fully linked model ($\epsilon=1$). (b) a weakly linked model ($\epsilon=0.1$) showing only small events. (c) same as (b) except large Events are also shown. (d) A log-log plot of an extremely weakly Linked model ($\epsilon=0.02$).

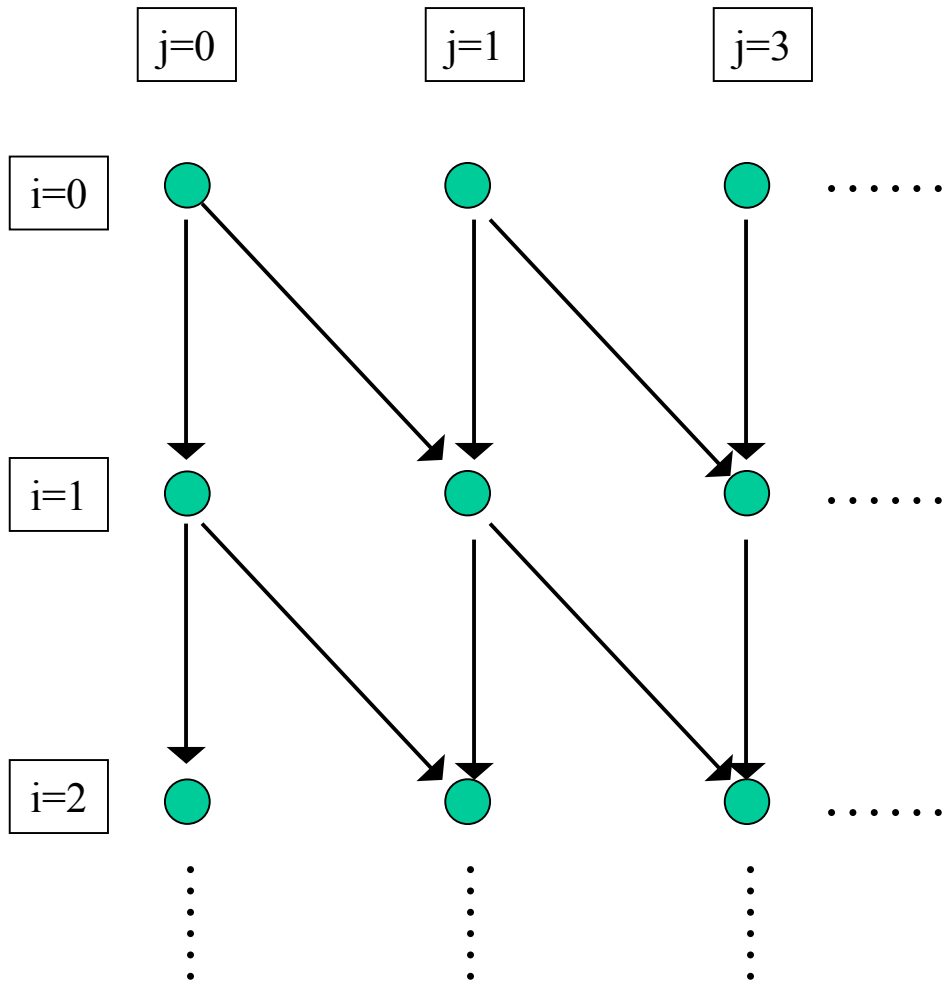

Figure 1: A lattice of firms. Circles indicate firms and the arrows indicate the direction of order flows. Note that only a small section of the lattice is shown.

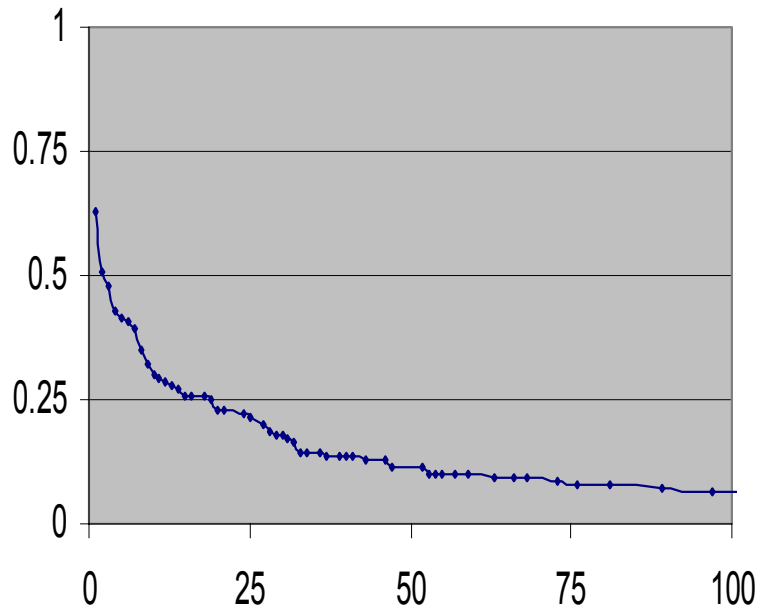

Figure 3: Graph of root mean squared deviation vs. total event size for a weakly linked model ($\epsilon=0.1$).

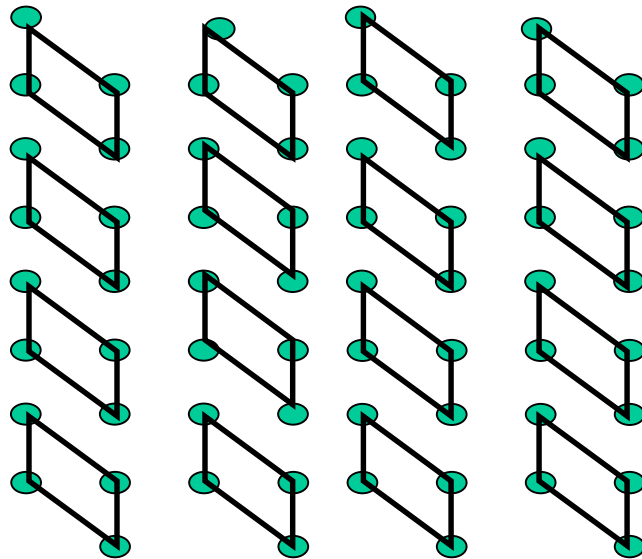

Figure 4: Agglomeration process, $k=1$. Circles represent firms. Lines connect firms into meta-firms.