

Gäckle, Christian; Schustereder, Ingmar; Waeger, Patricia

Working Paper

The changing relative price of skill-intensive goods

Kiel Advanced Studies Working Papers, No. 433

Provided in Cooperation with:

Kiel Institute for the World Economy – Leibniz Center for Research on Global Economic Challenges

Suggested Citation: Gäckle, Christian; Schustereder, Ingmar; Waeger, Patricia (2006) : The changing relative price of skill-intensive goods, Kiel Advanced Studies Working Papers, No. 433, Kiel Institute for the World Economy (IfW), Kiel

This Version is available at:

<https://hdl.handle.net/10419/27012>

Standard-Nutzungsbedingungen:

Die Dokumente auf EconStor dürfen zu eigenen wissenschaftlichen Zwecken und zum Privatgebrauch gespeichert und kopiert werden.

Sie dürfen die Dokumente nicht für öffentliche oder kommerzielle Zwecke vervielfältigen, öffentlich ausstellen, öffentlich zugänglich machen, vertreiben oder anderweitig nutzen.

Sofern die Verfasser die Dokumente unter Open-Content-Lizenzen (insbesondere CC-Lizenzen) zur Verfügung gestellt haben sollten, gelten abweichend von diesen Nutzungsbedingungen die in der dort genannten Lizenz gewährten Nutzungsrechte.

Terms of use:

Documents in EconStor may be saved and copied for your personal and scholarly purposes.

You are not to copy documents for public or commercial purposes, to exhibit the documents publicly, to make them publicly available on the internet, or to distribute or otherwise use the documents in public.

If the documents have been made available under an Open Content Licence (especially Creative Commons Licences), you may exercise further usage rights as specified in the indicated licence.

The Kiel Institute for the World Economy
Düsternbrooker Weg 120,
D-24105 Kiel

Working Paper No. 433

**The Changing Relative Price
of Skill-Intensive Goods**

by

Christian Gäckle, Ingmar Schustereder
and Patricia Waeger

March 2006

Kiel Advanced Studies Working Papers are preliminary papers, and responsibility for contents and distribution rests with the authors. Critical comments and suggestions for improvement are welcome.

The Changing Relative Price of Skill-Intensive Goods

Christian Gaeckle¹ Ingmar Schustereder² Patricia Waeger^{3 4}

21st March 2006

Abstract

Based on the conceptual results of Findlay, Grubert (1959) and Krugman (2000) we analyze the movement of the relative price of skill-intensive goods under skill-biased technological change and the countervailing effect of increasing world-wide supply of low-skilled-labor.

While the labor supply effect has become more important in the last two decades, we show that the distinction between large and small technological progress is crucially important for analyzing the changing pattern of relative price developments.

Keywords: skill-biased technological change, unskilled-labor supply, relative goods prices

JEL Classification: F11, F14, F16

¹ Kiel Institute for World Economics Advanced Studies Program (gaeckle@asp.ifw-kiel.de).

² Kiel Institute for World Economics Advanced Studies Program (schustereder@asp.ifw-kiel.de).

³ Kiel Institute for World Economics Advanced Studies Program (waeger@asp.ifw-kiel.de)

⁴ We thank Henning Klodt, Harmen Lehment and all ASP students for their advice.

1 Introduction

The integration of world economy leads to an aggravated labor market competition between the developed countries and the low-skilled-labor abundant countries. In the public debate, there is an increasing fear that this ends up in a trend decline in the real wage and lower employment opportunities of low-skilled workers in the western hemisphere. Moreover, the impact of global trade liberalization on the labor market in terms of an increasing relative wages of skilled compared to lower skilled workers is discussed frequently. However, trade is not the only determinant of change in an economy's labor demand. As labor economists argue the main source for the skill-premium is skill biased technological change .

In the light of the conceptual results of Findlay, Grubert (1959) and Krugman (2000) we contribute to this debate by analyzing the relative price development of skill-intensive industry goods. Increasing world-wide supply of unskilled-labor and skill-biased technological progress in the low-skilled intensive sector should lead to a rise in the relative price of skill-intensive goods. In contrast, a skill-biased technological progress in the skill-intensive sector is expected to decrease the relative prices of goods with a high skill-intensity.

So far there appear to be few empirical studies that try to untangle these possibilities in detail. Referring to earlier findings reported in Nunnenkamp et al. (1994), we will analyze time-series movements of detailed US producer price indices and try to identify the impact of these countervailing effects based on qualitative reasoning.

The paper is organized as follows. In section 2 we present the observed pattern of the relative price changes of skill-intensive goods from 1950 to 2003 for selected industry sectors. In section 3 we show the theoretical framework for analyzing changes in relative product prices. We start by explaining the Lerner-Diagram for three goods and two cones of diversification in a Heckscher-Ohlin-Model framework. Based on this methodology we first consider the effects

of a change in unskilled-labor supply and then analyze how skill-bias technological change in the low as well as in the high skill-intensive sector influences the relative price of skill-intensive goods. In section 4 we interpret the time-series movements of skill-intensive goods and show the implications for the labor-market. Section 5 concludes.

2 The Changes in the Relative Prices of Skill-intensive Goods from 1950-2003

2.1 Data Description and Methodology

Referring to earlier findings reported in Nunnenkamp et al. (1994), measures of changes in the relative price of skill-intensive goods will be constructed based on detailed US producer price indices. We choose producer price indices from the world's largest economy which is able to influence its own terms of trade. These producer price indices are available in detail for various sectors over a long period starting in 1950.⁵ Moreover, they are adjusted for quality improvements as far as it is methodically possible.⁶

In order to group industry sectors according to their skill-intensities we follow the *UNCTAD classification* which is shown in Table 1.⁷ Yet, we only distinguish between three product categories by factor-intensity summarizing the labor-intensive and the low-skilled manufactures into one group and leaving out *non-fuel primary commodities*.

⁵ Other countries are not considered in this analysis due to comparability problems of cross-country industry data. Further research extending the country scope requires a detailed disaggregation of sector composition.

⁶ See US Department of Labor – Handbook of Methods– for a detailed description of the methods of quality improvements for the producer price indices.

⁷ See UNCTAD (1996). This classification is further strengthened when total R&D spending is analysed per sector.

Tab. 1: Product Categories by factor intensity

Product Categories by factor intensity	Respective industries
<i>Non-fuel primary commodities</i>	
<i>Labour-intensive and resource-intensive manufactures</i>	Leather, Textiles, Apparel, Footwear, Toys and sports equipment, Wood and paper products, Non-metallic mineral products
<i>Low-skill-, technology-, capital- and scale-intensive manufactures</i>	Iron and steel, Fabricated metal products, Simple transport equipment, Sanitary and plumbing equipment, Ships and boats
<i>Medium-skill-, technology-, capital- and scale-intensive manufactures</i>	Rubber and plastic products, Non-electrical machinery, Electrical machinery other than semiconductors, Road motor vehicles
<i>High skill-, technology-, capital- and scale-intensive manufactures</i>	Chemical and pharmaceutical products, Computers and office equipment, Communications equipment and semiconductors, Aircraft, Scientific instruments, watches and photographic equipment

Source: UNCTAD (1996).

Within the high-skilled group we present the empirical observations for the industry sectors *drugs & pharmaceuticals, chemicals and industrial chemicals*. Concerning the medium-skilled group results are shown for the sectors *motor vehicles, machinery & equipment and electric machinery & equipment*. Finally, we look at *textiles & apparel, non-metallic mineral products* and *iron & steel* to investigate the price development for the low-skilled sector. For the respective nine different sectors we show the time-series from 1950 – 2003 depicting each change in relative price for a skilled versus a lower skilled product sector. Moreover, we con-

sider one sector per skill-intensity group versus the *Industrial Commodity Price Index*⁸ to give an intuition on the price development relative to an overall price index.

2.2 Results for US Producer Prices

Before turning to the development of relative prices, Table 2 gives a survey on absolute price changes for the considered goods (index 1970 = 100), hereby choosing three time periods: 1970-1979; 1970-1989; 1970-2003. Over the complete observation period, the price increase of high-skill-intensive manufactures is more pronounced compared to both the price dynamics of low- and medium-skill-intensive manufactures. However, there is a distinctive intrasectoral difference in the absolute price development, especially within the low- and high-skilled intensive group. To extract the patterns of relative price changes a confrontation of single industries with each other becomes necessary.

Tab. 2: US Producer Price Indices for Selected Commodities

Factor Intensities	1970 - 1979	1970 - 1989	1970 - 2003
Low skill-intensive manufactures			
Iron and Steel	245,9	350,3	357,4
Nonmineral metallic products	219,8	320,0	419,8
Textiles and allied products	157,4	214,3	228,6
Medium skill-intensive manufactures			
Machinery & Equipment	191,8	294,5	304,8
Motor Vehicles	175,6	268,4	299,3
Electric Machinery & Equipment	168,2	260,0	249,9
High skill-intensive manufactures			
Chemicals	217,1	351,4	462,3
Industrial Chemicals	261,9	401,4	495,5
Drugs & Pharmaceuticals	157,5	332,0	569,9

Source: US Department for Labor.

⁸ Unfortunately, there are no available data for “New Economy” sectors for the chosen time periods. These data are usually only available from 1991 onwards. Moreover, further investigations could concentrate on a more detailed sector division (more than 3 digits) for the shorter time period 1991–2003.

Figure 1a depicts the relative price change of *textiles & apparel*, *motor vehicles* and *drugs & pharmaceuticals* against the Industrial Commodities Producer Price Index. Correspondingly, Figure 1b describes the average annual growth rate of respective relative prices over the considered five decades. The relative prices of the most skill-intensive sector *drugs & pharmaceuticals* and the least skill-intensive sector *textiles & apparel* in our classification are falling until the early 1980s. In the subsequent periods up to 2003, the trend moves in opposite directions with the price of *pharmaceuticals* sharply increasing and that of *textiles & apparel* continuing to fall relative to the Industrial Commodity Price Index. The relative price of the *motor vehicles* remained remarkably constant over time with the exception of the 70's where a decline of 2,53% per year can be observed.

Fig. 1: Selected commodity prices relative to the Industrial Commodities Producer Price Index

a) Development in time

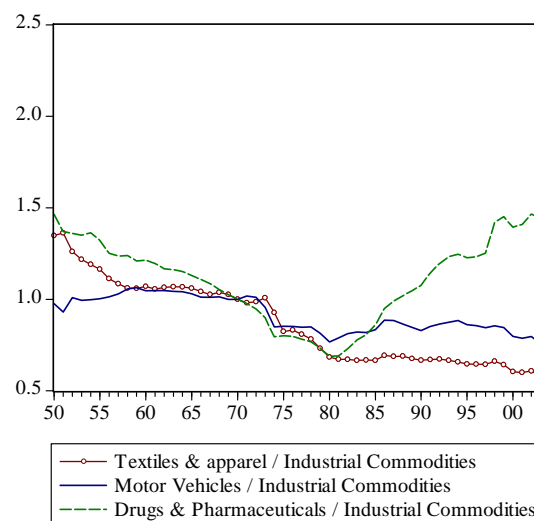

b) Average annual growth rates

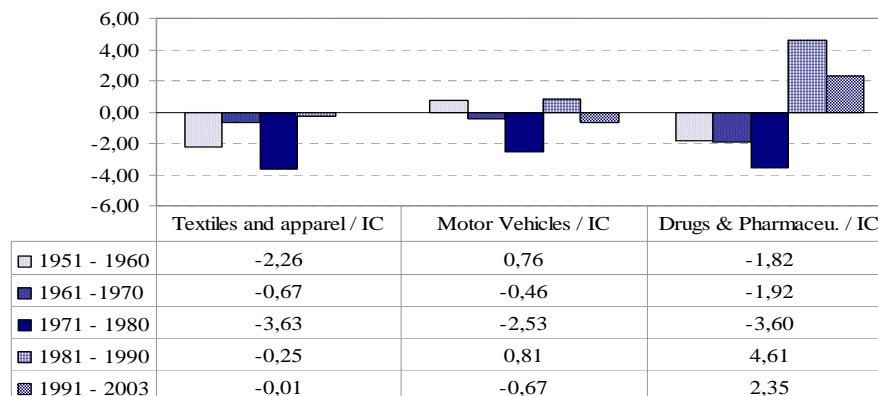

Source: US Department of Labor.

After this general overview of price development in the three respective groups, we further deepen our considerations by confronting the producer price of *drugs & pharmaceuticals* with each industry sector of the two lower skilled groups (Figure 2 a, b).

Fig. 2: The price development of Drugs & Pharmaceuticals relative to the prices of low- and medium skilled goods

a) Development in time

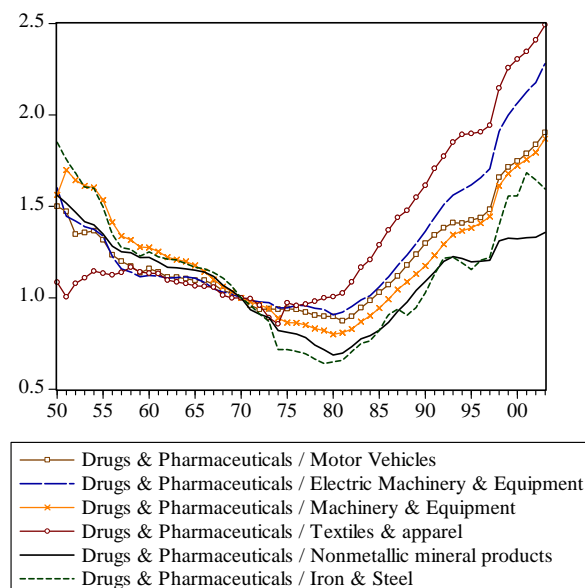

b) Average annual growth rates

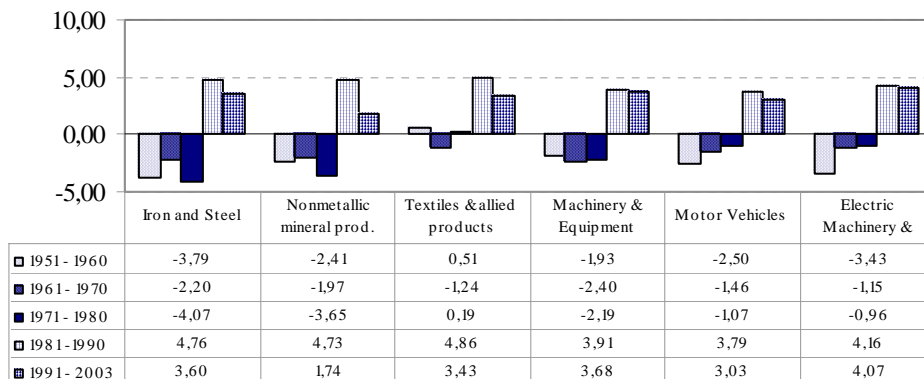

Source: US Department of Labor.

The development of the relative price over the considered time period is twofold. The relative prices were continuously falling until the mid-70s with the smallest decrease occurring in the price of *drugs & pharmaceuticals* relative to *textiles & apparel*. After a period of around five years, there has been a tremendous increase in the relative price of this high-skilled intensive good. The increase relative to the sectors of the low-skilled group is not systematically more pronounced than for the medium-skilled manufactures.

Complementary to this analysis we now focus on the producer prices of the remaining two high-skilled-intensive industries - *chemicals* and *industrial chemicals* – and confront both with each lower skill-intensive industry sector (Figure 3a, b; Figure 4a, b).

Fig. 3: The price development of Chemicals relative to the prices of low- and medium skilled goods

a) Development in time

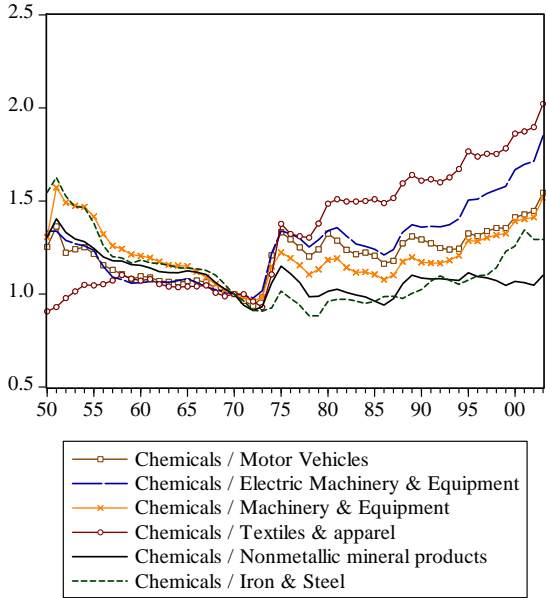

b) Average annual growth rates

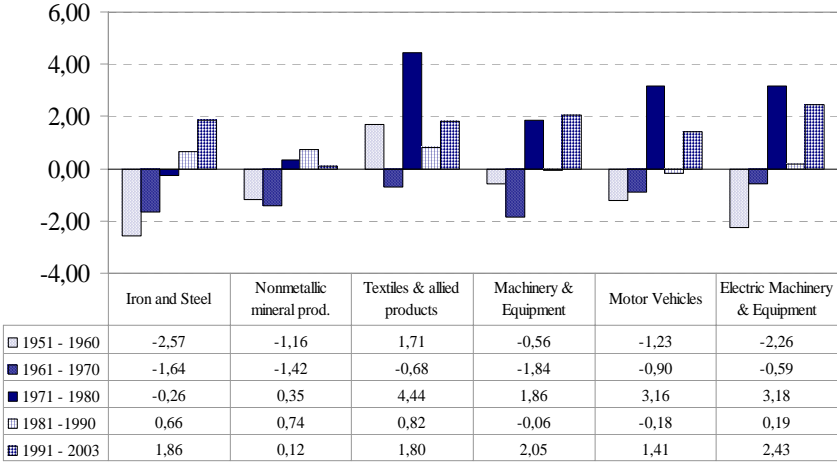

Source: US Department of Labor.

Fig. 4: The price development of Industrial Chemicals relative to the prices of low- and medium skilled goods

a) Development in time

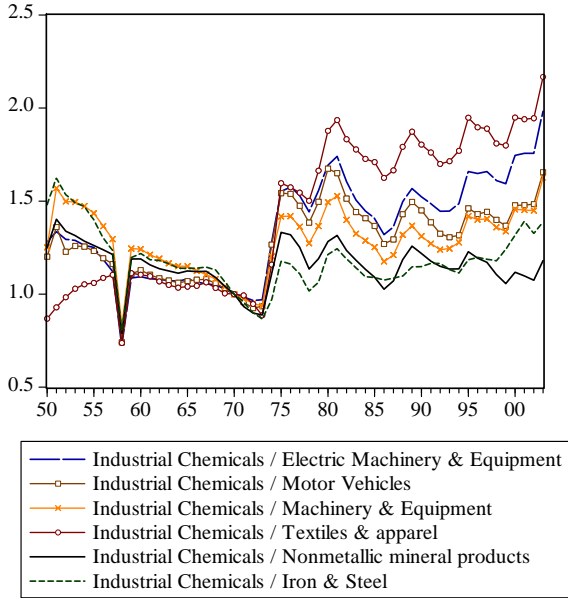

b) Average annual growth rates

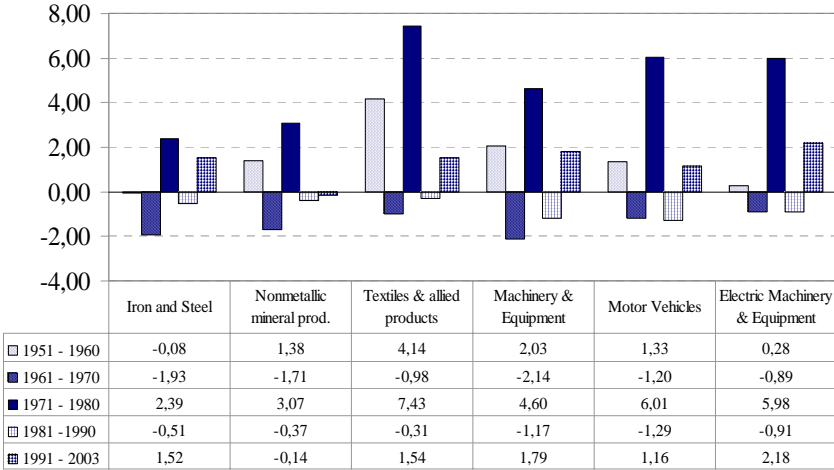

Source: US Department of Labor.

Due to similar supply conditions, both sectors show a rather coherent picture regarding their relative price development: In the first two decades, the decreasing pattern that we found in the relative price of *drugs & pharmaceuticals* is also observable both chemical industries. However, in the following decade the first oil-price shock in 1973⁹ lead to a price-rocketing effect for the subsequent two years pushing the two sectors on a higher relative price level. In the following years and contrary to the *drugs & pharmaceuticals* sector, these two high-skilled sectors show no clear sign of an increase in their price relative to sectors with a lower skill-intensity. Only for the last ten years of the observation period, a slight increase in the price trend of the *chemicals* sector can be observed.

Finally we turn to the price changes of medium skill-intensive goods relative to the price of low-skilled goods (Figures 5a, b to 7a, b). For all three considered time-series, a significantly smaller range of relative price changes can be observed compared to the previous findings.

In addition to the turning points of relative price changes that we observed in the direction of change in the high-skilled manufactures, we cannot spot equal patterns for the medium-skilled sectors. In fact, we observe patterns which largely depend on the specific low-skilled sector compared. The relative price of all three medium-skilled sectors rises in terms of the *textiles & apparel* sector. At the same time, we see a declining price of *electric machinery & equipment*, *motor vehicles* and *machinery & equipment* concerning both *iron & steel* and *non-metallic mineral products* even though the relationship is only adumbrated.

⁹ We cannot explain the sharp down- and upturn in 1957-58.

Fig. 5: The price development of Electric Machinery & Equipment relative to the prices of low-skilled goods

a) Development in time

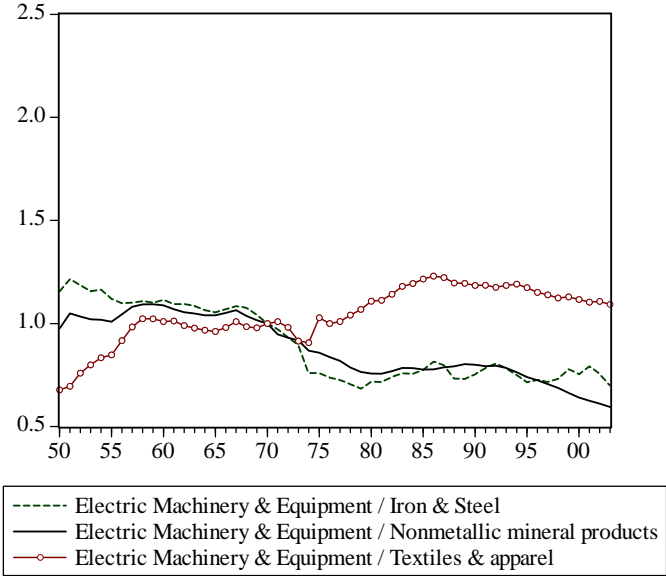

b) Average annual growth rates

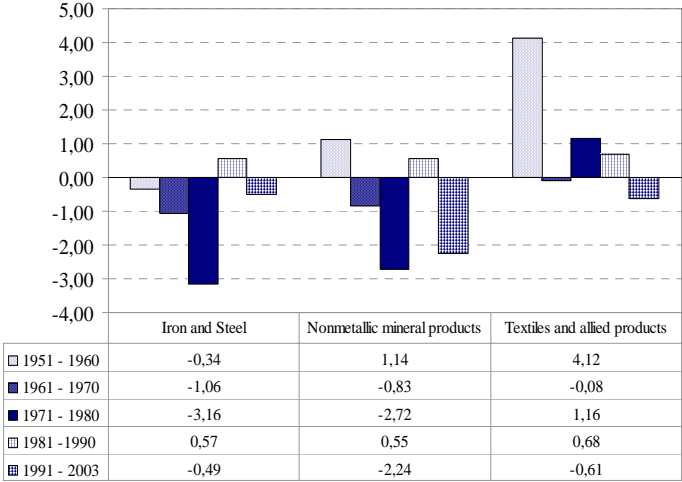

Source: US Department of Labor.

Fig. 6: The price development of Machinery & Equipment relative to the prices of low-skilled goods

a) Development in time

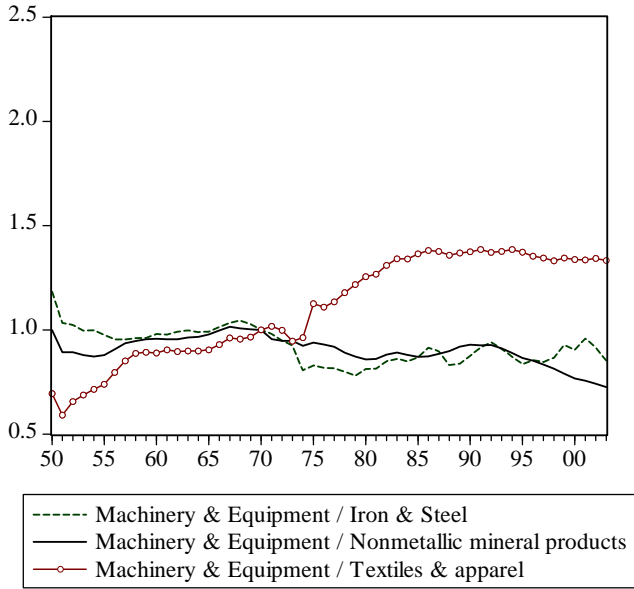

b) Average annual growth rates

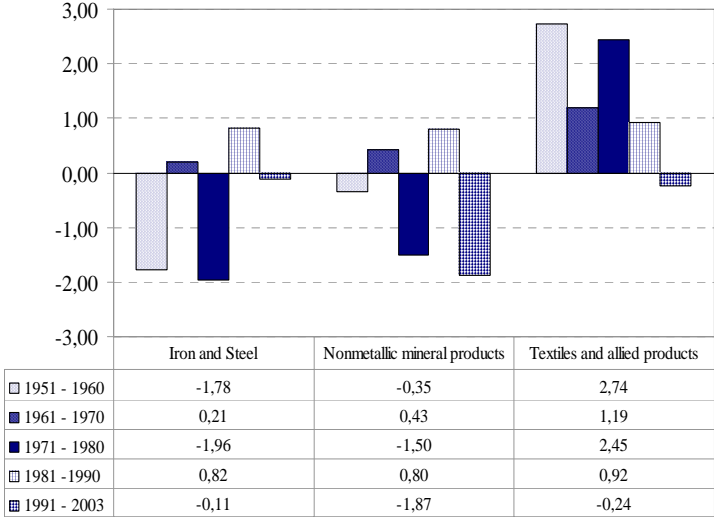

Source: US Department of Labor.

Fig. 7: The price development of Motor Vehicles relative to the prices of low-skilled goods

a) Development in time

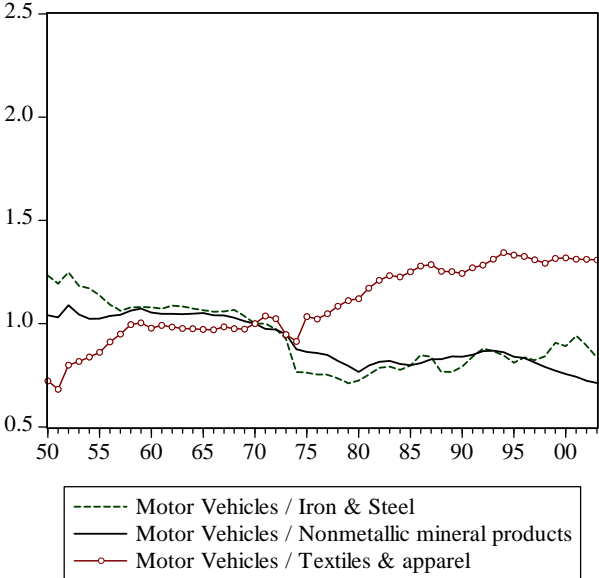

b) Average annual growth rates

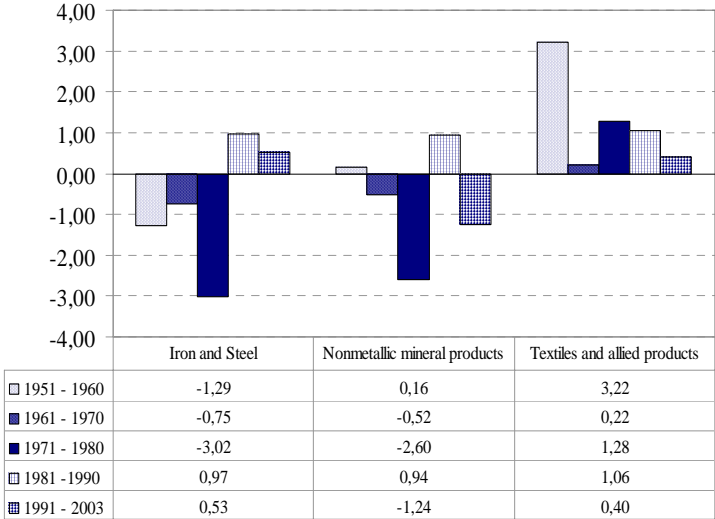

Source: US Department of Labor.

After having shown the mixed pattern of the main empirical regularities for selective relative prices of skill-intensive goods we now turn to the theoretical groundings. Based on the conceptual results of Findlay, Grubert (1959) and Krugman (2000) we derive the movement of the relative price of skill-intensive goods due to identical and ubiquitous skill-biased technological change and the countervailing effect of increasing world-wide supply of low-skilled-labor within a Heckscher-Ohlin framework.

3 Theoretical foundations

3.1 The Lerner-Diagram for three goods

We analyse the different effects of changes in technology and in factor endowment by applying the concept of the *Lerner-Diagram*.¹⁰ A 3x2x2 Heckscher-Ohlin Model (three goods, two factors, two countries) is used throughout the paper. The two factors of production are skilled-labor (S) and unskilled-labor (U). They are assumed to be mobile within a country but not across countries. The respective factor prices are w^s (wage rate of skilled-labor) and w^u (wage rate of unskilled-labor).

Figure 8 comprises of three unit-value isoquants (UVI) for the production of the three goods X , Y and Z , referring to X as the most, Y as the medium and Z as the least skill-intensive good. The UVI for good X is defined by $p_x X = 1$, where p_x is the price of good X . Given p_x one can determine the amount of good X which has to be produced for reaching a unit value of one ($V_x = 1/p_x$).

¹⁰ The diagram was originally developed by Lerner (1952). For a good explanation see Deardorff (2002a, b) or the textbook of van Marrewijk (2002).

Fig. 8: The Lerner-Diagram with three goods and one cone of diversification

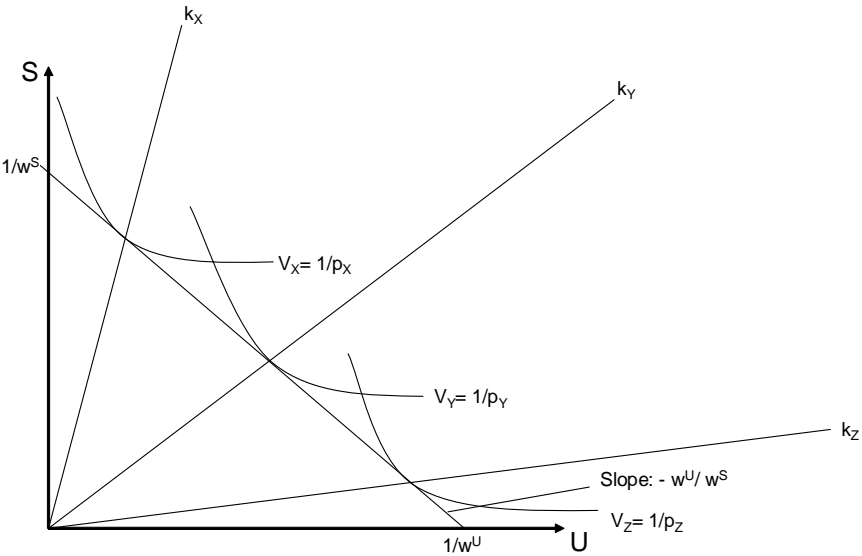

Source: Deardorff (2002a).

The common tangent to the unit-value isoquants $(\frac{y}{w^S} / \frac{y}{w^U})$ - the *unit-value isocost line* - indicates all input combinations (U, S) that give rise to a cost-level of one unit of measurement, taking the input prices as given ($w^S S + w^U U = 1$). Hence, its slope is the factor price ratio w^U / w^S prevailing in the economy. The tangent's intercepts define the inverse wages for skilled and unskilled-labor. In this specific case where all UVIs are tangent to the unit-value isocost line the production of all three goods is efficient with the optimal skilled/unskilled-labor ratios $k_i = S_i / U_i$, $i = X, Y, Z$.¹¹ The lowest and the highest ratio span the so called *cone of diversification*. Countries with factor endowments lying within this *cone* can diversify their production across all three goods hereby reaching identical factor-prices w^S and w^U .¹²

However, in a Lerner-Diagram it is also possible to depict the case of incomplete factor price equalization across countries. Having UVIs like in Figure 9 a single common tangent does not exist. This gives rise to two cones of diversification with different factor prices. Countries

¹¹ $k_x > k_y > k_z$ shows the order of all three goods concerning their skill-intensities.
¹² Full factor price equalization. Countries lying outside the cone can either produce only good X or good Z and will not have the same factor prices. See Deardorff (2002a), p. 3.

within the more (less) skill-intensive Cone 2 (1) can only produce good X and Y (goods Y and Z), i.e. prices do not permit free-trade production of all three goods in any one country.¹³ All countries lying within one cone can be considered as integrated economies, having identical good and factor prices and identical technologies.¹⁴ As Xu (2001) emphasizes, identical technological progress in this integrated economies as we will consider in Section 3.3, is equivalent to technological progress in a closed economy.¹⁵

Concerning demand we further assume homothetic and identical Cobb-Douglas preferences.

Fig. 9: The Lerner-Diagram with three goods and two cone of diversification

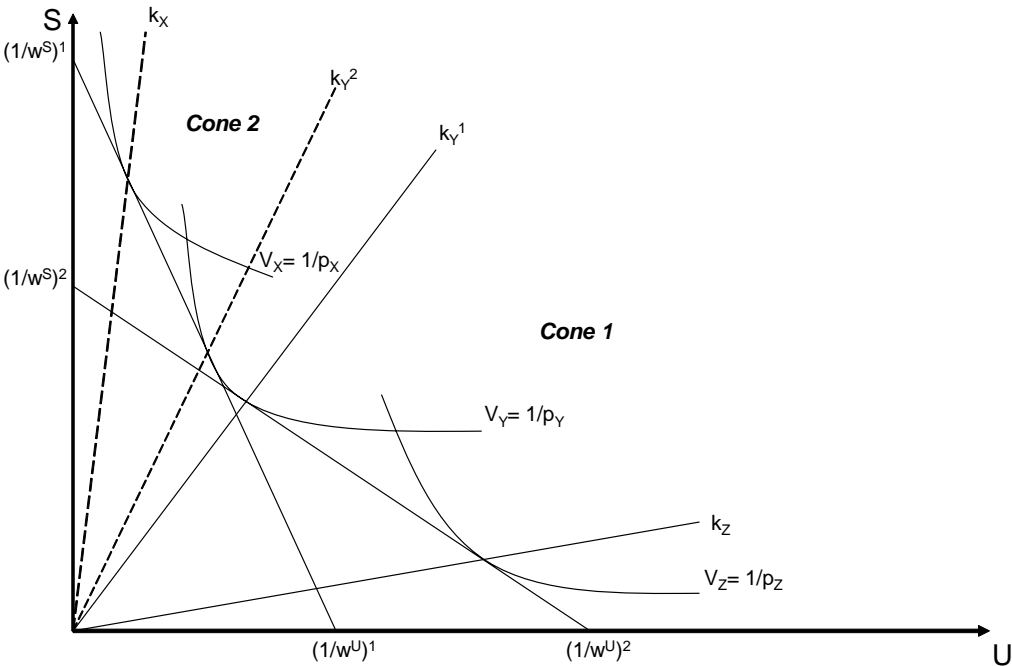

Source: Deardorff (2002a).

¹³ Deardorff (2002a), p. 3.
¹⁴ Identical technologies in producing the goods belonging to the specific cone.
¹⁵ Xu (2001), p. 16.

Within this concept of the *Lerner-Diagram for three goods and two cones of diversification* we will now analyze the effects on factor and good prices of (1) an *increasing in the world-wide supply of unskilled-labor*, (2) *skill-biased technological progress in the more unskilled-intensive sector* and (3) *skill-biased technological progress in the more skill-intensive sector*.

3.2 Effects of an increase in unskilled-labor supply on relative factor and product prices

A major vehicle of additional worldwide unskilled-labor supply has recently been the emergence of new information and Communication Technologies (ICT) which enabled transnational corporations to outsource parts of their value-chain to low-skilled-labor abundant countries such as India or China. A prominent example for this are call center activities.¹⁶

According to the Rybczynsky-Theorem an increase in the supply of unskilled-labor will cause the supply of the unskilled-labor intensive good Z to increase while the supply of the skill-intensive good X decreases.¹⁷ This fall of the relative supply of X to Z ($\Delta(Q_x / Q_z) < 0$) results in a rise of the relative price of X ($\Delta(p_x / p_z) > 0$). In the Lerner-Diagram one can depict this as a shift of V_z outward along the k_z -line.¹⁸

Concerning the medium-skilled good Y , we conclude that, as Y is more skill-intensive than Z but less than X , the relative supply of Y referring to Z will decrease ($\Delta(Q_y / Q_z) < 0$) while the relative supply of Y referring to X will increase ($\Delta(Q_x / Q_y) < 0$). For the relative prices this implies $\Delta(p_y / p_z) > 0$ and $\Delta(p_x / p_y) > 0$. The corresponding shifts of the UVIs are depicted in Figure 10.

¹⁶ See the debate between Samuelson (2004) and Bhagwati et al. (2004).

¹⁷ See Nunnenkamp et al. (1994), p. 121.

¹⁸ The shift is along the k_z -line because this price change has the same effect as Hicks-neutral technological regress which will be discussed below. See also Gundlach, Becker (2005), p. 7. Without loss of generality we choose to depict $\Delta(p_x / p_z) > 0$ in the Lerner-Diagram as being a fall in the price of Y $\Delta p_z < 0$ while holding p_x constant.

Fig. 10: Increase in world supply of unskilled-labor

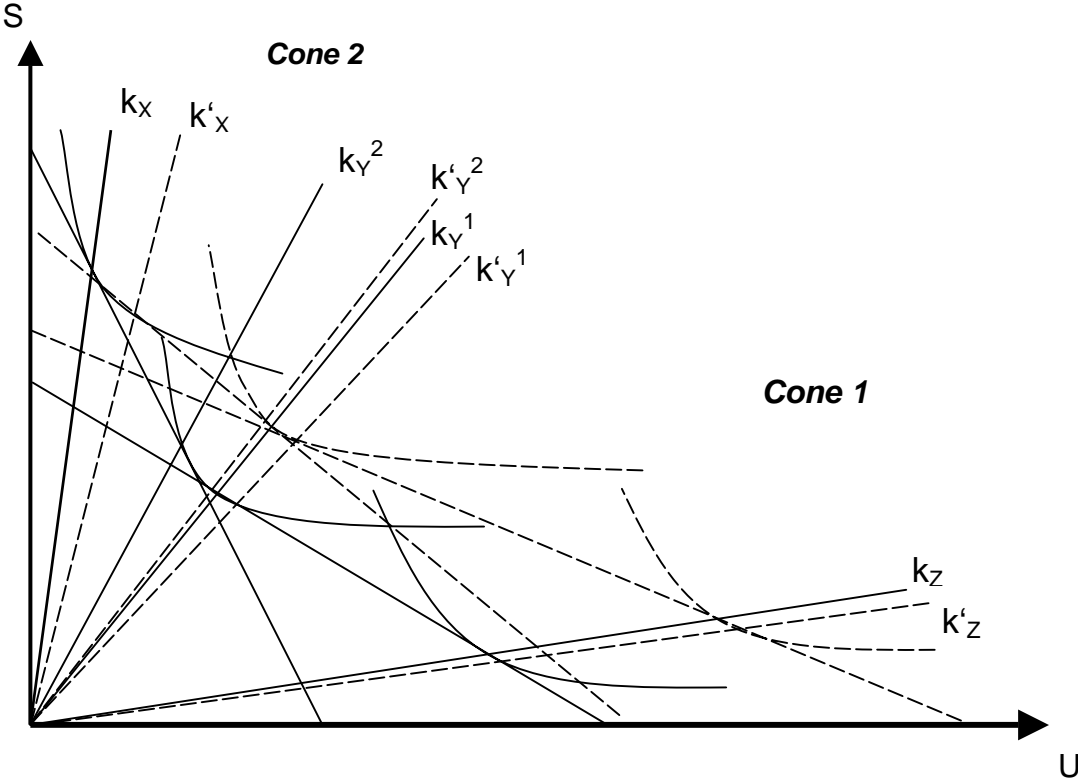

Source: Own work.

In the new equilibrium there are still two cones of diversification and hence no fully integrated world economy.¹⁹ Yet in both cones factor price lines turn anticlockwise indicating that both the relative and the absolute wage of unskilled-labor (skilled-labor) falls (rises). The main findings of this analysis are summarized in the first row of Table 3.

¹⁹ However, it is possible that some countries can either leave, switch or enter cones.

3.3 The effect of technological change on the relative factor and good prices

As there are three goods and two factors of production in the model nine different possibilities of technological change can occur: Hicks-neutral, skilled-labor-using and unskilled-labor-using technological change in sector X , Y or Z .²⁰ As it takes too long to describe all the different implications for factor and good prices of the nine types of technological change we limit our considerations. According to Krugman (2000) there has been an enormous *skill-using bias* in the technological progress of recent history.²¹ We will first look at the effects of this specific technical progress on relative good and factor prices when it occurs in the relatively more unskilled-labor intensive sector. This will clarify the methodology in our analysis. After that we scrutinize skill-biased technological change in the most skill-intensive sector, which is slightly more complex.

Moreover, we first concentrate on countries lying in the more skill-intensive cone of diversification (Cone 2) which we consider to be the cone of the industrialized world. The skill-using technical progress is assumed to be identical and ubiquitous in all these countries and hence can be treated like technological progress in a closed economy as already mentioned above. After that will show the implications for countries in the other cone (Cone 1).

3.3.1 Skilled-labor-using technological change in the more labor-intensive sector

According to Xu (2001) one always has to consider two effects in order to elaborate the change in relative factor prices caused by technological progress: a *direct* and an *indirect effect*. The former is described as the effect on relative factor prices holding relative product prices constant while the latter works through the changes of relative supplies on relative

²⁰ We refer to the classification by Hicks (1932) which distinguishes the technological change according to its factor-*using*-bias. I.e. skill-biased in this paper means skill-using (also called unskilled-saving) and unskilled-biased means unskilled-using (also called skill-saving). For the difference between the factor-*using* concept and the factor-*augmenting* concept of technological change see Xu (2001).

²¹ See Krugman (2000), p. 52.

good prices and further via Stolper-Samuelson-Theorem on relative factor prices. The following analysis is based on Findlay, Grubert (1959) and Krugman (2000).

Skill-using technological progress in sector Y moves V_Y inwards in the way depicted in Figure 11 (V_Y^1 to V_Y^2).²² By drawing the new common tangent $\overline{(1/w^s)^2(1/w^u)^2}$ to the UVIs we get the effect on relative factor prices holding the product price ratio constant (*direct effect*). As the new tangent is steeper the factor price ratio rises from $(w^u / w^s)^1$ to $(w^u / w^s)^2$. In addition, the skill-intensities of production of both goods rise (k_X^1 to k_X^2 ; k_Y^1 to k_Y^2).²³

In order to elaborate the *indirect effect* on w^u / w^s we now have to scrutinize how technological progress affects the relative commodity supplies. For this purpose an Edgeworth-Box will be applied (see Figure 12). Hereby the initial skill-intensity lines of good X and good Y intersect at the equilibrium point A . As stated above the skill-intensities in both sectors rise at constant product price ratio leading to point B . In point B the relative supply of X has fallen both because of a lower absolute supply of X ($\Delta Q_X < 0$) and a higher absolute supply of Y ($\Delta Q_Y > 0$). As we do not consider a small open-economy, terms of trade *are* affected by changes in relative supplies. In Figure 13 the intersection of the relative supply (RS) and the relative demand curve (RD) is shown by point A indicating again the initial equilibrium in our closed economy. The result of the decrease in relative supply of X holding relative product prices constant is represented by RS^2 . Having unchanged preferences (and no inferior goods) the relative product price has to rise in order to restore the equilibrium leading to point C , where the relative price has risen and the relative quantity has fallen compared to A .

²² According to the Hicks-Classification of neutral technological change a skill-bias is indicated by a rising skill-intensity at a constant factor price ratio. This effect can be seen in the Lerner-Diagram of Figure 11 since the tangency point of V_Y^2 and the parallel to $\overline{(1/w^s)^1(1/w^u)^1}$ (indicating a constant factor price ratio) being to the left of the initial skill-intensity line k_Y^1 .

²³ Hereby, the skill-intensity rises in sector Y even further than with constant relative factor prices. For a detailed analysis of the direct effect of technological change in a Lerner-Diagram see Findlay, Grubert (1959).

Fig. 11: Two good Lerner-Diagram with skill-using (labor-saving) technological progress in the labor-intensive sector Y

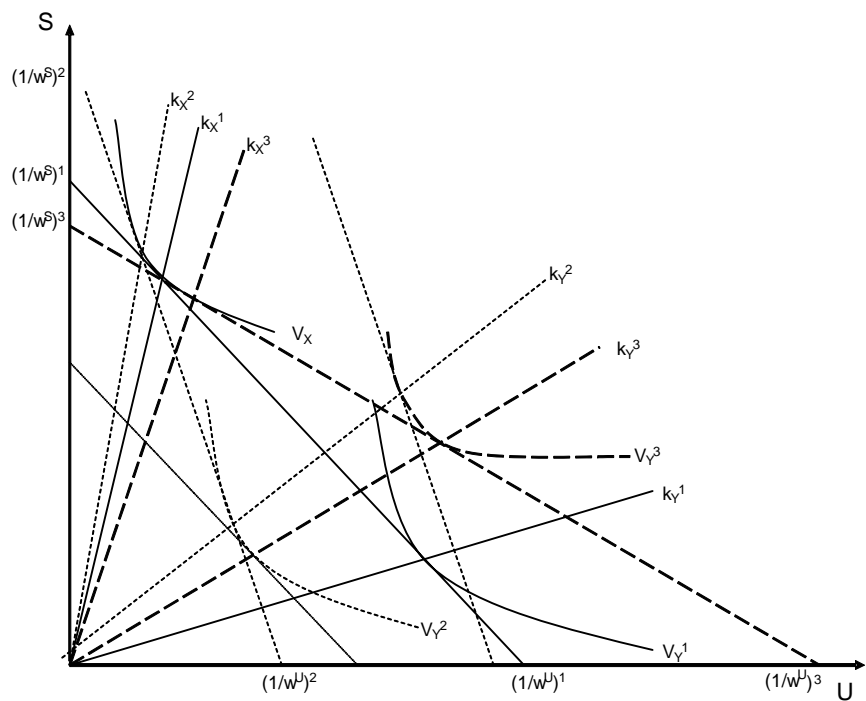

Source: Findlay, Grubert (1959), own work.

Fig. 12: Edgeworth-Box with skill-using technological progress in Y

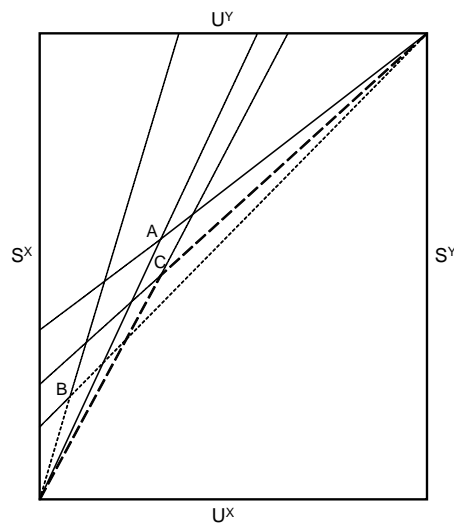

Source: Findlay, Grubert (1959), own work

Fig. 13: Effects on relative prices of skill-using technological progress in Y

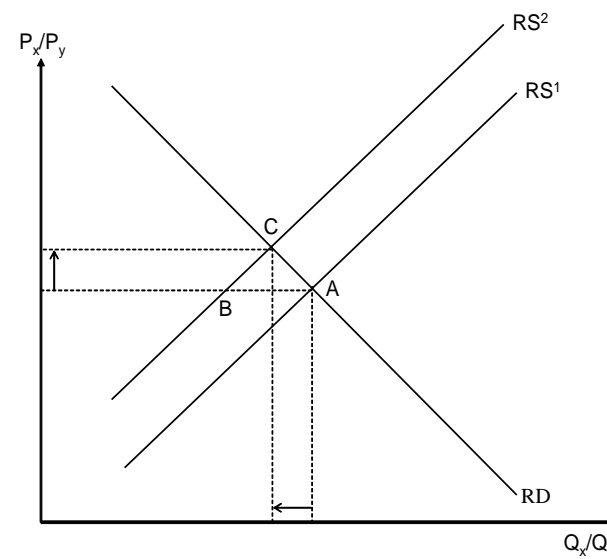

Source: Own work.

To solve for the effect on relative factor prices one has to return to the Lerner-diagram in Figure 11. A rise in relative product prices ($\Delta(P_X / P_Y) > 0$) signifies that the UVI of Y has to shift outwards in comparison to the UVI of X .²⁴ The new UVI is V_Y^3 . The new common tangent to V_X and V_Y^3 ($\overline{(1/w^s)^3(1/w^u)^3}$) shows that compared to the initial situation ($\overline{(1/w^s)^1(1/w^u)^1}$) and to the constant product price situation ($\overline{(1/w^s)^2(1/w^u)^2}$) the relative factor price has fallen (*direct and indirect effect taken together*).²⁵ We can also see that the skill-intensity in X decreases (k_X^3) while it increases in Y (k_Y^3) compared to the initial situation (k_X^1 and k_Y^1). Reconsidering these movements of k_X and k_Y in the Edgeworth-Box, we end up in point C with a decreased relative quantity of X .

Note that this example indicates that it is not always the sector-bias that matters as Krugman (2000) demonstrates intuitively and Xu (2001) shows formally. In this case of identical and ubiquitous technical progress in sector Y , unskilled-labor loses although it is the factor used relative intensively in its production.²⁶ Now we analyse what happens when this very technical progress occurs in the more skill-intensive sector X .

3.3.2 Skilled-labor-using technological change in the more skill-intensive sector

Figure 14 depicts skill-using technological progress in sector X shifting the initial UVI V_X^1 to V_X^2 .²⁷ Drawing the common tangent to V_X^2 and V_Y describes the changes in relative wages (*direct effect at constant product prices*) and in the skill-intensities of sector X and Y . A decrease of all three can be observed. The new values are $\overline{(1/w^s)^2(1/w^u)^2}$, k_X^2 and k_Y^2 .

²⁴ As in section 3.2, $\Delta(P_X / P_Y) > 0$ is depicted in the diagram as holding P_X constant while P_Y falls. A decrease in the product price corresponds to Hicks-neutral technological regress in the Lerner-Diagram and so the UVI of Y shifts outwards along the k_Y^2 -line (see the parallel line to $\overline{(1/w^s)^2(1/w^u)^2}$).

²⁵ For a formal prove see Xu (2001).

²⁶ This contrast to Leamer (1998) who states that only the sector bias matters. Yet, he referred to local technological progress within a small closed economy, i.e. with no effects on relative good prices.

²⁷ Again the skill-bias is indicated by having a higher skill-intensity at the initial relative factor price (see the parallel to the unit-value isocost line).

Yet, in such a case where the technological change is biased to the factor which is relative intensively used in the sector where it occurs, another possible impact on the skill-intensity of the progressing sector arises: if the reduction of total costs is not large enough it might as well happen that k_x rises compared to the initial situation (see k_x^2 in Figure 17).²⁸ We refer to this latter possibilities as a *STP (small technological progress)* whereas we call the former *LTP (large technological progress)*. However the *direct effect*, i.e. the effect on relative factor prices holding relative good prices constant is always negative.

With respect to the *indirect effect* we first consider the impact of LTC on relative supply holding the good price ratio constant (Figure 15). Starting in point *A* in the Edgeworth-Box the reduction in the two skill-intensities of both sectors leads to point *B* holding relative good prices constant. Hereby, the relative supply of the skill-intensive good *X* has increased compared to the initial situation. This is shown by moving the relative supply curve in Figure 16 to the right (RS^1 to RS^2). In order to reach the new equilibrium point *C* relative good prices have to fall and the relative quantity of *X* has to increase. Turning back to the Lerner-Diagram (Figure 14) the reduction in the relative good price of *X* leads to an outward shift of the UVI of sector *X*.²⁹ The final UVI of *X* (V_x^3) lies between its original position (V_x^1) and the constant product price location (V_x^2). The new unit-value isocost curve with slope $(w^U / w^S)^3$ demonstrates that relative factor prices decreased compared to the initial situation $(w^U / w^S)^1$. In addition, the final skill-intensities k_x^3 and k_y^3 are lower than the original ones (but not as small as in the case of constant product prices). Drawing these new skill-intensities in the Edgeworth-Box the new point *C* is characterized by an increase in the relative quantity of *X*. Con-

²⁸ However, it is still smaller than with identical relative factor prices (\tilde{k}_x^1).

²⁹ Again, this movement corresponds to a Hicks-neutral technological regress.

cluding this case of LTP, it has to be stated that there is no difference in the effects of sector and factor bias of technological change.

Now we turn to the case of Small Technical Progress (STP). As already mentioned above a fall in the wage ratio (*direct effect*) and the skill-intensity of sector Y (k_Y) as well as a rising skill-intensity in sector X can be observed (Figure 17). In the Edgeworth-Box in Figure 18 different possibilities arise for the location of point B (the point of constant product price ratio). As Findlay, Grubert (1959) ascertain the skilled/unskilled ratio in sector Y is the higher the higher it is in sector X.³⁰ However, the skill-intensity of X is limited by $\tilde{k}_X^1 > k_X^2 > k_X^1$ with \tilde{k}_X^1 being the skill-intensity at constant factor price ratio. If k_X^2 is close to \tilde{k}_X^1 then k_Y^2 is close to k_Y^1 . This border case is indicated by B^2 . With k_X^2 approaching to its initial level we get a smaller k_Y^2 . This is illustrated by point B^1 . Looking at the two border cases we conclude that an exact reaction of the relative quantity of good X (Q_X / Q_Y) cannot be determined. It could rise as in B^1 or fall as in B^2 . The respective product price reactions are depicted in Figure 19 and Figure 22.

If the *relative product price falls*, as indicated by the new equilibrium point C^1 in Figure 19, nearly the same effects as with LTP prevail in the Lerner-Diagram: With a decreasing product price ratio, the UVI of X shifts Hicks-neutrally back outwards (V_X^2 to V_X^3). The result is a lower relative wage ($(w^U / w^S)^3$) as well as a lower skill-intensity in sector Y (k_Y^3) compared to the initial equilibrium. The only difference lies in the increasing skill-intensity of sector X (k_X^3). Point C^1 in the Edgeworth-Box (Figure 18) represents such an equilibrium.

³⁰ See Findlay, Grubert (1959), p. 119. This can easily be seen by drawing several positions for the UVI.

Fig. 14: Two good Lerner-Diagram with large skill-using technological progress in the skill-intensive sector X

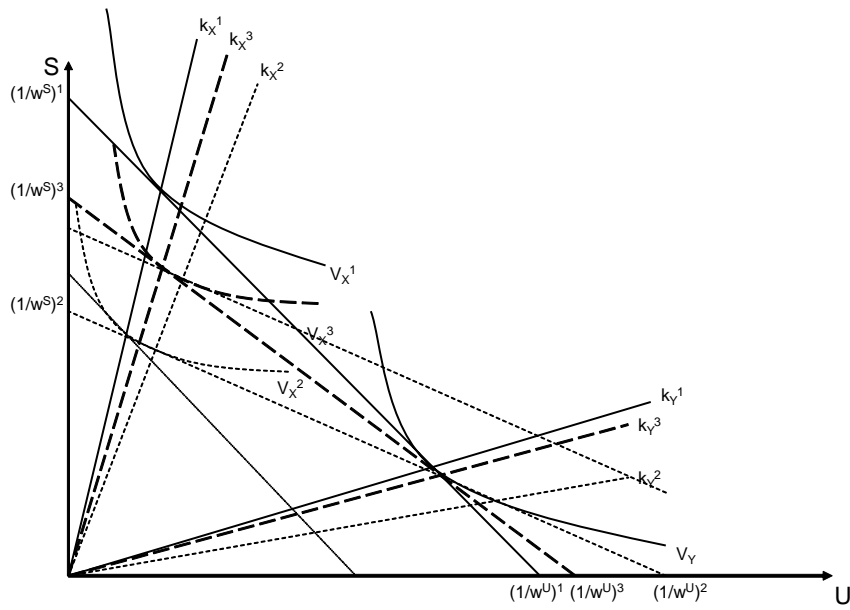

Source: Findlay, Grubert (1959), own work.

Fig. 15: Edgeworth-Box with large skill-using technological progress in X

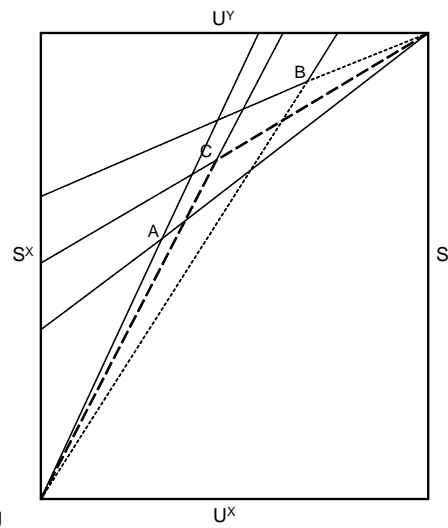

Source: Findlay, Grubert (1959), own work

Fig. 16: Effects on relative prices of large skill-using technological progress in X

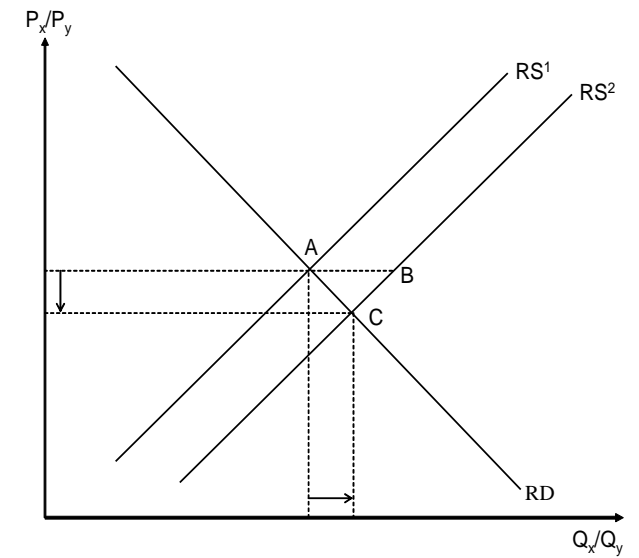

Source: Own work.

Fig. 17: Two good Lerner-Diagram with small skill-using technological progress in the skill-intensive sector X – Fall in the relative price of X

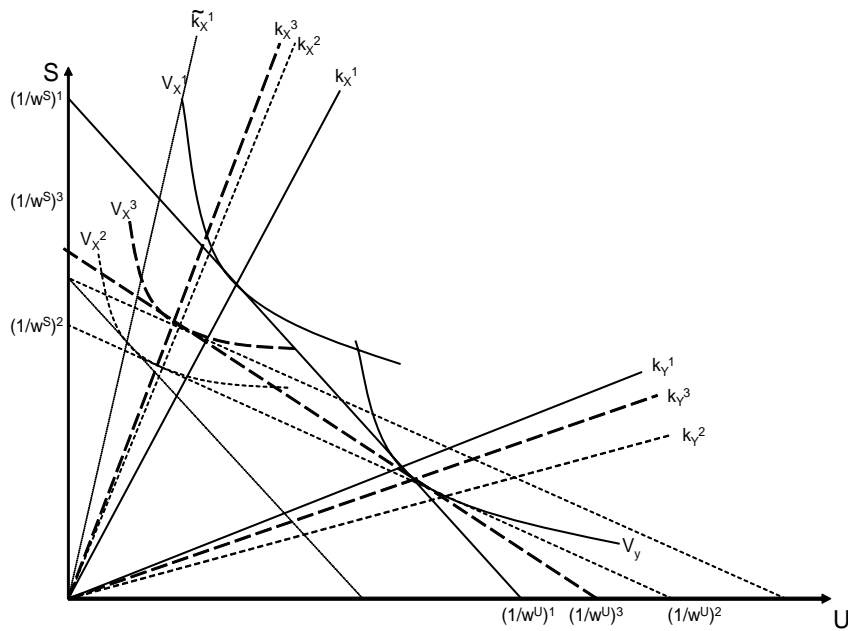

Source: Findlay, Grubert (1959), own work.

Fig. 18: Edgeworth-Box with small skill-using technological progress in X – Fall in the relative price of X

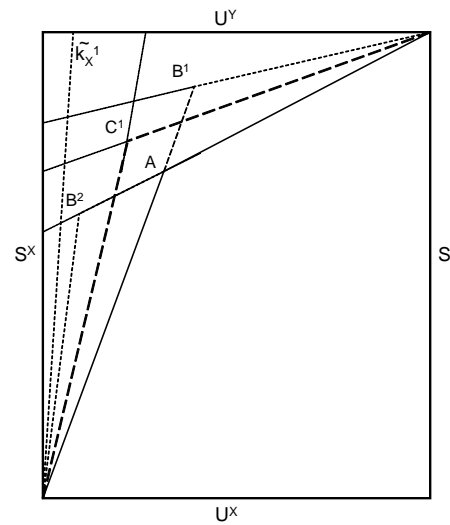

Source: Findlay, Grubert (1959), own work.

Fig. 19: Effects on relative prices of small skill-using technological progress in sector X – Fall in the relative price of X

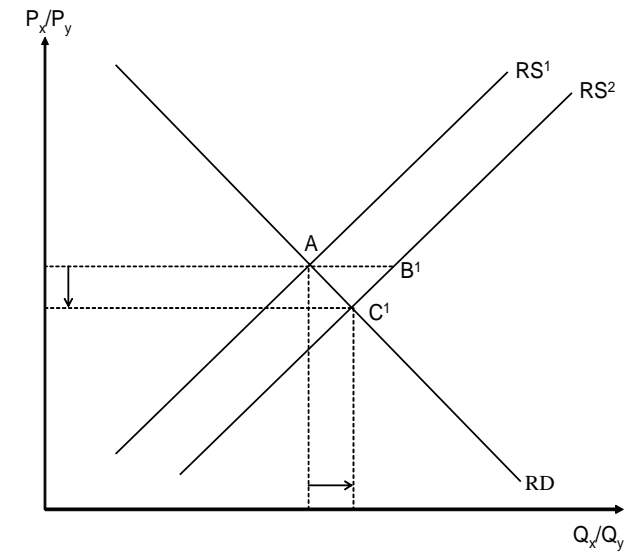

Source: Own work.

Fig. 20: Two good Lerner-Diagram with small skill-using technological progress in the skill-intensive sector X – Increase in the relative price of X

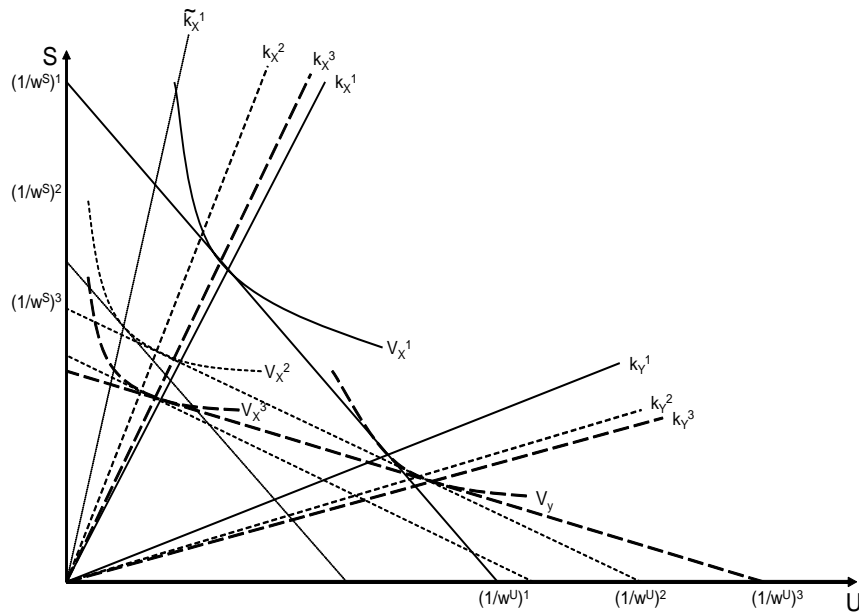

Source: Findlay, Grubert (1959), own work.

Fig. 21: Edgeworth-Box with small skill-using technological progress in X – Increase in the relative price of X

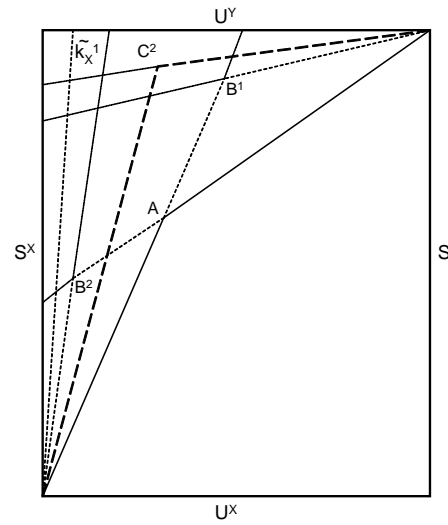

Source: Findlay, Grubert (1959), own work.

Fig. 22: Effects on relative prices of small skill-using technological progress in sector X – Increase in the relative price of X

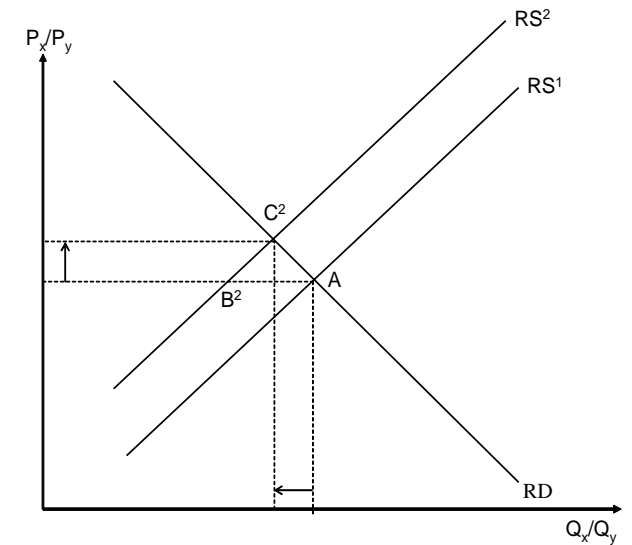

Source: Own work.

Considering the case for a *rising relative product price* (C^2 in Figure 22), one can observe a inward shift of the UVI of good X in the Lerner-Diagram (V_x^2 to V_x^3 in Figure 20) which is even more pronounced than under constant product prices. This implies that the *indirect effect* of technological progress amplifies the *direct effect* in this specific case: relative factor prices drop further than before. The same holds for k_y . Summarizing, an increase in k_x and a fall in both k_y and the wage ratio compared to the initial situation can be observed.

3.3.3 Implications for the second cone

The skilled-labor-using technological change in the *most high-skill-intensive sector* explained above is now transferred to the Lerner-Diagram with two cones and three goods.³¹ As Gundlach, Becker (2005) state, a skill-using technological case implies that the UVI of X shifts inwards and slightly to the left and we get the direct effect on relative wages as discussed above.³²

Concerning the indirect effect, however, it has to be taken into account that some of the additional income will induce a higher demand for good Z which is only produced in the more unskilled-labor abundant countries (Cone 1). Thus, the implications of skilled-labor-using technological change for the skill-intensive cone (Cone 2) are the same as described before but the movements of the relative quantities, factor and product prices are less pronounced than before. Still, the size of the inward shift of V_x is dependent on the sum of the direct and the indirect effect, i.e. whether the latter is additional to the direct effect or opposite.

We turn now to the implications of the additional demand for good Z which is induced in Cone 1. In fact, it is partly met by both an increasing relative supply of Z ($\Delta(Q_y / Q_z) < 0$) and an increasing relative price of the same good ($\Delta(P_y / P_z) < 0$). However, as quantity ef-

³¹ See Figure 9.

³² See also Gundlach, Becker (2005), p. 8-9.

ffects cannot be shown in the Lerner-Diagram the only change in Cone 1 result from the increase in the relative price of good Z. So V_Z shifts inwards in a Hicks-neutral way and consequently the relative wage increases within the very cone.³³

To finish our theoretical analyses of the two cone case, we have to look at the effects of skilled-labor-using technological change in the *more unskilled-labor-intensive sector* Y. As in the reasoning above we conclude that all changes in Cone 2 are less pronounced than discussed in section 3.3.1 because again a part of the additional income will induce a higher demand for good Z in Cone 1. The results of an increasing relative supply of Z, an increasing relative price of Z and an increase in relative wage also follows in this case.

Before we turn to the interpretation of the empirical development of the relative prices of skill-intensive goods, Table 3 gives an overview of our main theoretical findings concerning the increase in the unskilled-labor supply and the skill-biased technological progress.

Tab. 3: Main theoretical findings: Increase in unskilled-labor supply and skill-biased technological progress

	P_X/P_Z	P_X/P_Y	P_Y/P_Z	$\frac{w^U}{w^S}$
U ↑	↑	↑	↑	↓
TP in Y	↓	↑	↓	↑ (Cone 1) and ↓ (Cone 2)
LTP in X	↓	↓	↓	↑ (Cone 1) and ↓ (Cone 2)
STP in X	↑↓	↑↓	↓	↑ (Cone 1) and ↓ (Cone 2)

Source: Own work.

³³ Gundlach, Becker (2005) point out in particular that technological change leads to less factor-price diversification across cones.

4 Interpretation of Empirical Observations

The patterns of change in relative price presented in Section 2 reveal a heterogeneous picture of relative price development. Based on our previous theoretical considerations, we now can give some qualitative reasoning for this changing pattern.

The *drugs & pharmaceuticals* sector shows a clear U-shaped behaviour for all detected relative price time-series. Skilled-labor using LTP was the most dominant factor causing the dramatic downswing in relative price during the first three decades of our analysis (50-70s). The assumption of LTP occurring can be supported by the fact that this respective industry was still emerging and dynamic in this period.³⁴ The following change in the direction of relative price dynamic up from the early 80s is due to three cumulative effects. The first effect refers to weakened effect of skill-labor using LTP. With a growing maturity of the industry a continuous decline in the rate of technical progress takes place as evolutionary instead of revolutionary technological changes becomes prevalent. Hence, the following two decades are increasingly characterized by the STP assumption under which c.p. the relative price is pushed upwards. On the contrary, the other two factors refer to the specific characteristics of the sectors with which the *drugs & pharmaceuticals* sector is compared against.

The worldwide increase in unskilled-labor supply in the last decades and skill-labor using technological progress in the low-skilled-intensive sector forces the relative prices of skilled-intensive goods upwards. The extent depends on both the intensity with which low-skilled-labor is used in the production process and the dynamic of technological progress in the low-skilled intensive sector.³⁵ Hence, differences between the strength of relative price change

³⁴A more striking example for the link between LTP and industry life cycle is the development of the *Electronic Computers & Computer Equipment* industry in recent years. Its huge increase in labor productivity (25.5 % p.a. 1988 to 2003; output per hour) was accompanied by a tremendous fall in absolute prices (80 percent price fall between 1991 and 2003).

³⁵For theory see Section 2.3.1. In fact, since the late 80s the increase in labor productivity has been remarkably higher in the textiles & apparel sector than in the drugs & pharmaceutical sector.

when comparing *drugs & pharmaceuticals* with several other lower-skilled can be explained by these factors.

By looking at the *chemicals* and *industrial chemicals* sector, we get a confirmation that a shift from LTP to STP in the *drugs & pharmaceuticals* sector within the last five decades occurred. Both chemicals sectors are characterized by a decline in relative prices from 1950 to 1973 which is lower than the corresponding decline in the *drugs & pharmaceuticals* sector. When comparing the relative price development of the two chemicals sectors with the *drugs & pharmaceuticals* sector, we can neglect the two effects which affects lower-skilled-intensive goods.³⁶ Hence, we can c.p. deduce a smaller technological progress in the chemicals sector for this time period. If this difference prevails in the subsequent decades we would rather expect the relative price of *drugs & pharmaceuticals* to be constant over time while the relative price of chemicals is expected to raise as the countervailing effect of technological progress to the increased supply of unskilled-labor is far less pronounced. Yet, we observe a stronger raise in relative price of *drugs & pharmaceuticals*. This can only be explained by a reversion in the relative size of skill-using technological progress between the two sectors. A shift from LTP to STP in the *drugs & pharmaceuticals* sector which pushes the rate of technological progress below that of the chemicals sector must be the consequence.

The interpretation of the observed pattern are based on the assumption that shocks are only temporary. The price dynamic of the chemical and industrial chemical sectors is highly depend on the price of the main primary input oil which directly accounts for a large share of industries added value. In this framework, an oil price shock acts as an Hicks-neutral technological regress. If this shock is permanent and input shares are constant we have got to take its effect into account when explaining the relative price of skill-intensive goods. Hence, an empirical analysis which estimates the strength of skill-using technological progress and increase

³⁶ Given the assumption of equal skill-intensity so that an increase in world-wide unskilled-labor has the same effects for both sectors.

in world-wide supply of unskilled-labor in explaining the observed patterns has crucially control for these exogenous shocks.

Referring to the medium-skill-intensive sectors, we can detect a lower range of changing relative goods prices indicating that the effects of skill-using technological progress and increased supply of unskilled-labor cancels out partially. Yet, the picture remains mixed. The analyzed medium-skill intensive sectors show constant or decreasing pattern concerning the relative price towards iron & steel and non-metallic mineral products. In contrast, the pattern in terms of textiles & apparel is constantly positively sloped over the last 50 years. This is due to the fact that this sector incorporates the two effects of a higher supply of unskilled-labor and skill-using technological progress in the low-skilled sector both leading to higher relative price of the medium-skilled good over time.

Drawing implications for the labor markets we can only identify effects - skill-biased technological progress in most skill-intensive sectors, skill-biased technical progress in low-skilled sector and increasing world wide supply with unskilled-labor - which have a common *negative* influence on the relative wage of unskilled- to skilled-labor. This could even imply a trend decline in the real wage and the employment opportunities of low-skilled workers in developed economies.

However, keep in mind that this conclusion, i.e. it is only the factor bias that matters, is drawn on our theoretical and empirical assumption of the Integrated World Economy Model. When rather looking both at a small open economy without influence on relative product prices and at the case of non-identical global technological progress it may also be the sector bias that matters.³⁷ Furthermore, different wage implications might also arise when relaxing the assumption of Cobb-Douglas and homothetic demand.

³⁷ See Xu (2001) for the distinction between the Small Open Economy, Integrated World Economy and the Large Open Economy.

5 Conclusion

In this paper we investigated the changes of relative prices of skill-intensive goods. By qualitative reasoning we show that changing relative prices of skill-intensive goods can be inferred from the interaction of an increase in world-wide unskilled-labor supply, skill-biased technological progress in the unskilled-labor intensive sector and skill-biased technological progress in the skilled-labor intensive sector. Hence, this work provides a basis for a formal econometric analysis of observed patterns of sectoral price developments.

To refine and confirm our results, future research should apply a more disaggregated producer price data set of industry sectors, which is however only available for a much shorter time-period. Our selection of industries is still too aggregated to reliably account for the high degree of intrasectoral heterogeneity of skill-intensities.

The long-term observation of relative product prices had the advantage of detecting the importance large- versus small technological progress. For future research, it can also be interesting to explore the interaction between a sectoral industry life-cycle to its productivity dynamic and subsequently to its impact on the change of relative price of skill intensive goods. In this context, changing demand preferences over time as well as the varying intensity of industry competition have to be taken into account.

References

Bhagwati, J., Panagariya, A., Srinivasan, T. N. (2004), The Muddles over Outsourcing, *Journal of Economic Perspectives*, Vol. 18, No. 4, pp. 93–114.

Deardorff, A. V. (2002a), *Introduction to Two-Cone HO Equilibrium*, University of Michigan, <http://www-personal.umich.edu/~alandear/courses/441/handouts/Two%20Cones.pdf>, mimeo.

Deardorff, A. V. (2002b), *Introduction to the Lerner Diagram*, University of Michigan, <http://www-personal.umich.edu/~alandear/courses/441/handouts/Lerner.pdf>, mimeo.

Findlay, R., Grubert, H. (1959), Factor Intensities, Technical Progress, and the Terms of Trade, *Oxford Economic Papers*, Vol. 11, No. 1, pp. 111-121.

Gundlach, E., Becker, D. (2005), *Notes on Factor Price Equality and Biased Technological Change in a Two-Cone Trade Model*, Paper to be presented at DEGIT X in Mexico City, June 3-4, 2005.

Hicks, J. R. (1932), *The Theory of Wages*, London, Macmillan.

Krugman, P. R. (2000), Technology, Trade and Factor Prices, *Journal of International Economics*, Vol. 50, pp. 51-71.

Leamer, E. E. (1998), In Search of Stolper-Samuelson linkages between International Trade and Lower Wages, in: Collins, S. (eds.), *Imports, Exports and the American Worker*, Washington, Brookings, pp. 141-202.

Lerner, A. P. (1952), Factor Prices and International Trade, *Economica*, Vol. 19, No. 73, pp. 1-15.

Nunnenkamp, P., Gundlach, E., Agarwal, J. P. (1994), *Globalisation of Production and Markets - Kieler Studien 262*, Tübingen, J.C.B. Mohr.

Samuelson, P. (2004), Where Ricardo and Mill Rebut and Confirm Arguments of Mainstream Economists Supporting Globalization, *Journal of Economic Perspectives*, Vol. 18, No. 3, pp. 135-146.

UNCTAD (1996), *Trade and Development Report*, UN, Geneva, No. 159.

van Marrewijk, C. (2002), *International Trade and the World Economy*, Oxford, Oxford University Press.

Xu, B. (2001), Factor bias, sector bias, and the effects of technical progress on relative factor prices, *Journal of International Economics*, Vol. 54, pp. 5-25.

Contact information of the authors

CHRISTIAN GÄCKLE

Advanced Studies Program
Institut für Weltwirtschaft Kiel
Düsternbrooker Weg 148
24105 Kiel

E-Mail: gaeckle@asp.ifw-kiel.de

INGMAR SCHUSTEREDER

Lehrstuhl für Wirtschaftspolitik u. Internationale Politische Ökonomie
European Business School Oestrich-Winkel &
Advanced Studies Program
Institut für Weltwirtschaft Kiel
Düsternbrooker Weg 148
24105 Kiel

E-Mail: schustereder@asp.ifw-kiel.de

PATRICIA WAEGER

Advanced Studies Program
Institut für Weltwirtschaft Kiel
Düsternbrooker Weg 148
24105 Kiel

E-Mail: waeger@asp.ifw-kiel.de