

Buch, Claudia M.

Working Paper

Cross-Border Banking and Transmission Mechanisms: The Case of Europe

Kiel Working Paper, No. 1063

Provided in Cooperation with:

Kiel Institute for the World Economy – Leibniz Center for Research on Global Economic Challenges

Suggested Citation: Buch, Claudia M. (2001) : Cross-Border Banking and Transmission Mechanisms: The Case of Europe, Kiel Working Paper, No. 1063, Kiel Institute of World Economics (IfW), Kiel

This Version is available at:

<https://hdl.handle.net/10419/17896>

Standard-Nutzungsbedingungen:

Die Dokumente auf EconStor dürfen zu eigenen wissenschaftlichen Zwecken und zum Privatgebrauch gespeichert und kopiert werden.

Sie dürfen die Dokumente nicht für öffentliche oder kommerzielle Zwecke vervielfältigen, öffentlich ausstellen, öffentlich zugänglich machen, vertreiben oder anderweitig nutzen.

Sofern die Verfasser die Dokumente unter Open-Content-Lizenzen (insbesondere CC-Lizenzen) zur Verfügung gestellt haben sollten, gelten abweichend von diesen Nutzungsbedingungen die in der dort genannten Lizenz gewährten Nutzungsrechte.

Terms of use:

Documents in EconStor may be saved and copied for your personal and scholarly purposes.

You are not to copy documents for public or commercial purposes, to exhibit the documents publicly, to make them publicly available on the internet, or to distribute or otherwise use the documents in public.

If the documents have been made available under an Open Content Licence (especially Creative Commons Licences), you may exercise further usage rights as specified in the indicated licence.

Kiel Institute of World Economics
Duesternbrooker Weg 120
24105 Kiel (Germany)

Kiel Working Paper No. 1063

**Cross-Border Banking and Transmission
Mechanisms:
The Case of Europe**

by

Claudia M. Buch

July 2001

The responsibility for the contents of the working papers rests with the author, not the Institute. Since working papers are of a preliminary nature, it may be useful to contact the author of a particular working paper about results or caveats before referring to, or quoting, a paper. Any comments on working papers should be sent directly to the author.

Abstract

International activities of commercial banks are a potential source for the transmission of shocks across countries. In Europe, bank finance plays a relatively important role, and efforts have been made at creating a level playing field for financial institutions. This paper reviews the stylized facts of the integration of European banking markets and the changing nature of cross-border banking. Although the openness of financial systems has increased, bilateral financial linkages among EU countries remain relatively small. The exception are claims of German banks on a number of smaller countries, and we use these data for an analysis of the determinants of cross-border lending patterns.

Keywords: cross-border banking, European integration, transmission of shocks

JEL classification: F36, F42, G15

Dr. Claudia M. Buch
Kiel Institute of World Economics
24100 Kiel, Germany
Telephone: +49-431-8814-332
Fax: +49-431-8814-525
E-mail: cbuch@ifw.uni-kiel.de

1 Motivation*

Western Europe is among the financially most integrated regions world-wide. The Second Banking Directive has promoted an expansion in the cross-border activities of commercial banks (Buch 2000), the degree of capital mobility in the EU member states as such has increased (Lemmen 1998, Stirboeck and Heinemann 1999), and the euro is commonly believed to have further raised the degree of financial integration in Euroland (Danthine et al. 2000). Fratzscher (2001), shows that there has been a statistically significant increase in stock market linkages which can be linked to the introduction of the euro. Also, interbank money markets have witnessed a substantial integration boom after the introduction of the euro (BIS 2001).

As regards the degree of integration in banking markets, opinions diverge. While some authors conclude that a substantial degree of integration has been achieved already (Calcagnini et al. 2000) others, such as Berger et al. (2000b), are decidedly more skeptical and argue that there are substantial barriers to the full integration of markets. Anecdotal evidence on changes in the international lending activities of commercial banks shows a relatively minor effect of the euro.¹

Increased financial market linkages can be beneficial for a number of reasons. Benefits of financial sector integration comprise improved possibilities for portfolio diversification and thus improved interregional risk sharing, increased efficiency of the domestic financial system, and the possibility to finance domestic investment through foreign savings. Increased financial integration, however, can also raise the risk of financial sector contagion and thus of spill-overs or the propagation of financial crises elsewhere.

The costs and benefits of financial integration in Europe can therefore have important implications for a number of policy areas. If, for instance, instabilities of regional banking systems have potentially large effects on Euro-wide financial systems, a greater co-ordination and co-operation of banking supervising might be required. Also, the conduct and the effectiveness of monetary policy depends on the speed with which local liquidity shocks are transmitted inter-

* This paper has been written during a research visit at the National Bureau of Economic Research (NBER), Cambridge MA. The hospitality of the NBER and financial support from the Volkswagen Foundation are gratefully acknowledged. I would like to thank Joerg Doepke, John Driscoll, and Hubert Strauss for most helpful discussions and comments on an earlier draft. Remaining errors and inaccuracies are solely in my own responsibility.

¹ The international banking statistics of the Bank for International Settlements (BIS 2001) report information about the claims among the BIS reporting countries for the first time for the second quarter of 1999. Between this time and the end the third quarter of 2000, total claims of the reporting countries on the members of Euroland had increased by about one percent. Eight smaller reporting countries even reported a decline in (gross) Euroland assets.

regionally. Hence, obtaining more detailed information on the degree of market integration is crucial for economic policy.

Following recent international financial crises, there has been an upsurge in papers dealing with the causes and the measurement of spill-over effects of financial crises.² One of the results of this literature is that international activities of banks are playing an important role in the transmission of financial impulses across countries. It is not merely a coincidence that many of the theoretical models explaining currency crises borrow heavily from models which explain (contagious) bank runs. It is understood that the fact that banks link different national financial markets through their cross-border asset and liability holdings might contribute to spill over effects.

The focus of this paper is on transmission channels through international bank lending in Europe. We draw on a framework presented by Allen and Gale (2000b) who have argued that there is a non-linear relationship between the degree of financial integration and the transmission of shocks across countries. Trivially, there are no spill-overs of regional financial crises if financial markets are completely isolated. As banking systems become increasingly integrated but are not yet fully interlinked, liquidity shocks in one area might spill over into nearby regions and cause bank runs abroad. At a high degree of integration, however, bilateral linkages become relatively small, and the risk of contagion declines again.

In order to gauge the empirical relevance of these effects, this paper provides an assessment of the process of financial market integration that we have observed in Europe so far, focusing in particular on the impact of the integration process on intra-EU banking sector linkages. One result of the analysis is that, generally, international financial asset holdings of EU countries are heavily concentrated in other member states. While we do not perform a formal test of the possible 'EU bias' that this portfolio structure implies, the stylized facts imply that geographical proximity plays an important role for international asset choices, a finding which is supported by recent empirical evidence (Buch 2001, Portes and Rey 1999, Portes et al. 2001, Wei and Wu 2001).

Although this dominance of intra-EU asset holdings creates the potential for spill-over effects within the region, bilateral financial linkages yet remain small in comparison to national financial markets as a whole. More specifically, data on the regional structure of international banking assets suggest that bilateral lending relationships between EU countries are small relative to total domestic credit. The notable exception are claims of German banks on a number of smaller EU countries.

² See De Bandt and Hartmann (2000) for a comprehensive review of this literature.

In a second step, we therefore analyze credit relationships between Germany and these smaller EU countries (Austria, Denmark, Finland, Ireland). Our particular aim is to show whether domestic or foreign factors are affecting German banks' credit expansion abroad. If foreign (German) factors were found to dominate, their exposure to German banks might indeed create (negative) spill-over effects for the smaller EU economies. We do indeed find some evidence for the hypothesis that German shocks are transmitted through the international lending activities of commercial banks, and that these transmission effects affect credit conditions in the host economies to some extent.

This paper complements the existing empirical literature on financial integration in Europe, which has so far focused mainly on the linkages of national stock markets. Chelley-Steeley and Steeley (1999) find that equity markets in Europe have become more integrated after the abolition of exchange controls. Other tests of market integration use banking data to detect increased co-movements of interest rates within Europe (see, e.g., Artis and Zhang 1998, Centeno and Mello 1999, Holmes and Pentecost 1999). One general finding of this literature is that interest rate linkages in Europe have become stronger over time but that retail banking markets are less integrated than wholesale markets. Yet, since interest parity tests focus on markets for short-term financial assets only, they are not informative with regard to the integration of other market segments.

The role of banks in linking national financial markets and in transmitting shocks has also been addressed in different contexts recently. Evidence is available not only for emerging markets (Van Rijckeghem and Weder 2000) but also for mature market economies. For the United States, Peek and Rosengren (1997, 2000) show that domestic shocks to the Japanese economy have been transmitted through the international activities of Japanese banks. An interesting issue is thus to what extent the increased integration of banking markets in Europe, which is revealed by interest parity tests, affects the spill-overs through international bank lending. To the best of our knowledge, no previous evidence is available for Europe.³

The paper has five main parts. In the following second section, we present the model of Allen and Gale (2000b), which shows that portfolio diversification can have the positive effect of allowing a greater regional diversification of risk but that, at the same time, financial shocks might be contagious in incompletely integrated financial markets. In contrast to Allen and Gale (2000b), we also discuss the implications of regions which differ in size. This adds the possibility that liquidity shocks which occur in a relatively large region can cause bank runs else-

³ There are a few contributions which deal with regionally disaggregated banking data. However, none of these addresses the aspect of the transmission of shocks through banks' balance sheets. Monticelli (1996), for instance, uses information about cross-border holdings of monetary aggregates to estimate money demand functions. MacKay and Molyneux (1998) analyze correlations between regional bank lending and regional economic conditions.

where even if banks in the large region are not experiencing a crisis. Section three presents some stylized facts on financial market linkages in Europe, covering the structure of international asset holdings of the EU members countries, measures of banking sector openness, and the correlation of liquidity shocks. Section four provides new empirical evidence on the determinants of cross-border asset holdings, trying in particular to isolate domestic and foreign factors and showing potential channels of transmission. The focus of our empirical analysis is on banking sector linkages, mainly for two reasons. First, the creation of a Single Market for banking services has been one of the main goals of EU deregulation policy. Hence, one could expect that cross-border banking has benefited from the Single Market program to a relatively large extent. Second, statistics on bilateral cross-border asset holdings are more readily available for banking assets than in particular for portfolio investments. Part five concludes.

2 Financial Transmission Mechanisms and Banking

Although a host of papers has dealt with the spill-over effects of banking crises and the resulting systemic risks, few of these studies take explicit account of the regional structure of banks' assets and liabilities.⁴ Traditionally, and to a large extent guided by data availability, propagation or transmission effects have been studied empirically by using stock market data.⁵ However, there is an increasing amount of evidence suggesting that international asset choices of banks play an important role in the propagation of shocks (Peek and Rosengren 1997, 2000, Van Rijckeghem and Weder 2000).

This strand of the literature has been motivated by the observation that, just as portfolio diversification potentially provides substantial benefits, increased financial linkages might also lead to spill-over effects and hereby increase countries' exposure to external financial shocks. Work on these issues has typically focused on developing countries. Yet, because of the substantial financial linkages between developed market economies,⁶ evidence from these countries might be even more instructive with regard to the possible effects of financial integration. In this section, we are therefore presenting a simple framework of financial integration of developed countries: we consider regions which are similar size and state of development, and

⁴ De Bandt and Hartmann (2000) provide a comprehensive survey of the literature on systemic risks.

⁵ For evidence from Europe see Favero and Bonfiglioli (2000), Chelley-Steeley et al. (1998), or Chelley-Steeley and Steeley (1999).

⁶ Table 4 shows that EU countries hold the bulk of foreign assets in other countries in the region.

the main motive for holding international assets is the aim to diversify regional (liquidity) shocks.

2.1 Regional Risk, Diversification, and Contagion

The theoretical literature explaining the role of banks in the propagation of financial crises in developing countries has focused mostly on exchange rate effects for the net worth of banks: If banks' liabilities are denominated in foreign currency and if banks hold an open foreign exchange position, a devaluation would negatively affect their net worth, which may lead to lower capital inflows and thus speed up or even trigger a currency crisis (Aghion et al. 2000, Buch and Heinrich 1999, Cespedes et al. 2000).

Since the focus of the present paper is on the spill-over effects within a currency union such as Euroland, we will abstract from exchange rate changes but rather focus on the interaction between the degree of regional diversification of banks' portfolios and regional financial shocks. To show this, we use a recent model by Allen and Gale (2000b) which addresses the question how (regional) liquidity shocks can trigger bank runs and how these runs spread into other regions. The main message of their model is that international portfolio choices allow banks to better diversify risks but, at the same time, also expose them to the spill-over of foreign shocks.

2.1.1 *The Standard Model of Financial Contagion*

Allen and Gale (2000b) consider a model with four regions (A, B, C, D), each being home to one bank. Banks have the option to invest into short- and long-term domestic loans. They do not grant loans to non-bank customers abroad, but there is a network of interregional interbank assets and liabilities since each bank can hold interbank deposits abroad.

Regions are populated by identical consumers, each endowed with one unit of a consumption good in $t = 0$. Consumers can deposit their endowments with one of the regional banks which, in turn, can hold (interbank) bank deposits with all or only some of the other regional banks. Banks can also invest into short-term domestic assets, which yield a return $r < 1$ in $t = 1$ or into a long-term domestic asset which yields $R > 1$ in $t = 2$ or r if liquidated prematurely in period one.

Different assumptions are made concerning the degree of integration of regional financial markets. Essentially, the issue is whether there are bilateral financial linkages between all regions or whether some regions are isolated financially from others. Three cases need to be distinguished (Graph 1): Financial markets are completely integrated if all bilateral linkages exist (Case 1). However, due to transaction and information costs, some regional financial markets

may not be connected at all. This may lead to an incomplete financial integration (Case 2) in which all markets are linked, albeit only indirectly in some cases, or a disconnected market structure in which markets create clusters of integration but these regional clusters are not interlinked (Case 3). Before discussing how these different scenarios impact upon the transmission of financial shocks across regions, assumptions about the liquidity preferences of consumers in the four regions need to be made.

Ex ante, all consumers are identical but their liquidity needs may differ according to the state of nature S which is revealed after investment decisions have been made. With probability w ($1 - w$), they are early (late) consumers. In addition, liquidity needs can be high (w_H) or low (w_L). Agents have complete information about their environment. There are no asymmetries in information, and all investment decisions — including the allocation of interbank deposits — must be made before the actual state of nature is revealed.

Two scenarios are distinguished concerning the distribution of liquidity shocks (Table 1). In scenario one, states S_1 and S_2 can be realized only. Liquidity shocks in regions A and C (B and D) are perfectly positively correlated, but are perfectly negatively correlated with those in regions B and D (A and C). However, there is no aggregated shortage of liquidity (the probability of state \bar{S} is zero). The first best allocation of financial resources would thus be to invest into short-term and long-term assets as well as interbank loans and to “swap” liquidity from regions with low liquidity needs towards those with high liquidity needs in $t = 1$ (and vice versa in $t = 2$). Allen and Gale (2000b) show that this first-best allocation of resources can be achieved through interbank deposit holdings. This holds even if financial integration is incomplete.⁷ Financial integration obviously has positive welfare implications because it allows banks and consumers to insure themselves against regional shocks.

The result that a first-best allocation of regional risk can be achieved through an interbank banking market breaks down, however, in a second scenario. In this case, state \bar{S} may occur in which region A might be hit by an excess liquidity shock which puts its liquidity need slightly above the average liquidity need $g = \frac{w_H + w_L}{2}$. In this case, banks in region A may have to liquidate part of their long-term assets in order to meet their depositors’ liquidity needs in $t = 1$. If the excess liquidity shock is large relative to the liquidity buffer of short-term assets in region A , late consumers might be better off by trying to liquidate their deposits in period one, and a bank run in region A may ensue.⁸ The question is to what extent this liquidity shock spills over into other regions.

⁷ Inter-regional risk-sharing would not be possible if only perfectly correlated regions were financial integrated but disconnected from the others.

⁸ Technically speaking, if all depositors try to liquidate in $t = 1$, the bank has insufficient assets to guarantee full repayment. This corresponds to the bank run scenario of Diamond and

Trivially, in the case of financial autarky, the excess liquidity shock affects region A only. A similar result would obtain in the case of disconnected financial markets (Case 3) as a liquidity shock would be contained in a certain region. In incompletely integrated but interconnected financial markets (Case 2), however, the shock first spills over into region D . If also in this region the spill-over effect is large relative to the banks' short-term assets, a bank run would occur as well, and this effect would feed its way through all the remaining regional markets. Hence, under these assumptions (the shock being large relative to the liquidity buffers in regions A and D), it can be shown that a non-zero probability of state \bar{S} would result in a complete contagion of financial shocks. In completely integrated financial markets (Case 1), there is a smaller likelihood of financial contagion because the initial excess liquidity shock is distributed over more regions, and each region is hit by a relatively small shock only.

Hence, there is a non-monotonic relationship between financial integration and the probability of contagion: As regions move from complete financial isolation to greater but yet incomplete integration, the risk of financial contagion increases. It decreases again as markets tend towards full integration because greater integration implies a greater insurance against regional liquidity shocks. As in standard portfolio models, the benefits of diversification increase as the number of regions held in the portfolio of banks increases and/or correlations between liquidity shocks differ among regions.

2.1.2 Implications and Extensions

Despite the simplicity of its assumptions, the model by Allen and Gale (2000b) has a number of interesting implications:

First, although financial markets have become more integrated world-wide, the process of financial integration and deregulation across Europe has been particularly rapid. As banks get easier access to an EU-wide interbank deposit market, this might reduce the probability of regional financial crisis and increase the probability that EU-wide buffers of excess liquidity shocks can be used, thus containing crises. At the same time, it might be argued that the European economies are relatively similar and do thus provide little diversification opportunities. This, however, is not supported by the data. In Section 3.4, we will provide some evidence on the cross-correlation patterns between changes in deposits across European banks which shows that correlations among European markets are not necessarily higher than, for instance, between Europe and the US.

Dybvig (1983). In the terminology of Allen and Gale (2000b), a bank is bankrupt in this case whereas it is insolvent if it can meet the demands of its depositors only if liquidating some of its long-term assets and solvent if it can meet the liquidity demands in $t = 1$ by drawing on its own short-term assets and interbank deposits only.

Second, the fact that there are non-linearities with regard to the contagion effects of financial crises implies that there might be a region where countries decide to refrain from further liberalizing capital flows. This may be the case if the short-term costs of financial contagion exceed the long-term benefits through increased inter-regional risk sharing. After all, there is ample evidence that financial integration is a gradual process and that information costs (and thus learning) are playing an important role. The question is thus whether policymakers can push the degree of financial integration beyond the point in which financial integration increases rather than decreases the likelihood that financial crisis have negative spill-over effects. Also, it could be asked which policy instruments can be used to mitigate the negative effects of incomplete financial integration.

Third, although the model above has assumed that the four regions are of equal size, it has also been stressed that the exposure to a relatively large region matters. Take Case 2 as an example and assume that region *A* is significantly larger than region *D*. In this case, the second condition for a regional banking crises to become contagious (i.e. the liquidity shock spilling over from region *A* into region *D* is sufficiently large) is more likely to be met.

To see the impact of differences in size, it needs to be assumed that all asset choices are made simultaneously and prior to the revelation of the liquidity shock. Hence, the bank located in region *A* deposits some of its fund in an interbank deposit in region *D*. Bank *D*, in turn, will invest its deposits (including the interbank deposits from bank *A*) into short- and long-term assets. As the excess liquidity shock hits region *A*, bank *A* first runs down its own short-term assets, then the interbank deposits in region *D*. Doing so, it might be able to pay out all early consumers. Hence, it might stay solvent. If bank *A*'s deposits in bank *D* are relatively large, the buffer stock of bank *D* might be too small though. A bank run in region *D* might ensue.

The question is whether it is rational for all agents to allocate assets in such a way in the first place. Bank *A* certainly has an incentive because it can shield itself from going bankrupt. Bank *D* has to take the deposits if regions are integrated and if there are no capital controls. In a fully integrated market, it could itself hold deposits in another large region, *C*. Thereby, it would avoid running into liquidity problems. However, if markets *D* and *C* are incompletely integrated, this option is not available. In this case, liquidity problems in a large country could indeed cause banking failures in smaller countries even though banks in the large country would remain solvent. Notice that this argument goes through only if interbank deposits from region *A* are identical to interbank deposits from all other regions. If the excess liquidity shock in region *A* would show up in a risk premium (i.e. lower deposit rates or a conversion restriction iff bank in one of the other regions would go bankrupt otherwise), banks in region *D* might shield itself from the negative spill-over effect.

While Allen and Gale (2000b) are concerned with liquidity risk, Freixas et al. (2000) use a related approach to focus on the spill-over of solvency shocks through interbank markets. They

show that, generally, in the presence of interbank financial linkages, banks hold less liquid assets since they are (partly) insured against solvency shocks. Interbank linkages thus have the positive effect that they increase the resilience of a banking system to cushion solvency shocks. The costs of increased interbank linkages is, at the same time, that insolvent banks might stay in business because they can draw on interbank credit lines. Hence, a potential role for the central bank to close insolvent banks emerges.

One potential shortcoming of all of these models is that they assume the correlation of shocks, which determines the benefits from diversification, to be independent from the degree of financial market integration. Rather, in these models, the degree of integration of the real economy (in terms of return correlations) affects the degree of integration of the financial sector. Recent empirical evidence, however, suggests that the direction of causality might just be the reverse. Kalemli-Ozcan et al. (2000) argue that the degree to which the financial system is conducive to risk-sharing among regions affects the degree of industrial specialization. Their empirical results support a positive correlation between the degree of financial integration among regions (or countries) and the degree of specialization in industrial production. On average, risk sharing is substantially higher among regions within countries than among groups of countries. The difference in terms of industrial specialization is not quite as pronounced but still significant. This is essentially the same pattern underlying the model by Allen and Gale (2000b), as low return correlations would likewise be observed in financially integrated markets (absent regulatory barriers to integration): banks would have incentives to share risks interregionally if return correlations are low. Kalemli-Ozcan et al. (2000), however, show that the direction of causality is running from financial market integration to industrial specialization.

2.2 Contagion versus Propagation

The discussion so far has not been very specific with regard to the proper definition of contagion or spill-over effects, which has been subject to some debate in the literature. Some authors associate the concept of contagion merely with the simultaneous emergence of financial crises. Others distinguish between spill-overs which are unrelated to fundamentals and those which reflect fundamental characteristics of an economy.

Forbes and Rigobon (2000a, 2000b) have additionally pointed out that it might be useful to distinguish between propagation and contagion. Hereby, propagation denotes normal market linkages through, for instance, high correlations of returns, while contagion implies a change in the pattern of return correlations during a crises. According to this fairly strict definition, contagion would thus occur only if a significant *increase* in cross-market linkages after a shock to one country occurs can be observed. In this strict sense, the model of Allen and Gale (2000b) would thus not address contagion effects because linkages do not increase during crises.

Obviously, the policy implications of these different definitions differ substantially. If observed co-movements of markets during crises simply reflected normal co-movements, policy action might be counterproductive because it might disrupt normal market linkages which raise overall economic welfare. If, in contrast, contagion is a synonym for crisis *and* if crises have long-run negative effects, both short-term and long-term policy measures may be needed. For all practical purposes, it will be extremely difficult to decide whether spill-overs of crises elsewhere which affect the domestic economy should be taken as a mere by-product of economic integration and might thus be tolerated. Essentially, economic policy must then weigh the risks against the benefits of integration.

As regards the empirical implementation of the narrow definition of contagion, two practical problems must be solved.

First, normal market linkages must be defined. Take the degree of capital market integration as an example. A number of different methods for measuring the degree of integration ranging from price to quantity measures and addressing different market segments have been discussed in the literature.⁹ Some of these methods, such as portfolio tests, take the correlation between rates of returns as given and use these to assess the degree of integration. If, however, return correlations increase during crises episodes, these tests cannot be applied anymore. Hence, while it would be useful to have a much broader definition of market than correlation coefficients only linkages (and their possible change during crises), measuring changes in these linkages during crises is difficult.

⁹ See Buch and Pierdzioch (2001) for a survey

Second, Forbes and Rigobon (2000a, 2000b) show that the measurement of correlation coefficients must take into account that these estimates are biased upwards during crises periods. Without correction for this bias, an increase in correlations would be diagnosed too frequently. Forbes and Rigobon thus propose to adjust the correlation coefficient according to the following formula: $\mathbf{r}_t = \frac{\mathbf{r}_t^c}{\sqrt{1 + \mathbf{d}_t [1 - (\mathbf{r}_t^c)^2]}}$ where \mathbf{r}_t^c is the unconditional, unadjusted correlation coefficient and \mathbf{d}_t is the relative increase in the variance of returns in the crisis country.

Using this method, Forbes and Rigobon (2000a) find no significant increase in return correlations during recent financial crises in Latin America. Linne (1999) uses the same methodology and distinguishes between positive contagion (an increase in return correlations) and negative contagion (declining correlations). Evidence for positive and negative contagion differs between crisis episodes. While the Czech crisis of 1997 had little positive contagion effects and some negative effects, mainly in Eastern Europe, the Asian financial crisis of the summer of 1997 had relatively strong and positive global contagion but hardly any negative contagion effects. The Russian crisis of August 1998, to the contrary, showed no features of negative contagion but some positive contagion effects in Eastern Europe and Latin America. Applying the same methodology to longer-term time series, Bordo and Murshid (2000) reach similar conclusions and argue that there is little evidence that recent financial crises have been more contagious than historically observed ones.

Rigobon (2000) additionally proposes to use the fact that the covariance matrix of returns changes during crises episodes to identify propagation mechanisms and to solve a fundamental identification problem. He suggests a method which utilizes heteroskedasticity in the data as an additional identifying assumption. This method has been challenged by Favero and Giavazzi (2000) who argue that, without estimating structural equations, there might be incidences when the null of contagion could be rejected even though it might be true. Instead, the authors estimate a structural VAR of EU interest rates, capturing crises episodes through dummy variables. Contagion is defined as a situation when the structural parameters of the model are unable to explain transmission channels. Applying this method to EU interest rate data, they find that contagion effects have been present among European countries, a possible exception being France.

3 Financial Market Linkages in Europe: Stylized Facts

The model presented in the previous section suggests that the degree of integration of financial systems into international capital flows as well as the diversification of international asset holdings have implications for the way and the intensity with which financial shocks spread

among countries. In this section, we present some stylized facts on European capital markets which capture these factors.

While the deregulation of financial markets and the abolition of capital controls have shaped the evolution of global financial markets as such, progress on these fronts has been particularly rapid within Europe. Not only are the EU member countries geographically and culturally relatively close, which should lower information costs between markets. Direct regulatory barriers to the free flow of capital among these countries have also been abolished fully.¹⁰ This could be expected to have increased the degree of capital mobility, particularly *among* the EU countries.

Yet, the empirical evidence on the degree of interregional capital mobility within Europe is scarce, mainly because of the paucity of information on regional balance of payments data and bilateral asset holdings. Hence, most studies which look at the changing patterns on capital mobility over time are using aggregated time series which do not allow a breakdown of bilateral capital flows between the EU countries (Armstrong et al. 1996, Bayoumi et al. 1999, Lemmen 1998, Stirboeck and Heinemann 1999).

Some evidence is available, however, concerning the degree of capital mobility on a national level, which tends to exceed the degree of international capital mobility (Bayoumi et al. 1999, Kellermann and Schlag 1999). A corollary of this finding would be that the degree of intra-European capital mobility would lie somewhere in between. Whether and by how much this has changed over time, however, is difficult to assess without having information about bilateral capital flows.

In this section, we present several pieces of information which allow us to address the question to what extent the openness of financial systems in Europe and intra-regional capital flows have changed over the past decades. We begin by presenting evidence on the openness of Europe's banking systems. Second, we analyze the structure of international asset holdings of the EU member countries, and we show the importance of bilateral financial linkages among banks, and of cross-border payments flows. Since evidence on changes in the regional composition of international asset holdings over time has not been available for a large set of countries, we complement this analysis by data on the structure of German international capital flows. Incidentally, since Germany is both one of the largest investors within Europe and the largest recipient of funds, this also provides us with information about the possible changes in interregional capital flows in Europe as a whole. Finally, we analyze the correlations between liquidity stocks in Europe.

¹⁰ For a comprehensive survey of the deregulation of the financial services industry in Europe and the implementation of the various steps in each country see Bakker (1994) and EU (1997).

3.1 Banking Sector Openness

The openness of a banking system matters for a number of reasons. One aspect of the risks and benefits of openness have already been discussed above: more open financial systems might be exposed to the spill-over of financial shocks in other regions. At the same time, openness might help to cushion regional shocks. In addition, openness provides benefits because it is related to the degree to which the domestic banking system is exposed to competitive pressure from abroad. Reduced market power and increased efficiency are the channels through which these benefits materialize. However, there has also been an intense debate in the theoretical literature on the potentially adverse effects of increased competition on the monitoring incentives and thus the riskiness of banks (Allen and Gale 2000a, Aizenman 1998, Gehrig 1993).

In this section, we provide different measures capturing banking sector openness, noting that increased competitive pressure might be exerted directly through the physical presence of foreign banks on the domestic market or indirectly through increased capital flows. We present data on the structure of cross-border banking offices, the importance of banks' foreign assets and liabilities, and the market shares of foreign banks. We conclude with a short summary of the empirical evidence on changes in the profitability of the European banking industry.

Table 2 gives an overview of the prudential regulations that affect the activities of foreign financial institutions in Europe in an international comparison. In Europe, there are no restrictions to the market entry of foreign banks, indicating a slightly more liberal regime in comparison to high income countries on average and in particular to less developed countries. EU countries as well as developed countries in general also have a lower share of entry applications being denied in comparison to lower income countries.

At the same time, however, the actual share of foreign ownership is below the average for developed countries, and substantially below the values observed for lower income markets. Despite the substantial deregulation of cross-border banking that has taken place over the past decades, the direct presence of foreign banks (branches plus subsidiaries) on domestic markets remains modest for most EU countries (ECB 1999). As Graph 2 shows, the market shares of foreign banks have been flat and fairly low in most EU countries during the 1990s, and have even declined slightly in some countries. The notable exceptions are Luxembourg, the United Kingdom and in particular Ireland, where the market share of foreign banks has increased from about 10 percent in the early 1990s to more than 60 percent towards the end of the decade. However, in the majority of the EU countries, including the Austria, Finland, Germany, Italy, Netherlands, or Sweden, foreign banks hold less than 10 percent of total banking sector assets, which is substantially less than the average for developed countries (about 25 percent, see Table 2).

One reason for this dichotomy, i.e. openness for foreign entry and the low market shares of foreign banks, could be the fact that mergers and acquisitions (M&As) are one important channel through which entry in the banking sector occurs. So far, however, M&As in Europe have taken place mainly on a national level. Between 1985 and 2000, 84 percent of all cases involved domestic financial institutions only, as compared to 5 percent involving two European institutions, and 11 percent of international mergers (ECB 2000). Hence, domestic banking systems seem to have consolidated and strengthened first, thus reducing the profitability of entry.

The low frequency of bank mergers between (developed) EU countries and the limited entry of foreign banks is also a response to the limited success of entry. Empirical studies tend to show that international bank mergers have a relatively small probability of being successful and that foreign banks in developed countries tend to perform worse than their domestic counterparts (Berger et al. 2000a).

As regards the competitive threat that foreign banks pose to the domestic banking system, the specific form of overseas offices might be relevant. It has been argued that activities of foreign subsidiaries are focused on retail banking activities (and thus potentially pose a greater competitive threat to domestic banks) to a greater extent than those of foreign branches (Heinkel and Levi 1992). With only a few exceptions, the structure of foreign banking activities in EU countries is more heavily tilted towards branches rather than subsidiaries. However, it is not clear to what extent this actually reflects strategic choices of banks to penetrate certain market segments. Rather, regulatory changes at the EU-level are clearly behind this pattern: The Second Banking Directive of 1993 has eliminated the need to get a local banking charter for branches in a foreign country, has subjected foreign branches to home country supervision, and has abolished the need for foreign branches to hold a certain amount of endowment capital (EU 1997). Foreign banking activity has thus benefitted particularly.

In addition to direct competitive pressure through the presence of foreign banks on the domestic market, indirect pressure on domestic financial intermediaries comes through a greater integration into international capital flows. Graph 3 takes a more long-term perspective by looking at the evolution of gross and net foreign assets and liabilities of commercial banks since the late 1940s. Lacking consistent data on total assets of commercial banks during this period, we are using nominal GDP to scale the data. From these graphs, a number of interesting features emerge:

First, foreign activities of commercial banks have expanded rapidly after the end of the Bretton-Woods period and the subsequent abolition of capital controls in the early 1970s. Prior to this time, they hardly accounted for more than 5-10 percent of GDP. This is consistent with studies on long-term changes in the degree of capital mobility which find that the degree of inte-

gration of international capital markets has started to accelerate in the 1970s (Bordo et al. 1998, Taylor 1996).

Second, banking systems in Europe show divergent degrees of international openness. Broadly speaking, the countries fall into three groups: banks in highly financially open economies such as Ireland or the United Kingdom have foreign assets and liabilities which exceed GDP. The ratio of external assets for most countries is in the range of about 50 percent of GDP, this group comprising Austria, Denmark, France, Germany, the Netherlands, Portugal, and Sweden. Notwithstanding quite pronounced differences in developments over time, the group of countries which are less integrated into international capital flows and having gross foreign assets or liabilities of only 30 percent or less of GDP are Finland, Italy, and Spain.

Third, outward openness of banking systems seems to have accelerated after 1992 in a few countries such as Germany (which is partly also due to the reunification effect and the resulting increased imports of capital), Ireland, Portugal, or Spain. In others (France, Italy, Netherlands, Sweden), there has been an upward trend of this measure throughout while others (Austria, Finland, the United Kingdom) have even shown declining shares of banks' foreign assets and liabilities over GDP.

Fourth, net foreign asset positions are relatively small compared to gross positions. This is in line with earlier work looking at countries' international investment positions as a whole and is likely to reflect borrowing constraints that become effective if net positions are becoming large.¹¹

Perhaps one of the most interesting observations from Graph 3 is that the trend towards an increased outward openness of banking systems has continued and in some cases even accelerated in the 1990s, i.e. during a period when the disintermediation of financial services, and in particular the decline in the importance of commercial banks, has become an intensely debated issue.

Generally, changes in the ratio of banks' foreign assets and liabilities over GDP are driven by two factors, i.e. changes in the degree of openness of financial systems and changes in the importance of the banking system relative to GDP. In order to isolate these two effects, Graph 4 presents data on the importance of claims and liabilities towards non-residents relative to the balance sheet total of EU financial institutions in the 1990s. Two results are striking:

First, the importance of foreign assets and liabilities relative to their balance sheet total again varies quite substantially between the EU member countries. At the bottom end of the scale, banks in Italy or Spain have assets and liabilities vis-à-vis non residents of only 10 to 15

¹¹ See Kraay et al. (2000) or Lane and Milesi-Ferretti (2001).

percent of their balance sheet total. For the majority of the countries, this share is around 20–25 percent.

Second, changes in these ratios have been relatively modest for most countries during the 1990s, and there has been no consistent time trend across countries. To some extent, the increase in the ratio between foreign assets of the banking systems relative to GDP thus reflects the increase in the ratio of total banking system assets over GDP (Graph 4c).

Mainly, an increase in the openness of banking systems in Europe has thus occurred through increased capital flows rather than the market entry of foreign banks. The question is to what extent these changes have affected the profitability of the European banking industry. Correlations between the return on equity across European countries suggest that there remains a considerable degree of segmentation of banking markets. On average, the profitability of banks across EU countries (as measured by their return on equity) has been virtually uncorrelated in the past.¹² In integrated markets, we would expect a much closer link. Average return correlations for profits of banks across US regions, for instance, are substantially higher (0.44) (Berger and DeYoung 2001). A number of recent empirical studies has tried to isolate the effects that deregulation and increased integration has had for the competitive structure and profitability of the European banking industry more systematically.

Studying the situation prior to the implementation of the Second Banking Directive, Molyneux et al. (1994) find a lack of integration of European banking markets. They are using the so-called Panzar-Rosse-statistic (H) which calculates the responsiveness of banks' total revenues to changes in input prices. If banks operate in a highly concentrated banking sector under conditions of monopoly or perfect oligopolistic collusion, they respond to changes in input prices, and H would be zero or negative. In perfectly competitive markets, banks act as price takers, and H would be unity.

Using essentially the same methodological approach, Bikker and Groeneveld (2000) argue that the results of Molyneux et al. (1994) are relatively unstable because they do not take the gradual changes in competition that have occurred in European banking into account. Adjusting for this and using data for the years 1989 through 1996, Bikker and Groeneveld (2000) generally obtain more stable results and conclude that the Second Banking Directive has not increased the degree of competition in European banking. Rather, the degree of competition appears to have been rather fierce already prior to the creation of the Single Market.

Casu and Molyneux (2000) use a different empirical methodology by analyzing to what extent the performance of banks in Europe deviate from an estimated efficient frontier. Their results

¹² Using data on the correlation of the return on equity for European banks for the years 1979 through 1996 as provided by Berger et al. (2000a), we find an average correlation coefficient of 0.05.

are generally consistent with the other studies in that they find, if anything, improvements in the efficiency of banks in Europe following the Second Banking Directive which have been relatively minor. However, their finding that efficiency levels are relatively low overall and are, moreover, strongly influenced by country-specific factors is in contradiction to the conclusions of Bikker and Groeneveld (2000) that competition is and has been relatively intense throughout.

The importance of country-specific conditions is stressed also in Pastor et al. (2000). These authors are estimating a common frontier for banks from 10 European for the year 1993, taking into account factors such as regulatory or demographic factors unique to the individual country which might affect banking performance. One result is that differences in domestic conditions do indeed have a significant impact on relative banking performance. They distinguish three groups of banks: Facing relatively adverse economic conditions in their home markets, banks in Denmark, Portugal, and Spain yet achieve relatively high efficiency scores. Facing relatively favorable conditions on their home market, banks in France and Italy do not seem to be able to perform efficiently at home while banks in Belgium, Germany, Luxembourg, and the Netherlands do. In the case of these latter countries, the ability of domestic banks to exploit favorable conditions on their home market might thus explain difficulties of foreign banks to enter.

3.2 Regional Structure of International Asset Holdings

As EU banking systems have become more and more open internationally, the question is not only how large foreign assets are but also to what extent international asset holdings have been diversified. The International Capital Asset Pricing Model (CAPM) implies that investors should seek to diversify their portfolios to the greatest possible degree, and securities which show a low degree of correlation with the home portfolio should be relatively attractive. Since the member countries of the EU are relatively similar with regard to their state of economic development and since there has been a general convergence process in the up-run to the introduction of the common currency, we might expect to find a relatively small potential for diversification among these countries. If anything, there might be an incentive to diversify into the smaller EU countries which are still undergoing a catching up process and thus provide diversification opportunities. Market opportunities found in developing countries often differ from those in developed market even more profoundly. Countries in which returns feature low or even negative return correlations with those in industrialized countries might thus provide a substantially improved risk-return trade off.¹³

¹³ It has even been argued that, by exploiting these opportunities, industrialized countries could alleviate their chronic pension system problems (Reisen 2000).

Empirical evidence provided by Buch and Lapp (2000) and Lapp (2001) in fact supports the view that diversification within Europe is not necessarily an optimal strategy. Although it is certainly difficult to extrapolate future market opportunities (returns, the volatility of returns, and return correlations) into the future, evidence for bond and equity markets for the years 1988 through 1997 suggests that German investors would have gained from holding non-European stocks and bonds in their portfolios. Bonds and shares issued in Euroland indeed provided higher rates of return (calculated in D-Mark) than domestic securities. For bonds, non-EU markets not only offered higher returns but also a higher volatility. Stock market volatility, to the contrary, was similar to that in Germany for Euroland and even lower outside Europe, thus compensating for the somewhat lower returns. In addition, return correlations between non-EU and German securities were generally lower than those for securities issued in EU markets, thus offering diversification opportunities. An analysis of the investment portfolios of German commercial banks showed, however, that much of this potential remained unutilized.

The lack of evidence in favor of the investment patterns predicted by standard portfolio theory is certainly not a German phenomenon. Generally, agents tend to hold the bulk of their financial wealth in assets of their home country or currency.¹⁴ If anything, they diversify their portfolios only within a relatively small regional or cultural surrounding. There is an increasing amount of evidence that, even within national borders, investment patterns are guided by regional and cultural proximity (Coval and Moskowitz 1999, Grinblatt and Keloharju 2000). A number of explanations for this home bias in (international) investment portfolios have been offered, ranging from asymmetries in information on financial markets to incomplete integration of goods markets.¹⁵

Stylized facts on the degree of regional disparity of portfolios of European investors essentially confirm the view that geographical and cultural proximity are important determinants of international investment decisions. In the following, we are taking a fairly broad focus and look at intra-European holdings of assets, considering holdings of FDI, portfolio investments, and banking assets. Taking such a broad perspective has both advantages and disadvantages.

On the one hand, we acknowledge the fact that portfolio theory is one of the most powerful tools to analyze the degree of international financial market integration. In contrast to interest parity tests, which in a strict sense should be applied to identical financial assets such as domestic versus euromarket deposits only (Obstfeld 1995), the CAPM proposes a pricing (and thus arbitrage) mechanism precisely for different financial assets. Its prediction is that financial

¹⁴ See also Tesar and Werner (1992).

¹⁵ See Lewis (1999) for a survey.

assets should be priced according to the correlation of their returns relative to the market portfolio.¹⁶ Hence, at least theoretically, it is applicable to *all* kinds of financial assets.¹⁷

On the other hand, considering a broad range of financial assets implies that we lack data on the relevant rates of returns, particularly for foreign direct investments. Hence, rather than providing a full-fledged analysis of the deviation of actual portfolio choices from optimal patterns, we present stylized evidence on the regional composition of these portfolios.

Data on the share of EU countries in international asset holdings for the EU countries as well as for the US are presented in Table 5. These data have been drawn from three sources:

- Data on international banking assets have been retrieved from the Quarterly Review of the Bank for International Settlements (BIS 2001).
- Data on international portfolio investments have recently been published by the International Monetary Fund (IMF 1999b) and are available for most member countries, the most important exception being Germany.
- Finally, data on cross-border foreign direct investments were taken from the statistics on International Direct Investments of the OECD (OECD 2000b).

Generally, the EU member states hold more than one half of their (financial) assets within Europe. This holds true for all countries and assets considered with a few exceptions. Austria and the UK, for instance, hold less than 50 percent of their financial assets within Europe, albeit for very different reasons. For Austria, lending to the transition economies of Central and Eastern Europe is of above-average importance, thus likewise reflecting a regional component in investment portfolios. For the UK, to the contrary, the below-average EU-share is the result of the fact that London hosts an international financial center. As for portfolio investments, Italy and the UK have relatively low shares of EU-investments. Data on the outward stock of FDI have not been available for all countries. While the pattern is similar compared to security

¹⁶ Technically, this is expressed through the security's beta-factor: $r_i - r_f = \mathbf{b}_i (r_m - r_f)$. Hence, the difference between the (expected) rate of return on an asset i (r_i) and the risk-free rate (r_f) is proportional to the difference between the expected return on the market portfolio (r_m) and the risk-free rate (see, e.g., Ross 2000). Notice that this condition collapses into the interest parity condition in its strict definition if we, as Obstfeld (1995) postulates, consider identical financial assets which are merely traded in different locations.

¹⁷ This view might be considered as over-simplifying as it disregards, for instance, the special characteristics of foreign direct investment decisions. However, if international investment portfolios are defined in a broad sense and if some of the restrictive assumptions of standard portfolio models are relaxed, also FDI decisions might be considered to follow portfolio considerations.

holdings for most countries, only Portugal holds a below average share (40 percent) of its FDI in Europe.

Table 5 also reports information for the US as one of the most important international investors. While the share of the EU in the international investment portfolio of the US (about 48 percent) is somewhat below the average for the EU countries, this gap is yet far smaller than for trade. Only 20 percent of US trade is with countries of the European Union, as compared to values around 60-70 percent for the average EU country, which could be reflecting the importance of physical transportation costs. Applying a similar reasoning to Europe, one would expect a greater degree of trade integration than financial sector integration among the EU countries. Yet, this holds true for a few countries (Austria, Portugal, Spain, UK).

In addition, it could be argued that proximity plays a greater role in international bank lending than in international portfolio investments because bank lending also comprises loans to small and mid-sized customers (Eichengreen and Mody 2000). Bank lending indeed seems more heavily concentrated in Europe for the majority of countries (Denmark, Finland, Ireland, Italy, Sweden). For others, differences in the EU-shares for these two types of investments are very small, and only Austria and the UK, for reasons mentioned above, clearly show a diverging pattern.

The dominance of European countries in international asset holdings does not imply, however, that bilateral financial linkages are important relative to the total size of financial markets. Table 6 presents data on the ratio of bilateral asset holdings relative to domestic credit in EU countries. Overall, German and French banks are the major lenders on international banking markets, having accounted for almost 20 and 10 percent, respectively, of cross-border assets of commercial banks at the end of 1999. Comparing cross-border assets of German commercial banks to domestic credit in the EU countries, however, shows that most bilateral financial linkages are a relatively small fraction of total domestic credit only.

The only two countries which stand out in this regard are Germany and Luxembourg. Cross-border asset holdings of German commercial bank reach shares of 10 percent or even more of domestic credit in a number of EU countries (Austria, Denmark, Finland, Greece, Italy, Ireland, Netherlands, United Kingdom). Luxembourg, to the contrary, has liabilities vis-à-vis other EU countries which add up to more than the amount of domestic credit outstanding, Germany alone accounting for about half of these liabilities. Other major sources of intra-EU liabilities have been Belgium, France, and Italy.

3.3 Cross-Border Payments Flows

As an additional piece of information about the importance of cross-border banking, Graph 5 plots the development of cross-border payments flows in Europe which have been channeled through the payments system TARGET since the introduction of the Euro in January 1999. Although differences in the institutional set-up of payments system might affect the importance of cross-border payments flows, the data are yet instructive as regards developments over time.

Generally, the data show a modest increase in the importance of cross-border payments relative to total payments flows. Arguably, this increase is somewhat more pronounced for the number of transactions (Graph 5a) rather than their total value (Graph 5b) but it points to a greater degree of integration of money markets after the introduction of the euro. Whereas, in general, domestic payments dominate, cross-border payments tend to have larger volumes than domestic transactions.

In addition, the share of cross-border payments flows in the total differs considerably among countries (Graph 5). For Greece, Sweden, and Denmark, cross-border payments constitute more than 90 percent of total payments flows. This share is somewhat lower for the UK, Luxembourg, and Belgium but still reaches about 70 percent. For a third group of countries (Netherlands, Austria, Germany), cross-border payments flows account for about 50 percent of the total, and the remaining countries report shares of 10 to 40 percent.

3.4 Structure of German Capital Flows

The creation of a Single Market for capital could be expected to have tilted international capital flows of the European countries towards other member countries of the EU. Data for Germany reveal that, in fact, the share of EU countries in gross capital flows has increased continuously during the past decades (Graph 6). This trend is visible both for gross in- and outflows of capital. However, it is difficult to detect a significant impact of the Single Market program per se on these developments, at least not for total capital flows. Rather, increased financial linkages with the EU countries could be observed already since the earlier 1970s.

As for the individual items on the capital account (FDI, portfolio investment, bank lending), it is difficult to detect a long-term trend either. Partly, this is due to the fact that, even on an annual basis, the data are relatively volatile and that large outliers have occurred. If anything, it seems as if the increasing share of EU countries in Germany's capital flows has been driven by an increase in portfolio capital flows to this region.

In order to show changes in the structure of capital flows over time, Table 4 additionally presents the structure of German capital flows for three regions (all countries, non-EU industrial-

ized countries, EU countries) and for the period between 1971 and 2000. Additionally, the sample is broken down into the period before and after 1992.

As for gross capital inflows, FDI and portfolio investments have gained in importance at the expense of bank lending. Interestingly, while the structure of capital flows to non-EU industrialized countries has been almost stable over time, a relatively dramatic change in the structure of capital inflows from EU countries has taken place: FDI has increased from about 8 to 22 percent, portfolio investment from 34 to 40 percent, while the share of bank lending shrank accordingly.

Generally, the shift away from bank lending towards portfolio investment and — to a lesser extent — to FDI is also visible for German gross capital outflows. Again, differences between EU and other industrialized countries are visible: whereas, for other industrialized countries, the share of outflows of FDI has increased as well, substitution within Europe has taken place between portfolio investment and bank lending only.

These stylized facts suggest that, even though the Single Market program has intended to increase the incentives of banks to lend and borrow across borders, cross-border lending has not benefited more than proportionally than other capital flows. Rather, international portfolio investment seems to have increased more rapidly, and this disintermediation trend in German capital flows seems to have been more pronounced within Europe than for other industrialized countries.

3.5 Correlation Analysis

The effects of the regional diversification of banks' portfolio on contagion effects depend on the correlation of regional liquidity shocks (cf. Section 2.1). We have therefore calculated the correlation between changes deposits in EU countries to capture the importance of regional shocks. As a benchmark, we are including the correlation coefficients with the US and Japan.

Since the time series under study are predominantly non-stationary, we are using first differences of monthly data in order to avoid spurious correlations.¹⁸ Correlation coefficients are calculated for changes in total deposits of banks (demand plus other deposits) and for two time periods (before and after 1992). Results are presented in Table 3 which shows the correlations in the latter sample period (Table 3a) as well as the changes in the coefficients that have occurred between the two periods (Table 3b).

¹⁸ Data have, however, not been seasonally adjusted, which may tend to bias the estimated correlation coefficients upward.

The first stylized fact that emerges from Table 3a is that, on average,¹⁹ correlations among the European countries are not higher necessarily than those between Europe and the US or Japan. Virtually all EU markets are more closely correlated with the US than with the EU average and, for most of them, this also holds in relation to Japan. At the same time, there is a substantial degree of variation among the EU countries: correlations are relatively high among the Scandinavian countries (Denmark, Sweden), Southern Europe (Greece, Italy, Portugal, Spain), the large European countries (Germany, France, Italy), and the countries hosting international financial centers (Ireland, Luxembourg). However, there is also a number of low and even negative correlations, the latter in particular for Ireland and Luxembourg relative to the other EU countries.

In order to explore further whether there are any statistically significant patterns in the data, we have additionally correlated the deposit correlations with a number of potentially related variables. Berger et al. (2000a), for instance, provide evidence on the correlation patterns between banks' return on equity for the country sample we are looking at here. Their data are for the years 1979 through 1996, and we have therefore chosen the same time frame. Yet, we find no significant correlation between changes in deposits and the return on equity of banks (correlation coefficient of 0.19). Likewise, both variables are not linked significantly to geographical distance or correlations of GDP growth.

Although we are not providing a full-fledged portfolio model, these results get point to the conclusion that there are quite substantial diversification opportunities in Europe, which are moreover relatively persistent over time. Comparing the correlation between changes in deposits for different time periods indeed supports this view. Although correlations between EU banking markets have increased after 1992, these increases have not necessarily been more pronounced than in comparison to the US or Japan (Table 3b).

¹⁹ Note that the EU averages have not been weighted, which may partly affect these results. Changes in deposits of Austrian banks are, for instance, more closely correlated with the large EU countries Germany, Italy, and France than with the US.

4 Transmission and International Lending: Evidence from German Data

The descriptive statistics presented in the previous section have shown three main tendencies. *First*, financial sector openness, as measured by the share of external assets and liabilities of commercial banks, has increased over the past decades. *Second*, financial sector linkages among the countries of the EU are particularly strong, with about two thirds of international assets holdings of the EU countries remaining within the region. Taken in isolation, these two factors would suggest that propagation effects through banking sector linkages could be important for these countries. This risk, however, is potentially counterbalanced by the *third* stylized fact, namely the typically limited importance of bilateral financial linkages. Even if foreign (real or financial) shocks were to be propagated through the international activities of foreign banks, this transmission channel might thus have a relatively limited impact on the host country.

The fact that foreign lending by German banks plays a quite important role for a number of smaller EU countries (see Table 6) while, obviously, the reverse does not hold, suggests that an analysis of the impact of shocks to the German economy on credit markets in these countries can provide insights into transmission channels. In the following, we are analyzing lending markets in four countries (Austria, Denmark, Finland, Ireland) with a particular focus on the question to what extent lending on these markets is affected by conditions in Germany. Hereby, we analyze both the activities of German banks on these markets and aggregate domestic credit in order to show whether adjustments in the lending patterns of German banks may to some extent be counterbalanced by changes in the behavior of other lenders.

4.1 Earlier Evidence

As regards the empirical analysis of spill-over effects through the international activities of banks, two strands of the literature can be distinguished. A first group of papers focuses on the triggers and possible common sources of banking crises. One conclusion of this literature is that banking crises have in the past been triggered by both idiosyncratic and systematic shocks. Also, there is a substantial amount of evidence that banking crises tend occur simultaneously. However, it has proven difficult to isolate empirically whether this simultaneous occurrence of shocks is the result of contagion or the common exposure to aggregate shocks (De Bandt and Hartmann 2000).

Since the focus of the present paper is on the propagation effects through international bank lending, a second but much smaller group of papers is of particular interest. Van Rijckeghem and Weder (2000) analyze the pattern of foreign bank lending during three recent financial crises episodes (Mexico, Asia, Russia), focusing on the propagation of shocks through common

lender effects. Using changes in the exposure of BIS reporting banks to emerging markets in response to changes in exposure to other markets, they find significant common lender effects during the Thai and Mexican financial crises.

While Van Rijckeghem and Weder (2000) are concerned with the channels of transmission of international financial crises, Peek and Rosengren (1997, 2000) have focused on the transmission of domestic shocks in the Japanese economy into loan supply in the US. Interest in Japanese-US financial linkages arises from the fact that, on the one hand, Japanese banks have been affected by substantial regulatory changes and adverse shocks at the national level, which has raised the issue to which extent these shocks have been transmitted to foreign markets. On the other hand, Japanese banks hold substantial stakes in the US banking system, which makes the total amount of bank lending available to US firms potentially sensitive to changes in the behavior of Japanese banks.²⁰

Peek and Rosengren (1997) use bank-level data for the years 1988 through 1995 for Japanese banks and find that changes in lending are, inter alia, influenced by the capital-asset-ratio of the parent bank and by its amount of non-performing loans. In a follow-up paper (Peek and Rosengren 2000), they focus on the market for real estate loans in California, New York, and Illinois, finding evidence for a statistically and economically significant impact of a loan supply shock in Japan on economic activity in the US.

More specifically, Peek and Rosengren (2000) use the change in real estate loans of large banks in these three states as a dependent variable in a panel analysis for all large domestically-owned banks and Japanese bank branches. The explanatory variables fall into three main groups: factors capturing conditions of the Japanese parent bank, those capturing macro-economic developments in the Japanese economy, and those reflecting conditions on the US market. Their results show a positive impact of the risk-based capital ratio at the Japanese parent bank and of Japanese FDI in the US economy and a negative impact of the ratio of non-performing loans on changes in real estate lending. No statistically significant effect of a dummy for the presence of non-performing loans in the parent bank and its risk-based capital ratio or the capital asset ratio of US banks is found. Overall, these results show that a deterioration of asset quality on the level of the Japanese parent bank was transmitted to US real estate markets through a decline in lending of Japanese banks. Moreover, the impact on real activity in the US was found to be statistically and economically significant.

²⁰ The importance of Japanese banks in the US has declined recently, however. In 1988, European banks held only 27 percent of foreign banks' assets in the US, only half of the share of Japanese banks (60 percent). By 1998, these shares had reversed (calculated from Houpt 1999). Also, market shares of foreign banks in the US as such have gone down recently (Buch and Golder 2001).

It might seem reasonable to apply a similar analysis to bank lending markets in Europe. However, as Peek and Rosengren (2000) note, the applicability of their method hinges on two special conditions which are not readily met in the case of Europe:

First, Japanese banks have experienced a relatively large shock to domestic real estate prices which has been unrelated to economic conditions in the US and have adjusted to this shock by cutting down their (foreign) lending activities. In Europe, there are few events which have affected only a single country. If anything, German reunification might be considered an external shock to the German banking system which has been unrelated to events elsewhere. As new lending opportunities have become available, reunification might have had a negative impact on German banks' credit supply elsewhere in Europe.

Second, market shares of Japanese banks on the US market have been fairly high, in particular in the three states on which the study focuses.²¹ As has been argued above, even the large EU members have not achieved similar degrees of bilateral penetration of banking markets (Table 6).

Obviously, the degree to which foreign shocks are transmitted through internationally active banks crucially depends on the importance of foreign lending in a given market. In both case studies cited above — lending by Japanese banks in the US and lending of industrialized countries to emerging markets — activities of foreign banks are relevant for economic developments in the host region because the foreign liabilities of the countries under study are relatively large. If anything, these numbers would suggest that shocks originating in Germany could have a significant impact on other EU countries. This holds in particular if one additionally considers linkages between credit and other capital flows. Recent empirical evidence suggests that different types of capital flows tend to be closely correlated (Buch and Pierdzioch 2001). Moreover, there is a complex interaction in the volatility of capital flows. Hence, even if lending of foreign banks on the home market might appear relatively small, changes in it might have magnification effects on other capital flows.

4.2 Foreign Lending of German Banks

In this section, we analyze the determinants of claims of German banks on Austria, Denmark, Finland, and Ireland.²² We are particularly interested in the question to what extent structural changes occurring in the German economy spill over into these markets. In this context, the

²¹ New York and California have particularly high market shares of foreign banks. In the remaining US states, market shares of foreign banks are as low as in the typical European country (Buch and Golder 2001).

²² We exclude Luxemburg because of the special nature of its financial system.

question whether foreign activities of banks are driven by domestic or foreign factors is important. If, at one end of the spectrum, the lending decisions of German banks in the, say, Irish market are determined by German factors only, this would imply a transmission of German factors through international bank lending. If, to the contrary, Irish factors would matter only, there would be no propagation effect of this type. In this section, we present several stylized facts and empirical tests which provide us with information concerning the importance of spill-over through bank lending channels.

4.2.1 Stylized Facts

Statistics on the international investment position of German banks provide a breakdown of the assets and liabilities of domestic banks, their foreign subsidiaries, and their foreign branches abroad.²³ Previous research has found that banks choose different organizational forms depending on the regulatory regime and the state of development of host markets. Ter Wengel (1995), for instance, argues that subsidiaries are employed in countries with liberal regulations and high per-capita incomes. Heinkel and Levi (1992) provide evidence that activities of foreign subsidiaries are closer to the host-country market than those of foreign branches because they are set up as independent entities in the host-country.

Table 7 depicts some of the characteristics of German banks' foreign activities which confirms some but not all of these hypotheses. Data are for 1984 through 2000 and, due to the dominance of the EU in external claims, the EU data can be seen as representative also for total foreign assets. When comparing the evolution of these numbers over time and across countries, a number of noteworthy characteristics emerge:

First, on average, the share of domestic banks in foreign assets has been about 45 percent, followed by foreign branches (34 percent) and foreign subsidiaries (20 percent). For Europe as a whole, there has been a shift away from domestic banks towards branches since the mid-1980s. These trends are different for Denmark, Austria, and Finland though where cross-border activities of domestic banks have been above average and where growth of branching activity has been less pronounced. One obvious explanation for this pattern is the geographical proximity of Austria and Denmark to Germany and their small size, given fixed costs of market entry.

Second, lending to non-banks has become more important over time for Europe as a whole and, particularly, for Finland. This may suggest that German banks have increasingly been able to enter the retail banking segment of the host economies by gradually improving their credit

²³ In the following, we will use the term "German banks" as comprising all of these categories. Notice that the domestic banks include subsidiaries of foreign banks in Germany. However, due to the small overall market shares of foreign banks, these are unlikely to constitute a large share of the banks' total foreign assets and liabilities.

risk assessment of non-banks customers. The exceptions are Denmark, where the share of lending to non-banks has been flat and above-average throughout, and Ireland, where interbank lending has gained substantially.

Third, when comparing the share of lending to non-banks across the three different types of German banks, little support can be found for the hypothesis that subsidiaries are closer to the local market and thus mainly service non-bank consumers. While this pattern is found for the EU as a whole and for Denmark, it is not evident in the data for the other countries. In Austria and Ireland, domestic German banks are more active in dealing with non-bank customers than foreign subsidiaries, in Finland, the importance is similar for domestic banks and their foreign subsidiaries.

Fourth, there is a positive correlation between the share of lending to banks and the share of short-term loans. Also, short-term foreign assets are more important for the branches of foreign banks than for the other banking groups, reflecting the focus of foreign branches on the wholesale banking market. Generally, the share of short-term lending shows the cyclical pattern which is also found in international data (Mussa et al. 1999) but no clear trend over time.

Overall, these stylized facts suggest that financial linkages between Germany and the smaller EU countries under study here are special in the sense that they are to a relatively large degree facilitated through domestic banks. While the structure of foreign assets and liabilities of German banks and their subsidiaries shows certain similarities, activities of foreign branches seem to be more focused on the wholesale, interbanking market. In addition, the Irish case is special because it is the only market for which interbanking relationships have become more important over time.

4.2.2 Data Specification

The transmission of (financial) shocks through international activities of commercial banks is a relatively new field in the literature on international banking. One of the few studies addressing this issue (Peek and Rosengren 2000) uses bank-level data to assess the impact of changes in the capitalization of parent banks on lending decisions abroad. Unfortunately, lacking comparable micro-data on the regional credit portfolios of individual German banks, we are not able to apply the same empirical strategy.

Rather, we are estimating reduced-form equations for the loan supply of German banks on the respective host markets:

$$(1) \quad L_t = \mathbf{g}_0 + \mathbf{g}_1 X_t + \mathbf{g}_2 X_t^* + \mathbf{e}_t,$$

where L_t = credit supply of German banks abroad, $X_t(X_t^*)$ = parameters capturing demand and supply conditions on the foreign and the German market, and \mathbf{e}_t = error term. If markets are

linked but if international asset holdings are not diversified fully, a negative liquidity shock to the German banking system would be expected to spill-over into host-country markets. In Allen and Gale (2000b) these market linkages arise through interbank deposit-taking only. In reality, however, markets are also linked through (trade-related) financial transactions with non-financial firms or the capitalization of banks.

In estimating equation (1), we are facing a basic identification problem since we must be able to isolate domestic from foreign factors affecting credit supply decisions. Since we are considering the supply of credit of German banks on the host-country market, this is equivalent to identifying supply- versus demand-side factors. Several methods for identification have been proposed in the literature:

Winker (1996) analyzes the German credit market and estimates a simultaneous equation model for loan demand and supply as well as a target value for the lending rate, explicitly allowing for disequilibrium effects. Peek and Rosengren (1997, 2000), as has been described above, identify a supply shock by using the capital-asset ratio of Japanese banks, which is essentially unrelated to domestic factors on the US market, as an explanatory variable for the lending activities of these banks in the US. Finally, Ostergaard (2000) studies the determinants of changes in lending decisions of banks in the US, instrumenting demand effects through dummy variables capturing changes in US tax laws which have affected the demand for but not the supply of loans.

Our strategy for identifying demand- and supply-side factors has been to find domestic (foreign) variables potentially affecting the loan supply decisions of German banks while being unrelated to conditions on the host (domestic) market.

To capture shocks to the German banking system, we have included the capitalization of German banks (the ratio of capital over total assets) as an explanatory variable. Since the capitalization is unlikely to be affected by developments in the host markets, one reason being the fact that reverse financial and trade linkages are unimportant for the German economy (see also Table 6), this allows us to capture supply-side, German factors. Better capitalized banks should be able to grant more loans, and we would expect a positive coefficient. Although this ratio shows a positive correlation with measures of the demand for loans in the host market (GDP or the index of industrial production), these correlations are yet lower than for the simple (log of) the capital of German banks. The exception is Austria for which we are using the change in the capitalization ratio instead. At the same time, (log) capital and the capitalization ratio are highly correlated. We might also expect a stronger impact of the degree of capitalization on the activities of domestic banks than for their foreign branches and subsidiaries. Subsidiaries, in particular, are legally independent units which hold their own capital stock but are owned by the parent bank.

As regards shocks specific to the German economy, the re-unification has undoubtedly been the major event in the past decades. At the same time, it is unrelated to local demand conditions on the markets for foreign loans of German banks that we are considering. We have account for this fact by introducing a dummy variable which has been set equal to one starting in June 1990, i.e. after the official introduction of the D-Mark in East Germany, and equal to zero before this time.

In addition, we have controlled for demand factors and interest rates. Demand for loans on the host market can be expected to be a positive function of the level of economic activity, such as measured through the volume of GDP. Hence, it would be expected to enter with a positive sign. A similar argument could be made for the demand for loans on the home market. The supply of loans of German banks abroad would therefore be a negative function of economic activity in Germany. Due to a high degree of multicollinearity between the levels of GDP across Europe, however, we cannot isolate domestic and foreign demand factors: For the countries under study, domestic GDP is highly correlated with German GDP, the correlation coefficients being in the order of magnitude of 0.8–0.9 (for the levels). In addition, GDP and bilateral trade move closely together.²⁴

Therefore, we have controlled for the importance of foreign trade financing, which has been identified in the literature as one of the main reason for banks to go abroad, by including the average volume of bilateral foreign trade (exports plus imports divided by two).²⁵ To the extent that there is a link between banks' activities on foreign markets and the presence of German firms abroad, we would expect a positive coefficient. In interpreting this variable, two important issues need to be borne in mind: First, since trade activities are highly correlated with both domestic and foreign GDP, we cannot interpret trade as capturing either domestic or foreign demand conditions. Rather, we use it as a general proxy for market demand. Second, because cross-border financial flows to some extent reflect the financing of foreign trade, the trade variable might not be exogenous.

An identification problem similar to the one that beleaguers proxies of domestic demand affects the choice of the interest rate variable. Within the sample of European economies that we are studying, interest rates have been highly correlated throughout the sample period. This holds both across countries as well as for individual market segments (deposit, lending, or discount rates) within a given country. Hence, it is impossible for all practical purposes to identify effects of domestic versus foreign interest rate changes. We have therefore chosen the German

²⁴ This holds also for Finland for which the correlation between domestic and economic activity is lower than for the other countries.

²⁵ An additional variable controlling for the activities of German firms abroad could be the stock of bilateral FDI. However, we did not have information on this variable on a quarterly or even monthly basis.

deposit rate as a proxy for the costs of refinancing of German banks. This choice was motivated by two considerations:

First, the German discount rate, which would more directly capture the effects of a common monetary policy, has remained unchanged over certain time intervals. Hence, we prefer a more market-based interest rate. *Second*, contrary to the German lending rate, the deposit rate is practically uncorrelated with the US T-Bill rate which we will later on include as a proxy for the international interest rate level. Although, theoretically, the German deposit rate should reflect the costs of deposits for German banks and enter with a negative sign, it is at the same time highly correlated with the Finnish and the Austrian lending rate and might thus pick up also the return on lending in these markets. The interpretation of the coefficient on the US T-bill rate is less difficult. Although this rate may to some extent pick up the costs of refinancing on the international capital market, it is more likely to reflect the opportunity costs of lending within Europe, and we would expect a negative coefficient.

As a baseline estimation, we are using trade links, the capitalization of German banks, and the German deposit rate as explanatory variables. The data we are using in the following are monthly, seasonally adjusted variables (using the multiplicative Census X-11 method) for the years 1985 through 2000. Hence, we have about 190 observations in each case. The dependent variable and foreign trade were entered in logarithmic form, and the estimated coefficients can be interpreted as elasticities. The remaining coefficients are semi-elasticities; multiplication with the initial level of the explanatory variable yields the actual elasticity. All equations have been estimated separately for the different types of German banks (domestic banks, subsidiaries, branches) and for host-country domestic credit.

4.2.3 Cointegration Tests

Prior to establishing the long-run determinants of German loan supply abroad, we have tested whether each variable passes a unit root test. Results are given in Table 8. Given that all the variable of interest appear to contain a unit root, we have first run different tests for the presence of a cointegration relationship (i.e. a stationary linear combination) among them.

Two types of cointegration tests have been performed. First, residual-based tests such as the two-step Engle Granger test (1987) aim at distinguishing a system without cointegration from a system in which at least one cointegration relationship is present. Second, we are using the Johansen procedure to determine the number of cointegration relationships in the system. The evidence that we obtain from these tests is mixed though.

Starting with the Engle-Granger procedure, we have first regressed the log of claims of German banks abroad on the main variables of interest, i.e. the log of bilateral foreign trade, the German deposit rate, and the capitalization of German banks. In a second regression, dummy

variables for German unification, the Second Banking Directive, and the introduction of the euro have been added as well. The residuals from these regressions have then been tested for stationarity by means of ADF tests (Table 9). Generally, reject the hypothesis that the residuals are stationary, and that there is at least one cointegration vector in the system. Evidence for cointegration is found only for activities of domestic banks on the Austrian market.

However, the results from the Engle-Granger tests are not supported by the results from the Johansen procedure (Johansen 1988). With this method, we can identify if there is a common stochastic trend in the data and thus if the variables under study are cointegrated. More technically, there is a vector X_t of n potentially endogenous variables, where X_t can be modeled as an unrestricted VAR involving up to k lags of X :

$$(2) \quad X_t = A_1 X_{t-1} + A_2 X_{t-2} + \dots + A_k X_{t-k} + u_t,$$

where the residuals are normally distributed with zero mean $u_t \sim N(0, \mathbf{S})$. We can reformulate this equation into an error correction model

$$(3) \quad \Delta X_t = \Gamma_1 \Delta X_{t-1} + \dots + \Gamma_1 \Delta X_{t-k+1} + \Pi X_{t-k} + u_t,$$

with $\Gamma_i = -(I - A_1 - \dots - A_i)$, $\Pi = -(I - A_1 - \dots - A_k)$, and $\Pi = \mathbf{a}\mathbf{b}'$, where \mathbf{a} gives the speed of adjustment to equilibrium, while \mathbf{b} gives the matrix of long-run coefficients which provides up to $n-1$ cointegration relationships in the multivariate model that ensure the convergence of the elements in X_t to their long-run steady state values. The existence of r cointegration vectors among n variables, where $r < n$, implies that there are $n - r$ shared trends. If $n - r = 1$, this is evidence for a single shared trend. If $r = 0$ and the rank of Π thus zero, there are n stochastic trends but no shared trends.

Table 10 presents the results of these tests, determining whether there are cointegration relationships between the supply of German banks abroad, the bilateral trade between Germany and the host country, the German deposit rate, and the capitalization of German banks. The results strongly suggest the presence of cointegration relationships in the data, in some cases even of several of such relationships. Very similar results (not reported) are obtained when estimating the system using the credit supply of the foreign branches or subsidiaries. Hence, when estimating the long-run determinants of German banks' foreign activities below, we need to make use of an estimation method which takes the potential endogeneity of the explanatory variables into account.

4.2.4 Dynamic Ordinary Least Squares (DOLS) Estimators

After having established some evidence for the presence of cointegration relationships between the variables under study, we now move on to estimate the long-run determinants of lending of

German banks abroad. In a baseline specification, we have again used the volume of bilateral trade, the capitalization of German banks, and the German deposit rate as explanatory variables. Doing so, we have to take into account the potential endogeneity of foreign trade: if banks extend credits abroad in order to finance foreign trade, the volume of trade would depend on the amount of bank lending. One method of testing for cointegration between non-stationary variables which takes the endogeneity of the regressors into account is an estimator proposed by Saikkonen (1991). Stock and Watson (1993) have subsequently modified this estimator and also shown that it is asymptotically equivalent to other methods estimating long-run cointegration vectors while having superior small sample properties.²⁶

This dynamic ordinary least squares (DOLS) method starts by regressing the level of the endogenous variable on the levels, leads, and lags of the potential explanatory variables:

$$(4) \quad L_t = \mathbf{g}_0 + \mathbf{g}_1 X_t + \mathbf{g}_2 X_t^* + \sum_{i=-K_2}^{K_1} a_j \Delta X_{t+i} + \sum_{j=-K_0}^{K_1} b_j \Delta X_{t+j}^* + \mathbf{e}_t$$

where X (X^*) = domestic (foreign) determinants of loan supply, $t = K_2 + 2, K_2 + 3, \dots, T - K_1$, and \mathbf{e}_t = error term. While \mathbf{g}_1 and \mathbf{g}_2 give the long-run cointegration coefficients, the coefficients of the leads and lags of the explanatory variables have no economic interpretation but serve the purpose on ensuring the consistency of the regression and to eliminate the effects of regressor endogeneity. The convenient feature of the *DOLS* estimator is that an *OLS* estimate of (4) yields consistent estimates of the long-run coefficients despite the fact that the errors and the regressors will usually be correlated. This is due to the fact that the *OLS* estimators will be super-consistent because they asymptotically converge to the true parameter value with a rate proportional to the sample size T rather than \sqrt{T} as in normal applications (Stock 1987).

One additional advantage of this method is that the residuals \mathbf{e}_t need not be free from autocorrelation. If they are autocorrelated, however, the t -statistics used to test the significance of the cointegration parameters need to be modified by taking into account consistent estimators of the long-term variance.

Since the number of the leads and lags K in (4) is not chosen such as to remove residual autocorrelation, a criterion is needed to determine the appropriate K . Hassler (2001a) proposes to use information criteria. Maddala and Kim (1999) suggest to use a general-to-specific approach and to estimate the model with as many lags (and leads) as possible to begin with, dropping insignificant variables subsequently. In our case, however, it has proven difficult to use information criteria because the standard information criteria (Akaike's AIC or Schwarz's

²⁶ For a discussion of this method see Hassler (2001a) and Maddala and Kim (1999).

BIC) kept increasing in absolute terms as we increased the lag length. We have therefore started by estimating the model using 12 leads and lags in each case.

As an additional test for cointegration, we have used the KPSS-test (Kwiatkowski et al. 1992) to test for stationarity of the residuals in (4). In contrast to other tests for cointegration, KPSS switches the Null and the Alternative. It tests the Null hypothesis of cointegration (i.e. \mathbf{e}_t is stationary) against the hypothesis of no cointegration (\mathbf{e}_t is I(1)). In other words, the Null of cointegration is rejected at large values of the KPSS statistic. If the OLS estimator of the cointegration vector is not asymptotically normal, the KPSS test statistic can yet be calculated by using the efficiently corrected residuals from estimating (4) (Shin 1994). The test statistic is then given by

$$(5) \quad \mathbf{h}_{m,K} := \frac{T^{-2}}{\hat{\mathbf{w}}_v^2} \sum_{t=1}^T \left(\sum_{i=1}^t \tilde{\mathbf{e}}_i \right)^2$$

where the long-term variance of the residuals is given by $\mathbf{w}_v^2 = \text{Var}(\mathbf{e}_t) + 2 \sum_{t=1}^{\infty} \text{Cov}(\mathbf{e}_t, \mathbf{e}_{t+t})$ and $\tilde{\mathbf{e}}_i$ denotes the estimated residuals. Since at least one of our RHS variables, i.e. trade, follows a deterministic trend, the critical values need to be adjusted accordingly (Hassler 2001b), and we have

$$(6) \quad \mathbf{h}_{m,K} \xrightarrow{d} KPSS_t(n-1)$$

When performing the KPSS test, an appropriate truncation lag must be specified. Kwiatkowski et al. (1992) use annual data and argue that a lag of 8 is a compromise between the large size distortions using a lag of 4 and the low power under the alternative hypothesis if a lag of 12 was chosen. In the present paper, we are reporting the results for truncation lags of 12 and 24. In most of the cases, the value of the test statistic changed very little when increasing the truncation lag.

Results are summarized in Tables 11–14. The equations are estimated for each of the three organizational forms of German banks (domestic banks, subsidiaries, and branches) separately,²⁷ and domestic credit in the respective host country is used for comparison. After estimating the baseline regression, different regulatory dummies as well as a linear time trend have been added. We have also included additional explanatory variables such as the US T-bill rate (results not reported) and an index of economic sentiment.

²⁷ The exception is Ireland since the time series for foreign subsidiaries of German banks have started only in 1991 and have therefore not been included.

Considering the baseline regressions first, they provide results which are consistent with our expectations, and there generally is evidence in favor of cointegration among the variables. Results for the individual coefficient estimates, however, differ between countries. Foreign trade enters with a positive sign for Austria and Finland. As regards the magnitude of the coefficients, there appears to be a stronger link between the foreign activities of German banks and their branches and foreign trade activities than this is the case for the foreign subsidiaries. This could be taken as evidence in favor of the hypothesis that activities of subsidiaries are more oriented towards the host-country market. Yet, it should be noted that also domestic credit as such tends to be correlated with foreign trade activities. This correlation is most likely due to the fact that foreign trade is capturing demand conditions in general and thus picks up the level of economic activity. In the case of Denmark, no significant impact of trade in the baseline regression is obtained and even a negative link for branches subsidiaries when the dummies are added. A positive effect is found for activities of foreign branches in Ireland.

For Austria, Denmark, and Ireland, the German deposit rate has the expected negative sign, i.e. an increase in the funding costs of German banks lowers their foreign lending activities. A positive sign is found in most of the equations estimated for Finland, reflecting a relatively high correlation between Finnish lending and German deposit rates.

Finally, the capitalization of German banks clearly has a positive impact on foreign lending in Austria for all three banking groups considered, and this effect also feeds through into Austrian domestic credit. As expected, the magnitude of this effect is greatest for domestic banks, followed by their branches and their subsidiaries. The effect is weakest, in economic terms, with regard to domestic credit. Similarly, we find a positive impact of the capitalization of German banks on their credit supply in Denmark. Likewise, for Finland, a positive effect is obtained for the baseline specification for domestic banks and their subsidiaries, and the impact on domestic credit is even negative. The only robust finding for Ireland is a positive and significant link between the capitalization of German banks and the foreign lending activities of their branches.

For Austria and Denmark, we even find a positive effect of the capitalization on domestic credit, suggesting that the foreign lending activities of German banks are indeed a channel through which domestic shocks are transmitted internationally. For Finland and Ireland, the evidence is more mixed, and we even find a negative link between the capitalization of German banks and domestic credit. One possible explanation for this finding could be that the two countries are more remote from Germany while Denmark and Austria are neighboring countries which are essentially affected by the same factors as the domestic credit market.

Because loan demand and supply can be expected to reflect expected rather than current business conditions, it might be useful to capture these effects through indicators of economic confidence. Since 1995, the European Commission has been publishing indicators of economic sen-

timent in the EU members countries which we use as a proxy for expected business conditions. The coefficient is constructed such that it takes a value of 100 if no changes are expected and more (less) than 100 if better (worse) business conditions are expected. Hence, this variable should enter with a positive sign for the host and with a negative sign for the home country (Germany). Since for Denmark, Finland, and Ireland, these indicators have are insignificantly correlated with the German index, we can expect that they capture host-country conditions. For Austria, however, the correlation is relatively high (0.75).

Generally, by including the sentiment indicators, the evidence in favor of cointegration weakens. Hence, one should be cautious in interpreting the following relationships as stable, long-run linkages. With regard to the magnitude and the significance of the individual coefficient estimates, however, the results are relatively clear.

With the exception of Ireland, the sentiment indicators tend to be statistically significant.²⁸ However, they have the expected signs (positive for the domestic, negative for the foreign index) only for the branches and subsidiaries of German banks in Austria as well as Austrian domestic credit. For the remaining specifications, the relationship is often reversed, and expected changes in German business conditions enter with a positive sign. One possible explanation of this finding is that, due to the close linkages in business cycles across the countries under studies, improvements in conditions in Germany also lead to revisions in expectations about business conditions abroad.

Not all of the results are robust against including additional explanatory variables (results not reported), mainly because we have additionally included a linear time trend which often renders the trade variable insignificant. Dummy variables we are adding are intended to capture the German unification process in 1990, the implementation of the Second Banking Directive in 1992, and the introduction of the Euro in 1999. We expect German unification to have a negative impact on the foreign lending activities of German banks due to the increased demand for capital at home. The Second Banking Directive should, in general, have increased the incentives of banks to go abroad. However, different organizational forms have not been affected in the same way. We would in particular expect that foreign branching activity has been affected. Finally, the introduction of the euro has caused some statistical changes in Euroland, which this dummy might be picking up.

As regards German reunification, we do indeed find the expected negative impact on the foreign activities of domestic German banks in Denmark and Austria. However, this negative effect does not carry over to the activities of foreign branches and subsidiaries (which mostly have expanded following re-unification) or to the activities on the Finnish market (where we

²⁸ Generally, the weaker results for Ireland are most likely due to the fact that lending takes place mainly on the interbank market.

find a negative impact on the lending activities of foreign subsidiaries). These findings suggest, on the one hand, that the banks might have been shifting activities between the different organizational forms and, in addition, that the channels through which the banks are operating are shaped by national characteristics and regulations.

The findings for Ireland are particularly striking. Here, activities of German banks seem to have increased significantly following unification. Rather than picking up an actual reunification effect, however, this variable is more likely to reflect the substantial move towards financial integration that Ireland has made. As depicted in Graph 3, foreign assets and liabilities of Irish commercial banks have generally expanded rapidly since the early 1990s, hence the unification dummy coincidentally might be reflecting this trend. Notice also that Ireland is the only country for which a linear time trend has been significant throughout. Fairly mixed effects are also found for the Second Banking Directive and the introduction of the euro. However, these latter effects should not be over-interpreted since they are, to some extent, due to a reclassification of foreign assets and liabilities following the introduction of the common currency and do therefore not necessarily reflect changes in the lending behavior of banks.

It should be noted, in addition, that not all of these results have been robust against changes in the lag length. In addition to the results reported above, we have run the regressions using 6 and 18 leads and lags. For Austria, we obtain fairly similar results with regard to trade, the interest rate, and the capitalization. Similarly, for Finland, the positive trade effects, and some of the interest rate effects are fairly unaffected by the choice of the lag length. Results are less stable for Denmark though.

Finally, we have added the US T-bill rate as a regressor in order to capture the conditions on international financial markets. We would, as has been argued above, expect to find a negative effect of this variable to the extent that it is picking up the opportunity costs of lending to one of the markets considered here. Yet, we obtain fairly different results across markets and different types of banks, and there is no clear pattern in the data. If anything, we find a positive link between the activities of domestic banks abroad and the T-Bill rate (Ireland and Finland), and a negative link to the foreign activities of domestic banks' branches (Denmark, Ireland, Finland). For Austria, to the contrary, activities of foreign branches are affected positively, while we find a negative link to the activities of foreign subsidiaries. Also, some of the estimated coefficients, in particular for Denmark, are not robust against including the international interest rate.

In summary, there are a few findings that seem to be fairly robust. First of all, we have confirmed the result of earlier studies on the international activities of commercial banks that trade and international lending activities are linked. This is one potential channel through which shocks can be transmitted internationally. However, we have not attempted to shed light at the question what the direction of causality between trade and financial markets might be. Since trade activities are closely correlated with economic activity in general, both at home and

abroad, we also cannot identify whether domestic or foreign shocks are transmitted. Secondly, we have tried to capture shocks specific to the domestic economy and/or the German banking system through the German deposit rate and the capitalization of German banks. Although results have varied between countries, we have found evidence for the hypothesis that changes in the liquidity conditions on German markets and the capitalization of the German banking system spill over into the smaller European countries under study here through the international activities of German commercial banks. These effects also seem to affect general credit supply conditions abroad.

4.3 Short-Run Dynamics

So far, our analysis has focused on the long-run determinants of banks' activities abroad while ignoring the short-run dynamics of foreign lending. One way of analyzing the impact of (exogenous) shocks such as changes in the capitalization of the German banks on both their foreign assets and foreign domestic credit is to perform an impulse-response analysis. While impulse responses analyses have been a standard tool for analyzing the transmission of monetary impulses or, more recently, also the activities of different banking groups (Kueppers 2000), they have less frequently been used for an analyses of the foreign lending activities of commercial banks.

We have estimated the following VAR

$$(7) \quad y_t = A_1 y_{t-1} + \dots + A_p y_{t-p} + e_t$$

where y_t = vector of k endogenous variables, A_1, \dots, A_p = matrices of coefficients to be estimated, and e_t = vector of innovations. These innovations are allowed to be contemporaneously correlated but are assumed to be uncorrelated with their own lagged values and the remaining RHS variables. The lag length p has been chosen to minimize the Schwarz criterion, and standard specification tests have been performed. As we refrained from using dummy variables to ensure the normal distribution, this assumption has been violated in all cases. The assumptions of absence of autocorrelation and of homoskedasticity of the residuals, in contrast, were met in most of the cases.

The model has been estimated in levels and using 6 lagged variables of the claims of German banks abroad, bilateral trade, the German deposit rate, and the capitalization of German banks. From this model, impulse responses for 24 period were calculated, using the Choleski-decomposition of the covariance matrix with the German variables (deposit rate, capitalization) being ordered first, implying that these variables have an effect on the foreign variables (claims of German banks, trade), while themselves being unaffected by developments abroad. This as-

sumption has proven not to be crucial, however, as the results have been relatively insensitive to the ordering of the domestic versus the foreign variables.

Graph 7 presents the responses of foreign claims of German banks to an increase in the German deposit rate and in the capitalization of German banks. The results are similar to those obtained for the long-run coefficients estimated above, but not the same. The most stable results are obtained for Austria where foreign lending declines if the costs of refinancing rise and increases if the capitalization of German banks improves. The positive response to a change in the capitalization is also found for Denmark and Finland. For Ireland, however, the response to an improvement in the capitalization of German banks is a decline in the lending of German banks, which is at odds with the positive long-run response found above. Generally, the results for Ireland are the least stable as also the interest rate coefficient is positive (rather than negative). For Finland, the positive response to changes in the German deposit rate is confirmed while for Denmark we find hardly any effect.

5 Conclusions and Outlook for Future Research

In recent policy discussions on the welfare implications of financial market integration, the potential costs in terms of negative spill-over effects of financial crises have been stressed. Innocent by-standers might fall victim to financial crises elsewhere simply because there are strong (financial) market linkages between the two regions. Although there are also important economic benefits that can be reaped through increased financial integration, the adverse consequences for the real economy often may appear to necessitate a more restrictive policy towards financial liberalization. From a policy perspective, these issues may seem the most relevant for developing countries which do actually still have a degree of freedom in choosing whether to liberalize the capital account of their balance of payments. For developed market economies, which have practically dismantled capital account restrictions altogether, the issue may seem less relevant. Yet, even here, policymakers might consider alternative policy instruments to cushion adverse shocks of financial crises.

This paper has started by reviewing a small theoretical framework which showed that the spill-over effects of regional financial shocks are a non-linear function of the degree of financial openness. Under financial autarky, financial crises are restricted to the region in which they originate. As countries start integrating financially but remain incompletely diversified, financial crises might spread into nearby regions. This risk must be weighted against the positive effect that integration has for inter-regional risk-sharing. Under perfect financial integration, however, financial shocks are likely to spread more evenly across regions, and financial crises might be avoided altogether.

The degree of financial integration and the implications for the regional effects of financial shocks are particularly important for Europe. The financial markets of the members of Euroland are, on the one hand, likely to be less integrated interregionally than the regions forming national monetary unions. The introduction of the Euro and the creation of a Single Market for capital are, on the other hand, commonly believed to have promoted the integration of financial markets within Europe. Hence, regional financial shocks are likely to become less severe over time.

Showing the changing degree of integration of markets and the importance of bilateral financial linkages, however, has proven to be a difficult task. Recent data on the allocation of financial assets of EU countries has shown that the bulk of assets is held within the Euro area. Also, the degree of openness of financial systems of the EU countries has increased over the past decades. This might suggest that the potential for spill-over effects within the region are large. Compared to total domestic credit, bilateral financial linkages among EU countries, however, still remain small. The notable exception are claims of Germany as the largest creditor in Euroland on a number of smaller member countries.

Similar to the evidence on the transmission of shocks in the Japanese economy to the US through the lending activities of US banks, we find that German shocks have been transmitted through banks' foreign activities to smaller EU member countries such as Austria, Denmark, Finland, and Ireland. An increase in the degree of capitalization of German banks, for instance, often causes an expansion of lending abroad. Similarly, changing liquidity conditions as reflected in changes in domestic deposit rates have effects on the foreign lending activities of German banks. We also find a close correlation between bilateral foreign trade and financial linkages. Due to the close correlation of these two variables to general demand conditions, however, domestic and foreign factors could not be isolated.

There are a number of dimensions along which the present study could be extended. An obvious extension would be to include evidence on larger EU member countries to show whether the determinants of German banks' activities differ between larger and smaller countries. One hypothesis that could be tested is whether activities in larger host countries are more likely to be driven by host- rather than home-country factors than activities in smaller countries. Also, in view of the on-going integration process, time varying parameters could be allowed for. In addition, bank-level data could help to isolate macro- from microeconomic, bank-specific factors that determine international lending decisions. Finally, we have considered the international lending activities of commercial banks as a transmission channel only. An obvious extension would be to analyze links between different types of capital flows and to check how transmission effects might get magnified or mitigated by changes in other capital account items.

6 References

- Aghion, P., P. Bacchetta, and A. Banerjee (2000). Currency Crises and Monetary Policy in an Economy with Credit Constraints. Harvard University, University of Lausanne, and MIT. Mimeo.
- Aizenman, J. (1998). Capital Mobility in a Second Best World — Moral Hazard with Costly Financial Intermediation. National Bureau of Economic Research (NBER). Working Paper 6703. Cambridge, MA.
- Allen, F., and D. Gale (2000a). *Comparing Financial Systems*. The MIT Press. Cambridge (MA) and London.
- Allen, F., and D. Gale (2000b). Financial Contagion. *The Journal of Political Economy* 108 (1): 1–33.
- Armstrong, H.W., V.N. Balasubramanyam, and M.A. Salisu (1996). Domestic savings, international and intra-European Union capital flows, 1971–1991. *European Economic Review* 40 (6): 1229–1235.
- Artis, M.J., and W. Zhang (1998). The Linkages of Interest Rates Within the EMS. *Weltwirtschaftliches Archiv* 134 (1): 117–132.
- Bakker, A.F.P. (1994). *The Liberalization of Capital Movements in Europe*. Amsterdam.
- Bank for International Settlements (BIS) (2001). *Quarterly Review: International Banking and Financial Market Developments*. February. Basle.
- Barth, J.R., G. Caprio Jr., and R. Levine (2001). The Regulation and Supervision of Banks Around the World — A New Database. http://www.worldbank.org/research/projects/bank_regulation.htm
- Bayoumi, T., L. Sarno, and M.P. Taylor (1999). European Capital Flows and Regional Risk. *The Manchester School* 67 (1): 39–59.
- Berger, A.N., R. DeYoung, H. Genay, and G.F. Udell (2000a). Globalization of Financial Institutions: Evidence from Cross-Border Banking Performance. *Brookings-Wharton Papers on Financial Services* 3: 23–158.
- Berger, A.N., R. DeYoung, and G.F. Udell (2000b). Efficiency Barriers to the Consolidation of the European Financial Services Industry. *European Financial Management* 6 (forthcoming).
- Berger, A.N., and R. DeYoung (2001). The Effects of Geographic Expansion on Bank Efficiency. *Journal of Financial Services Research* (forthcoming).
- Bikker, J.A., and J.M. Groeneveld (2000). Competition and Concentration in the EU Banking Industry. *Kredit und Kapital* 33(1): 62–98.
- Bordo, M.D., B. Eichengreen, and J. Kim (1998). Was There Really an Earlier Period of International Financial Integration Comparable to Today?. National Bureau of Economic Research (NBER). Working Paper 6738. Cambridge, MA.
- Bordo, M.D., and A.P. Murshid (2000). Are Financial Crises Becoming Increasingly More Contagious? What is the Historical Evidence on Contagion? National Bureau of Economic Research. Working Paper 7900. Cambridge, MA.
- Buch, C.M. (2000). Information or Regulation: What is Driving the International Activities of Commercial Banks? *Kiel Working Paper* 1011. Kiel Institute of World Economics, Kiel.

- Buch, C.M. (2001). Distance and International Banking. Kiel Institute of World Economics. Working Paper. Kiel. mimeo.
- Buch, C.M. and S.M. Golder (2001). Foreign versus Domestic Banks in Germany and the US: A Tale of Two Markets? *Journal of Multinational Financial Management*. Forthcoming.
- Buch, C.M. and R.P. Heinrich (1999). Handling Banking Crises — The Case of Russia. *Economic Systems* 23 (4): 349–380.
- Buch, C.M. and S. Lapp (2000). Bank Portfolios in Euroland. In T. Moser and B. Schips (eds.), *EMU, Financial Markets, and the World Economy*. Kluwer Academic Publishers: 109–142.
- Buch, C.M. and C. Pierdzioch (2001). The Growth and the Volatility of International Capital Flows: Reconciling the Evidence. In H. Siebert (ed.), *The World's New Financial Landscape: Challenges for Economic Policy*. Forthcoming.
- Calcagnini, G., F. Farabullini, and D.D. Hester (2000). Financial Convergence in the European Monetary Union?. Universita di Urbino, Banca d'Italia, and University of Wisconsin. Mimeo.
- Casu, B., and P. Molyneux (2000). A Comparative Study of Efficiency in European Banking. School of Accounting, Banking and Economics. University of Wales (Bangor). mimeo.
- Centeno, M., and A.S. Mello (1999). How Integrated are the Money Market and the Bank Loans Market Within the European Union? *Journal of International Money and Finance* 18: 75–106.
- Céspedes, L.F., R. Chang, and A. Velasco (2000). Balance Sheets and Exchange Rate Policy. National Bureau of Economic Research (NBER). Working Paper 7840. Cambridge, MA.
- Chelley-Steeley, P.L., and J.M. Steeley (1999). Changes in the Comovement of European Equity Markets. *Economic Inquiry* 37 (3): 473–488.
- Chelley-Steeley, P.L., J.M. Steeley, and E.J. Pentecost (1998). Exchange Controls and European stock market integration. *Applied Economics* 30: 263–267.
- Coval, J.D., and T.J. Moskowitz (1999). Home Bias as Home: Local Equity Preference in Domestic Portfolios. *The Journal of Finance* LIV (6): 2045–2073.
- Danthine, J.-P., F. Giavazzi and E.-L. von Thadden (2000). European financial markets after EMU: a first assessment. Centre for Economic Policy Research (CEPR). Discussion paper 2413. London.
- De Bandt, O., and P. Hartmann (2000). Systemic Risk: A Survey. Centre for Economic Policy Research. Discussion Paper 2634. London.
- Deutsche Bundesbank (2000). *Zahlungsbilanzstatistik*. Frankfurt am Main.
- Deutsche Bundesbank (2001). *Zahlungsbilanzstatistik*. Frankfurt am Main.
- Diamond, D., and D. Dybvig (1983). Bank runs, deposit insurance, and liquidity. *Journal of Political Economy* 91 (3): 401–419.
- Eichengreen, B., and A. Mody (2000). Lending booms, reserves and the sustainability of short-term debt: inferences from the pricing of syndicated bank loans. *Journal of Development Economics* 63 (1): 5–44.
- Engle, R.F., and C.W.J. Granger (1987). Co-Integration and Error Correction: Representation, Estimating and Testing. *Econometrica* 55: 251–276.

- European Central Bank (ECB) (1999). *Possible Effects of EMU on the EU Banking Systems in the Medium to Long Term*. Frankfurt a.M.
- European Central Bank (ECB) (2000). *Mergers and Acquisitions Involving the EU Banking Industry — Facts and Implications*. December. Frankfurt a.M.
- European Commission (EU) (1997). *Credit Institutions and Banking*. The Single Market Review. Subseries 2. Vol. 3. Office for Official Publications of the European Communities. Luxembourg.
- Favero, C.A., and A. Bonfiglioli (2000). Measuring Co-movements Between US and European Stock Markets. IGIER Working Paper No. 165. Milano.
- Favero, C.A., and F. Giavazzi (2000). Looking for Contagion: Evidence from the ERM. National Bureau of Economic Research. NBER Working Paper 7797. Cambridge, MA.
- Forbes, K., and R. Rigobon (2000a). Contagion in Latin America: Definitions, Measurement, and Policy Implications. National Bureau of Economic Research. Working Paper 7885. Cambridge, MA.
- Forbes, K., and R. Rigobon (2000b). No Contagion, Only Independence: Measuring Stock Market Co-movements. MIT Sloan School of Management and NBER. Mimeo.
- Fratzscher, M. (2001). Financial Market Integration in Europe: On the Effects of EMU on Stock Markets. European Central Bank. Working Paper 48. March. Frankfurt a.M.
- Freixas, X., B.M. Parigi, and J.-C. Rochet (2000). Systemic Risk, Interbank Relations, and Liquidity Provision by the Central Bank. *Journal of Money, Credit, and Banking* 32(3): 611–638.
- Gehrig, T. (1993). An information based explanation of the domestic bias in international equity investment. *The Scandinavian Journal of Economics* 95 (1): 97–109.
- Grinblatt, M., and M. Keloharju (2000). Distance, Language, and Culture Bias: The Role of Investor Sophistication. Yale International Center for Finance. Yale ICF Working Paper 00-04.
- Hansen, H., and K. Juselius (1995). *Cats in Rats — Cointegration Analysis of Time Series*. Estima, Evanston.
- Hassler, U. (2001a). Leitfaden zum Testen und Schätzen von Kointegration. In W. Gaab, U. Heilemann, and J. Wolters (eds.), *Arbeiten mit ökonomischen Modellen*. Physica (Heidelberg). Forthcoming.
- Hassler, U. (2001b). The Effects of Linear Time Trends on the KPSS Test for Cointegration. *Journal of Time Series Analysis*. Forthcoming.
- Heinkel, R.L., and M.D. Levi (1992). The Structure of International Banking. *Journal of International Money and Finance* 11: 251–272
- Holmes, M.J., and E.J. Pentecost (1999). A New Test of International Financial Integration with Application to the European Union. *Journal of Economic Integration* 14 (1): 1–12.
- Houpt, J.V. (1999). International Activities of U.S. Banks and in U.S. Banking Markets. *Federal Reserve Bulletin* 85(9): 599–615.
- International Monetary Fund (IMF) (1999a). *Direction of Trade Statistics Yearbook*. Washington DC.

- International Monetary Fund (IMF) (1999b). *Results of the 1997 Coordinated Portfolio Investment Survey*. Washington DC.
- International Monetary Fund (IMF) (2001). *International Financial Statistics*. Washington DC.
- Johansen, S. (1988). Statistical Analysis of Cointegration Vectors. *Journal of Economic Dynamics and Control*: 132–254.
- Johansen, S., and K. Juselius (1990). Maximum Likelihood Estimation and Inference on Cointegration — with Applications to the Demand for Money. *Oxford Bulletin of Economics and Statistics* 52 (2): 169–210.
- Kellermann, K., and C.-H. Schlag (1999). Eine Untersuchung der Ersparnis-Investitions-Korrelation in Deutschland. *Zeitschrift für Wirtschafts- und Sozialwissenschaften* 119 (1): 99–121.
- Kalemli-Ozcan, S., B.E. Sorensen, and O. Yosha (2000). Risk Sharing and Industrial Specialization: Regional and International Evidence. Federal Reserve Bank of Kansas City. Research Division. Working Paper RWP 00-06.
- Kraay, A., N. Loayza, L. Serven, and J. Ventura (2000). Country Portfolios. National Bureau of Economic Research (NBER). Working Paper 7795. Cambridge, MA.
- Kueppers, M. (2000). Curtailing the Black Box: German Banking Groups in the Transmission of Monetary Policy. *European Economic Review* (forthcoming).
- Kwiatkowski, D., P.C.B. Phillips, P. Schmidt, and Y. Shin (1992). Testing the Null Hypothesis of Stationarity Against the Alternative of a Uni Root. *Journal of Econometrics* 54: 159–178.
- Lane, P.R., and G.M. Milesi-Ferretti (2001). External Capital Structure: Theory and Evidence. In: Siebert, H. (ed.) *The World's New Financial Landscape: Challenges for Economic Policy*. Tuebingen (Mohr). forthcoming.
- Lapp, S. (2001). Anlageentscheidungen deutscher Investoren. Unpublished PhD-Thesis.
- Lemmen, J. (1998). *Integrating Financial Markets in the European Union*. Cheltenham and Northampton (Edward Elgar).
- Lewis, K.K. (1999). Trying to Explain the Home Bias in Equities and Consumption. *Journal of Economic Literature* 37: 571–608.
- Linne, T. (1999). Contagion effects of Central and East European currency crises. Diskussionspapiere 96. Institut fuer Wirtschaftsforschung, Halle.
- MacKay, R.R., and P. Molyneux (1998). Bank Finance and the Regions: A European Perspective. In S. Hill, and B. Morgan (eds.), *Inward Investment, Business Finance and Regional Development*. Macmillan: 186–196.
- MacKinnon, J.G. (1991). Critical Values for Cointegration Tests. Chapter 13 in *Long-run Economic Relationships: Readings in Cointegration*, ed. by R.F. Engle and C.W.J. Granger, Oxford University Press.
- Maddala, G.S., and I.-M. Kim (1999). *Unit Roots, Cointegration, and Structural Change*. Cambridge University Press.
- Molyneux, P., D.M. Lloyd-Williams, and J. Thornton (1994). Competitive Conditions in European Banking. *Journal of Banking and Finance* 18(3): 445–459.

- Monticelli, C. (1996). EU-Wide Money and Cross-Border Holdings. *Weltwirtschaftliches Archiv* 132 (2): 215–235.
- Mussa, M., A. Swoboda, J. Zettelmeyer, and O. Jeanne (1999). Moderating Fluctuations in Capital Flows to Emerging Market Economies. Paper presented on the Conference on Key Issues in Reform of the International Monetary and Financial System, May 28-29, 1999. Mimeo.
- Obstfeld, M. (1995). International Capital Mobility in the 1990s. In P.B. Kenen (ed.), *Understanding Interdependence — The Macroeconomics of the Open Economy*. Princeton, New Jersey.
- Organisation for Economic Cooperation and Development (OECD) (2000a). *Bank Profitability – Financial Statements of Banks* (CD-Rom). Paris.
- Organisation for Economic Cooperation and Development (OECD) (2000b). *International Direct Investments* (CD-Rom). Paris.
- Ostergaard, C. (2000). External Financing Costs and Banks' Loan Supply: Does the Structure of the Bank Sector Matter. Financial Markets Group. London School of Economics. August. Mimeo.
- Pastor, J.T., A. Lozano-Vicas, and I. Hasan (2000). Cross-Border Performance in European Banking. New York University Salomon Center. Working paper S-00-14. New York.
- Peek, J. and E. S. Rosengren (1997). The International Transmission of Financial Shocks: The Case of Japan. *American Economic Review* 87 (4): 495–505.
- Peek, J., and E.S. Rosengren (2000). Collateral Damage: Effects of the Japanese Bank Crisis on Real Activity in the United States. *American Economic Review* 90 (1): 30–45.
- Portes, R., and H. Rey (1999). The Determinants of Cross-Border Equity Flows. National Bureau of Economic Research. Working Paper 7336. Cambridge MA.
- Portes, R., H. Rey, and Y. Oh (2001). Information and Capital Flows: The Determinants of Transactions in Financial Assets. *European Economic Review* (Papers and Proceedings). forthcoming.
- Reisen, H. (2000). *Pensions, Savings and Capital Flows*. Edward Elgar (Cheltenham and Northampton).
- Rigobon, R. (2000). Identification through Heteroskedasticity: Measuring “Contagion” Between Argentinean and Mexican Sovereign Bonds. National Bureau of Economic Research. Working Papers 7493. Cambridge, MA.
- Ross, S.M. (2000). *An Introduction to Mathematical Finance — Options and Other Topics*. Cambridge University Press.
- Saikkonen, P. (1991). Asymptotically Efficient Estimation of Cointegration Regressions. *Econometric Theory* 7: 1–21.
- Shin, Y. (1994). A Residual-Based Test of the Null of Cointegration Against the Alternative of No Cointegration. *Econometric Theory* 10: 91–115.
- Stirboeck, C. and F. Heinemann (1999). Capital Mobility within EMU. ZEW, Zentrum fuer Europaeische Wirtschaftsforschung GmbH. Discussion paper 99-19. Mannheim.
- Stock, J.H. (1987). Asymptotic Properties of Least Squares Estimators of Cointegration Vectors. *Econometrica* 55: 113–144.

- Stock, J.H., and M.W. Watson (1993). A Simple Estimator of Cointegrating Vectors in Higher Order Integrated Systems. *Econometrica* 61: 783–820.
- Taylor, A.M. (1996). International Capital Mobility in History: The Savings-Investment Relationship. National Bureau of Economic Research. Working Paper 5743. Cambridge, MA.
- Tesar, L.L., and I.M. Werner (1992). Home Bias and Globalization of Securities. National Bureau of Economic Research. NBER Working Paper 4218. Cambridge, MA.
- Van Rijckeghem, C., and B. Weder (2000). Spillovers Through Banking Centers: A Panel Data Analysis. International Monetary Fund. Working Paper 00/88. Washington DC.
- Wei, S.-J., and Y. Wu (2001). Negative Alchemy? Corruption, Composition of Capital Flows, and Currency Crises. National Bureau of Economic Research. Working Paper 8187. Cambridge, MA.
- ter Wengel, J. (1995). International trade in banking services. *Journal of International Money and Finance* 14(1): 47–64.
- Winker, P. (1996). A Macroeconomic Disequilibrium Model of the German Credit Market. Universitaet Konstanz. Sonderforschungsbereich 178 “Internationalisierung der Wirtschaft”. Diskussionsbeitraege 302. Konstanz.
- The World Bank (2001). *Financial Structure and Economic Development Database*. <http://www.worldbank.org/research/interest/data.htm>

The Data

Capital: log of capital accounts of German banks based on the IFS-banking survey, million national currency, rate of capitalization calculated as the share of capital in total assets (net foreign assets plus domestic credit); all data are based on national, not EU-wide, residency, capital of foreign subsidiaries is not included. Source: IMF (2001)

Cross-border assets: balance of payments statistics of the Deutsche Bundesbank (Aussenwirtschaftliche Bestandsstatistik), covering external assets of German domestic banks, their foreign subsidiaries and branches, broken down into short- and long-term items and claims on banks and non-banks. In million D-Mark, Source: Deutsche Bundesbank (2001). Unpublished monthly data have been provided by the Deutsche Bundesbank. The data have been corrected manually for large individual outliers as well as the following structural breaks: 98:2 (claims of domestic banks on banks in Denmark), 93:2 (claims of subsidiaries on banks in Austria), 92:6, 92:9, 97:2 (claims of subsidiaries on non-banks in Austria), 97:1, 97:9 (claims of subsidiaries on banks in Finland), 95:12 (claims of subsidiaries on banks and non-banks in Ireland), 97:17 (claims of branches on banks and non-banks in Ireland), 97:12 (claims of domestic banks in Ireland). Data after 99:1 have been converted from euro into D-mark.

Domestic credit: log of total domestic credit based on the banking survey (Denmark: monetary survey), million national currency. Source: IMF (2001)

Economic sentiment indicator: published by the European Commission, seasonally adjusted and retrieved via Datastream, SENT = domestic sentiment indicators, SENT* = German sentiment indicator (in logs)

Interest rates: German deposit rate and US T-bill rate. Source: IMF (2001)

Regulatory dummies: Unification (set equal to 1 for the time after June 1990), Second Banking Directive (set equal to 1 for the time after January 1992), Euro (set equal to 1 for the time after January 1999)

Trade: Sum of bilateral exports and imports for Germany divided by two, in million USD, Source: IMF (1999a)

All data in national currencies or US-Dollar have been converted into D-Mark using cross-rates vis-à-vis the USD and into constant prices with the German consumer prices index and have been seasonally adjusted using the X11-method implemented in EViews. Structural breaks in the data were corrected manually as follows: banks' balance sheets: January 1999 for Germany, January 1995 for Ireland. In addition, single missing values have been extrapolated.

Table 1 — Regional Liquidity Shocks

	<i>A</i>	<i>B</i>	<i>C</i>	<i>D</i>
S_1	w_H	w_L	w_H	w_L
S_2	w_L	w_H	w_L	w_H
\bar{S}	$g + e$	g	g	g

Source: Allen and Gale (2000b)

Table 2 — Openness of Banking System Towards Foreign Competition

	EU	Euroland	Developed countries	High income	Upper middle income	Lower middle income	Lower income
Limitations on foreign bank ownership of domestic banks	0.00	0.00	0.08	0.17	0.44	0.19	0.14
Limitations on entry of foreign banks	0.00	0.00	0.04	0.07	0.11	0.24	0.14
Bank concentration ratio	59.19	56.17	60.92	63.75	66.48	72.35	72.91
Foreign bank ownership	16.29	19.97	24.81	33.57	31.72	33.75	33.59
Government –owned banks	9.98	12.97	10.27	10.28	12.32	28.32	35.36
No entry applications	0.00	0.00	0.04	0.09	0.14	0.13	0.00
Domestic	0.21	0.27	0.24	0.31	0.25	0.30	0.11
Foreign	0.08	0.10	0.08	0.16	0.30	0.43	0.22
Fraction of entry applications denied	3.67	3.23	3.21	7.69	11.99	32.22	49.32
Domestic	5.42	3.37	2.13	7.16	8.33	28.04	79.82
Foreign	1.67	2.22	3.21	6.91	16.85	30.83	37.85

All variables are averages by income level or region, respectively. Bank concentration ratio = fraction of deposits held by the five largest banks. Foreign bank ownership = fraction of banking system's assets that are 50 percent or more foreign-owned. Government-owned banks = fraction of banking system's assets that are 50 percent or more government-owned. No entry applications = dummy variable which assigns a one if applications for licenses have been received in the past 5 years. Fraction of entry applications denied = fraction of applications denied in the past 5 years.

Source: Barth et al. (2001)

Table 3 — Correlations of Liquidity Shocks

a) Correlations of Changes in Deposits, 1993–1998

	AUT	BEL	DNK	FIN	FRA	GER	GRE	ILR	ITA	LUX	NET	PRT	ESP	SWE	UK	US	JAP
BEL	0.58*																
DNK	0.28	-0.03															
FIN	0.65*	0.19	0.20														
FRA	0.74*	0.14	0.27	0.75*													
GER	0.68*	0.22	0.48*	0.63*	0.83*												
GRE	0.22	-0.16	-0.04	0.31	0.51*	0.43*											
IRL	0.06	0.11	-0.14	0.22	-0.01	-0.19	-0.29										
ITA	0.71*	0.44*	0.26	0.56*	0.75*	0.83*	0.45*	-0.14									
LUX	-0.15	0.08	0.05	-0.35*	-0.13	-0.02	-0.45*	-0.51*	-0.10								
NET	0.08	-0.16	0.38*	0.10	0.02	0.00	-0.18	0.10	-0.09	0.00							
PRT	0.37*	0.31	-0.17	0.41*	0.59*	0.53*	0.29	-0.02	0.49*	0.09	-0.34						
ESP	0.43*	0.09	0.29	0.42*	0.58*	0.63*	0.55*	-0.05	0.69*	-0.31	0.04	0.35*					
SWE	0.63*	0.71*	0.26	0.30	0.38*	0.53*	0.11	-0.02	0.59*	-0.01	-0.15	0.15	0.22				
UK	0.05	-0.04	0.08	0.14	-0.17	-0.08	-0.42*	0.10	-0.20	0.14	0.35*	-0.22	-0.14	0.02			
US	0.56*	0.31	0.51*	0.51*	0.66*	0.73*	0.41*	-0.32	0.70*	0.06	0.08	0.39*	0.55*	0.49*	-0.12		
JAP	0.20	0.08	-0.04	0.51*	0.49*	0.46*	0.15	0.11	0.48*	0.01	0.02	0.37*	0.47*	0.28	-0.04	0.32	
EU-Ø	0.33	0.15	0.17	0.29	0.27	0.35*	0.12	-0.01	0.34	-0.03	-0.04	0.13	0.22	0.19	-0.01	0.30	0.22

The Table shows the correlation between quarterly changes in real deposits (demand, time, and savings deposits, IFS lines 24 plus 25, deflated by the domestic consumer prices index) for country pairs for the years 1993 (QI) through 1998 (QIV). Because of structural breaks in the data for the members of Euroland, data for more recent periods have not been taken into account. * = significant at the 5 percent level (critical value = $\pm 2/\sqrt{n} = 0.35$)

b) Change in correlation coefficients

	AUT	BEL	DNK	FIN	FRA	GER	GRE	ILR	ITA	LUX	NET	PRT	ESP	SWE	UK	US	JAP
BEL	0.41																
DNK	-0.26	-0.23															
FIN	0.10	0.04	-0.22														
FRA	0.46	-0.01	0.25	0.51													
GER	-0.05	0.19	-0.06	0.01	0.62												
GRE	-0.06	0.02	-0.24	0.14	0.40	0.10											
IRL	-0.22	0.11	-0.20	0.16	-0.13	-0.42	-0.53										
ITA	-0.09	0.28	-0.25	0.01	0.43	0.06	0.13	-0.40									
LUX	-0.31	-0.04	-0.16	-0.76	-0.37	-0.31	-0.49	-0.66	0.24								
NET	0.38	-0.51	0.64	0.35	-0.04	0.43	0.19	0.28	0.33	-0.02							
PRT	0.34	0.23	-0.08	0.50	0.58	0.55	0.15	0.02	0.36	0.10	-0.37						
ESP	-0.03	-0.11	-0.03	0.02	0.41	0.08	0.28	-0.24	-0.24	-0.49	0.30	0.31					
SWE	0.17	0.55	0.05	0.01	0.10	0.20	0.11	-0.06	0.03	-0.16	-0.03	0.01	0.13				
UK	-0.03	-0.11	0.01	-0.04	-0.18	-0.21	-0.42	0.08	-0.25	-0.01	0.41	-0.17	-0.26	0.13			
US	0.01	0.27	0.02	-0.06	0.58	0.03	0.06	-0.39	-0.11	-0.17	0.40	0.36	0.23	0.34	-0.10		
JAP	-0.27	-0.22	-0.54	0.02	0.31	-0.13	-0.33	-0.06	-0.04	-0.22	0.19	0.33	0.07	0.13	-0.19	-0.23	
EU-Ø	0.01	0.04	-0.01	0.06	0.13	0.09	0.02	-0.09	0.07	-0.18	0.10	0.11	0.02	0.04	-0.05	0.06	-0.06

Difference between the correlation coefficients for the years 1993 (QI)-1998 (QIV) and 1970 (Q1)-1992(QIV). A positive number indicates that changes in deposits have become more closely correlated.

Table 4 — Structure of German Capital Flows (%) 1971–2000

	Gross inflows			Gross outflows		
	1971–1992	1992–2000	1971–2000	1971–1992	1992–2000	1971–2000
	<i>All countries</i>					
FDI	7.9	18.2	15.7	18.7	26.5	23.8
Portfolio	33.4	40.1	38.5	20.4	43.9	35.8
Bank credit	58.9	41.7	45.9	60.8	29.5	40.4
	<i>Non-EU industrialized countries</i>					
FDI	10.2	12.3	11.6	29.5	36.9	34.6
Portfolio	42.2	42.2	42.2	29.5	36.8	34.4
Bank credit	47.5	45.5	46.1	40.6	26.2	30.8
	<i>EU-12 industrialized countries</i>					
FDI	7.9	22.1	19.4	18.3	18.7	18.6
Portfolio	33.6	40.2	38.9	19.6	52.3	42.5
Bank credit	58.4	37.7	41.6	62.0	28.9	38.8

Source: Deutsche Bundesbank (2001), own calculations.

Table 5 — Financial Market Linkages in Europe (% of Total Assets Held in EU Countries)

	Stock of outward FDI (1997) ¹	Portfolio investments (1997)				Bank lending (1999)	Trade (1998)
		Equity	Debt (long-term)	Debt (short-term)	Total		
Austria	41.7	58.2	59.2	...	58.9	45.2	66.1
Belgium	...	88.1	67.2	35.2	73.4	75.3	73.7
Denmark	...	53.3	71.1	...	62.1	69.2	69.6
Finland	66.4	66.2	60.0	46.9	61.0	65.9	56.5
France	49.7	49.8	58.5	...	55.6	53.7	61.9
Germany	52.1	56.2	54.6
Greece	60.1
Ireland	...	43.3	68.2	...	58.7	74.7	61.0
Italy	...	61.9	29.9	52.2	40.2	63.8	59.1
Netherlands	45.8	38.1	77.6	...	56.9	56.7	51.3
Portugal	40.0	60.4	53.8	31.7	55.0	...	79.1
Spain	...	55.8	50.9	...	53.2	51.8	67.7
Sweden	58.0	51.3	56.8	47.2	52.4	59.0	59.6
United Kingdom	42.0	38.6	44.3	16.4	40.8	34.9	49.9
<i>Memorandum</i>							
United States	42.8	53.1	35.1	...	47.5	48.9	20.5

1) Denmark: 1994.

Sources: BIS (2001), IMF (1999a, 1999b), OECD (2000b), own calculations.

Table 6 — Cross-Border Banking Assets in % of Domestic Credit (Based on EU-wide Residency), end-1999

Country B	Country A														
	Austria	Belgium	Denmark	Finland	France	Germany	Greece	Ireland	Italy	Luxembourg	Netherlands	Portugal	Spain	Sweden	UK
Austria		0.4	0.9	0.5	0.2	0.5	1.0	1.5	0.5	1.6	0.5	0.4	0.1	0.3	0.6
Belgium	1.8		4.3	1.7	2.0	1.1	1.0	8.1	2.5	14.1	3.6	1.8	1.0	1.0	3.0
Denmark	0.0	0.2		1.9	0.1	0.2	0.0	2.2	0.1	5.1	0.1	0.0	0.0	2.4	0.5
Finland	0.1	0.2	0.9		0.0	0.1	0.2	0.3	0.1	0.3	0.1	0.1	0.0	2.9	0.2
France	2.9	8.0	2.6	3.9		2.2	7.9	4.2	6.1	12.8	4.0	2.8	3.1	1.7	4.6
Germany	13.5	7.3	14.9	15.2	5.3		12.5	24.4	9.4	65.1	10.3	9.2	6.1	7.5	10.7
Ireland	0.2	0.1	0.7	0.2	0.1	0.1			0.1	0.2	0.2	0.0	0.1	0.2	1.1
Italy	1.2	1.9	0.9	0.4	1.4	0.5	3.3	3.8		12.9	1.5	5.1	0.6	0.5	2.3
Netherlands	2.2	6.8	4.6	3.2	1.3	1.2	3.8	3.1	2.6	3.5		1.9	1.1	2.2	2.8
Spain	0.5	0.8	0.7	0.6	0.8	0.5	1.7	1.6	1.1	2.2	0.7	2.1		0.3	0.9
Sweden	0.2	0.3	5.0	6.4	0.1	0.1	0.2	0.4	0.1	0.8	0.3	0.1	0.0		1.1
UK	2.3	3.9	4.4	1.8	2.0	1.0	5.9	6.7	2.4	2.7	2.9	1.7	1.3	2.9	
EU total	24.8	29.8	39.8	35.6	13.3	7.4	37.6	56.3	25.1	121.3	24.1	25.3	13.4	21.8	27.8
US	1.0	2.7	5.3	2.2	1.5	1.0	3.1	2.2	2.0	2.9	3.8	0.5	0.7	1.7	3.3
Japan	1.3	1.4	3.0	2.9	2.2	1.9	1.5	6.3	1.2	7.0	2.9	0.6	0.9	2.0	4.7
Total	33.3	50.5	70.0	49.1	26.6	19.5	63.4	79.2	37.0	141.4	41.0	35.0	20.3	33.4	49.2

Reports cross-border claims of banks in Country B in percent of domestic credit in Country A

Source: IMF (2001), BIS (2001), own calculations.

Table 7 — Structure of Foreign Assets and Liabilities of German Banks 1984–2000

	1984	1990	1995	2000
	Share of domestic banks in foreign assets (%)			
EU	50.3	53.7	42.6	46.6
Austria	56.8	65.0	46.7	71.2
Denmark	62.1	53.0	59.5	60.6
Finland	53.2	62.6	55.0	48.8
Ireland	71.1	56.2	59.7	50.4
	Share of foreign branches in foreign assets (%)			
EU	29.5	25.7	34.6	37.9
Austria	17.6	15.3	24.7	15.6
Denmark	14.6	24.9	18.2	28.9
Finland	20.9	19.9	24.5	30.9
Ireland	21.1	22.7	26.1	30.9
	Share of lending to non-banks (%)			
EU	37.6	30.8	35.3	53.1
Austria	21.1	13.4	45.4	62.4
Denmark	67.3	35.6	62.6	56.8
Finland	43.4	26.7	79.8	92.3
Ireland	92.9	89.0	58.8	40.3
	Share of short-term lending (%)			
EU	65.3	70.0	65.5	54.4
Austria	62.7	77.0	52.9	35.7
Denmark	25.1	66.3	35.1	42.4
Finland	52.8	59.7	22.0	27.3
Ireland	9.9	19.5	43.3	55.1

German Banks = domestic banks plus foreign subsidiaries and foreign branches.

Source: Deutsche Bundesbank (2001), own calculations

Table 8 — Unit Root Tests

	Level		First Difference	
	Test specification	ADF-Statistic	Test specification	ADF-Statistic
	log (claims of German domestic banks)			
Austria	CT6	-1.02	C03	-5.63***
Denmark	CT2	-0.56	C01	-11.56***
Finland	C02	-2.08	C02	-10.08***
Ireland	CT1	-2.32	C01	-10.92***
	log (claims of German branches)			
Austria	CT3	-1.95	C03	-8.36***
Denmark	C01	-1.27	002	-8.84***
Finland	C02	-2.94**	C01	-12.65***
Ireland	CT1	-2.00	C02	-8.60***
	log (claims of German subsidiaries)			
Austria	CT4	-1.63	C04	-8.19***
Denmark	C02	-2.38	001	-8.79***
Finland	CT2	-2.02	C02	-9.86***
Ireland	CT1	-2.02	C00	-13.11***
	log (bilateral trade)			
Austria	CT4	-2.65	C04	-8.17***
Denmark	CT6	-3.10	C02	-8.91***
Finland	CT2	-2.59	C01	-15.95***
Ireland	CT4	-3.11	C03	-10.56***
	Germany			
log (capital)	C01	-0.98	C04	-5.19***
capitalization	C01	-0.67	C00	-14.18***
deposit rate	C01	-1.07	000	-6.81***

Reports augmented Dickey-Fuller unit root tests. Time period: 1985:1–2000:12. ***(**,*) denotes rejection of the hypothesis of a unit root at the 1(5,10) percent level. Test specification: constant, trend, number of lags of the endogenous variable. Critical values are taken from MacKinnon (1991).

Table 9 — Engle-Granger Cointegration Tests

	Baseline specification		Including dummies	
	Number of lags	ADF-statistic	Number of lags	ADF-statistic
<i>Austria</i>				
Domestic banks	3	0.27	3	-8.80***
Branches	3	-1.78	3	-2.81
Subsidiaries	3	-1.93	3	-3.54
Domestic credit	3	-3.51	3	-3.21
<i>Denmark</i>				
Domestic banks	4	-0.99	4	-3.02
Branches	2	-1.08	2	-2.32
Subsidiaries	4	-2.48	4	-3.38
Domestic credit	2	-0.47	2	-3.25
<i>Finland</i>				
Domestic banks	4	-3.37	4	-3.63
Branches	2	-3.55	2	-3.62
Subsidiaries	2	-3.02	2	-3.74
Domestic credit	2	-3.09	2	-3.70
<i>Ireland</i>				
Domestic banks	4	-3.10	4	-3.32
Branches	4	-2.26	4	-2.74
Subsidiaries	4	-2.33	4	-1.91
Domestic credit	2	-1.67	2	-2.68

The table presents augmented Dickey-Fuller (ADF) unit root tests for the residuals of a regression of (log) claims of German banks, their foreign subsidiaries and branches as well as host-country domestic credit on (log) bilateral trade, the German deposit rate, and the capitalization of German banks (baseline regression). The lag length has been determined to remove autocorrelations in the residuals. In the extended regression, dummy variables for German re-unification, the Second Banking Directive, and the introduction of the euro have been added. Time period: 1985:1–2000:12, monthly data. ***(**,*) denotes rejection of the hypothesis of a unit root at the 1(5,10) percent level. Critical values of -4.97 (-4.43, -4.15) have been taken from Hassler (2001a).

Table 10 — Johansen Cointegration Tests

	Cointegration Rank		Residuals		Number of lags	Model	Cointegration relationships
	Trace	Critical values	AR(1)	AR(4)			
	Austria						
$r = 0$	79.4	58.9	0.06	0.76	12	4	3
$r \leq 1$	48.9	39.1					
$r \leq 2$	27.2	22.9					
$r \leq 3$	13.4	10.6					
	Denmark						
$r = 0$	67.9	49.9	0.08	0.13	12	2	2
$r \leq 1$	41.6	31.8					
$r \leq 2$	17.7	17.8					
$r \leq 3$	7.8	7.5					
	Finland						
$r = 0$	89.2	58.9	0.84	0.87	12	4	3
$r \leq 1$	40.4	39.1					
$r \leq 2$	21.1	22.9					
$r \leq 3$	6.5	10.6					
	Ireland						
$r = 0$	66.5	43.6	0.03	0.63	12	3	2
$r \leq 1$	30.7	26.7					
$r \leq 2$	10.5	13.3					
$r \leq 3$	1.4	2.7					

Tests for cointegration are Johansen's likelihood ratio tests based on the trace of the stochastic matrix (Johansen and Juselius 1990), where r refers to the number of cointegrating vectors. Using the Pantula principle, estimates include a constant restricted to the cointegration space (model 2), a constant in the cointegration space and a deterministic trend in the short-run dynamics (model 3), or a constant and a linear trend in the cointegration space and a deterministic trend in the short-run dynamics (model 4). Significance levels have been taken from Hansen and Juselius (1995). The autocorrelation tests on the residuals give the probability levels. Time period: 1985:1–2000:12, monthly data.

Table 11 — Austria: Determinants of Cross-Border Assets Holdings of German Banks

	Baseline regression				Including sentiment indicators			
	Claims of German banks			Domestic credit	Claims of German banks			Domestic credit
	Domestic banks	Branches	Subsidiaries		Domestic banks	Branches	Subsidiaries	
Trade	0.84*** (7.75)	0.95*** (10.17)	0.51*** (10.97)	0.55*** (19.42)	0.85*** (3.92)	0.77*** (4.16)	0.37*** (5.06)	0.53*** (16.26)
German deposit rate	-0.15*** (-9.81)	-0.18*** (-13.92)	-0.07*** (-10.60)	-0.03*** (-8.66)	-0.16*** (-8.89)	-0.17*** (-11.44)	-0.07*** (-11.88)	-0.03*** (-10.64)
d (Capitalization)	13.41*** (7.97)	11.75*** (8.16)	5.03*** (0.71)	1.86*** (4.26)	11.11*** (7.82)	7.59*** (6.26)	3.67*** (7.70)	1.18*** (5.46)
SENT*					9.26*** (2.02)	-8.22*** (-2.14)	-3.02*** (-2.01)	-2.67*** (-3.91)
SENT					-0.95 (2.94)	4.80** (1.93)	2.37*** (2.44)	1.08*** (2.43)
\bar{R}^2	0.91	0.93	0.90	0.98	0.86	0.89	0.88	0.98
DW	0.32	0.63	1.08	0.27	0.65	0.63	0.99	0.46
DF	96	97	97	97	103	104	104	104
KPSS-Test								
h_t for k = 12	0.066	0.060	0.056	0.056	0.114**	0.081**	0.084**	0.045
h_t for k = 24	0.070	0.062	0.061	0.061	0.105**	0.093**	0.095**	0.078**

The dependent variables, trade, and the sentiment indicators are in logs. Estimated by dynamic ordinary least squares (DOLS), using $ar = 6$ and 12 leads and lags for the period 1985–2000 (6 lags for the equations including the sentiment indicators), using monthly data. Standard errors have been obtained using consistent estimators of the long-term variance. DW = Durbin Watson test. DF = degrees of freedom. KPSS unit root tests for stationarity of the residuals from the DOLS regression are based on 12 and 24 lags, and h_t values are for the respective lag. The critical values at the 5 (10) % level are for three regressors: 0.101 (0.081) and for five regressors: 0.073 (0.056) (Hassler 2001a).

Table 12 — Denmark: Determinants of Cross-Border Assets Holdings of German Banks

	Baseline regression				Including sentiment indicators			
	Claims of German banks			Domestic credit	Claims of German banks			Domestic credit
	Domestic banks	Branches	Subsidiaries		Domestic banks	Branches	Subsidiaries	
Trade	-0.12 (-0.49)	0.41 (1.51)	0.10 (0.38)	0.02 (0.15)	0.03 (0.16)	1.99*** (4.71)	0.71* (1.64)	-0.05 (-0.46)
German deposit rate	-0.04*** (-2.66)	-0.12*** (-9.01)	-0.03*** (-2.38)	-0.03*** (-3.98)	-0.06*** (-4.95)	-0.08*** (-3.75)	0.02 (1.34)	-0.02*** (-3.59)
Capitalization	0.45*** (5.32)	0.54*** (6.39)	0.11 (1.45)	0.06 (1.46)	0.44*** (6.89)	0.19 (1.56)	-0.02 (-0.16)	0.09*** (2.66)
SENT*					3.85*** (2.09)	6.60** (1.93)	-1.31 (-0.47)	-0.10 (-0.11)
SENT					-8.83*** (-4.87)	-16.9*** (-4.87)	-8.65*** (-2.63)	-2.47*** (-2.67)
\bar{R}^2	0.92	0.93	0.68	0.61	0.92	0.88	0.56	0.73
DW	0.43	0.85	0.66	0.28	0.67	0.65	0.61	0.53
DF	97	86	74	97	104	100	88	104
<i>KPSS-Test</i>								
h_t for k = 12	0.059	0.036	0.040	0.054	0.086**	0.069**	0.047	0.066**
h_t for k = 24	0.074	0.059	0.060	0.075	0.077**	0.071**	0.071**	0.072**

Notes: See Table 12.

Table 13 — Finland: Determinants of Cross-Border Assets Holdings of German Banks

	Baseline regression				Including sentiment indicators			
	Claims of German banks			Domestic credit	Claims of German banks			Domestic credit
	Domestic banks	Branches	Subsidiaries		Domestic banks	Branches	Subsidiaries	
Trade	1.27*** (4.73)	1.81*** (2.52)	0.69*** (3.82)	0.51*** (5.47)	1.97*** (8.45)	2.59*** (9.94)	1.06*** (4.28)	0.62*** (6.03)
German deposit rate	0.07*** (5.17)	0.09*** (2.94)	-0.04*** (-3.92)	0.12*** (26.02)	0.08*** (4.75)	0.10*** (5.14)	-0.01 (-0.86)	0.12*** (16.01)
Capitalization	0.23*** (2.28)	-0.05 (-0.21)	0.28*** (4.08)	-0.15*** (-4.25)	-0.01 (-0.12)	-0.35*** (-3.83)	0.15* (1.68)	-0.18*** (-4.96)
SENT*					4.37*** (2.51)	-3.86*** (-2.05)	6.31*** (3.39)	1.21 (1.58)
SENT					-1.32 (-0.81)	-3.83*** (-2.16)	2.19 (1.25)	0.49 (0.69)
\bar{R}^2	0.96	0.89	0.94	0.98	0.96	0.94	0.93	0.95
DW	0.54	0.72	0.78	0.29	0.55	1.40	0.55	0.48
DF	97	86	97	97	104	100	104	104
<i>KPSS-Test</i>								
h_t for k = 12	0.029	0.051	0.061	0.041	0.043	0.063**	0.073**	0.046
h_t for k = 24	0.055	0.071	0.062	0.062	0.059*	0.082**	0.089**	0.074**

Notes: See Table 12.

Table 14 — Ireland: Determinants of Cross-Border Assets Holdings of German Banks

	Baseline regression			Including sentiment indicators		
	Claims of German banks			Claims of German banks		
	Domestic banks	Branches	Domestic credit	Domestic banks	Branches	Domestic credit
Trade	0.30 (0.63)	0.82*** (2.29)	0.30 (0.89)	-0.24 (-0.38)	-0.32 (-0.33)	-0.24 (-0.33)
German deposit rate	-0.17*** (-5.15)	-0.27*** (-10.21)	-0.21*** (-8.36)	-0.12*** (-4.41)	-0.23*** (-5.91)	-0.18*** (-5.79)
Capitalization	0.85*** (3.12)	0.70*** (3.50)	0.23 (1.16)	0.91*** (3.62)	1.04*** (2.75)	0.40 (1.36)
SENT*				-4.02 (-1.57)	-3.37 (-0.89)	-1.64 (-0.55)
SENT				10.88** (1.94)	11.44 (1.36)	6.16 (0.94)
\bar{R}^2	0.98	0.97	0.94	0.98	0.95	0.92
DW	0.25	0.85	0.30	0.46	0.62	0.36
DF	97	86	97	104	100	104
<i>KPSS-Test</i>						
h_t for k = 12	0.063	0.041	0.058	0.066**	0.084**	0.102**
h_t for k = 24	0.063	0.102*	0.074	0.078**	0.087**	0.104**

Notes: See Table 12.

Graph 1 — Financial Integration versus Connectedness

Case 1 — Complete Financial Integration

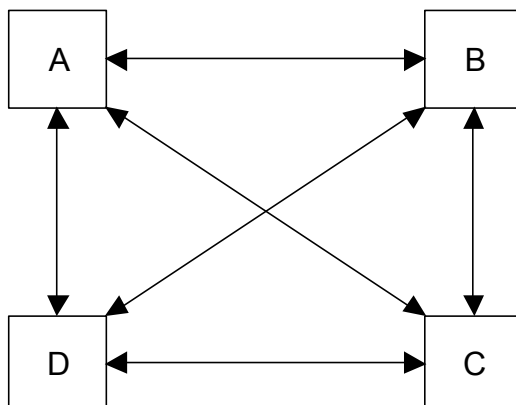

Case 2 — Incomplete Financial Integration

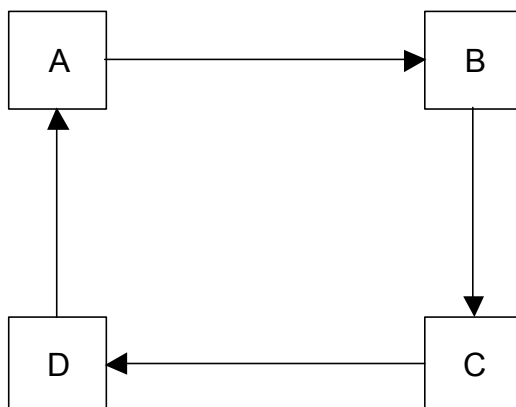

Case 3 — Disconnected Financial Markets

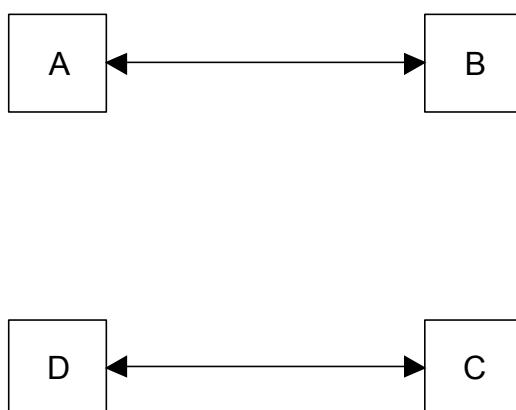

Source: Allen and Gale (2000b)

Graph 2 — Market Shares of Foreign Banks (Share of Total Assets), 1990–1997

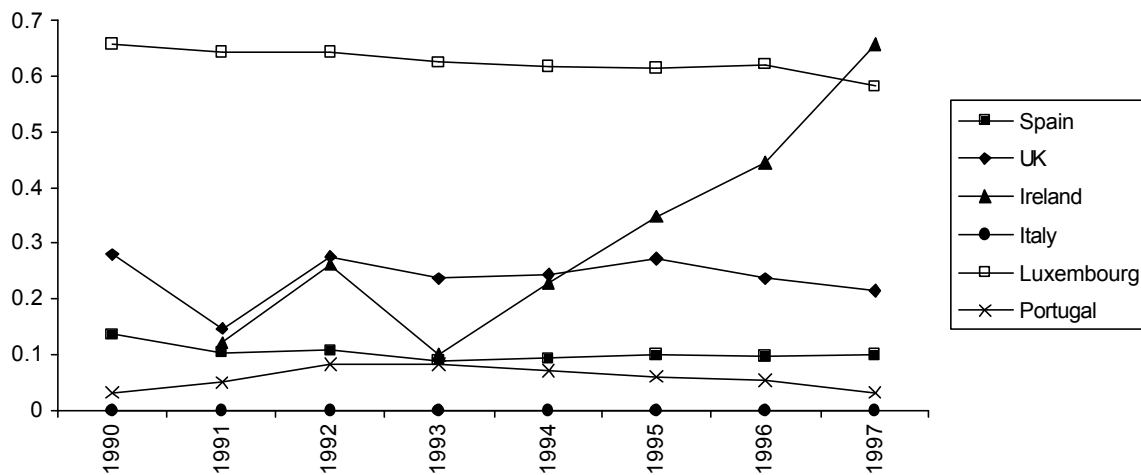
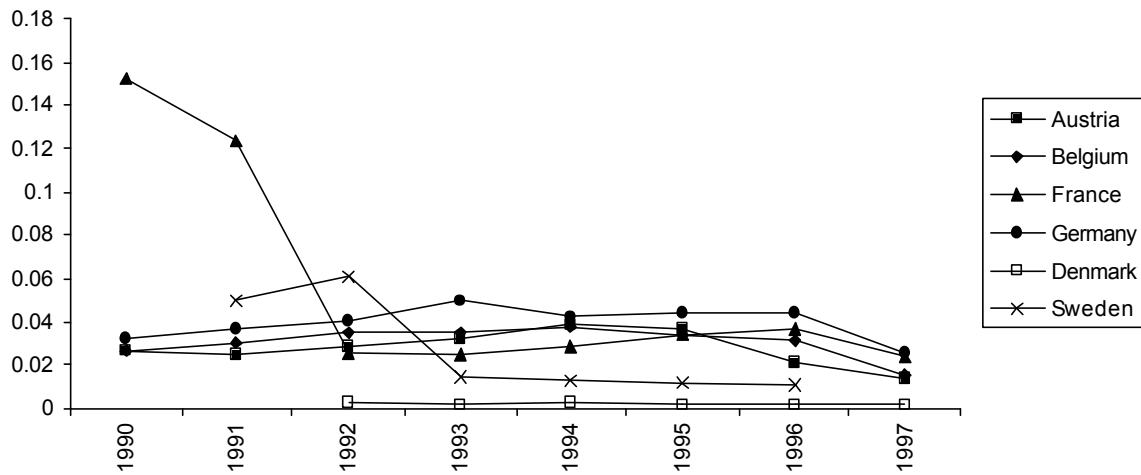

Source: The World Bank (2001)

Graph 3 — Foreign Assets and Liabilities of Commercial Banks (% of GDP), 1948–1999

_____ gross foreign assets - - - - - gross foreign liabilities — net assets

Austria

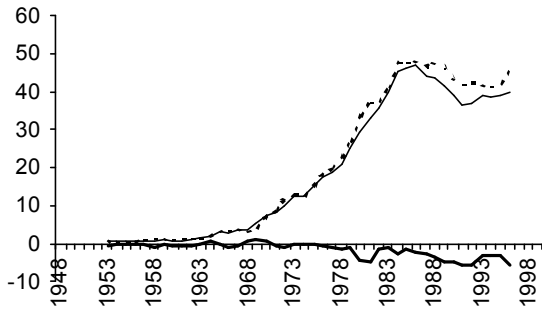

Denmark

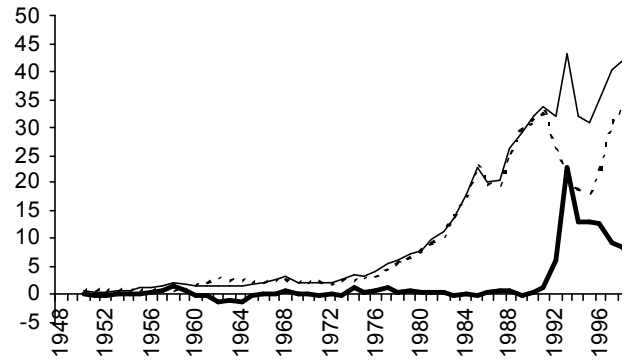

Finland

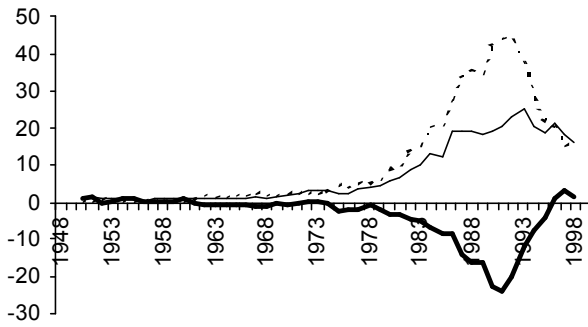

France

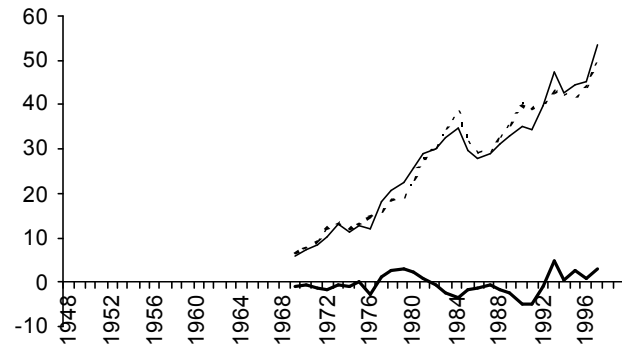

Germany

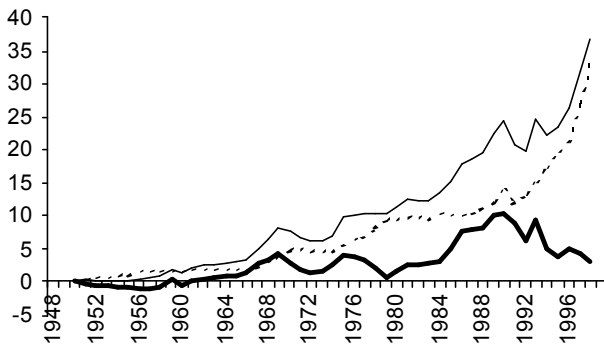

Italy

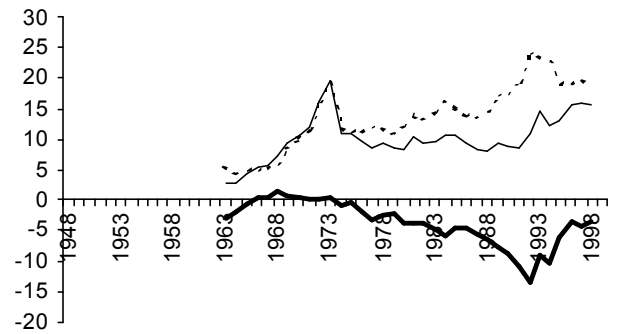

Ireland

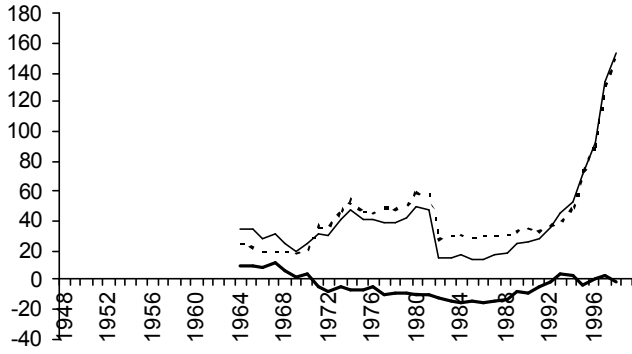

Netherlands

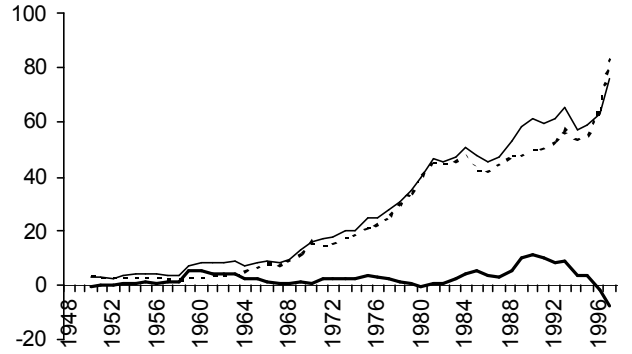

Portugal

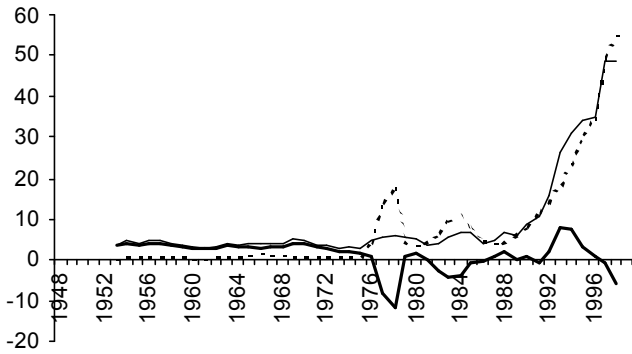

Spain

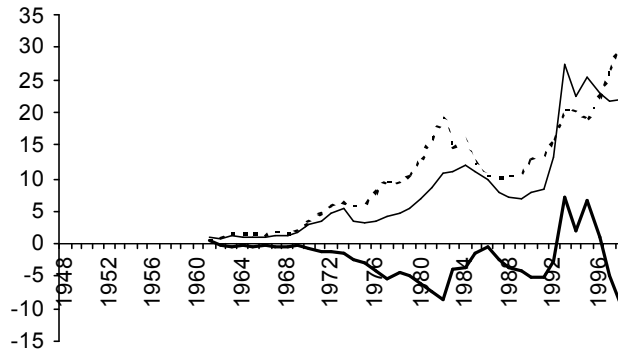

Sweden

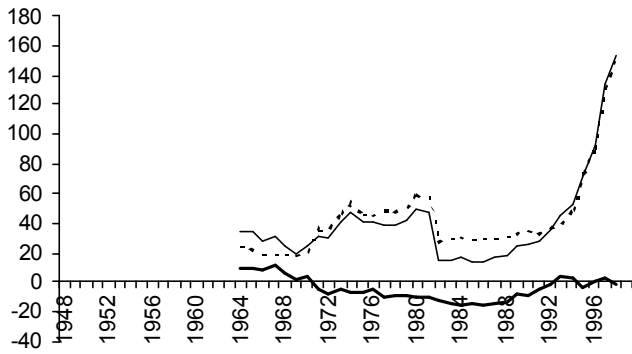

United Kingdom

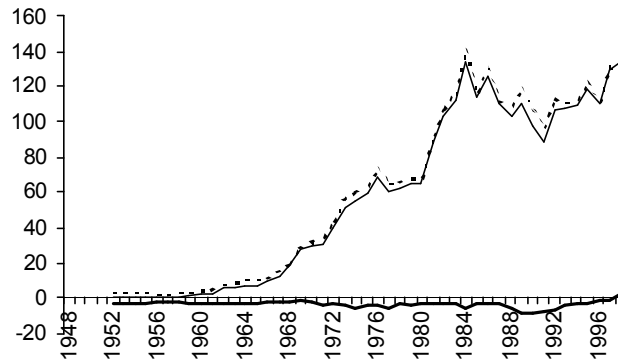

Source: IMF (2001), own calculations

Graph 4 — Foreign Assets and Liabilities in % of Balance Sheet Total 1980–1996

a) Claims on non-residents

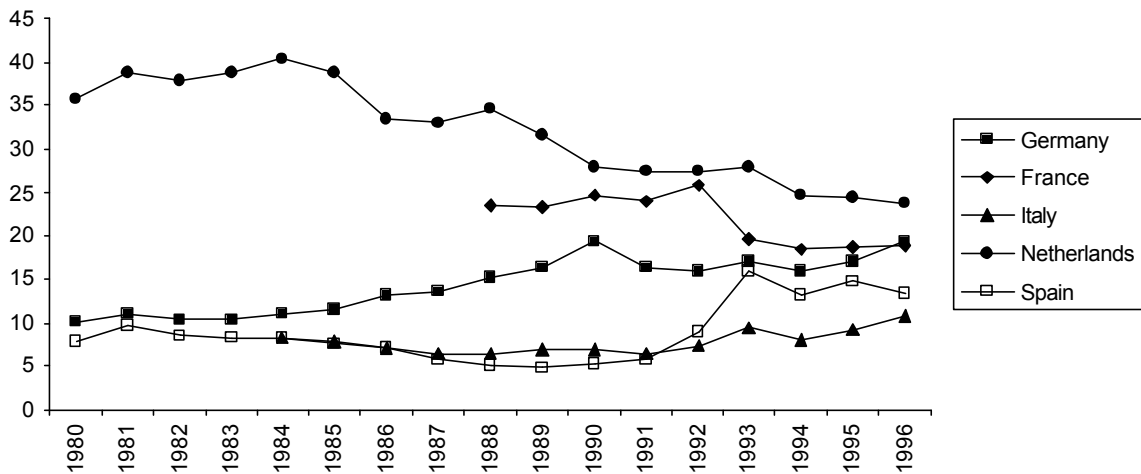
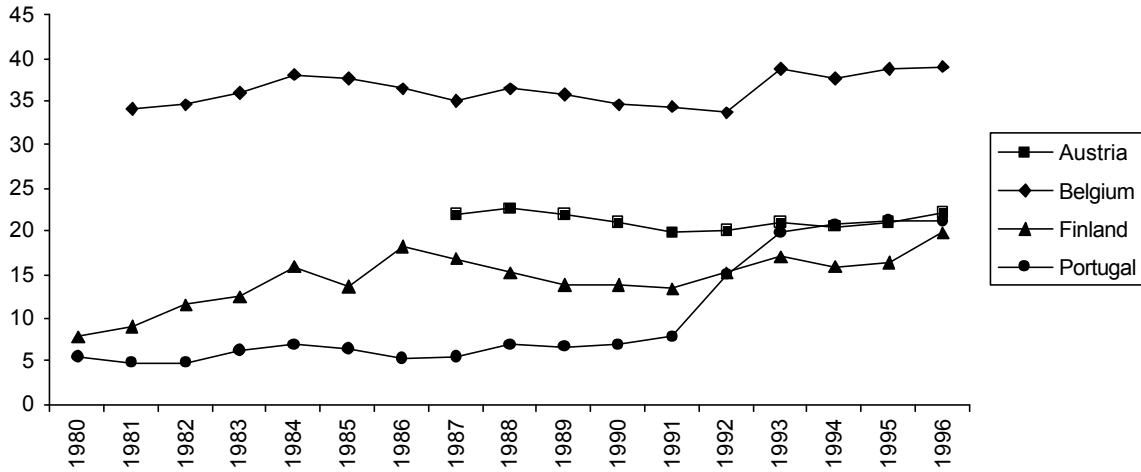

b) Liabilities towards non-residents

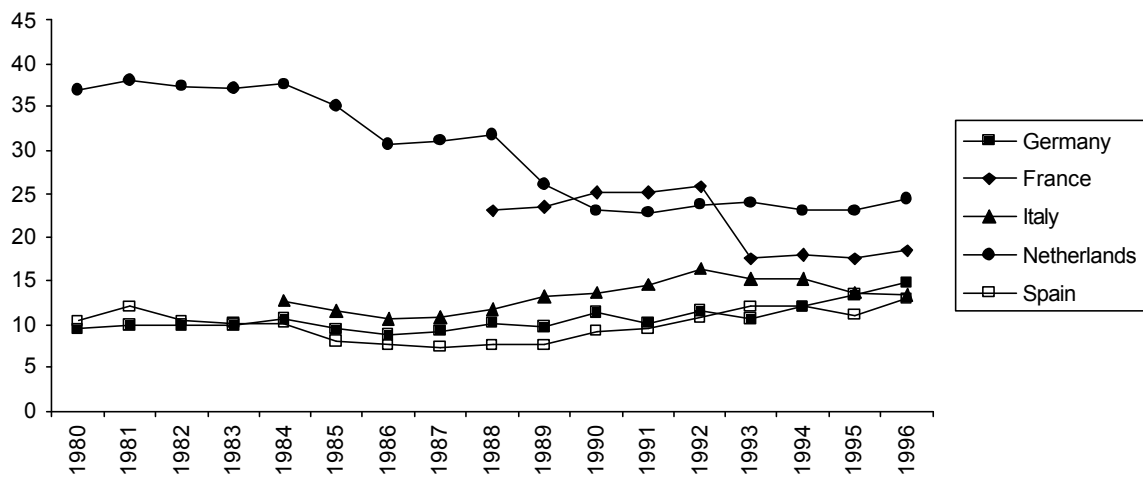
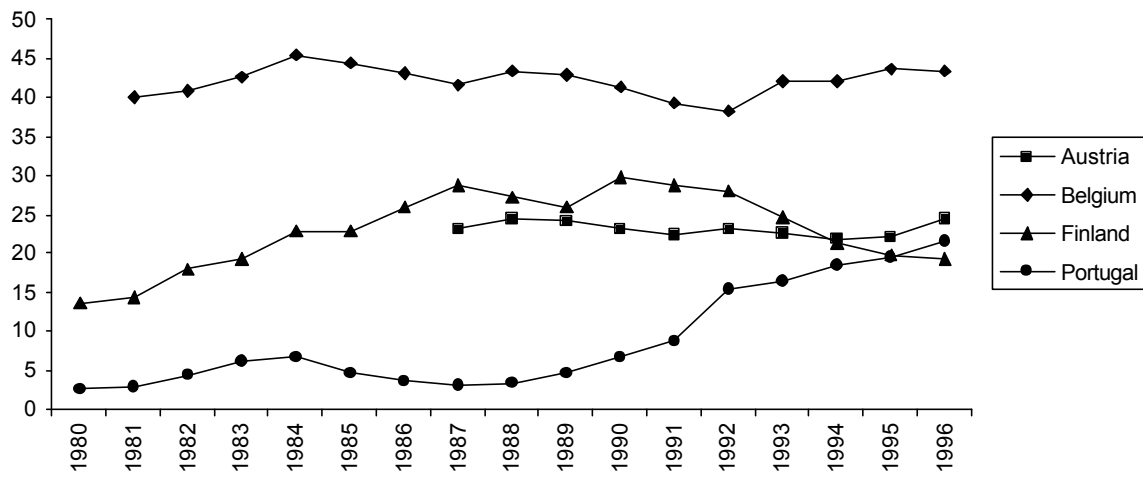

c) Memorandum: Banking Systems Assets / GDP

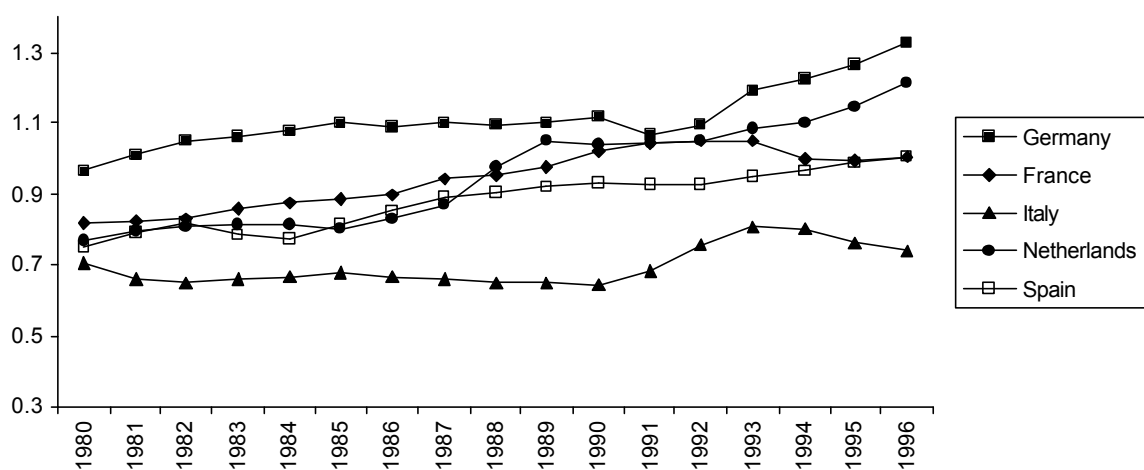
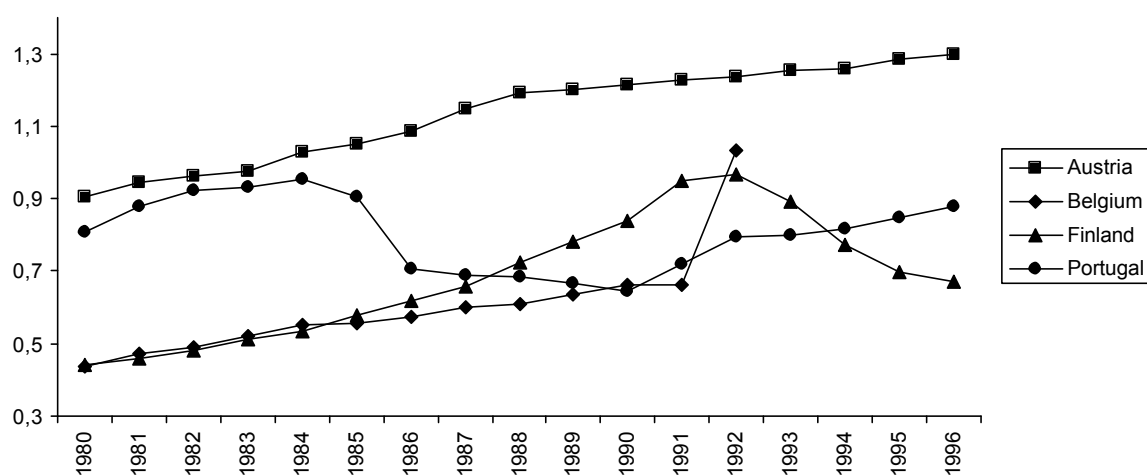

Source: OECD (2000a), The World Bank (2001), own calculations.

Graph 5 — Development of Cross-Border Payment Flows, 1999–2001

a) Volume of Payments Instructions processed by TARGET (number of payments)

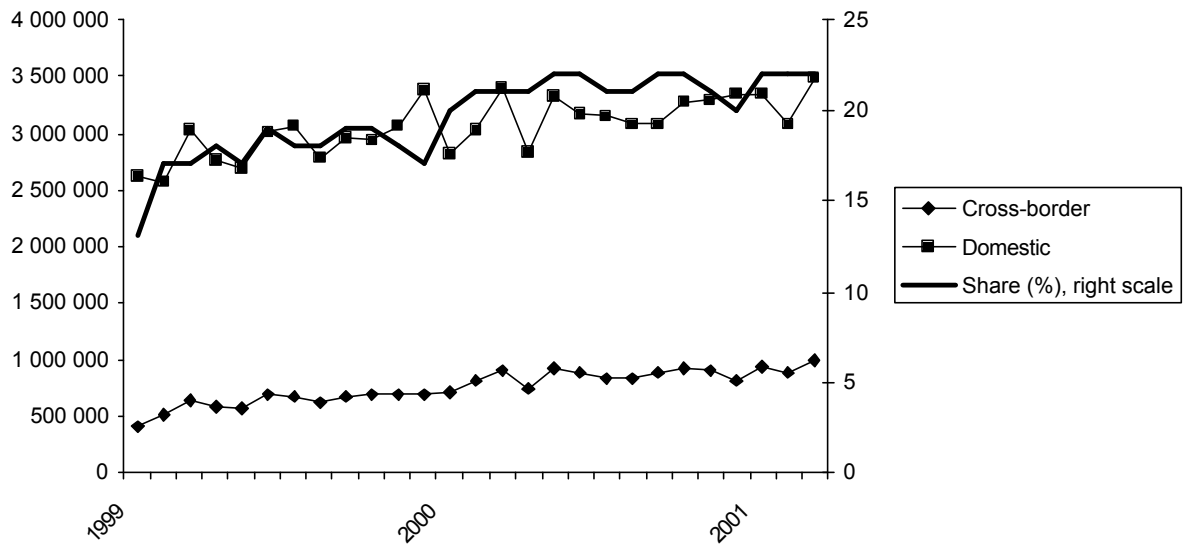

b) Volume of Payments Instructions processed by TARGET (value of transactions, billion Euro)

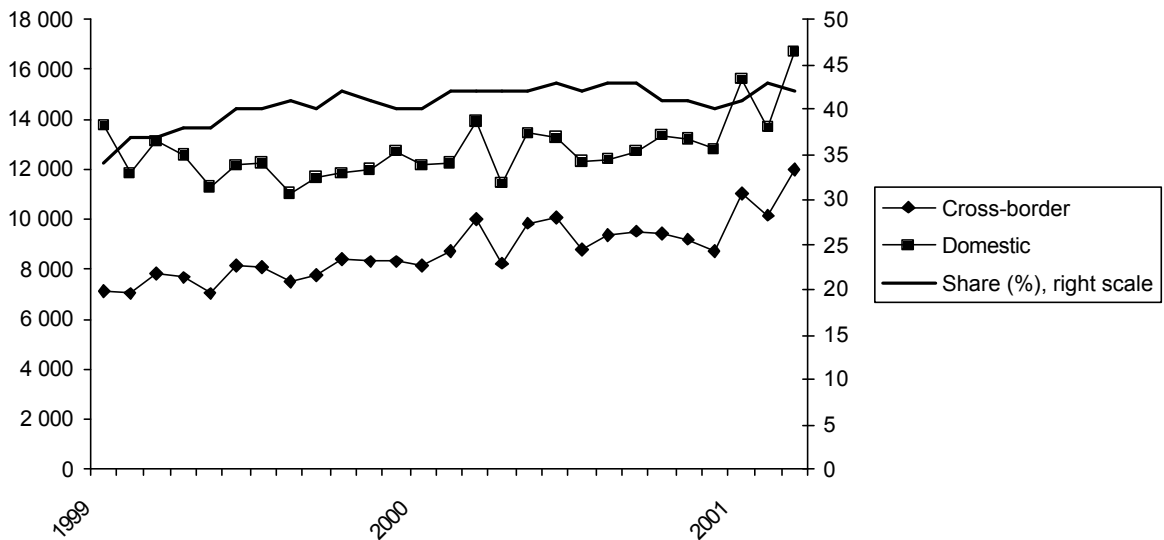

c) Share of cross-border payments in total payments by country

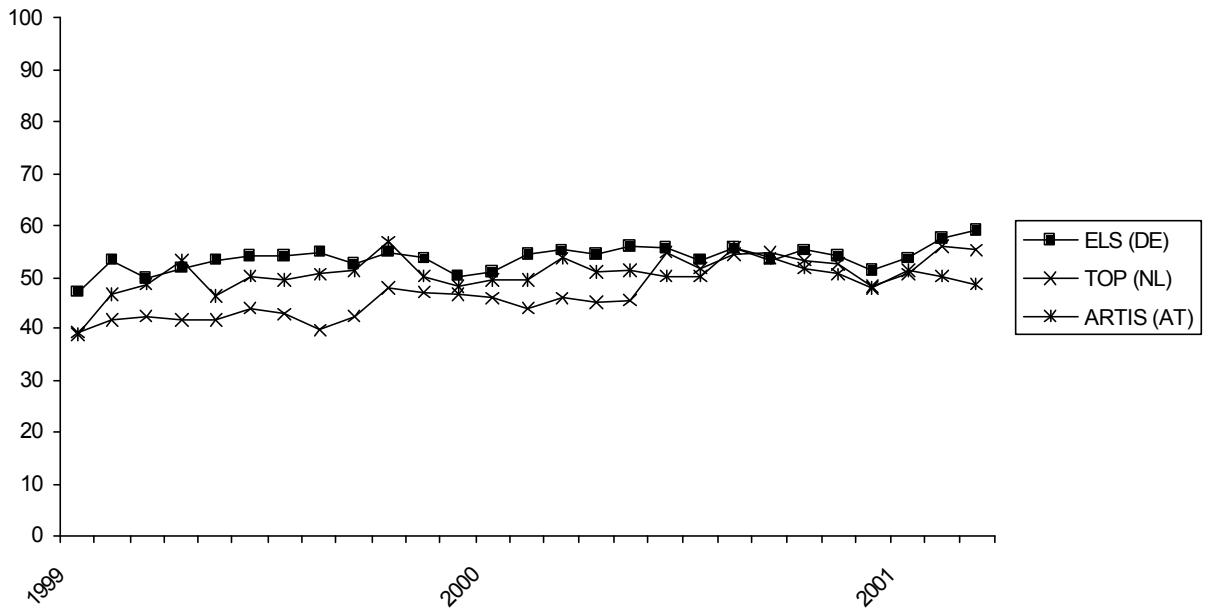
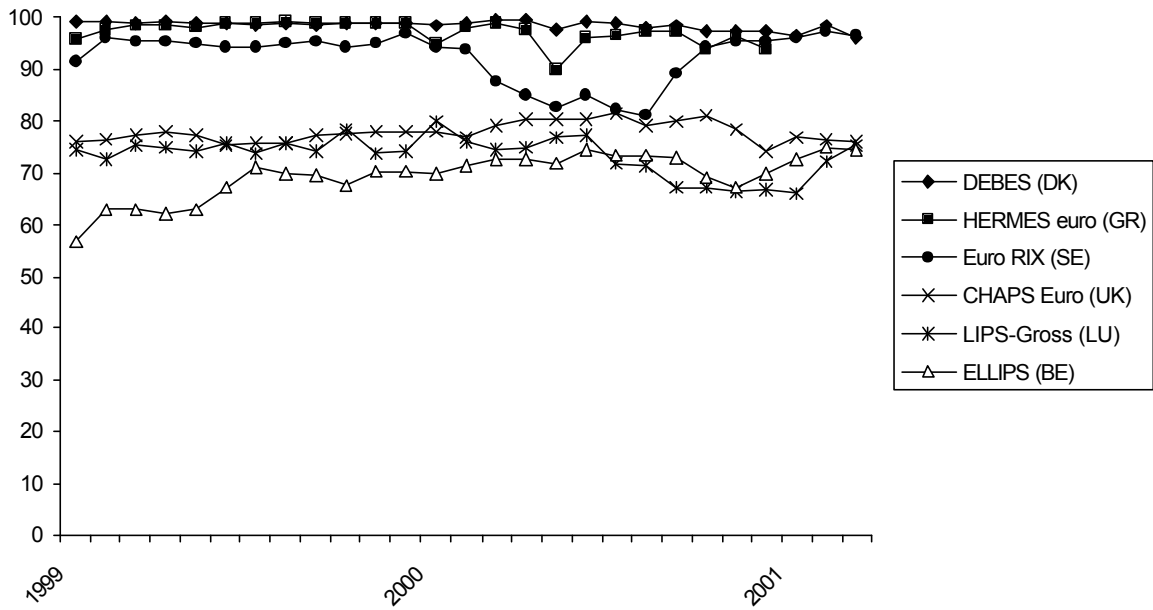

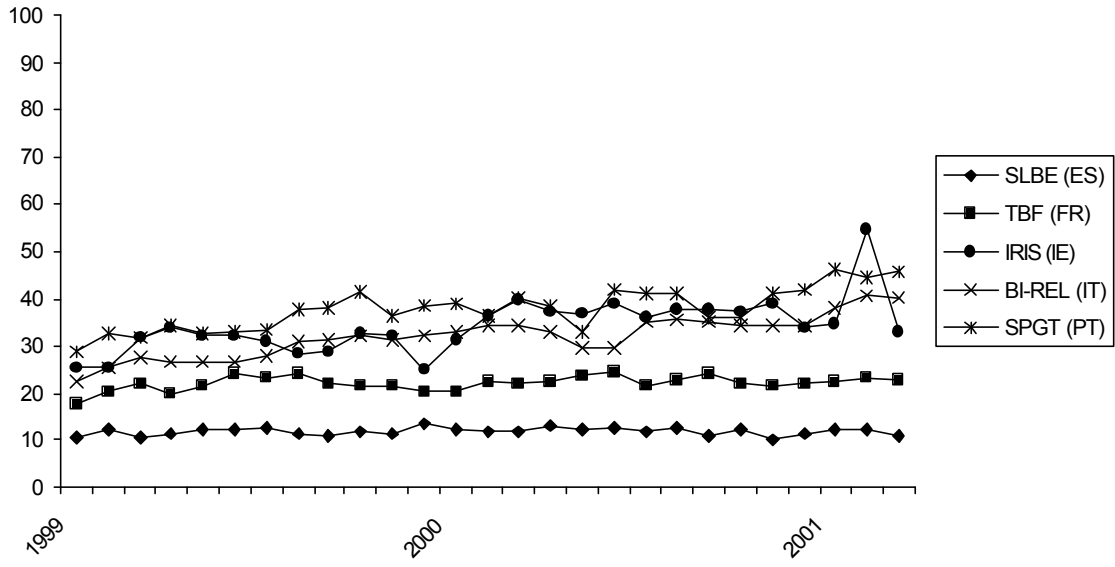

Source: ECB (www.ecb.int)

Graph 7 — Results of the Impulse Response Analysis

Response to Cholesky One S.D. Innovations ± 2 S.E.

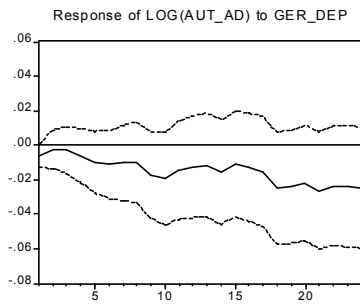

Response to Cholesky One S.D. Innovations ± 2 S.E.

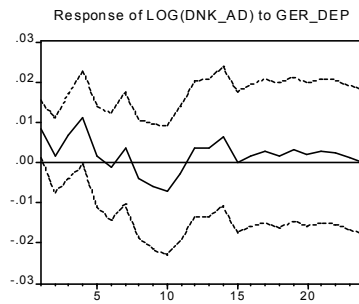

Response of LOG(AUT_AD) to D(CAPITALIZATION)

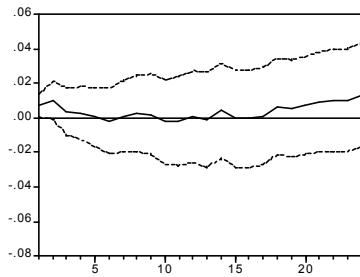

Response of LOG(DNK_AD) to CAPITALIZATION

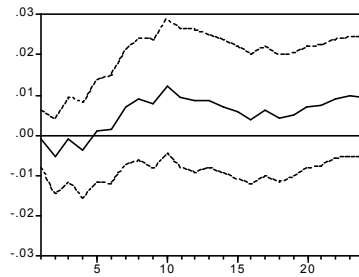

Response to Cholesky One S.D. Innovations ± 2 S.E.

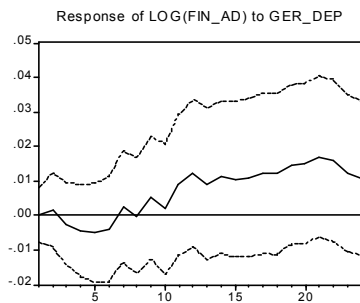

Response to Cholesky One S.D. Innovations ± 2 S.E.

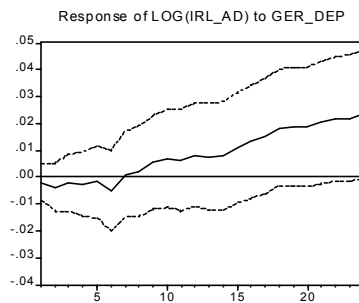

Response of LOG(FIN_AD) to CAPITALIZATION

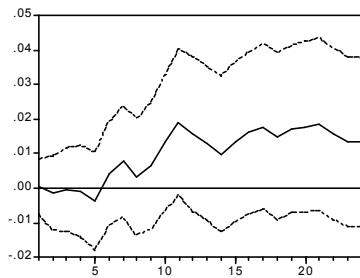

Response of LOG(IRL_AD) to CAPITALIZATION

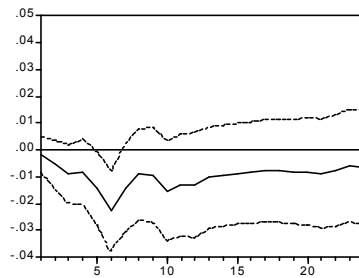

Graph 6 — Share of EU in German Capital Flows (% of Total Capital Flows) 1971–2000

a) Total capital flows

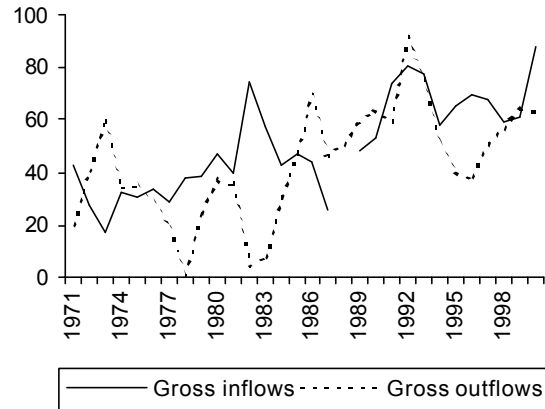

b) Foreign direct investment

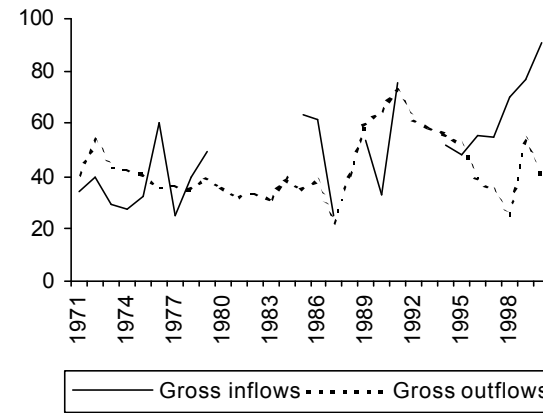

c) Portfolio investments

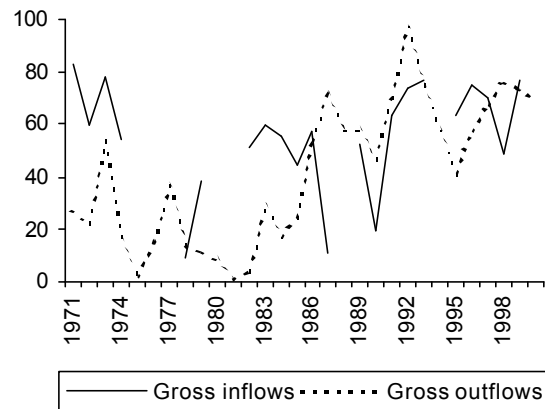

d) Other investments

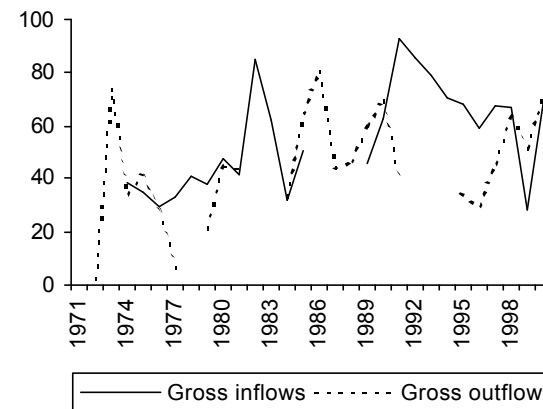

Extreme values (below zero and above 100 percent) have been eliminated. Shares have been calculated from Deutsche Bundesbank (2000).