

Jansson, Leif; Nordström, Tomas; Ysander, Bengt-Christer

Working Paper

The ISAC Model: Structure, Implementation and Stability

IUI Working Paper, No. 64

Provided in Cooperation with:

Research Institute of Industrial Economics (IFN), Stockholm

Suggested Citation: Jansson, Leif; Nordström, Tomas; Ysander, Bengt-Christer (1982) : The ISAC Model: Structure, Implementation and Stability, IUI Working Paper, No. 64, The Research Institute of Industrial Economics (IUI), Stockholm

This Version is available at:

<https://hdl.handle.net/10419/95156>

Standard-Nutzungsbedingungen:

Die Dokumente auf EconStor dürfen zu eigenen wissenschaftlichen Zwecken und zum Privatgebrauch gespeichert und kopiert werden.

Sie dürfen die Dokumente nicht für öffentliche oder kommerzielle Zwecke vervielfältigen, öffentlich ausstellen, öffentlich zugänglich machen, vertreiben oder anderweitig nutzen.

Sofern die Verfasser die Dokumente unter Open-Content-Lizenzen (insbesondere CC-Lizenzen) zur Verfügung gestellt haben sollten, gelten abweichend von diesen Nutzungsbedingungen die in der dort genannten Lizenz gewährten Nutzungsrechte.

Terms of use:

Documents in EconStor may be saved and copied for your personal and scholarly purposes.

You are not to copy documents for public or commercial purposes, to exhibit the documents publicly, to make them publicly available on the internet, or to distribute or otherwise use the documents in public.

If the documents have been made available under an Open Content Licence (especially Creative Commons Licences), you may exercise further usage rights as specified in the indicated licence.

A list of Working Papers on
the last pages

No.64, 1982

**THE ISAC MODEL: STRUCTURE,
IMPLEMENTATION AND STABILITY**

by

Leif Jansson, Tomas Nordström
and Bengt-Christer Ysander

This is a preliminary paper. It is intended for private circulation, and should not be quoted or referred to in publications without permission of the authors. Comments are welcome.

April, 1982

CONTENTSPage

Chapter 1	Introduction	3
	1.1 Inertia and adjustment in a small open economy	3
	1.2 Market behavior	6
	1.3 Impact of world markets	10
	1.4 Government behavior	15
	1.5 Income formation and the level of aggregation	21
	1.6 Shortrun and longrun dynamics	24
Chapter 2	An Outline of the Model	27
	2.1 A key map of the model	27
	2.2 Price and wage formation	35
Chapter 3	The Equations of the Model	42
	3.1 Definitions and conventions	42
	3.2 Commodity balances in fixed and current prices	42
	3.3 The i/o-matrix	43
	3.4 Energy substitution	47
	3.5 Investments in the business sector	48
	3.6 Foreign trade	49
	3.7 Disposable income in the household sector	50
	3.8 Private consumption	54
	3.9 Central government	55
	3.10 Local government	56
	3.11 Stock building	59
	3.12 Prices	60
	3.13 Employment	61
	3.14 Wages	62

	<u>Page</u>
Chapter 4 Implementation	65
4.1 Level of aggregation	65
4.2 Values of essential parameters	68
4.3 The solution algorithm	81
 Chapter 5 Stability	 86
5.1 A pragmatic framework of stability and control	 86
5.2 Stable growth and resilience	92
5.3 Controlling the model	102
5.4 Structural stability	111
5.5 Adaptivity or the limits of macro-models	 125
 APPENDIX A: The system of equations	 129
 APPENDIX B: List of Symbols	 138
 REFERENCES	 143

THE ISAC-MODEL: STRUCTURE, IMPLEMENTATION AND USE.

1 Introduction

In the following we present a model for the Swedish economy called ISAC - Industrial Structure And Capital Growth. The principal aim of our modeling efforts has been to form an instrument suitable for the medium and long term study of stability and growth. The model also reflects our concern to arrive at empirically estimable relations and functions, and to make possible projections over a longer time span in order to analyze some crucial policy problems concerning e. g. the balance of payment, energy policy, and the control of local government spending. The model has so far been mainly used for policy studies dealing with the time periods 1980-85 and 1980-2000, respectively.

1.1 Inertia and adjustment in a small open economy

In a small open economy like Sweden much interest is focused on the way in which the economy adjusts to changes in trade volume and prices on the world markets. There are many ways in which this adjustment process can be modelled. In a pure neoclassical model of competitive equilibrium the emphasis would be on the final results of the assumed price adjustments, disregarding the various sources of inertia and the effects of intermittent disequilibria. The assumed adjustment mechanisms would then usually not be directly estimable from the dynamic performance of real life economies and the model

would be best suited for comparative static studies of medium and long term tendencies.

In ISAC we have gone in an opposite direction, trying as far as possible to incorporate various kinds of adjustment obstacles, like the sticky wages and prices of markets characterized by monopolistic or oligopolistic competition, the immobility of vintage capital, and the cash-flow restrictions on investment financing and the inertia and lags observed in both private and local government consumption. We recognize regulated prices like the rate of exchange and cost components mainly determined from abroad like the rate of return requirement. Market disequilibria - surpluses or deficits of foreign exchange and of production capacity and labor - will therefore be a normal feature of model projections and will have feedback effects in the form both of price modifications and a rationing of supply. From a disequilibrium situation the model economy may finally - with the help of or despite economic policy measures - fetch up in a new equilibrium or steady state growth barring new disturbances. Even then, however, the adjustment path will in most cases affect the final equilibrium in important ways. To study this interdependence between short-run instability and long term growth is indeed one of the main purposes of the ISAC model.

The ambition to incorporate a realistic description of the "imperfect" adjustment mechanisms is a feature which the ISAC-model has in common with i.a. the LIFT-model of the University of Maryland and the MGM-model of the Cambridge Growth project (Almond 1978, Barker 1976). The development of ISAC has indeed run parallel with the development of

the MGM-model and has been influenced and aided by the experience earned from the Cambridge Growth project.

The history of the ISAC-model can, to a certain extent, be said to reflect the developments of the Swedish economy during the 70s.¹ The model work was started in the middle of the 70s. The aim was to construct a static planning model for the whole economy of the kind then used for medium term planning in many Treasuries around Europe. Starting out from the experience of fast growth and price stability in the 60s it was deemed sufficient and appropriate to limit the modelling ambitions to the description or prescription of balanced-growth paths from the present to a future target date. The emphasis was on developments in real terms with consistent price structures being computed afterwards.

The increased price instability and price uncertainty engineered in part by the 73 oil crisis was in Sweden followed by dramatic swings in industrial investment activity during the rest of the decade. In the second phase of model development priority was therefore given to the integration of price formation into the model computation and the introduction of investment functions for the various industrial branches.

¹ For a detailed account of the first version of the model see "IUI:s långtidsbedömning 1976. Bilagor." (1977), in particular chapters 1-3 by Ulf Jakobsson, G Normann and Lars Dahlberg, respectively.

A second version of the model is described by the present authors in "Kalkyler för 80-talet." (1979).

At the the end of the 70s. the economic interest in Sweden was increasingly focused on the determinants of our international competitiveness and on the need for structural adjustment in industry in order to eliminating our mounting trade deficit. Thus, there were compelling reasons in the final phase of model development for introducing more explicit mechanisms for price and wage setting, for making the capital structure in industry more explicit with the aid of a vintage capital approach, and for incorporating a special submodel for local government spending. To make possible an explicit analysis of various means of reducing our oil dependence a relatively detailed treatment of industrial energy consumption was also incorporated into the model.

1.2 Market behavior

The markets explicitly treated in the ISAC model are throughout characterized by a monopolistic or oligopolistic competition. The nonregulated prices are set by the sellers, not by any neutral "market" mechanism. This certainly does not imply the absence of any adjustment towards market equilibrium. But "sticky" prices and wages can make the adjustment considerably slower and more indirect.

On the markets for tradable goods prices develop as weighted averages of changes in cost in world market prices and changes in capacity utilization, where different weights can be used for domestic and foreign sales, respectively. This can be interpreted as saying that basically the firms are trying to cover costs, where costs are computed as avera-

ge variable cost plus planned depreciation and a target rate of return on installed capital.¹ This "cost price" is then modified to take account both of the foreign competition and of variations in capacity utilization.

There are no long-run returns to scale in industrial production but capacity within each branch is distributed between vintages, typically differing in technology and in productivity. In a world of perfect competition only those vintages would be used which can earn a quasi-rent at given world market prices. The way we have modelled the Swedish economy is quite different. Typically, a Swedish industrial branch is dominated by a small number of big firms - each comprising several capital vintages, both in different plants and within the same plant, which moreover often represent different technological stages of the production processes. We therefore assume that, due to technological reasons and to considerations of regional employment responsibilities, the firms will at each time have the same capacity utilization in each vintage. In the short run this may imply accepting current losses in some vintages. Since the firms are assumed also to vary the relative scrapping of vintage capacity in inverse proportion to profitability, vintage use will, nevertheless, in the long run adjust to differences in quasi rent. The short-run impact on the firm of, say, a change in world market prices will thus be to a certain extent cushioned both by the "sticky" pricing and the evening out of capacity use - mak-

¹ For a discussion of pricing with target rate of return and of the empirical evidence for its use cf. Eckstein-Fromm, 1968.

ing the compensatory change in trade volume correspondingly greater. Since changing trade and capacity use will react back both on pricing and - together with profits - on investments, the adjustment will be reinforced. The adjustment will, however, still be somewhat slower and carried out on a lower profit level than what would be the case in a perfectly competitive world.

The response to the firms' price setting will on domestic markets be determined by intra-firm demand, by governmental demand, and by consumers' final demand as expressed in a system of linear expenditure equations. On the foreign markets, the response, described by a set of export functions, will be determined by the relative price development and by the world market trade expansion.

For nontradable goods the prices are assumed to be completely determined by cost, including a target rate of return on capital.

Wage setting on the labor market is modelled by a Phillips curve type of approach, making wages in the private sector depend on past profits, productivity development and inflation, and current unemployment. This outcome can be interpreted in a manner somewhat analogous to that used for the price setting in the product market. The wage earners will try to get compensated for both inflation and productivity gains but the final result will, however, be modified by current market conditions, i.e., unemployment. Long-run wage adjustment will thus be reinforced by the change in total employment resulting from the bargaining.

For public employees a one year lag in wage settlement has been usual and has been assumed in the model to continue also in the future. The sensitivity of wages to employment conditions is obviously of strategic importance for the functioning and the policy implications of the model. In the model version documented here the empirical estimates of this sensitivity may well be biased by the choice of open unemployment as indicator of market conditions and by our assumption of an aggregated labor market with exogenously given supply.

A consequence of assuming immediate adjustment of supply to demand at the set prices in the product markets, i.e., no unplanned stock changes, is that disequilibria will occur also in the another factor market in the form of over- and underutilization of capital. As already told above, a slow adjustment of capacity will, however, take place since investments are determined by the degree of utilization as well as by past profit performance.

This kind of investment function is obviously in line with the assumption of monopolistic competition in the product markets. The influence of past profits can be said to reflect both profit expectations and the cash flow restrictions on investment finance. A similar mixture of financial conditions and utilization rates will also determine local government investment in the various areas of service production.

There are no explicit financial markets in the model. Instead both the rate of exchange and the required rate of return on capital are assumed to be exogenously determined. The rate of exchange is treated as an instrument of government policy.

Although some causes of exchange disequilibria may be weakened by self-correcting adjustments elsewhere in the model, there is thus no feedback mechanism leading automatically to exchange adjustment in the absence of government intervention.

A similar - and related - need of government intervention arises in the capital and the money markets. The required rate of return in the small open economy is assumed to be determined abroad by conditions in the international financial markets. This internationally determined rate of return is then transformed to a particular rate for each branch of industry by taking account of differences in depreciation rate, tax treatment and solidity. The required rate of return will influence the firm's pricing and investment and by that also its saving, but will not affect the saving ratio for households.¹ The main burden of adjusting total domestic saving to avoid surpluses or deficits in external payments will thus fall on the public budgets, particularly the state budget.

1.3 The Impact of World Markets

What happens in the world markets is of decisive importance for a small open economy like Sweden. The inter-relations between Swedish markets and foreign markets are in the ISAC-model described in

¹ Having failed to arrive at any reliable estimate of the aggregate consumption function - partly due to methodological shifts in the official data base - we have in this model version kept the aggregate saving ratio for households constant at the 1977 level. The choice of level as such is important only by its implications for the net balance of the state budget.

the usual way by export- and import-functions with the relative price (domestic/world) and market expansion as determinants. The measurement and interpretation of the involved elasticities does, however, involve some rather knotty problems.

That most estimated relative price elasticities both for exports and imports are rather low - in the estimates we use between 1.5 - 2.0 on the average - is well in line with our basic assumption of monopolistic competition determining foreign markets as well as the domestic ones. Unfortunately, we cannot be sure that the aggregate elasticities we measure reflect market condition for the commodities concerned. To be able to discern the various biases that might be involved in the estimates it might be worth while to start by recalling some main possible reasons or characteristics of monopolistic competition, explaining the existence of price differences between similar products.

One such characteristic may be simply product differentiation. The products of different firms - and countries - are then perceived as being different, even though the difference may only exist "in the eyes of the perceiver".

A second characteristic can involve differences concerning non price elements of transaction cost, i.e., differences in market strategies. The search cost of the buyer will, e.g., vary with advertising efforts.¹ Contractual forms and credit condi-

¹ Limited information and a randomized search may indeed by itself explain why the individual firm faces a sloping demand curve.

tions will affect both cost and risk for the buyer, etc.

A third possible reason for the emergence of a monopolistic competition structure is the existence of entry costs and of various forms of restrictions on free competition.

It seems intuitively reasonable to assume that all these three characteristics are to a certain extent relevant on most markets for international trade. If true, this means that unbiased estimates of elasticities should require not only that all transaction costs are taken into account but, even more important, that data are disaggregated by product, firm and market.

The realities of official statistics, however, are far removed from these utopian ideals. That our measurement of elasticities involves a specification bias by not including other transaction costs than price, is so obvious that we usually do not bother to reflect on it. Of more immediate concern is usually the aggregation bias, that comes from measuring price on aggregates of commodities and markets, that are different and moreover shifting in composition. That we may be comparing aggregates of different compositions - e.g. domestic sales versus imports of a certain composite good or exports versus world market trade - means that the measured changes in relative price may in part not be due to different price development for individual goods but simply reflect the different composition of the aggregates. Changes in composition will moreover call forth changes in the aggregate rate of price change even without any changing rate in any individual line of goods. A regis-

tered increase of the export price index for a certain aggregate commodity may, e.g., reflect the fact that the exporters - reacting, say, on sinking profits and trade - are falling back on a defensive market strategy, retiring to "safe" markets, where earlier market penetration allows them to raise prices faster while consciously staying away from too competitive markets and goods.

For these reasons aggregation will usually lead to a misrepresentation of behavioral responses. It means that we implicitly assume a two-stage maximization, where the buyer first reacts on an aggregate price, determining an aggregate volume of the composite commodity and then in the next stage "distributes" this composite demand volume optimally between the individual goods with respect to their respective prices. It is well known that such a two-stage maximization is in general only possible when the composite commodity from the buyer's point of view can be expressed as a linear homogeneous function of the individual commodities, and that even then "the correct" aggregate price index will be identical with the usual weighted price index only in the trivial case where individual price developments are identical, i.e., when the individual goods are perfect substitutes.¹

The aggregation bias obviously makes interpretation of the elasticities involved very uncertain,

¹ For a thorough treatment of aggregation and decentralization cf. i.a. Blackorby-Primont-Russel, 1975 and 1978, particularly chapt. 5-9. A detailed discussion of two-stage maximization as part of the aggregation problem is presented in Bliss, 1975, chapt. 7.

makes the long-run stability of measured relations questionable and the assumption of a constant elasticity - used in this model also - particularly suspect.

The Swedish official statistics, however, carry the aggregation one step further by aggregating in the usual way the imported and domestically produced quantities of the same industrial category of goods, and using this aggregate in estimating, e.g., input-output relations. Although the inconsistency or bias becomes particularly glaring in this case since different prices are explicitly quoted for the two parts that are treated as perfect substitutes, it really only means a new marginal strengthening of the general aggregation bias. Since there are no base in official data for a radically different approach, we have here chosen to follow the official statistics and accept this further approximation in estimating demand elasticities. All we can generally say is that the probability for a serious bias arising out of this particular kind of aggregation should decrease with the disaggregation of industrial sectors.

Most recent estimates of price elasticities in foreign trade in West-European countries are of the same low order as the ones we have used. Whether this should increase our confidence in the estimates is, however, questionable, since they may well contain common biases. If we accept the estimates as true, they imply that demand and/or supply of tradable goods is rather inflexible both for us and our trading partners - that there are rigidities in the economies concerned which may be due to monopolistic competition or to more general causes, e.g. obstacles to mobility in the factor markets.

Low price elasticities do, however, have some obvious and important consequences for economic policy. For one thing they make currency devaluation - even without compensating wage change - a more sluggish instrument for improving the trade balance and for expanding employment. They can also make a selective taxation or indeed tariff on imported goods a more efficient way of improving the external balance than, say, general export subsidies or indeed devaluation of the currency. In a full employment situation, e.g., taxing an imported good with a highly elastic domestic demand, involves a limited loss of consumers' surplus to be compared to the resource cost and terms of trade loss involved in trying to force a corresponding general expansion of exports. Import taxation might still be an efficient way of solving trade deficit problems if instead of having a very elastic total demand, you have a highly elastic domestic supply - especially in a situation with less than full capacity utilization.¹

1.4 Government Behavior

In an open economy with a large public sector like Sweden, government behavior can affect the adjust-

¹ One should perhaps at this point add three cautionary notes. The possible efficiency of import taxatory - remarked upon by many economists around Europe - is of course conditional on no retaliation measures being taken by the trading partners and no losses of dynamic efficiency resulting from the decrease in specialization. Secondly, the possible relative efficiency of selective import taxation has nothing to do with the optimal tariff argument, since it does not involve any change in terms of trade. Thirdly, the possible advantage tends to be grossly exaggerated by those who are calculating in fixed prices and thus neglecting all losses of consumers' surplus.

ment of the economy in important ways. It may serve as a source of inertia or as an inbuilt stabilizer in the traditional sense, it may on the other hand give rise to new oscillatory movements and it is, finally, expected to provide the means to facilitate the necessary adjustment through economic policy.

In analyzing government behavior it is, however, necessary to distinguish between local and central government. Local government in Sweden has up till now not been independently involved in income distribution and stabilization policy except to a very limited extent. Economic policy has largely been left as a responsibility for central government, whose budget is dominated by transfer payments. Local government has traditionally been the main provider of public services.

Local government

The restructuring of Swedish economy in postwar years has been rapid. While agricultural employment has been drastically reduced, a matching increase has occurred in the service sector, particularly in the public services, which have doubled their share of GNP and trebled their employment share. The major part of this expansion - in education, medical care and social welfare - took place within the local governments which now employ almost a quarter of the labor force and channel almost a third of the national income through their budgets. Local governments have in this way grown into the same order of size as manufacturing industry, which meanwhile has kept its share both of GNP and of employment relatively

unchanged. There is also a substantial degree of decentralization and freedom from central government control within the 300 different local government units. There are 277 municipals and 24 counties.

There are several potential ways for central government to control local government. However, when it comes to actual effective control of total expenditures or investments - or the consumption share of local government - postwar history makes it indeed very doubtful if local governments have really been more controlled or more needful of the wishes of central decision makers than the big manufacturing corporations. Although about a fourth of local government financing comes from central government grants, until recently there was no attempt to use grant policy for controlling total local government expenditures.

Against this background the assumption - common to almost all national policy models - that local government expenditures can be treated as a central policy parameter, seems particularly unwarranted. The treatment of local government expenditures as an exogenous parameter can obviously lead to misrepresentations of economic policy problems in several important ways. It overestimates both the effectiveness of existing policy means and the degree of inbuilt stability and inertia guaranteed by the existence of the public sector. At the same time it neglects the importance of swings in local government activity, generated independently and/or reinforcing disturbances from elsewhere in the economy, and makes it impossible to study explicitly the problems of central control of local government expenditures.

For these reasons local government actions are treated endogenously in the ISAC -model by way of a special aggregate sub-model.

The sub-model is represented by a 10-equation system explaining production expenditures (1-5), transfer payments to households (6 - 7), investments (8), loans (9) and - residually - taxes (10). The production technology used by local governments are throughout assumed to be of the Leontief type with fixed coefficients, so that production volumes can be directly transformed into required inputs from the business sector.

The sub-model is derived from an additive quadratic goal function maximized under a budget constraint and can be generally described as a model of budgeting behavior for local government decision-makers. The goal function includes consideration not only of service and transfer targets but also of private disposable income, of capacity utilization and of the net real wealth of local government.

The explanation for service production derived from this kind of quadratic goal function can be interpreted as reflecting a certain kind of budgetary procedure. To begin with, demographic factors, the need and cost of capacity expansion and private income developments determine the maximum amount of money that the decision makers in local government would like to spend on a certain category of service. These maximal claims must then somehow be cut down to fit into the available tax income, defined by a two-year lag in disbursement of the tax yield. The cutting ratio for a certain category - determining how much of the total reduc-

tion required that will have to fall on this category - will vary directly with the price of the service and inversely with the rate of decline of the marginal utility for the service. This "two-stage" budgetary procedure can be viewed as corresponding to the two-level hierarchy of budgeting and of political representation used in Swedish local governments.

Local government transfers have been classified into two categories of housing subsidies to households - subsidies to rent and subsidies to other current housing expenditures, i.e., water, electricity, heating etc. Local government is in both cases modeled as trying to maximize the housing standard that can be bought for a given amount of money. How big the total transfer expenditure will be, given a certain subsidy level, is then determined by housing demand - or more exactly by the local governments' expectations of housing demand.

The corresponding investments will be determined by capacity utilization, liquidity and credit market conditions. The two latter factors will also decide to what extent the investments should be loan financed. Finally, current tax rate will be residually determined by the budget restraint.

Because of the two year lag in final dispersement of taxes to the local governments and because many of the expenditure decisions must be based on expectations formed on the experience from the preceding year, there may also be unplanned changes of liquidity. These lags together with the interaction between local government expenditures and wage determination in the total economy can give rise to cyclical swings in local government expenditure.

Central government

A relatively disaggregated treatment of the central government budget is a necessary prerequisite for the intended use of the ISAC-model for policy analyses. The central government budget expenditures are slightly bigger in total amount than those of the local government but are in contrast to these dominated by transfer payments.

Central government consumption is treated as exogenous and is divided up into six categories. The corresponding investments are determined by a simple accelerator principle. The production technology, like that of local government, is assumed to be characterized by fixed input-output ratios.

There are altogether ten forms of central government transfer payments distinguished in the model: industrial subsidies, local government grants and eight types of transfers to households, ranging from various pensions to sickness and unemployment benefits. The size of these transfers is exogenously determined by existing laws or by government decisions. The same is true for the four types of transfers to central government which apart from the national income tax also includes social security contributions and other payroll taxes. The final incidence of payroll taxes is hard to measure and still open to controversy. We have, however, throughout made the simplifying assumption that payroll taxes are entirely rolled back onto the wage earners.

Besides the budget items there are other policy parameters for central government, e.g., the exchange rate, tax rate limits for local government

and "wage policy". With "wage policy" we here mean the possibility under certain conditions to shift the "Phillips curve". This can be interpreted in terms of a labor market policy - changing mobility or matching on the market - or as an adjustment of the marginal tax structure, making it easier to co-ordinate wage settlements for different wage groups without inflationary effects.

1.5 Income Formation and the Level of Aggregation

It would have been desirable to be able to use the model also for analyzing income distribution problems, particularly the interaction between income distribution on the one hand and allocation and stabilization policies on the other. Unfortunately this has proved possible to do only to a very limited extent.

Many different kinds of income are distinguished in the treatment of income formation in the model but only a few types of income recipients. Transfers that help to make up disposable income for the households mirror the transfers in the government sector which we have already dealt with above. As for factor incomes a first distinction is made between wages and entrepreneur income.

When it comes to income recipients, however, there are only two categories, pensioners and wage earners, although the latter can be split into entrepreneurs and other wage earners. The unemployed are here grouped together with the employed. As long as we cannot make a corresponding separation of the expenditure system for private consumption - and the available data do not allow this as yet

- the value for distributional analysis of a further disaggregation of income recipients is anyhow limited.

The expenditure system for private consumption - the same for all consumers - distinguishes between 14 different commodities. Production within the business sector is more disaggregated, recognizing altogether 23 different sectors. Within each sector there are five different types of factors used, i.e., besides intermediate inputs, capital, labor, fuel and electricity.

Production capital is, however, further disaggregated through the vintage approach, with each vintage being not only ear-marked for a specific branch but also reflecting the relative price expectations in the investment period and thus being potentially different from the rest of the vintages. The difference between different vintages is further enhanced by the fact that a major part of technical development is treated as embodied, which also means incidentally that a major part of productivity changes in manufacturing is explained endogenously in the model by investments and structural change.

Compared to production capital, aggregation has been carried much further with respect to labor. Although there are different wage levels in different manufacturing branches and a lagged development of wage for public employees, labor supply is treated in the model as one homogeneous aggregate. If capital can be said to be treated as "putty-clay", the treatment of labor could be characterized as "putty-putty". Not only are there no human capital distinctions between different kinds of

labor, but there is also no branch or vintage specific labor. In keeping with our ambition to model the various kinds of inertia or adjustment obstacles, it would undoubtedly have been desirable to have a regionally and branchwise segmented labor market with explicit mobility obstacles.

The choice of a suitable level of aggregation is generally difficult and all the more so when, as in our case, you want to be able to do model projections into a distant future. For the use of models over long time periods there are both obvious advantages and disadvantages of aggregation.

The advantages are well-known. Aggregate models are easier to handle and easier to understand. They require less detailed future projections which in turn may make them appear, as more generally valid. From the estimation point of view, there is also the hope that some random or specification errors may get swamped in the aggregation.

The disadvantages are equally self-evident. First of all, there are all the usual statistical problems connected with aggregation. By aggregating relations over different micro units and thereby also hiding their interaction, the derived aggregate relations will be less autonomous the parameters therefore less stable and you may be facing increasing problems of simultaneity between your variables. On top of that you will have the kind of aggregation bias in estimating behavioral reactions which we already discussed above. Many of these aggregation problems become, almost definitionally, more serious as you extend the projections in time.

Equally important is the economic argument against aggregation in long-term studies, which says that by carrying aggregation too far you may altogether miss the possibility of analyzing structural changes that should be a primary concern for any long-term economic study. It is after all mostly in the relation between sectors and more specifically in the capital structures that you have enough inertia and long enough lead-times to be able to make meaningful statements about long-term effects.

Our choice of aggregation levels in the ISAC-model has been pragmatically guided both by the availability of data and by our focus of interest. We chose a more disaggregated treatment of manufacturing because of its importance for foreign trade and international specialization which has been one of our primary concerns. The government sector and particularly the local government sector were likewise dealt with in rather great detail because of our belief that the rapid growth of the government budgets represent a major structural change of importance also for the functioning of the rest of the economy.

1.6 The Short-Run and Long-Run Dynamics

Already the short introductory comments above may have raised the following question in the reader's mind. Is the model mainly meant to describe the short and medium-term functioning of the economy or should it be primarily regarded as an instrument for the analysis of long-term growth and growth policy?

There are undoubtedly many short-run dynamic aspects of the model, that seem to indicate that short-term policy analyses should be its main application. It is meant to be solved year by year, it contains a great number of lag structures, all the usual types of Keynesian multiplier and accelerator loops, a large number of stabilization policy instruments and also some dynamic mechanisms like the Phillips curve and local government behavior, which are central to any explanation of cyclical movements in prices and production.

On the other hand, the emphasis on structural change, the rather detailed treatment of capital formation and capital structure in manufacturing and of long-term energy substitution possibilities, with concomittant explanations of endogenous productivity developments would rather seem to point to an interpretation in terms of long-term growth.

Since the model is neither a full-fledged business cycle model but still close enough to play havoc with any simple and straight-forward growth pattern, the reader might well ask what this hybrid model could really be suited for. As we will be returning to this question of model use later on in the last section, a short comment may be sufficient at this point.

Let us start by granting that the model by no means is competent to handle all short-term effects of short-term policy. Already the absence of financial markets makes its use as a full-fledged business cycle model somewhat suspect. It is undoubtedly more convincing as an instrument to study the long-term effects of long-term policy, a perma-

ment change, say, in currency regime, in the given rate of return requirement, in average profit levels or in household saving habits.

There are, however, two other kinds of studies which particularly require a mixture of short and long-run features in the models used. One is concerned with studying long-term effects of short-term policies, i.e., the way short-run stability characteristics of the economy and the chosen stabilization policy affects long-term growth patterns and possibilities.

The second deals with the contrary problem: the effects on short-run stability and stabilization possibilities of long-term policies. How can, e.g., long-term choices of, say, taxing structure, consumption shares for households, local and central government, respectively, or government price-/interest regulations or guarantees, affect the way the economy reacts later to disturbances from the world markets and the measures required and available for stabilization policies? The ISAC-model has, to a large extent, been particularly tailored for this type of studies of the policy interrelations between short and long run.

2 An Outline of the Model

The full version of ISAC contains hundreds of variables and relationships. The large size of the model is an inevitable outcome of our attempts to model explicitly the structure of the industrial sector. This task requires disaggregation not only between branches but also, we believe, within branches to capture the economy's sluggish accommodation to changing relative prices through dated capital formation.

Since we have also tried to take a policy approach to our modelling efforts the submodels for the household sector as well as the local government sector has been given a detailed design to allow for a fairly realistic treatment of different possible economic political measures.

Although the disaggregation contributes to the size of the model what makes it complex is rather the kind of relations between variables that is specified in the model. The purpose of this chapter is to describe some of these relations in an aggregated model setting. Section 2.1 will give an overview of the model structure while one important mechanism, the wage-price formation, is presented in more detail in section 2.2.

2.1 A key map of the model

Figure 2.1 is an attempt to illustrate the overall structure of ISAC. The figure shows main variables

and submodels and the most important relations between them. The block diagram is built around a sector balance for industry which assures that supply equals demand. The exogenous determinants of the development of the model economy can be divided into two sets. The first set of variables are external to the economy in the sense that neither the development of the economy nor the economic political decision-making is assumed to exert any influence on them. These variables, marked by single-squares in figure 2.1, are world markets (prices and volumes), disembodied technical change, labor supply and, finally, a rate of interest that is assumed to be imposed on the economy from abroad.

The other set of exogenous variables are the policy instruments, indicated by rhombs. They are the exchange rate, central government consumption and various kinds of fiscal parameters affecting the household sector through taxes and transfers as well as the local government sector through i.a. the grant system.

Finally there is assumed to be a policy instrument to influence the wage rate albeit not necessarily completely control it.

Given these two sets of exogenous variables every item of the sector balance will be determined in the way that is outlined below. The demand for intermediary goods in industry (INS) is of course given by current production (x) and the i/o-matrix. Since the present model version only allows for substitution of energy, capital and labor in production processes and no exogenous trends are attached to commodity input coefficients the i/o-matrix is almost constant over time.

Figur 2.1 ISAC-modellens struktur 1981

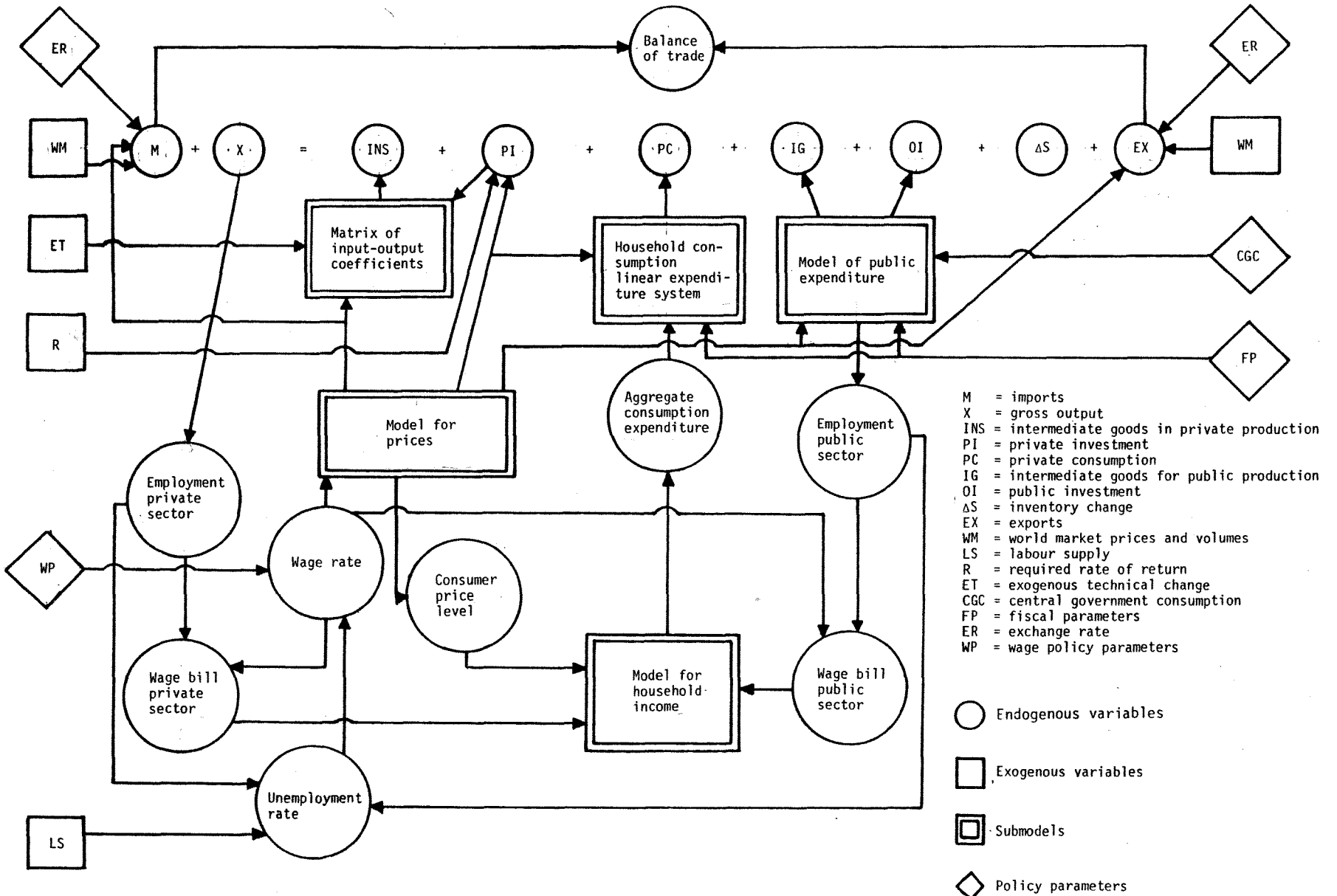

Investments in industry (PI) are determined by investment functions taking account of influences from profit expectations as well as current capacity utilization. Through the vintage mechanism the volume of investment will affect average capital- and labor-productivity in industry. Productivity growth also depends on the rate of scrapping of old vintages which is assumed proportional to quasi-rents earned in each vintage. So far the vintage approach is only implemented for branches in the manufacturing sector while capital in other branches is treated as homogenous in each branch. Also investment functions are specified and estimated only for manufacturing branches and otherwise set either as an exogenous trend or related to production in some simple way.

Private consumption is determined by a rather detailed specification of income and expenditure in the household sector. The main source of gross income is wages and salaries from industry, thus providing the model with a multiplier link between the activity level in the economy and private consumption expenditures shown in Figure 2.2. Starting, as in the figure, with some exogenous change in fiscal parameters (FP), e.g. a reduced income tax rate, household income will increase. Since the savings ratio is a constant fraction of disposable income most of the tax reduction will result in consumption expenditure thus increasing demand for commodities. Some of these will be imported but domestic production and employment will increase creating more wage income and so on. The size of multiplier is also affected by wage inflation as a consequence of the higher activity level in the economy. This mechanism, which is not shown in Figure 2.2., will on the one hand positively

Figure 2.2 The production-consumption loop

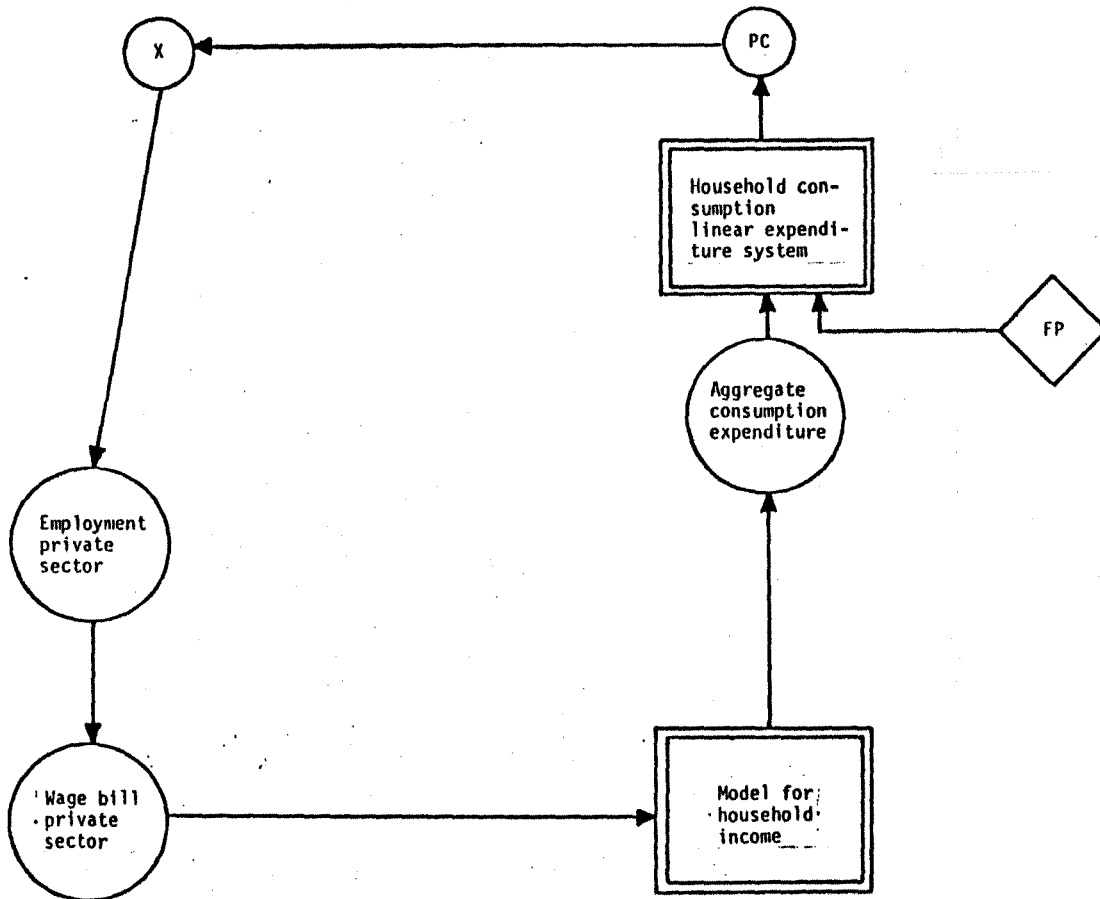

affect total wage income through higher wage rates. On the other hand it will, however, also limit the real multiplier effect through higher inflation, and increased imports and reduced exports following the rise in the domestic price level. The net real effect of these secondary mechanisms after 2-3 years may be positive or negative depending i a on price elasticities in foreign trade and the sensitivity of wages to increased preassure on the labour market. Other important sources of household income are wage, salaries and transfers from the public sector. After deduction of various taxes households are left with disposable income. The savings ratio is assumed fixed and real consumption expenditure is distributed between fourteen consumption categories by a linear expenditure system. The feed-back mechanism between the production system and consumption demand through the household sector is important to explain the model's short term response to an exogenous disturbance, either in the form of e.g. a change in world market growth or in the form of some fiscal measure towards the household sector.

Public sector demand for intermediary and investment goods (IG, OI) is partly a policy variable (central government), partly endogenous (local government). The local government model, as it is presently implemented, tends to produce fairly strong oscillations in the economy through its interactions with the labor market on the one hand and the household sector via the endogenous local tax rate on the other. These links are shown in Figure 2.3.

Figure 2.3 The local consumption - labor market loop

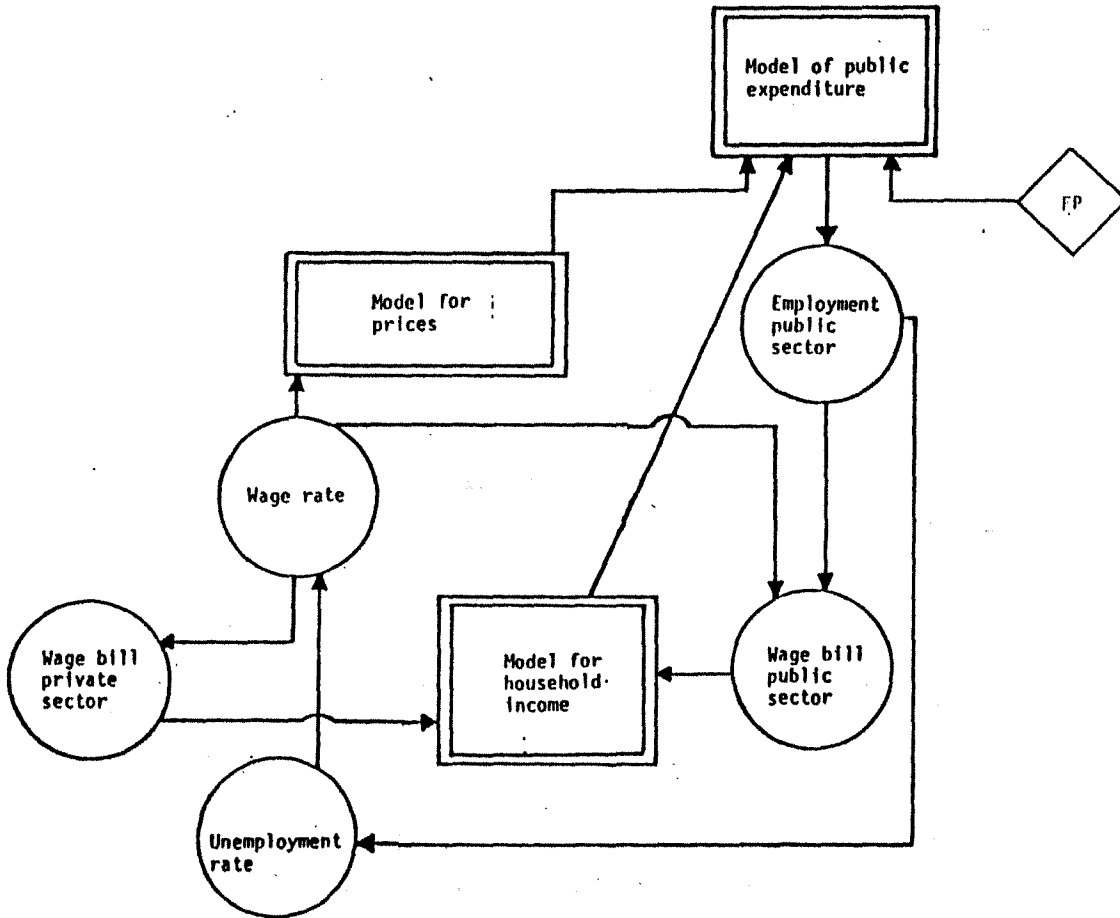

Suppose central government increase their categorical grants to local governments, indicated by a change in fiscal parameters (FP) in the figure. The immediate impact of this measure will be to decrease local governments' net costs of production and hence induce them to step up real expenditures. The grants will also improve their financial situation making tax increases unnecessary. Since no other fiscal measures are assumed, if the original grants increase is not financed by central government taxes, the activity level in the economy will increase and so will employment. The resulting wage inflation will partly "finance" the local government expenditure increase by eroding households' income and by worsening the external balance. But the wage increase will also lead to increased net costs of production for local governments and slow down their expansion. However, because of the two year lag in the disbursement of centrally collected local tax-income, local governments' financial situation will again improve at a time when wages are moderate as a consequence of weak demand. Thus with a two year lag the inflated household income will feed back to local governments' acting as a stimulus to increased expenditures.

Simulation experiments carried out so far with this submodel, reported in Nordström-Ysander (1981) are still on an explorative level¹ and the stability tests discussed in chapter 5 are accomplished with exogenous local governments.

Changes in stocks (ΔS) are modelled in a very simple fashion with total stocks in the economy proportional to production in some "stockholding" branches. Mostly, however, the model is run with exogenous stock investments.

Finally the sector balance for industry includes imports and exports (M,EX). These are, of course, of great importance considering the large export- and import-shares, especially for the manufacturing branches, in the Swedish economy. As discussed in chapter 1 we assume, for aggregational and market structural reasons, that price differentials between imported and domestically produced goods can persist over long periods, and also that Swedish exporters are not necessarily price-takers on the world market. The implication of these assumption is that imports and exports will depend on relative prices and that domestic producers can price themselves out of domestic as well as foreign markets as was the case in the middle of the seventies.

Used together with the wage equation, the foreign trade functions introduce a mechanism that tend to dampen the effects of world market disturbances. The immediate impact of a general world market price increase, for example, will be higher domestic inflation through imports and a preassure on the labor market due to improved relative prices and hence increased net demand from abroad. This will however create both inflation expectations and wage drift on the labor market pushing up wages. The higher wages will not only remove preasures on the labor market but also reduce the initial surplus on foreign account. These mechanisms, indicated in figure 2.4, is further dealt with in Chapter 5.

2.2 Price and wage formation

The previous section gave a summary description of the determination of industry's fixed price sector

Figure 2.4 The foreign trade-labor market loop

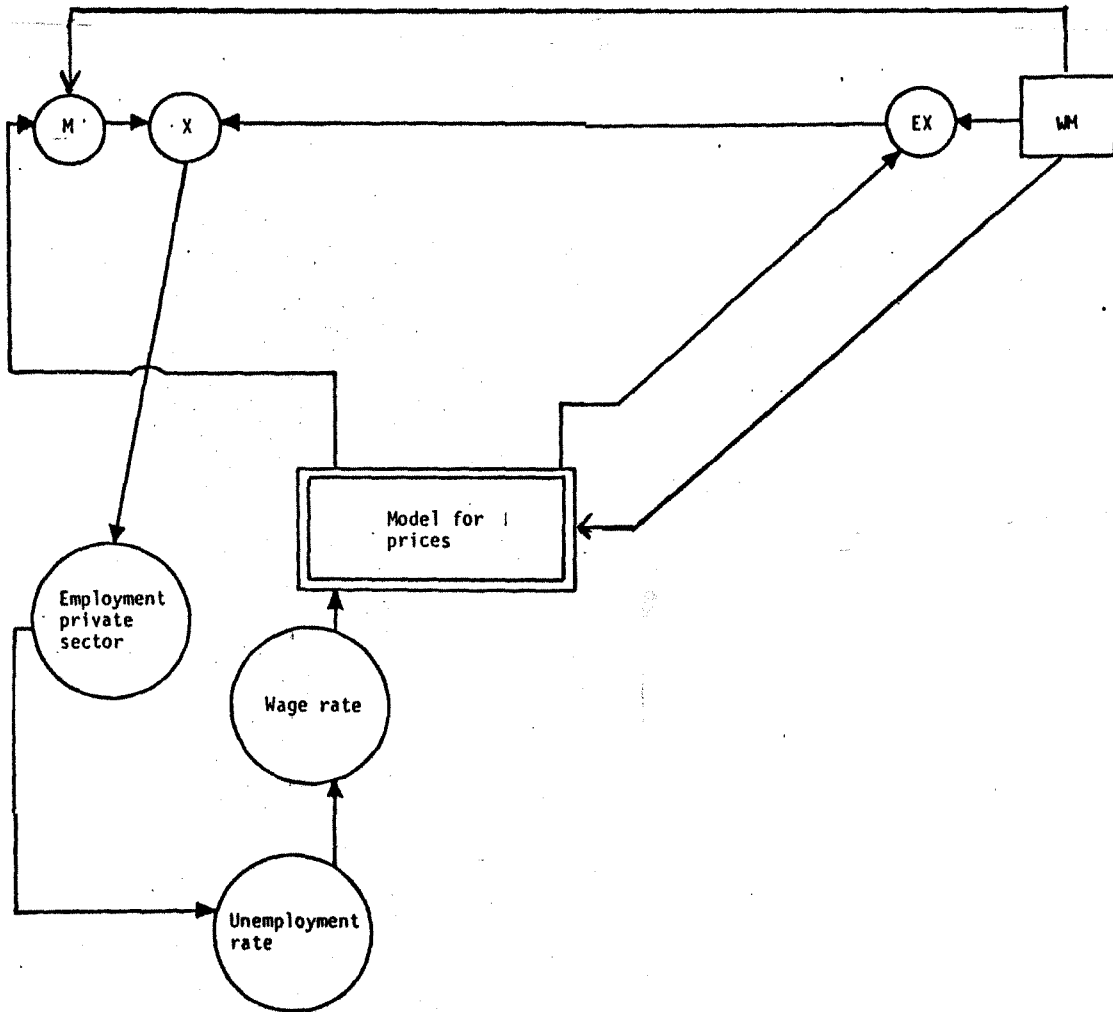

balance in the model. Obviously prices play an important role for the solution of the model. We shall therefore describe the price formation hypotheses and equations that are used in the model.

As mentioned in chapter 1 prices are based on average rather than marginal costs. Unit cost is taken to include "normal" profits, i.e. the mark-up over average operating costs is equal to average capital cost share. Theoretically this kind of pricing can be underpinned by assuming market imperfections and adjustment costs. It also seems to be well in accordance with observed behavior.

For a small country, however, with large export shares it seems natural that producers not just pass on their costs to the world market without regard to competitors' prices. The price equations in ISAC also allows for such an influence and are accordingly specified as a geometric average of unit cost and world market price (in Swedish currency):

$$P \sim C^\alpha \cdot PW^{(1-\alpha)} \text{ or } \dot{P} = \alpha \cdot \dot{C} + (1-\alpha) \cdot \dot{PW}$$

where dotted variables are growth rates. The size of the parameter α is of crucial importance. Obviously α equal to unity implies pure mark-up pricing. On the other extreme, with α equal to zero, producers are assumed always to follow world market prices. The implications of the two extremal points of the interval for α are shown in figure 2.5. Initially domestic prices, costs and world market prices are assumed to coincide ($P_0 = PW_0 = C$). Facing the demand curve E_0^D for Swedish products, exports will amount to E_0 . Now we introduce a shift in world market prices, ΔPW .

Figure 2.5 Export Effects of Different Pricing Parameters

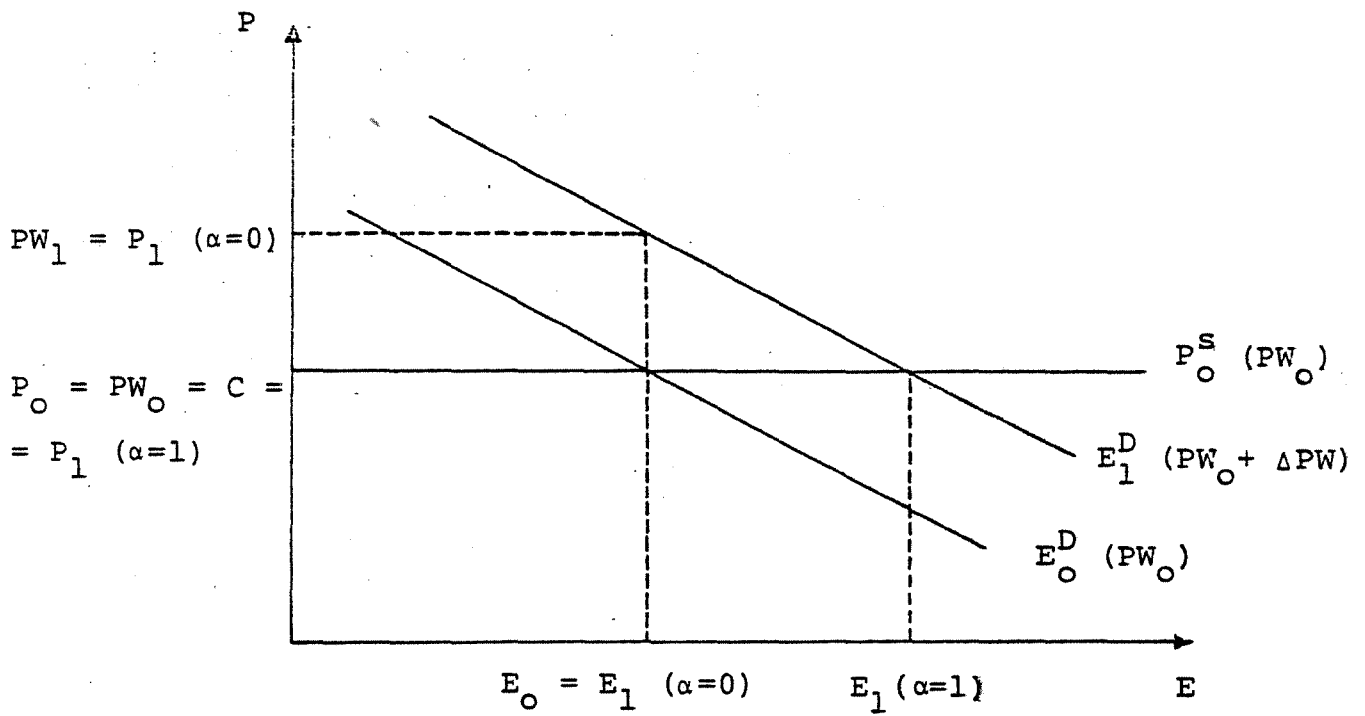

Equations:

$$P^S = C^\alpha PW^{1-\alpha}$$

$$E^D = (P/PW)^{-\beta}$$

Suppose that $\alpha = 1$, i.e. that pure mark-up pricing is used, and that the cost curve does not shift. Then the Swedish export price will still be equal to P_0 making it possible to gain market shares in face of the new export demand curve E_1^D as a result of competitors' price increase ΔPW . Exports will rise to $E_1(\alpha = 1)$ in the figure. If on the other hand α is zero exports will not change at all despite the world price increase since domestic producers will simply let their prices follow on. Of course, with constant costs this will increase profits.

This situation does however not correspond to the common "small country assumption" with purely price taking domestic producers. Although export prices are set by the world market, producers are also assumed to face a totally elastic demand curve meaning that they can sell all they want at prevailing prices. With our assumption that foreign demand for Swedish products have limited price elasticities, producers setting their price equal to the average world market price, will only retain their market share and may not be able to sell all they wish at that price.

In the discussion above costs were for simplicity assumed to be unaffected by the world price increase. Of course price increases abroad will influence domestic inflation. One way world inflation will be felt is through imported goods. Another is through price increases by domestic producers if they take the opportunity to raise their profit margins.

However, the model economy also includes an internal source of inflation in the shape of a kind of

an expectations augmented Phillip's curve where the overall wage rate growth is explained by last year's consumer price growth, the inclusion of which can be thought of as either an expectational or a compensatory element in the wage formation process,² the current rate of unemployment, profit levels and finally productivity growth.

Theoretically justifiable Phillip's curves can be specified in a great many ways. Two features of this particular specification should be noted since they are important to the model behavior. The first one is the rather unsophisticated formation of expectations that is assumed. It rather may seem more natural to view the one year lagged consumer price variable as a compensatory mechanism for past inflation especially since the parameter was estimated not to differ significantly from unity. The second noteworthy characteristic of the chosen wage equation is the absence of lags in the unemployment variable.³ These two properties make wages react very quick and strong to inflationary pressures making e.g. the domestic consequences of external inflationary shocks fade away in a rather short period.

Notes

¹ Cf Nordström-Ysander, 1981.

² Estimated parameter values are given in chapter 4.

³ Various lags were tried when estimating the equation, cf Jansson, forthcoming.

3 The equations of the model

3.1 Definitions and conventions

The following definitions and conventions have been used in this chapter

Large romans = matrices

Small romans without subscripts = vectors

Small letters with subscripts = scalars

Superscripts = indices of categories etc.

Subscripts = indices of branches, goods etc.

"Roofed" letters are vectors turned into diagonal matrices

The transpose of a vector or matrix is denoted by "' ", e.g. x' .

(t-n) = n-year lag. When no time indication is given, time t is assumed.

Dotted variables indicate growth rates, e.g. $\dot{x} =$

$$= \frac{dx}{dt} \cdot \frac{1}{x}$$

Parameters are mostly named by small greek letters or in the case of simple constants by roman a or b with appropriate subscripts and occasionally a superscript indicating explained variable or the like.

3.2 Commodity balances in fixed and current prices

The following two accounting identities state that total domestic demand (right hand side) is equal to total domestic supply (left hand side) for every commodity.¹

$$m + x = Ax + inv + pc + pu + ds + e$$

$$\hat{p}^m m + \hat{p}^x x = \hat{p}^h (Ax + inv + pc + pu + ds) + \hat{p}^e e$$

3.3 The i/o matrix

The i/o matrix for the manufacturing industry is calculated from a vintage model of production technique for each of the 14 branches in the sector.²

Aggregated input coefficients in a new vintage at time t are given by a constant elastic function in last year's input prices:

$$Q_{m,i}^t = a_{m,i} \prod_n p_{n,i} (t-1)^{\alpha_{m,n,i}}; \quad i = 1, \dots, 14$$

where $m, n = 1$ for intermediate goods

2 for electricity

3 for fuels

4 for labor

5 for capital

The sum of the elasticities $\alpha_{m,n,i}$ over n is zero which makes the input share function homogenous of degree zero, i.e. a proportional increase in all prices will not affect the choice of technique.

The input share equations can not be achieved from cost minimization of a common production structure, so the constraints derived from the classical demand theory are not satisfied. The reason to leave the firm theoretical grounds is purely pragmatic. The constant elastic form used makes it practically possible to foresee and track the

impact of price changes on the technical development.

The $\alpha_{m,n,i}$ used are calculated from estimated translog functions, see Dargay, J. (1981), at the observed sample average. Since the variations in the elasticities calculated over the observed period are moderate in spite of considerable changes in relative prices the constant elastic functions can be regarded as approximations to proper share functions.

Assuming that i/o coefficients in a vintage are independent of utilization ratios and that all vintages are used at the same intensity level the capacity distribution over vintages can be used to calculate overall i/o coefficients in a branch. The capacity distribution in a branch is calculated from gross investments and scrapping of old vintages.

New capacity in branch i is given by gross investments and the chosen capital output coefficient

$$\bar{x}_i^{-t} = g_i / Q_{5,i}^t$$

Remaining capacity in old vintages depend on the rate of scrapping which is assumed inversely proportional to the quasi-rent earned by each vintage

$$d_i^v = \sum_{n \neq 5} Q_{n,i}^v p_{n,i}(t-1) / p_i^x(t-1) d_i; \quad v = 0, \dots, t-1$$

Although this criterion will speed up the scrapping of old capacity in times of changing relative prices it will still allow vintages earning negative quasi-rents to be run for several years.

Given the rate of scrapping current production capacity in old vintages in manufacturing branch i is straight forward

$$\bar{x}_i^v = (1-d_i^v) \cdot \bar{x}_i^{v-1} ; v = t_0, \dots, t-1$$

and the distribution of capacity over vintages is

$$\bar{x}_i^v = \bar{x}_i^v / \bar{x}_i$$

where \bar{x} is total capacity

$$\bar{x}_i = \sum_v \bar{x}_i^v$$

This will finally give us overall aggregated input coefficients for manufacturing branches as

$$Q_{n,i} = \sum_v Q_{n,i}^v \bar{x}_i^v ; \begin{matrix} n = 1, \dots, 5 \\ i = 1, \dots, 14 \end{matrix}$$

The matrix of aggregate input coefficients for the manufacturing sector thus depends on the pace with which new capacity (and technology) is installed and old phased out and accordingly becomes a slowly moving function of relative prices in the economy.

The aggregated i/o coefficients $Q_{n,i}$ with $n = 1, 2, 3$ is transformed to the standard 23 input goods format by matrix H giving the i/o matrix A for the manufacturing sector

$$A_{j,i}^m = \sum_n Q_{n,i} H_{j,n,i} ; \begin{matrix} n = 1, \dots, 3 \\ i = 1, \dots, 14 \\ j = 1, \dots, 23 \end{matrix}$$

The $Q_{4,i}$ is and $Q_{5,i}$'s are the inverse of respectively labor and capital productivity in each branch.

For the 9 branches outside the manufacturing sector there is no vintage approach adopted as yet in the model. For these branches capital stocks are assumed to be homogenous and aggregate input shares are given by a constant elastic function in input prices. The disaggregated i/o matrix for these 9 branches, A^0 , is then compiled in the same way as A^m .

Finally A^m and A^0 are combined to give the total 23x23 i/o matrix $A = (A^m, A^0)$.

Investments, input shares and depreciations are all functions of only predetermined variables which means that they are not dependent on the model solution for year t and accordingly neither is A .

The assumptions that all vintages are used at the same intensity level and that i/o ratios are independent of the utilization rate implies that the A matrix describes the input-output relations not only at full capacity production but also at any other actual production level. It also means that the utilization rate can be calculated at "branch level" for the whole business sector, disregarding the vintage structure in manufacturing branches:

$$ur_i = x_i / \bar{x}_i \quad ; \quad i = 1, \dots, 23$$

3.4 Energy substitution³

Five energy carriers are distinguished in the model: electricity, distant heating, oil, coal and domestic fuels. Energy consumption is accounted for in these five categories for each of the 23 business sectors, for the public sector and for the household sector.

The substitution between different energy forms in the business sector is assumed to take place in two stages. In the first stage a new production technique with five inputs is selected: electricity, fuel (incl. heating where appropriate), other intermediate goods, labor and capital as described in section 3.3.

In the second stage the choice between different kinds of fuels is made. It is assumed that ex post substitution is possible in all branches in this stage. The shares q^f for coal and domestic fuels of total fuel consumption depend on price according to the following relation:

$$q_{j,i}^f = a_{j,i} \cdot (b_{j,i} - p_{j,i} \mu_{j,i}) ; \begin{matrix} i = 1, \dots, 23 \\ j = 1, 2 \end{matrix}$$

where $j = 1$ for coal

2 for domestic fuels

The p 's are up to five year lagged energy prices, including capital cost, relative to the price of oil produced energy. Since the aggregate use of fuels is the sum of oil, coal and domestic fuels (all measured in Twh), the share of oil is determined as a residual. The above relation thus does not describe the choice of optimal fuelshares at

given prices, but rather the sluggish accommodation of energy demand to changing price relations.

The rationale behind the two stage procedure for determination of energy demand in the business sector is the assumption that the choice of fuel have negligible effects on the rest of the installed production technique. This seems to be a good approximation in many cases since fuel is mostly used to produce heat and the heat production unit may be fairly separate from the rest of the production process.

3.5 Investments in the business sector

Investments in each branch of the manufacturing sector is determined by past profits and capacity utilization

$$g_i = k_i(t-1) \left(\sum_{j=1}^4 \gamma_{j,i} ep(t-j)_i + \delta_i \right) ur_i(t-1)$$

where the parameters $\gamma_{j,i}$ are all > 0 ep_i is an "excess profit" index relating realized gross operating surplus to the user cost of capital

$$ep_i = (va_i - \omega_i l_i) / p_i^k k_i$$

p_i^k is the cost of capital in branch i defined as

$$p_i^k = p_i^g(r_i(r_\omega))$$

where r_i is the required rate of return in branch i , calculated as a function of the exogenous rate

of interest r_w , and p^g the price of investment goods for branch i .

In branches outside the manufacturing sector investments are either exogenous or related to production in the branch.

To account for demand for different goods generated by investment activities the composition of gross investments is assumed to differ between branches but to be constant over time:

$$\text{inv} = G g$$

where G is a matrix converting investments in investing branches into commodity demand directed towards producing branches.

3.6 Foreign trade

The volume of export, e , and import, m , depends on market size and relative price for each commodity.

The general form of the export functions are

$$e_i = a_i^e \prod_{j=0}^1 [p_i^e(t-j) / (\theta p_i^w(t-j))]^{\beta_{i,1+j}} w_{m_i}$$

where p^e and p^w are Swedish export price and world market price respectively. The export price is expressed in Swedish currency while the world market price is expressed in foreign currency. θ is the exchange rate. The size of the world market is given by index w_m for each good.

The import functions have a similar structure:

$$m_i = a_i^m \prod_{j=0}^1 [\theta p_i^w(t-j)/p_i^{xh}(t-j)]^{\gamma_{i,1+j}} h_i^{\gamma_{i,3}}$$

Swedish producers' price of commodities sold on the domestic market, competing with imports, is p_i^{xh} . The variable h is total domestic demand.

As the foreign trade equations show exports and imports depend on prices relative to the world market with at one year lags. For many commodities lagged relative prices affect current export/import volume as much as current price relations.

3.7 Disposable income in the household sector

The submodel for household income distinguishes between two kinds of individuals. "Pensioners" are people with most of their income from the social security system. The remainder is simply called "wage-earners" although it includes the total labor force, i.e. entrepreneurs as well as unemployed persons.

Individuals receive factor-income, capital-income and transfers from other sectors. After deduction of income- and payroll-taxes, and transfers to other sectors they are left with disposable income.

Factor income

The main part of factor income is gross wages and salaries, including payroll taxes and other collective fees, but factor income also includes part of net surplus in producing sectors.

Gross wages and salaries is the product of wage/hour and the number of hours worked in different sectors plus the public sector:

$$Y_{11} = \omega^i \cdot l + w^{s'} \cdot l^s + \omega^{l'} \cdot l^l$$

$$Y_{12} = he' \cdot l \cdot va$$

where he is entrepreneurs' share of total hours worked in each branch and va is value added (i.e. their productivity is assumed equal to the employees'). According to National accounting conventions Y_{12} also includes imputed income from owner-occupied houses.

Capital income

Capital income include interest-payments calculated as a constant fraction of entrepreneurs' income:

$$Y_{21} = a_{21} \cdot Y_{12}$$

Other net capital income is calculated from financial assets, fa , which in turn are accumulated from total financial surpluses and deficits of the household sector.

$$Y_{22} = a_{22} \cdot fa$$

Transfer income

This part of the submodel is fairly disaggregated and to a large extent exogenous except for inflation. There are six different types of transfer incomes:

- 1: National general pension (old age plus others)
- 2: Ditto local
- 3: National supplementary pensions
(old age plus others)
- 4: Private (collective) pensions (old age)
- 5: Other transfer income (non-taxable)
- 6: Other transfer income (taxable)

The first four items are calculated as number of persons, np , times real income per capita, rp , and inflation (consumer price index):

$$Y_{3i} = np_i \cdot rp_i \cdot cpi; \quad i = 1, \dots, 4.$$

Other transfer income, which mainly goes to wage earners, is divided according to whether it is taxable or not.

Non-taxable transfer income is set by an exogenous trend plus inflation:

$$Y_{35} = a_{35} \cdot \exp(b_{35} \cdot t) \cdot cpi.$$

Taxable transfers are divided into sickness benefits, unemployment benefits and others. Sickness benefits are assumed to be proportional to wage sum while unemployed persons receive a constant fraction of average wage income per employee.

$$Y_{36} = a_{36} \cdot Y_{11} + a_{37} \cdot Y_{11} \cdot u + a_{38} \cdot \exp(b_{36} \cdot t) \cdot cpi$$

Transfer payments

Five types of transfer payments are distinguished:

- 1: National income tax
- 2: Local income tax
- 3: Social security contributions
- 4: Other payroll fees
- 5: Other transfer payments.

National income tax is calculated from an aggregate progressive tax-function:

$$Y_{41} = a_{41} \cdot \text{skind} \cdot n_b (\text{besk}/\text{skind}/n_b) b_{41}$$

where the tax index skind is one year lagged consumer price index and n_b is number of assessed persons.

Taxable income, besk, is a fairly complicated function taking account of different kinds of deductions from gross income

$$\text{besk} = F_b (Y_{11}, \dots, Y_{36})$$

Local tax is calculated from taxable income using the local tax rate utd:⁴

$$Y_{42} = \text{utd} \cdot \text{besk}$$

Payroll taxes and fees are shares of total gross wage:

$$Y_{43} = a_{43} \cdot Y_{11}$$

$$Y_{44} = a_{44} \cdot Y_{11}$$

Other transfer payments are calculated as:

$$Y_{45} = a_{45} \cdot \exp(b_{45} \cdot t) \cdot \text{cpi}.$$

Disposable income

Summing up incomes and payments we get disposable income for the household sector as

$$y_d = \sum_{j=1}^6 \left[\sum_{i=1}^3 y_{ij} - y_{4j} \right]$$

3.8 Private consumption

Consumption expenditures per capita equals disposable income less savings. Savings are set as a constant fraction, s_r , of disposable income and total population is n_s

$$cp = (1-s_r) \cdot y_d/n_s$$

Total consumption expenditure per capita is distributed on 14 consumer goods by a linear expenditure system:

$$p_i^c c_i = \gamma_i p_i^c c_i(t-1) + \beta_i \left(c_p - \sum_{k=1}^{14} \gamma_k p_k^c c_k(t-1) \right)$$

$$\text{where } \sum_{j=1}^{14} \beta_j = 1 \quad i=1, \dots, 14$$

The price vector p^c represents the prices of domestic absorption, p^h , converted to the consumer goods level by a constant matrix PK:

$$p^c = PK \cdot p^h.$$

Private consumption per capita is then transformed to total private consumption at the 23 commodity level:

$$pc = PK \cdot c \cdot n_s$$

3.9 Central government

The development of central government consumption is exogenously determined. Seven different consumption purposes are distinguished.

- 1: National defense.
- 2: Public order and safety.
- 3: Education.
- 4: Health.
- 5: Social security and welfare services.
- 6: Roads.
- 7: Other services.

The rate of growth of production, x_s , and consumption, cs , for the various purposes is a constant proportion, gr , of an exogenously given common growth factor g_0 .

$$x_s = g_0 \cdot gr$$

$$cs = (I-sa) \cdot x_s$$

where the $sa:s$ are shares of sales from production.

The need for intermediate goods is related to production in each central government sector. Together with exogenous investments this gives central government demand from the 23 business branches:

$$f_s = SG \cdot x_s + sg \cdot i_s$$

where aggregate central government investment is i_s . SG is a constant conversion matrix and sg a ditto vector.

3.10 Local government

Production within local governments are split into five categories.

1. Education.
2. Health.
3. Social welfare.
4. Roads (total expenditures).
5. Central administration, fire service etc.

These expenditures are explained by linear expressions of the following form:

$$x_{li}^l = a_{1i} z_{1i} + a_{2i} z_{2i} + a_{3i} z_{3i} + a_{4i} z_{4i} + a_{5i} z_{5i}$$

where z_{1i} are shift variables, z_{2i} and z_{3i} stand for investment consequences and capacity restrictions, while z_{4i} and z_{5i} reflect the impact of changes in real income, local tax rates and relative prices⁵.

As with central government sales made by local authorities of goods and services at market prices are assumed to be a constant fraction of local production giving local consumption as

$$c_l = (I - l_a) \cdot x_l$$

Aggregate investments by local authorities are explained by a gradual adjustment to desired capital stock levels, with the rate of adjustment depending on capital good prices, interest rates, liquidity situation and real income development.

$$\Delta kp = a_{16}z_{16} + a_{26}z_{26} + a_{36}z_{36} + a_{46}z_{46} + a_{56}z_{56}$$

$$z_{16} = kp; \quad z_{26} = \Delta kp^*; \quad z_{36} = \Delta liq(t-1) \cdot z_{16};$$

with kp is actual and kp^* desired real capital stock and Δliq is the change in local authorities' liquidity.

$$z_{46} = \phi_6 \cdot kp^2 \cdot r \cdot \frac{besk}{besk(t-2)}$$

with ϕ_6 , net real price of capital goods, defined in the same way as ϕ_i .

$$z_{56} = (1-utd-av_0)besk \cdot z_{46} \cdot z_{16}$$

where av_0 is nominal fees.

The depreciation is assumed to be a constant fraction of existing capital stock. Gross investments then becomes

$$i_l = \Delta kp + a_{66}z_{66}$$

where a_{66} is the depreciation rate and $z_{66} = kp(t-1)$.

Investments may also be computed in a simplified manner as equal to desired capital stock changes plus reinvestments.

The local governments' expenditures on production and investments are converted final demand of commodities from the business sector by LG and lg :

$$f_l = LG + x_l \cdot + lg \cdot i_l$$

Together with central government's demand this gives total public sector demand for commodities from the business sector:

$$p_u = f_s + f_l$$

Transfer payments, t , are split into two categories, - subsidies to public utilities and direct transfers to the household sector. In the model the explanation of these payments is derived from the idea that the provision of housing space and of public utilities are arguments in the local governments' goal function, pursued indirectly by way of "price subsidies".

$$t_i = a_{2i} \zeta_i + a_{3i} \mu_i + a_{4i} \gamma_i$$

$i=1,2$ 1 = public utilities subsidies
 2 = direct household (housing) subsidies,

where ζ_i represents the cost for the households relative to disposable income and μ_i and γ_i express the impact of developments in real income, local tax rate and relative prices.

The transfer payments can alternatively be treated in a simplified manner. The net amount of subsidies to public utilities are then approximated as a constant fraction of production in sector 18 (electricity, heat etc.). Direct household transfers are set as a linear function of households' housing expenditures (z_{13}).

Local government expenditures are financed by taxes and state grants with liquidity changes acting as a buffer against planning failures. Given state grants (sb_0), net borrowing (Δdt), other net income (C_0), and interest payments (rdt) the local tax rate is determined residually by way of the budget restriction:

$$utd = \frac{besk}{besk(t-2)} [-utd(t-2)(besk(t-2) - besk(t-4)) - sb_0 - \Delta dt - e_0 + rdt]$$

To simulate possible restrictions or inertia in local government political behavior, the model can alternatively be supplemented with a floor restriction on the tax rate complemented with a rule, prescribing that planned surpluses un above a certain relative level are used to scale up current expenditure.

3.11 Stock building

Total change of stocks, ds_a , in the economy is exogenous in the model. The commodity composition of stock investment goods, sc , is assumed constant over time. Inventory demand for commodities thus becomes

$$ds = sc \cdot ds_a$$

A simple stock building model can be included when necessary. Still only one aggregate inventory good is distinguished but demand for inventories is generated by four aggregate stockholding branches. The four branches are foresting, agriculture and fishing, producers of intermediate goods, produ-

cers of finished goods and the wholesale and retail trade. Stocks are assumed proportional to production, y_i , in these aggregate branches which gives total stockholding as:

$$s_a = \sum_j s_j = \sum_j a_j y_j; \quad j=1, \dots, 4$$

and

$$ds = sc \cdot ds_a = sc \cdot [s_a(t) - s_a(t-1)]$$

3.12 Prices

As is evident from foreign trade equations Swedish prices on foreign and domestic markets are allowed to differ from world market prices. These differences make Swedish producers loose or gain market shares. It is furthermore assumed that the export price, p^e , may differ from the price, p^{xh} , set for the domestic market.

$$p_i^e = a_{i1} (p_i^w)^{a_{i2}} uc_i^{a_{i3}} ur_i(t-1)^{a_{i4}}; \quad i = 1, \dots, 23$$

$$p_i^{xh} = b_{i1} (p_i^w)^{b_{i2}} uc_i^{b_{i3}} ur_i(t-1)^{b_{i4}}; \quad i = 1, \dots, 23$$

The unit cost of production, uc , is calculated as

$$uc = A \cdot p^h + vac$$

with

$$vac_i = [w_i \cdot l_i + p_i^k \cdot k_i] / x_i$$

that is, value added at normal profits.

The price equations above can be seen as a (more realistic) compromise between the common extreme assumptions of either a pure "cost plus" behavior or a "EFO" assumption, where producers exposed to foreign competition are pure price takers.

Given the Swedish producers' prices on the domestic market and import prices the implicit price index for commodities on the domestic market, p^h , is calculated as

$$p_i^h = [(x_i - e_i)p_i^{xh} + m_i \cdot \theta \cdot p_i^w] / h_i$$

with

$$h = x - e + m$$

Adding export value and value of home market sales gives the unit price of domestic production:

$$p_i^x = e_i \cdot p_i^e + (x_i - e_i) \cdot p_i^{xh}$$

For all business sectors gross profit Π_i will be determined residually:

$$\Pi_i = (p_i^x - A_i^h p^h) x_i - w_i l_i - i_i$$

where A_i denotes column i of the matrix A and i_i is indirect taxes.

3.13 Employment

Total employment in the economy is derived from production and productivity in each sector.

For the business sector employment in branch i is given by

$$l_i = x_i \cdot Q_{4,i} \quad ; \quad i = 1, \dots, 23$$

For the public sector labor input coefficients, q^s and q^l , are exogenous although occasionally subject to a trend development:

$$l_i^s = x_{s_i} \cdot q_i^s \quad ; \quad i = 1, \dots, 7$$

$$l_i^l = x_{l_i} \cdot q_i^l \quad ; \quad i = 1, \dots, 7$$

Together with an exogenous labor supply, l_s , these equations give the unemployment rate:

$$u = (l_s - x \cdot Q_4 - x_s \cdot q^s - x_l \cdot q^l) / l_s$$

where Q_4 is the vector of labor input coefficients in the business sector.

3.14 Wages

The changes in the wage rate is the same for all branches in the business sector and is determined by a kind of Phillips curve:

$$\dot{w}_0 = a_0 + a_1 \cdot \text{cpi}(t-1) + a_2 (u - u_0) + a_3 [\Pi^m(t-1) - \Pi_0] + a_4 \dot{Q}_4^m(t-1)$$

Thus the change in the wage rate is a function of current deviation of the unemployment rate from a "normal" or "frictional" unemployment rate (u_0), past inflation, $\text{cpi}(t-1)$, past deviation from a "normal" level of aggregate gross profit margin Π_0 in the manufacturing sector and finally past

change of aggregate labor productivity in the manufacturing sector (Q_4^m is aggregate labor input coefficient, i.e. the inverse of labor productivity). It is assumed that wage changes in the public sector is lagging one year behind the business sector.

Wage rate growth is thus given by

$$\dot{w}_i = \dot{w}_0 \quad ; \quad i = 1, \dots, 23$$

$$\dot{w}_i^s = \dot{w}_0 (t-1); \quad i = 1, \dots, 7$$

$$\dot{w}_i^l = \dot{w}_0 (t-1); \quad i = 1, \dots, 7$$

NOTES

¹ A list of symbols is found in Appendix B.

² A detailed account of the vintage approach as applied to the iron and steel industry is given in Jansson, 1981.

³ A more thorough account of energy substitution in the model is given in Nordström-Ysander, 1983.

⁴ Y_{42} is the local tax payed in year t . However, as spelled out in the local government model below it only reaches local authorities in year $(t-2)$.

⁵ All expressions explaining local authority behavior are derived from maximizing a quadratic goal-function under a budget restriction. A detailed account of the model is given in Ysander, 1981.

4 Implementation

This chapter deals with some aspects of the implementation of the model to make it fit for practical use. The data base is fairly large and will not be given in full here. We will be satisfied to report parameter values for some important equations. This is done in section 4.2. Before that, however, section 4.1 will list the level of disaggregation of some main variables.

Since the model is large and complex the method used to solve it will be of paramount practical importance. The solution algorithm is described in Section 4.3.

4.1 Level of aggregation

The fundamental level of aggregation in the model is the distinction between 23 producing branches in the business sector. These are listed in Table 4.1 along with their SNI-classification numbers. Branches 4-17 (sometimes including branch 3) are referred to as the manufacturing sector. To give a hint of the relative size of the branches the last column also show fixed price value added in percent of sector total in 1980.

The basic classification shown in Table 4.1 is also used for commodities and it is assumed that output of every branch is homogenous at this level of aggregation.

Public consumption is disaggregated into thirteen real expenditure purposes - seven in central government sector and six in local government

Table 4.1 Classification of branches in the business sector

Name	SNI	Value added ^a (percent)
1. Agriculture, fishing	11,13	3.0
2. Forestry	12	2.4
3. Mining and quarrying	2	0.8
4. Manufacture of food (sheltered)	3111-1 3116-8	2.1
5. Ditto (exposed)	3113-15 3119,3121-1	0.9
6. Manufacture of beverages and tobacco	313-4	0.4
7. Textile, wearing apparel	32	1.2
8. Manufacture of wood, pulp and paper	33,341	6.1
9. Printing and publishing industries	342	2.0
10. Manufacture of rubber products	355	0.3
11. Manufacture of industrial and other chemicals, and plastic products	351-2	2.3
12. Petroleum and coal refineries	353-4	0.2
13. Manufacture of non-metallic products (except products of petroleum and coal)	36	1.1
14. Basic metal industries	37	1.9
15. Manufacture of fabricated metal products, machinery and equipment, excl ship- building	38 excl 3841	13.8
16. Ship building	3841	0.6

Name	SNI	Value added ^a (percent)
17. Other manufacturing industries	39	0.2
18. Electricity, gas and water	4	3.3
19. Construction	5	9.7
20. Wholesale and retail trade	61-2	13.8
21. Transport, storage and communication	7	8.7
22. Letting of dwellings and use of owner-occupied dwellings	83101	10.4
23. Other private services	Rest of 6,7,8 and 9 ^b	14.9
Total business sector	1-9	100.0

^a At 1975 producer prices.

^b Private part. Public authorities do have some activities also in other branches These are, however, disregarded.

sector.¹ These thirteen categories, listed in Table 4.2, are also used to describe production within the public sector. It should be noted, however, that public enterprises are classified among business branches according to Swedish national accounting conventions.

Finally, private consumption is divided into fourteen categories, shown in Table 4.3, which are more suitable for analysis of demand than the basic 23 commodities division. The distribution of domestic private consumption expenditures between categories are determined by a linear expenditure system (cf sections 3.8 and 4.2) and converted to demand for commodities.

4.2 Values of essential parameters

This section presents parameter values of the main behavioural equations. Most of them, but not all, are estimated from historical data. Technical matters about estimation procedures will be omitted but references are given to more complete presentations.

The main set of parameters that are not properly estimated relates to the price formation equations, which give domestic producers' prices as functions of costs and world market prices. There is a distinction in the model between domestic producers' export prices (p^e) and import competing prices (p^{xh}):

$$p_i^e = a_{i1} \text{cost}_i^{a_{i2}} (\theta p_i^w)^{a_{i3}}; \quad a_{i2} + a_{i3} = 1$$

$$p_i^{xh} = b_{i1} \text{cost}_i^{b_{i2}} (p_i^m)^{b_{i3}}; \quad b_{i2} + b_{i3} = 1$$

Table 4.2 Classification of public consumption

Name	Classification according to Swedish national accounts	Central government consumption in 1979 (percent) ^a	Local government consumption in 1979 (percent) ^a
1. National defence	20	10.5	-
2. Public order and fire protection	13	4.0	0.9
3. Education	30	2.9	17.9
4. Health	40	1.2	23.2
5. Social security and welfare services	50	4.2	13.6
6. Roads	85	0.9	1.5
7. Other public services	6,7,rest of 8,9	8.2	11.0
Total public consumption	1-9	31.9	68.1

^a Of total public consumption at 1975 year's prices.

Table 4.3 Classification of private consumption

Name	SNA	Per cent ^b
1. Food	11, 7132, 7136	19.9
2. Beverages, tobacco	12-14	6.9
3. Clothing and footwear	20, 822(p) ^a	9.4
4. Cultural services	723-5, 73, 862	4.9
5. Personal care and effects	452, 512, 81	1.8
6. Gross rents and water charges	31	19.4
7. Private transport	611, 621(p), 623	5.5
8. Recreation	4114, 52, 612, 621(p), 71 excl 71320 and 71360 721-2, 821 822(p)	7.4
9. Furniture	41 excl 4114 42-4, 451	6.9
10. Other consumption	Rest of 1-8	6.7
11. Electricity	321	2.0
12. Gas, fuels, steam	322-5	2.1
13. Gasoline	622	2.6
14. Purchased transports	63	2.6
Total private domestic consumption expenditure	1-8	98.1
Foreign travel, net	9	1.9
Total private consumption	1-9	100.0

^a P(p) denotes part of SNA-number

^b Of total private consumption expenditure 1980 in 1975 year's prices.

The sum of exponents for each branch (commodity) is in both cases restricted to unity giving domestic producers' prices as geometric averages of production costs and world market prices.^{2, 3} With a_{i2} and b_{i2} equal to unity companies are assumed to compensate all domestic cost increases on the world market thereby protecting their profit ratios even in the face shrinking market shares - at home as well as abroad. On the other hand such price behavior also make companies use reduced costs or increased world market prices (e g through currency devaluation) to improve their competitiveness with increased demand on domestic and foreign markets as a consequence. (Cf section 2.2.) The reverse will of course follow if the a_{i2} :s and b_{i2} :s are close to zero.

As stated above we have not carried out any econometric analysis of price parameters of our own. Intuitively it seems reasonable that the sensitivity to world market prices will vary considerable between branches, depending on type of commodity and on the degree of exposure to foreign competition. This conclusion is supported by Calmfors and Herin (1979) which so far is the only attempt to estimate price equations on Swedish data at a disaggregated level. Contrary to conventional wisdom, Calmfors and Herin estimated a rather low influence from world market prices and a corresponding high sensitivity to domestic cost factors.

This was the case even for highly exposed branches with fairly homogeneous outputs such as paper and pulp, and iron and steel industries.

We have felt free to vary the price parameters in different applications of the model and also some-

times to let the price behavior differ between foreign and domestic markets (i.e. $a_{i2} \neq b_{i2}$ and $a_{i3} \neq b_{i3}$). The standard set of parameters are shown in Table 4.4, which give the industrial branches in order of assumed increasing influence from world market prices on their own price setting behavior. As can be seen from the table manufacturing branches (excluding petroleum refineries) are assumed to be equally sensitive to cost and world market price. It is, however, important to realize that the direct influence from foreign prices in the equations is not the only one. Domestic producers' prices will also to a varying degree react to world market prices through imported input goods which will affect production costs. The total foreign price influence will therefore always be greater than showed in Table 4.4.

For most branches Calmfors and Herin found no significant influence on price setting from capacity utilization. In the model simulations we have, however, frequently exploited a capacity variable in the price equations to speed up the adjustment to normal capacity utilization levels.

The wage formation is given by a kind of Phillips curve as described in section 3.14:

$$\dot{w}_0 = a_0 + a_1 \cdot \dot{cpi}(t-1) + a_2 \cdot (u - u_0) + a_3 \cdot (\Pi^m(t-1) - \Pi_0) + a_4 \cdot \dot{Q}_4^m(t-1)$$

where dotted variables are growth rates.

The consumer price influence, \dot{cpi} , was first estimated not to differ significantly from unity and

Table 4.4 Values of parameters in price equations (standard set-up)

Branch ^a	$a_{i2}=b_{i2}$	$a_{i3}=b_{i3}$
1, 18, 19, 22	1.0	0.0
2, 20, 21, 23	0.75	0.25
3-11, 13-17	0.5	0.5
12	0.0	1.0

^a Names of branches are listed in Table 4.1.

Table 4.5 Values of parameters in wage equation

Variable	Parameter
Constant	2.63
\dot{cpi}	1.0 ^a
$(u-u_0)$	-4.14
$\Pi^m - \Pi_0$	0.56
Q_4^m	-0.47

^a Restricted

was therefore restricted in the final estimation the outcome of which is given in Table 4.5. Estimation procedure and results are reported in Jansson (1982) and will not be repeated here. Suffice it to emphasize that the full compensation for past consumer price increases, as well as the rather high absolute value of the labour market coefficient, is a bit exceptional and that parameters in these kinds of wage equations are notoriously unstable.

As the wage inflation neutral "normal" unemployment (u_0) and manufacturing gross profit share (Π_0) we have in most simulations used 2 percent and 27 percent respectively.

The ex ante choice of production technique in manufacturing branches is based upon a constant elastic function in relative input prices (cf section 3.3)

$$Q_{m,i}^t = a_{m,i} \Pi_{n,i} p_{n,i} (t-1)^{\alpha_{m,n,i}}; \quad \begin{array}{l} i=4, \dots, 17 \\ m,n=1, \dots, 5 \end{array}$$

The $\alpha_{m,n,i}$ s are based on Dargay (1981) and are shown in Table 4.6. They are, however, modified in two ways. The first relates to the number of energy inputs where the estimates only covered energy as a whole at the time when figures were put into this part of the model. In order to, at least to some extent, account for possible substitution effects of changing relative prices for electricity and fuels energy elasticities were split in parts. On the disaggregated branch level elasticities of substitution between electricity and fuels on the one hand and other inputs on the other hand were simply assumed to be equal in

Table 4.6 Values of parameters in the functions for ex ante choice of technique in manufacturing branches

		$\alpha_{m,n,i}$				
i	m/n	1	2	3	4	5
4	2	-0.090	-0.390	0.0	0.120	0.360
	3	-0.090	0.0	-0.390	0.120	0.360
	4	1.410	0.0	0.0	-1.620	0.210
	5	-0.240	0.060	0.060	0.540	-0.420
5	2	1.440	-1.410	0.0	0.450	-0.480
	3	1.440	0.0	-1.410	0.450	-0.480
	4	1.860	0.015	0.015	-1.950	0.060
	5	0.510	-0.045	-0.045	0.120	-0.540
6	2	1.500	-0.450	0.0	-0.960	-0.090
	3	1.500	0.0	-0.450	-0.960	-0.090
	4	1.770	-0.060	-0.060	-2.190	0.540
	5	-0.630	-0.015	-0.015	1.140	-0.480
7	2	3.570	-2.940	0.0	0.300	-0.930
	3	3.570	0.0	-2.940	0.300	-0.930
	4	1.290	0.015	0.015	-1.5690	0.270
	5	-0.090	-0.105	-0.105	1.080	-0.780
8	2	1.650	-1.230	0.0	-0.240	-0.180
	3	1.650	0.0	-1.230	-0.240	-0.180
	4	1.740	-0.030	-0.030	-1.830	0.150
	5	0.630	-0.030	-0.030	0.300	-0.870

$\alpha_{m,n,i}$						
i	m/n	1	2	3	4	5
9	2	0.900	-1.590	0.0	1.440	-0.750
	3	0.900	0.0	-1.590	1.440	-0.750
	4	1.050	0.015	0.015	-1.260	0.180
	5	0.660	-0.015	-0.015	0.570	-1.200
10	2	1.110	-1.530	0.0	0.450	-0.030
	3	1.110	0.0	-1.530	0.450	-0.030
	4	0.930	0.015	0.015	-1.290	0.330
	5	-0.270	0.0	0.0	0.810	-0.540
11	2	0.960	-0.780	0.0	-0.150	-0.030
	3	0.960	0.0	-0.780	-0.150	-0.030
	4	1.680	-0.015	-0.015	-1.620	-0.030
	5	0.810	-0.015	-0.015	-0.060	-1.720
13	2	1.650	-1.230	0.0	-0.240	-0.180
	3	1.650	0.0	-1.230	-0.240	-0.180
	4	1.740	-0.030	-0.030	1.830	0.150
	5	0.630	-0.030	-0.030	0.300	-0.870
15	2	2.130	-1.920	0.0	0.030	-0.240
	3	2.130	0.0	-1.920	0.030	-0.240
	4	1.650	0.0	0.0	-1.710	0.060
	5	0.510	-0.015	-0.015	0.240	-0.720
16	2	1.500	-1.680	0.0	0.330	-1.500
	3	1.500	0.0	-1.680	0.330	-0.150
	4	1.800	0.0	0.0	-1.950	0.150
	5	-0.030	-0.015	-0.015	0.510	-0.450

size. Moreover, changing as few estimated parameters as possible required that cross price elasticities between electricity and fuels to be zero. As estimates for different energy forms now are available on a disaggregated branch level these will be implemented in the next version of the model.

The second way in which we have modified the estimates arises from the ex ante - ex post distinction. The estimates are based on observed input coefficients for the whole production capacity in a branch. The response of these average coefficients to changing input prices is much weaker than the response in marginal additions to capacity. We assume that the influence from prices is increased by a factor three. All parameters in Table 4.6 are thus three times the estimated values.

None of these modifications are of course satisfactory. However, given the very scant empirical basis for the disaggregated ex ante functions some kind of ad hoc modifications along these lines are unavoidable.

Investments in manufacturing branches are explained by expected (past) profits and capacity utilization (cf Section 3.5):

$$g_i = k_i(t-1) \left[\sum_{j=1}^4 \gamma_{j,i} \cdot ep(t-j)_i + d_i \right] ur_i(t-1)^{a_i}$$

The basis for the parameter values in Table 4.7 is found in Jansson (1981), which also provides the assumptions behind this specification of the investment function. The capacity utilization varia-

Table 4.7 Values of parameters in investment functions

Branch	$\gamma_{1,i}$	$\gamma_{2,i}$	$\gamma_{3,i}$	$\gamma_{4,i}$	$\sum_j \gamma_{j,i}$
4	0.0316	0.0000	0.0197	0.0000	0.0513
5	0.0000	0.0000	0.0322	0.0000	0.0322
6	0.0326	0.0739	0.0497	0.0285	0.1847
7	0.0470	0.0349	0.0104	0.0144	0.1067
8	0.0000	0.0101	0.0000	0.0175	0.0276
9	0.0838	0.0000	0.0163	0.0068	0.1069
10	0.0324	0.0124	0.0000	0.0000	0.0448
11	0.0119	0.0113	0.0000	0.0214	0.0894
13	0.0050	0.0291	0.0124	0.0000	0.0465
14	0.0132	0.0125	0.0433	0.0220	0.0910
15	0.0000	0.0201	0.0000	0.0235	0.0436
16	0.0753	0.0516	0.0000	0.0000	0.01269
17	0.091	0.0000	0.0000	0.0000	0.0917

ble is, however, added afterwards with the a_i 's assumed equal to 3.0 for all branches in the standard version of the model. Compared to an outright accelerator this is a fairly modest influence. Together with the price equations this will provide the model with stabilizing responses to disturbances that affects capacity utilization. A higher rate of utilization will on the one hand lead to higher prices thereby reducing demand, and to increased investments on the other, thus expanding capacity.

The distribution of private real consumption expenditures between consumer goods is explained by a linear expenditure system (cf Section 3.8):

$$c_i = [\gamma_i p_i^c c_i(t-1) + \beta_i (c_p - \sum_{k=1}^{14} \gamma_k p_k^c c_k(t-1))] / p_i^c$$

where $\sum_{j=1}^{14} \beta_j = 1$ and $i=1, \dots, 14$.

The consumption goods are listed in Table 4.3. Parameter values, which are given in Table 4.8, are estimated in Dargay (1981).

Foreign trade is explained by market size and relative prices (cf Section 3.6):

$$e_i = a_i^e \cdot \prod_{j=0}^1 [p_i^e(t-j)/\theta \cdot p_i^w(t-j)]^{\beta_{i,1+j}} \cdot w m_i$$

and

$$m_i = a_i^m \cdot \prod_{j=0}^1 [\theta \cdot p_i^w(t-j)/p_i^{xh}(t-j)]^{\gamma_{i,1+j}} \cdot h_i^{\gamma_{i,3}}$$

Table 4.8 Values of parameters in private consumption expenditure system

Consumer	β	γ
1	0.1081	0.9405
2	0.1135	0.7998
3	0.0717	0.9000
4	0.0110	0.9797
5	0.0041	0.9498
6	0.0000	1.0100
7	0.3025	0.2502
8	0.1116	0.7600
9	0.0716	0.8301
10	0.0920	0.8898
11	0.0110	0.9306
12	0.0362	0.8700
13	0.0602	0.6697
14	0.0065	0.9500

The export price elasticities are shown in Table 4.9. Only four export equations are based on estimated parameters (indicated by * in the table) but those branches nevertheless account for about x percent of total export volume. Total elasticities range from -1.0 to -2.0 with lower absolute values assumed for export of services (except for export of chemicals).

As shown in Table 4.10 65 percent of total import volume are based estimated prices and market-elasticities. Generally import is less sensitive to relative prices than exports with textile and machinery as notable exceptions. Since there is no indigeneous production of coal and oil imports are purely complementary but is affected by substitution with domestic energy.⁴

4.3 The solution algorithm

Since the number of equations is so large and there are so many nonlinear relations between variables, there is no way to explicitly express the endogenous variables as functions of exogenous and predetermined variables. Therefore it is not possible to solve the model in one step but we need an iterative procedure. The technique used in ISAC is the Gauss-Seidel algorithm. This algorithm is elementary, very simple to implement and has proved robust, efficient and cheap to use in terms of computer time. Through the iterative procedure it is also easy to add or detract equations without bothering about the order in which they are computed, which variables are endogenous etc. This possibility greatly increases the flexibility of the model.

Table 4.9 Values of parameters in the export functions

Branches	$\beta_{i,1}$	$\beta_{i,2}$	$\sum_j \beta_{i,j}$	Share of total export volume ^b in 1980 (percent)
1-6,9,10				
13,14,16,17	-1.0	-1.0	-2.0	17.9
7*	-0.56	-0.92	-1.48	2.7
8*	-0.82	-1.34	-2.16	19.8
11*	-0.71	-0.39	-1.10	6.2
15*	-1.55	-0.51	-2.06	38.4
20,21,23	-1.3	0.0	-1.3	12.6
12,18,19,22 ^a	-	-	-	2.4

* Estimated parameters.

^a Zero or exogenous exports

^b At 1975 year's prices

Table 4.10 Values of parameters in the import functions

Branches	$\gamma_{i,1}$	$\gamma_{i,2}$	$\sum_j \gamma_{i,j}$	$\gamma_{i,3}$	Share of total import volume ^c in 1980 (percent)
8-10,13,16,17	-0.5	-1.0	-1.5	1.5	8.0
4-6* ^a	0.0	-0.53	-0.53	1.88	5.6
7*	-0.87	-1.63	-2.50	1.49	8.1
11*	-0.67	0.0	-0.67	1.27	10.3
14*	-0.69	-0.76	-1.45	1.32	5.8
15*	0.0	-2.71	-2.71	1.88	34.9
20,21,23	-1,3	0.0	-1.3	1,5	8.2
3,12 ^a	-	-	-	-	15.4
1,2,18,19,22 ^b	-	-	-	-	3.7

* Estimated parameters.

^a Imports of coal and oil is given directly by demand since no import competing domestic production exists.

^b Zero or exogenous imports.

^c Cif at 1975 year's prices.

Let us for descriptive purposes represent the ISAC model as a number of equation one for each endogenous variable as follows:

$$\begin{aligned}x_1 &= g_1(x_1, x_2, \dots, x_n, z) \\x_2 &= g_2(x_1, x_2, \dots, x_n, z) \\&\cdot \\&\cdot \\&\cdot \\x_n &= g_n(x_1, x_2, \dots, x_n, z)\end{aligned}$$

where the x :s are endogenous variables and z is a vector containing all the exogenous and predetermined variables. The iteration starts with an initial guess of the x :s—normally the previous period's solution. Computing the right hand side of the first equation gives a new value of x_1 which substitutes the old value in the subsequent calculations. The second equation gives a new value of x_2 , which substitutes the old value etc. This procedure is repeated through all n equations and is then started all over again from the first equation. It goes on until the process converges i.e. until the computed values of the x :s on the left handside are close enough to the old ones on the right hand side in the equation system above.

This method have proved to be very useful and robust for the type of models that ISAC represents and this is also the experience gained by the use of the MGM and LIFT models. For a more thorough discussion of the Gauss-Seidel method in connection with macro models, see Barker (1976).

Notes

¹ This is when local government expenditures are exogenous. In the present version of the expenditure model two of the six categories are put together.

² The exchange rate (θ) times world market prices in foreign currency (p^w) may differ from import prices because of tariffs as well as for aggregational reasons.

³ The capacity utilization variable is omitted, cf section 3.12.

⁴ Imports of branch 3 commodities is a mix of coal and other mineral raw material (excl oil). For simplicity, however, all imports are treated as complementary.

5 Stability

Having treated above in some detail the structure of ISAC we should now say something about the working and dynamic properties of the model. We emphasized already at the beginning that ISAC is better suited to analyze stability and stabilization problems than to deal with allocational or distributional policies because of its degree and form of aggregation. Without e.g. a sub-grouping of households and of private consumption, no serious incidence studies can be attempted. The situation is not quite so clearcut when it comes to long-term resource allocation. Structural change and productivity developments in manufacturing, shifting government shares in consumption and income formation are aspects of long-run economic adjustment which are explicitly recognized and analyzed in the model. The absence of financial markets, of an explanation of household saving and of regional dimensions still, however, makes it difficult to use the model for full-fledged studies of growth policies. What the model can be used for with advantage is studies of stability and of medium-term stabilization policies and their relation to growth and structure.

5.1 A pragmatic frame-work of stability and control

Anyone setting out to study the stability properties of a real-life dynamic system like the Swedish economy is bound to become frustrated at the very start in trying to assemble a suitable conceptual

tool-box or frame-work. The stability concepts articulated and used in the mainstream of economic theory are so far removed from the dynamic problems of real economies as to be almost irrelevant to our purpose here. The systems treated in the literature are usually autonomous, i.e. time is not an essential variable. Stability definitions turn to empirically indeterminate concepts like "neighborhoods arbitrarily close to the origin" while any empirically useful stability concept should be concerned instead with the system staying within certain specified bounds. The systems usually discussed are moreover closed, i.e., do not explicitly contain exogenous variables like world market trade or stabilization policy instruments etc.

We are thus forced to make a detour in order to define our concepts. To make this detour as short as possible, the presentation or definition of the five different stability notions used will be sketchy and direct without any side-glances on existing literature.

To simplify the discussion let us assume that the ISAC-model could be represented by a system of first order difference equations¹:

$$\Delta x_t = f(x_{t-1}, y_t, u_t, z, t)$$

where x = endogenous variables

y = exogenous variables

z = system parameters

u = control variables ("policy instruments")

and t = time

If we specify a development over time for exogenous variables (\bar{y}) and policy instruments (\bar{u}), and an initial position for the economy (x_0) we can solve the system of equations for a growth path (\bar{x}).²

Let us now introduce our first "stability" concept by defining a stable growth path as one for which growth rates of all endogenous variables are fairly constant:

$$|\Delta x_{i,t}/x_{i,t-1} - \Delta x_{i,s}/x_{i,s-1}| < \varepsilon_1 ; t_0 \leq t, s \leq t_f$$

Our definition of stable growth should correspond to the use of that expression in common parlance but can not be applied strictly. It does not embrace all endogenous variables e.g. the balance of payments which, being a difference between external income and expenditure, obviously may show large relative changes. The definition should be applied only to "basic" endogenous variables such as volumes of production and demand, price indices and the like.

As stated several times before the ISAC-model does not assure strict equilibrium solutions in the sense that excess demand may arise in some markets for shorter or longer periods. These possible excess demands, E_j , will concern currency (the balance of payment), labor and production capacity.

We can now define an equilibrium growth path where all excess demands are limited:

$$|E_{j,t}| < \varepsilon_2 ; t_0 \leq t \leq t_f$$

Equilibrium growth in the ISAC-model implies stable growth as we have defined the concepts. This is the rationale behind our almost exclusive analysis of excess demands in the model simulations that will be discussed below. Although the proposition is hard to prove strictly - because of the size and complexity of the model - it is intuitively reasonable and confirmed by extensive experimentation with the model. Assuming that values of exogenous variables and policy instruments does not exhibit large jumps it is e.g. obvious that production capacity equilibrium is sufficient for stable growth in output. This is so because of considerable inertia in capacity growth. Turning to the demand side of the model the composition of every category is fairly stable since no sudden relative price shifts between different goods are likely to occur given stable exogenous prices. Also equilibrium in the external balance assures no sudden shifts in domestic prices relative world market prices and hence no drastic shifts in exports and imports. Finally equilibrium in the labor market rules out sudden shifts in unit labor costs.

Although the model is not solved for equilibrium in some markets it contains adjustment mechanisms that tend to make market disequilibria bounded and keep them from reinforcing each other. These mechanism together with suitable choice of policy instruments assures that an equilibrium growth path is always possible to find. This will accordingly also be stable as defined above.

Next we want a measure of what we will call the resilience of the system, i.e. the ability of the system, to absorb outside shocks by itself or with-

out intervention in the form of policy changes. Given a stable growth path, \bar{x}^* , we introduce "disturbances" or major changes in some exogenous variables, while keeping everything else including the preset policy, unchanged. We call the system - or the specific growth path - resilient if it adjusts back to a stable growth path close to the original one:

$$|x_t(y_0 + \Delta y_0) - x_t^*(y_0)| < \varepsilon_3 ; t > t_s$$

To quantify the concept of "degree of resilience" - and the same goes also for the other stability concepts introduced below - we obviously need to answer at least four kinds of questions. How big, relatively speaking, is the disturbance and where is it located in time and place? How long does it take - and at what amplitude of fluctuations - to bring back growth into a stable pattern? How big are the "stabilization" costs, measured in terms of some social "loss function"? How big is the following growth loss, if any, measured by that same function?

In the next step we assume that the resilience of the system is not sufficient, so that explicit policy intervention must be brought about to counteract the external disturbance.

We call the system controllable or manageable if there always exists a policy packet, \bar{u} , that will bring the system back close to the original undisturbed growth path:

$$|x_t(y_0 + \Delta y_0, \bar{u}') - x_t^*(y_0, \bar{u})| < \varepsilon_4 ; t > t_s$$

Given a "loss function", defined in terms of well fare effects of growth paths as well as political costs of policy measures, optimal policies can be defined. No explicit loss function is however integrated in the model but far less sophisticated measures such as total private consumption, real wage rate, tax rates etc. are used to compare different policies. The reason is twofold. Firstly, the specification and estimation of a comprehensive social loss function is no easy task. Secondly, a strict optimization would require several iterations over possible policies and therefore significantly greatly increase computer time.

So far we have taken the model structure, Z , as given. If we take into account the possibility of changes in the system parameters we can define structural stability:

$$|x_t(Z+\Delta Z) - x_t^*(Z)| < \varepsilon_4 ; t > t_s$$

that is small exogenous changes in Z at a given time - i.e. "sensitivity tests" - will only produce small shifts in the growth path.

Finally one may think of a system exhibiting a learning behavior in the sense that structural parameters are allowed to change as a consequence of shifts in exogenous variables. Such a learning property can be stabilizing as well as destabilizing. In the former case we will call the system adaptive, defining the concept as

$$|x_t(y_0 + \Delta y_0, Z_t') - x_t^*(y_0, Z_t)| < \varepsilon_5 ; t > t_s$$

From the definitions it is obvious that resilience is a more restrictive concept of stability than

adaptiveness. However the difference between the concepts can to some extent be attributed to the level of aggregation in the model.

To return to a stable growth path after some disturbance in world markets an adaptive parameter shift may be required for instance in export and import functions. In a more disaggregated model this parameter shift may correspond to redistributions of export- and import shares between goods with parameters in the functional relationships unchanged. The latter disaggregated system would then be said to be resilient.

After this very cursory introduction of stability concepts let us try to illustrate them by some simple applications on the ISAC-model.

5.2 Stable growth and resilience

To ease an understanding of the stability behavior of the model let us first recall some of its fundamental properties. There are three main types of markets where disequilibria or excess demand may occur. Production capacity may differ from the quantity actually produced, the unemployment rate may be higher or lower than the rate assumed to be caused by frictions in the labor market, and finally, foreign payments on current account may not balance, indicating an over- or undervalued currency.

For the first two of these disequilibria the model includes relations that tend to reduce deviations from "normal" values. If capacity falls short of demand, the reaction will be both to limit the

increase in demand and to expand production capacity. To keep down the demand increase the price and wage equations are of great importance. The increased production will push up capacity utilization. This gives a direct upward pressure on supply prices. But there is also an indirect price effect. The increased demand will reduce unemployment below "normal" levels and wages will raise faster than otherwise.

Although producers are not assumed to use pure mark-up prices some of the wage inflation will be passed on to consumers. Increased demand will thus to some extent transform into higher prices. There will also be a tendency to expand capacity through investments, which will increase, *ceteris paribus*, when producers become short of capacity. Producers' prices will respond to demand increases affecting utilization ratios in the short run, but it may take several years before capacity, growing through higher investment, will catch up with production to reach "normal" utilization ratios.

The third disequilibrium, the current account, does not set directly in motion any balancing forces. The exchange rate is assumed fixed or rather exogenously determined and is included in the set of control variables used to steer the model (cf. section 5.3).

With this in mind we can go on to construct first of all a stable growth path, that can then serve as a reference path for the evaluation of system resilience when outside disturbances occur. To simplify the example the local government submodel has not been used, making all government consumption exogenously determined.

World market development and other exogenous variables for the period studied, 1980-2000, have been chosen from current Swedish projections, also used by us in other model simulations (cf. Nordström - Ysander 1981 for a detailed discussion of the assumptions). The model economy has then been steered through the eighties by use of tax and wage policy into a "turn-pike" 1990, characterized by narrowly bounded excess demand on the markets concerned as shown in Figure 5.1. New permanent values have then been set for the policy variables, so that the growth path during the nineties remains stable in this sense. (The steering technique will be further discussed in section 6.3)

This is indicated by Figure 5.2 where growth rates for some aggregated real and price variables is given. The short run fluctuations in the beginning of the eighties are mainly due to the need to restore profit margins in industry. During the rest of the decade the slow growth of private consumption is explained by the need to restore the external balance. Having achieved that in 1990 (cf. Figure 5.1) taxes can be relaxed to let private consumption grow at a one percentage point faster rate than during the second half of the eighties. (Public consumption growth is assumed equal during the whole simulation period):

Generally Figures 5.1-2 show that variations in growth rates of endogenous variables are fairly small if exogenous variables and policy instruments are given, and that there are no tendencies for the solution to "explode". More specifically, the figures indicate that possible excess demand can be kept within certain limits and that this implies a stable growth path during the same

Figure 5.1 The Reference Case

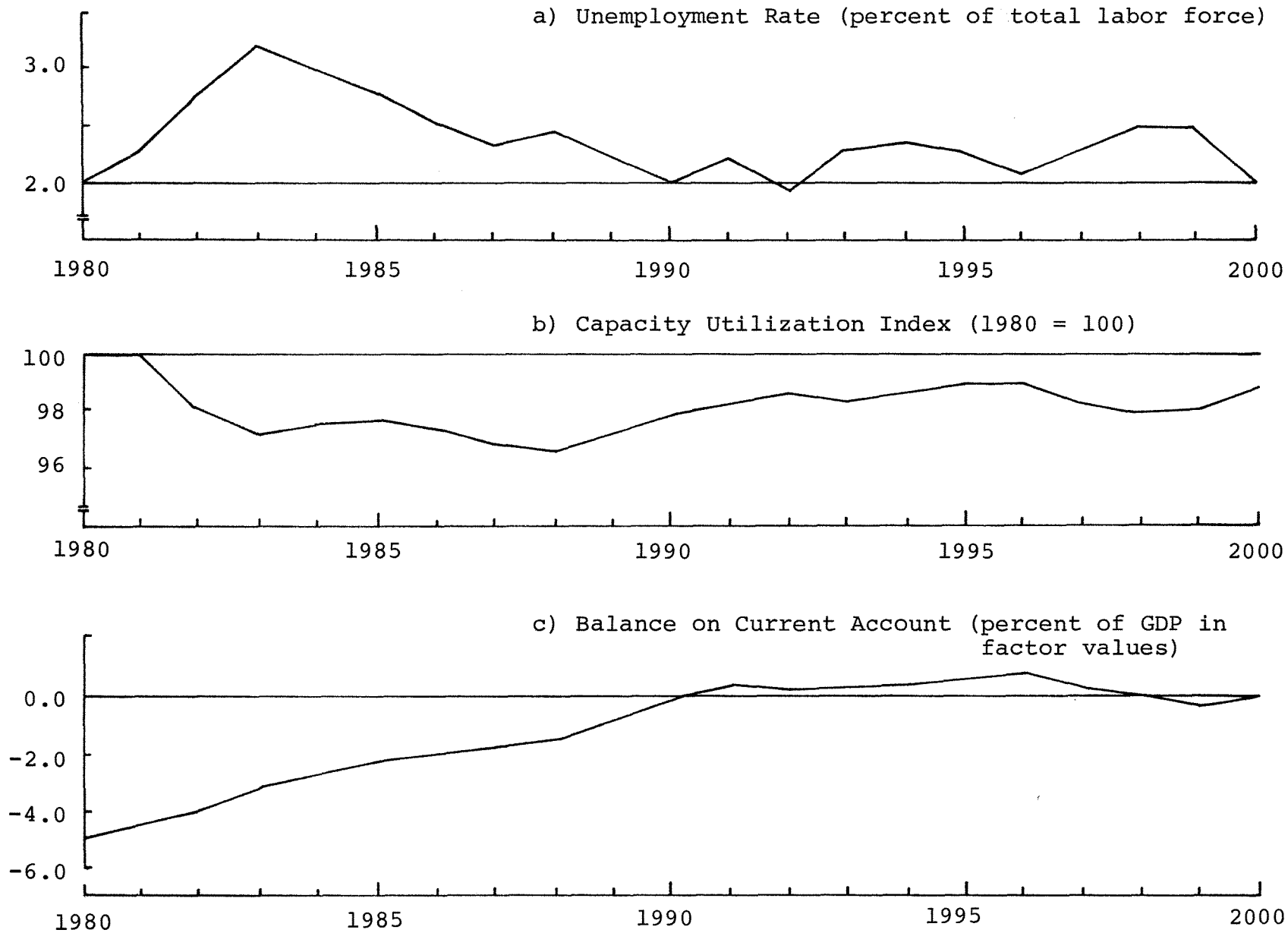
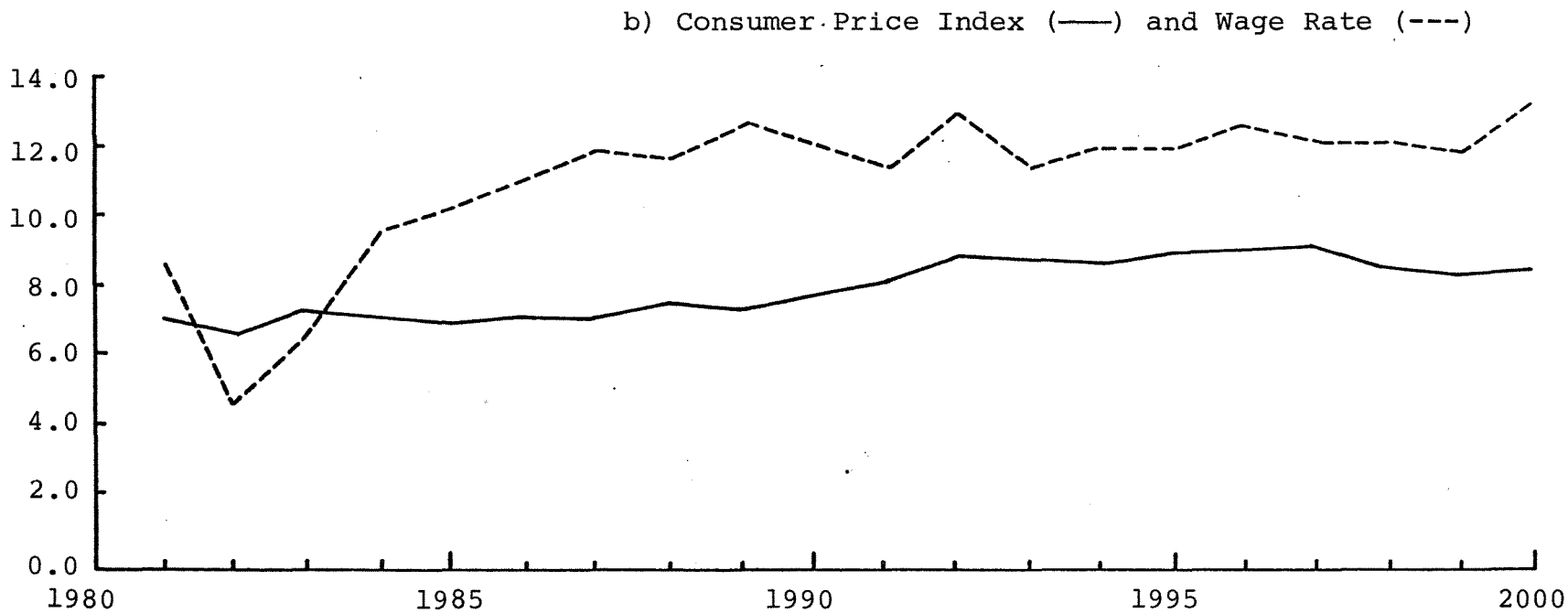
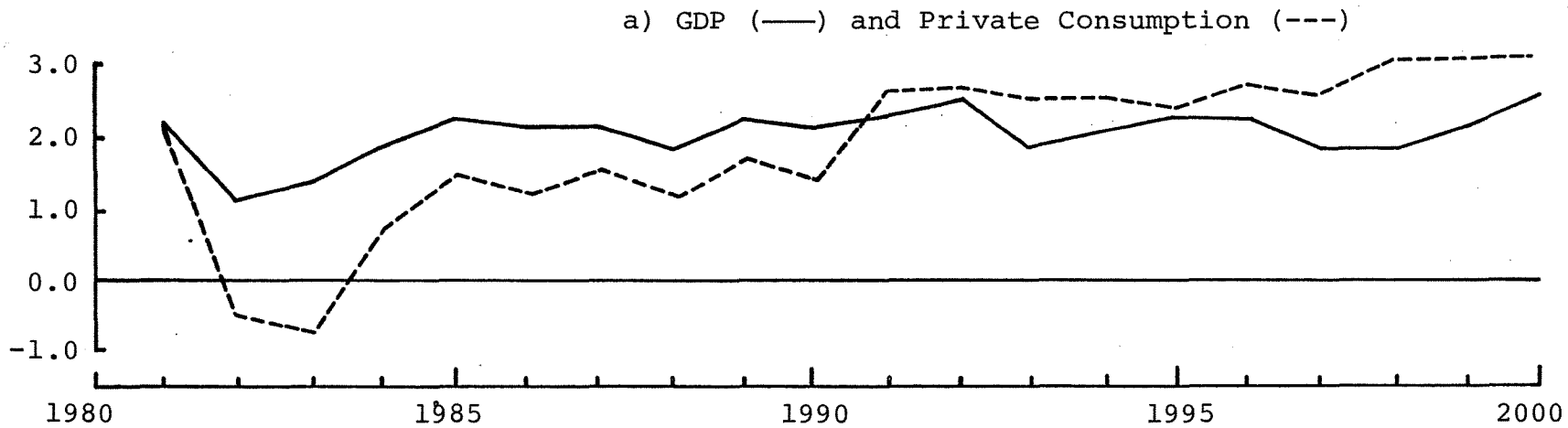

Figure 5.2 The Reference Case
(Percentage increase per year)



period. In the stability experiments discussed in the rest of the chapter we will therefore be content to show only excess demand diagrams.

In the first resilience test, we assume a 5% jump upwards in world market prices in 1981/82 compared to the reference case. The higher price level is assumed to persist implying equal growth rate during the rest of the simulation period. Public policy remains unchanged, since we want to study the "self-correcting" mechanisms in the system. The result is shown in Figure 5.3 as deviations from the reference case in the three "excess demand" markets. The immediate effect will be improved profits in export companies. However, there will also follow increased net demand from abroad since producers will partly take advantage of their improved relative cost position by capturing market shares. The current account will be improved by more than one half percent of GDP in 1982 and 1983 compared to the reference case. This development will, however, bring about reactions in the labor market and in the production system. As a consequence of increasing pressure from the demand side, wages and prices will shift upwards. The imported inflation in 1982 will add to inflation expectations and make wage inflation in 1983 even more severe. This price-wage spiral will reverse the process described above and will lead to unemployment and overcapacity in industry and so forth. As shown in Figure 5.3 the induced cycles will be gradually weakened and the economy will stabilize itself around its new long run equilibrium growth path. In this particular case the only persistent effect is of course a 5% rise in all price levels relative to the reference case.

Figure 5.3 Effects of Permanent 5 % World Price Increase 1982
(Difference from Reference Case)

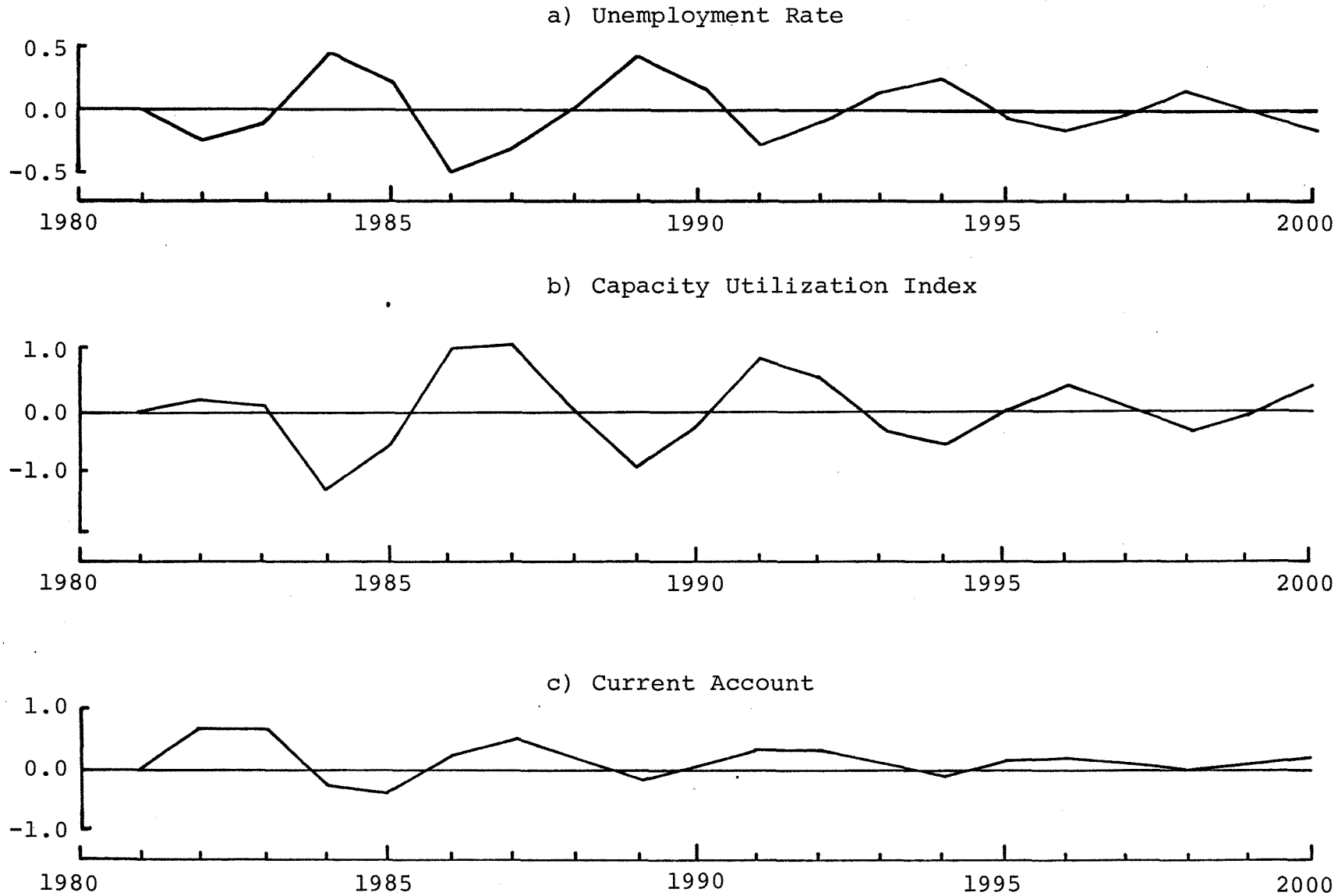

In the second resilience test the economy is exposed to an overall 5% increase of world market growth relative to the reference case in 1981/82. The story is told in Figure 5.4. In this case net export demand is affected directly without any improvement in relative prices. The same mechanisms as before will however produce reactions from the price side to hold back demand.

The fluctuations will fade away within a few years in this case but there will persist a surplus on current account even during the nineties. The model economy will accordingly not absorb this kind of exogenous disturbance and return to equilibrium growth. The reason for this is obvious since the exchange rate is exogenous and thus remains the same as in the reference case despite the significantly improved world trade. With floating exchange rates the current account surplus would have brought about currency appreciation.

The fact that not all excess demands vanish after a world trade disturbance does however not necessarily rule out the stability of the corresponding growth path as defined in section 5.1. This is indicated by Figure 5.5. Although effects of the disturbance on prices and quantities is registered for the whole simulation period they will fairly soon be confined to small deviations from the reference growth path.

In the simulations accounted for above we tested the resilience of the model for permanent shifts in world market variables. Figures 5.7-8 show the results of temporary disturbances of the same variables, i.e. the initial 5% extra growth in 1982 will be followed by a 5% fall two years later as

Figure 5.4 Effects of Permanent World Trade Increase 1982
(Difference from Reference Case)

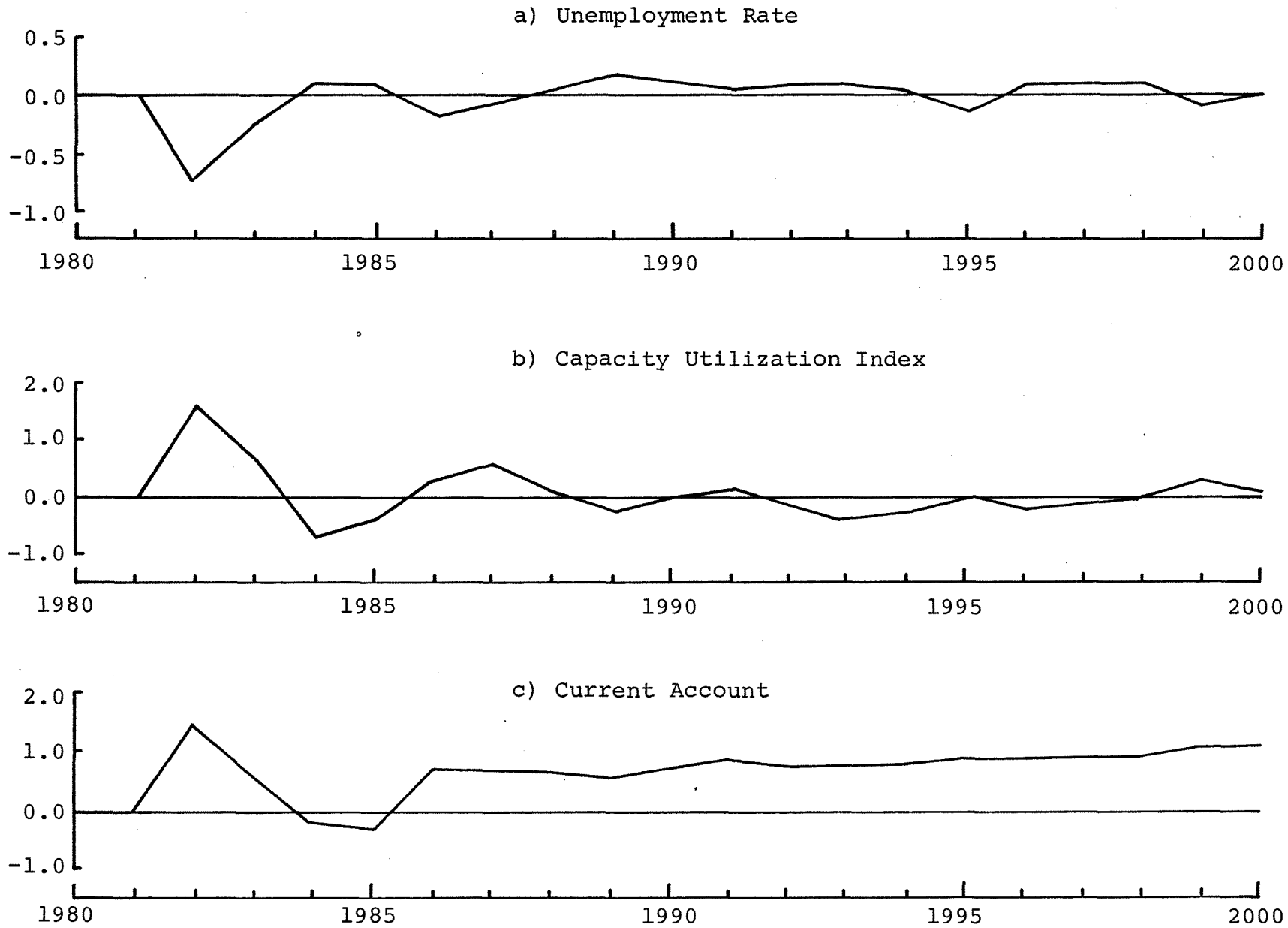
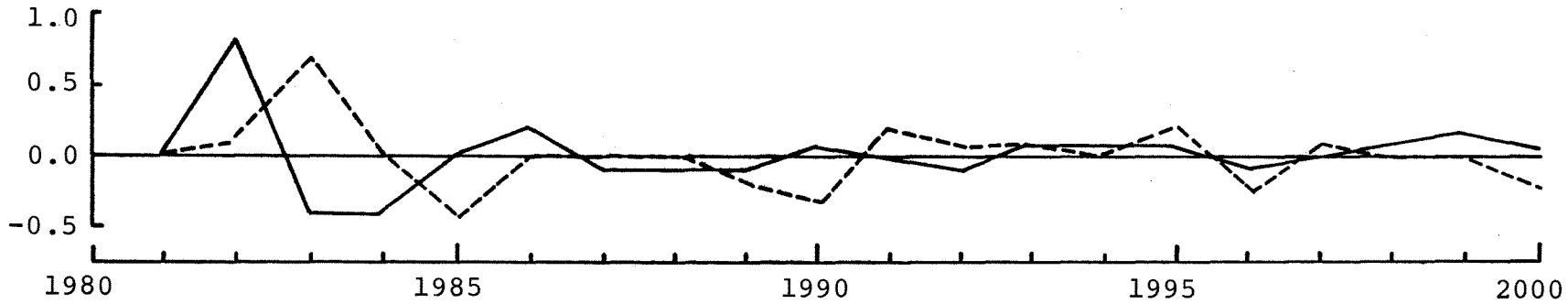
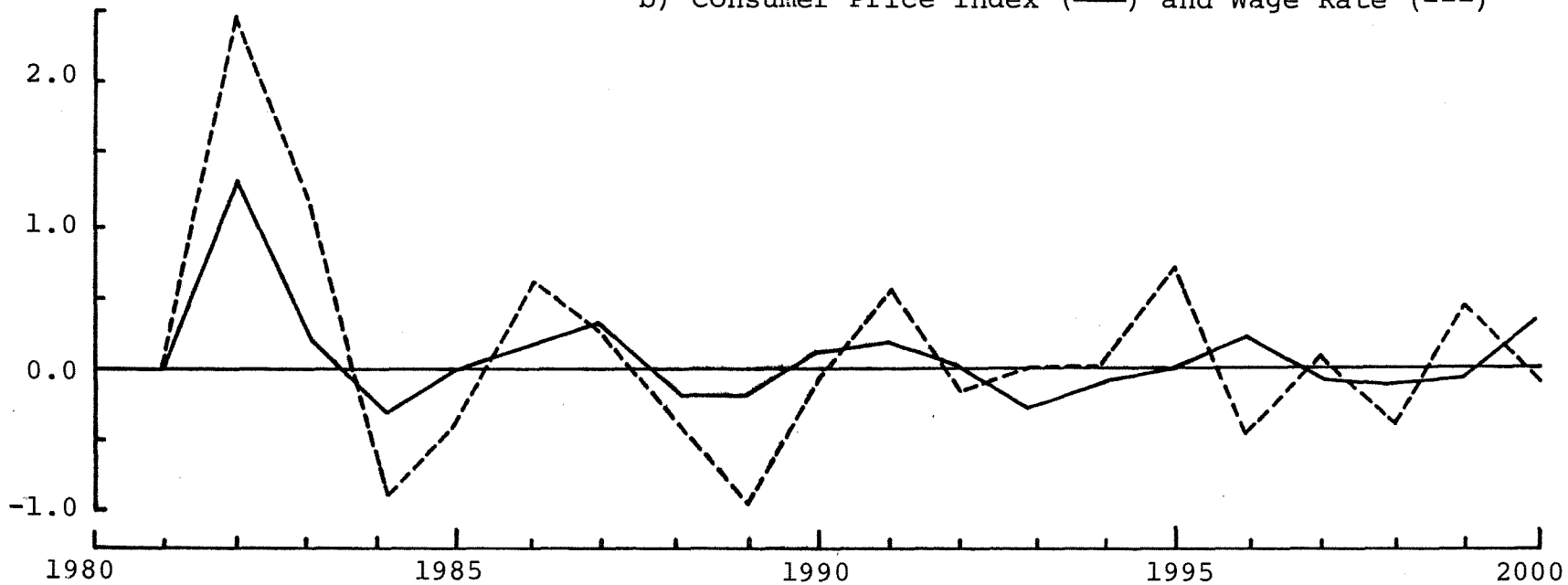

Figure 5.5 Effects of Permanent 5 % World Trade Increase 1982
(Growth Rate Differences from Reference Case)

a) GDP (—) and Private Consumption (---)



b) Consumer Price Index (—) and Wage Rate (---)



compared to reference case growth rates. Although the excess demand cycles are clearly amplified in this case - especially when it comes to the world price disturbance - the oscillations still are smoothed out over time. However Figure 5.6 also indicates that current parameters in the model may not be too far from producing non-damped excess demand cycles, at least in response to certain kind of external price disturbances. Finally we may note that this time the system will resume equilibrium growth even in the face of a trade disturbance. The balance on current account given in Figure 5.7 will show no persistent surplus since the level world trade does not differ from the reference case as from 1984.

5.3 Controlling the model

The need to steer the model solutions arises from the desire to compare the outcome of equilibrium growth paths under different external conditions. E.g. how will the space for consumption be affected by higher oil prices given that it is possible to preserve equilibrium growth?

As is obvious from the previous section equilibrium growth is not assured in the model even in the long run, if parameter values are held constant. If however some of the model parameters are assumed free to change during a simulation it is always possible to attain equilibrium growth. This set of parameters are called policy instruments, control parameters or the like, and are chosen to correspond as much as possible to instruments used in actual economic political decision making. In the present version of the model the following main instruments are available:

Figure 5.6 Effects of Temporary World Price Increase 1982-84
(Difference from Reference Case)

a) Unemployment Rate

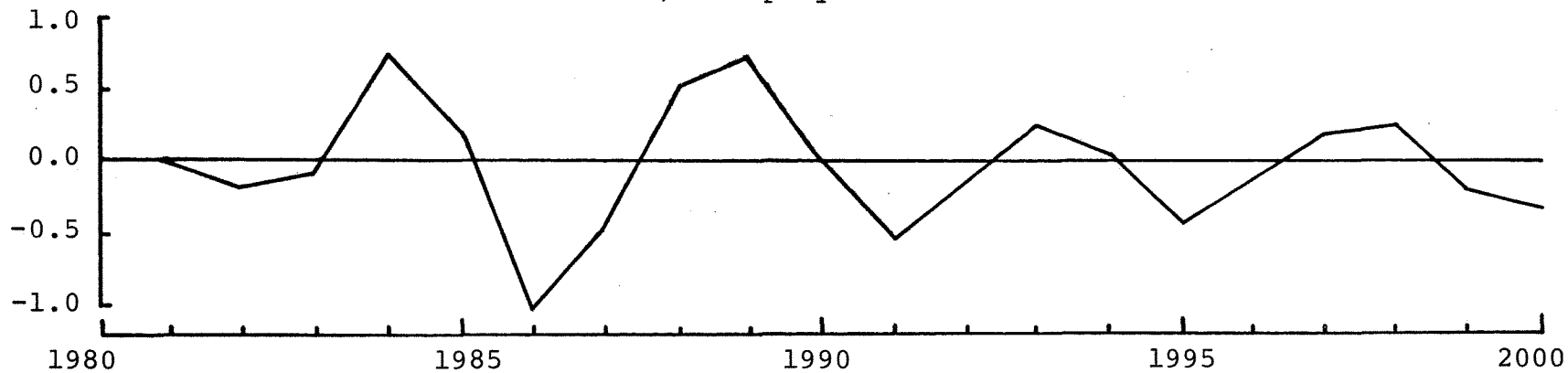

b) Capacity Utilization Index

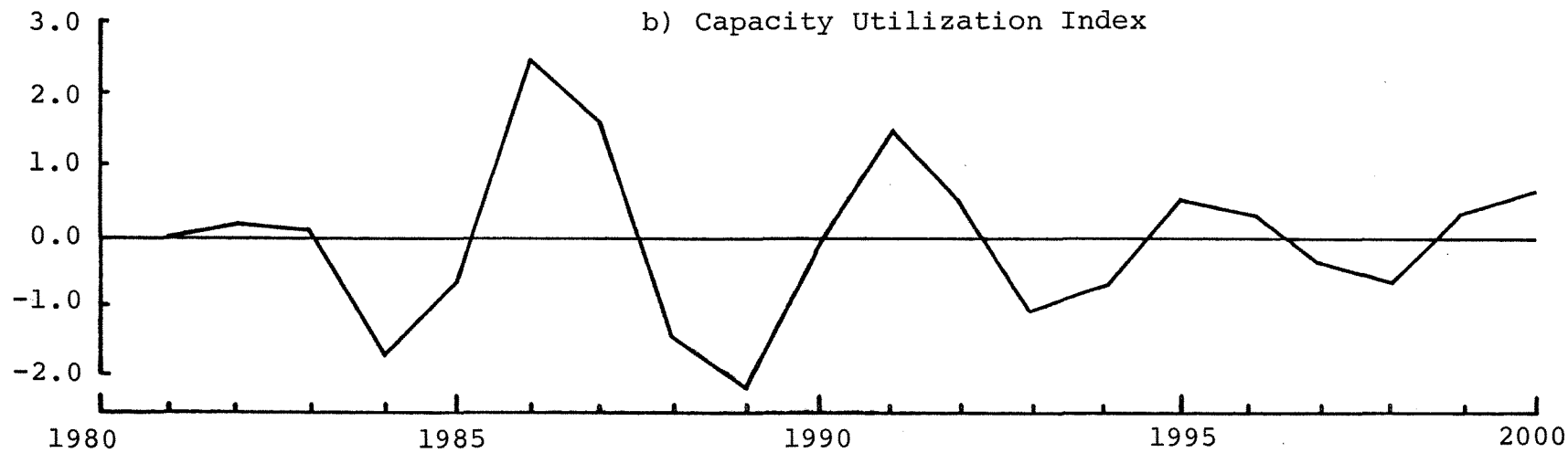

c) Current Account

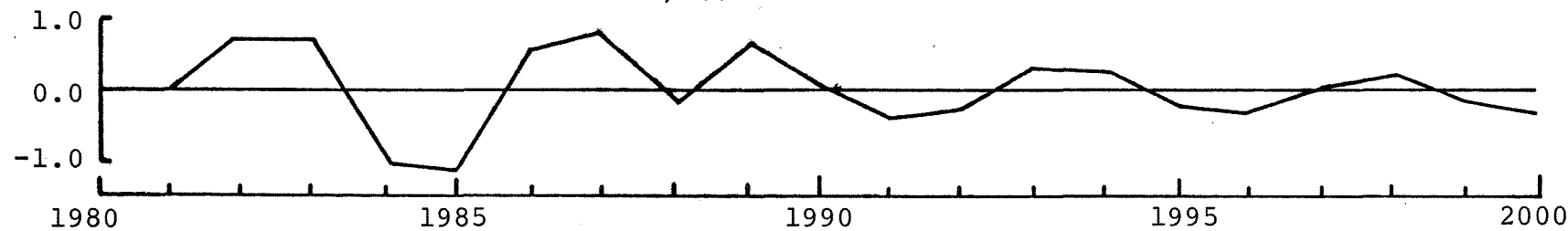
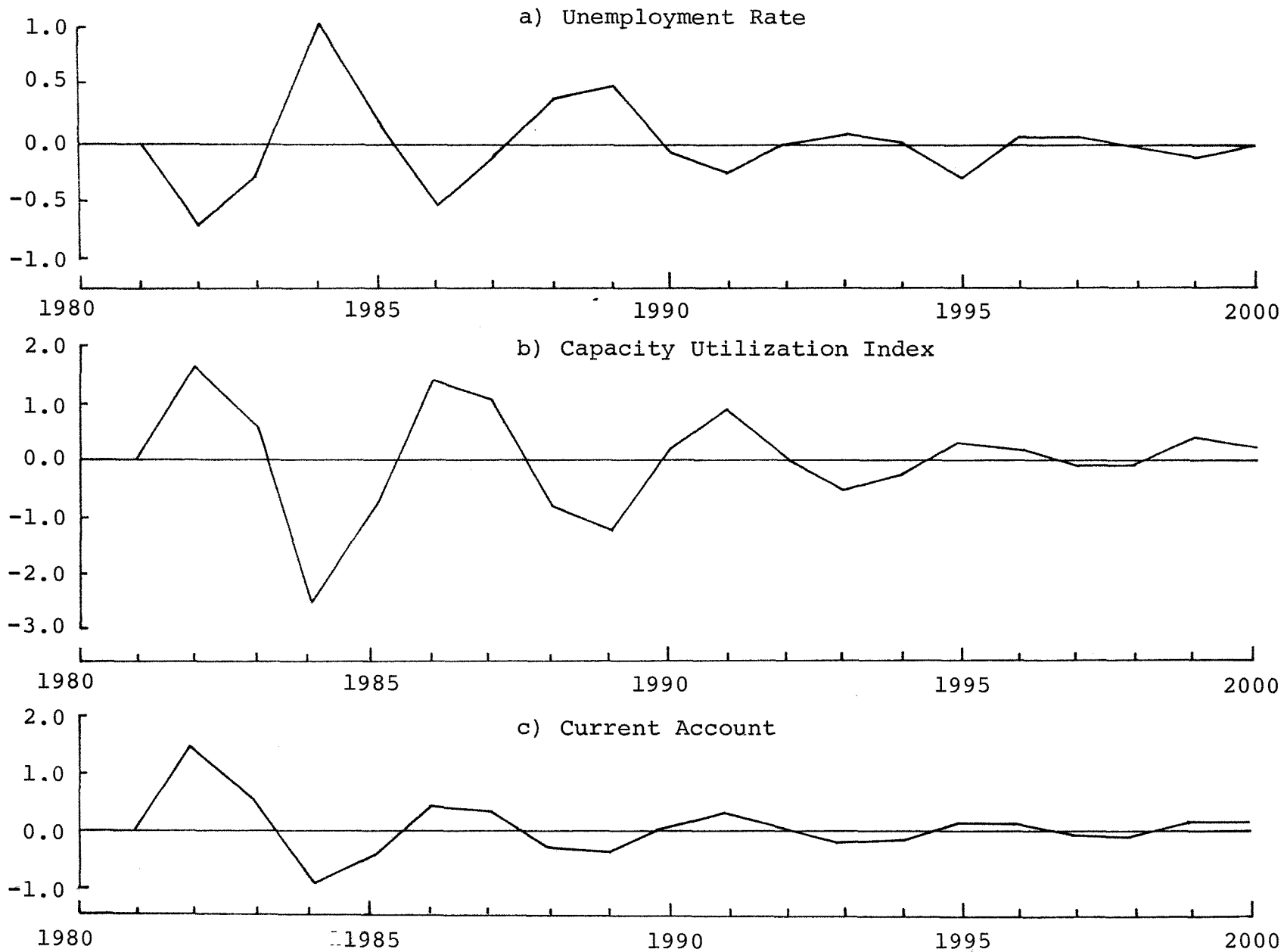

Figure 5.7 Effects of Temporary 5 % World Trade Increase 1982-84
(Difference from Reference Case)



- parameters in the income tax function
- wage tax rate
- exchange rate
- central government consumption and grants
- autonomous wage rate increase

Needless to say the correspondence between model and real life instruments is not exhaustive. Since the model i.a. does not explicitly include financial markets no monetary policy instruments are present.

One may of course also have reasonable doubts about how far the variables listed above are really available as policy instruments. The wish to use control variables analogous to those used in actual decision making has in fact been an important reason for including some submodels, such as the local government model, and for the fairly detailed treatment of taxes and transfers in the household sector model. The traditional treatment of e.g. the local government sector growth as an instrument for macro policy is obviously unsatisfactory since such an instrument simply is not available for central government decision making. The local government submodel makes it possible to affect local growth by i.e. changing grants to local authorities. When it comes to wages some kind of control is simply assumed. Note however that the wage rate control is assumed indirect through the constant term in the wage function (cf. section 3.13). "Uncontrolled" short term fluctuations in the wage rate are still possible.

Before describing the effects of different policy measures in the model a few words must be said

about how they are used. Since the model is solved year by year it would be possible to change control every year. For practical as well as theoretical reasons this is however not done. Suffice it to say that important short term mechanisms still are lacking in the model, e.g. inventory functions, and that credit markets are not yet explicit in the model. A certain setup of policy variable values are instead assumed to be maintained for several years - in most applications of the model five or ten years. The use of control variables in the model should for that reason be seen as medium term guide lines to economic policy without regard to short term fluctuations.

Figure 5.8 shows the ten year effects of four policy instruments in terms of unemployment rate and balance on current account (as percent of GDP). The arrows show the difference in unemployment rate and current account (as percentage of GDP) between a reference simulation, PO, and simulations with different values of policy parameters. All differences are measured for the single year 1990 only. For example, the arrow P1 gives the effects in 1990 of a gradual shift upwards of the personal income tax scale during the eighties. As can be seen from the figure this will improve the current account compared to the reference simulation outcome in 1990, while leaving the unemployment rate unaffected. The immediate impact of increased taxes is to depress private consumption, which will save imports and improve the current account. The fall in domestic demand will almost totally be compensated by external demand stimulated by improved relative prices due to less pressure on the labor market and hence on wages.

Figure 5.8 Ten Year Effects of Policy Instruments

Current account/GDP (percent)

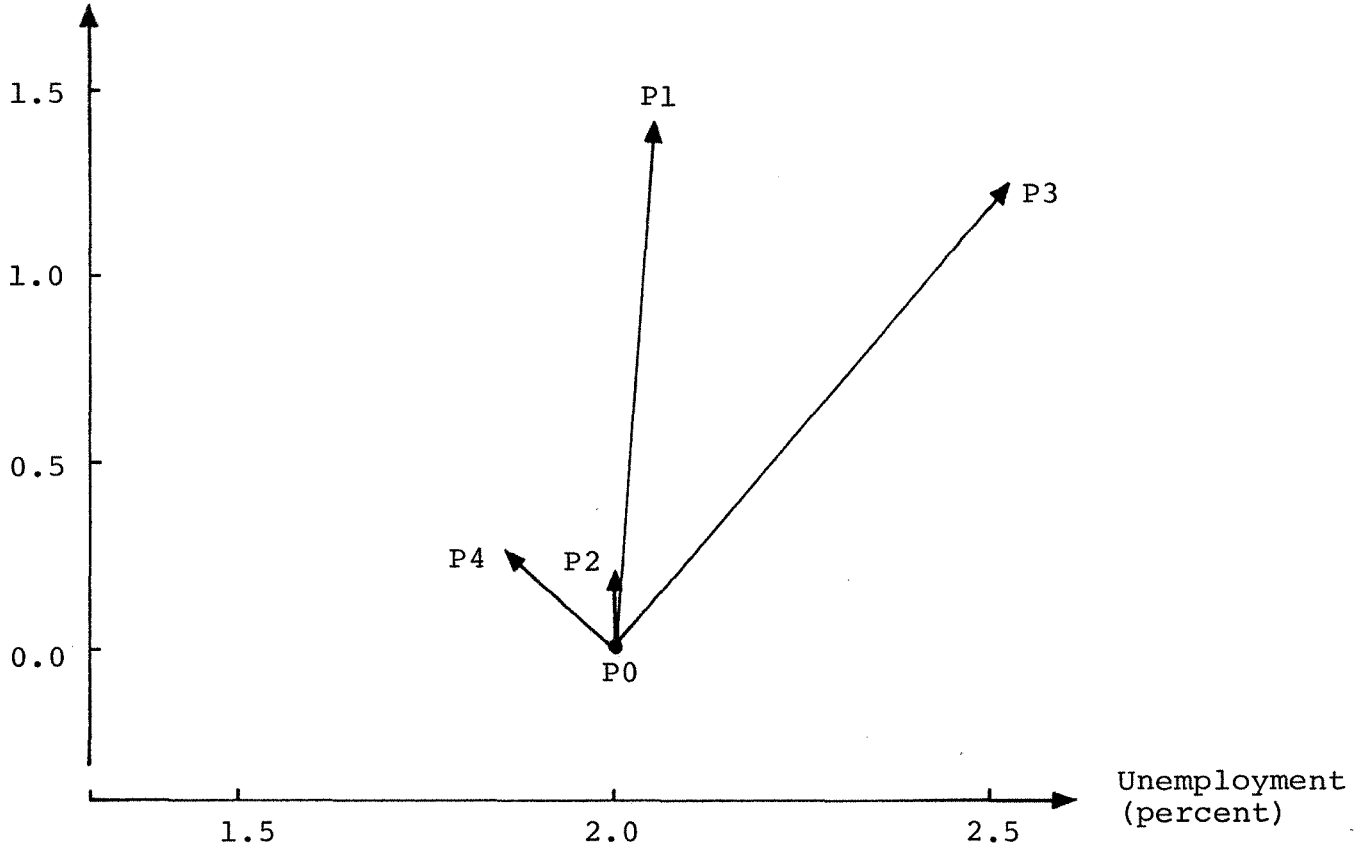

P1: Upward shift of income tax scale by 0.5 percentage points every year 1981-90

P2: Depreciation of currency by 1 % per year 1981-90

P3: Public consumption growth rate decreased by 0.5 percentage point for the period 1981-90

P4: Autonomous wage trend decreased by 1 percentage point for the period 1982-90

Besides tax policy domestic demand can be directly affected by control of public consumption growth. The arrow P3 shows the effect of a growth rate decrease by one half of a percentage point during the eighties compared to the reference case. Like P1 which reduces private consumption, this will improve the external balance while increasing unemployment. The unemployment rate will however be considerably larger given a certain improvement on current account. The reason is of course that the tax increase will in itself reduce imports through reduced private consumption, while public consumption variations have small direct effects on imports. In this case the whole external improvement will be indirect and caused by higher unemployment rates which will reduce wages thereby improving external competitiveness but also reducing households income and consumption.

The two measures P2 and P4 are aimed directly at relative wage and cost conditions. With the wage function that is used (cf. sections 3.13 and 4.2) devaluations of the currency will be of little use to affect the external or internal balance since it will only produce domestic compensatory inflation responses. Reducing the "autonomous" wage growth will, on the other hand, obviously affect current account as well as employment positively as shown by P4.

Some words of caution should be said about the interpretation of the "effect-arrows" in Figure 5.8. To begin with, since ISAC is a dynamic model the effects of policy measures of the kind discussed above will not be constant over time. What is important to our interpretation and use of these parameters as control variables is however only

that after some years the effects will stabilize around some fixed level or rate of change. Figure 5.9 gives the development over the eighties of the four policy measures shown in Figure 5.8. Although there are evident cycles in some variables average levels seems fairly stable and the amplitudes are small. Therefore we feel rather safe to pick a single year to represent the effects of different policy measures. As shown in Figure 5.9 however there may occur shifts in the effects between policy instruments even after the initial impact phase. In the particular simulations shown in the figure this relates primarily to currency and wage policy respectively. Much of the crossings of the effect curves P2 and P4 however have other causes. The wage rate is exogenous in 1981 for technical reasons implying that wage policy is in fact not initiated before 1982. An appropriate picture of the stability of policy effects is obtained if the wage policy curve, P4, is shifted one year backwards in both diagrams.

A second point to bear in mind in connection with the policy effects as shown in Figure 5.8 is the difficulty to compare the power of different policy measures. Generally the length of the arrows can not be used for such comparisons since one also has to consider the policy parameter changes behind them. Strict evaluation requires a social loss function to be specified. However one kind of conclusion as to the usefulness of different measures can be drawn. Assume that the model economy initially is out of balance in 1990. To move it back to an equilibrium solution in terms of the currency and labor markets generally two of the control variables must be used. From Figure 5.8 it is obvious that changes in income tax and

Figure 5.9 Policy Effects during the Eighties.
Difference from the Reference Case
in Percentage Points

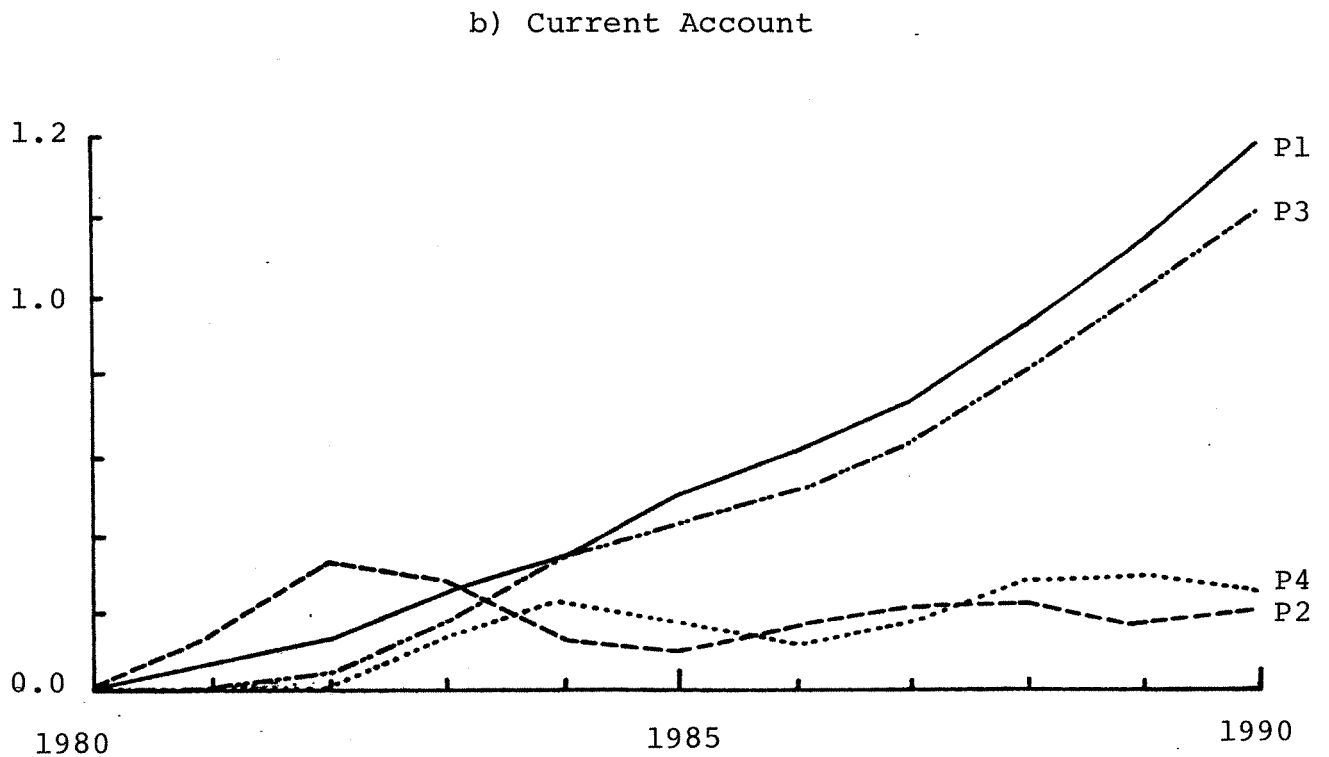

exchange rate are rather ineffective to influence employment levels. A policy packet consisting of only these two measures can not therefore cope with excess demand in the labor market as the model is specified. It is also indicated by Figure 5.8 that a combination of wage policy and public consumption control may be the most effective policy packet. The fact that their effect arrows runs almost perpendicular makes it possible to reach an arbitrary shift in unemployment and current account with lesser changes in policy parameters.

Finally, as have been indicated several times before, there is no outright optimization procedure used in controlling the model. The rough method used to measure the effects of e.g. different world market conditions is to steer the model to an equilibrium solution in the currency and labor markets, checking off the capacity gap, and then to read off the differences over time in relevant variables including the policy parameters. Of course this introduces some degree of arbitrariness into the analysis but seems to us to be the practical way to use such a large model as the one described here.

5.4 Structural stability

The concept of structural stability is a more tricky notion than it looks at first sight. To make sensitivity tests of structural coefficients around a given simulation path is a standard procedure for any conscientious modeler. In the case of ISAC it is intuitively obvious that the model is structurally stable in the narrow sense that the

absence of explicit discontinuities in the model guarantees that small isolated changes in the coefficients will only result in small displacements of the simulated growth path¹.

We will illustrate this statement by three tests where some strategic parameters are changed. These relates to (A) the price setting behavior of manufacturing companies, (B) the price responsiveness of foreign demand for Swedish goods and services and, finally, (C) the extent of compensation for past inflation in wage formation.

In the first test (A) manufacturing companies are assumed pay more attention to domestic production costs than to world market price developments in setting their prices than in the standard model set up. More precisely the elasticity of prices with respect to unit costs is increased from 0.5 to 0.75 for manufacturing branches and the elasticity with respect to world market prices correspondingly reduced from 0.5 to 0.25 (excl. branch No. 12, cf. section 3.12 and Table 4.4). As can be seen from Figure 5.10 the effects on the equilibrium growth path in terms of excess demands are rather insignificant. The initial impact will be a small deterioration in utilization of resources compared to standard assumptions since the initial unfavorable cost development will to a larger extent push up export prices and thus weaken real foreign demand. However when wage and cost increases are slowed down after a couple of years the positive effects on export prices and competitiveness will be felt implying reduced unemployment and improved external balance. Differences from the standard case will exist through the whole simulation period but will remain small.

Figure 5.10 Increased Cost Influence in Price Setting (A).
Standard Assumption Given by Dashed Lines

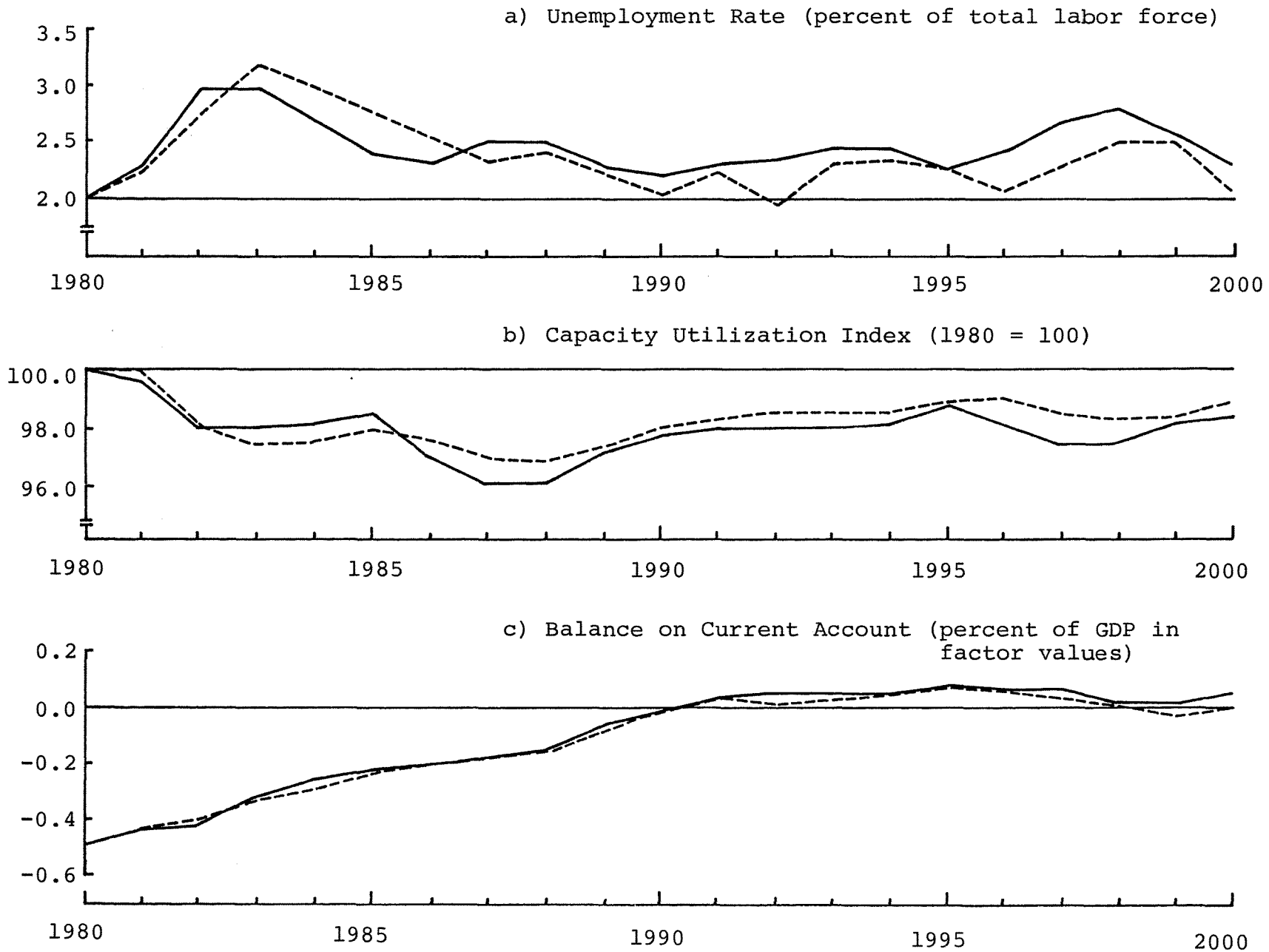

In the second structural stability test (B) the immediate foreign demand response to Swedish export prices is increased. More specifically the short run elasticity of exports with respect to relative price is on average about 2.2 compared to 1.2 in the standard set up. The result is shown in Figure 5.11. Obviously excess demands are also in this case confined to a fairly narrow region around the reference equilibrium growth path, although fluctuations seems to increase somewhat. This is what should be expected since small changes in prices will transform into a larger change in real demand (from abroad) than in the standard set up.

In the last structural test (C) the coefficient variation will on the other hand have a stabilizing effect. In this test the degree of compensation for (past) inflation in the wage function was reduced from 1.0 to 0.75 (cf. section 4.2). This will reduce the rate of unemployment "needed" to break the tendency to self sustaining wage inflation implied by the specification of the wage formation in the model. As is seen in Figure 5.12 the reduced compensation also permits the economy to increase the long run employment level through reduced real wages and improved competitiveness on world markets. Still the corresponding growth path is stable.

However given the likely structural stability of the model one may wish to penetrate further into the effects of different coefficient assumptions. This will be done below on basis of the three types of parameter changes discussed earlier in this section. The coefficient assumptions will be compared with respect to the development of priva-

Figure 5.11 Increased Price Response in Foreign Markets (B).
Standard Assumption Given by Dashed Lines

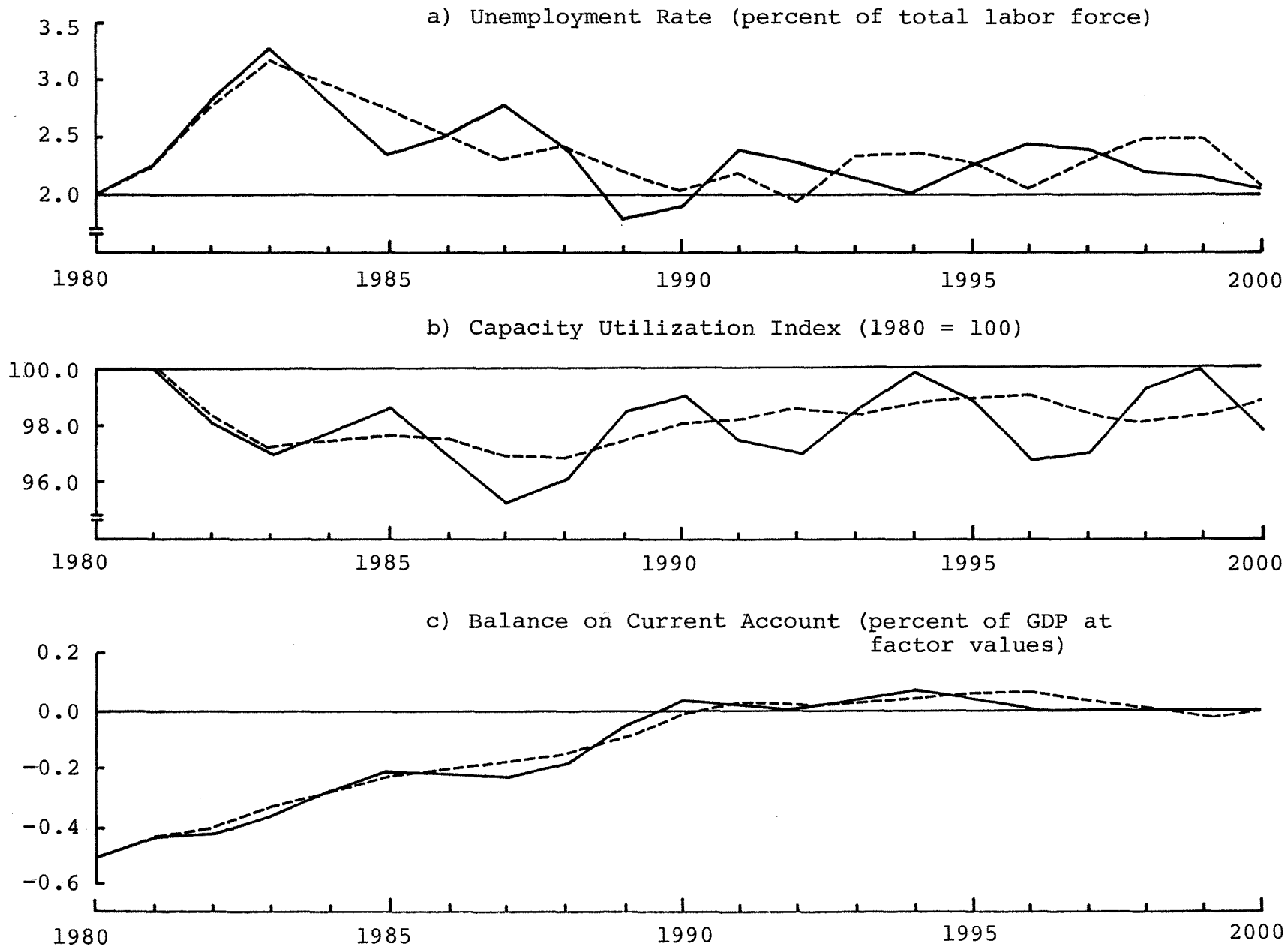
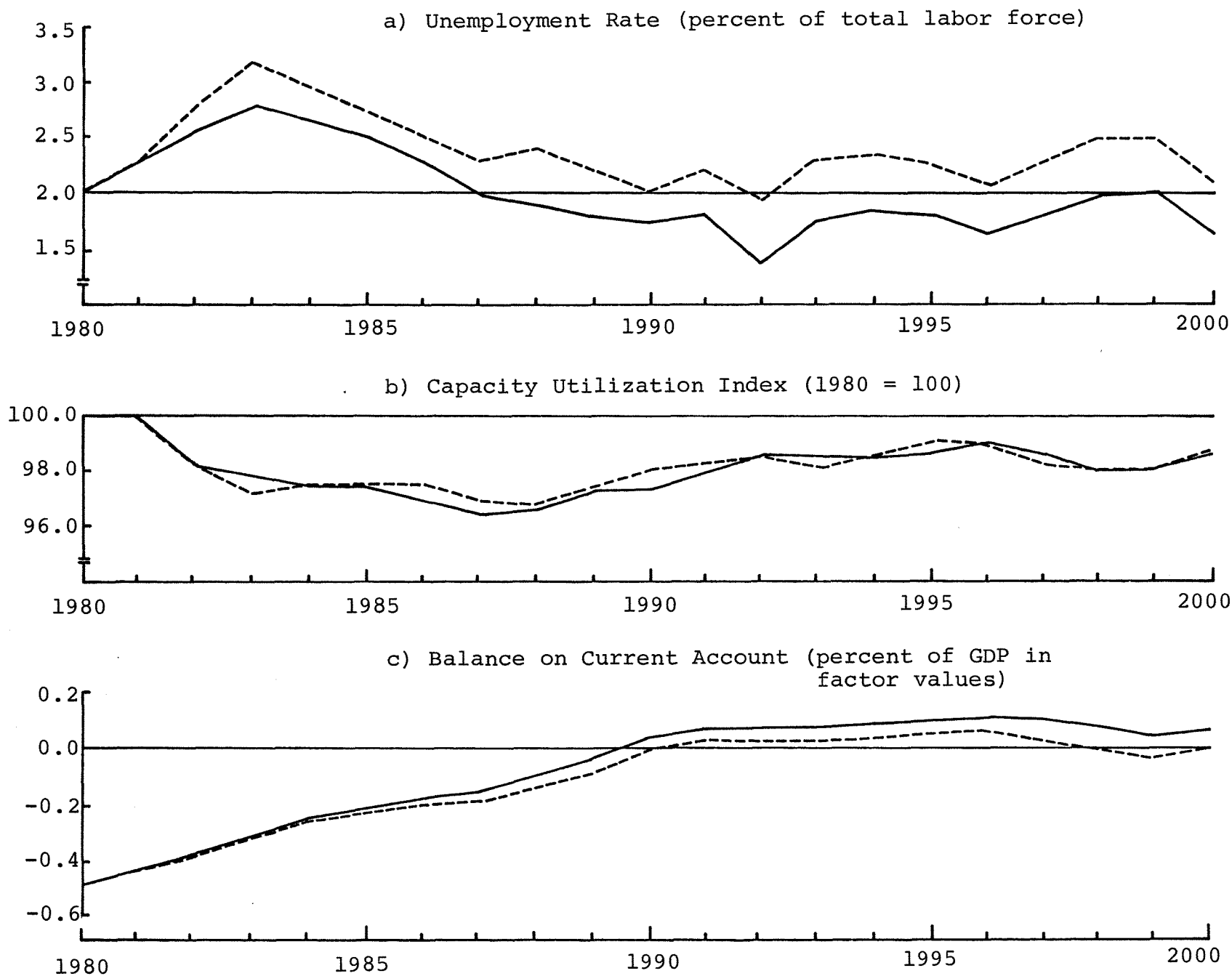

Figure 5.12 Reduced Inflation Compensation in Wage Formation (C).
Standard Assumption Given by Dashed Lines



te consumption, the effects of policy parameters and, finally, the resilience of the system.

Even though structural coefficients may not affect the stability of the system the resulting growth paths may differ when evaluated in terms of some social well fare or loss function. In Figure 5.13 the three simulations A-C are compared to the reference case simply in terms of level of private consumption. Although differences to the standard growth path are small - within $\pm 0.5\%$ - for all cases some pattern is discernible. For A and B the consumption path is more or less a mirror image of employment (cf. Figures 5.10a and 5.11a) i.e. higher employment leads to higher consumption and vice versa with no differences in real income per capita compared to the reference case. In (C) however, with less than inflation compensated wages even in the long run real income per wage-earner will be reduced leading to lower total private consumption despite increased employment. Since aggregate productivity is almost equal between the simulations and public consumption is the same by definition, the external balance must improve as showed in Figure 5.12c.

The consumption effects of variations in the coefficients in question may seem small with regard to the rather significant changes that was studied. The reason for this lies partly in the model specification. Since wages are assumed to respond quickly and strongly to labor market conditions close to normal employment levels are almost always assured. Also aggregate productivity does not change much unless investments are substantially increased. Finally public consumption is exogenous in the version of the model used for these experi-

Figure 5.13 Effects on Private Consumption
(Reference Case = 100.0)

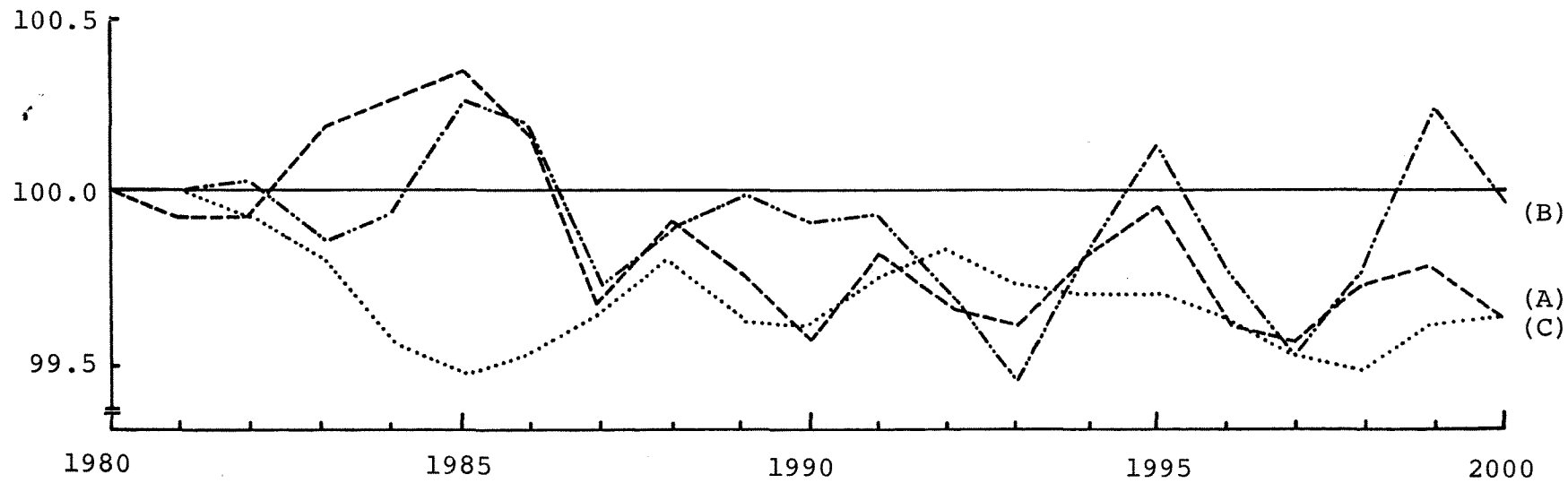

- R: Reference Case
- - - A: Change in Price Setting Behavior
- · - · B: Change in Export Price Elasticity
- C: Change in Wage Formation

ments. These factors together imply that increased private consumption can only be explained by one or several of either increased employment, increased external deficit or improved terms-of-trade. The model specification however to a great extent rules out any significant contributions from the employment effect.

Hoever one might have expected fairly large effects from especially the change in export price elasticities with amplified price responses leading to improvements in the external balance and/or a smaller necessary deterioration in terms-of-trade since foreign market demand would come forth without large decreases in relative export prices.

The fact that expected strong effects seems to be lacking in our experiments relates to more general problems than model specification in interpreting and analyzing sensitivity tests.

A first type of problem is connected with the obvious fact that the results of different coefficient variation will not be independent of each other, i.e. cannot be simply added. The effects of changing export or import price-elasticities will e.g. in general vary with variations in the income elasticity of imports. The positive effect, in a trade-deficit situation, of a more price-elastic export market is thus reduced by a higher propensity to use marginal income additions for import.

Also the effects of changed coefficients generally depend on the standard growth path used as reference point. Again a specific change in foreign trade price elasticities will affect the growth path

more or less depending on the degree of relative price change assumed in the reference simulation. If, for instance, world trade growth is so generous as to permit external balance without reduced relative export prices, the effects of changes in price elasticities will of course be insignificant.

This is the reason why the model economy reacted so little to the elasticity test accounted for above. Starting, instead, from significant relative price changes export and import price elasticities will be of strategic importance.

To illustrate possible changes in policy effects of different coefficient assumptions the same policy instruments as in section 5.3, summarized in Figure 5.8, are used. From Figure 5.9 it is evident that the relations between policy effects in terms of unemployment and external balance will change with time but stabilize after some years. (Note the one year late execution of wage policy.) This relative stability is necessary to discuss ten year (or long run) effects as in Figure 5.8. Changing structural coefficients will however to a varying degree also change cyclical patterns in the model economy. Therefore the relative effects of a change in a specific policy instrument under different coefficient assumptions are sometimes rather unstable throughout of the simulation period. Despite these problems of interpretation the ten year effects of each of the four policy instruments are indicated in Figure 5.14 for the reference simulation (R) and the three coefficient variations (A, B and C) described earlier in this section.

Each of the four subdiagrams are constructed in the following way. For the standard coefficient set up the model is run through the eighties with and without the specific tax scale parameter change. The 1990 difference in unemployment rate and current account (as percentage of GDP) gives the arrow R. This procedure is repeated for each of the chosen coefficient variations resulting in arrows A-C. Then the next policy instrument effect is analyzed in the same manner and ten year differences market off as arrows R, A, B and C respectively, etc.

Trying to correct for cyclical effect pattern a tax rate increase will have almost identical long run effects on unemployment and external balance irrespective of choice of coefficients in question. The effect will be close to the reference case (R) in Figure 5.14a.

Also the effects of a gradual currency depreciation seems not to depend very much on different coefficient values with average effects along the B-C arrows. It may be interesting to note however that the long run "efficiency" of the instrument (the length of the arrow) is insignificant in all but one coefficient set up. The exception of course is C, i.e. the reduced inflation compensation in wage formation. With total compensation, potential improvements in international competitiveness following from depreciating the currency will not materialize, since imported price increases will be compensated for and again push up domestic costs and prices. The same general remarks are valid for the instruments shown in the last two subdiagrams. Thus, the conclusion is that (long run) policy effects will be fairly unaffec-

Figure 5.14 Consequences for Policy Parameter
Effects of Changed Structural
Coefficients
(See Text for Explanation of Symbols)

a) Tax Rate Increase

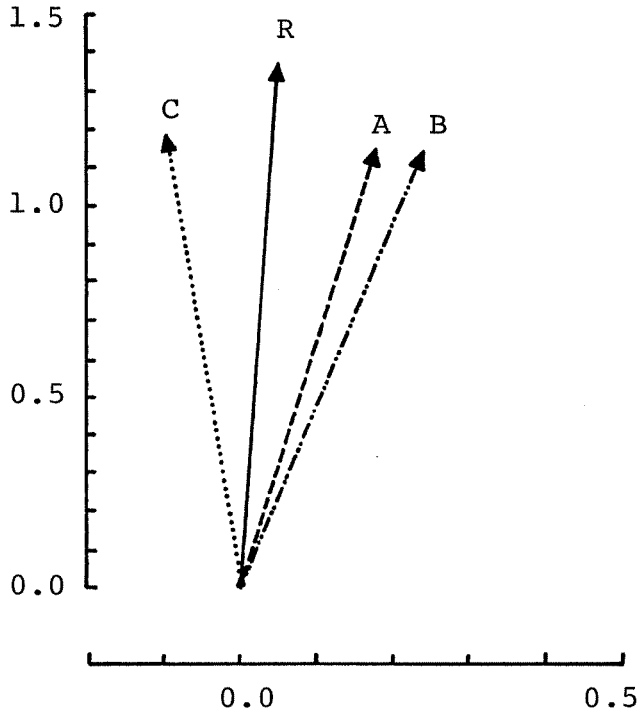

b) Depreciation of Currency

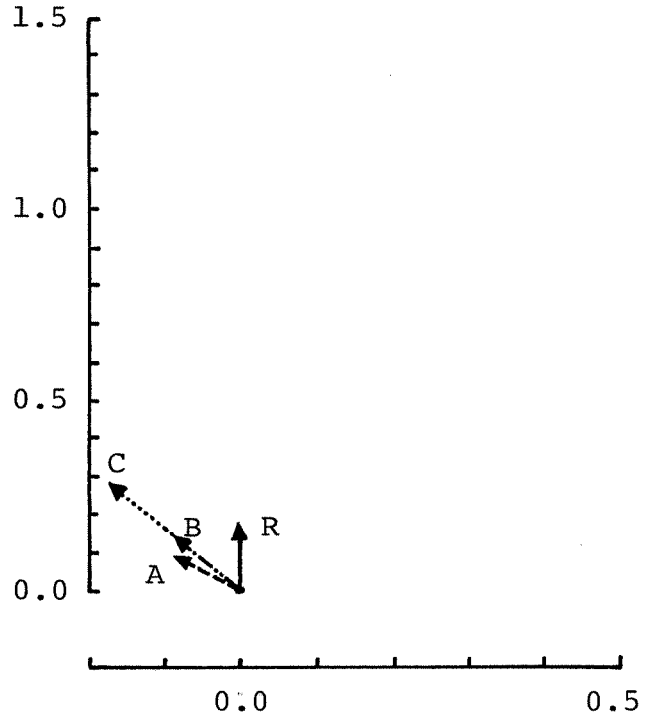

c) Reduced Public Consumption Growth

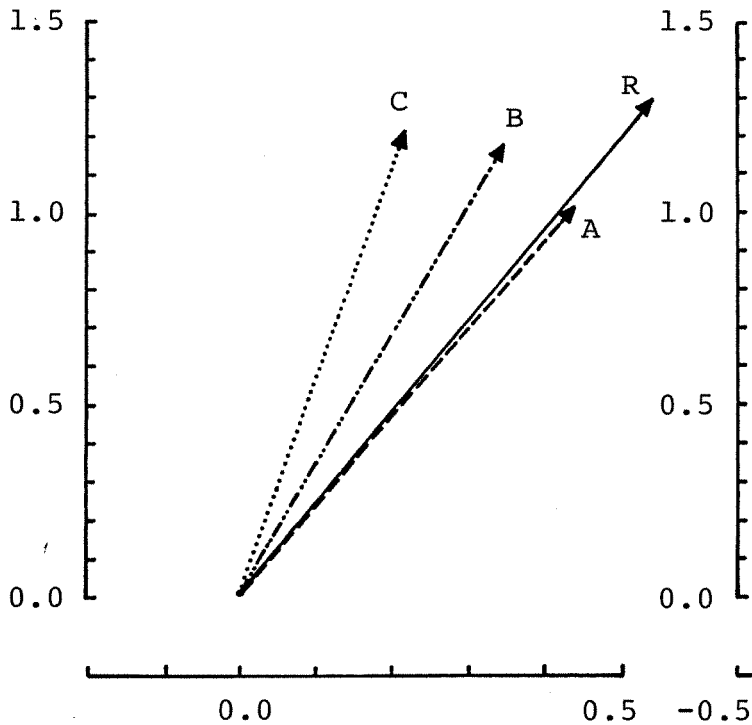

d) Reduced Autonomous Wage Rate Growth

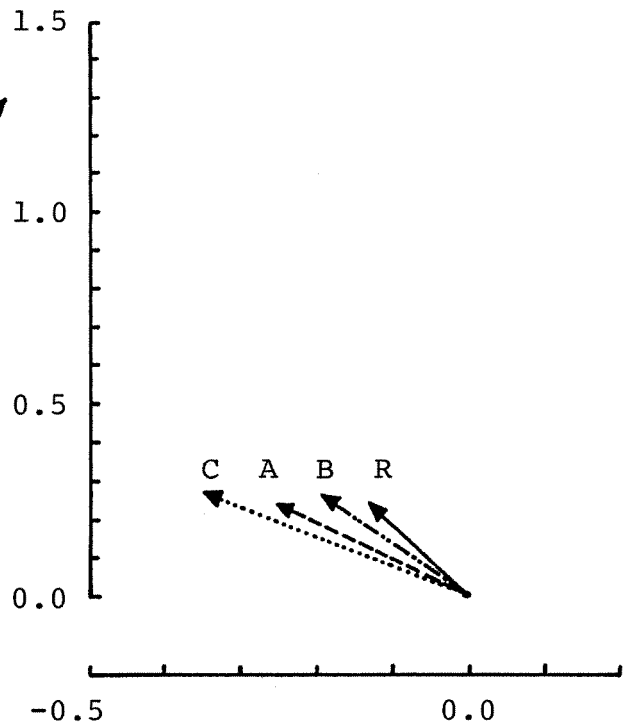

ted by, at least, those coefficient variations that are accounted for above.

Finally the effects of coefficient variations on the resilience of the model will be briefly discussed. The testing procedure is analogous to the one used in the policy effect experiments. The model is run with different coefficient configurations and for each one of these tested for the effects of world market disturbances. These are designed as sudden 5% general increases in 1981/1982 in world market prices and world trade respectively above the level assumed in the reference case. The higher levels of prices and traded volumes are assumed to persist (cf. section 5.2). The results of these experiments are showed in Figures 5.15-16 in terms of differences in unemployment rates between disturbed and undisturbed simulations for each coefficient assumption. To start with the price disturbance shown in Figure 5.15 the resilience of the system seems to be preserved although there are perceivable differences between different coefficient assumptions. With less weight on world market prices assumed in companies' price setting (case A) the external price shock yields a considerable lowering of relative prices. Through increased net foreign demand this price differential will transform into a reduction of unemployment that is twice as large as in the reference case (R). After the first full cycle the further development will however stick fairly close to the path given by the standard coefficient set up (R). With increased price responsiveness of foreign demand (case B) cycle amplitude in terms of unemployment differences will be still enhanced. Moreover the amplitude of the oscillations seems to decrease somewhat although with this choice of

Figure 5.15 Effects on Unemployment Rates of 5 % World Price Increase in 1981/82 for Different Parameter Assumptions
 (Difference in Percentage Points from Undisturbed (Cases))

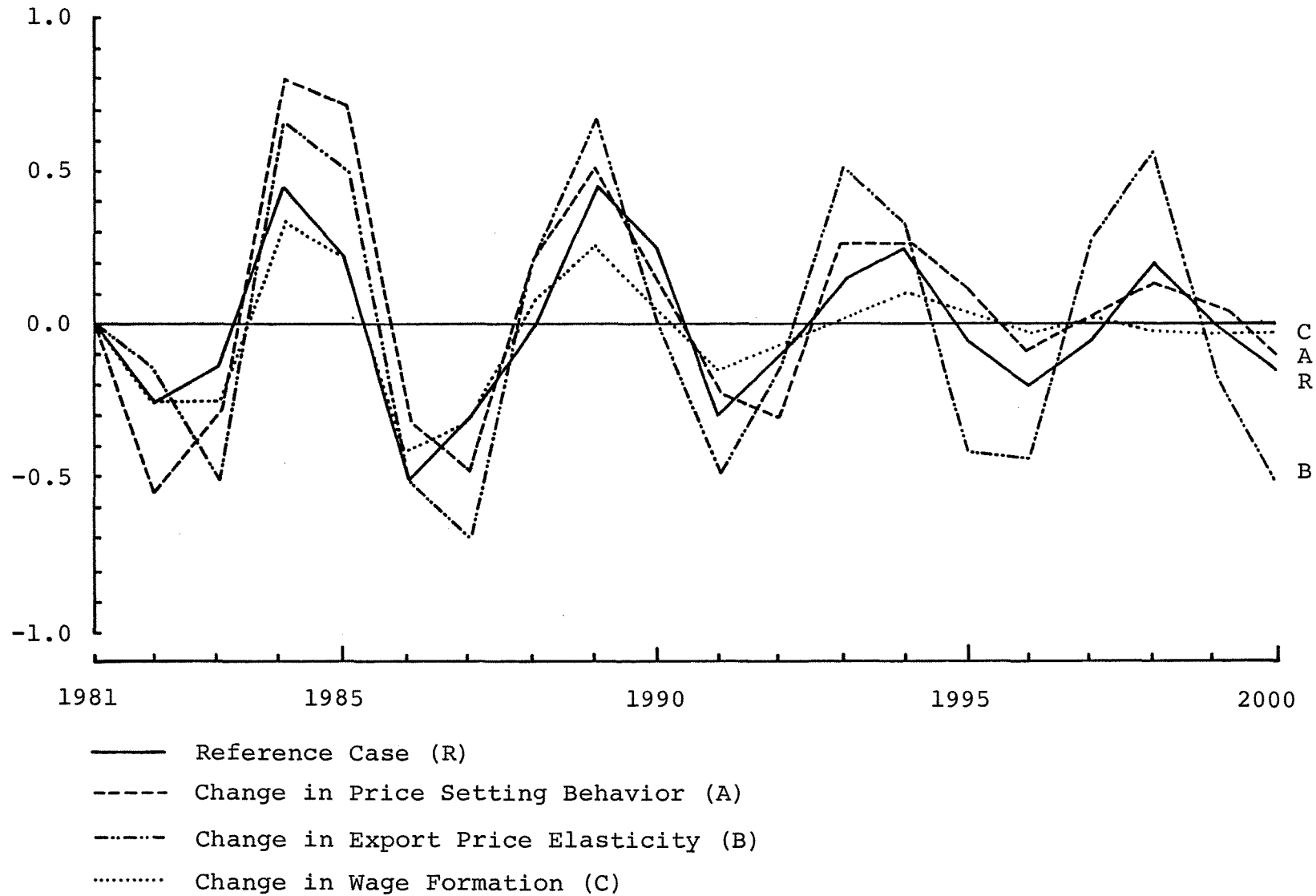

coefficients they will be more than four times as large as in the other cases at the end of the period. In case C, finally, the limited inflation compensation can be seen to increase the model's ability to absorb an external price shock as expected.

Turning now to the effects of a trade growth shock, Figure 5.16 tells pretty much the same story. The repercussions of this disturbance will be strong throughout the simulation period in the case of increased export demand price elasticity (case B). Although the simulation path does not seem to "explode" there are no signs of dampening effects on the unemployment cycle generated by the initial disturbance.

Taken together these experiments show that resilience of the model is not always guaranteed. This is, of course, of no surprise.

5.5 Adaptivity or the limits of macro-models

A major problem in making long-term projections with a model, whose structure has been estimated from the experience of past decades, is that we do not know to what extent the attitudes and the behavior reflected in the estimated structure, will be relevant also in the future. Has the stagflation and the stabilization problems following in the wake of the 73'-crisis caused such changes in the behavior or structure of the economy that we can no longer trust past experience and econometric estimates? The increasing tax-consciousness, the tendencies towards more cautious pricing and investment-reactions to advantageous cost-develop-

Figure 5.16 Effects on Unemployment Rates of 5 % World Trade
Increase in 1981/82 for Different Parameter Assumptions
 (Difference in Percentage Points from Undisturbed Cases)

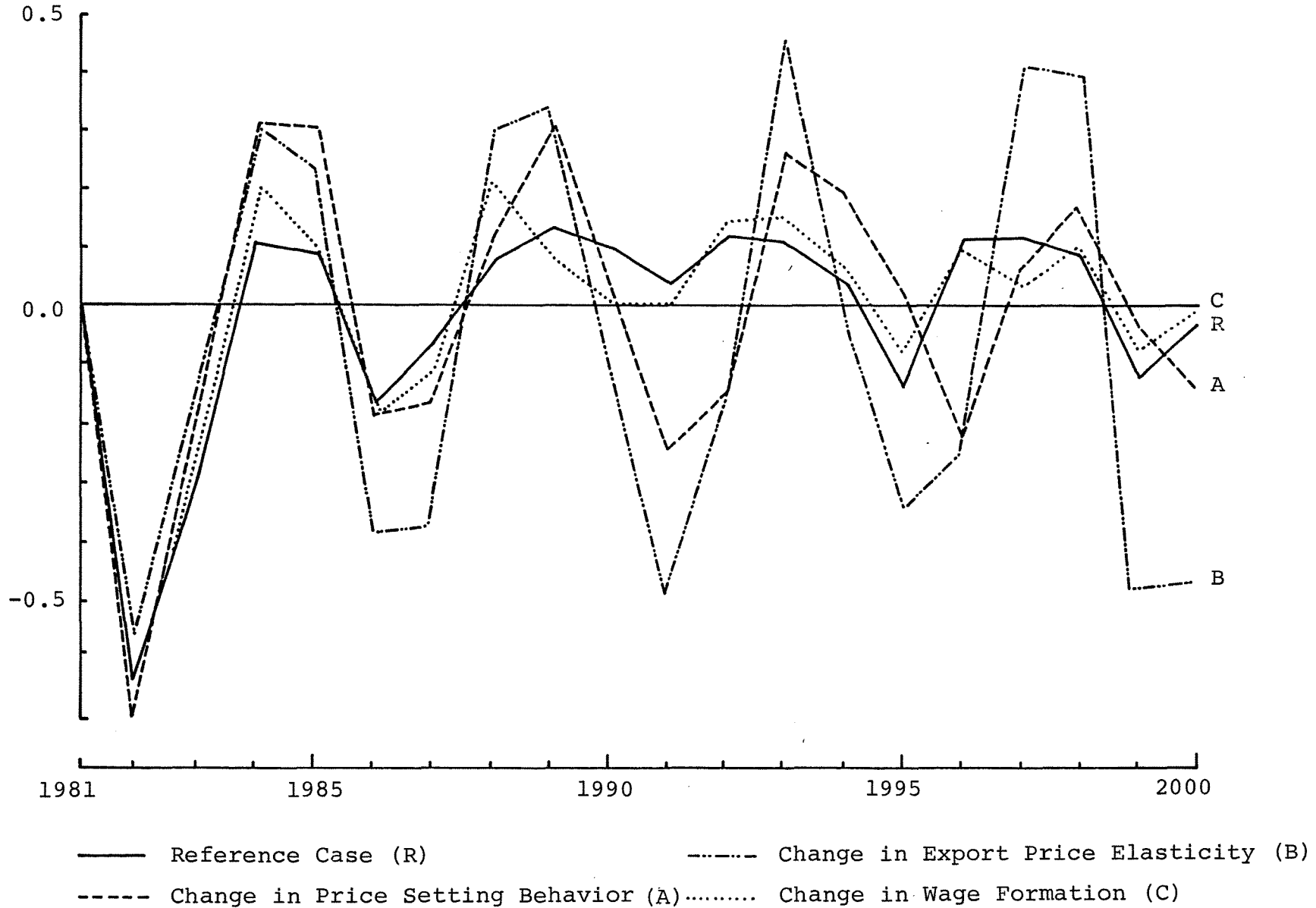

ments, the growing dominance of public employees in the wage formation process, the increasing extent of inflation-indexing, the new currency regimes and shifts in corporative ownership and financing are points in question for the Swedish economy.

That these changes do not come out of the blue, but have to be explained in terms of the economic events in the past, seems evident. An even more ambitious task would be to study to what extent these institutional and behavioral changes tend to make the economy more stable or more manageable. Does, e.g., the increased tax-consciousness and tax-adjustment make local authorities more sensitive to income-changes and by that less counter-cyclical in spending behavior? Have the increased price uncertainty also increased the risk-aversion in the firms, adding new inertia to the economy? In what degree is the economy adaptive - or the opposite?

There is obviously no way in which we could even attempt to answer these large questions, crucial as they may be for any hope of basing policy on econometric projections. We have, anyhow, probably the wrong kind of model to even start exploring them. The structural coefficients of a macro-model, like ISAC, should always be thought of as rough estimates of the aggregate outcome of underlying probabilistic micro-processes. The aggregate demand curves we estimate, e.g., sum the net effects of a number of oligopolistic firms trying to capture new markets and customers - or retain old ones - by new prices and more differentiated products and attempting to get the message across to the customers who in their turn are searching for

new and better price-product combinations. The degree of flexibility in market supply and demand with that the resilience and manageability in the economy will then, in the end, depend on the production, consumption and search strategies for the involved firms and households. An explanation of structural change and adaptivity will, in most cases, have to start at the micro-level. When we come up against questions of adaptivity we have reached one - of the many - limits to macro models.

Notes

¹ This is not entirely true for the local government expenditure model where e.g. liquidity accumulated above certain limits will bring about increasing expenditures.

Appendix A: The system of equations

$n = 23$

$m = 14$

$u = 20$

Bloc	Number of variables	Number of equations
Commodity balances	$33n$	$3n$
Production capacity etc.	$(2u+15)n$	$(2u+39)n$
Foreign trade	n	$2n$
Private consumption	$n+2m+2$	$n+2$
Government production etc.	$0.5m+4$	$n+1.5m+4$
Prices	$n+1$	$4n+1$
Wages	$n+3m+4$	$2n+4m+4$
Total	$92n+5.5m+11$	$92n+5.5m+11$

Commodity balances

n = 23

m = 14

Equations	Name of endogenous variables not counted before	Number of variables	Number of equations
$m+x = h+e$	$m, x, h, e,$	4n	n
$\hat{m} \cdot \theta_p^w + \hat{x} \cdot p^x = \hat{h} \cdot p^h + \hat{e} \cdot p^e$	p^x, p^h, p^e	3n	n
$h = Ax+inv+pc+pu+ds$	A, inv, pc, pu	26n	n
		33n	3n

Production capacity and production technique

n = 23
m = 14
u = 20

Equations	Name of endogenous variable not counted before	Number of variables	Number of equations
$Q = \sum_{v=t-u}^t Q^v \hat{x}^{-1} \bar{x}^v$	$Q, Q^v, \bar{x}, \hat{x}^v$	$(u+1)n$	$5n$
$Q^t = F_Q [p^h(t-1), w(t-1), t]$	-	-	$5n$
$\bar{x}^t = (Q_5^t)^{-1} g$	g	n	n
$d^v = F_d [p^x(t-1), p^h(t-1), w(t-1), Q^v, \bar{x}^v(t-1)]; v=t-u, \dots, t-1$	d^v	$(u-1)n$	$(u-1)n$
$\hat{x}^v = (I - d^v) \hat{x}^v(t-1); v=t-u, \dots, t-1$	-	-	$(u-1)n$
$\bar{x} = \sum_{v=t-u}^t \bar{x}^v$	-	-	n
$ur = \hat{x} \cdot \hat{x}^{-1}$	ur	n	n
$A = F_A(Q)$	-	-	$23n$
$g = F_g [ep(t-s), ur(t-1), k(t-1)]; s = 1, \dots, 4$	ep	n	n
$ep = (p^x - p^h A - \hat{\omega} \cdot \hat{l} - \hat{i}) (p^k \hat{k})^{-1}$	k	n	n
$p^k = F_p(p^h, r)$	p^k	n	n
$\hat{k} = Q_5 \cdot \bar{x}$	-	-	n
$inv = G \cdot g$	-	-	n
		$(2u+15)n$	$(2u+39)n$

Note: a) Only 20 different vintages are distinguished in each branch.

b) Q_r is a vector of capital output coefficients.

Foreign trade

$n = 23$

$m = 14$

Equations	Name of endogenous variable not counted before	Number of variables	Number of equations
$e = F(p^e / \theta p^w(t-s), wm); s=0,1$	-	-	n
$m = F_m(p^{xh} / \theta p^w(t-s), h); s=0,1$	p^{xh}	n	n
		n	2n

Private consumption

n = 23

m = 14

Equations	Name of endogenous variable not counted before	Number of variables	Number of equations
$pc = F_{pc}(y_{11}, pc(t-1), p^h, p^h(t-1), besk)$	$y_{11}, besk$	2	n
$y_{11} = w' \cdot l + w^D' \cdot l^D$	l, w^D, l^D	n+2m	1
$besk = F_{besk}(y_{11})$	-	-	1
		n+2m+2	n+2

Government production and investment

$n = 23$

$m = 4$

Equations	Name of endogenous variable not counted before	Number of variables	Number of equations
$pu = (SG, LG) \cdot xp + (sg, lg) \cdot ip$	ip	2	n
$xp = \begin{matrix} xs \\ xl \end{matrix}$	xl	$0,5 \cdot m$	m
$ip = \begin{matrix} i_s \\ i_l \end{matrix}$	i_s, i_l	2	2
$i_s = F_{si}(xs)$	-	-	1
$xl = F_{lp}(besk, utd, w^l, p^h)$	-	-	$0,5 \cdot m$
$i_l = F_{li}(xl)$	-	-	1
		$0,5m+4$	$n+1,5m+4$

Prices

n = 23
m = 14

Equations	Name of endogenous variable not counted before	Number of variables	Number of equations
$p^e = F_p^e(\theta_p^w, uc, ur(t-1))$	uc	n	n
$p^{xh} = F_p^{xh}(\theta_p^w, uc, ur(t-1))$	-	-	n
$uc = A \cdot p^h + Q_4 \cdot \hat{w} + Q_5 \cdot p^k$	-		n
$\hat{p}^x = [\hat{e} \cdot p^e + (\hat{x} - \hat{e}) \cdot p^{xh}] \cdot \hat{x}^{-1}$			n
$cpi = p^h \cdot pc / \sum_{i=1}^n pc_i$	cpi	1	1
		n+1	4n+1

Employment and Wages

n = 23

m = 14

Equations	Name of endogenous variable not counted before	Number of variables	Number of equations
$l = \hat{Q}_4 \cdot x$	l	n	n
$q^p = \frac{q^s}{q}$	q^p	m	m
$l^p = \hat{q}^p \cdot x_p$	l^p	m	m
$u = (l_s - x' \cdot Q_4 - x_p' \cdot q^p) / l_s$	u	1	1
$\dot{w}_O = F_w [cpi(t-1), u, \Pi^m(t-1), Q_4^m(t-1)]$	Π^m, Q_4^m, w_O	3	1
$\dot{\hat{w}} = \dot{w}_O \cdot I$	-	-	n
$w^p = \frac{w^s}{w}$	w^p	m	m
$\dot{\hat{w}}^p = \dot{w}_O(t-1) \cdot I$	-	-	m
$\Pi^m = \frac{\sum_{i=1}^{14} [p_i^x - (A' p^h)_{i-i_i}] x_i}{\sum_{i=1}^{14} x_i}$	-	-	1
$Q_4^m = \frac{\sum_{i=1}^{14} Q_{4,i} \cdot x_i}{\sum_{i=1}^{14} x_i}$	-	-	1
		n+3m+4	2r+4m+4

Notes

¹ The income tax function in the model is specified in the following way (cf. section 4.7)

$$y_{41} = t \cdot [a_{41} \cdot skind \cdot n_b \cdot (besk/skind/n_b)^{b_{41}} + utd_0 \cdot besk]$$

where

y_{41} = total income tax

a_{41} = constant

$skind$ = inflation compensation index

n_b = number of taxpayers

$besk$ = taxable income

b_{41} = central government income tax elasticity

utd_0 = local government tax rate in 1980

t = policy parameter

This specification of the tax function is used when local governments are exogenous and included in the policy arsenal. With endogenous local sector also the local tax rate is endogenous. This will of course greatly reduce the effects of changes in t .

Appendix B: List of symbols

Symbol	Meaning	Dimension
COMMODITY BALANCES		
$*^1x$	Domestic production	23
$*m$	Imports	23
$*e$	Exp-orts	23
(*)A	I/o coefficients	23x23
(*)inv	Demand for investment goods	23
$*pc$	Private consumption demand	23
(*)pu	Public sector demand	23
ds	Change in inventor stocks	23
$*p^x$	Price of domestic production	23
p^m	Price of domestic production	23
$*p^h$	Price of domestic absorption	23
$*p^e$	Price of exports	23
THE I/O MATRIX		
$*Q_{m,i}^v$	Aggregate input coefficient m in vintage v in manufacturing ² branches i	m=5, i=14
$*\bar{x}_i^v$	Production capacity in vintage v in manufacturing branches i	i=14, v=20
$*d_i^v$	Rate of scrapping in vintage v in branch i	i=14, v=20
$*ur$	Capacity utilization ratio	23
$*q_{j,i}^f$	Fuel input coefficients in business sector	i=23, j=2

Symbol	Meaning	Dimension
INVESTMENTS IN THE BUSINESS SECTOR		
(*)g	Gross investments in the business sector	23
*ep	"Excess profits" in manufacturing sector	14
*va	Value added at factor cost	23
*p ^k	Cost of capital in manufacturing sector	
r _w	External rate of interest	1
FOREIGN TRADE		
p ^w	World market prices in foreign currency	23
θ	Exchange rate	1
wm	World market volume index	23
*p ^{xh}	Domestic producers' prices on domestic markets	23
DISPOSABLE INCOME AND CONSUMPTION EXPENDITURES IN HOUSEHOLD SECTOR		
*y ₁₁	Total wages	1
*cpi	Consumption price index	1
*besk	Taxable household income	1
*utd	Local tax rate	1
*p ^c	Household consumption purposes	14

Symbol	Meaning	Dimension
GOVERNMENT SECTOR (s=central, l=local)		
(*) x_s, x_l	Production	7
(*) cs, cl	Consumption	7
(*) fs, fl	Demand for commodities from business sector	23
(*) i_s, i_l	Gross investments	1
STOCK BUILDING		
ds_a	Change in total stocks	1
s_a	Total stock demand	1
PRICES		
* uc	Average costs incl ca- pital cost	23
* p^x	Price of domestic pro- duction	23
* p^e	Price of exports	23
* p^{xh}	Domestic producers' prices on domestic markets	23
* p^h	Price of domestic absorption	23
p^w	World market prices in foreign currency	23
p^m	Price of imports	23

Symbol	Meaning	Dimension
WAGES AND EMPLOYMENT		
\dot{w}_0	Wage rate increase	1
w	Wage rates in business sector	23
w^s, w^l	Wage rates in central (s) and local (l) government sector	7
(w^P)	$w^P = [w^s, w^l]$	
λ	Employment in business sector	23
$(*) \lambda^s, \lambda^l$	Employment in central (s) and local (l) government sector	17
u	Unemployment rate	1
Π^m	Gross profit share of value added in manufacturing sector	1

NOTES

¹ Endogenous variables are marked by *. Paranthesis denote that only part of the vector or matrix is endogenous.

² There are 14 branches in the manufacturing subsector of the business sectopr (cf Section 4.1).

REFERENCES

- Barker, T.S. (ed.): Economic Structure and Policy. London, 1976.
- Bentzel, R., A Vintage Model of Swedish Economic Growth from 1879 to 1975. Fifth World Congress of the International Economic Association, Tokyo, 1977.
- Bergman, L., ELIAS - A Model of Multisectoral Economic Growth in a Small Open Economy, Working Paper No. 81, IUI, 1983.
- Bergström, V., "Approaches to the Theory of Capital Cost", Scandinavian Journal of Economics, No. 78, pp. 437-456, 1976.
- Bergström, V., and H. Melander, "Production Functions and Factor Demand Functions in Postwar Swedish Industry", Scandinavian Journal of Economics, Vol. 81, No. 4, pp. 534-551, 1979.
- Berndt, E.R. and D.O. Wood, "Technology, Prices and the Derived Demand for Energy", Review of Economics and Statistics, August, Vol. 57, No. 2, pp. 259-268, 1975.
- Berndt, E.R., M.A. Fuss and L. Waverman, A Dynamic Model of Costs of Adjustment and Interrelated Factor Demands. With an Empirical Application to Energy Demand in U.S. Manufacturing, Working Paper No. 7925, Institute for Policy Analysis, University of Toronto, Toronto, Canada, November, 1979.
- Berndt, E.R. and M.S. Khaled, "Parameter Productivity Measurement and Choice Among Flexible Functional Forms", Journal of Political Economics, Vol. 81, No. 6, pp. 1220-1245, 1979.

- Blackaby, C. - Primont, D. - Russel, R.R., "Budgeting, Decentralization and Aggregation", Annals of Economic and Social Measurement Vol. 4, 1975.
- Blackaby, C. - Primont, D. - Russel, R.R., Duality, Separability and Functional Structure: Theory and Economic Applications, North-Holland, New York, 1978.
- Bliss, C.J., Capital Theory and the Distribution of Income. North-Holland, Amsterdam, 1975.
- Calmfors, L. - Herin, J., "Domestic and Foreign Price Influences: A Disaggregated Study of Sweden"; Inflation and Employment in Open Economies (se nedan)
- Carling, A., Dargay, J., Dettinger, C. och Sohlman, Å., Energipolitikens Effekter inom Industrin, Forskningsgruppen för Energisystemstudier, FFE-Rapport nr 8, Stockholm, 1978.
- Dargay, J., The Demand for Energy in Swedish Manufacturing, Working Paper No. 33, IUI.
- Dargay, J., Energy Usage and Energy Prices in Swedish Manufacturing, Working Paper No. 80, IUI, 1983.
- Dargay, J. - Lundin, A., Hushållens Energiefterfrågan - Empiriska Studier för Sverige, Forskningsgruppen för energisystemstudier, FFE-rapport nr 14, Stockholm, 1978.
- Eckstein, O. - Fromm G., "The Price Equation" The American Economic Review, Vol. 58, No. 5, 1968.
- Eliasson, G. - Sharefkin, M. - Ysander, B.-C., (eds.), Policy Making in a Disorderly World Economy, IUI, 1983.

- Energy Policy Modeling: United States and Canadian Experiences. Specialized Energy Policy Models, Volume I (ed. Ziemba, W.T. - Schwartz, S.L. - Koenigsberg, E.), Martinus Nijhoff Publishing, 1981.
- Fuss, M. and D. McFadden, eds., Production Economics: A Dual Approach to Theory and Applications, Vol. 1 and 2, North Holland, Amsterdam, Netherlands, 1978.
- Hickman, B.G. - Coen, R.M., An Annual Growth Model of the U.S. Economy, North-Holland, 1976.
- Inflation and Employment in Open Economies, (ed. Lindbeck, A.), North-Holland, 1979.
- IUI:s Långtidsbedömning 1976. Bilagor, (The 1976 Medium Term Survey from the Industrial Institute for Social and Economic Research). Uppsala 1977.
- Iwai, K., Disequilibrium Dynamics - A Theoretical Analysis of Inflation and Unemployment, Cowles Foundation, Monograph 27, Yale University Press, 1981.
- Jansson, L.: A Vintage Model of the Iron and Steel Industry, Working Paper No. 41, IUI 1981.
- Jansson, L., The Wage Equation of the ISAC Model. Mimeo, IUI 1982.
- Kalkyler för 80-talet. Specialstudier för IUI:s Långtidsbedömning 1979. Del 2, (Calculations for the Eighties. Special Studies for the 1979 Medium Term Survey from the Industrial Institute for Social and Economic Research). Stockholm 1979.
- Modeling and Measuring Nature Resource Substitution (ed. Berndt, E.R. - Field, B.C.), MIT Press, 1981.
- Morishima, M. - Murata, Y. - Nosse, T. - Saito, M., The Working of Econometric Models, Cambridge University Press, 1972.

- Nordström, T. and Ysander, B.-C.; Local Authorities, Economic Stability and the Efficiency of Fiscal Policy. Some Experimental Simulations for Sweden in the Eighties. Working Paper No. 44, IUI 1981.
- Nordström, T. and Ysander, B.-C., Oil Prices and Economic Stability: Simulation Experiments with a Macroeconomic Model, Working Paper No. 82, IUI 1983.
- Okun, A.M., Prices and Quantities, Blackwell, Oxford, 1981.
- Pindyck, R.S., "Interfuel Substitution and the Industrial Demand for Energy: An International Comparison", The Review of Economic and Statistics, May, Vol. LXI, No. 2, pp. 169-179, 1979.
- Stabilization Policies in Interdependent Economies (ed. Claessen, E. - Salin, P.), North-Holland, 1972.
- Södersten, B., Internationell Ekonomi, Rabén & Sjögren, 1969.
- Theil, H., Theory and Measurement of Consumer Demand, Volume 1, North-Holland, 1975.
- The Medium Term - Models of the British Economy (ed. Worswick, G.D.N - Blackaby, F.T.), London, 1974.
- Wells, C., Optimal Fiscal and Monetary Policy - Experiments with an Econometric Model of Sweden, Gleerup, 1978.
- Ysander, B.-C.: An Econometric Model of Local Government Budgeting, Working Paper No. 43, IUI, 1981.
- Östblom, G., Energianvändningen i Sverige 1965-1978, Forskningsgruppen för energisystemstudier, FFE Rapport nr 4, 1980.