

Nordström, Tomas; Ysander, Bengt-Christer

Working Paper

Oil Prices and Economic Stability Simulation Experiments with a Macroeconomic Model

IUI Working Paper, No. 82

Provided in Cooperation with:

Research Institute of Industrial Economics (IFN), Stockholm

Suggested Citation: Nordström, Tomas; Ysander, Bengt-Christer (1983) : Oil Prices and Economic Stability  Simulation Experiments with a Macroeconomic Model, IUI Working Paper, No. 82, The Research Institute of Industrial Economics (IUI), Stockholm

This Version is available at:

<https://hdl.handle.net/10419/94938>

Standard-Nutzungsbedingungen:

Die Dokumente auf EconStor dürfen zu eigenen wissenschaftlichen Zwecken und zum Privatgebrauch gespeichert und kopiert werden.

Sie dürfen die Dokumente nicht für öffentliche oder kommerzielle Zwecke vervielfältigen, öffentlich ausstellen, öffentlich zugänglich machen, vertreiben oder anderweitig nutzen.

Sofern die Verfasser die Dokumente unter Open-Content-Lizenzen (insbesondere CC-Lizenzen) zur Verfügung gestellt haben sollten, gelten abweichend von diesen Nutzungsbedingungen die in der dort genannten Lizenz gewährten Nutzungsrechte.

Terms of use:

Documents in EconStor may be saved and copied for your personal and scholarly purposes.

You are not to copy documents for public or commercial purposes, to exhibit the documents publicly, to make them publicly available on the internet, or to distribute or otherwise use the documents in public.

If the documents have been made available under an Open Content Licence (especially Creative Commons Licences), you may exercise further usage rights as specified in the indicated licence.

A list of Working Papers on
the last pages

No. 82

OIL PRICES AND ECONOMIC STABILITY
- SIMULATION EXPERIMENTS
WITH A MACROECONOMIC MODEL

by

Tomas Nordström
and Bengt-Christer Ysander

This is a preliminary paper. It is intended for private circulation, and should not be quoted or referred to in publications without permission of the authors. Comments are welcome.

CONTENTS	Page	
1	THE PROBLEM OF ENERGY POLICY	3
	The Instability of Oil Prices	3
	Tracing the Impact of an Oil Price Hike	5
	Policies to Counter Instability	8
2	THE MACROECONOMIC FRAMEWORK	13
	The Macro Model	14
	Prices and Wages	21
3	THE ENERGY SYSTEM 1980-2000	24
	Energy Supply and Energy Prices	24
	Energy Demand	29
	Total Energy Use and Aggregate Substitution	40
4	THE SIMULATION DESIGN	46
	Economic Developments	
	in the Eighties and Nineties	46
	Stagnating Oil Prices	51
	Simulation Experiments	54
5	THE IMPACT OF AN OIL PRICE SHOCK	58
	Impact Without World Market Repercussions	58
	Impact of World Market Repercussions	62
	Stabilization Policies	67
	Effects of Policy Restrictions	74
6	THE USE OF AN OIL TAX AS INSURANCE	80
	The Cost of an oil Tax	82
	Effects of an Oil Tax Compared to	
	an Import Price Increase	88
	The Benefits of an Oil Tax	90
7	CONCLUSIONS	95
	REFERENCES	97

1 THE PROBLEM OF ENERGY POLICY

The need for a national energy policy, for government interfering with the supply and demand of energy, is - at least in the case of Sweden - mainly due to the instability of the oil prices. A primary task of economic analysis is therefore to trace the impact of changing oil prices on the national economy. The major challenge of national energy policy is to devise ways of reducing or accomodating this instability and uncertainty of oil prices.

These are bold, and undoubtedly oversimplified statements. Let us try to develop and clarify the reasoning behind them, introducing at the same time the aim and methodological approach of the present study.¹

The Instability of Oil Prices

The real price of oil declined steadily from the end of the war up to 1970. At the same time the advances in nuclear technology opened up prospects of an inexhaustable source of cheap electricity. Aside from partnering and monitoring the ventures in nuclear technology - and controlling the exploitation of natural energy resources - the national governments had little cause for intervening in the energy markets.

All this changed in the early 70s. The oil price hike in 1973 - compounded by rising costs and safety concerns for nuclear power - brought home the lesson that cheap energy and stable energy prices could no longer be taken for granted. Since then real oil prices have been fluctuating widely with a new all time record in 79-80 and a slump in 1983. The detailed story of what happened in '73, how the initial price rise on the Rotterdam spot market, due mainly to the Suez embargo, was translated into a

¹ For a short resume of study results cf. Ysander, 1983.

huge permanent rise of contract prices, still remains controversial. We do not know for sure the relative importance of the raw material boom, of the OPEC-cartel and the seven sisters, of strategies aiming at transferring money and of policies for strategic control.

What we do know is that conditions in the international oil market have changed radically with respect to price stability. To a large extent it seems to be a case of uncertainty breeding on uncertainty. A tendency towards a shortening of contract times, a convergence of contract prices, an increased sensitivity for changes in spot prices and a growing propensity to inventory speculation, all contribute to this impression. This inherent market instability is accentuated by the political instabilities of some oil-producing countries creating risks of major supply disturbances. It is further boosted by the tendency of cartel prices to "overshoot", setting off cyclical changes in world economic activity and energy demand.

The volume of existing forward oil markets in London and New York is still far too small to contribute in any substantial way to a stabilization of oil prices. The buying and selling of future contracts could not be expected anyhow to cope with the price instabilities arising from major supply disruptions. Nor has the oil-saving efforts of the industrialized countries necessarily made these countries less vulnerable to supply disruptions, less insensitive to price in precarious situations.

There are thus many reasons to assume that the international oil market will remain instable also during the coming decade. In the long run, extending the horizon to the turn of the century, real oil prices will be determined by the marginal costs of producing oil from secondary deposits, and will therefore undoubtedly tend to rise. In the meantime we may however reasonably expect wide and sometimes abrupt fluctuations. As a representative although somewhat extreme, example of these possible price changes, we have in the following simulation study chosen to focus at-

tention on an abrupt 60 percent oil price hike, occurring in 1991 after several years of relatively stable price developments. We can thus be said to project into the future a renewal of the '73 experience.

We have not found it necessary to look as closely at the possibility of a major sharp price decline. There are very obvious asymmetries between the case of a price hike and that of a correspondingly large price decline. The impact on the international markets of a price decline will primarily be connected with the liquidity and solvency problems of some less developed oil producing countries and by certain general "withdrawal symptoms" in the international monetary system. We have little of empirical evidence from which to make concrete projections for this case, but the little we have seems to indicate that - assuming a responsible monetary management - the expansion of the "winners" would tend to outweigh the contraction of the losers in regard to world trade.

The asymmetry becomes even more pronounced when we turn to the direct impact on the Swedish economy. In as far as a dominant part of the policy issues raised by an oil price hike is concerned with containing and controlling the inflation and the deficit problems, there are simply no corresponding problems in the case with a price decline. The major task of the government in such a case would be to try to stop individual investors from misinterpreting the temporary low prices and from going on an energy spending spree.

Tracing the Impact of an Oil Price Hike

In analyzing the impact of an oil price hike we have worked with several alternative assumptions as to the world economic environment. As for oil price development, apart from the possible price hike, we have used both a slowly rising real price trend and a stagnating one. In modeling the repercussions of the price hike on the international markets, we have drawn both on the expe-

rience of the 70s and on experiments performed with the LINK model (Sarma, 1983). A shortlived boom in raw material is supposed to be followed by several years of slowed-up growth in world trade. By measuring the impact on the Swedish economy with and without international repercussions we can at least exemplify the possible relative importance of the world market disturbances - the indirect effects.

When it comes to analyzing the direct effects of oil price changes, there is one major question which confronts you right from the start. Is it the new high level of oil price which is the main perceived threat or is it the abrupt and unexpected way it jumps up? The general experience of the two price hikes in the 70s seems to point to the latter.¹ In particular much of Sweden's present difficulties, manifested by a mounting deficit both in public budgets and in external exchange and by a shrinking and underutilized export industry, can be viewed as arising out of a failure to cope with the stabilization problems caused by the oil price hikes (Eliasson, Sharefkin, Ysander, 1983). As we shall see later this intuition is confirmed by comparing, in the simulations the impact of a sudden oil price hike with that of a gradual and anticipated increase of oil prices over the entire 80s.

If macroeconomic stabilization is the main worry, then the stabilization policies pursued - or not pursued - will obviously be of decisive importance for the final outcome.² In the simulation we have worked with three different policy instruments: Wage, tax and public consumption policies. We have not included an active exchange policy among our policy instruments since it appears in the model to be a substitute rather than a complement to wage policy.

¹ Comparisons made between the effects of gradual vs abrupt oil price increases in e.g. Jacobson and Thurman, 1981, also lend support to this interpretation.

² The theoretical analysis by i.a. Svenson, 1981, and the simulation experiments by J.D. Sachs reported in Bhandari and Putnam, 1982, exemplify studies that instead focus on intertemporal welfare and balance-of-payment effects.

What we then first do is to model and measure two "extreme" alternative outcomes. In the one case no policy changes are made after the "oil crises", which means that inflation will slowly be forced down by unemployment, while the foreign debt continues to cumulate. The welfare implications of this "worst case" is then compared with a "best case", where an optimal employment of available policy instruments contains the crises and restores balance in external payments and in the labor market within three years.¹

The impact problem is thus narrowed down to a question about how probable it is that we will in fact be able to cope adequately with the stabilization problems.

In the following simulations we have tried to use as "substitute measures" for this probability - or rather for its inverse - the development of real wage, employment and public consumption required by the stabilization program and interpretable as symptoms of the concomitant political strains.

The chances of coping will be diminished if further restrictions - due e.g. to binding promises to various voter groups - are placed on the available policy instruments. If the central government has its hands tied by political commitments to groups of consumers and wage earners, this will in general increase the amplitude of the policy changes needed and with that the "political strains", or the improbability of coping effectively with the crises. In the simulations we have in this fashion successively climbed down a ladder of political feasibility, placing restrictions on wage policy, on public consumption and finally on tax policy. The relative outcome of these experiments demonstrates how limited flexibili-

¹ The optimal choice of instruments in this case turns out to be wage policy and tax policy, which are rather complementary in respect to the two targets. With two targets and with two instruments changed in a linear fashion, the policy solution moreover turns out to be unique or nearly so. We thus avoid the choice between alternative stabilization policies (cf. Gramlich, 1979 for a discussion of the dimensions and issues of that choice).

ty in fiscal and budgeting policy may affect and inflate the impact problem.

In thus modeling the impact of an oil price hike we are however exemplifying only some special cases. We only treat one major price upheaval, not the prospect of general price instability. Moreover the model does not take into explicit account the ways in which anticipated future instability modifies current behavior. The investors in the model e.g. are assumed to have simple adaptive price expectations, which means that the risk and uncertainty surrounding future oil prices are not to any substantial extent foreshadowed in their current investment plans. Our experiments really deal only with the rather special case where a period of stable prices have effectively lulled all anxieties so that the oil price hike takes everybody with complete surprise.

Policies to Counter Instability

If instability of oil prices is the major problem, it then follows that the main thrust of energy policy must be directed towards countering the effects of that instability - always assuming that a small country like Sweden cannot hope alone to modify the behavior of the international oil market. Such an energy policy can aim at reducing the total risk involved as well as pooling the risk for individual risk-bearers.

These aims are of course already reflected in today's energy policy in Sweden. By taxing energy and by subsidizing oil-saving investments and development costs we both encourage total oil saving and redistribute some risks - mainly the risk of cheap future oil - among the taxpayers. Both the consistency and the efficiency of these policies may however be questioned. The level of energy taxes often seems more determined by fiscal considerations than by long-term aims of energy price stabilization. Investment subsidies may be an unprofitable way of hedging against possible oil price slumps and moreover often requires decisions on choice

of technique and fuel, that should rather be left to decentralized decision-makers in the market.

The question might reasonably be raised, why central government should interfere at all with the market and its agents by way of energy policy. Leaving aside those arguments for state support of technological development and infra-structure investments which are not specific for energy investments, a first line of approach stresses asymmetries in information. Putting it crudely - the central government may know better, may have more foresight, have longer horizon and may be more expertly staffed than the individual agents in the economy. The "track record" of central government forecasting and action in the energy field may not be particularly convincing compared with that of big companies, but it could still be the case that e.g. households and local governments tend to be even more biased or myopic. The Swedish experience over the last decade seems indeed to indicate that local governments sometimes need central guidelines to venture into new areas of energy opportunities.

Even if we leave out informational asymmetries there are some rather solid reasons for central government to aid in stabilizing energy prices. Let us just mention two. The first is a simple risk-pooling argument. The oil price risks are now very unevenly distributed in the economy. Some investors e.g. in oil substitutes stand to lose considerably in the event of an oil price slump - which may contribute to dwindling investments - while the opposite is true of heavy oil users and their customers etc. Given a certain common degree of relative risk-aversion the economy as a whole stands to gain by having some kind of risk-pooling installed.¹ The second kind of argument is one that will be underlined by our results in the following. If oil saving not only pays for the individual, but also helps the total economy by easing the sta-

¹ For a thorough development of this argument within the context of Neumann - Morgenstern utility theory cf. Hey, 1981 and Borch, 1968. The general conclusion could also be derived from alternative approaches to decision under uncertainty (cf. e.g. Kahneman - Tversky, 1979, Simon, 1978, Shackle, 1979.)

bilization strains, then these "external effects" of the saving efforts should somehow be signalled by the government.

In the present Swedish context this latter line of reasoning could be further pursued. A "tariff" on imported oil implies - at least in the short run - a certain terms-of-trade gain, which will be larger the more price sensitive Swedish oil consumers are and the less price sensitive our foreign customers are. In as far as we must adhere to a very hard-fisted domestic demand policy over the next few years in order to support an export-offensive, a "forced" oil saving may help in easing this adjustment.

One way for central government to counter the adverse effects of oil price instability and uncertainty would be to guarantee a certain domestic oil price development - within suitable margins - over the next decade, and adjust oil taxes - or subsidies as the case may be - accordingly. The guaranteed price path could e.g. be such, that the expected value of the guarantee was equal to nil and the guaranteed price at the turn of the century - or the projected extension of the guarantee to that year - equalled the expected international market price. There are several possible time profiles of guaranteed price that could meet with these requirements. If we expect the 80s to become the lean years for domestic consumption, but hope to be able to raise living standards during the 90s, we could utilize the terms-of-trade gains from a rising oil tax during the present decade, while allowing tax levels to go down - if no oil crises occurs - in the 90s. Since such a "price umbrella" would automatically shelter the development and use of oil substitutes and of oil-saving devices there should be room for considerable cuts in current energy subsidy schemes.

One way of looking at the price guarantee is as an offer to domestic customers of favorable forward contracts - hedging price hike risks. At the same time there would be a hedge against the risk of price slumps, since the forward contracting is, as it were, obligatory and spot operations are made unprofitable. The govern-

ment may to a certain extent reinsure itself by operations on the international forward markets and by long-term contracting.¹

The exact terms of the guarantee could be phrased in several ways. They could e.g. be limited to maximizing the annual percentage change in real prices, be confined by the amount of tax in the domestic price and/or be such as to leave domestic oil prices free to fluctuate within a $\pm 10\%$ of a preset price path.

The experiments we have performed with the model are necessarily simplified and stylized compared with such flexible schemes. Just as we confine our study to one singular price hike in '91 we also focus our interest on a rather special form of tax scheme. We add a cumulative oil tax during the eighties, so that by '91 - if the oil crises occurs - we can just off-set the price hike by lifting off all tax. If there is no price hike we can alternatively keep the tax level unchanged or reduce it successively so as to stabilize or lower oil prices in the 90s.² This kind of experiment certainly cannot tell us the whole story. What it does is to provide an insight into the costs and benefits of a price guarantee in a specific but still representative case.

¹ The hedging argument could also be couched in terms of transaction costs. To insure against all kinds of price risks involved for substitutes and complement commodities would require a quite extensive network of future markets. Even if such a "free market alternative" were available it could be profitable to save transaction costs by a common oil price guarantee.

² The crises scenario we have chosen to treat could be regarded as a "maximal perceived threat". Particularly we assume that no retrenchment of real oil prices from the high level attained in 1991 has yet occurred by the year 2000. Any downward adjustment towards a slowly rising long term equilibrium price is thus postponed till after the turn of the century. This does in fact tally reasonably well with our overall experience for the nine years 1973-82, but also means that the impact measured includes effects of a raised price level during the 90s, as well as consequences of unexpected fluctuations.

Our model experiments labor under another, and perhaps more serious handicap, when it comes to illustrate the possibilities of stabilizing domestic oil prices. Since, as we underlined above, price expectations in the model are formed in a simple adaptive way we do not catch the probably very important expansive effects of limiting price uncertainty for the economic agents. On the other hand we probably tend for the same reason to overestimate the amount of misdirected choices of technique and investments that unstable price trends and market signals would call forth. We may therefore end up by slightly overestimating both costs and benefits of the price stabilization schemes. Although we have no firm evidence to quote in support, we tend to think that in the final balance this model handicap will mean that our results understates the case for oil price stabilization.

2 THE MACROECONOMIC FRAMEWORK

To evaluate the economic effects of different oil price developments and oil tax policies we have used a fairly disaggregated growth model for the Swedish economy.¹ The ISAC-model, which will be briefly described in the next section, was originally built for medium and long term analysis. For the simulations discussed in this report, however, some short run dynamics - primarily related to wage and price formation - was added to account for the immediate impact of sudden external price hikes.

Also a submodel for energy supply and demand, was added to ISAC. However, in order to keep down total model size only those parts of the energy system essential to our main interest - primarily industrial demand of energy - were treated extensively. Thus energy demand for house heating as well as for transport was dealt with in an aggregate and simplified way. On the supply side, production of primary as well as secondary (refined) energy is again rather crudely modelled.

Finally, to account quantitatively for the impact of world events and the effects of different policy measures, one needs also a "zero point" or reference simulation as a measuring rod. Levels of future economic variables are undoubtedly more uncertain than differences between levels. This does not imply, however, that absolute levels are unimportant and that a reference case could be chosen at random. One important example of this in the simulations reported here, is the restriction on future nuclear power capacity in Sweden. In a slow growing economy this may be of

¹ The ISAC-model, Industrial Structure and Capital Growth, has been developed at the Industrial Institute for Economic and Social Research by the authors together with Leif Jansson. ISAC has been used in the Institute's medium term surveys and will partly be integrated into the system of models for medium and long term analysis used at the Ministry of Economics. The model is described in Jansson, L. - Nordström, T. - Ysander, B.-C., (1982).

little importance, while a fast growing energy demand will call for compensating energy sources. A reasonably designed reference point for the simulations may also convey important information by itself.

The Macro Model

The model used for the simulation experiments is fairly large. A comprehensive account of the model is given in Jansson, Nordström, Ysander, (1982). The purpose of this section is to describe its main structure and dynamic properties.

Figure 2.1 is an attempt to illustrate the overall structure of ISAC. The figure shows the main variables and submodels and their inter-relations. The block diagram is built around a multisectoral balance for the economy which assures that supply equals demand. The exogenous determinants of the developments of the model economy can be divided into two sets. The first set of variables are external to the economy in the sense that neither the development of the economy nor political decision-making exerts any influence on them. These variables, marked by single-squares in the figure, are world markets (prices and trade volumes), disembodied technical change, labor supply and, finally, a rate of interest that is assumed to be imposed on the economy from abroad.

The other set of exogenous variables is made up of policy instruments, indicated by rhombs. They are the exchange rate, central government consumption and various kinds of fiscal parameters affecting the household sector through taxes and transfers and also acting on the local government sector through i.a. the grant system.

Finally there is a policy instrument influencing the long run wage rate although not controlling short run fluctuations.

Figure 2.1 The structure of the ISAC model 1983

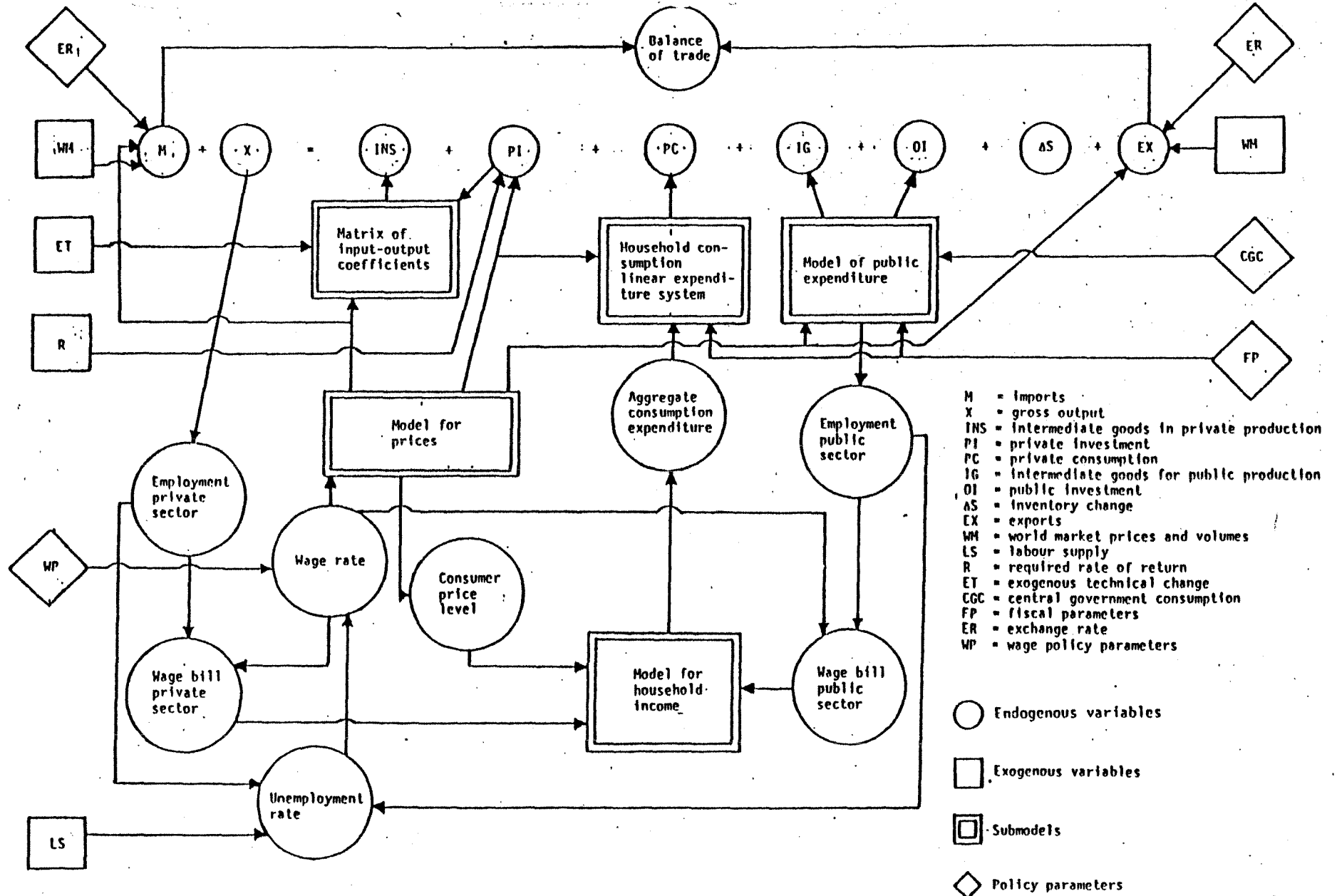

Given these two sets of exogenous variables every item of the sector balance will be determined. The demand for intermediary goods in industry (INS) is given by current production (X) and the matrix of input-output coefficients. The model allows for substitution between energy, capital and labor in production processes. The rest of the i/o-matrix is constant over time.

Investments in industry (PI) are determined by profit expectations as well as by current capacity utilization. Real capital is described by vintages with different technical properties. Through the vintage mechanism the volume of investment will affect average capital- and labor-productivity. Productivity growth also depends on the rate of scrapping of old vintages which is assumed proportional to the quasi-rents earned in each vintage. So far the vintage approach has only been implemented for branches in the manufacturing sector while capital in other branches is treated as homogenous in each branch. In the same way investment functions are specified and estimated only for manufacturing branches but elsewhere determined either as an exogenous trend or as related to production in some simple manner.

Private consumption (PC) is determined by a rather detailed specification of income and expenditure in the household sector. The main source of gross income is wages and salaries from industry, thus providing the multiplier link shown in Figure 2.2 between the activity level in the economy and private consumption expenditures. An exogenous change in fiscal parameters (FP), e.g. a reduced income tax rate, will increase household income. Since the savings ratio is exogenous, most of the tax reduction will be translated into consumption expenditure, thus increasing demand for commodities. Some of these will be imported, but domestic production and employment will increase, creating more wage income and so on.

The size of the multiplier can also be affected by the wage inflation resulting from a higher activity level in the economy. This mechanism, which is not shown in Figure 2.2, will on the

Figure 2.2 The production-consumption loop

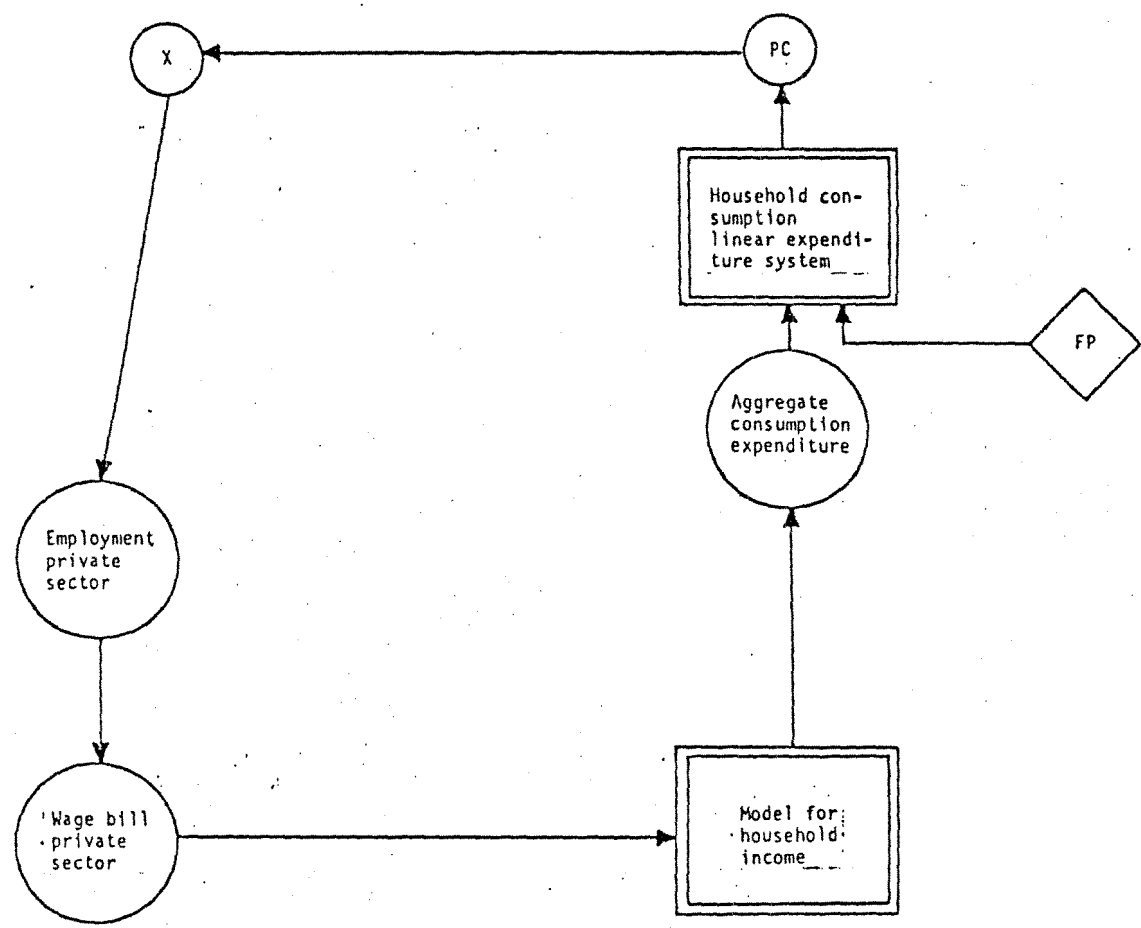

one hand, positively affect total wage income through higher wage rates. On the other hand, it will also limit the real multiplier effect by deflating nominal income through higher inflation, and still further through increased imports and reduced exports following the rise in the domestic price level. The net real effect of these secondary mechanisms after 2-3 years may be positive or negative depending i.a. on the price elasticities in foreign trade and on the sensitivity of wages to increased pressure in the labor market. Other important sources of household income are wages, salaries and transfers from the public sector. After deduction of various taxes households are left with disposable income. Real consumption expenditure is distributed between fourteen consumption categories by a linear expenditure system. The feed-back mechanism between the production system and consumption demand through the household sector explains much of the model's short term response to an exogenous disturbance, whether in the form of e.g. a change in world market growth or through a change in some fiscal measure towards the household sector.

Public sector demand for intermediary and investment goods (IG, OI) is partly a policy variable (central government), partly endogenous (local government). The local government model, as it is presently implemented, tends to produce fairly strong oscillations in the economy through its interactions with the labor market on the one hand and the household sector (via the endogenous local tax rate) on the other. These links are shown in Figure 2.3.

Suppose central government increases the categorical grants to local governments, in the figure indicated by a change in fiscal parameters (FP). The immediate impact will be to decrease local governments' net costs of production and hence induce them to step up real expenditures. The grants will also improve their financial situation making tax increases unnecessary. Since no other fiscal measures are assumed, i.e. the original grants increase is not financed by increased taxes from central government,

Figure 2.3 The local consumption - labor market loop

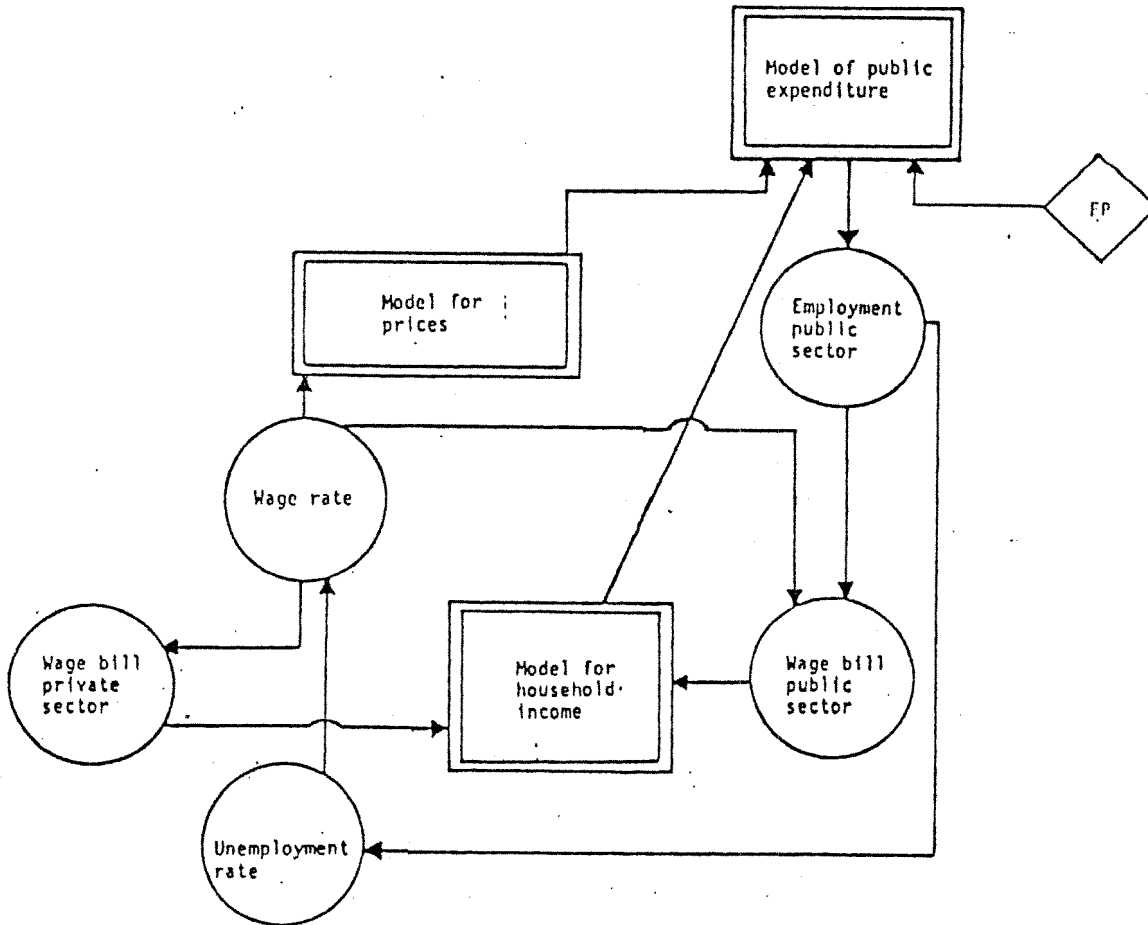

the activity level in the economy will go up and so will employment. The resulting wage inflation will partly "finance" the local government expenditure increase by eroding household income and by worsening the external balance. But the wage increase will also lead to increased net costs of production for local governments and slow down their expansion. However, because of the two year lag in the disbursement of centrally collected local tax-income, the financial situation of local governments will tend to improve again later when wages are moderate as a consequence of weak demand. Thus, with a two year lag, the inflated household income will feed back to local governments, acting as a stimulus to increased expenditures.

Some explorative experiments have been carried out with this sub-model (Nordström-Ysander, 1981). The simulations in this study still work, however, with the assumption of exogenous local governments.

Changes in stocks (ΔS) are modeled in a very simple fashion with total stocks in the economy being set in proportion to production in some "stockholding" branches. Mostly, however, the model is run with exogenous stock investments.

Finally the sector balance for industry includes imports and exports (M, EX). These are, of course, of great importance considering the large export- and import-shares, especially for manufacturing branches, in the Swedish economy. We assume that price differentials between imported and domestically produced goods can persist over long periods, and also that Swedish exporters are not necessarily price-takers on the world market.¹ One implication of these assumptions is that imports and exports will depend on relative prices and that domestic producers can price themselves out of domestic as well as foreign markets - as indeed they did in the middle of the seventies.

¹ The rationale for these assumptions are discussed in Jansson, L. - Nordström, T. - Ysander, B.-C., (1982).

Used together with the wage equation, the foreign trade functions introduce a mechanism, indicated in Figure 2.4, that tends to dampen the effects of world market disturbances. The immediate impact of a general world market price increase, for example, will be higher domestic inflation through imports and a pressure on the labor market due to improved relative prices and to an induced increase of net demand from abroad. This will, however, create both inflation expectations and wage drift in the labor market, then pushing up wages. The higher wages will not only remove pressures on the labor market, but will also reduce the initial surplus on foreign account.

Prices and Wages

Obviously price and wage formation play an important role for the solution of the model. Prices are based on average rather than marginal costs. Unit cost is taken to include "normal" profits, i.e., the mark-up over average operating costs is equal to average capital cost share. Theoretically this kind of pricing can be underpinned by assuming market imperfections and adjustment costs. It also seems to be well in accordance with observed behavior.

For a small country, however, with large export shares one would not expect producers to just pass on their costs to the world market without regard to competitors' prices. The price equations in ISAC also allow for an influence from price competition being specified as a geometric average of unit cost and world market price (in Swedish currency):

$$P \sim c^\alpha \cdot PW^{(1-\alpha)} \quad \text{or} \quad \dot{P} = \alpha \cdot \dot{c} + (1-\alpha) \cdot \dot{PW}$$

where dotted variables are growth rates. The size of the parameter α is of crucial importance. α equal to unity implies pure mark-up pricing with strong effects on foreign market shares from

Figure 2.4 The foreign trade-labor market loop

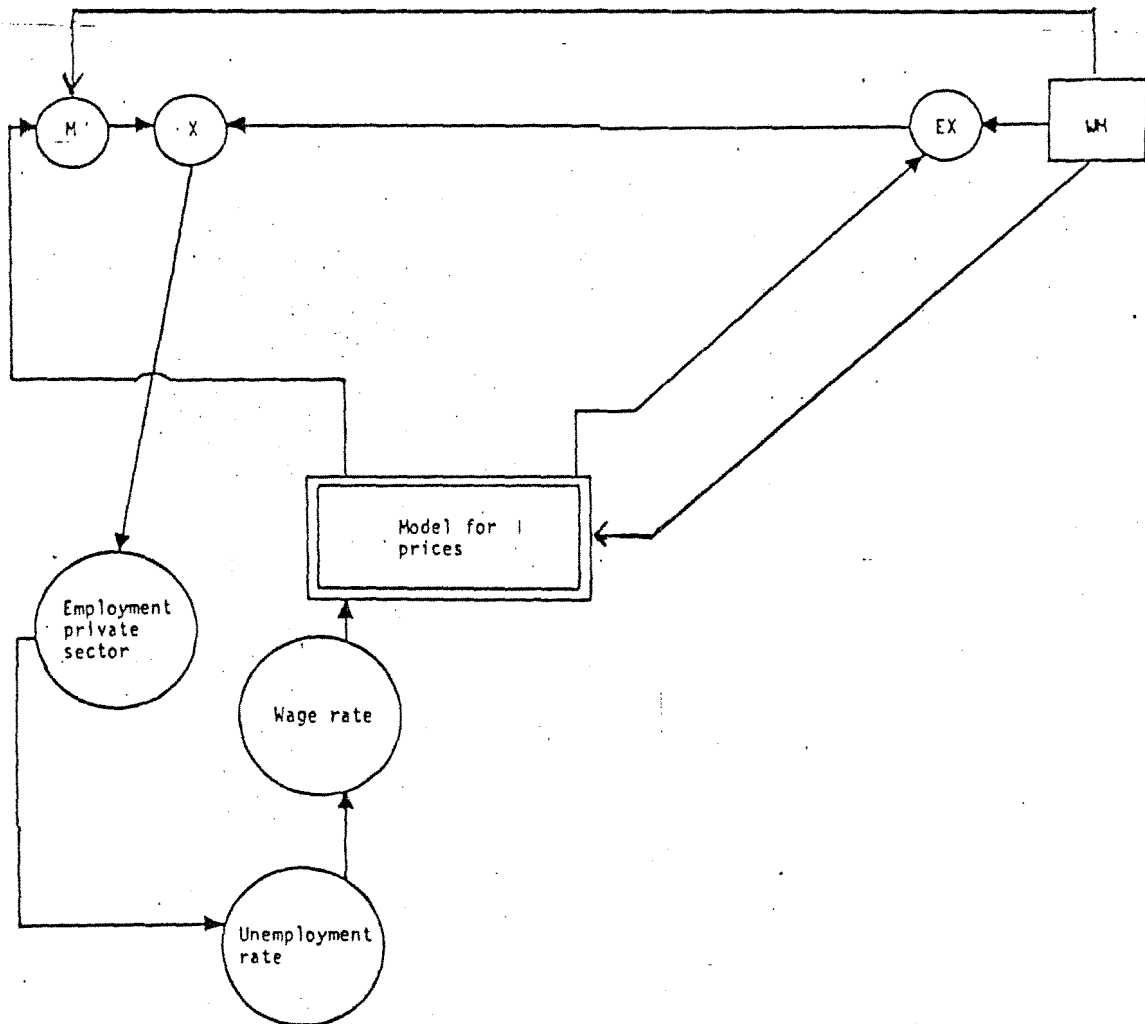

domestic cost inflation. With α equal to zero, producers are, on the other hand, assumed to follow world market prices. In this case exports will always grow with world trade while domestic wage inflation will cut down profit shares.

In the discussion above, costs were treated as unaffected by the world price increase. But price increases abroad will of course influence domestic inflation. One way this will be done is through imported goods. Another is through price increases by domestic producers, taking the opportunity to raise their profit margins.

The model economy, however, also includes an internal source of inflation with a kind of expectations augmented Phillip's curve. The overall wage rate growth is explained by last year's consumer price growth, current rate of unemployment, profit levels and finally productivity growth.

Phillip's curves can be specified, and justified, in a great many ways. Two features of this particular specification should be noted, since they are important to the model behavior. The first one is the rather unsophisticated formation of expectations that is assumed. The one year lagged consumer price variable could also be thought of as a compensatory mechanism for past inflation, especially since the estimated parameter did not differ significantly from unity. The second noteworthy characteristic of the chosen wage equation is the absence of lags in the unemployment variable.¹ These two properties both contribute to make wages sensitive to inflationary pressures. They thus confer a certain stability to the economy, making e.g. the domestic repercussions of external inflationary shocks fade away in a rather short period.

¹ Various lags were tried when estimating the equation, cf. Jansson, L: "The Wage Equation in the ISAC Model", Mimeo, IUI, 1981.

3 THE ENERGY SYSTEM 1980-2000

The ISAC model was originally not designed for energy analysis. In order to carry out the simulations described in this report, energy flows was built into its i/o-structure. Efforts was also made to estimate energy demand functions mainly in the manufacturing and household sectors. As already noted above the supply side and demand from other sectors were dealt with in a more aggregate and simplified way. No vintage structure has been implemented for energy sensitive consumption capital like houses or cars. In some instances we could only "estimate" the required energy demand function by calibration i.e. by comparison with other projections. We do believe, however, that the structure of the energy submodel gives a fair representation of the basic mechanisms and problems in Sweden's energy situation and that the estimated relations are robust enough to reflect accurately, if not exactly, our energy policy options.

Energy Supply and Energy Prices

Primary fuels from domestic (wood, peat) and foreign (oil, coal) sources are assumed to be supplied in any quantity at given prices. The assumed price development for primary fuels in the reference case are given in Table 3.1. Oil prices are assumed to increase by 8 % per year throughout the simulation period. This implies, that the real price of oil is assumed to grow by 1.5 % per year during the eighties and some half percentage point faster during the nineties relative to the world market price for finished goods. Throughout the study we assume that oil prices on the domestic market grow at the same rate as import prices given the current rates of oil taxation. This simplification overlooks the fact that taxes may be related to quantities rather than values and that domestic refining and transport services are part of the consumer price. Coal prices are assumed to be proportional or

Table 3.1. Prices of primary fuels in the reference simulation
(Growth rate in per cent)

	1980/90	1990/2000
Oil	8.0	8.0
Coal	8.9	8.0
Domestic fuels	6.0	5.0
CPI	6.2	6.5
GDP-deflator	6.7	7.2
World market price for finished goods	6.4	6.0

follow oil prices. The difference in rate of price increase during the eighties shown in the table simply reflects how the coal price with a certain time lag "catches up" with the oil price hike in 1978/80. This "catching up" is assumed to take place during the first years of the eighties. Prices for domestic primary fuels grow with costs in the forestry branch. Some allowance is made for improvements in the extraction technology, assuming a slight increase in productivity growth during the nineties. The price of domestic fuels relative to oil is therefore decreasing at an accelerating rate - from minus 2 % per year during the first half of the period to minus 3 % per year during the second half. It should be noted, however, that these prices only hold for primary fuels. Substitution between them is also affected by "conversion" costs, which may differ considerably. Turning coal or domestic fuels into useful energy requires more inputs (labor and capital) than if oil is used. Generally, this will make coal energy prices develop more favorably than shown in the table and energy produced from domestic fuels develop less favorably in relation to oil based energy.

Turning to the supply of electricity and distant heating the political restrictions imposed on the use of nuclear and hydro power is accounted for in the model. Total gross production of nuclear and hydro power (i.e., including internal use in the power stations) is assumed to increase by almost 4 TWh per year during the eighties and then to decline at approximately the same rate from 1995 due to the gradual closing of nuclear power stations. Adding further exogenous assumptions on industrial production of backpressure power, wind power development, possible combined production of electricity and distant heating, etc. the production system shown in Figures 3.1-2 emerges. Although the assumptions made and the resulting supply structure may well be disputed, it seems necessary to account for the rather strong shifts imposed on the electricity - distant heating production system during the simulation period by political decisions. This will have strong implications i.a. on the use of fuels - domestic and imported.

As shown in Figure 3.1 production of electricity is assumed to increase fast during the eighties with the nuclear power still building up. Although direct use of electricity for heating purposes will also increase, there will still be capacity left to replace fuels in the distant heating system. However, when demand for electricity catches up with the stagnating production in the nineties, the use of electric power to boil water for distant heating will have to end.

The assumed decrease of fuel input in the distant heating system in the eighties may very well be reversed in the nineties. The same holds for the fuel input in electric power production. Part of the gradually reduced nuclear capacity may have to be replaced by condensed steam or combined power plants using domestic or imported fuels. The reference case development of fuel use in electric power/distant heating production is summed up in Figure 3.2. With the assumptions made, the figures show a very fast increase in fuel input and even a slight increase in the use of oil towards the end of the nineties. This explains an important part of the rising demand for fuels during the nineties, which will be

Figure 3.1 Production of electricity and distant heating
(Reference case)

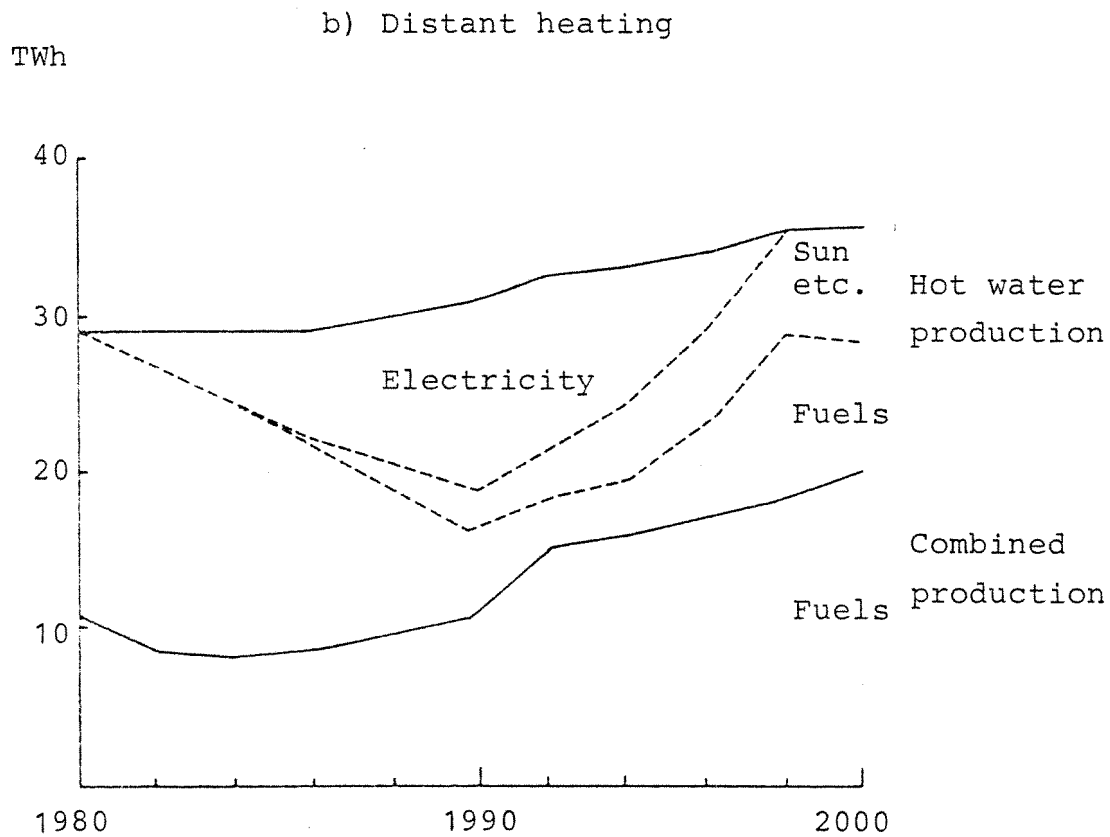
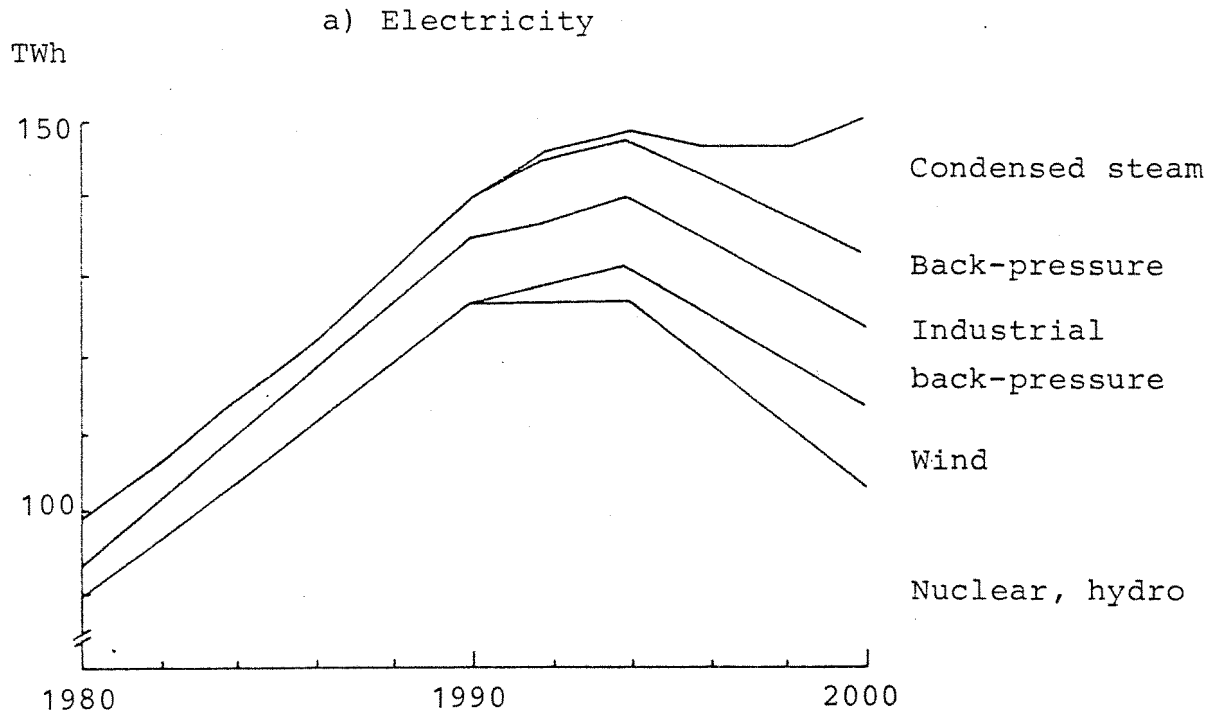
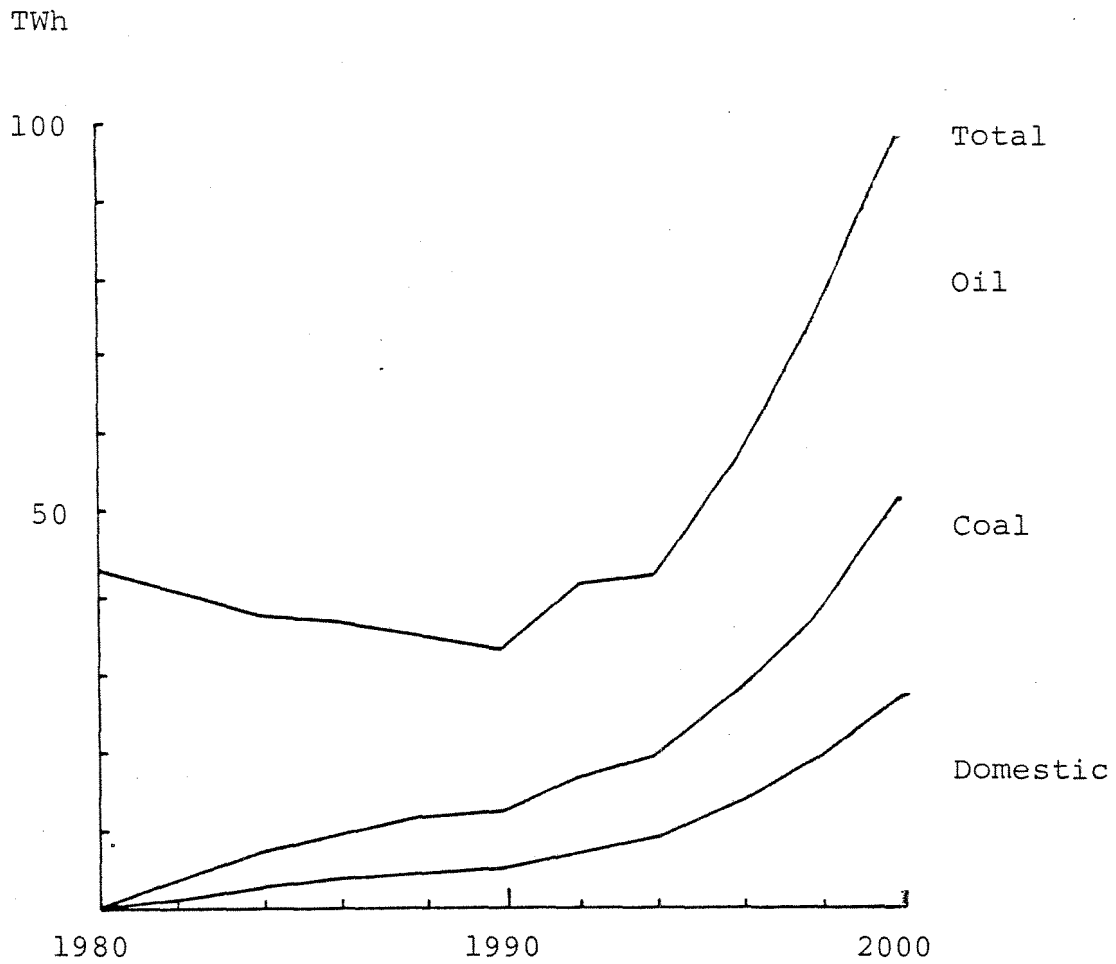

Figure 3.2 Use of fuel in the electric power/
distant heating production system
(Reference case)



further discussed in the next section. Increased use of imported fuels with rising relative prices, will make the real price of electricity and distant heating rise in the nineties. This will slow down demand growth but - according to the model - not enough to prevent large increases in the use of fossil fuels in power plants.

Energy Demand

Some thirty sectors are distinguished in the determination of final energy consumption. For each of these sectors total energy demand is usually separated into five categories i.e. electricity, distant heating, oil, coal and domestic fuels (wood and peat). For producing sectors energy demand is mostly projected as energy use per unit output (the energy coefficient) times production volume, while households' consumption of energy is formulated slightly differently.

The description of energy demand will follow the main sector groupings in the macromodel. Although this may not be the most suitable way to analyze energy use these groupings have been maintained for practical reasons. The main energy consumer sectors thus are the following:

- Manufacturing sector (14 branches)
- Rest of industry (9 branches)
- Household sector (3 purposes)
- Public sector (2 purposes)

This grouping i.a. implies that the heating of buildings is split up between all four sectors. Heating of homes will e.g. take place partly within the "rest of industry" (apartments for rent) and partly within "household sector" (owner-occupied houses).

The most elaborate part of the energy demand sub-model relates to the manufacturing sector. The total energy coefficients for

each branch is determined by three mechanisms - the vintage effect, ex ante substitution between (aggregated) inputs, and finally ex post substitution between fuels.

The ISAC model utilizes a vintage description of production capacity and technology for manufacturing branches. Although the empirical implementation in the present version of the model is incomplete in some respects it nevertheless takes account of important parts of the substitution effects. New choices of technology in investments due to a shift in relative input prices will be successively realized as new capacity is installed and old scrapped. Substitution between inputs thus continues many years after a change in the input price structure. A price shift occurring at the beginning of the simulation period - usually 20 years - will have effects throughout the period, since real capital turnover time is more than 20 years. This also means that part of the initial capacity - between one fourth and one half - will still be used after 20 years. One obvious reason for this rather sluggish rate of substitution is the treatment of machinery and buildings as an aggregated real capital stock. A good deal of technical change is, of course, due to investments in new machinery and equipment within existing factory buildings. With aggregated real capital it is, however, not possible to increase the speed of substitution by investing more in machinery and equipment in response to price shifts. The model therefore tends to underestimate the medium term (5-10 years) substitution possibilities in the economy.

Another deficiency in the implementation of the vintage mechanism is the lack of initial capacity distributions. A rectangular initial distribution is assumed, i.e., input coefficients are set equal between all vintages. This holds except for labor input where the marginal coefficient is assumed to be 0.6 times the average coefficient in all branches. For energy this is a very cautious "estimate" of marginal input coefficients since price developments during the recent decade may very well lead to reduced energy use in today's optimal production technique. The assump-

tions about initial average and marginal input coefficients will have a decisive influence on the development of aggregated energy coefficients and thus on the full employment energy demand levels in the economy. This is illustrated in Figure 3.3, which shows the effect on the total energy coefficient for the manufacturing sector of different assumptions regarding the marginal coefficient in the initial distribution. In case B the initial marginal coefficient is set at 60 % of case A value. With new capacity being added through investments, this will result in a faster decrease of the energy coefficient although the development of relative prices is identical in the two cases. Thus, different assumptions on marginal versus average coefficients for the initial simulation year will affect future levels of energy consumption. As stated before, however, most of the simulations reported in the following and the conclusions drawn, do not really depend on absolute levels of future energy use, but rather on differences between projected levels under alternative assumptions.

The second substitution mechanism is the choice of technique in new vintages. In each branch, input coefficients for electricity, fuels, capital and labor are computed from (last years) relative prices using constant elastic functions estimated from historical data (cf. Dargay, 1982, 1983). The results of this econometric approach to the ex ante substitution possibilities should be interpreted with caution for two reasons. The first reason is that, due to lack of data on technological choice in new plants, our estimates relate to average technology in a branch. Substitution possibilities, however, are undoubtedly far greater on the margin than what they seem to be when measured intermarginally on the whole capital stock. We have tried to correct for this by scaling up substitution elasticities.¹

The second reason for caution is that estimates have been made for a period (1950-75) when real energy prices were steadily fal-

¹ For a related discussion of the costs of adjustment in energy demand for manufacturing cf. Berndt-Fuss-Waverman, 1979.

Figure 3.3 Aggregated energy coefficients with different initial marginal coefficients in the manufacturing sector

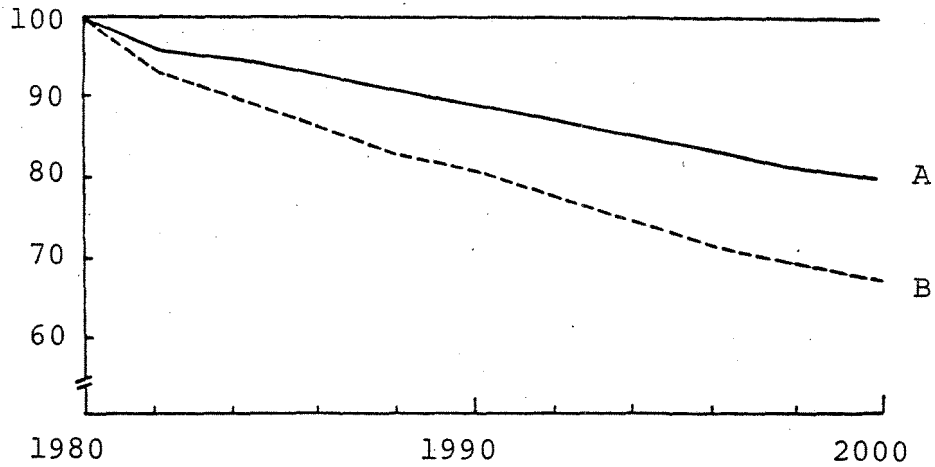

Note: The curves show total energy use in physical units per unit output in fixed (1975 year's) prices with 1980 value equal to index 100. A is the reference case discussed below. B shows the effects on the energy coefficient in the manufacturing sector if the marginal coefficient in the initial distribution is assumed to be only 60 percent of the reference case value.

ling. This means we cannot know whether substitution possibilities are symmetric or not. We still use the results for a period when real prices of energy - or at least of fuels - are steadily increasing. The alternative would be to use engineering data on possible future production techniques which, however, suffers from uncertainties related to technical and commercial full scale implementation. Of course, the two methods should be used together and checked off against each other.¹ This has generally not been possible to do within the work presented in this report. Some attempts to compare the two approaches have, however, been made within the Energy and Economic Structure project (cf. Ysander, 1983).

The coefficients for electricity and fuels in the manufacturing sector in the reference case are shown in Figure 3.4. Although the coefficients are subject to aggregation effects due to changing industrial structure, the general pattern is clear. The use of energy per unit output will fall and the fuels coefficient will decrease faster than the electricity coefficient.

Having determined the aggregated input coefficient for fuels the next step must be to distinguish between different kinds of fuels. To separate the choice of other input coefficients from the choice of fuel type, means we assume that a decision to use, e.g., coal instead of oil will not affect labor and capital coefficients. This is not strictly true in most cases. The rationale behind the chosen procedure is that estimates of substitution elasticities for different energy types on a disaggregated branch level were not available when the model was implemented. Substitution between fuels within a branch is furthermore assumed to be possible across all existing plants, e.g., the type of fuel used in a boiler can be switched without much change in the technique used in the rest of the production process. This is a sufficiently accurate description of the use of fuels in the manufacturing sector ex-

¹ For a discussion of methodological options and some attempts at comparison cf. Berndt-Field, 1981.

Figure 3.4 Energy coefficients for electricity
and fuels in the manufacturing sector.
Reference case

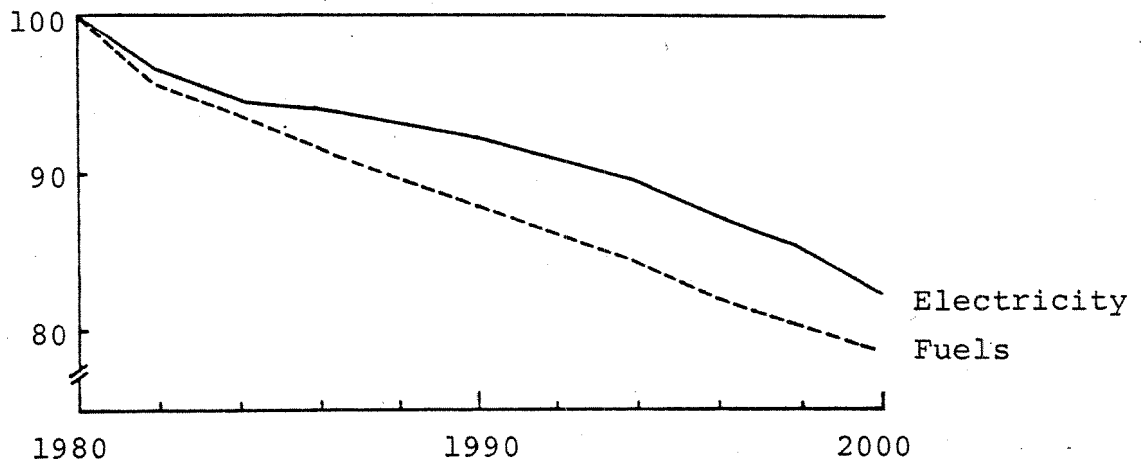

cept for those branches, such as iron and steel, where a particular fuel is also an integrated part of the production process itself.

For convenience we measure substitution between fuels in terms of physical energy units which makes it easier to calibrate the reference projection against other projections.¹

While the use of fuels per unit output in the manufacturing sector falls, the share of oil will also decrease due to the unfavorable relative price development as shown in Figure 3.5. Coal and domestic fuels will each increase their share with some ten percentage points during the simulation period.²

Energy substitution in the eight industrial branches outside the manufacturing sector is treated in a more conventional way. Ex post substitution possibilities between inputs (electricity, fuels, labor and capital) are given by constant elastic functions in relative prices. The procedure to determine the share of different types of fuels - given the input coefficients - is the same as before. Estimates of elasticities are, however, based on "calibration" and "informed judgement" to a greater extent than for the manufacturing sector.

¹ It should be noted, however, that the reference projection was constructed with an aggregate manufacturing sector and was not based on detailed studies of substitution possibilities between fuels for each manufacturing branch.

² In comparing this development with the prices given in Table 3.1, two things should be noted. The table refers to the price of the fuel. Since fuel cost is a relatively large share of the production cost of energy when oil is used, the price of the fuel will then have a stronger impact on energy price. Assuming that the cost of other inputs (labor and capital) per unit output follow the general inflation, this implies that there will be a slight decrease in coal produced energy price relative to oil energy price - at least from 1985 on - and that the price development for energy based on domestic fuels will be somewhat less favorable than it appears in Table 3.1. There is also a four year lag assumed in the fuels substitution which evens out the 1980-85 difference between coal and oil. The coal price rise during this period will in fact catch up with the oil price thus restoring the "normal" relation between coal and oil prices.

Figure 3.5 Use of oil, coal and domestic fuels
in the manufacturing sector
(Percent of total fuel use)

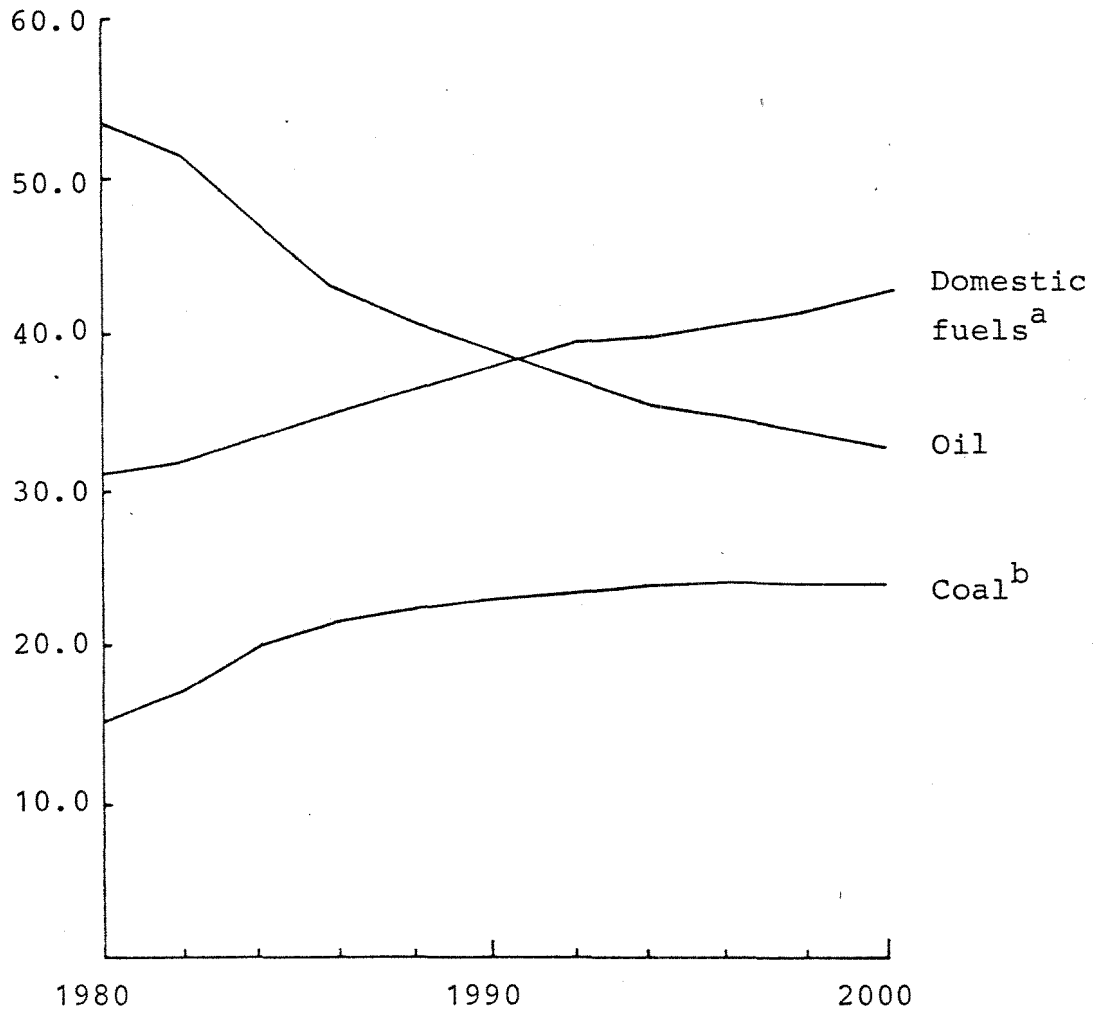

^a Incl. internal fuels in paper and pulp industries.

^b Incl. coke.

The same holds for energy use in the public sector. Energy use in the reference case for these two sectors is shown in Figure 3.6. The total energy coefficient is falling - although slowly - during the simulation period. The share of oil consumption per unit output will fall from two thirds to one half. The sluggish decrease of energy and oil demand is i.a. explained by the fact that transports are included in this sector making it more difficult to substitute oil for other energy. Also saving - and substitution - possibilities in the heating of buildings, which is responsible for a great part of the sector's total energy use, have been judged cautiously in the model.

The last energy consuming sector is the household sector. The basis for the energy projection in this sector is a linear expenditure system, comprising three energy "goods" directly consumed by households along with the other eleven consumer goods in the system. One difficulty, which makes the numerical results harder to interpret, is that electricity used for heating and other purposes (light, machines, etc.) cannot be distinguished in the statistics long enough to allow for proper estimation (cf. Dargay-Lundin, 1978).

Since the price of electricity for heating develops favorably during the first half of the simulation period, one should expect increased electricity consumption. As shown in Figure 3.7 the model "predicts" a slight increase in the coefficient for electricity use in the household sector, despite a fairly strong decrease in total energy use (per consumption unit) during the eighties. This development is primarily explained by the combination of a fast reduction in house heating - the distant heating coefficient is even reduced and a fast substitution toward electric heating. Hence, households' direct consumption of electricity will increase by more than 40 % over the decade.

Again it should be noted that energy use in this sector also includes motor fuels. The slow substitution of oil used for this purpose shows up in the figure as a slow increase of "other energy" which is made up of mainly motor fuels other than gasoline.

Figure 3.6 Energy use per unit output in the public sector and "other industry". Reference case.
(Total energy use per unit output in 1980 = 100)

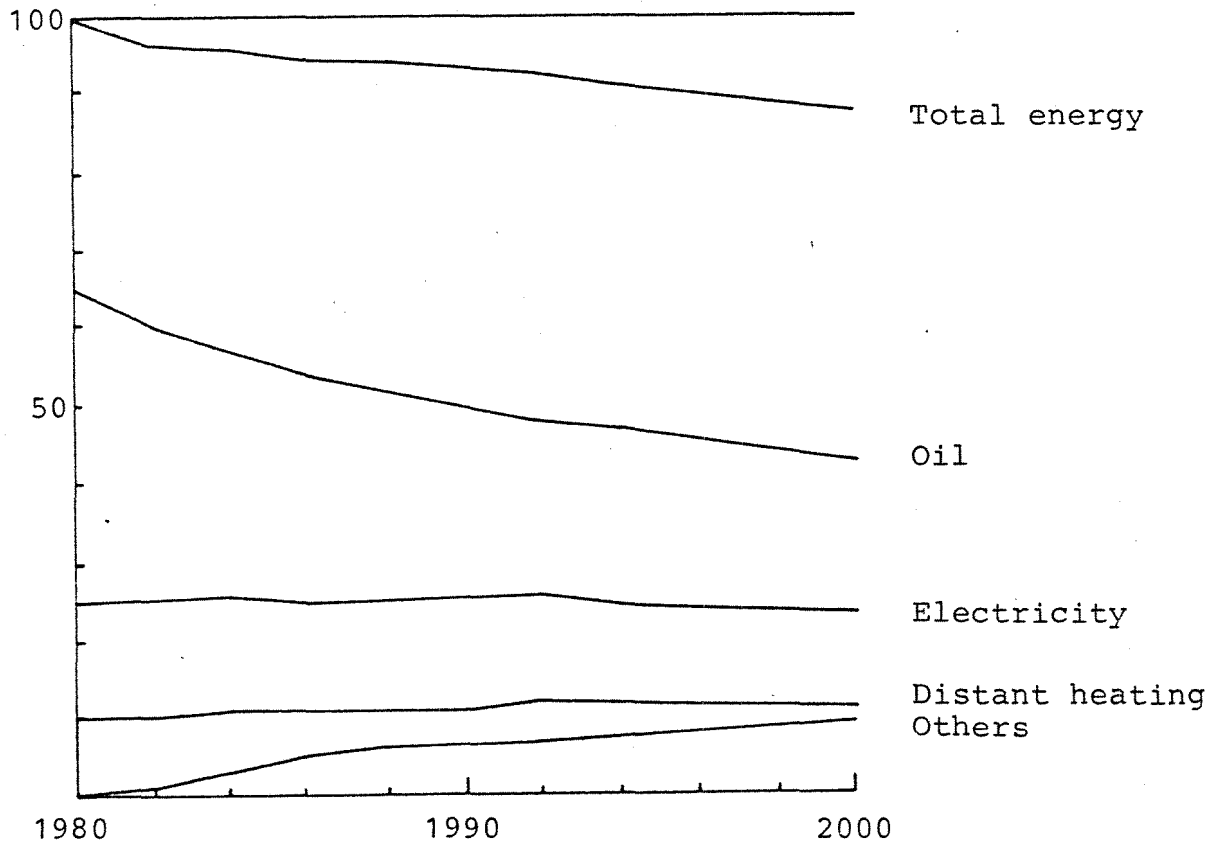
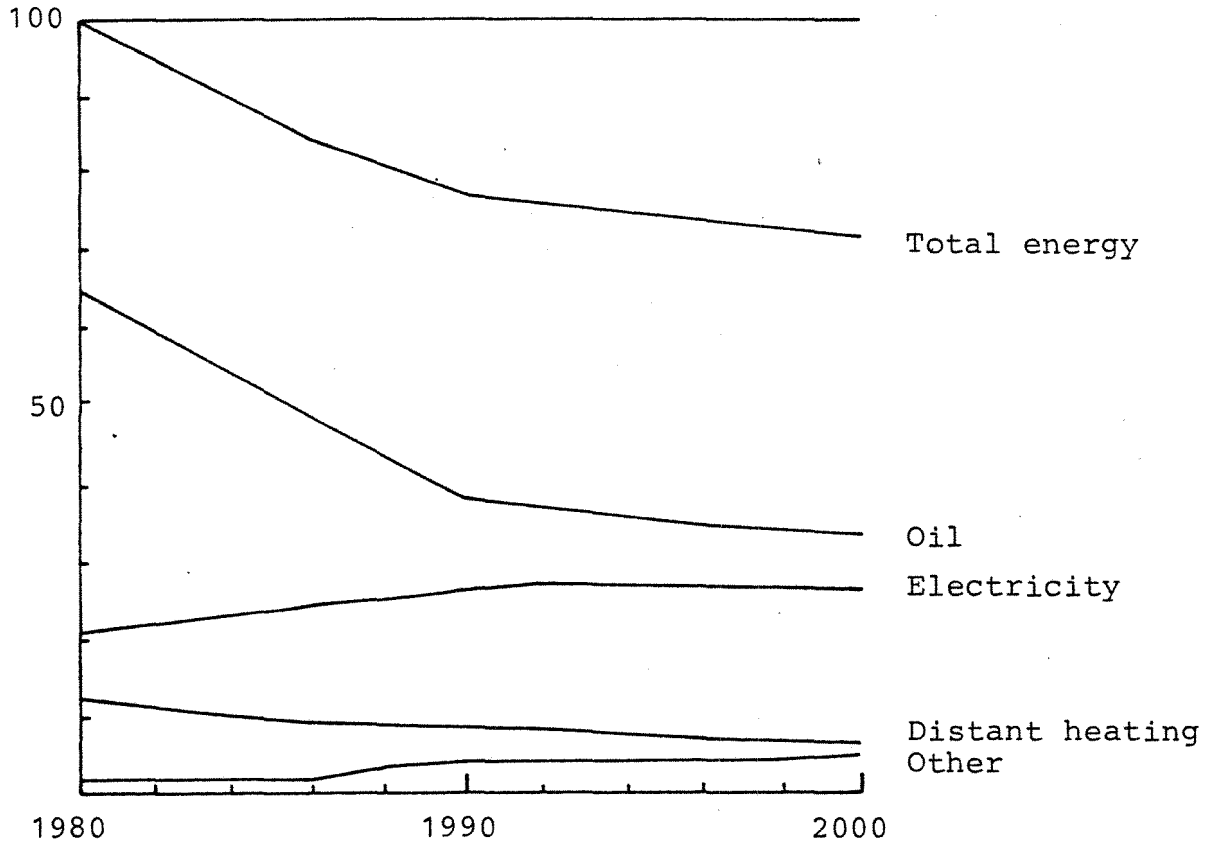

Figure 3.7 Energy use per unit private real consumption
in the household sector. Reference case
(Total energy use per unit real consumption
in 1980 = 100)



Total Energy Use and Aggregate Substitution

The total use of energy in the model economy is determined i.a. by those assumptions on prices, substitution elasticities, political restrictions, etc. discussed above. The general economic growth is, of course, also of paramount importance. The macro-economic assumptions used to construct the reference growth path will be described in the next chapter. In this section we will briefly discuss what all these assumptions imply for total energy use.

Final demand of energy per unit GDP falls in the reference case - altogether by 20 % - throughout the entire simulation period as shown in Figure 3.8. Since, however, GDP grows by more than 50 %, the level of final energy use will end up at a 20 % higher level compared to the 1980 consumption. A large part of the reduction of oil consumption per unit output is evidently explained by energy saving. Only a minor part is replaced by other kinds of energy - notably coal and domestic fuels (wood and peat).

Turning to the input of primary energy, the picture is much the same. During the eighties abundance of nuclear power contributes to a reduction of oil use for the production of distant heating and electricity as well as for direct house heating. Towards the end of the simulation period, nuclear power is partly replaced by fuel based energy, even forcing a slight increase in oil input per unit GDP. It must be emphasized, however, that levels of energy consumption in the reference case are not primarily meant to be used as independent projections or forecasts. They do however seem to fit the "conventional wisdom" about future energy consumption as documented by numerous official studies during recent years. Some of these projections are gathered in Table 3.2. They show some crude consensus, at least at an aggregate level, with the one notable exception reported in column F. This study projects a level of energy use 20-25 years ahead, that is less than half the reference case level (column A). This rapid energy saving is supposedly brought about by implementing those most profitable techniques, which are energy conserving. Given the

Figure 3.8 Final energy use per unit output (GDP)
Reference case (1980 = 100)

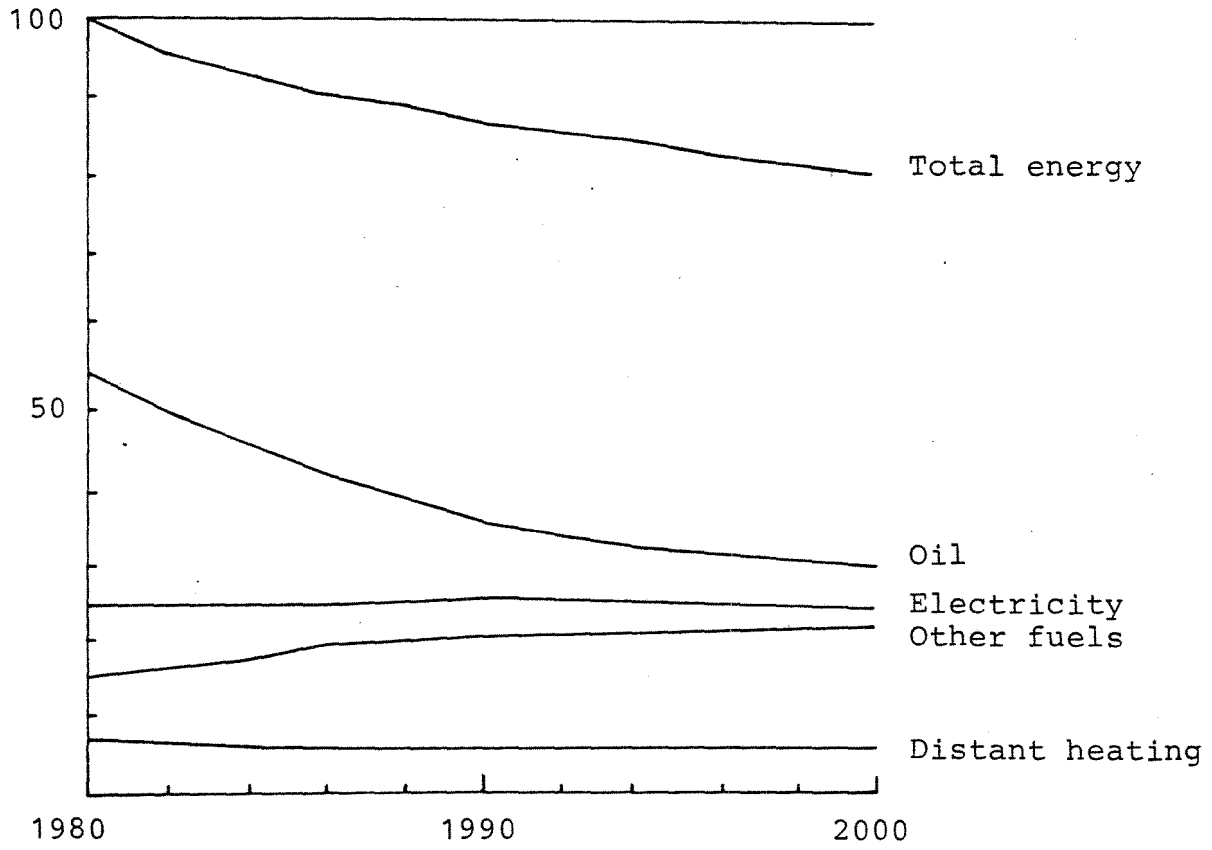

Table 3.2 Recent energy projections (TWh)

	1990				2000			
	A	B	C	D	E	A	B	F
Nuclear + hydro power	126	126	124	130	-	103	126	65
Oil	219	225	267	189	230	258	179	100
Coal	43	60	31	55	46	70	107	
Domestic fuels	67	70	58	79	77	112	98	95
Other	4	4	3	6	-	19	10	11
Total	459	485	483	459	-	562	520	271

A = This study, reference case

B = SOU 1979:83

C = SIND 1980:17

D = Prop 1980/81:90

E = SOU 1982:16

F = Steen et.al., 1981

rate of depreciation of real capital and of gross investment it is possible to calculate future energy use with "best technology" and to do this for different economic growth scenarios. With a low marginal energy coefficient the average coefficient will also decrease with time. The approach is much the same as adopted in the ISAC- model although more interest is focused on the marginal coefficients which tend to be lower than those used in our study. These coefficients are, however, not formally implemented into a macromodel of the ISAC-type.

The principal aim with the model experiments carried out in this study is to compare the outcome under different as-

sumptions on oil prices. The general economic consequences will be extensively dealt with later. To illustrate some energy substitution mechanisms the energy consumption effects will, however, briefly be discussed here.

Let us compare the reference path with an "oil tax" case, where the price of oil on the domestic market is gradually increased through the eighties. The tax is assumed to inflate the oil price paid by consumers by 4.5 % per year above the reference case. During the nineties oil prices will grow at the same rate as in the reference case, but the price level will be higher by more than 50 %. The resulting difference in primary energy use relative to the reference case is shown in Table 3.3. We see that the oil coefficients for the whole economy will continue to decrease in the nineties in the tax case, even though oil prices then are assumed to grow at the same rate as in the reference case. This is due to the sluggish reaction to price changes and the slow adjustment of real capital structure.

With the vintage capital approach used for investments in the manufacturing sector, the low marginal oil coefficients chosen in the eighties will, *ceteris paribus*, decrease average oil use until the whole capital stock is renewed. In the oil tax case there is no tendency for the decrease in the oil coefficient to halt, since the oil price differential will grow to the maximal 54 % in 1990. Rather there seems to be an accelerated decrease in average oil use in this sector, partly as a result of structural shifts towards less energy intensive branches.

The same continued decrease in oil use during the nineties arises in the rest of the production system (including production of public services). However, reduction in oil use is here much slower i.a. due to a large share of gasoline which is hard to substitute.

Development of oil use in the household sector when taxes are raised does not, however, exhibit these lingering effects. Since much of the households' oil consumption is tied to capital goods,

Table 3.3 The effects on oil coefficients from an oil tax increase during the eighties^a
(Reference case coefficients = 1.00)

	1990	2000
Manufacturing sector	0.77	0.45
Other industry and public sector	0.84	0.76
Household sector	0.64	0.63
Production of distant heating and electricity	0.80	0.25
Total economy	0.75	0.56

one would expect continued decrease of oil use during the nineties with the turnover of the stock of houses and cars. However, no such vintage mechanism is implemented for capital goods in the household sector. The model specifications for household energy consumption will therefore probably overestimate the price-effects during the eighties and underestimate the long-run effects.

In the oil tax case there is also a fast decrease of oil use in the production of distant heating and electricity during the nineties due to particular reasons. Because of the nuclear power build-up, the use of fuels in this sector will be halved during the eighties, leaving little room for investments in new plants for coal or domestic fuels. The full impact of the oil tax will therefore be felt during the nineties when fuel based production of electricity and distant heating expands by a factor three. In the oil tax case, the use of oil per unit output will be one fourth of the reference case level at the end of the simulation period.

Finally, from Table 3.3 it is possible to compute a kind of approximate aggregate price elasticity of oil, assuming that the elasticity of oil use with regard to GDP is close to unity. Given the size of the tax increase the aggregate price elasticity during the eighties could be calculated as -0.6. Since, however, the relative decline of the oil coefficient continues during the nineties without any further increase in oil price differentials, the price elasticity measured over the whole simulation period would be twice as large i.e. -1.2.

4 THE SIMULATION DESIGN

Economic Developments in the Eighties and Nineties

As a measuring rod for our simulations we have used a "reference case", i.e. a standard scenario for the development of the Swedish economy during the next two decades. The assumptions concerning the international markets and the domestic labor supply are listed in Table 4.1.

We assume that the rate of increase in the volume of international trade will be stable but somewhat lower than in previous post-war decades. For raw materials and semi-finished goods this will mean an annual rate of increase of 2.3 and 2.6 percent respectively during the eighties and nineties, while the trading in finished goods is supposed to increase annually 5.7 and 5.0 percent respectively and that of services 4.5 and 5.0 percent. There are good reasons to expect a stagnating supply of labor in the next two decades. The number of hours worked per employee will continue to decrease at a fairly rapid rate during the eighties yielding a falling labor supply in terms of hours. These developments are however assumed to come to an end in the nineties with a slight increase in number of persons in the labor force, offset by a small decrease in the number of hours worked per employee, thus making labor supply in number of hours almost constant during the decade.

The price of oil is assumed to increase annually with 1.5-2.0 percent relative to the price of finished goods in international trade. The coal price is throughout the simulations assumed to adjust proportionately, although with a certain lag, to changes in the oil price, thus maintaining the relative level vis-à-vis the oil price that it had reached before the oil price rise in 1979-80.

Table 4.1 Assumptions for the eighties and nineties

World trade development

Annual increase, %	1980/1990		1990/2000	
	Volume	Price ^a	Volume	Price ^a
Raw materials and semifinished goods ^b	2.3	5.5	2.6	4.1
Finished goods	5.7	6.4	5.0	6.0
Services	4.5	7.0	5.0	6.0

^a In international currency.

^b Includes the following branches: agriculture, forestry and fishing; mining and quarrying; manufacture of wood products, pulp and paper; basic metal industries.

Labor supply development

Annual increase	1980/1990	1990/2000
Number of persons ^a	32.7	14.2
Number of persons ^b	0.7	0.3
Hours worked per employee ^b	-1.0	-0.2
Labor supply, number of hours ^b	-0.3	0.1

^a Yearly change in thousands of persons.

^b Yearly percentage growth.

As described in Chapter 2 a model simulation also requires a number of policy variables to be given exogenously in order to reach announced targets of economic policy. There is in principle a great many ways of controlling the economy, i.e. to reach specific macro economic targets.

We have employed three main policy instruments: wage policy, wage tax and public consumption.

"Wage policy" really means controlling the long term growth trend of wages. Technically this is attained in the simulations by varying the constant term in the estimated relation for the growth rate of nominal wages. In actual life this could correspond to the efforts, frequently exemplified in Sweden during the 70s, to keep down the nominal wage claims in the collective bargaining by various fiscal adjustments, particularly directed towards the rate of personal income tax.

The second type of policy instrument is the wage tax, which is assumed to be entirely shifted back onto the wage earners even in the short run. It can be looked upon as a representative of a wide variety of tax and transfer measures. It is, however, a natural candidate since there are strong reasons to suppose that future increases in central government taxation will predominantly take this form.

Finally we assume full control not only of central government consumption and transfers but also of local government expenditures. What this means is that we have simplified the interpretation of the experiments by treating local government expenditures - and taxes - as exogenous.¹

Among our policy instruments we have not included an active exchange policy. The reason is that, in the model, changes of the

¹ For an account of the interaction between local governments and the rest of the economy and its effects on stabilization problems and policies, cf. Nordström - Ysander (1981)

exchange rate appear to be substitutes rather than complements to wage policy. The price compensation claims built into the equation explaining the rate of wage increase, tend to counteract and, after 2-3 years, almost completely neutralize any change of the exchange rate. That an active exchange rate policy thus requires the cooperation of the parties on the labor market to keep back compensatory claims would seem to agree rather well with our experiences from the 70s.

Three target variables are considered in the reference simulation: the rate of unemployment, the balance of payment and the growth rate of public consumption.

The policies adopted in the reference case - Figure 4.1 - have had the following main targets. The current balance of payment deficit should be eliminated by 1990 and stay close to zero for the rest of the period. Unemployment should be kept around what is considered a "normal" rate of frictional unemployment - 2 percent of the labor force. The assumed strategy for public consumption has been to let it grow at a slightly faster rate than private consumption during the eighties but evening out the accounts in the nineties, thus attaining on the average a roughly proportionate increase over the two decades of public and per capita private consumption.¹

Table 4.2 shows the simulated development of the economy in the reference case. The need to restore the external balance before 1990 is reflected in the gap between the growth of exports and imports during the eighties with repercussions primarily on

¹ For a more detailed discussion of alternative conditions and strategies for Swedish economic development 1980-2000, cf. Nordström - Ysander (1980).

Figure 4.1 Target variable values 1980-2000
Reference case

Deficit on current account, percent of GDP at
factor values (—)

Unemployment, percent of total labor force (-----)

Real private consumption, percent of total con-
sumption (right hand scale) (-.-.-)

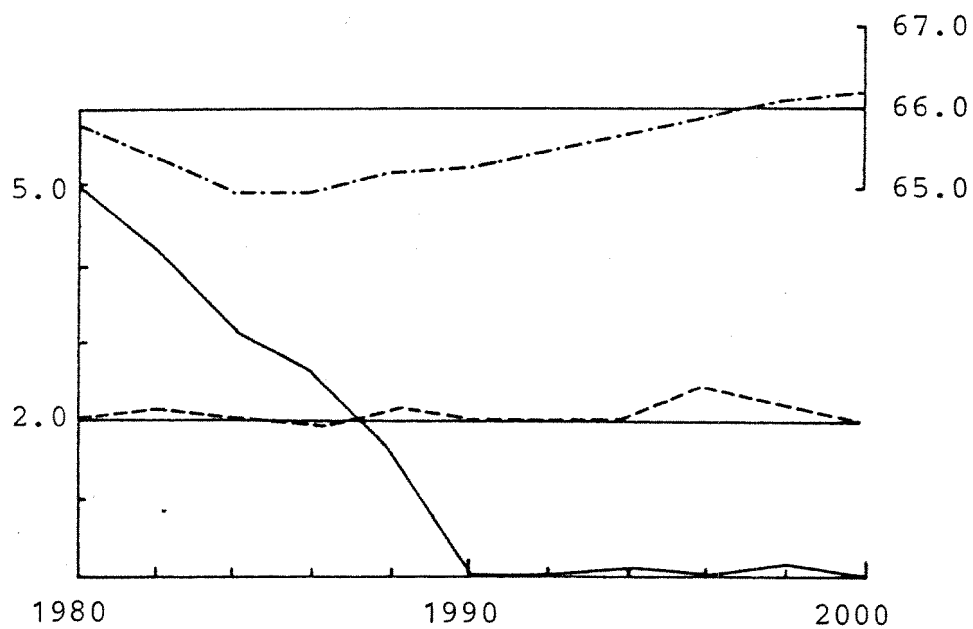

Table 4.2 Real GDP by expenditure 1980-2000.

Reference case

Annual increase, %	1980/1990	1990/2000
Consumption	1.3	2.4
Investments ^a	1.8	2.1
Exports	4.6	3.8
Imports	2.9	4.3
GDP	2.1	2.3

^a Including changes in stocks.

private consumption growth. In the nineties a faster consumption growth compensates for the meager previous decade.¹

Stagnating Oil Prices

How would this reference scenario change with other assumptions about oil price development?

In the standard reference case we have assumed for the oil price a 1.5-2.0 real growth rate for the rest of the century - if deflated by the price of finished goods. Oil price forecasting is, however, a highly uncertain business and no one can exclude the possibility of e.g. a stagnating real oil price. However, our main results do not depend critically on these assumptions.

¹ The difference in growth rate between exports and imports in 1990/2000 is due to the fact that volumes are expressed in 1975 years prices. The 1990 export volume is 25 % larger than the import volume implying a slower growth rate required for export volume to keep export value increase equal to import value increase. Also the fairly favorable growth assumptions for world trade developments actually permit a slight increase in relative export prices, thus further reducing the necessary export volume growth rate.

Our main aim is to analyse the impact of oil price shocks on the economy and different ways to alleviate the problem they cause. Most of our conclusions relate to differences between simulations rather than to absolute levels. The effects of an oil price hike is here measured by the difference in e.g. private consumption levels between a simulation with the sudden oil price increase and a simulation without it. Within certain bounds this difference does not vary very much with the oil price assumption used as reference. We shall, however, briefly discuss the effects of stagnating oil prices. The exact price assumptions are given in Table 4.3.

Table 4.3 World Market Prices

Annual Increase %	Reference Case		Stagnating Oil Prices	
	1980/1990	1990/2000	1980/1990	1990/2000
Finished Goods	6.4	6.0	6.4	6.0
Oil	8.0	8.0	6.0	6.0
Coal	8.9	8.0	6.9	6.0

The reduced energy import prices will certainly improve terms-of-trade for the Swedish economy. The consumption level corresponding to full employment and external balance will accordingly be higher as shown in Figure 4.2. The total gain at the end of the simulation period will amount to 5 % of the reference case private consumption level. The improved terms-of-trade are not solely due to the oil prices. Since the total oil import bill will be smaller the need to generate a trade surplus for other goods is somewhat relaxed. Hence the need to gain market shares by lower

Figure 4.2 Effects of Stagnating Oil Prices
(Reference Case = 100)

Private Consumption (—)
GDP (----)
Terms-of-trade (-.-.-)

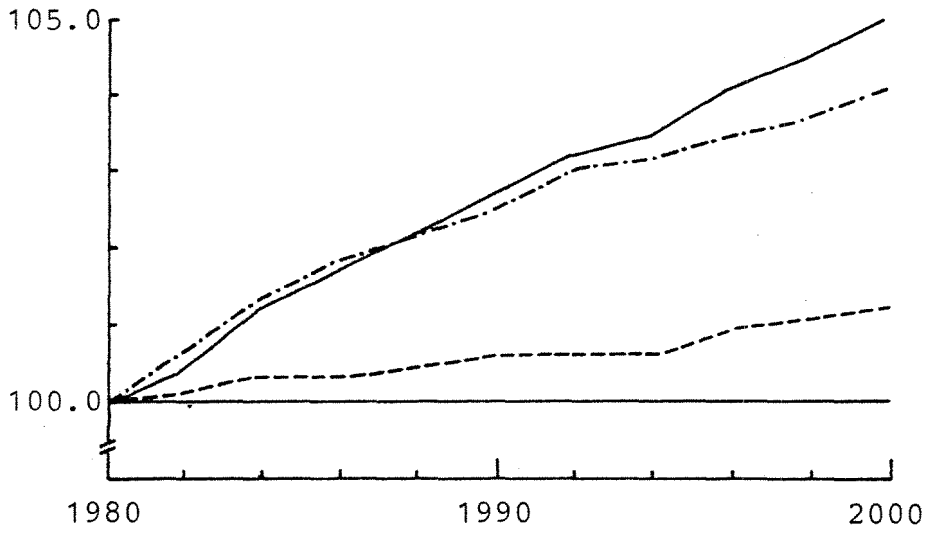

relative prices and deteriorating terms-of-trade will be correspondingly less.

Simulation Experiments

The main experiments we have performed with the model are summarized in Table 4.4. Below the reference case and the case of a gradual oil price increase different variations of the oil crisis scenario are listed in order of increasing adjustment problems.

The oil crisis itself is modeled as a close to 60 percent rise in the relative oil price, occurring early in 1991 with the gradual price increase (GO), the same total relative price increase is reached in 1991 by a steady rise throughout the eighties. In the first type of oil crisis simulation (O, OI), the oil price hike occurs without interrupting world trade.

In the second type of oil crisis scenario (OW, OS, TOS), various cyclical repercussions on other world markets taken into account. Based on the experience of the 70s and on some experiments carried out for this purpose on the LINK model (Sarma, 1983), the resulting world trade cycle is modeled as a 3-year pattern led by a short-lived speculative boom in raw material and investment goods, of dominant importance still for Swedish exports, followed by a general trade slump. Over the first 4 years of the 90s the annual increase in the volume and price of world trade (excluding services) will be, on the average, multiplied by a factor of 0.5 and 1.0 respectively, compared to the reference development. To facilitate comparisons, we let, in both cases, public consumption develop as in the reference case, registering the shrinking room for increased consumption in terms of private consumption.

In the simulations listed in the left-hand column - O, OW - no policy adjustments are made to compensate for the oil price hike. The impact measured will thus be the outcome of market reactions to the changed relative prices.

Table 4.4 Eleven simulations 1980-2000

		No oil tax		Oil tax	
		No policy adjustment	Policy adjustment		
Oil Price and political adjustment costs	No oil price hike		REF - The reference case (increasing/stag- nating oil prices)	TREF - Oil tax without oil price hike UPA	
			GO - Gradual oil price increase UPA		
	Increasing economic and political adjustment costs		O - Oil price hike without world mar- ket repercussions	OI - Oil price hike without world mar- ket repercussions UPA	
			OW - Oil price hike with world market repercussions	OS - Oil price hike with world market repercussions UPA	TOS - Oil tax with oil price hike UPA
				MW - Minus wage policy	
			MP - Minus also public consumption policy		
			MR - Minus also the possibility of lowering real wages		

UPA = Unrestricted Policy Adjustment

When instead full use is made of available policy instruments in order to restore balance in external payment and in the labor market in three years, the result will be as in the simulations OI and OS, listed in the middle column.

The 3 variations MW, MP, and MR listed below in the same column simulate the effect of successively taking into account restrictions on the use of economic policy instruments which, judging from the experience of the 70s, may well be perceived as binding by Swedish decision-makers. In MW, we take away the wage policy instrument, making it impossible to influence the long-term trends in nominal wage increase. This must then be compensated for by an active use of the control of public consumption. In MP, this policy instrument is also blocked, public consumption again being prescribed to follow the reference pattern. Finally, in MR, the need for trade union support is supposed to force the government to guarantee no decline in real wages, thus increasing the unemployment needed to ensure external balance.

Two additional cases, in which an oil tax is used as a buffer against the possibility of an oil-price hike, are listed in the right-hand column of Table 4.4. The oil tax we study has a very simple construction. It is successively stepped up during the 80s, annually adding an extra oil price increase of around 5 percent, so that by the beginning of 1991 it has raised the domestic oil price as much as the assumed size of an eventual oil price hike.

If the oil crisis materializes - the TOS-case - the tax is used as a buffer, the lifting of the tax neutralizing the raised import price. We then measure the benefits by comparing the resulting development during the 90s with the uninsured case, OS, assuming the same access to policy instruments. If the oil crisis does not come (the TREF-case), the oil tax remains and causes some retardation in growth during the following decade. The cost of the tax insurance is evaluated by comparison with the outcome in the reference case which, apart from the tax, rests on identi-

cal assumptions. A comparison is also made with the case, SO, of a gradually rising import price in order to differentiate between the effect of changed terms-of-trade and that of changed domestic relative prices.

5 THE IMPACT OF AN OIL PRICE SHOCK

In this chapter we will describe the impact of an oil price hike on the economy using the reference case as a standard of comparison. Both short term responses and long term substitution effects will be discussed. Changing oil prices also have important effects on the world market. These effects may be of great importance to a small open economy like the Swedish. Economic policy must also be taken explicitly into account since an oil price crisis makes policy changes necessary, at the same time increasing the pressures on policy-makers.

Impact Without World Market Repercussions

Let us first trace the direct impact of an oil price hike on the Swedish economy disregarding the repercussions on the world markets. In 1990/1991 the price of imported oil is assumed to increase by 2/3 instead of the reference 8 % increase. Through the eighties and again from 1991 onward oil prices will increase by the reference case rate. Prices on coal are assumed to follow oil prices albeit with a certain lag as shown in Figure 5.1.

Although target variables will be displaced by the oil price increase it may clarify the analysis if we start by keeping policy variables unchanged. The question we thus try to answer is: what would happen with the economy in an oil crisis if the Swedish government decided to ignore it and to go on doing "business as usual"?

The immediate impact of a large oil price rise on the model economy is to boost inflation, e.g. as measured by the consumer price index. This comes about in two ways - directly through the households' use of oil and indirectly through increased costs of

Figure 5.1 Real price of oil and coal

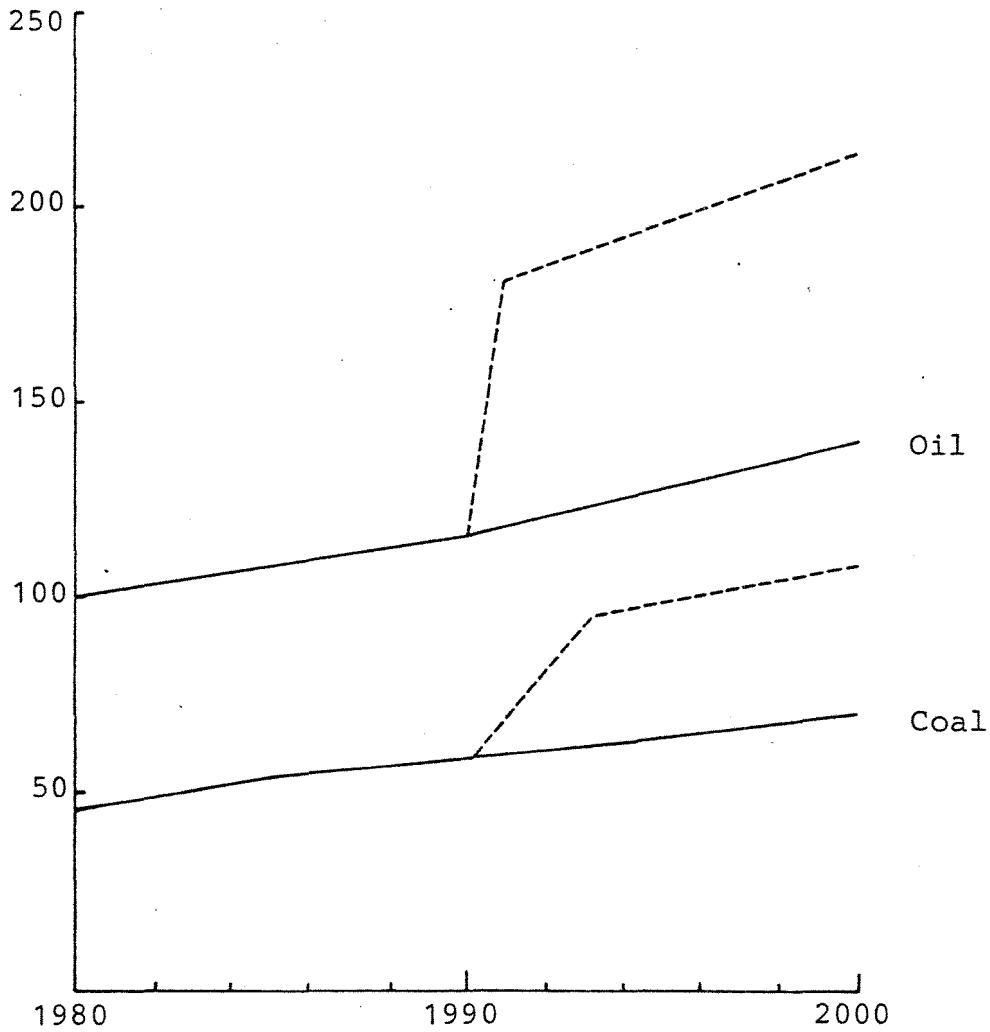

Note: The dotted lines show price developments in the oil price hike case. Real price of oil (Swedish Crowns per MWh) in 1980 = 100.0
Nominal prices are deflated by the world market price for finished goods.

production in the business sector. The inflation impact is shown in Figure 5.2. After the initial inflation peak in 1991, the inflation rate will gradually approach that of the reference case.

However the oil price hike and its inflation impact will set forces in motion which will affect the real development of the economy and feed back on prices with various lags. One important mechanism coming into play is the wage formation mechanism. As is evident from Figure 5.2a the initial impact on wages is negative. Wage rate growth in 1990/1991 will fall below the reference case by three percentage points. A fairly strong wage response to excess demand in the labor market comes into play immediately while wages respond to prices only after a year. Inflation will deflate private income and will make industry lose market shares abroad. This fall in real demand will promptly show up in open unemployment as shown in Figure 5.2b, thus causing wages to fall relative to the reference case. There is a fairly large cut in real wages in 1991 - minus 6.5 percent compared to the reference case and minus 3.5 percent relative to the wage level of the previous year. This assumed wage formation mechanism will bring the economy back to full employment within a few years. Thus, the model asserts or assumes that a total lack of accommodation on the part of the government will cure the economy both of unemployment and inflation within 3-4 years. The fall in domestic real income is however not large enough to offset the loss of terms-of-trade imposed on the economy by the oil price increase. The initial deficit on current account will thus persist as shown in Figure 5.2b. (The exchange rate is assumed fixed.)

The limited fall in consumption demand - 3 percent during 1991 compared to the reference case - is due to the progressive income tax as well as to the inflation compensated transfers which make up a considerable part of the households' disposable income. Another contributing factor is the assumption that public wage increases lag one year behind the business sector. So, some of the reasons why stabilization after an oil price hike cannot

Figure 5.2 Effects on inflation, unemployment and current account from the oil price hike

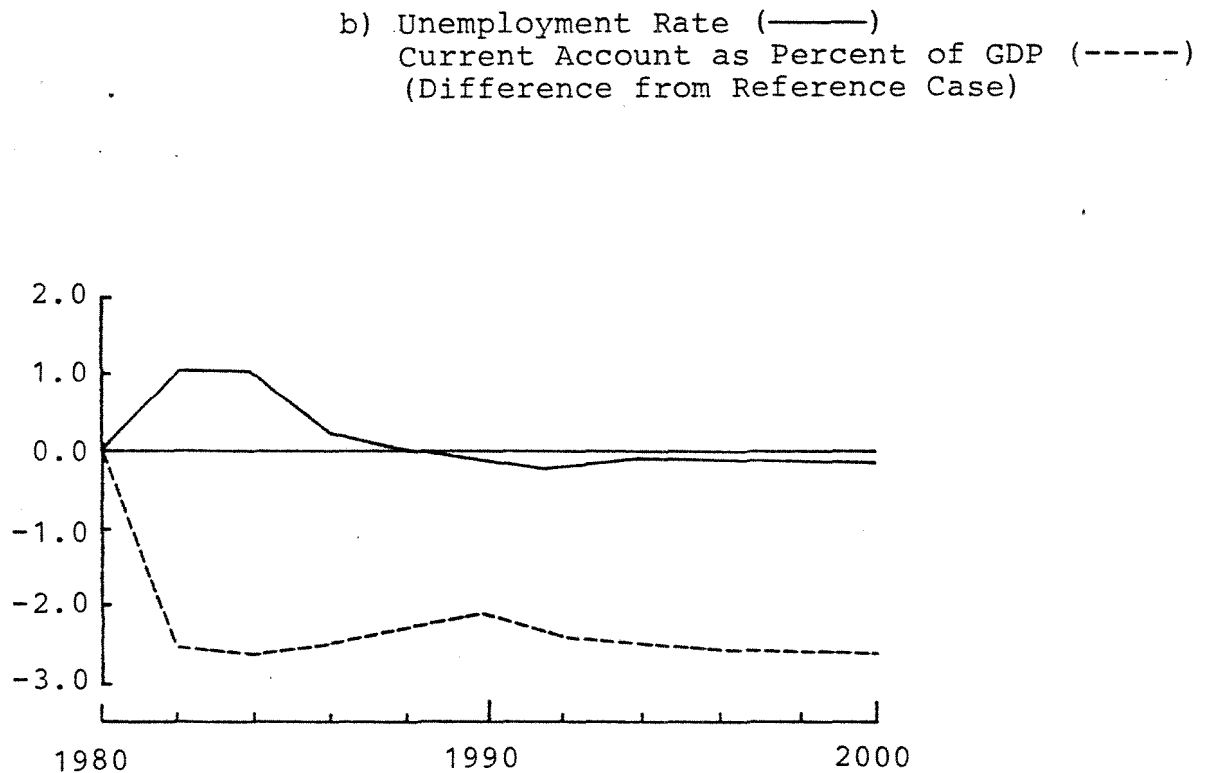
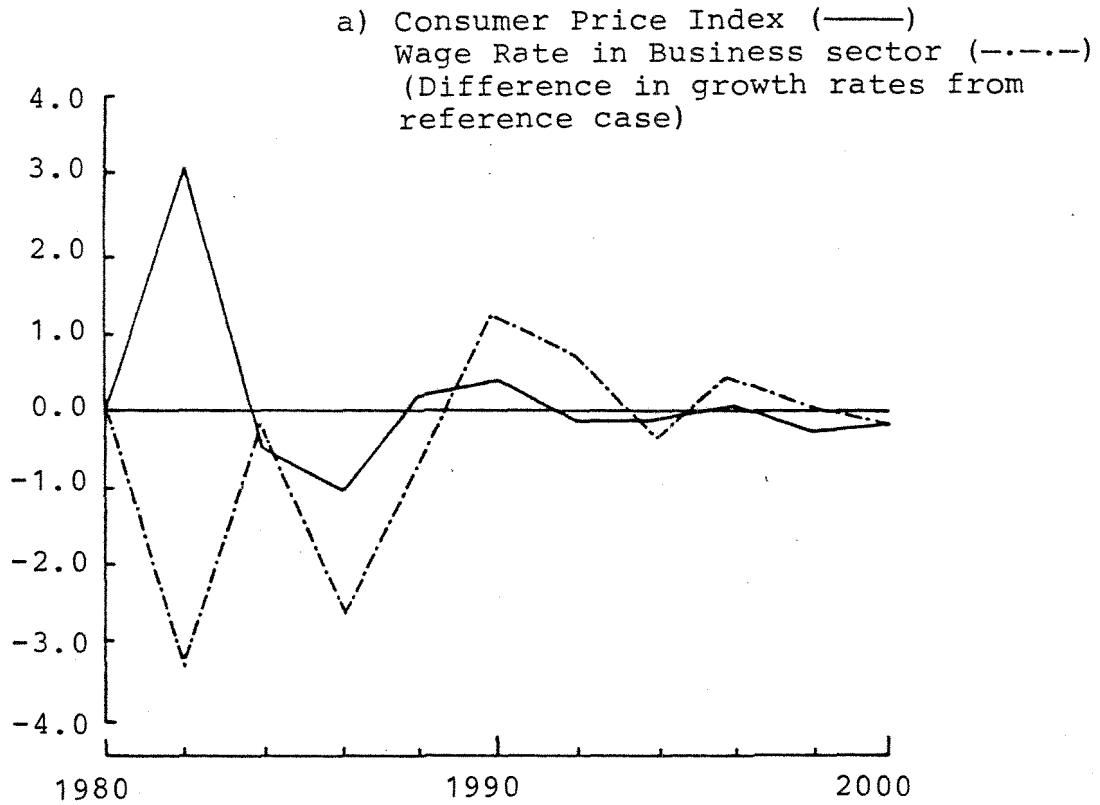

Note: The difference in oil price growth in 1990/1991 compared to the reference case is 54%. For coal this difference is spread over three years. Apart from oil and coal prices all growth rates of international prices are identical between the two simulations.

safely be left to the markets has to do with the fact that "in-built automatic stabilizers" in the tax and transfer system and various forms of inflation indexing cushions the inflationary impact so much as to impede the adjustment of the domestic consumption level, leaving us with an external deficit.

Turning briefly to the energy consequences, the use of oil will decrease compared to the reference case. A minor part of the reduction is explained by slower economic growth. More important, however, is reduced energy use per GDP unit and reduced share of oil in total energy use. As Figure 5.3 indicates, oil use in TWh/GDP is reduced by 30 % during the nineties as a result of the oil price rise in 1991. Total primary energy input will be 10 % lower. The decline in energy coefficients is gradual due to the inertia in energy substitution built into the model, i.a. through vintage mechanisms the capital formation in the business sector.

Impact of World Market Repercussions

In our discussion so far world markets were assumed to be completely unaffected by the oil price shock. We did this for analytical reasons to isolate the "direct" oil price impact from "indirect" effects from unstable world markets. The assumption could be interpreted as reflecting perfect adjustment or stabilization policies being carried out throughout the world. At least at an aggregate level this would imply i.a. that inflation is contained and that the financial transfers inherent in an oil price hike are organized without depressing real income and demand. This could of course be true only at an aggregate level. To ascertain this stability, patterns of trade and production would have to change in response to shifts in wealth among countries and relative prices among goods.

Judging from historical experience, crises of the type discussed here are however not likely to be handled in a cooperative spirit

Figure 5.3 Effects on energy use from the oil price hike. Primary energy input to GDP
(Reference case = 100)

Total energy (——)
Oil (-----)

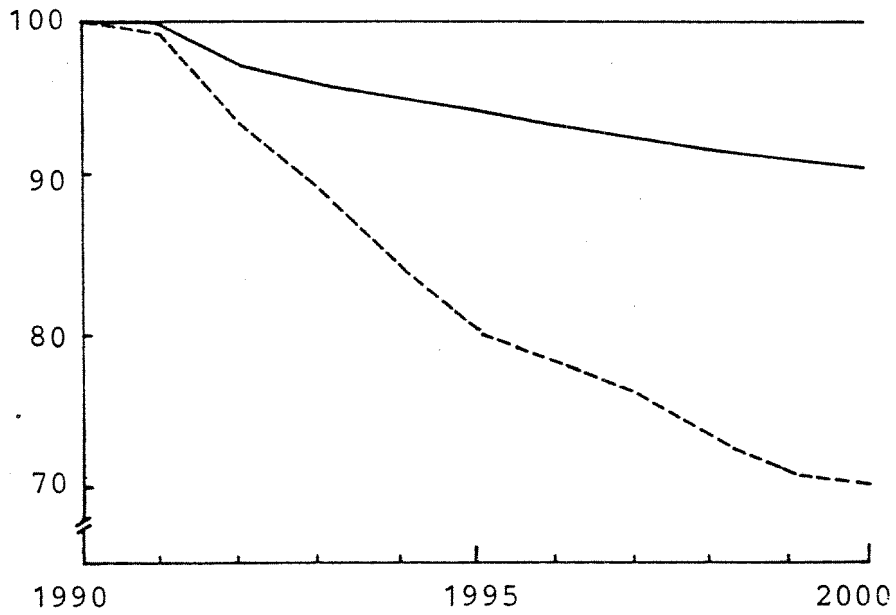

or to be accommodated smoothly by the international community. It seems therefore reasonable to introduce some kind of world market effects into our simulation experiments. This will add considerably to the arbitrariness of the calculations since future international policy responses are not easy to predict. Our aim, however, is only to illustrate the increased strains that domestic policy makers will be facing when international stabilization policies are not pursued in an optimal way.

Based on the experience of the seventies and on some experiments carried out on the LINK model for this purpose (Sarma, 1983), a world trade cycle is modeled as a three year pattern led by short-lived speculative boom in raw materials and investment goods - of dominant importance still for Swedish exports - followed by a general trade slump. Over the first four years of the nineties the annual increase in the volume and price of world trade will on the average be multiplied by a factor 0.5 and 1.0 respectively.

For the rest of the decade, markets are assumed to be stable but with lower trade growth rates and higher inflation rates than in the reference case, as shown in Figure 5.4. World markets for services are assumed to develop with the same patterns as markets for finished goods.

Initially the assumed world market cycle will in fact somewhat alleviate the negative effects of the oil price increase for the Swedish economy. This is evident from Figures 5.5a-c, which show differences between oil price hike simulations with and without world market repercussions.

The reason is the raw material boom in the first phase of the cycle which favors the relatively large Swedish exports of such goods. The balance on current account will therefore improve somewhat during 1991-1992. When markets turn down, however, the negative effects will be correspondingly stronger. Since the domestic activity level - given e.g. by the employment rate - will not improve even during the third year of the crisis, the increase

Figure 5.4 Oil price hike and world market repercussions
(Differences in growth rates from reference case)

a) Raw materials excl. fuels
World Trade (———)
World Market Prices (-----)

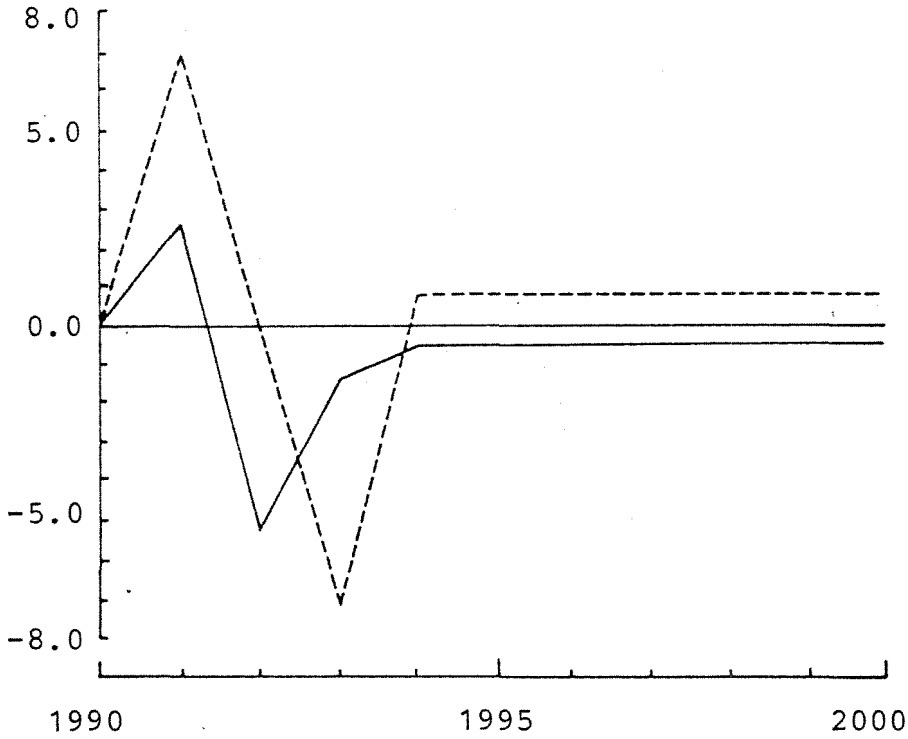

b) Finished goods
World Trade (———)
World Market Prices (-----)

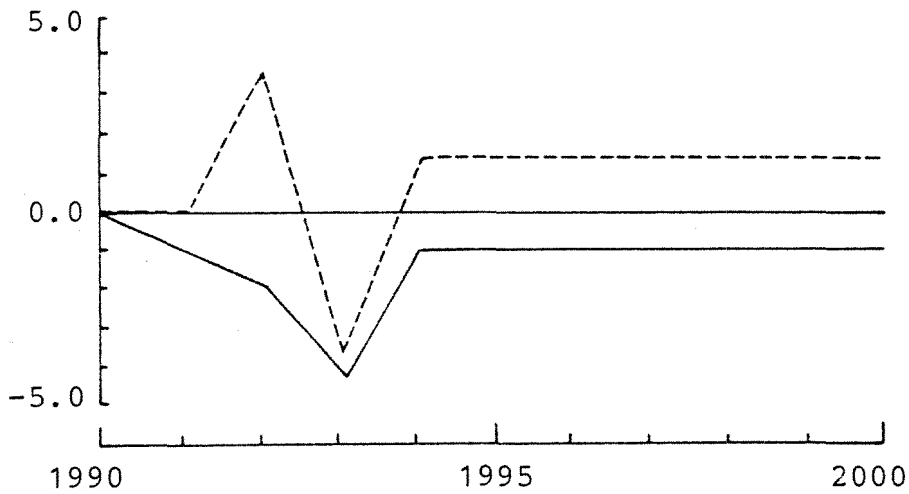

Figure 5.5 Effects of oil price crises and world market repercussions

(Difference from reference case)

Oil Price Hike Only (—)

Oil Price Hike Plus World Market Repercussions (-.-.-)

a) Real Wage Rate Growth

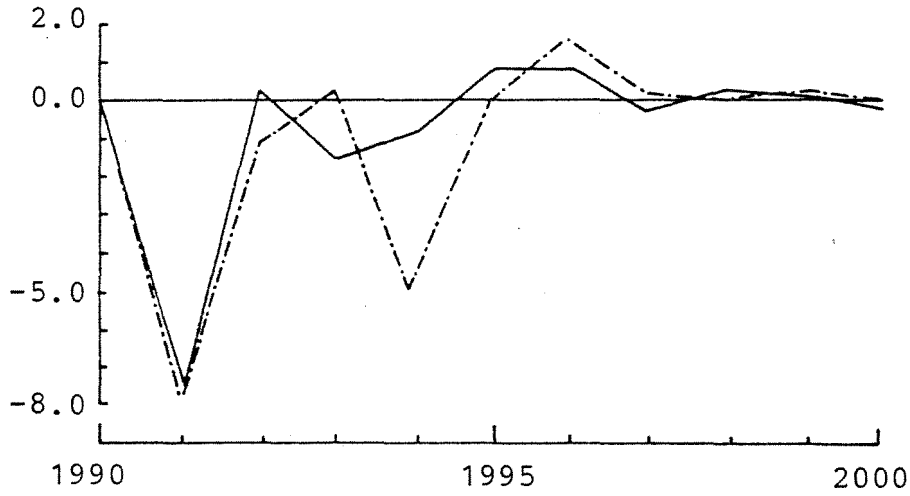

b) Unemployment Rate



c) Current Account as percent of GDP

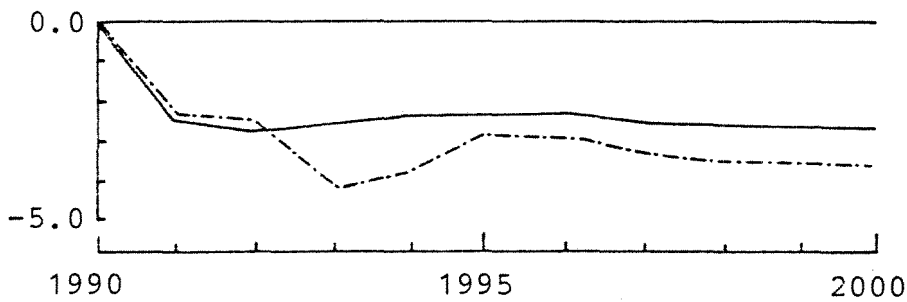

in domestic unit labor costs will be modest. Compared to a simulation without disturbed world markets, real wages will on average decrease by one percentage point per year during the first five years of the decade. Figure 5.5b-c show that economic imbalances - unemployment and external deficit - will be reinforced by the world market crises. The rate of unemployment caused by the combined oil price rise and world market repercussions will amount to 3.4 % and 2.5 % respectively in 1993 and 2000. The deficit on current account for those two years will be respectively 4.2 % and 3.7 % of GDP.

Stabilization Policies

We have so far only studied the impact of an oil price hike in the case where the government takes no countermeasures, but allows the foreign debt to accumulate. That is obviously an untenable position in the long run and we will now go on to see what solution can be offered by an active stabilization policy.

Economic policy in the simulation experiments is pursued towards two main goals: full employment and balance on current account for external transactions. The three instruments used to achieve desired target levels are taxes, real public expenditures and wage-policy.

Tax policy is modeled as a wage tax. In using public consumption as an instrument it is tacitly assumed that policy makers exercise full control not only of central government expenditures but of local government expenditures as well. The ISAC-model does in fact include an expenditure model for local governments where the central expenditure control can be substituted by more realistic policy variables like different kinds of grants. This sub-model is however not used in the present simulations.

The wage policy instrument, finally, is implemented as an autonomous wage rate increase that is assumed to be directly or indi-

rectly controlled by the government policy makers. Altogether this does not yield a very rich framework for stabilization policy analysis but works satisfactory for our purposes.

Throughout this section we will keep the public expenditure growth unchanged and analyze the use of tax and wage policy to reach the specified targets. Variations in public consumption growth will, however, be necessary when the use of other policy instruments is restricted, as we will see later on.

The effects of parameter changes in the ISAC-model has been described elsewhere and shall not be repeated in detail (cf. Jansson, Nordström, Ysander, 1982). As is seen from Figure 5.6 a reduction of the autonomous wage rate growth (A) will improve the current account and increase employment in a medium term perspective (3-5 years). This is mainly the result of improved competitiveness on the world market. Instruments B and C in the figure on the other hand will primarily affect domestic demand by increased taxes and reduced public expenditures respectively. A desired improvement of the external balance can be accomplished with smaller negative effects on employment if measures are directed towards private consumption, due to its higher marginal import propensity.¹ In both cases, however, the increased unemployment will depress wages, thereby also boosting net exports through improved international competitiveness.

We saw already (cf. Figure 5.5) that the oil price crisis will bring about internal as well as external disturbances throughout the nineties if no counter measures are undertaken. When world market effects are taken into account, unemployment will reach a peak level at 3.5 % in 1993 and will then remain around 2.5 %. The principal problem will, however, be the current ac-

¹ This is the simple "technical reason" for giving the combination wage and tax policy first priority in selecting an "optimal" policy program for two instruments. There are of course other ways of evaluating program packages, and our choice here should not be thought of as indicating any value judgement in this respect.

Figure 5.6 Effects of policy instruments on target variables
(Differences to the reference case)

Current Account
(per unit of GDP)

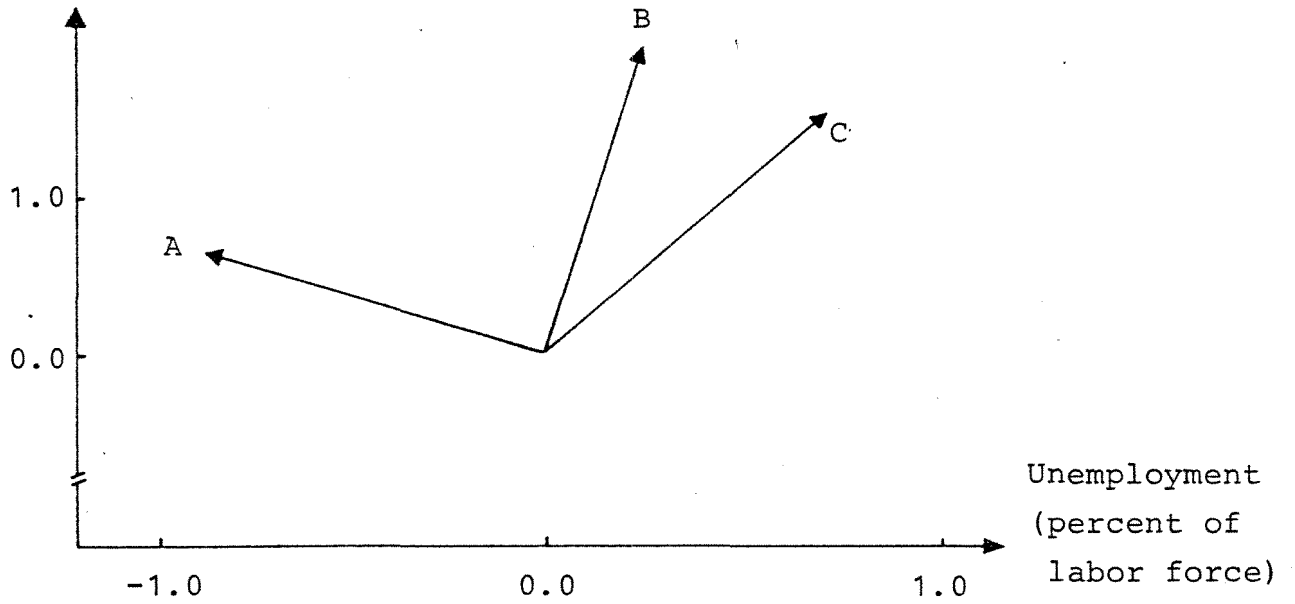

- A: Wage Policy
- B: Tax Policy
- C: Public Consumption Policy

count which will deteriorate to a deficit amounting to 3-4 percent of GDP. The outflow of currency will then sooner or later make policy adjustments necessary. We have here chosen to use parameters in the tax and wage functions as policy instruments. We have also, for analytical reasons, chosen to bring the economy back on target as soon as 1993 and to keep it close to target for the rest of the decade. By this standardization it is possible to compare the austerity required by different policy packages.

The changes in tax and wage-policies necessary are rather self-evident. Although the crisis by itself will lower real wages, the decrease is not large enough to offset the rising energy costs in production and the deteriorating terms-of-trade. As shown in Figure 5.6 a downward adjustment of the "autonomous" wage rate increase will improve the external balance as well as the employment situation. To reach the targets in 1993 tax rates must also be raised. Thus economic policy must depress real wages and private consumption shares of GDP, even further than what would be the case in an "uncontrolled" development of the crises-ridden economy. This is illustrated by the shaded areas in Figure 5.7. Policy measures will have to be rather harsh during the first three years of the crisis. Real wages, which grow by more than 3 percent a year in the reference case, must decrease by more than 2 percent per year during 1990-1993. For the rest of the decade real wages may grow at approximately the reference case rate. Also tax policies must be hard-fisted enough to force down private consumption and make room for the net export expansion necessary to restore external balance. Although GDP growth is not much changed by the policies measures, private consumption will decrease by 1.6 % per year between 1990 and 1993. It should be emphasized that labor supply is exogenous in the model and thus not affected by taxes or wages. When the crisis has been contained after three years, the economy resumes a "normal" growth path although from a lower consumption level than in the reference case. This difference is a rough measure of the welfare loss incurred by the combined oil price and world market crisis through deteriorating terms-of-trade. It will reach a maximum of

Figure 5.7 Policy measures to reach target values in an oil crisis

Reference Case (———)
Oil Crisis with Reference Case Policy (-----)
Oil Crisis with Adjusted Policy (-·-·-·-)

a) Wage Policy: Real Wage Rate Level
(Reference Case = 100)

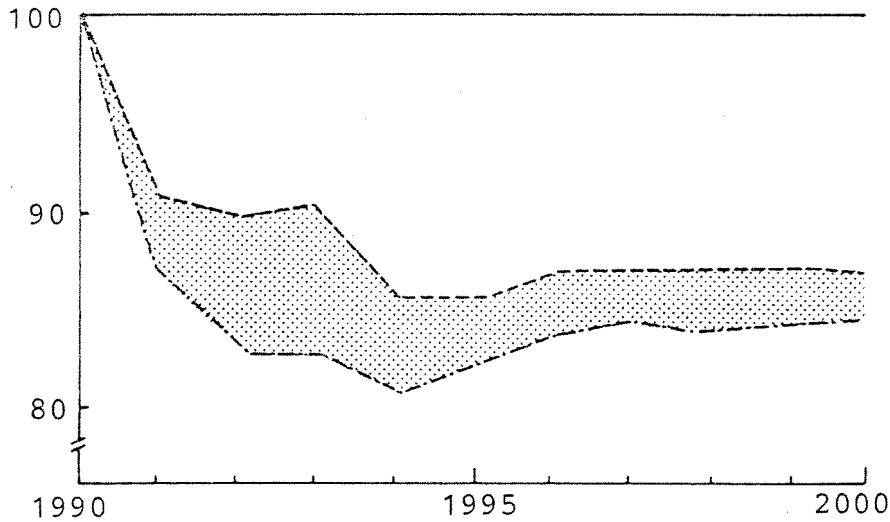

b) Tax Policy: Real Private Consumption Share of GDP (percent)

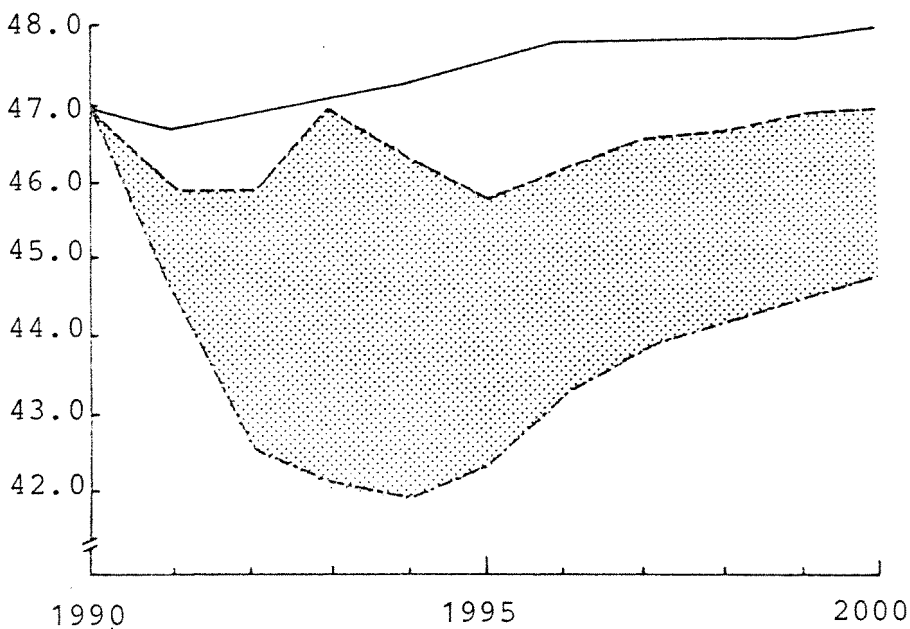

14 % of the reference case level in 1995 and will on the average be 10 %.¹

Of course, if all countries would accommodate the oil price hike without deflating their economies, the hardships would be mitigated. As stated above we may approximate such a development - including a balanced trade between oil exporting and importing countries - by assuming that world markets for other goods are unaffected by the oil price rise. This will substantially reduce the necessary changes in policy parameters as well as the persistent loss in terms-of-trade and consumption levels due to stagnating world markets. The difference between the outcome of the two oil crisis cases - with and without world market repercussions - are summarized by the shaded area in Figure 5.8. In both cases targets are reached in 1993 and maintained for the rest of the decade. The figure thus shows direct and indirect effects from an oil price crisis in terms of welfare losses (as measured by private consumption) and policy requirements (as measured by the real wage rate). With the assumed size of the oil price rise and its world market repercussions, the major part of the impact on the Swedish economy - about 3/4 - will consist of the direct oil price effect. However, Figure 5.8b shows that the required real wage adjustment is magnified by the world market effects. While the real wage rate levels in 1995 must be 9 percent below the reference case level when the oil price hike is not accompanied by disturbances in world trade, real wages will have to fall another 7 percent if such disturbances has to be accommodated. During the first two years of the crisis real wages will have to fall by 4 percent as a direct effect on the economy from the oil price rise, while it takes a reduction of real wages by almost 10 percent during these two years to handle the combined crisis. Obviously this will increase the risk of not coping and of therefore incurring further welfare losses.

¹ This case (OS) will be compared to the oil tax case (TOS) in Chapter 6.

Figure 5.8 Direct and Indirect Effects from an Oil Crisis
(Reference Case = 100)

a) Private Consumption Level

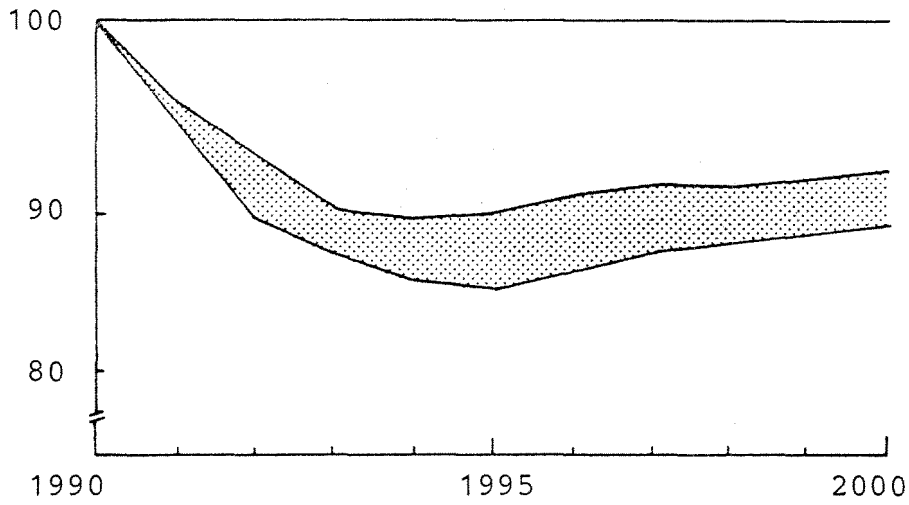

b) Real Wage Rate Level

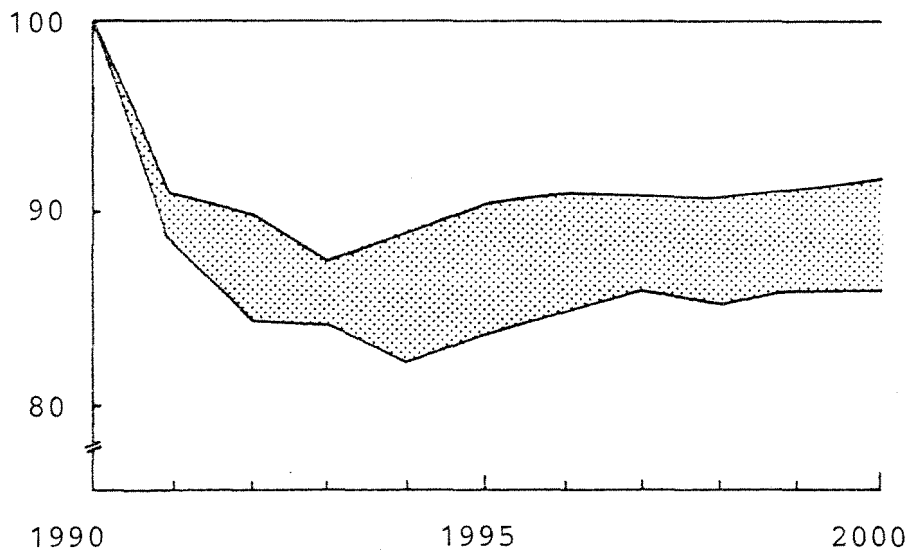

Effects of Policy Restrictions

So far we have assumed the policy instruments to be completely at the disposal of the policy maker with no restrictions on their use. Policy problems in real life tend to be more complex. There are political trade-offs and the preferences of organized voter groups to take into account. Such interdependencies could be incorporated into the simulation exercises through optimization over some explicit loss-function. For several reasons we have here chosen a much cruder analytical approach. One reason is that such loss-functions are hard to specify and even harder to estimate (cf. Gramlich, 1979). The main reason, however, is technical. Since ISAC is a fairly large model, formal optimization would have added considerably to solution costs.

Instead we will in the following simply discuss the consequences of successively giving up or restricting the use of policy instruments. The gradual shrinking of the policy space will make it impossible to reach both targets in all cases. We have then chosen to meet the external balance target and measure the cost of the restrictions in terms of unemployment.

The experiments are carried out in the following way (cf. also Table 4.4). During the "crisis" period 1991-1993 various restrictions are put on the use of policy variables. The policies pursued still aim at reaching in 1993 both the external balance and the employment target. When both cannot be reached the employment target is abandoned. For the rest of the simulation period, i.e. 1994-2000, no restrictions are imposed and targets are (approximately) attained. By measuring the "harshness" of the policies required in terms of consumption and real wage, we try, in a very rough and indirect way, to estimate the risk of not coping with the crises, of the policies being blocked or impeded.

In the first experiment (MW) no wage policy is allowed, i.e. we cannot control the autonomous wage growth. Wages will not only fluctuate according to "market forces" but also develop according

to an exogenous long term trend. To reach the targets we must then use the third instrument available - public consumption expenditures. If we cannot improve our competitive position by measures directly affecting production costs, i.e., wage rates, the only way to eliminate the external deficit in the short run without increasing unemployment is to save imports by substituting public for private consumption. This solution is illustrated in Figure 5.9, where all variables are related to the unrestricted oil crises case (OS). Note that the current account target is reached in these experiments and is therefore not shown in Figures 5.9-11.

The necessary redistribution between private and public consumption is drastic. Public consumption growth rate must increase from 2.1 % to almost 7 % per year during the crisis period 1991-93. To release labor for this public expansion from the rest of the economy, taxes must be raised substantially. As a result private consumption in 1993 is 8 % below the OS case. Since the private consumption level in the OS case is almost 5 % below the 1990 pre-crisis level this further decrease implies an average yearly reduction of total private consumption by 4.5 % during 1991 and 1993. Even though consumption levels will be restored to the unrestricted levels towards the end of the decade it would obviously be difficult to find support for and to execute such wild swings in public consumption.

Inflation will be higher during the crisis period than in the OS-case (cf. Figure 5.9b) since wage inflation is not controlled. Real wage growth will on the average exceed the OS case by 2.3 % per year between 1991 and 1993, still however implying zero real wage growth from 1990.

In the second experiment (MP) we also assume that rapid shifts in public sector growth are impossible. To make it simple we proscribe that public consumption cannot be used as a policy instrument at all. This leaves us with only one policy variable - tax policy - and with no hope of reaching both targets except by chance. Since we have decided to stick to the external balance,

Figure 5.9 Minus wage policy (MW)

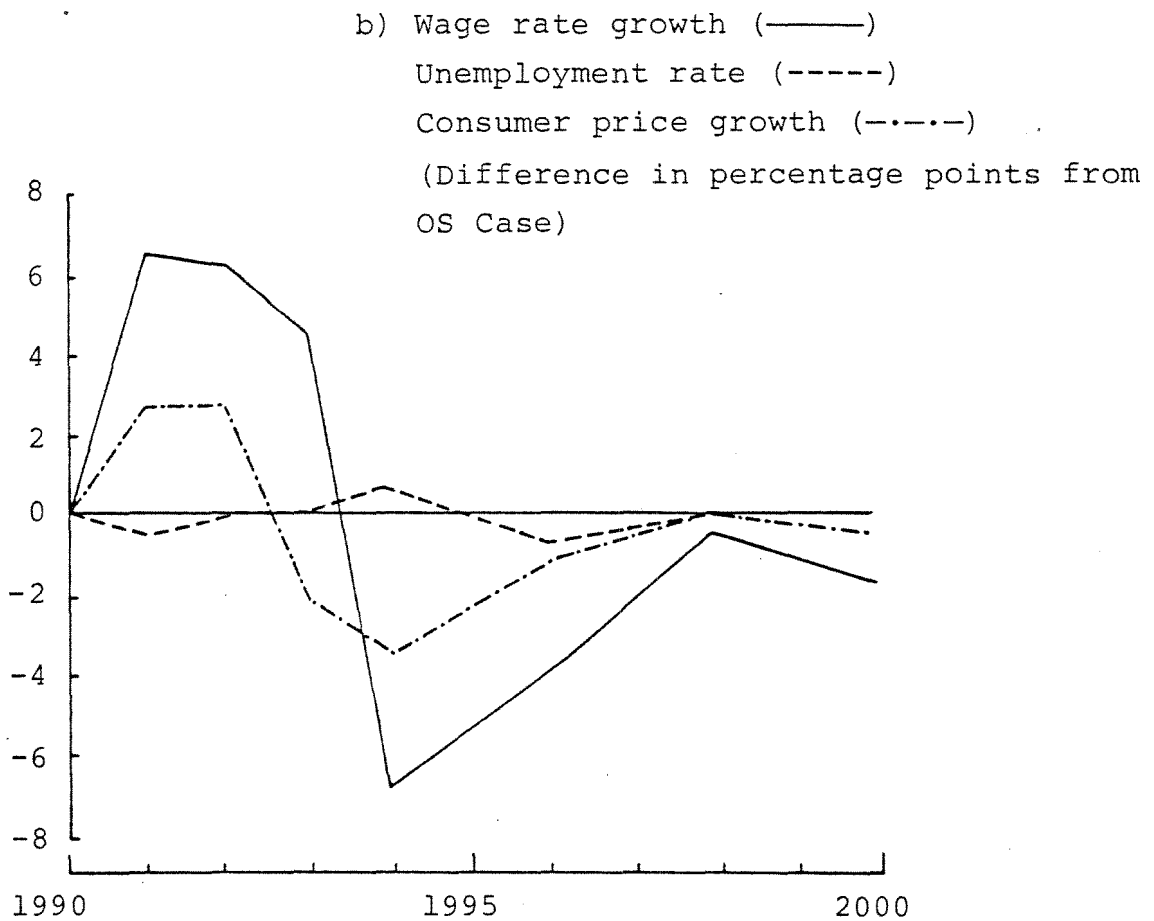
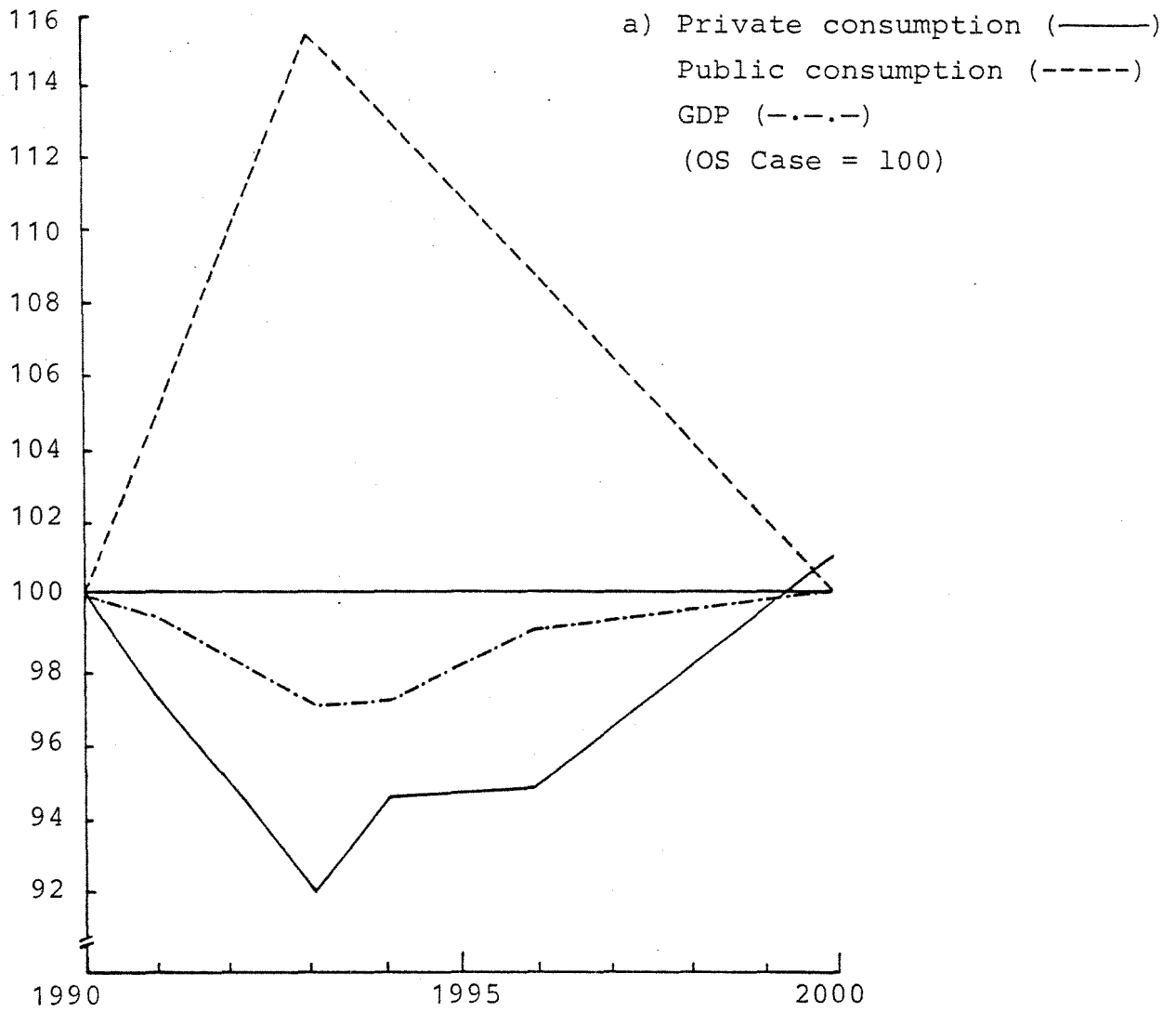

taxes must be raised to make room for the necessary export expansion. The tax raises will save imports through reduced private consumption and depress wages through increased unemployment. Lower wages in their turn increase net exports and improve the current account. As Figure 5.10 shows, private consumption need not be quite as contracted as in the MW case during 1990-1993. At the same time public consumption will be much lower and unemployment almost twice as large. Towards the end of the decade, the economy will again settle on a growth path close to the unrestricted OS case. Real wages will decline during 1990-1993 although not so fast as in the OS case, as shown in Figure 5.10b.

In our final experiment, the MR case, we add, on top of all the preceding policy restrictions, the political prescription that real wages should not be allowed to fall. Strictly speaking this is not a policy restriction in the model but rather an ad hoc restriction on one (or several) of its behavioral equations. Nevertheless we believe that the effects of such a lower bound on real wage rate growth is of great interest, whether it is imposed by central policy makers or by the parties on the labor market. This restriction will reduce the effects of raised taxes on the balance of payments. The resulting unemployment cannot fully exert its downward pressure on wages. Thus the net export expansion that comes from improved competitiveness will be weaker, and it will be left to the income effect on imports to ascertain a balanced current account. This will call for a larger reduction in private consumption and in total demand than in the MP case, as seen in Figure 5.11. Unemployment will exceed 5 % in 1992 - almost twice the level in the OS case.

Figure 5.10 Minus public consumption (MP)

a) Private consumption (—)
GDP (-.-.-)
(OS Case = 100)

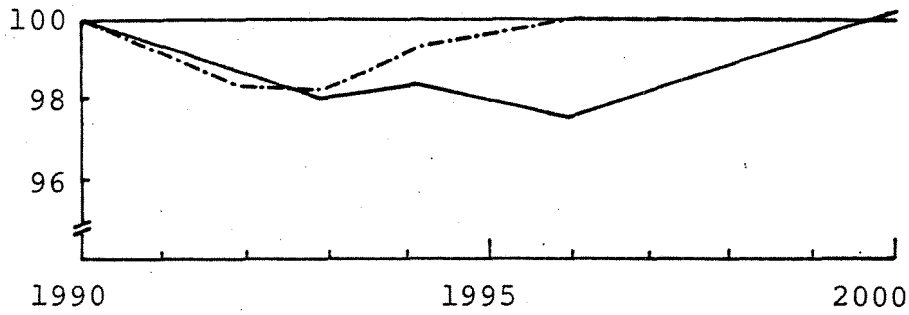

b) Wage rate growth (—)
Unemployment rate (-----)
Consumer price growth (-.-.-)
(Difference in percentage points from OS Case)

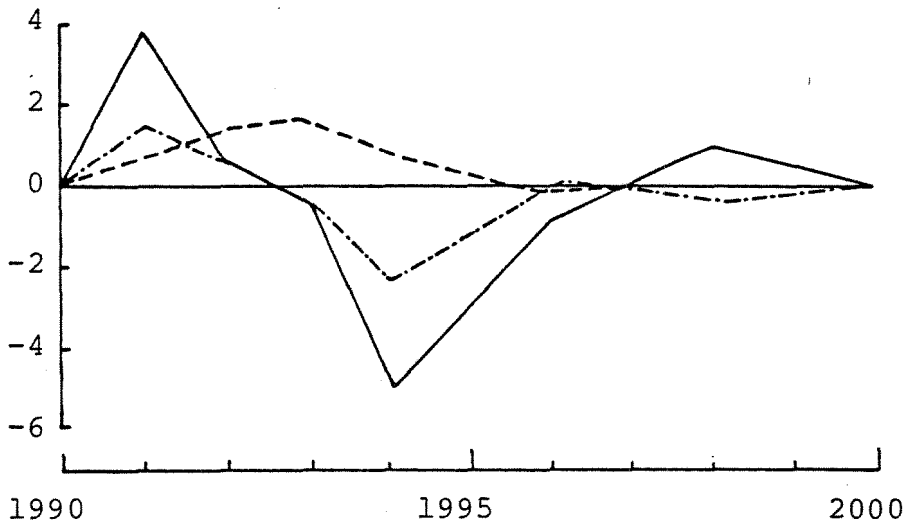
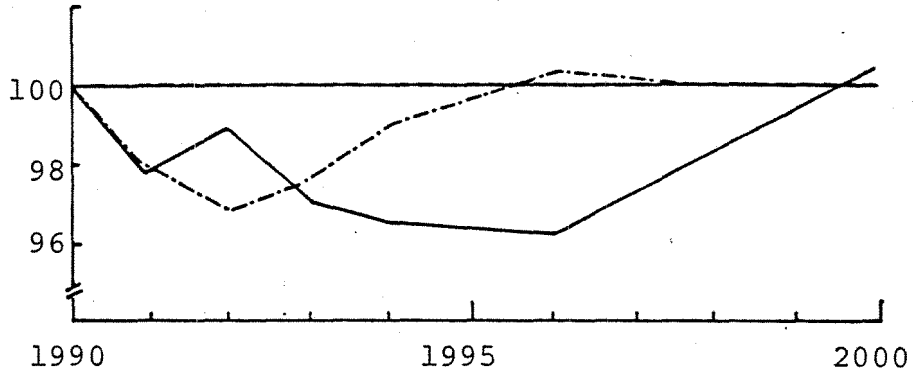
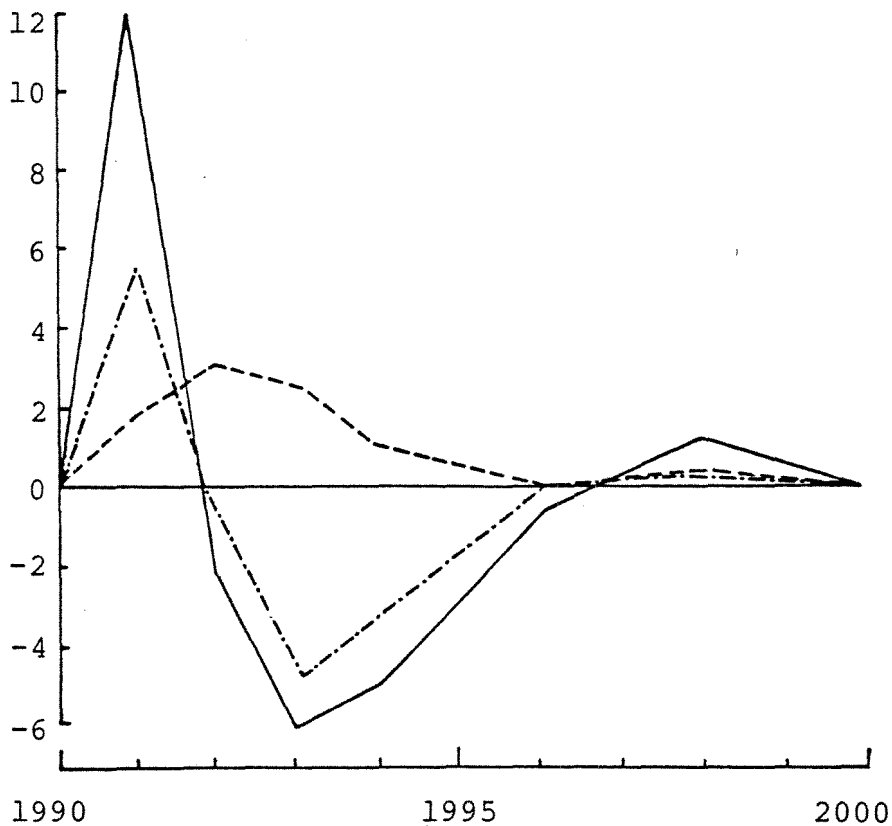

Figure 5.11 Minus real wage adjustment (MR)

- a) Private consumption (——)
- Public consumption (-----)
- GNP (-.-.-.-)
- (OS Case = 100)



- b) Wage rate growth (——)
- Unemployment rate (-----)
- Consumer price growth (-.-.-.-)
- (Difference in percentage points from OS Case)



6 THE USE OF AN OIL TAX AS INSURANCE

There are many alternative ways in which you can try to insure against the adverse effects of an "oil crisis". Some ways were indeed already suggested above, e.g. improving counter-cyclical measures and preparing for sharp changes in fiscal policy. Another natural suggestion is to force domestic producers and consumers to adjust gradually to an anticipated long term rise in oil price. This could merely mean promoting flexibility in investments involving the use of energy and persuading, by the use of some "indicative planning", investors to tailor their investments to fit expectations of higher future oil prices. As we suggested in our introductory discussion, there may, however, be good reasons for the government to go a step further and extend some kind of guarantee for a slowly rising domestic oil price, both as a way of reducing total risk and as a form of risk-pooling. This can be done in many ways. The example we have chosen to illustrate in our simulation is a rough sort of "oil price insurance" - a cumulative oil tax. The use of increased domestic oil taxation as a means of accelerating energy saving and the use of substitute fuels is a dominant theme in the current Swedish discussion on energy policy.

The oil tax we study has a very simple construction. It is successively stepped-up during the eighties, annually adding an extra oil price increase to domestic consumers, so that by the beginning of 1991 it has raised the oil price altogether 54 percent above international levels - the same as the assumed size of an eventual oil price hike.

If the oil crisis materializes - the TOS case - the tax is used as a buffer, the lifting off of the tax neutralizing the raised import price. We then measure the "benefits" by comparing the resulting

development during the nineties with the "uninsured" case OS, assuming the same access to economic policy instruments. If the oil crisis does not come - the TREF case - the oil tax however remains, causing some retardation in growth etc. during the following decade. Simulation experiments show that a major part of these adverse effects could be eliminated if the tax e.g. was successively lifted off during the nineties, ensuring a return to international price levels at the turn of the century. To assume that uncertainty about oil price development should suddenly end in 1991 seems however not only arbitrary but also hard to interpret. The cost of the tax "insurance" is evaluated by comparing with the outcome in the reference case, which, apart from the tax, rests on identical presumptions.

It should perhaps be emphasized that we have chosen this particular tax construction more out of analytical convenience than for its merits as a concrete proposal. The oil tax in our simulation does have the disadvantage of driving up the domestic oil price to a level in 1990 that may be attained in the international markets only 20-30 years later. A more realistic proposal would perhaps be to align the guaranteed rate of increase of domestic oil price with the anticipated long term price trend so as to make the expected level of international and domestic oil price at the turn of the century roughly the same. It may also turn out to be impossible for fiscal reasons to make the guarantee absolute. A compromise solution could be to limit the fiscal "risk" to the amount of oil tax, thus setting an absolute floor for the oil price development, insuring effectively against a price slump, but only alleviating the problems for the individual investor raised by a major price hike.

Since our simulations could anyhow only provide an example and never hope to give a proper evaluation of more flexible schemes and proposals, we have chosen the rather extreme case where a full guarantee will work even in the face of a major price hike without involving net subsidies.

The Cost of an Oil Tax

The oil tax is assumed to affect the price of oil to all consumers at an equal rate, i.e. their buying prices will increase at the same rate compared to the reference case. This will introduce an increasing price differential on the domestic market during the eighties between oil and other primary energy sources as shown in Figure 6.1. In real terms the oil prices paid by consumers will rise steeply while prices of domestically produced fuels will even decline somewhat due to a favorable productivity development as the scale of production increases. This will induce substitution away from oil to a greater extent than in the reference case.

The reduced use of oil will mitigate the inflationary impact of the oil tax but will not eliminate it. Without compensatory economic policy, the oil tax will affect total demand and employment in two ways. To begin with it will raise consumer prices and reduce real disposable income compared to the reference case. Also the industrial sector's international competitiveness will be adversely affected by increased energy costs. The result will be loss of market shares both on foreign and domestic markets. The development through the eighties is given in Figure 6.2. At the end of the decade real private consumption expenditures will be almost 3 % below the reference case level. Total exports will be down 2 %.

The weak export demand will however not bring about a deficit on current account. As shown in Figure 6.2b the external balance will actually improve. There are two reasons for this. Firstly, the substitution away from oil will considerably reduce the cost of imported energy although some oil will be replaced by coal. The savings on import costs will amount to more than 2 % of the total import bill in 1990. Secondly the deflated private consumption volume will further depress the import need. These two effects combined will prevail over the deteriorated competitiveness in Swedish industry, due to higher oil costs, and lead to an improvement in the balance of payment.

Figure 6.1 Real Prices of Primary Fuels

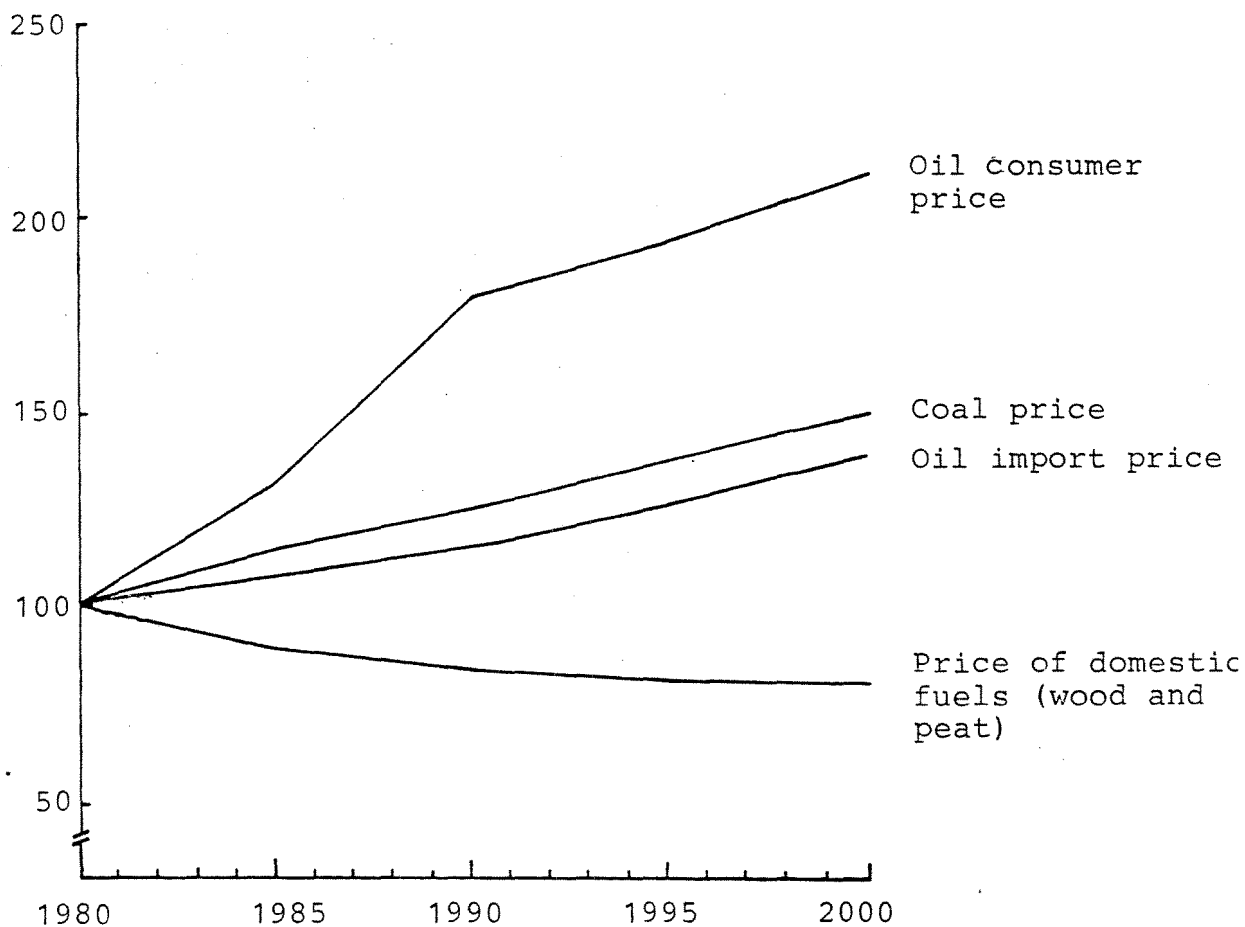

Note: Nominal prices are deflated by the world market price for finished goods. The real price in 1980 is set equal to 100.0 for all fuels.

Figure 6.2 Macroeconomic Effects of an Oil Tax
without Compensatory Economic Effects

a) Private Consumption (———)
Export (-----)
(Reference Case = 100)

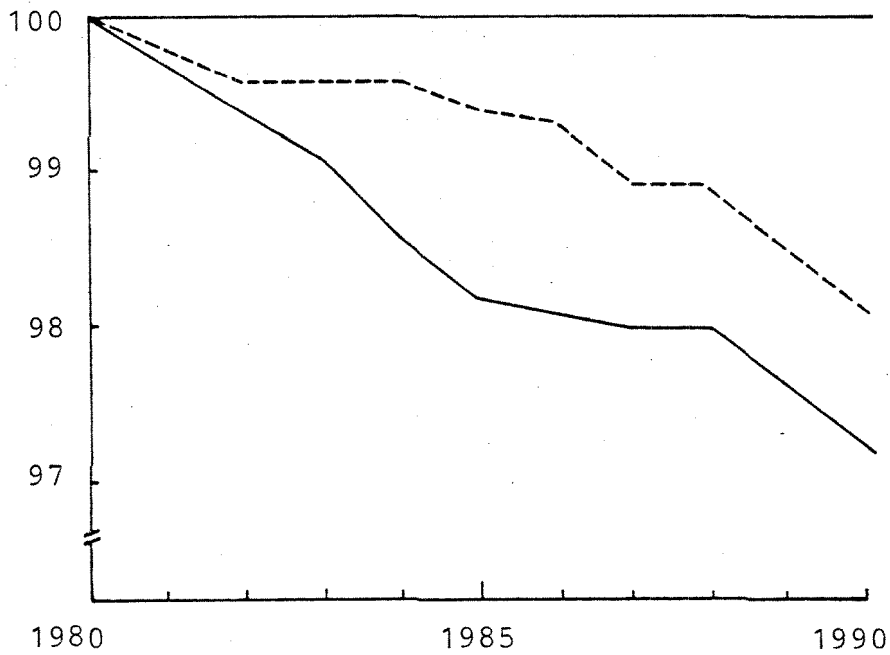

b) Unemployment (———, Left hand scale)
Balance of Payment as Percentage of
GDP (-----, Right hand scale)
(Reference Case = 0.0)

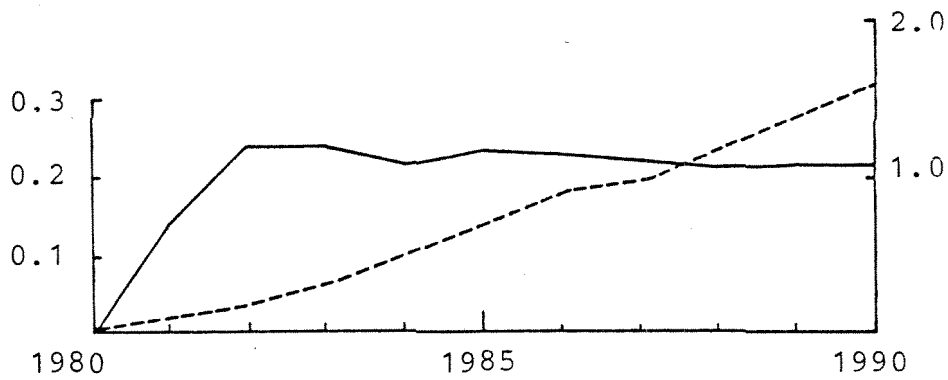

Unemployment will rise somewhat due to reduced demand and at the end of the decade there will be unused resources as well as an external surplus due to the oil tax imposed. This implies that there is room for a more "expansionary" economic policy during the decade, than was carried out in the reference case. It turns out that it is possible to attain full employment and balance on current account by a reduction of income taxes if the long term wage trend is simultaneously adjusted somewhat downwards. The outcome of such a policy change is described in Figure 6.3. From the second half of the eighties and throughout the rest of the simulation period the level of private consumption consistent with full employment and external balance will be almost one percent higher if the oil tax is introduced.¹

Total production in the economy will as expected respond negatively to the oil tax even with compensatory policies being pursued. This is due to substitution effects reducing labor productivity with rising energy prices. The decline in full employment GDP will continue throughout the simulation period due to the gradual introduction of less labor saving technologies compared to the reference case. This reduced production volume, however, permits a higher consumption level, since the export required to balance external transactions is almost 4 % lower than in the reference case. Again this is possible only because of the improved terms-of-trade of the economy, which will accompany the substitution away from imported oil. Terms-of-trade - the export price index divided by the import price index - in 1990 is almost 3 % higher in the oil tax case than in the reference case. Ceteris paribus this would allow for a redistribution of 3 % of the volume of foreign trade to domestic uses. With the large foreign sector of the Swedish economy this is a sizable share of domestic use. It will however to a large extent be offset by the negative productivity effects and increased energy-related investments.

¹ As stated above the tax rate will increase gradually during the eighties to reach 54 % in 1990 and remain on that level for the rest of the period.

Figure 6.3 Macroeconomic Effects of an Oil Tax with
Compensatory Economic Policy (TREF)

Private Consumption (—)
Exports (-----)
GDP (-·-·-·-)
(Reference Case = 100)

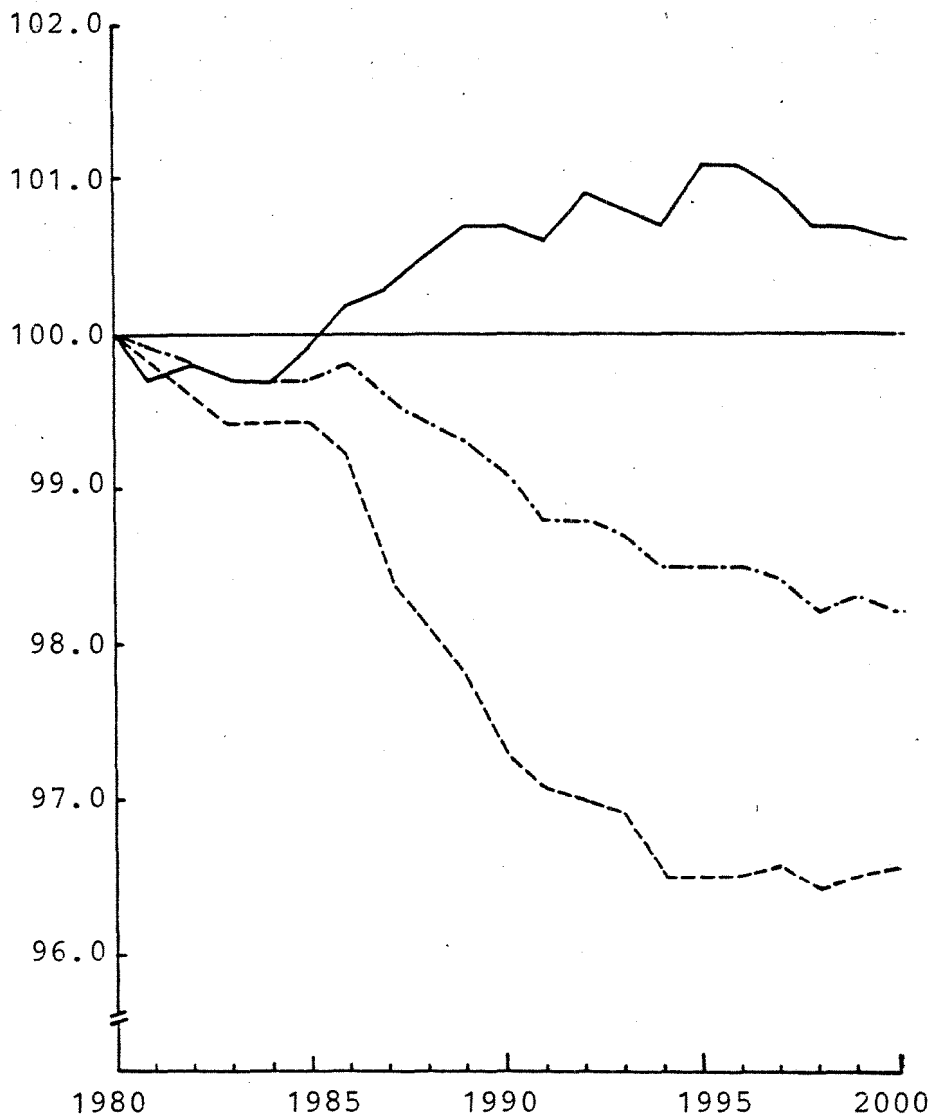

Fixed price GDP for the tax- and non-tax cases are compared in Table 6.1. The loss in productivity does not completely wipe out the positive terms-of-trade effect associated with the oil tax. The lower overall production volume will also somewhat reduce the required investments although the total investment ratio will rise as a consequence of increased energy related investments in the oil tax case.

It is obvious already from the figures given that the factors affecting the consumption difference are nicely balanced. One should therefore be cautious in drawing conclusions from the actual outcome of the simulation examples. The most we can say is that the expected negative growth effects of the oil tax are more or less neutralized by other factors notably the effects on terms-of-trade of increased economizing in the use of oil. If it is easy and cheap to substitute oil by e.g. domestic fuels, the cost of the oil tax in terms of reduced productivity and increased energy investments will be small and the net effect on private consumption is likely to be positive. The same holds if the price responsiveness of foreign markets to Swedish exports is small. In that case a large oil import is "expensive" since it requires large cuts in relative export prices - or worse terms-of-trade in equilibrium - to make sure of the markets needed to pay for the oil. Reduced oil import will thus give rise to sizable improvements in terms-of-trade.

The energy consumption pattern emerging from the oil tax simulation is shown in Figure 6.4. Compared to the reference case the savings of oil are considerable. The consumption level will be 75 % of the reference case level in 1990. By the year 2000 oil use will have fallen almost another 25 percentage points relative to the reference case, due to lagged responses to the rising relative oil price. As can be seen from the GDP-curve the declining oil use is not explained by a lower economic growth rate. To some extent it is caused by a larger reduction in total energy use than in GDP compared to the reference case. The lion's share of the oil saving, however, is accomplished by substitution

Table 6.1 **GDP by expenditure,**
(billions of SEK in 1975 fixed prices)

	Reference case			Oil tax case minus reference case	
	1980	1990	2000	1990	2000
Private consumption	164.4	185.9	238.8	+1.3	+1.4
Gross investments	60.5	74.9	92.6	-0.4	-1.4
Export	104.3	163.8	238.4	-4.4	-8.1
Import	97.3	129.9	198.4	+0.2	+0.6
GDP ^a	322.0	396.8	496.5	-3.7	-8.7

^a Expenditure items will not sum to GDP since those that do not differ between the two cases are excluded.

with other types of energy. In our oil tax simulation oil use is 120 TWh lower in 2000 than in the reference case. 50 % of this gap is filled by coal, 20 % by domestic fuels (wood and peat) and the rest by what is usually called savings, i.e. substitution with other factors of production and changes in the composition of consumption of goods and services.

Effects of an Oil Tax Compared to an Import Price Increase

The oil price on the domestic market is determined by the import price and oil taxes. We saw earlier that the economy as a whole may benefit from an oil tax due to savings on import expenditures. If the domestic oil price increase was caused instead by rising prices on the world market, oil savings would take place to the same extent. However, terms-of-trade would then deteriorate, thereby shrinking the room for domestic private and public consumption if external balance is to be maintained.

Figure 6.4 Energy Consumption in the Oil Tax Case
(Reference Case = 100)

Oil Consumption (———)
Energy Consumption (-----)
GDP (-·-·-)

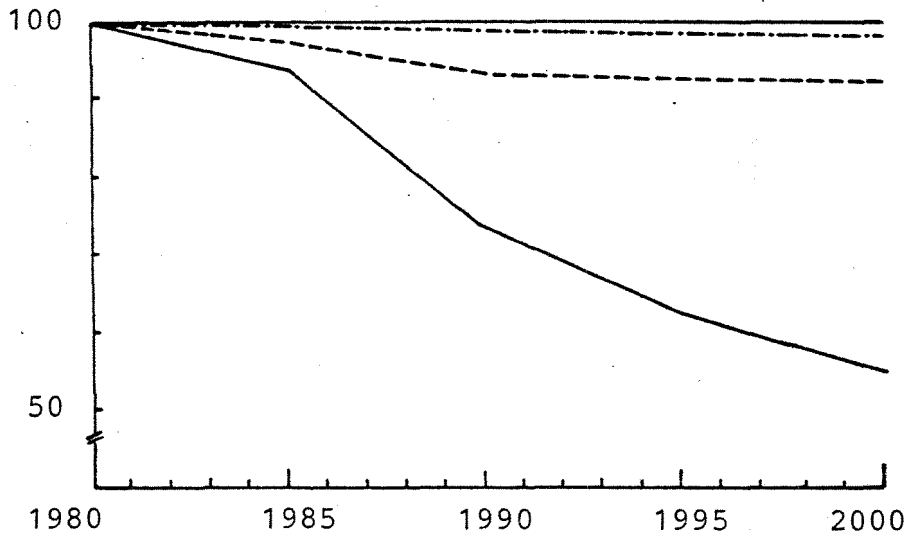

The result of a simulation where oil import prices are raised to establish the same domestic oil price as in the oil tax case is shown in Figure 6.5.¹ Although there will be oil savings they will not be large enough to prevent a substantial loss in the economy's terms-of-trade during the eighties. This loss emanates from two sources. First there is the impact of the oil price on import prices. Secondly, there will also be a need to lower relative export prices to gain market shares abroad to pay the increased oil bill. This is done in the simulation by adjusting wage increases. Export volumes will then become higher than in the oil tax case, but at the same time export prices, and hence terms-of-trade, will be lower. The result is a level of private consumption during the nineties which is about 7 percent lower than in the oil tax case.

If, however, we compare instead the gradually rising import price case with a sudden oil price hike, the big advantage of a gradual price rise is of course the absence of stabilization problems and the ensuing political strains. A gradual rise will also be anticipated and planned for, and will therefore avoid the costs of misguided investments that are incurred by a sudden and unanticipated price jump.

The Benefits of an Oil Tax

The cost of an oil tax, in terms of consumption forgone, does not seem very frightening. On the other hand one would expect the benefits to be substantial if an oil crisis occurs. The reason is twofold. First the oil dependence of the economy will be much less. Hence the penetration of an oil price hike will be less severe. Second, if the oil tax is used as a buffer, the inflationary impulse may be contained, reducing the risk of a self-sustained

¹ This simulation is very much like the one discussed in the beginning of the previous chapter. However, in that case coal prices were as usual assumed to follow oil prices on the world market. To show only the "partial" oil tax-import price difference we here let coal prices remain unaffected.

Figure 6.5 Oil Tax vs Oil Import Price Increase
(Oil Tax Case = 100.0)

Private Consumption (—)

Exports (-----)

Terms-of-trade (-.-.-.-)

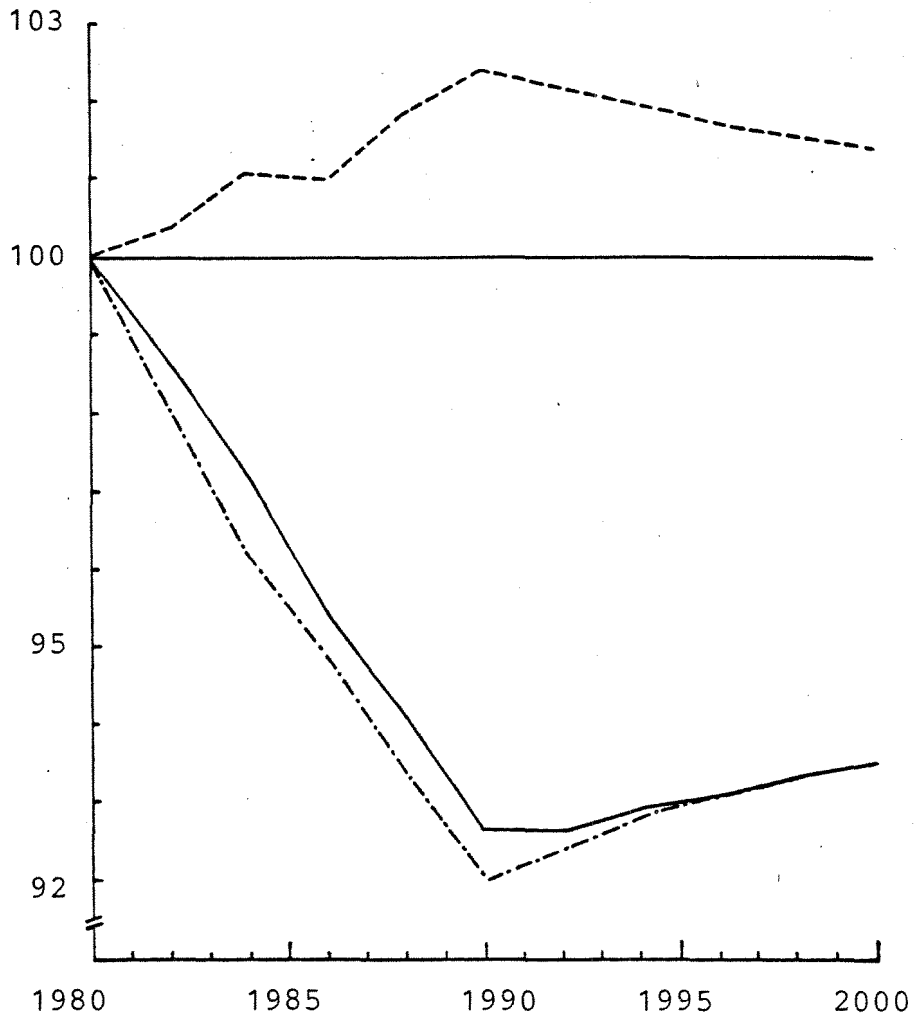

wage-price spiral in the aftermath of the oil price hike. This will greatly facilitate the conduct of economic policy since adjustments in terms of wages and taxes need not be quite so drastic.

How domestic oil price develops in the price hike case when oil is taxed and when it is not, is measured in Table 6.2. We see that the price increase felt by consumers during the crisis year 1991 is considerably less in the oil tax case, when the tax is used as a price buffer. Of importance to the stabilization problems that will follow in the wake of the crises, is the reduced oil dependence of the economy. Measured as percentage of GDP (at factor cost) the oil import bill in the non tax case is 7.0 in 1990 but only 6.1 when the extra oil tax is imposed during the eighties.¹ Furthermore, due to the forced export drive, necessary to pay for higher oil imports in the non tax case, the economy will be more vulnerable to a slow world trade growth during a crisis. The oil tax will thus reduce the exposure of the economy to world market disturbances on the import as well as on the export side.

Table 6.2 **Oil prices paid by consumers in the oil crises case.**
(Average annual growth rate)

	1989/1990	1990/1991	1991/2000
Oil tax case	12.8	8.0	8.0
Non tax case	8.0	66.3	8.0

¹ The use of primary oil energy in 1990 is reduced by 26 % in the oil tax case. The oil import bill, however, is reduced by only 15 %. The difference is explained by a shift towards more refined products in the total oil import along with a general shift towards more refined products. With a more detailed treatment of the domestic refinery sector in the model, likely shifts in the composition of oil imports could of course have been incorporated into the calculations.

The implications for stabilization policy of the oil tax is illustrated in Figure 6.6. To regain full employment and external balance by 1993 a very harsh policy is needed in the non tax case as already described in the previous chapter. Real wages must fall by 2 % a year instead of the 3 % growth that is possible in the undisturbed (reference) case. In 1991, according to the model, even nominal wages will have to fall - despite a 9 % growth in consumer prices - to accomplish the necessary accommodation. Taxes must be raised to depress private consumption and to make room for the export expansion and import substitution.

By comparison the strains imposed by the crises in the oil tax case seem more manageable. Real wages may in fact still grow during the adjustment period. The private consumption share of GDP will fall drastically during the crisis with or without oil taxes. In the latter case, however, this fall is accompanied by a slow GDP growth, making the consumption level fall by 5.5 percent during 1991 and 1992. In the oil tax case unemployment will be more easily contained and GDP growth will be higher. The fall in consumption level will therefore be limited to 3.5 percent during 1991 and 1992.

During the latter part of the nineties the differences between the tax and non tax cases in consumption levels, real wage growth etc. will even out. This is simply due to the construction of the simulation examples. We have assumed that balance in the economy is attained by 1993 and have compared the necessary measures. However the value of the oil tax may also be estimated in terms of the risk of having the economy go out of control and the welfare losses this could imply. If - in the non tax case - stabilization policy fails and we get a persistently high inflation and, after some years, increasing unemployment, how would e.g. the level of private consumption compare to a balanced oil tax case? Our experiences of oil crises have indicated that these losses may be severe. However, to construct such cases for the nineties might stretch the capacity of the model and the imagination of the reader a bit too far.

Figure 6.6 Oil Tax with Oil Price Hike -
Consequences for Stabilization Policy

Reference Case (——)

Oil Crisis without Oil Tax (-----)

Oil Crisis with Oil Tax (-.-.-.-)

a) Wage Policy: Real Wage Rate Level
(Reference Case = 100)

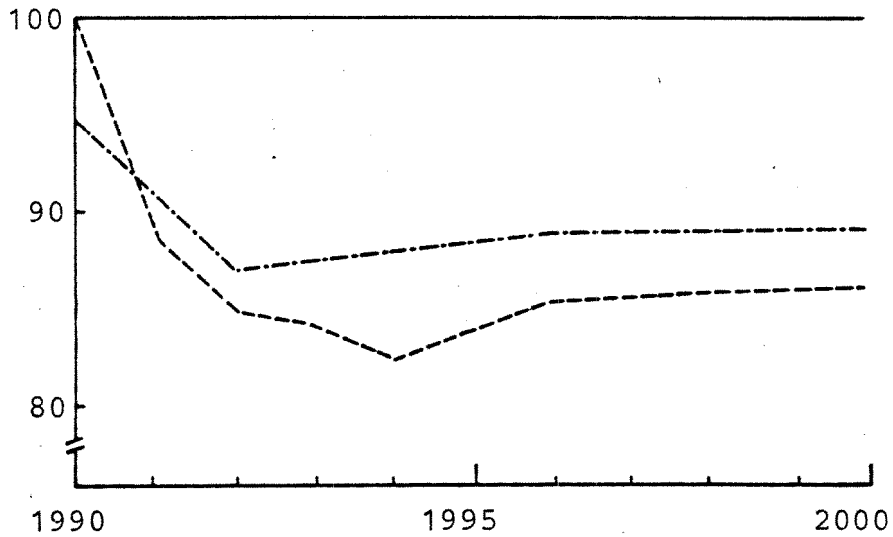

b) Tax Policy: Real Private Consumption
Share of GDP (percent)

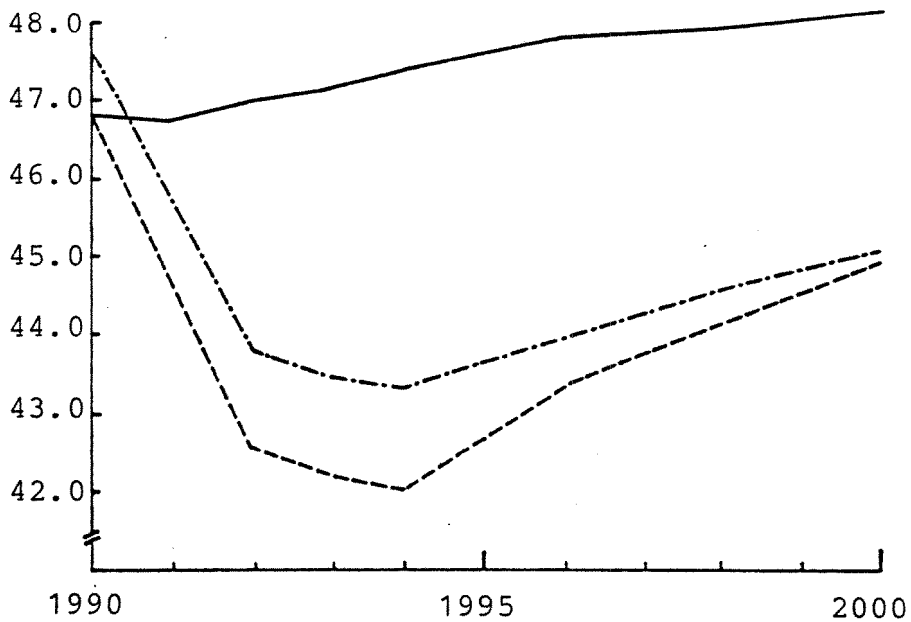

7 CONCLUSIONS

This study starts out from the assertion that instability and price uncertainty in the oil markets is one of the main problems confronting - and indeed calling forth - energy policy.

The first part of the study is devoted to tracing the impact of a representative oil price hike on the Swedish economy. Our simulation experiments yielded i.a. the following conclusions.

1. The long-term development of oil prices are indeed an important determinant of the rate of growth of the Swedish economy. Stagnating real prices up to the turn of the century may, as shown in the simulations, add a half percent of annual growth, compared to the case with a slowly rising (1.5 %/annum) oil price.
2. Even more important is the instability of the oil market. Judging both from the experiences of the 70s and from simulation results, the size of the indirect effects of an oil price hike via world market repercussions may be half or more of that of the direct impact on the economy.
3. An "oil crisis" is for Sweden to a large extent a problem of economic stabilization. What makes an unexpected oil price hike so much more dangerous than a correspondingly large but gradual price rise, is the risk of not being able to cope with these problems. A fast but efficient adjustment of domestic policies can reduce the welfare losses considerably.
4. The chances of coping efficiently with the stabilization problems can be shown to depend critically on the flexibility of available policies. The more the government is tied down by various commitments, which limit the use of policy instruments, the more extreme - and therefore the less likely - will the required policy changes be.

The second part of the study deals with possible policy devices aimed at reducing and sharing oil price risks. Our experiments with a government price guarantee supported by a cumulative oil tax used as price buffer, indicated i.a. the following.

5. The cost of such an oil tax in the case when no oil price hike occurs may be smaller than commonly supposed and could even turn out as a net profit. With appropriate policy changes the ensuing gains of terms-of-trade may be large enough to more than offset the deterioration of international competitiveness. We will however enter the next century with a smaller industrial capacity.

6. The "benefits" of smoothing the domestic oil price development, when a major oil price hike occurs, is considerable and due both to the enforced increase in total oil saving and to the pooling of price risks. The chances of efficiently dealing with the stabilization problem of an oil crisis are enhanced substantially by the early introduction of an oil tax and an oil price guarantee.

It should again be stressed that we have not been able in this simulation study to treat the general problem of oil price instability and price stabilization. The simulation results are more like a point estimate of a stylized and rather extreme case. We do think however that the results indicate fairly well both the mechanisms and the magnitudes involved and allow for some general conclusions to be drawn as to the desirable direction for future energy policy.

REFERENCES

- Bhandari, J. and Putnam, B (eds.), 1982, The International Transmission of Economic Disturbances Under Flexible Exchange Rates, MIT Press, Cambridge, Mass.
- Berndt, E.R. and Wood, D.O., "Technology, Prices and the Derived Demand for Energy", Review of Economics and Statistics, August, Vol. 57, No. 2, pp. 259-268, 1975.
- Berndt, E.R., Fuss, M.A. and Waverman, L., A Dynamic Model of Costs of Adjustment and Interrelated Factor Demands. With an Empirical Application to Energy Demand in U.S. Manufacturing, Working Paper No. 7925, Institute for Policy Analysis, University of Toronto, Toronto, Canada, November, 1979.
- Berndt, E.R. and Khaled, M.S., "Parameter Productivity Measurement and Choice Among Flexible Functional Forms", Journal of Political Economics, Vol. 81, No. 6, pp. 1220-1245, 1979.
- Berndt, E.R. and Field, B.C., Modeling and Measuring Natural Resource Substitution, The MIT Press, 1981.
- Borch, K.H., The Economics of Uncertainty, Princeton, 1968.
- Carling, A., Björk, O. och Kjellman, S., Internationella Energi-marknader - Prognosmetoder och Framtidsbedömningar. (International Energy Markets - Forecasting Methods and Future Assessments), IUI, 1979.
- Dargay, J., The Demand for Energy in Swedish Manufacturing, in Ysander, B.-C. (ed.), Energy in Swedish Manufacturing, IUI, 1983.
- Dargay, J., Energy Usage and Energy Prices in Swedish Manufacturing, in Ysander, B.-C. (ed), Energy in Swedish Manufacturing, IUI, 1983.
- Dargay, J. - Lundin, A., Hushållens Energiefterfrågan - Empiriska Studier för Sverige, Forskningsgruppen för Energisystemstudier, FFE-rapport nr 14, Stockholm, 1978.

- Eliasson, G. - Sharefkin, M. - Ysander, B.-C., (eds.), Policy Making in a Disorderly World Economy, IUI, 1983.
- Eliasson, G. - Sharefkin, M. - Ysander, B.-C., "Stability and Macroeconomic Policy - the Lesson of the 1970s", in Eliasson, G. - Sharefkin, M. - Ysander, B.-C., (eds.), Policy Making in a Disorderly World Economy, IUI, 1983.
- Energy Policy Modeling: United States and Canadian Experiences. Specialized Energy Policy Models, Volume I, (eds. Ziemba, W.T. - Schwartz, S.L. - Koenigsberg, E.), Martinus Nijhoff Publishing, 1981.
- Eng, T., Framtida energikriser - Hur kan de uppkomma? Hur påverkas världsekonomin? Hur sårbart är Sverige? - En studie av krisscenarier för tiden fram till år 2000. (Future Energy Crises - Their Possible Causes and their Impacts on World Economy and on the Swedish Economy. A Study of Scenarios up to the Year 2000). Research Report No. 14, IUI, 1982.
- Giavazzi, F., Odekon, M. and Wyplosz, C., (1982), "Simulating an Oil Shock With Sticky Prices", European Economic Review 18, No. 1/2.
- Gramlich, E.M., "Macro Policy Responses to Price Shocks", Brookings Papers on Economic Activity 1979, 125, The Brookings Institution, Washington, D.C.
- Hey, J.D., Economics in Disequilibrium, Robertson, Oxford, 1981.
- Jacobson, L. and Thurman, S., 1981, "Oil Price Indexing - Versus Large Price Shocks: Macroeconomic Impacts", International Finance Discussion Papers, No. 180, Federal Reserve Board, USA.
- Jansson, L. - Nordström, T. - Ysander, B.-C., The ISAC Model of the Swedish Economy - Structure, Implementation and Stability, Working Paper No. 64, IUI.
- Kahneman, D. and Tversky, A., "Prospect Theory: An Analysis of Decision Under Risk", Econometrica, Vol. 47, No. 2, 1979.
- Nordström, T. - Ysander, B.-C., Offentlig service och industriell tillväxt. Perspektivskisser av svensk ekonomisk utveckling 1950-2000. (Public Service and Industrial Growth - Alternative Paths of Development for the Swedish Economy 1950-2000). Research Report No. 11, IUI, 1980.

- Nordström, T. and Ysander, B.-C., Local Authorities, Economic Stability and the Efficiency of Fiscal Policy. Some Experimental Simulations for Sweden in the Eighties. Working Paper No. 44, IUI, 1981.
- Pindyck, R.S., "Interfuel Substitution and the Industrial Demand for Energy: An International Comparison", The Review of Economic and Statistics, May, Vol. LXI, No. 2, pp. 169-179, 1979.
- Prop. 1980/81:90, Riktlinjer för energipolitiken.
- Pyle, D.H. and Turnovsky, S.J., "Safety-first and expected utility maximization in mean-standard deviation portfolio analysis", Review of Economics and Statistics, Vol. 52, No. 1, 1970.
- Sarma, K.S., "An Examination of the Impact of Changes in the Prices of Fuels and Primary Metals on Nordic Countries Using a World Econometric Model", in Eliasson, G. - Sharefkin, M. - Ysander, B.-C., (eds.)' Policy Making in a Disorderly World Economy, IUI, 1983.
- Shackle, G.L.S., Imagination and the Nature of Choice, Edinburgh, 1979.
- Simon, H.A., "Rationality as process and as product of thought", American Economic Review, Vol. 68, No. 2, 1978.
- SIND 1980:17, Energi på 80-talet.
- SOU 1979:83, Om vi avvecklar kärnkraften.
- SOU 1982:16, Skatt på energi.
- Spence, M., Market Signalling, Harvard University Press, 1974.
- Steen, P. - Johansson, T. - Fredriksson, R. - Bogren, E., Energi - till vad och hur mycket? Stockholm 1981.
- Svensson, L.E.O., 1981, "Oil Prices and a Small Oil-importing Economy's Welfare and Trade Balance", Working Paper 1981:4, Department of Economics, University of Stockholm.
- Ysander, B.-C., "Oil Prices and Economic Stability - the Macroeconomic Impact of Oil Price Shocks in the Swedish Economy", in Eliasson, G. - Sharefkin, M. - Ysander, B.-C., (eds.)' Policy Making in a Disorderly World Economy, IUI, 1983.

- Ysander, B.-C. (ed.), Energy in Swedish Manufacturing, IUI, 1983.
- Östblom, G., Energianvändningen i Sverige 1965-1978, Forskningsgruppen för Energisystemstudier, FFE-rapport nr 4, 1980.

WORKING PAPERS (Missing numbers indicate publication elsewhere)

1976

1. Corporate and Personal Taxation and the Growing Firm
by Ulf Jakobsson
7. A Micro Macro Interactive Simulation Model of the Swedish Economy.
Preliminary model specification
by Gunnar Eliasson in collaboration with Gösta Olavi
8. Estimation and Analysis with a WDI Production Function
by Göran Eriksson, Ulf Jakobsson and Leif Jansson

1977

12. The Linear Expenditure System and Demand for Housing under Rent Control
by Per Högberg and N Anders Klevmarken
14. Rates of Depreciation of Human Capital Due to Nonuse
by Siv Gustafsson
15. Pay Differentials between Government and Private Sector Employees in Sweden
by Siv Gustafsson

1979

20. A Putty-Clay Model of Demand Uncertainty and Investment
by James W. Albrecht and Albert G. Hart

1980

25. On Unexplained Price Differences
by Bo Axell
26. The West European Steel Industry - Structure and Competitiveness in Historical Perspective
by Bo Carlsson
33. The Demand for Energy in Swedish Manufacturing
by Joyce M. Dargay
34. Imperfect Information Equilibrium, Existence, Configuration and Stability
by Bo Axell

1981

35. Value Added Tax: Experience in Sweden
by Göran Normann
36. Energi, stabilitet och tillväxt i svensk ekonomi (Energy,
Stability and Growth in the Swedish Economy)
by Bengt-Christer Ysander
37. Picking Winners or Bailing out Losers? A study of the
Swedish state holding company and its role in the new
Swedish industrial policy
by Gunnar Eliasson and Bengt-Christer Ysander
40. Wage Earners Funds and Rational Expectations
by Bo Axell
41. A Vintage Model for the Swedish Iron and Steel Industry
by Leif Jansson
43. An Econometric Model of Local Government and Budgeting
by Bengt-Christer Ysander
44. Local Authorities, Economic Stability and the Efficiency of
Fiscal Policy
by Tomas Nordström and Bengt-Christer Ysander
45. Growth, Exit and Entry of Firms
by Göran Eriksson
52. Swedish Export Performance 1963-1979. A Constant Market
Shares Analysis
by Eva Christina Horwitz
55. Arbetsmarknad och strukturomvandling i de nordiska
länderna
av Bertil Holmlund
56. Central Control of the Local Government Sector in Sweden
by Richard Murray
58. Industrial Subsidies in Sweden: Macro-economic Effects and
an International Comparison
by Bo Carlsson
59. Longitudinal Lessons from the Panel Study of Income
Dynamics
by Greg J. Duncan and James N. Morgan

1982

61. Var står den nationalekonomiska centralteorin idag?
av Bo Axell
63. General Search Market Equilibrium
by James W. Albrecht and Bo Axell
64. The Structure and Working of the Isac Model
by Leif Jansson, Thomas Nordström and Bengt-Christer
Ysander
65. Comparative Advantage and Development Policy Twenty
Years Later
by Anne O. Krueger
67. Computable Multi-Country Models of Production
and Trade
by James M. Henderson
68. Payroll Taxes and Wage Inflation: The Swedish Experiences
by Bertil Holmlund (Revised, September 1982).
69. Relative Competitiveness of Foreign Subsidiary Operations
of a Multinational Company 1962-77
by Anders Grufman
70. Optimization under nonlinear constraints
by Leif Jansson and Erik Mellander
71. Technology, Pricing and Investment in Telecommunications
by Tomas Pousette
72. The Micro Initialization of MOSES
by James W Albrecht and Thomas Lindberg
73. Measuring the Duration of Unemployment: A Note
by Anders Björklund
74. On the Optimal Rate of Structural Adjustment
by Gunnar Eliasson
75. The MOSES Manual
by Fredrik Bergholm
76. Differential patterns of Unemployment in Sweden
by Linda Leighton and Siv Gustafsson

77. Household Market and a Nonmarket Activities (HUS)
- A Pilot Study
by Anders Klevmarcken
78. Arbetslöshetsersättningen i Sverige
- motiv, regler och effekter
av Anders Björklund och Bertil Holmlund

1983

79. Energy Prices, Industrial Structure and Choice of
Technology; An International Comparison with Special
Emphasis on the Cement Industry
by Bo Carlsson
80. Energy Usage and Energy Prices in Swedish Manufacturing
by Joyce Dargay
81. ELIAS - A Model of Multisectoral Economic Growth
in a Small Open Economy
82. Oil Prices and Economic Stability - Simulation
Experiments with a Macroeconomic Model
by Tomas Nordström and Bengt-Christer Ysander