

Martin, Antoine; McAndrews, James; Palida, Ali; Skeie, David

Working Paper

Federal reserve tools for managing rates and reserves

Staff Report, No. 642

Provided in Cooperation with:

Federal Reserve Bank of New York

Suggested Citation: Martin, Antoine; McAndrews, James; Palida, Ali; Skeie, David (2013) : Federal reserve tools for managing rates and reserves, Staff Report, No. 642, Federal Reserve Bank of New York, New York, NY

This Version is available at:

<https://hdl.handle.net/10419/93643>

Standard-Nutzungsbedingungen:

Die Dokumente auf EconStor dürfen zu eigenen wissenschaftlichen Zwecken und zum Privatgebrauch gespeichert und kopiert werden.

Sie dürfen die Dokumente nicht für öffentliche oder kommerzielle Zwecke vervielfältigen, öffentlich ausstellen, öffentlich zugänglich machen, vertreiben oder anderweitig nutzen.

Sofern die Verfasser die Dokumente unter Open-Content-Lizenzen (insbesondere CC-Lizenzen) zur Verfügung gestellt haben sollten, gelten abweichend von diesen Nutzungsbedingungen die in der dort genannten Lizenz gewährten Nutzungsrechte.

Terms of use:

Documents in EconStor may be saved and copied for your personal and scholarly purposes.

You are not to copy documents for public or commercial purposes, to exhibit the documents publicly, to make them publicly available on the internet, or to distribute or otherwise use the documents in public.

If the documents have been made available under an Open Content Licence (especially Creative Commons Licences), you may exercise further usage rights as specified in the indicated licence.

Federal Reserve Bank of New York
Staff Reports

Federal Reserve Tools for Managing Rates and Reserves

Antoine Martin
James McAndrews
Ali Palida
David Skeie

Staff Report No. 642
September 2013



This paper presents preliminary findings and is being distributed to economists and other interested readers solely to stimulate discussion and elicit comments. The views expressed in this paper are those of the authors and are not necessarily reflective of views at the Federal Reserve Bank of New York or the Federal Reserve System. Any errors or omissions are the responsibility of the authors.

Federal Reserve Tools for Managing Rates and Reserves

Antoine Martin, James McAndrews, Ali Palida, and David Skeie

Federal Reserve Bank of New York Staff Reports, no. 642

September 2013

JEL classification: E42, E43, G12, G20

Abstract

Monetary policy measures taken by the Federal Reserve as a response to the 2007-09 financial crisis and subsequent economic conditions led to a large increase in the level of outstanding reserves. The Federal Open Market Committee (FOMC) has a range of tools to control short-term market rates in this situation. We study several of these tools, namely, interest on excess reserves (IOER), reverse repurchase agreements (RRPs), and the term deposit facility (TDF). We find that overnight RRP (ON RRP) may provide a better floor on rates than term RRP because they are available to absorb daily liquidity shocks. Whether the TDF or RRP best support equilibrium rates depends on the intensity of interbank monitoring costs versus balance sheet costs, respectively, that banks face. In our model, using the RRP and TDF concurrently may most effectively stabilize short-term rates close to the IOER rate when such costs are rapidly increasing.

Key words: monetary policy, fixed-rate full allocation overnight reverse repurchases, term deposit facility, interest on excess reserves, FOMC, banking

Martin, McAndrews, Palida, Skeie: Federal Reserve Bank of New York (e-mail: antoine.martin@ny.frb.org, jamie.mcandrews@ny.frb.org, ali.palida@ny.frb.org, david.skeie@ny.frb.org). The authors thank Alex Bloedel for research assistance and seminar participants at the Federal Reserve Bank of New York and the Board of Governors for helpful comments. The views expressed in this paper are those of the authors and do not necessarily reflect the position of the Federal Reserve Bank of New York or the Federal Reserve System.

1 Introduction

This paper studies new monetary policy tools for managing short-term market rates. The tools we consider are interest on excess reserves (IOER), reverse repurchase agreements (RRPs) with a wide range of market participants, and the term deposit facility (TDF).

The Federal Reserve responded to the 2007-09 financial crisis and its aftermath with a wide range of monetary policy measures that dramatically increased the supply of reserves. In part, this has led the federal funds rate, and other money market interest rates, to be more variable than before the crisis. In October 2008, the Federal Reserve began paying IOER to depository institutions (DIs). Since then, money market rates have consistently remained below the IOER rate. In June of 2011, the Federal Open Market Committee (FOMC) announced a strategy for the possible use of new tools geared towards influencing short-term market interest rates and keeping them close to the IOER.² In August 2013, the FOMC also announced a fixed-rate, full-allotment overnight RRP (ON RRP) as one of these potential tools.³

IOER is paid to DIs holding reserve balances at the Federal Reserve.⁴ Term and ON RRP provide a wide range of bank and non-bank counterparties with the opportunity to make the economic equivalent of collateralized loans to the Federal Reserve. The TDF is a facility offered to DIs, who are eligible to earn interest on balances held in accounts at the Federal Reserve, that allows them to hold deposits for longer term for an interest rate generally exceeding the IOER. An institutional background and explanation of these tools is provided in Section 2.

We develop a general equilibrium model of banking and money markets to study how the Federal Reserve can manage short-term market rates and the large level of reserves on its balance sheet using these tools. Our model extends Martin, McAndrews, and Skeie (2013) (hereforth referred to as MMS) to include two separate banking sectors, randomized relocation liquidity shocks occurring in an interim period, and interbank lending frictions. The model provides a framework within which to study the effectiveness of IOER, the term and ON RRP and the TDF in supporting interest rates, and provides insight into the economic mechanisms that determine the equilibrium rates and quantities.

In our model, when banks are subject to balance sheet costs as in MMS, a withdrawal by depositors (caused by a "liquidity shock") must be redeposited in other

²Source: <http://www.federalreserve.gov/monetarypolicy/files/fomcminutes20110622.pdf>

³Source: <http://www.federalreserve.gov/newsevents/press/monetary/20130821a.htm>

⁴IOER differs from interest on reserves (IOR) in that IOER is paid to reserve holdings in excess of the reserve requirement.

banks.⁵ Those banks will react to the exogenous additional deposits and unplanned balance sheet expansion by lowering their deposit rates. Alternatively, households can hold government bonds, which would shield households from having to resort to short-term deposits with depressed rates, and thus deposits bear a liquidity-risk premium. In equilibrium, the liquidity shock leads to downward pressure on both deposit rates and government bond yields.

Liquidity shocks affect banks' asset returns as well. When a bank faces stochastic withdrawals by its depositors, liquid reserves serve as a buffer, allowing the bank to fund these withdrawals with accumulated reserves. However, when outstanding reserves are held in insufficient quantities, in equilibrium, a bank's funds are tied up in illiquid assets and limit the bank's ability to accommodate the withdrawal shock on its own. In this situation, the bank must resort to borrowing on an interbank market. When interbank lending frictions, such as monitoring costs, are present, the interbank loan rate increases, reflecting the costs of the frictions in interbank lending. When there is a positive probability of experiencing sufficiently large withdrawals, banks have a stronger incentive to hold their assets as liquid reserves, rather than tie them up in illiquid assets such as loans to firms. For illiquid assets to be held in positive amounts, they must earn a premium over reserve holdings in equilibrium.

The Federal Reserve has the ability to affect these spreads through its choice of the quantity of reserves in the banking system and the size and implementation of other central bank facilities that provide a broad array of tools for the Federal Reserve.

IOER is offered to banks. It influences deposit rates as it represents the riskless return on an invested deposit at the Federal Reserve. It also sets a short-term reservation rate in the interbank market at which banks should not lend below.

Federal Reserve RRP provide an additional investment source for an expanded set of intermediaries, such as money market mutual funds (MMFs). RRP can be used to raise rates by diverting deposits away from banks and into Federal Reserve RRP non-bank counterparties. This supports deposit rates by reducing banks' balance sheet size. Balance sheet size may be costly because of capital requirements, leverage ratios, FDIC deposit insurance assessments, and other balance sheet costs.

RRPs may be either fixed-rate, full-allotment or fixed-quantity, and may be term or overnight. Because the overnight rate reflects daily liquidity shocks, the fixed-rate, full-allotment ON RRP is the most effective facility for setting a fixed reservation rate for those intermediaries; term or fixed-quantity RRP cannot achieve the same level and stability of interest rates.

⁵For simplicity, we will refer to DIs as "banks" in our framework.

In comparison to the RRP, the TDF absorbs liquid reserves without reducing the size of bank liabilities and increases bank asset returns more directly. If RRP and the TDF are used in sufficiently large size, they can re-establish the interbank market by reducing the size of liquid reserves used to ward off liquidity shocks and can raise equilibrium bank asset returns. We find that utilizing both the TDF and the RRP together may support rates most effectively if both bank balance sheet costs and interbank lending frictions are large enough.

Our paper fits broadly into the existing literature on monetary policy implementation, IOER, and reserves. Poole (1970) shows that the effectiveness of an interest rate-change policy versus a money stock-change policy is not well determined and depends on parameter values, but a combination policy is always weakly superior to either of the two used alone. Ennis and Keister (2008) provide a general framework for understanding monetary policy implementation with IOER. They show that IOER can help implement a floor on market rates and allows the Federal Reserve to keep interest rates closer to target rates. MMS focuses on the effects of excess reserves on inflation, interest rates, and investment. They find that these parameters are largely independent of bank reserve holdings unless external frictions are present. Bech and Klee (2011) analyze the federal funds market in the presence excess reserves. They argue that since government-sponsored enterprises (GSEs) do not have access to IOER, they have lower bargaining power and trade at rates lower than IOER, thus resulting in the observed IOER-federal funds effective rate spread. Kashyap and Stein (2012) show that, with both IOER and reserve quantity control, the central bank can simultaneously maintain price stability and address externalities resulting from short-term debt issuance. The current paper is the first to analyze the additional Federal Reserve tools and their effectiveness in controlling short-term money market rates and managing Federal Reserve liabilities.

The paper is organized as follows: Section 2 explains institutional details on the Federal Reserve's monetary policy before, during, and after the 2007-09 financial crisis and provides descriptions of IOER, RRP and the TDF. Section 3 presents and solves the benchmark model. Section 4 incorporates the RRP and the TDF into the benchmark model and analyzes their equilibrium results and effectiveness. Section 5 concludes. Proofs of some propositions and all figures are in the Appendix.

2 Institutional Background

Prior to the financial crisis of 2007-2009, the Federal Reserve closely controlled the supply of reserves in the banking system through its open market operations (OMOs). In an OMO, the Federal Reserve buys or sells assets, either on a temporary basis (using repurchase agreements) or on a permanent basis (using outright transactions), to alter the amount of reserves held in the banking system.⁶ For example, purchasing Treasuries will increase the amount of reserves in the system.

By adjusting the supply of reserves in the system, the open market trading desk (the Desk) at the Federal Reserve Bank of New York (NY Fed) could influence the level of the federal funds rate, the rate at which DIs lend reserves to each other. DIs in the US are required to maintain a certain level of reserves, proportional to specified deposit holdings, which, in addition to precautionary demand for reserve balances, creates a demand curve for reserves. The interest rate at which the demand and the supply curves intersect increases when the Desk reduces the supply of reserves, for example.⁷ Through arbitrage, the level of the federal funds rate influences other short-term money markets rates.

In response to the 2007-09 financial crisis and subsequent economic downturn, monetary policy measures included large-scale lending to provide liquidity to financial institutions, and large-scale asset purchases through the large-scale asset purchase program (LSAP) to stimulate the economy by lowering longer term interest rates.⁸ This facilitated a very large increase in the supply of reserves.⁹ Moreover, in December 2008, the FOMC lowered the target federal funds rate to a range of 0 to 25 basis points, its effective zero bound, to help stimulate the economy.¹⁰

The effective federal funds rate, a weighted average of federal funds trades arranged by brokers, remained below 25 basis points, as shown in figure 1.¹¹ Figure 1 highlights that the federal funds rate fluctuated closely with other short-term money market rates, including the overnight Eurodollar rate and the overnight Treasury repo rate. These rates are seen to be typically decreasing in the level of reserves.

⁶ Assets eligible for OMOs are Treasuries, agency debt, and agency mortgage-backed securities (MBS).

⁷ See Ennis and Keister (2008) and Keister, and Martin, and McAndrews (2008) for a more detailed introduction to traditional Federal Reserve monetary policy and OMOs

⁸ The LSAPs are sometimes referred to as "quantitative easing" (QE)

⁹ See Gagon, Raskin, Remanche, and Sack (2010) for more information on the LSAPs.

¹⁰ Source: <http://www.federalreserve.gov/monetarypolicy/files/fomcminutes20081216.pdf>

¹¹ One common explanation for this is the current large presence of GSE lending in the federal funds market. GSEs are not eligible for IOER and tend to lend at rates below 25 basis points (see Beck and Klee (2011)).

See figure 1

In light of the LSAPs and the large expansion of the balance sheet, the Federal Reserve has been preparing a variety of tools to ensure that short-term rates can be raised when needed. IOER has been used as one of these tools since October 2008; however two of these tools, RRP with an extended range of counterparties, and the TDF, have not been implemented in large-value facilities as of yet. In a 2009 speech, NY Fed President William Dudley, referred to the RRP and the TDF as the “suspenders” that will support IOER, i.e. the “belt,” in allowing the Federal Reserve “retain control of monetary policy.”¹² In August 2013, the FOMC announced potential use of an additional tool, the ON fixed-rate, full-allotment RRP.

2.1 Interest on Excess Reserves

To manage short-term rates in the face of large excess reserves, the Federal Reserve began to pay DIs IOER in October 2008. IOER differs from interest on reserves (IOR) in that IOER is paid to reserve holdings in excess of the reserve requirement. The Financial Services Regulatory Relief Act of 2006 originally granted the Federal Reserve the ability offer IOER. However, the original authorization was only applicable to balances held by DIs starting October 2011. The Emergency Economic Stabilization Act of 2008 accelerated the start date to October 2008.¹³

The interest owed to a balance holder is computed over a maintenance period, typically lasting one to two weeks depending on the size of the DI. Interest payments are typically credited to the holder’s account about 15 days after the close of a maintenance period.¹⁴ IOER was first offered in October of 2008 at 75 basis points, but is currently at 25 basis points where it has been since December 2008. Institutions that are not DIs are not eligible to earn IOER.¹⁵

2.2 Reverse Repurchase Agreements

An RRP is economically equivalent to a collateralized loan made to the Federal Reserve by a financial institution. RRP have historically been used, though somewhat

¹²Source:<http://www.newyorkfed.org/newsevents/speeches/2009/dud090729.html>

¹³Source:<http://www.federalreserve.gov/newsevents/press/monetary/20081006a.htm>

¹⁴Source:<http://www.federalreserve.gov/newsevents/press/monetary/monetary20081006a2.pdf>

¹⁵Source:<http://www.federalreserve.gov/newsevents/press/monetary/20081006a.htm>

infrequently, by the Federal Reserve in the conduct of monetary policy, arranged with a set of counterparties called “primary dealers.”¹⁶

In October 2009, the Federal Reserve announced that it was considering offering RRP on a larger scale to an expanded set of counterparties.¹⁷ The expanded set of counterparties include DIs as well as non-DIs, such as MMFs, GSEs, and dealers, increasing both the number and the type of Federal Reserve counterparties.¹⁸ In addition, in August 2013 the Federal Reserve announced it would further study the potential for adopting a fixed-rate, full-allotment ON RRP facility.¹⁹ In his September 2013 speech, President Dudley discussed this new facility as a way to support money market rates by allowing counterparties a flexible amount of investment at a fixed rate when needed.²⁰

RRPs do not change the size of the Federal Reserve’s balance sheet, but modify the composition of its liabilities. Indeed, each dollar of RRP held by counterparties reduces one-for-one reserves held by DIs.²¹

The Federal Reserve Bank of New York has held numerous small-scale temporary operational exercises of RRP for eligible counterparties starting in the fall of 2009.²² Most recently, small-scale operational exercises have been held in April, June and August of 2013. These operations were limited in terms of their overall size (less than \$5 billion) and were focused on ensuring operational readiness on the part of the Federal Reserve, the triparty clearing banks, and the counterparties.²³ While the Desk has the authority to conduct RRP at maturities ranging from 1 business day (overnight) to 65 business days, the operational exercises thus far have typically ranged from overnight to 5 business days, with several of the August 2013 operational exercises consisting of overnight RRP. Overnight RRP were typically settled the day after, however overnight RRP with same day settlement were offered in August 2013.

At the September FOMC meeting, the committee authorized the Desk to imple-

¹⁶See <http://www.newyorkfed.org/markets/primarydealers.html>.

¹⁷Source:<http://www.newyorkfed.org/newsevents/news/markets/2009/an091019.html>

¹⁸A full list of current eligible counterparties is available at http://www.newyorkfed.org/markets/expanded_counterparties.html

¹⁹Source:<http://www.federalreserve.gov/monetarypolicy/files/fomcminutes20130731.pdf>

²⁰Source:<http://www.newyorkfed.org/newsevents/speeches/2013/dud130923.html>

²¹See the New York Fed page on RRP for more information: <http://data.newyorkfed.org/aboutthefed/fedpoint/fed04.html>

²²See the New York Fed page on temporary operations for a listing of recent RRP exercises: <http://www.newyorkfed.org/markets/omo/dmm/temp.cfm>

²³These exercises were approved by the FOMC in November 2009. See:<http://www.federalreserve.gov/monetarypolicy/files/fomcminutes20091216.pdf>

ment fixed-rate RRP exercises with per-counterparty bid caps to limit the aggregate size of the facility. In comparison to previous exercises, these exercises should better simulate the fixed-rate, full-allocation facility, which was discussed in the July 2013 FOMC minutes.²⁴

2.3 Term Deposit Facility

The TDF is another policy tool that can reduce reserves but it is available only to DIs.²⁵ The TDF was approved in April 2010, following the approval of amendments to Regulation D (Reserve Requirements of Depository Institutions), allowing Federal Reserve Banks to offer term deposits to institutions eligible to earn interest on reserves.²⁶ Small value temporary operational exercises of term deposits have occurred since June 2010, and recent small value operational exercises have been held in March, May, and July, and September of 2013.²⁷

As was the case for RRPs, the TDF does not change the size of the Federal Reserve's balance sheet, but alters the composition of its liabilities. Reserves used to finance purchases of term deposits are unavailable to DIs until the term deposit matures. The TDF therefore directly absorbs reserves when banks substitute reserve holdings for TDF holdings.

3 Benchmark Model

3.1 Agents

The economy lasts three periods $t = 0, 1, 2$ and consists of two sectors, $i = 1, 2$, which are partially segmented. Each sector contains three agents: a bank, a firm, and a risk-neutral household. In addition, a financial intermediary that we associate with an MMF operates across both sectors. The central bank and the government issue liabilities but do not behave strategically.

At date 0, households in each sector receive an endowment (E_i) that can be held in the form of deposits in the bank of their sector (D_i), or in MMF shares (F). No other agent has an endowment.

²⁴Source:http://www.newyorkfed.org/markets/rrp_faq.html

²⁵Source:<http://www.federalreserve.gov/newsevents/press/monetary/20100430a.htm>

²⁶Source:<http://www.federalreserve.gov/newsevents/press/monetary/20100430a.htm>

²⁷Source:http://www.frbervices.org/centralbank/term_deposit_facility_archive.html

The supply of reserves and government bonds are set exogenously and denoted by \mathbf{M} and B , respectively. The interest paid on reserves is set exogenously and denoted by R^M paid each period, while the interest paid on government bonds is determined in equilibrium and denoted R^B .

Banks take deposits from households and can invest them either in loans to the firm from the same sector (L_i) or in reserves at the central bank (M_i), with $M_1 + M_2 = \mathbf{M}$. Note that only banks can hold reserves. Reserves are injected by purchasing bonds, so the quantity of bonds held by the central bank, B^{CB} , is equal to the supply of reserves \mathbf{M} .

Firms borrow from banks and finance projects with a concave and strictly increasing production function, with marginal return given by $r_i(L_i)$. The firms' output is sold as consumption goods to households at date 2.²⁸

The MMF can sell shares to households and invest in government bonds. We denote the MMF's holding B^H .

Banks, firms, and the MMF are profit maximizers, while households seek to maximize consumption. There are centralized markets for goods, bonds, and reserves, which imply they have common prices and returns across sectors. However, the returns on the other assets in the economy can vary across sectors. We abstract from credit risk, as the focus of the paper is the use of monetary policy tools in a stable, non-crisis environment.

3.2 Timeline

At $t = 0$ assets are traded in both sectors. The household of sector i deposits D_i^0 in the local bank and invests F_i^0 in MMF shares. Banks accept deposits, hold reserves, and lend to firms at a rate R^L . The MMF sells share and purchases bonds.

At $t = 1$, a liquidity shock hits one of the two sectors. The probability that sector i is hit is $\frac{1}{2}$ for $i = 1, 2$. In the sector affected by the shock, a fraction λ of households must withdraw their deposits from their bank because they relocate to the other sector. In the benchmark case, the only option for relocated households is to deposit in the bank of the sector they moved to.

Banks can use reserves to meet withdrawals. Reserve have a face value of R^M at $t = 1$ per unit held at $t = 0$. If a bank does not have enough reserves, it can borrow I in the interbank market at an interest rate of R^I . We assume interbank lending frictions in the form of a strictly increasing and convex cost, $f_i(I)$, for the lending

²⁸Note that uppercase variables denote nominal values while lowercase variables denote real values. Also subscripts always represent the sector.

bank, which represents monitoring costs. We assume that IOER is constant so that a unit of reserve held from $t = 1$ to $t = 2$ is also R^M .

At $t = 2$, firms sell their output to households at a price of P per unit, households consume the goods they purchase, and firms repay their loans to banks.

We assume for simplicity that deposits made at $t = 0$ can be withdrawn for a return of 1 at period $t = 1$. Deposits not withdrawn at $t = 1$ yield a return of R^{D0} , while deposits that were withdrawn and re-deposited yield a return of R^{D1} .

To facilitate analysis we choose a somewhat stylized structure of the MMF. We choose to model MMF shares as offering a competitive return of R^{F0} for those sold in $t = 0$ and R^{F1} for those offered in $t = 1$. Thus, we consider shares of the MMF offered in different periods as investments in different funds.

A key friction is the presence of “balance sheet costs” for banks. Balance sheet costs were introduced in MMS, with each bank bearing an exogenous cost that is increasing in the size of their balance sheet, with marginal real cost given by $c_i(D)$.

Balance sheet costs are motivated by the analysis of market observers. For example, interbank broker Wrightson ICAP (2008) voiced concerns that large reserves could “clog up bank balance sheets.” Furthermore, as MMS explains, banks tended to reduce the size of their balance sheets during the recent crisis, in line with the presence of balance sheet costs. Evidence for this cost is also suggested by figure 1. We observe that the quantity of reserves is clearly negatively correlated with all of the bank deposit and related short-term money market rates plotted. The table below lists these correlation coefficients.²⁹

Rate	Correlation
Federal Funds Effective	-.59
O/N Eurodollar	-.57
4 Week T-Bill	-.53

In MMS, this negative correlation is explained by balance sheet frictions bearing exogenous costs on banks, which in equilibrium are pushed onto depositors. Thus, when reserves, and consequently bank balance sheets, are large, the resulting frictions are imposed on depositors through a lower deposit rate. Possible explanations for these balance sheets costs include capital requirements, leverage ratios, and FDIC deposit insurance assessments applied to all non-equity liabilities.³⁰ In July 2013,

²⁹Source: Federal Reserve Board H.15 report and H.4.1 re-
port: <http://www.federalreserve.gov/releases/h15/update/> and
<http://www.federalreserve.gov/Releases/h41/>

³⁰Federal Reserve Bank of New York President Dudley states that “to the extent that

the Federal Reserve and the FDIC proposed a new rule to strengthen leverage ratios for the largest, most systemically important banks. Under the proposed rule, bank holding companies with more than \$700 billion in consolidated total assets would be required to maintain a tier 1 capital leverage of 5 percent, 2 percent above the minimum supplementary leverage ratio of 3 percent. Such proposals suggest that balance sheet costs may be relevant especially in the near future.³¹

We assume that this cost is aggregated across periods; that is, if D^0 deposits were issued in $t = 0$ and D^1 deposits were issued in $t = 1$, then the total cost for the bank due to balance sheet costs is:

$$P \left[\int_0^{D^0} c_i(D) dD + \int_{D^0}^{D^0+D^1} c_i(D) dD \right] \quad (1)$$

At period $t = 2$, households pay a lump-sum tax (τ) such that the government maintains a net balanced budget.

3.3 Optimizations

In this section we describe each agent's optimization. Firms seek to maximize profits obtained from sales of real goods in $t = 2$. Thus, the firm in sector i solves:

$$\max_{L_i} P \int_0^{L_i} r_i(\widehat{L}) d\widehat{L} - R_i^L \widehat{L}$$

The MMF maximizes profits and solves:

$$\begin{aligned} \max_{B^H, F^0} R^B B^H - R^{F^0} F^0 \\ s.t. \quad B^H = F^0 \end{aligned}$$

The MMF simply arbitrages, in the bond market, the capital obtained from selling their shares. They earn the spread between the total bond return and the claims they must pay out for all shares in $t = 2$.

Households and banks must take into account the liquidity shock. The household of sector i solves:

$$\begin{aligned} \max_{D_i^0, F_i^0} \frac{1}{2} \left(\frac{R_i^{D^0} (1 - \lambda) D_i^0 + R^{D^1} \lambda D_i^0}{P} \right) + \left(\frac{1}{2} \right) \left(\frac{R_i^{D^0} D_i^0}{P} \right) + \frac{R^{F^0} F_i^0 - \tau}{P} \\ s.t. \quad D_i^0 + F_i^0 = E \end{aligned}$$

the banks worry about their overall leverage ratios, it is possible that a large increase in excess reserves could conceivably diminish the willingness of banks to lend." Source: <http://www.newyorkfed.org/newsevents/speeches/2009/dud090729.html>

³¹Source: <http://www.federalreserve.gov/newsevents/press/bcreg/20130709a.htm>

The first term in the objective function represents the expected return on deposits from a household in the sector affected by the shock. With probability λ the household must relocate, withdraw D_i^0 from its bank, and can redeposit in the bank of the other sector. In such a case, the household earns R^{D1} on its deposit in the sector it moved to. If the household does not need to relocate, then it earns R_i^{D0} on its deposit. The household also earns $R^{F0}F_i^0$ for its investment in the MMF, and pays τ in taxes, regardless of whether it must relocate. Since the household values real consumption, all nominal terms are divided by the price level in $t = 2$. The constraint simply states that total household investment in $t = 0$ must equal total endowment.

The banks' optimization is similarly given by:

$$\begin{aligned}
& \max_{L_i, M_i, D_i^0, D_i^1, I} \frac{1}{2} (R^M \max(R^M M_i - \lambda D_i^0, 0) - R^I \max(0, \lambda D_i^0 - R^M M_i)) \\
& - (1 - \lambda) R_i^{D0} D_i^0 - P \int_0^{D_i^0} c_i(\widehat{D}) d\widehat{D} \\
& + \frac{1}{2} (R^M (R^M M_i + D_i^1 - I_i) + R^I I_i \\
& - P \int_0^{I_i} f_i(\widehat{I}) d\widehat{I} - R_i^{D0} D_i^0 - R^{D1} D_i^1 - P \int_0^{D_i^0 + D_i^1} c_i(\widehat{D}) d\widehat{D}) + R_i^L L_i \\
& s.t. \quad L_i + M_i = D_i^0 \\
& \quad \quad R^M M_i + D_i^1 - I_i \geq 0
\end{aligned}$$

With probability $\frac{1}{2}$, bank i is hit with the liquidity shock and must pay out λD_i^0 in deposits. Any reserves in excess of λD_i^0 can be reinvested for a return of R^M and the bank earns $R^M (R^M M_i - \lambda D_i^0)$. If outstanding reserves do not exceed λD_i^0 , the difference must be satisfied using interbank loans and the bank must pay out $R^I (\lambda D_i^0 - R^M M_i)$ to the other bank. The bank must also pay out $(1 - \lambda) R_i^{D0} D_i^0$ at date 2, and bear the balance sheet costs $P \int_0^{D_i^0} c_i(\widehat{D}) d\widehat{D}$. If the bank is not hit by the shock, it receives additional deposit at $t = 1$ and may be requested to provide an interbank loan. The payoff earned on reserves held from $t = 1$ to $t = 2$ is $R^M (R^M M_i + D_i^1 - I_i)$. The payoff on the interbank loan is $R^I I_i - P \int_0^{I_i} f_i(\widehat{I}) d\widehat{I}$. The bank must also pay out its deposit liabilities, $(R_i^{D0} D_i^0 + R^{D1} D_i^1)$, and its balance sheet cost $P \int_0^{D_i^0 + D_i^1} c_i(\widehat{D}) d\widehat{D}$. In either case, the bank will earn the same return on loans, $R_i^L L_i$. The first constraint says that, since banks have no initial capital, $t = 0$ deposits must equate with the bank's $t = 0$ asset holdings $L_i + M_i$. The second constraint is to ensure that the bank does not make more interbank loans than they

have outstanding liquidity, $R^M M_i + D_i^1$.

3.4 Equilibrium Analysis

For simplicity, we consider standard market security instruments; we use general equilibrium as our solution concept. In particular, an equilibrium in this economy is a set returns, $R_i^{D0}, R^{D1}, R^B, R^{F0}, R^{F1}, R_i^L$, and R^I , and a $t = 2$ price level P , such that all markets clear at the agents' optimizing levels of investment and consumption.

We focus on an ex-ante symmetric case where both sectors and all agents are identical. Therefore we assume that for all households i in both sectors we have $E_i = E$. Furthermore for both sectors 1 and 2, we have:

$$\begin{aligned} r_1(L) &= r_2(L) = r(L) \\ c_1(D) &= c_2(D) = c(D) \\ f_1(I) &= f_2(I) = f(I). \end{aligned}$$

We also assume the standard regularity conditions:

$$\begin{aligned} r(L) &> 0, \quad r'(L) < 0, \quad r(0) = \infty, \quad r(\infty) = 1 \\ c(D) &> 0, \quad c'(D) > 0, \quad c(0) = 0, \quad c(\infty) = \infty \\ f(I) &> 0, \quad f'(I) > 0, \quad f(0) = 0, \quad f(\infty) = \infty. \end{aligned}$$

Furthermore, we examine equilibria where the quantity of reserves and bonds are symmetric across the two sectors at $t = 0$. That is, $M_i = \frac{\mathbf{M}}{2}$ and $F_i^0 = \frac{B - \mathbf{M}}{2}$ for $i = 1, 2$.³² This implies that:

$$D_1^0 = D_2^0 = E - \frac{B - \mathbf{M}}{2} \tag{2}$$

$$L_1 = L_2 = E - \frac{B}{2} \tag{3}$$

Since all the quantities at $t = 0$ are identical in equilibrium, we can drop the subscripts. By symmetry, and because of the common good market, $R_1^{D0} = R_2^{D0}$ and

³²Note that M_i represents the amount of reserves held by the bank of sector i at $t = 0$. At $t = 1$ bank i 's outstanding reserves may change in response to liquidity shocks and/or interbank lending.

$R_1^L = R_2^L$ for both sectors in equilibrium. Therefore we can also drop the subscripts on all rates and talk of one equilibrium rate for loans and deposits. It is easy to show that only the bank from the sector that did not experience the shock offers interbank loans. To further simplify notation, we assume that the bank experiencing the shock does not receive deposits at $t = 1$.³³ Therefore, the equilibrium rates R^{D1} and R^I refer only to the returns offered in $t = 1$ for the non-shocked bank and we can drop the subscripts on D_i^1 and I_i .

We can now turn to the determination of equilibrium rates and quantities. The level of the central bank's supply of reserves plays a large role in the rates determined in equilibrium. We first define $\bar{\mathbf{M}}$, the supply of sreserve above which banks have enough reserves to fully fund potential withdrawals at $t = 1$:

$$\bar{\mathbf{M}} \equiv \frac{\lambda}{R^M - \lambda}(2E - B) \quad (4)$$

Propositions 1 and 2 characterize the equilibrium of this model for $\mathbf{M} \geq \bar{\mathbf{M}}$ and for $\mathbf{M} < \bar{\mathbf{M}}$.

Proposition 1 *For $\mathbf{M} \geq \bar{\mathbf{M}}$ a unique competitive equilibrium is given by (1)-(8):*

1. $L = E - \frac{B}{2}$
2. $R^L = (R^M)^2$
3. $D^0 = E - \frac{B-\mathbf{M}}{2}$, $D^1 = \lambda D^0$, $F^0 = \frac{B-\mathbf{M}}{2}$, $F^1 = 0$
4. $R^{D0} = \frac{2}{2-\lambda}[(R^M)^2 - \frac{\lambda R^M}{2} - P(\frac{1}{2}c(D^0) + \frac{1}{2}c(D^0 + D^1))]$, $R^{D1} = R^M - Pc(D^0 + D^1)$,
 $R^{F1} \leq R^{D1}$
5. $R^{F,0} = R^B = \frac{\lambda}{2}R^{D1} + (1 - \frac{\lambda}{2})R^{D0}$
6. $I = 0$
7. $R^I = R^M + Pf(0) = R^M$
8. $P = \frac{(R^M)^2}{r(E - \frac{B}{2})}$

³³We could also prove that there would be no $t = 1$ deposits for the shocked bank if depositors could not withdraw and deposit into the same bank and non-shocked depositors could not relocate to the other sector at $t = 1$.

Proof. See the Appendix. ■

Item 1 and the first equality under item 3 show that the amount of loans and deposits are pinned down by the endowment, the supply of government bonds, and the supply of reserves, which are exogenously fixed. Item 2 must hold for banks to invest in both loans and reserves. Item 3 states that $t = 1$ deposits are equal to the amount withdrawn by relocating depositors and that total investment in the MMF is equal to the amount of government bonds remaining after the central bank has completed its purchases. Like in MMS, balance sheet costs drive a wedge between the deposit rate and IOER, as shown in item 4. The wedge increases with the size of the balance sheet costs and, thus, the size of deposits. Item 5 says that the return offered by the MMF, which is equal to the return on bonds, must be equal to the expected return on deposits for depositors to invest in both the bank and the MMF.

Since $\mathbf{M} \geq \overline{\mathbf{M}}$, the interbank market is inactive, as noted in item 7. Banks have enough liquidity to accommodate any potential payment shock and, thus, have no incentive to engage in costly interbank borrowing. Finally, item 7 states that the interbank return is equal to the IOER when there is no interbank lending.

When there is no shock ($\lambda = 0$), proposition 1 is the case of moderate balance sheet cost in MMS. Figure 2 represents the equilibrium graphically.

See figure 2

Proposition 2 characterizes the equilibrium when liquidity is not sufficient to cover withdrawals at date 1 and banks must use the interbank market. To facilitate the analysis, we impose a small regularity condition:

$$r\left(E - \frac{B}{2}\right) > \frac{1}{2}R^M f\left(\lambda\left(E - \frac{B - \mathbf{M}}{2}\right) - R^M M\right) \quad (5)$$

Equation (5) states that the marginal return on production must be sufficiently large compared to the marginal real interbank cost at the equilibrium loan and deposit level.

Proposition 2 *If (5) holds and $\mathbf{M} < \overline{\mathbf{M}}$, a unique competitive equilibrium is given by (1)-(8). If (5) does not hold, then no equilibrium with a finite, positive price level and full redeposits at $t = 1$ exists.*

1. $L = E - \frac{B}{2}$
2. $R^L = (R^M)^2 + \frac{1}{2}(R^M)^{1/2}Pf(I) > (R^M)^2$
3. $D^0 = E - \frac{B - \mathbf{M}}{2}$, $D^1 = \lambda D^0$, $F^0 = \frac{B - \mathbf{M}}{2}$, $F^1 = 0$

4. $R^{D0} = \frac{2}{2-\lambda}[(R^M)^2 - \frac{\lambda R^M}{2} + Pf(I)(\frac{R^M}{2} - \frac{\lambda}{2}) - P(\frac{1}{2}c(D^0) + \frac{1}{2}c(D^0 + D^1))]$,
 $R^{D1} = R^M - Pc(D^0 + D^1)$, $R^{F1} \leq R^{D1}$
5. $R^{F0} = R^B = \frac{\lambda}{2}R^{D1} + (1 - \frac{\lambda}{2})R^{D0}$, $B^H = \frac{B-M}{2}$
6. $I = \lambda D^0 - R^M M > 0$
7. $R^I = R^M + Pf(I) > R^M$
8. $P = \frac{(R^M)^2}{r(L) - \frac{1}{2}R^M f(I)} > \frac{(R^M)^2}{r(L)}$

Proof. See the Appendix. ■

Items 1, 3, and 5 are the same as in proposition 1. Item 6 shows that banks use the interbank market because liquidity is scarce. As is shown in figure 3 below, and implicitly in item 7 of the proposition, the interbank rate is decreasing in the amount of reserves and is always above the IOER.

See figure 3

Investing in loans rather than reserves means potentially having to borrow in the interbank market, which is costly since $R^I > R^M$. Hence, the return on loans must exceed the IOER rate, as shown in figure 4 and in item 2 of the proposition. Also, since R^L is no longer pinned down at the IOER, item 8 shows that the equilibrium price level is increasing in the volume of interbank loans and, thus, decreasing with the level of reserves.

See figure 4

Given the presence of balance sheet costs, it is reasonable to believe that $R^{D1} < R^{D0}$. This is because $t = 1$ deposits are added to more congested balance sheets than $t = 0$ deposits. The $t = 1$ deposits increase the balance sheet cost of the bank receiving these deposits and the depositors have a perfectly inelastic demand for these deposits. In proposition 1 we will have $R^{D1} < R^{D0}$ when:

$$(R^M)^2 - R^M > \frac{P}{2}(c(D^0) - (1 - \lambda)c(D^0 + D^1)) \quad (6)$$

and similarly for proposition 2:

$$(R^M)^2 + Pf(I)(\frac{R^M}{2} - \frac{\lambda}{2}) - R^M > \frac{P}{2}(c(D^0) - (1 - \lambda)c(D^0 + D^1)) \quad (7)$$

It can be easily seen that for most reasonable parameters this will hold. In fact, even if $R^M = 1$, (6) and (7) can still hold provided balance sheet costs are

large enough. However, since we focus on primarily on situations with large balance sheet costs and non-trivial IOER, for the remainder of the paper we will make the following assumption that IOER is sufficiently large compared to the size of the shock:

$$R^M > 1 + \frac{\lambda}{2} \quad (8)$$

This is a sufficient condition which guarantees that $R^{D1} < R^{D0}$ in both propositions 1 and 2.³⁴

Furthermore, from equation 5 in both propositions we obtain an interesting corollary:

Corollary 3 *For both $\mathbf{M} \geq \overline{\mathbf{M}}$ and $\mathbf{M} < \overline{\mathbf{M}}$, when $\lambda > 0$ we have that $R^B < R^{D0}$, i.e. $t = 0$ deposits have a higher return than government bonds.*

The intuition for this corollary is that deposits are risky, since a depositor who must relocate gets a low return. In contrast, government bonds offer a certain return. For the expected return on deposits to be equal to the expected return on bonds, the return depositors get if they are not relocated must be greater than the return on bonds. This “liquidity risk” premium is given by

$$\frac{\lambda}{2}(R^{D0} - R^{D1}) \quad (9)$$

and is precisely the expected loss on a unit of deposit in case of relocation.

4 Central Bank Tools

We now use this framework to analyze the RRP and the TDF. We assume that the MMF can invest in RRP in addition to government bonds. In contrast, only banks can invest in the TDF. The TDF serves as a substitute to reserves for banks, but does not bear the liquidity benefit of reserves.

Both RRP and the TDF substitute for reserves on the balance sheet of the central bank one for one. Thus, these assets essentially “absorb” reserves.

³⁴It may be of use discussing why we could have $R^{D1} > R^{D0}$. The reason is that in $t = 0$ the bank loses an expected amount of $\frac{\lambda R^M}{2}$ from the potential shock, for every additional unit of deposit taken on. Thus, they must be compensated for this through a lower deposit rate in $t = 0$. This extra cost does not exist in $t = 1$ since in our model there is no shock after $t = 1$. However, when the shock size is small, or balance sheet costs are very large, the extra cost incurred in $t = 0$ is likely to be irrelevant.

4.1 Overnight RRP: Fixed-Quantity vs. Fixed-Rate, Full-Allotment

The purpose of an ON RRP is to offer a short-term investment that is available whenever needed. The ON RRP is offered in $t = 1$ and allows the MMF to purchase additional assets. This, in turn, allows relocated households to purchase MMF shares as an alternative to redepositing in the bank at their new location.

We do not consider RRP at date 0 to focus instead on the role of ON RRP in mitigating the liquidity shock. We perform the analysis in the case of no interbank lending ($\mathbf{M} \geq \overline{\mathbf{M}}$).

Proposition 4 considers the case of a fixed-quantity operation (ON FQ RRP). The central bank offers a perfectly inelastic supply of RRP (RP^{FQ}) at a market determined, perfectly competitive rate (R^{FQ}).

Proposition 4 *For $RP^{FQ} \leq \lambda D^0$ we have in equilibrium that $R^{FQ} = R^{D1}$, $D^1 = \lambda D^0 - RP^{FQ}$. Furthermore, in this equilibrium R^{D0} , R^{D1} , and R^B are all higher than the corresponding rates in proposition 1.*

Proof. If $R^{FQ} > R^{D1}$, demand for RRP exceed supply. If $R^{FQ} < R^{D1}$, demand for RRP is zero and the market does not clear. Neither of these are possible equilibria, hence $R^{FQ} = R^{D1}$ in any equilibrium. This directly implies that households are indifferent between re-depositing in the unshocked bank and investing in the MMF at $t = 1$, and therefore deposit market clearing implies the expression for D^1 . Then, $D^1 < \lambda D^0$ implies that $c(D^0 + D^1) < c((1 + \lambda)D^0)$, the balance sheet cost for the unshocked bank in proposition 1. Item 4 in proposition 1 implies that the long- and short-term deposit rates both increase relative to the equilibrium without RRP due to the decrease in balance sheet costs, and item 5 implies that the bond rate increases accordingly. ■

The ON FQ RRP increases the return received by relocated households because it decreases the balance sheet costs of the bank in the region to which relocated households move.

Proposition 5 shows that a fixed-rate, full-allotment ON RRP (ON FRFA RRP) can achieve the same allocation as an ON FQ RRP. The ON FRFA RRP offers an interest rate R^{FR} at $t = 1$ for any quantity demanded. The rate R^{FR} is set exogenously by the central bank.

Proposition 5 *If the central banks sets $R^{FR} = R^{FQ}$ from proposition 4, we have that $RP^{FR} = RP^{FQ}$, $R^{FR} = R^{FQ} = R^{D1}$, and $D^1 = \lambda D^0 - RP^{FQ} = \lambda D^0 - RP^{FR}$.*

Proof. Equality of the rates is immediate from proposition 4. Suppose that $RP^{FR} < RP^{FQ}$, and denote by $D^{1,FR}$ and $D^{1,FQ}$ the corresponding re-deposit volumes. Date $t = 1$ market clearing implies that $D^{1,FR} > D^{1,FQ}$, which in turn implies $R^{D1,FR} < R^{D1,FQ}$ and hence $R^{D1,FR} < R^{FR} = R^{FQ} = R^{D1,FQ}$, a contradiction. An analogous argument for $RP^{FR} > RP^{FQ}$ implies that $RP^{FR} = RP^{FQ}$ in any equilibrium. Equality of the $t = 1$ deposit volumes follows from market clearing. ■

Figure 5 illustrates the relationship between the two RRP policies.

See figure 5

The ON FRFA RRP policy that sets $R^{FR} = R^{D0}$ is of note in this model. This policy eliminates the wedge between the bond and deposit rates in $t = 0$.

Proposition 6 *If the central bank sets $R^{FR} = R^{D0}$ then $R^B = R^{D0}$ in $t = 0$.*

Proof. From proposition 5, $R^{FR} = R^{D1}$ in any equilibrium. Hence, $R^{FR} = R^{D0}$ implies $R^{D1} = R^{D0} = R^B$ by equation (5) of proposition 1. ■

We can see from the previous two propositions that the RRP creates a transfer from the non-shocked bank to the shocked household by absorbing some of the liquidity shock. As a result the equilibrium $t = 1$ deposit rate is increased, up to the facility rate, and the quantity decreased, by the size of the facility. The overall result of this is a decrease in bank profits (because a lower amount of $t = 1$ deposits are issued at a higher rate) and an increase in consumer wealth (because shocked funds now yield a higher return).

Note that the presence of the ON RRP indirectly exerts upward pressure on bond rates in $t = 0$. The increase in the “re-deposit” rate for a shocked household increases the overall expected return of investing in deposits. Arbitrage then requires the bond and $t = 0$ MMF return to increase as well.

4.1.1 Uncertainty in Shock Size

While proposition 5 shows that a ON FQ RRP can implement the same allocation as an ON FRFA RRP, it is worth thinking about how the two tools could differ in a richer setting. For example, the two facilities would have different implications if the fraction of household that are relocated, λ , is uncertain. In such a case, an ON FQ RRP would result in fluctuations in the RRP rate, while an ON FRFA RRP would result in fluctuations in the quantity of RRPs. Hence, a policymaker who

dislikes fluctuations in the interest rate more than fluctuations in the quantity of reserves would prefer the ON FRFA RRP.

To formalize this, we assume in this section that λ can take two values, λ^L and λ^H , with $\lambda^H > \lambda^L$. We assume that the central bank knows the two possible realizations of λ but does not know which one will occur when it implements the ON RRP policy.³⁵ We also assume that the central bank would like to target a specific $t = 1$ investment rate of R^* and can choose either an ON FRFA RRP or an ON FQ RRP to do so. We will show that, in general, the ON FRFA RRP can implement a $t = 1$ investment rate close to R^* with less interest rate volatility than the ON FQ RRP.

To make the problem interesting, we analyze the case where:

$$R^M - Pc(D^0) > R^* > R^M - Pc((1 + \lambda^L)D^0) \quad (10)$$

so that the target $t = 1$ investment rate is higher than the outcome that would occur in either state without central bank intervention, but not so high that $t = 1$ deposit markets become completely inactive in all situations. We first show that an ON FRFA RRP policy can implement R^* in either state.

Proposition 7 *If the central bank sets $R^{FR} = R^*$, and (10) holds, then $R^{D1} = R^{FR} = R^*$ when either λ^L or λ^H occurs.*

Proof. First assume λ^L occurs. Suppose $R^{D1} > R^{FR}$. Then there would be no demand for the ON FRFA RRP, and $D^1 = \lambda^L D^0$. However, since we have that $R^{D1} > R^{FR} > R^M - Pc((1 + \lambda^L)D^0)$ by assumption, the unshocked bank will not be willing to supply $\lambda^L D^0$ in $t = 1$ deposits which is inconsistent with market clearing. Thus, we cannot have $R^{D1} > R^{FR}$. Now suppose that $R^{D1} < R^{FR}$. Then there will be no demand for $t = 1$ deposits ($D^1 = 0$). However since $R^{FR} = R^* < R^M - Pc(D^0)$, banks will want to supply positive deposits, which is also inconsistent with market clearing. Therefore, we cannot have $R^{D1} < R^{FR}$. Thus, we have established that $R^{D1} = R^{FR} = R^*$ when λ^L occurs. Now suppose that λ^H occurs and that $R^{D1} > R^{FR}$. Since $\lambda^H > \lambda^L$, we will have that $R^{D1} > R^{FR} > R^M - Pc((1 + \lambda^H)D^0)$ by (10). By the same argument as in the previous part, we have that $R^{D1} > R^{FR}$ is a contradiction. The case where $R^{D1} < R^{FR}$ is eliminated by an identical argument as in the previous part. Thus we have that $R^{D1} = R^{FR} = R^*$ in either state. ■

The proposition establishes that an ON FRFA RRP can impose a target R^* for any state under (10) and thus completely eliminate $t = 1$ interest rate volatility. It

³⁵For the analysis we conduct here, it is actually not necessary for us to define probabilities of the two states occurring.

is rather clear that this cannot be achieved with the ON FQ RRP. This is because when λ^L is realized, a smaller value facility will be needed to impose R^* than when λ^H occurs. A central bank cannot achieve R^* for all realizations of λ if it cannot condition the policy on the state of the world. We do however show that the central bank can implement a floor on rates at R^* . First we define RP^{FQ^*} to be the quantity of the facility that is needed to impose R^* when λ^H occurs, i.e. RP^{FQ^*} will solve:

$$R^* = R^M - Pc((1 + \lambda^H)D^0 - RP^{FQ^*}) \quad (11)$$

Such an RP^{FQ^*} will exist by continuity of the cost function as well as (10).

Proposition 8 *Under (10), if the central banks sets $RP^{FQ} = RP^{FQ^*}$, then $R^{D1} = R^*$ when λ^H occurs, and $R^{D1} > R^*$ when λ^L occurs, and D^1 is positive.*

Proof. The fact that $R^{D1} = R^*$ when λ^H occurs is true by the definition of RP^{FQ^*} . When λ^L occurs two situations can arise. First we may have that $RP^{FQ^*} \leq \lambda^L D^0$. In such a case we will have

$$\begin{aligned} R^{D1} = R^{FQ} &= R^M - Pc((1 + \lambda^L)D^0 - RP^{FQ^*}) \\ &> R^M - Pc((1 + \lambda^H)D^0 - RP^{FQ^*}) = R^*. \end{aligned}$$

However, when $RP^{FQ^*} > \lambda^L D^0$, the facility supply cannot be satisfied by shocked withdrawals alone. In order to satisfy the full amount of FQ^* additional withdrawals must occur by non-shocked investors. This will only happen when $R^{FQ} = R^{D0}$ so that non-shocked depositors are indifferent between holding their deposits and withdrawing and investing in the facility. Since the non-shocked bank will want to supply zero deposits in $t = 1$ at R^{D0} , we will have $D^1 = 0$, and the market for $t = 1$ deposits will not even exist in this case. Thus, whenever positive $t = 1$ deposits exist, we will have that $R^{D1} = R^{FQ} \geq R^*$. ■

This proposition shows that a ON FQ RRP can effectively provide a floor on rates at the target rate R^* . However, $t = 1$ investment rates may be very volatile, especially if the difference between the two shock sizes are large and both occur with high probabilities. A central bank with the intention of implementing a target rate while minimizing interest rate volatility may thus prefer a ON FRFA RRP over an ON FQ RRP.

4.1.2 Discussion

Other advantages of a FRFA RRP may also exist that are outside the scope of this model. For example, fixed-rate RRPs provide MMFs with certainty regarding fixed-rates, and certainty regarding (unlimited) quantities, both of which would have

additional benefits to MMFs in the face of uncertainty on demands and supplies in short-term money markets. In practice, MMFs have effective risk aversion, in part caused by the requirement for stable net asset values (NAVs). The certainty provided by ON FRFA RRP creates a benefit for a more stable transmission of monetary policy. FQ RRP, in contrast, will not eliminate the uncertainty regarding equilibrium rates and quantities that MMFs can receive.

Furthermore, fixed-rate RRP tend to better facilitate an overnight RRP facility. As shown above, such daily availability provides MMFs with greater certainty to support their elastic demand, at or above the RRP rate, for other assets. Fixed-rate RRP also allow for one-day maturity RRP, which can be rolled over. A fixed-quantity RRP is not as amenable to daily operations. FQ RRP would therefore tend to require longer term RRP for operational cost reasons. Shorter-term RRP provide MMFs the ability to substitute with shorter-term alternative assets. Such RRP will support money market and bank deposit rates of all maturities, even as short as overnight rates. Typically, money market rates increase with the tenor of the instrument. While ON FRFA RRP can be rolled over, and therefore provide a better floor to overnight rates as well as to longer-term rates, a longer-tenor RRP does not provide such support to rates of shorter tenors.

As a result of this, longer-term RRP may possibly have little effect on shorter-term rates. For example, a one-month RRP may increase one-month money market rates, but this may not be well transmitted down to provide support for overnight rates, which could be best supported with ON RRP. One-month RRP may rather simply increase the steepness of the one-month yield curve. In the case of ON FRFA RRP, MMFs may even take up quantities of RRP at quite low rates.

4.2 Term vs. Overnight RRP

We model long-term RRP as an alternative source of investment for MMFs in $t = 0$. Term RRP (denoted RP^{TM}) are supplied inelastically by the central bank at a fixed-rate R^{TM} , paid off in $t = 2$. Term RRP are available only to the MMF and reduce the quantity of reserves.

We restrict our analysis to the case where the interbank market is inactive at date 1, as in proposition 1. If RP^{TM} RRP are issued in $t = 0$, the total supply of reserves decreases from \mathbf{M} to \mathbf{M}' where $\mathbf{M}' = \mathbf{M} - RP^{TM}$. So we assume that $\mathbf{M}' \geq \overline{\mathbf{M}}$.

Item 5 of proposition 1 must hold for bonds to be held in equilibrium. In the benchmark case we can write the equilibrium bond rate as:

$$\overline{R^B} = (R^M)^2 - \frac{P}{2} \left(c \left(E - \frac{B - \mathbf{M}}{2} \right) + (1 + \lambda) c \left((1 + \lambda) \left(E - \frac{B - \mathbf{M}}{2} \right) \right) \right) \quad (12)$$

If term RRP rates are introduced at a rate below $\overline{R^B}$, then no RRPs are held by the MMF. Therefore we have the following lemma:

Lemma 9 *If R^{TM} is set less than $\overline{R^B}$ in proposition 1, we will have*

$$R^{TM} < R^{F0} = R^B = \overline{R^B} = \frac{\lambda}{2} R^{D1} + \left(1 - \frac{\lambda}{2}\right) R^{D0} < R^{D0}$$

and $RP^{TM} = 0$, $\mathbf{M} = \mathbf{M}'$.

If R^{TM} is set above $\overline{R^B}$, then there will be a positive demand for term RRPs.

Proposition 10 *For R^{TM} greater than $\overline{R^B}$, in equilibrium we must have $\overline{R^B} < R^B = R^{TM}$, $RP^{TM} > 0$, and $\mathbf{M}' < \mathbf{M}$. Furthermore, both R^{D0} and R^{D1} will increase, while their respective equilibrium quantities decrease.*

Proof. See the Appendix ■

RRP holdings increase when the term RRP rate is set at a higher level. This leads to higher MMF investment and lower bank deposits, reducing the balance sheet costs. Hence, both R^{D1} and R^{D0} increase until $R^{TM} = \frac{\lambda}{2} R^{D1} + \left(1 - \frac{\lambda}{2}\right) R^{D0}$. The term RRP rate, when it is set sufficiently high, creates a floor for the bond and deposit rates. The appendix provides a proof of proposition 7. It also characterizes the acceptable range of central bank-set RRP rates so that equilibrium is possible without triggering an interbank market. Figure 6 graphically illustrates the affect of the term RRP policy on R^{D0} , and the affect on R^{D1} is similar.

See figure 6

We have modeled term RRPs as being fixed-price, full-allotment. As in the previous section, one can also consider an operation for a fixed quantity, RP^{TM} , of RRP, where the rate is market determined. The equilibrium in the fixed-price, full-allotment case where $\overline{R^B} = R^B = R^{F0} = R^{TM}$ is identical to any equilibrium in which a quantity RP^{TM} of RRPs are set which yield R^{TM} in equilibrium. The main difference is that in the fixed-rate setting we could have equilibria where $R^{TM} < R^B$. In this situation, MMFs only hold bonds and no RRPs are held. Such an equilibrium (where the RRP rate is strictly below the other rates) is impossible in the operation

style setting of the fixed-quantity RRP market.³⁶ Arbitrage forces the RRP rate to be equal to the bond rate, since it is also a safe asset. For similar reasons, the bank deposit rates increase with the RRP quantity supplied. The mechanism is that an increase in the quantity supplied of RRP decreases the quantity of deposits which reduces balance sheet costs.

Both the term and the ON RRP increase $t = 1$ and $t = 2$ deposit rates. However, they do so through different mechanisms. The ON RRP (that is offered in $t = 1$ only) sets a reservation $t = 1$ deposit rate, which directly raises R^{D1} up to that level. R^{D0} increases because the ON RRP absorbs shocked withdrawals and lowers $t = 1$ expected balance sheet costs for the bank. The term RRP (offered only in $t = 0$) directly lowers balance sheet costs in $t = 0$ and partially raises $t = 0$ deposit rates. The decrease in deposits at $t = 0$ reduces the size of the shock in $t = 1$, which then indirectly increases $t = 1$ deposit rates by reducing the balance sheet cost burden. This then feeds back into $t = 0$ deposit rates, as banks now expect lower $t = 1$ deposits. Thus, an additional increase in R^{D0} occurs.

An ON RRP (of either fixed-rate or fixed-quantity) offered at $t = 0$ would also reduce D^0 and thus reduce balance sheet costs and raise $t = 0$ deposit rates. Term RRP may be preferable, however, if offering RRP of open-ended size on a daily basis is operationally difficult or expensive compared to a term RRP that attracts large, long-term deposits.

4.3 TDFs vs. RRP

As shown in the previous sections, RRP provide a tool for the central bank to both manage reserves and provide a floor for rates. Another such tool is the term deposit facility (T). The TDF is comparable to the term RRP with the exception that it is only offered to banks. As we will show in this section, the two tools vary in their effect on equilibrium rates depending on various parameters in the model. For this section, we assume that the central bank chooses a sufficiently large equilibrium quantity of the TDF or RRP such that reserves are reduced to the point where $\mathbf{M} < \overline{\mathbf{M}}$ at the end of $t = 0$. That is, the central bank is using its policy tools in large enough size so as to rekindle the interbank market and promote interbank lending in $t = 1$.

We model the TDF as a fixed-quantity operation (T) offered by the central bank in $t = 0$ maturing in $t = 2$ with a competitive return R^T . Important to note is that

³⁶One could argue that this case corresponds to a zero quantity auctioned, where the equilibrium rate i indeterminate within a range.

TDF holdings cannot be used to ward off liquidity shocks. In this sense, they are a perfect substitute for real sector bank lending and in equilibrium we must have that $R^T = R^L$. The key difference between the RRP and the TDF is that TDFs force substitution of liquid reserves to illiquid TDF holdings completely within the banking sector. RRPs, on the other hand, divert reserve holdings to the assets held by the universal MMF which is not prone to shocks. Thus, utilizing RRPs as opposed to TDFs reduces liquid assets while bearing less of an increase on interbank borrowing costs and liquidity premia. For simplicity and for ease of comparison, we will assume that the RRP is a term RRP in this case.

As an illustration, first suppose that the central bank increases the TDF supply by 2 units. Each bank would decrease its liquid reserve holdings by 1 unit. In doing so they lose R^M units of reserves which could have been used to ward off a potential liquidity shock. This means that interbank loans will increase by R^M , which implies that the equilibrium interbank rate will increase by $f(I + R^M) - f(I)$. On the other hand, if the central bank were to supply 2 more units of RRPs instead, each bank would still decrease its liquid reserve holdings by 1 unit (assuming the MMF borrows equally from both sectors) sacrificing R^M in liquid assets in $t = 1$. However, each household is also converting one deposit to an MMF share. Thus, interbank loans will only increase by $R^M - \lambda < R^M$ and the interbank rate will increase by $f(I + R^M - \lambda) - f(I) < f(I + R^M) - f(I)$. This implies that the liquidity premium will be smaller in the case of RRPs than of the TDF. This is shown in figure 7.

See figure 7

This difference also factors into the effect on deposit rates. From part 4 of proposition 2, we can see that the $t = 0$ deposit rate is increasing in interbank lending and decreasing in equilibrium $t = 0$ and $t = 1$ deposits due to balance sheet costs. This leads to the following proposition for interbank and balance sheet costs that are largely convex. The proposition is more explicitly formalized and proved in the appendix:

Proposition 11 *When marginal real balance sheet costs are large relative to interbank lending costs and both marginal cost functions are convex, we will have $\frac{\partial R^{D0}}{\partial T} > \frac{\partial R^{D0}}{\partial R^{PTM}}$. This occurs when deposits and liquid reserves are large and interbank lending is small. Reversing these relationships will yield the opposite inequality.*

Proof. See the Appendix ■

The result is driven primarily by the convexity of the two costs. Nevertheless, there are relatively interesting implications of the above proposition. The sizes of

$f(\cdot)$ and $c(\cdot)$ will increase when interbank loans and deposits, respectively, are larger. Therefore, when both of the cost functions are very convex, a policymaker who has a primary goal of increasing deposit rates may want to mediate between usage of both tools. Specifically, he may want to first use term RRP to reduce deposit size, then divert to implementation of the TDF after decreases in marginal balance sheet costs diminish. On the other hand, a policymaker who seeks to absorb reserves with a smaller effect on increasing deposit rates may want to focus on the one facility, namely the TDF if marginal balance sheet costs are very fast increasing, and the RRP if interbank lending frictions are instead more prominent.

5 Conclusion

In response to the 2007-09 financial crisis and subsequent economic conditions, the Federal Reserve engaged in large-scale lending to financial institutions to provide liquidity and large-scale asset purchases to stimulate the economy by lowering interest rates. As a result of these policies, the amount of reserves in the banking system increased dramatically to over \$2 trillion as of September 2013. In October 2008, the Federal Reserve began offering IOER to DIs to better control short-term rates in this environment of large excess reserves. Furthermore, in June 2011, the FOMC announced plans to implement certain tools, namely term and ON RRP offered to a wide range of counterparties and the TDF offered to DIs, which would help IOER in supporting interest rates. In August 2013, the FOMC announced further study of fixed-rate, full-allotment ON RRP as a potential tool. The purpose of this paper is to analyze the effectiveness of IOER, the RRP, and the TDF in implementing the FOMC's goals of retaining control over short-term interest rates while managing reserves.

We introduce a simple general equilibrium model to analyze these tools. While parsimonious and tractable in its exposition, our model highlights numerous important results regarding IOER, RRP, and the TDF. As in MMS, IOER influences deposit rates as it represents the riskless return on holding a deposit. It also sets a short-term reservation rate in the interbank market at which DIs should not lend below. We find that RRP work mainly through the household investment side but also serve to reduce reserves. RRP can raise deposit rates in two ways: Decreasing balance sheet costs through reallocating depositor funds into MMFs holding government bonds, which are not subject to balance sheet costs and liquidity shocks, and setting a reservation rate for short-term deposits that occur as a result of liq-

uidity shocks. While the model shows that fixed-rate and fixed-quantity ON RRP would be identical in the absence of informational frictions, fixed-rate RRP may be advantageous for a central banker trying to set a floor on short-term rates without perfect knowledge on the intensity of shocks or exogenous costs agents face. Term RRP in this model offer little benefit over ON RRP if the ON RRP can be offered on a consistent basis at low cost in implementation. However, they can further reduce balance sheet costs and raise deposit rates. TDFs, in contrast to RRP, do not reduce balance sheet costs. Therefore, when the banking system is forced to trade on costly interbank markets, RRP increase the size of this interbank market by less than the TDF. This motivates usage of the RRP and the TDF concurrently. Namely when real marginal balance sheet costs and interbank lending costs are very convex, policy makers with the intention of raising deposit rates to high levels may want to use both facilities together.

Our model provides a broad framework in which many additional questions about central bank policy for managing large levels of reserves can be analyzed. As in MMS, we can ask how balance costs affect inflation and consumption. Additionally, we can consider heterogeneity across and within sectors. Other extensions to the model can include incorporating additional financial institutions, such as securities dealers and GSEs. The central bank can manage its liabilities facilities with regard to these institutions to further absorb reserves, influence the broad range of money market rates, and impact the level of lending, output, inflation, and consumption. With this in mind, we also stress the versatility of this particular model as a useful benchmark that can be used to analyze a variety of further institutional details for financial intermediaries and money markets.

References

- [1] Ashcraft, Adam, James McAndrews and David Skeie (2011). "Precautionary Reserves and the Interbank Market," *Journal of Money, Credit and Banking*, Vol. 43(7, Suppl.), pp. 311 - 348.
- [2] Bech, Morten, Elizabeth Klee (2011). "The Mechanics of a Graceful Exit: Interest on Reserves and Segmentation in the Federal Funds Market," *Journal of Monetary Economics*, Elsevier, Vol. 58(5), pp. 415-431.
- [3] Beckner, Steven K. (2009). "Federal Reserve State of Play," *imarketnews.com* November 12, 2009. <http://imarketnews.com/node/4617>.
- [4] Bennett, Paul and Stavros Peristiani (2002). "Are U.S. Reserve Requirements Still Binding?" Federal Reserve Bank of New York *Economic Policy Review* 8(1).
- [5] Ennis, Huberto M. and Todd Keister (2008). "Understanding Monetary Policy Implementation," Federal Reserve Bank of Richmond *Economic Quarterly* 235-263.
- [6] Freixas, Xavier, Antoine Martin and David Skeie (2011). "Bank Liquidity, Interbank Markets and Monetary Policy," *Review of Financial Studies*, 11(1), pp. 104-132.
- [7] Gagnon, Joseph, Matthew Raskin, Julie Remanche, and Brian Sack (2010). "Large-Scale Asset Purchases by the Federal Reserve: Did They Work?," Federal Reserve Bank of New York *Staff Reports* no. 441.
- [8] Hilton, Spence (2005). "Trends in Federal Funds Rate Volatility," Federal Reserve Bank of New York *Current Issues in Economics and Finance* 11(7).
- [9] Kashyap, Anil and Jeremy C. Stein (2012). "The Optimal Conduct of Monetary Policy with Interest on Reserves," *American Economic Journal: Macroeconomics*, 4(1), pp. 266-282.
- [10] Keister, Todd, Antoine Martin and James McAndrews (2008). "Divorcing Money from Monetary Policy," Federal Reserve Bank of New York *Economic Policy Review* 14(2).
- [11] Keister, Todd and James McAndrews (2009). "Why Are Banks Holding So Many Excess Reserves?" *Current Issues in Economics and Finance*, Federal Reserve Bank of New York.
- [12] Martin, Antoine, James McAndrews and David Skeie (2013). "Bank Lending in Times of Large Reserves," Federal Reserve Bank of New York *Staff Reports* no. 497.
- [13] Meltzer, Allan H. (2010). "The Fed's Anti-Inflation Exit Strategy Will Fail." *Wall Street Journal*. January 27, 2010. <http://online.wsj.com/article/SB10001424052748704375604575023632319560448.html>.
- [14] Poole, William (1970). "Optimal Choice of Monetary Policy Instruments in a Simple Stochastic Macro Model" *Quarterly Journal of Economics* 84(2) pp. 197-216.

- [15] Wrightson ICAP (2008). *Money Market Observer*, October 6.
- [16] Wrightson ICAP (2009). *Money Market Observer*, January 12.

Symbol	Description
B	Supply of government bonds
B^H	Bonds held by MMF on behalf of households
B^{CB}	Bonds held by central bank
$c(\cdot)$	Marginal real balance sheet costs as a function of deposits
D^0	Deposits offered by banks to households in $t = 0$
D^1	Deposits offered by non-shocked bank to households in $t = 1$
E	$t = 0$ household endowment of individual sector
$f(\cdot)$	Marginal real interbank lending cost as a function of interbank loans
F^0	MMF shares held by household in $t = 0$
F^1	MMF shares held by household in $t = 1$
I	Interbank loans in $t = 1$
L	Bank loans to firms in $t = 0$
\mathbf{M}	Total reserves supplied by central bank
M	Reserves held by an individual bank
$\overline{\mathbf{M}}$	Threshold level of reserves supply at which any less would trigger the interbank market
P	$t = 2$ price of real consumption
$r(\cdot)$	Marginal rate of firm production as a function of bank loans
R^B	Return on government bonds paid at $t = 2$
R^{D^0}	Return on $t = 0$ deposits paid at $t = 2$
R^{D^1}	Return on $t = 1$ deposits paid at $t = 2$
R^{F^0}	Return on $t = 0$ MMF shares paid at $t = 2$
R^{F^1}	Return on $t = 1$ MMF shares paid at $t = 2$
R^I	Return on interbank loans paid at $t = 2$
R^L	Return on $t = 0$ loans paid at $t = 2$
R^M	Exogenously set return on reserve held for 1 period
λ	Size of the relocation shock as a fraction of deposits

Appendix Proofs:

Proof of Proposition 1. We show that if $\bar{\mathbf{M}} \leq \mathbf{M}$, then there exists an equilibrium (Q,R) given by proposition 1, equations (1)-(8). This equilibrium is unique up to the allocation of bond holdings between MMFs and households and the return on interbank loans $R^I \leq R^M$. For notational convenience, we suppose that MMFs are the only private holders of bonds whenever there is no ambiguity.

To begin, we show that the proposed price system and allocation is an equilibrium. Equation (5) follows from the households' first order conditions and implies that they are indifferent between holding shares in MMFs and depositing funds in expectation at $t=0$. The equality of the MMF and bond returns follows immediately from the assumption of competitive pricing, and implies that the MMF is indifferent about the number of shares it issues. Hence $F^0 = \frac{B-M}{2}$ is optimal, and is necessary for bond market clearing. Equation (2) follows from the banks' first order condition and implies that banks are indifferent between holding loans or reserves on the asset side of their balance sheets. Equation (4) follows from indifference conditions about balance sheet size for the banks. In periods $t=0$ and $t=1$, the return from a marginal reserve must equal the cost of a marginal deposit in expectation. (In $t=1$, this indifference only need apply to the unshocked bank, by assumption.) The indifference condition in $t=0$ is given by $0 = \frac{1}{2}((R^M)^2 - R^{D^0} - Pc(D^0 + D^1)) + \frac{1}{2}((R^M)^2 - (1 - \lambda)R^{D^0} - \lambda R^M - Pc(D^0))$ and in $t=1$ it is $R^{D^1} + Pc(D^0 + D^1) = R^M$, where D^0 and D^1 are determined endogenously. Rearranging yields the first two equations in (4). Given the final equation in (4), $F^1 = 0$ is optimal for households. Binding budget constraints then directly implies $D^1 = \lambda D^0$. Then $D^0 = E - \frac{B-M}{2}$ is necessary to satisfy the households' budget constraints and, given the banks' indifference between loans and reserves at $t=0$, directly implies (1). By the assumptions that $r(\cdot) > 1$ and that $R^M > 0$ is set exogenously, there exists a positive P satisfying (8). Assumptions on $r(\cdot)$ imply that firms always demand $L > 0$, and given (8), (1) satisfies their first order conditions. Finally, given (7), unshocked banks in $t=1$ are indifferent between lending and keeping a marginal reserve, so (6) is clearly optimal. Thus, this allocation is an equilibrium under the given price system.

To show uniqueness, we argue that, aside from the possibility of $R^I < R^M$, these prices must hold in any equilibrium and that $I = 0$ in any equilibrium. The no-arbitrage arguments for (2), (4), and (5) show that these must hold in any equilibrium. To be explicit, (2) is required so that there is not infinite (zero) supply of loans and zero (infinite) demand for reserves; (4) is required for banks to demand positive, finite balance sheets; (5) is required for finite, positive household demand

for both deposits and bonds. If P does not satisfy (8), either the firms' first order conditions are not satisfied or one of the $t=0$ markets does not clear, so P must satisfy (8) in any equilibrium. To finish, we consider the household and bank portfolio decision at $t=1$. Suppose $R^{F1} > R^{D1}$. Then it is optimal for liquidity-shocked households to invest all of their withdrawn funds in the MMF such that $D^1 = 0$ and $F^1 = \lambda D^0$. In this case, the shocked bank holds $\frac{M}{2} - \lambda D^0$ reserves and the unshocked bank holds $\frac{M}{2}$ reserves (its volume of deposits is unchanged after the shock), so the market for reserves does not clear in $t=1$, a contradiction. So the only admissible equilibrium $t=1$ rates satisfy $R^{F1} \leq R^{D1}$. Similarly, $R^I \leq R^M$ is necessary for banks to have nonzero demand for reserves at $t=1$. If inequality is strict, no interbank loans will be issued because holding reserves strictly dominates lending them. Suppose the weak inequality binds and that (6) does not hold, that is, $I > 0$ in equilibrium. In this large-reserves regime, this would imply violations of both banks' $t=1$ budget constraints. Hence the shocked bank must lend back to the unshocked bank, and $I > 0$ cannot be an equilibrium. Hence, the proposed equilibrium is the unique symmetric equilibrium up to the return on interbank loans $R^I \leq R^M$.

Proof of Proposition 2. We show that if $\mathbf{M} < \overline{\mathbf{M}}$ and $r(E - \frac{B}{2}) > \frac{1}{2}R^M f(\lambda(E - \frac{B-M}{2}) - R^M \frac{M}{2})$, then there exists a unique equilibrium (Q,R) given by proposition 2, equations (1)-(8).

To begin, we show that equations (1)-(8) constitute an equilibrium. Equation (2) is a direct generalization of its analogue in proposition 1, and implies banks' indifference (in expectation) about holding loans or reserves as assets at $t=0$. The indifference condition is $0 = \frac{1}{2}(R^L - R^M(R^I - Pf(I))) + \frac{1}{2}(R^L - R^M R^I)$, where the first term is the unshocked bank's return on a marginal loan net the opportunity cost of holding a marginal reserve to be lent out, and the second term is the shocked bank's return on a marginal loan net the realized cost of not holding a marginal reserve. Similarly, Equation (4) is derived from banks' indifference about holding a marginal reserve and deposit at $t=0$, which is expressed as $0 = \frac{1}{2}(R^M R^I - R^{D0} - Pc(D^0 + D^1)) + \frac{1}{2}((R^M)^2 - (1 - \lambda)R^{D0} - \lambda R^I - Pc(D^0))$. Now, (7) implies that the unshocked bank is indifferent at $t=1$ between holding or lending a marginal reserve, when it has already lent I . Hence, (6) is optimal given (7) and also ensures market clearing for deposits at $t=1$. Consider P is given by $P = \frac{R^L}{r(E - \frac{B}{2})}$. Expanding R^L and rearranging shows that this is equivalent to $P = \frac{(R^M)^2}{r(L) - \frac{1}{2}R^M f(I)}$ when L , R^L and L assume their equilibrium values given by (1), (2) and (7). The arguments in the proof of proposition 1 show that equations (1), (3), and (5) follow from (2) and (4),

and are also consistent with firm optimization given (8). Now, (7) implies that the unshocked bank is indifferent at $t=1$ between holding or lending a marginal reserve, when it has already lent I . Hence, (6) is optimal given (7) and also ensures market clearing for deposits at $t=1$. Hence, (1)-(8) define a competitive equilibrium.

To show uniqueness, it suffices to show that the price system must hold in any equilibrium. The above arguments then imply that the allocation is the unique symmetric equilibrium. The price system must hold in any equilibrium by arguments identical to those in the proof of proposition 1 in addition to the observations that, first, (7) must hold in order for interbank loan supply to be positive and finite, and second, (6) must hold exactly to satisfy the banks' $t=1$ budget constraints and clear the market for $t=1$ deposits. Hence, (1)-(8) define the unique symmetric equilibrium.

Proof of Proposition 10 We will first introduce some notation and then restate and prove the proposition. First, note that the equilibrium $t = 0$ and $t = 1$ deposit rates can be written as a function of the amount of term RRPs that is invested in by the household of each sector through the MMF. Denote the functions $R^{D0}(RP^{TM})$ and $R^{D1}(RP^{TM})$ respectively.³⁷ Now, recall that term RRPs absorb reserves. Thus, we define $\widehat{RP^{TM}} = \frac{(\mathbf{M}-\overline{\mathbf{M}})}{2}$ as a threshold level of total term RRPs contributed by the endowment of each sector so that if any additional units were supplied, the interbank market would be triggered.

Furthermore, we define \widehat{R}^{D0} and \widehat{R}^{D1} as the equilibrium rates that would result if $2\widehat{RP^{TM}}$ and $\overline{\mathbf{M}}$ were supplied by the central bank:

$$\begin{aligned}\widehat{R}^{D0} &= \frac{2}{2-\lambda} \left[(R^M)^2 - \frac{\lambda R^M}{2} - P \left(\frac{1}{2} c \left(E - \frac{B}{2} - \frac{\overline{\mathbf{M}}}{2} \right) + \frac{1}{2} c \left((1+\lambda) \left(E - \frac{B}{2} - \frac{\overline{\mathbf{M}}}{2} \right) \right) \right) \right] \\ \widehat{R}^{D1} &= R^M - P c \left((1+\lambda) \left(E - \frac{B}{2} - \frac{\overline{\mathbf{M}}}{2} \right) \right)\end{aligned}$$

Finally we define \widehat{R}^{TM} as:

$$\widehat{R}^{TM} = \frac{\lambda}{2} \widehat{R}^{D0} + \left(1 - \frac{\lambda}{2} \right) \widehat{R}^{D1}$$

Now we restate the proposition:

Restatement of Proposition 10: For $\frac{\lambda}{2} R^{D0} + \left(1 - \frac{\lambda}{2} \right) R^{D1} < R^{TM} \leq \widehat{R}^{TM}$, where R^{D0} and R^{D1} are the equilibrium rates given in proposition 1, there exists a

³⁷In this proof we denote RP^{TM} as the amount of each households endowment that goes to funding the MMFs investment in term RRPs. It is equal to half of the total amount of term RRPs supplied by the MMF.

competitive equilibrium where $R^B = R^{TM}$ and $RP^{TM*} > 0$, where RP^{TM*} is the term RRP quantity consumed by each sector. Furthermore, R^{D0} and R^{D1} rise to $R^{D0'} > R^{D0}$ and $R^{D1'} > R^{D1}$, and D^0 and D^1 reduce to $D^{0'}$ and $D^{1'}$. All other rates and quantities remain unchanged. This is the only equilibrium in which the interbank market is not triggered.

Little actually remains to be proved. Note that both the equilibrium rates $R^{D0}(RP^{TM})$ and $R^{D1}(RP^{TM})$ are continuous and strictly increasing in TM by proposition 1, therefore the expression $\frac{\lambda}{2}R^{D0}(RP^{TM}) + (1 - \frac{\lambda}{2})R^{D1}(RP^{TM})$ is continuous and strictly increasing in RP^{TM} . Also $\frac{\lambda}{2}R^{D0}(0) + (1 - \frac{\lambda}{2})R^{D1}(0) = \frac{\lambda}{2}R^{D0} + (1 - \frac{\lambda}{2})R^{D1} < R^{TM}$ by assumption, and $\frac{\lambda}{2}R^{D0}(\widehat{RP^{TM}}) + (1 - \frac{\lambda}{2})R^{D1}(\widehat{RP^{TM}}) = \widehat{R^{TM}} > R^{TM}$. Intermediate value theorem mandates that there exists a $0 < RP^{TM*} < \widehat{RP^{TM}}$ such that $\frac{\lambda}{2}R^{D0}(RP^{TM*}) + (1 - \frac{\lambda}{2})R^{D1}(RP^{TM*}) = R^{TM}$. RP^{TM*} is our equilibrium Term RRP consumption for each sectors. Clearly $R^B = R^{TM}$ for equilibrium in the bond market. R^{D0} and R^{D1} have increased to $R^{D0'} = R^{D0}(RP^{TM*})$ and $R^{D1'} = R^{D1}(RP^{TM*})$ respectively. D^0 and D^1 reduce to $D^{0'} = E - \frac{B}{2} + (\frac{M}{2} - RP^{TM*})$ and $D^{1'} = \lambda D^{0'}$ respectively. Uniqueness follows immediately from the fact that the expression $\frac{\lambda}{2}R^{D0}(RP^{TM}) + (1 - \frac{\lambda}{2})R^{D1}(RP^{TM})$ is strictly increasing

Proof of Proposition 11³⁸: We first rewrite the R^{D0} of proposition 2 in terms of the quantity of term RRPs (RP^{TM}) and TDF (T) invested in by the sectors. Note that in this case $D^0 = E - \frac{B}{2} + \frac{M}{2} - RP^{TM}$, $D^1 = \lambda D^0$. Also we denote M' as the effective level of reserve holdings each sector holds after central bank issuance of term RRPs and TDFs. That is $M' = \frac{M}{2} - RP^{TM} - T$.

$$R^{D0}(RP^{TM}, T) = \frac{2}{2 - \lambda} \left[(R^M)^2 - \frac{\lambda R^M}{2} + Pf(\lambda D^0 - (R^M)^{1/2} M') \left(\frac{R^M}{2} - \frac{\lambda}{2} \right) - P \left(\frac{1}{2} c(D^0) + \frac{1}{2} c((1 + \lambda)(D^0)) \right) \right]$$

We define the following quantities:

$$\begin{aligned} \alpha &= \frac{1}{2 - \lambda} \\ \beta &= r(L) - \frac{1}{2} R^M f(\lambda D^0 - R^M M') \\ \phi &= f(\lambda D^0 - R^M M')(R^M - \lambda) - (c(D^0) + c((1 + \lambda)(D^0))) \end{aligned}$$

³⁸As in the proof of proposition 10, we denote RP^{TM} and T as the amount contributed by each sector rather than the total supply.

Now taking the derivatives of R^{D0} with respect to both RP^{TM} and T , algebra will yield:

$$\begin{aligned}\frac{\partial R^{D0}}{\partial RP^{TM}} &= \alpha P \left(\frac{R^M (R^M - \lambda) f'(I) \phi}{2\beta} + f'(I) (R^M - \lambda)^2 + c'(D^0) + (1 + \lambda) c'((1 + \lambda) D^0) \right) \\ \frac{\partial R^{D0}}{\partial T} &= \alpha P \left(\frac{(R^M)^2 f'(I) \phi}{2\beta} + f'(I) R^M (R^M - \lambda) \right)\end{aligned}$$

We can now write the expression:

$$\frac{\partial R^{D0}}{\partial T} - \frac{\partial R^{D0}}{\partial RP^{TM}} = \alpha P \left(\frac{R^M f'(I) \lambda \phi}{2\beta} + f'(I) (R^M - \lambda) \lambda - c'(D^0) - (1 + \lambda) c'((1 + \lambda) D^0) \right)$$

From the above equation, we can see that $\frac{\partial R^{D0}}{\partial T} - \frac{\partial R^{D0}}{\partial RP^{TM}} > 0$ when:

$$f'(I) \left(\frac{R^M \lambda \phi}{2\beta} + (R^M - \lambda) \lambda \right) > c'(D^0) + (1 + \lambda) c'((1 + \lambda) D^0)$$

Since it was assumed that both $f(\cdot)$ and $c(\cdot)$ are convex, their derivatives are both increasing in interbank and deposits respectively. Also, β is decreasing and ϕ increasing in the marginal interbank lending cost, so the left side of the inequality will be increasing in the marginal interbank cost. ϕ is decreasing in the marginal balance sheet cost, so the left side of the inequality is decreasing in marginal balance sheet costs. Thus, we have that the left side of the inequality will be larger when 1) Interbank lending is high and 2) deposits are low.

Appendix: Figures

Figure 1

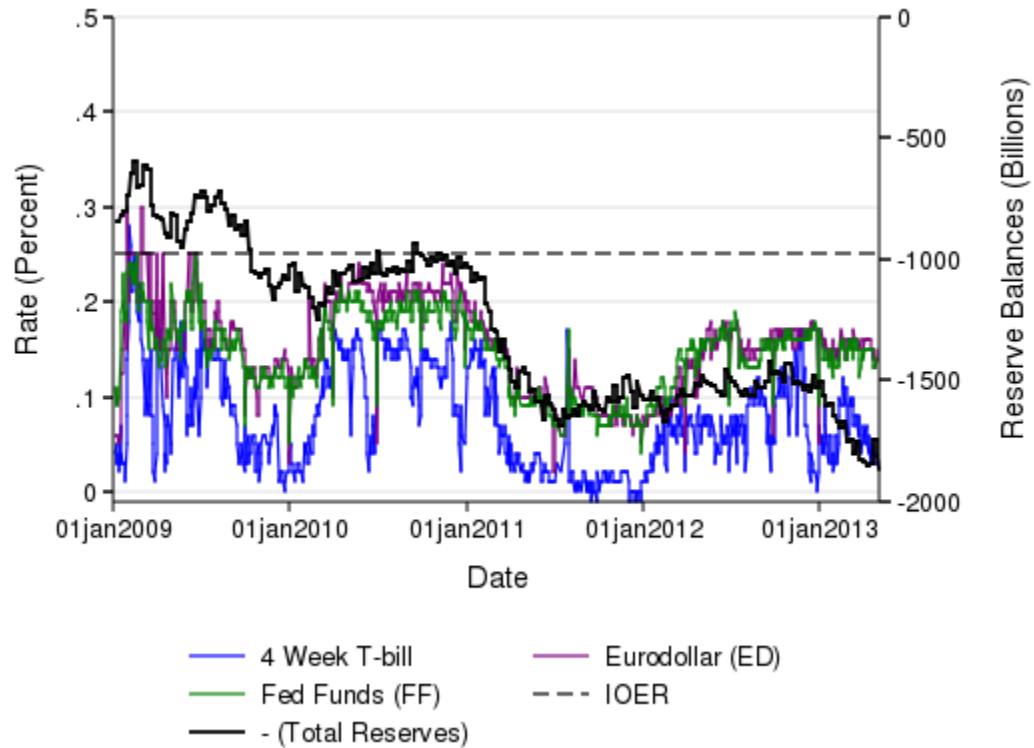
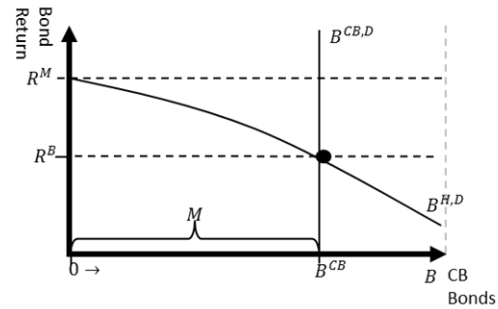
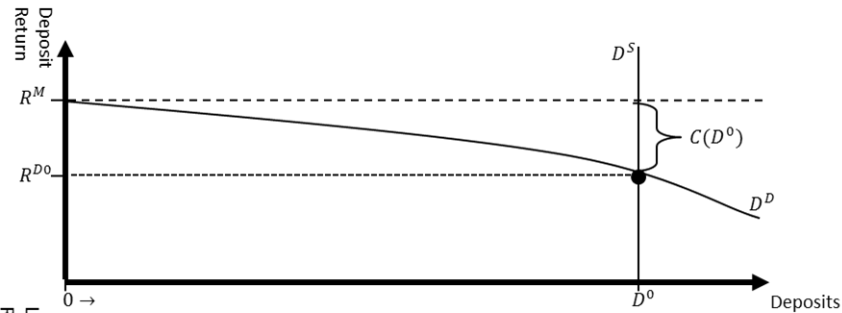

Figure 2



(A)



(B)

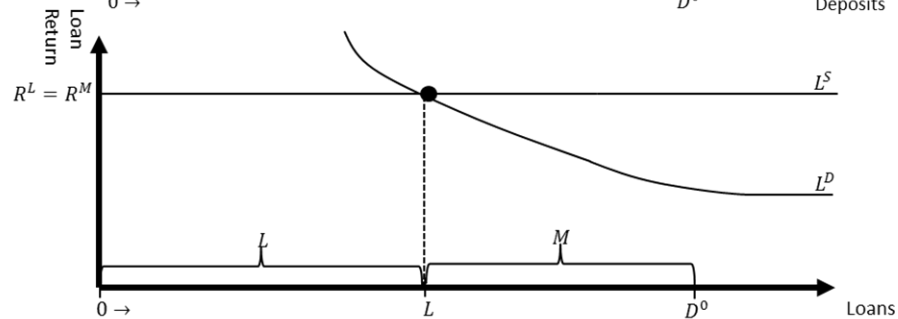

(C)

- (A) Bond market: Household bond holdings increase leftward. As households hold more bonds, deposits decrease in equilibrium. Deposit rates are less depressed by balance sheet costs, and the equilibrium bond rate rises.
- (B) Deposit market: Bond market clearing and the binding resource constraint forces household supply of deposits to be perfectly inelastic. Banks never offer a deposit rate higher than IOR, else they would be making negative profit on marginal deposits. Banks' demand for deposits are decreasing in the deposit rate.
- (C) Loan market: Banks' loan supply correspondence is zero below IOR, infinite above IOR, and perfectly elastic at IOR. Firms' demand for loans is decreasing in the loan rate.

Figure 3

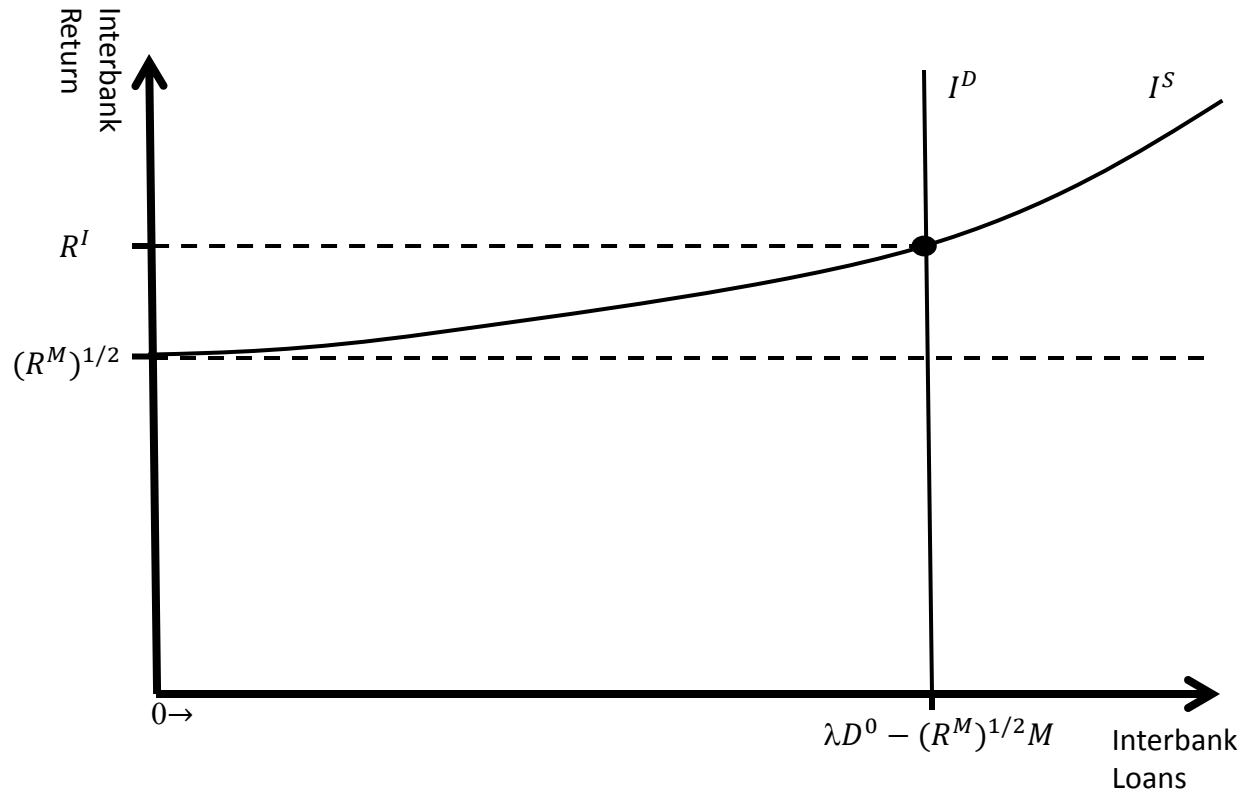

Interbank market: When the interbank market is inactive, arbitrage forces the interbank rate to equal IOR. For positive volumes of interbank trade, lending frictions force a wedge between IOR and the interbank rate. The shocked bank demands exactly enough interbank funds to fully cover the liquidity shock. The unshocked bank's supply of loans is increasing in the interbank rate (which makes lending more profitable).

Figure 4

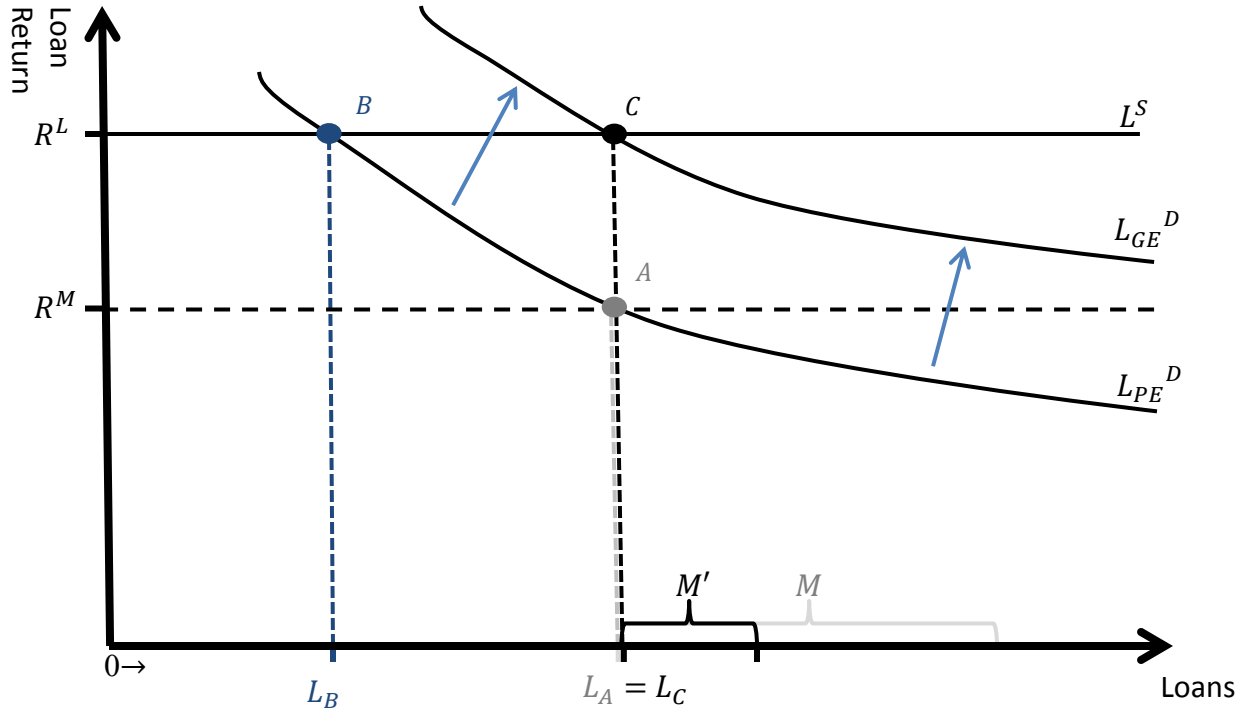

Assume that $M \geq \bar{M} > M'$. With reserves M , the equilibrium at Point A is given by Proposition 1. Consider a decrease in reserves to M' . Point B shows the partial equilibrium effect: the interbank market becomes active, forcing a wedge between the loan rate and IOR. As the supply curve shifts upward with the loan rate, the new (partial) equilibria are traced by the (partial equilibrium) demand curve. Interbank lending frictions also force inflation (an increase in P) as in Equation 7 of Proposition 2. Inflation shifts out the demand for loans in general equilibrium, which results in the final (general) equilibrium at Point C. Note that the volume of loans is unchanged, as it must be due to resource constraints.

Figure 5

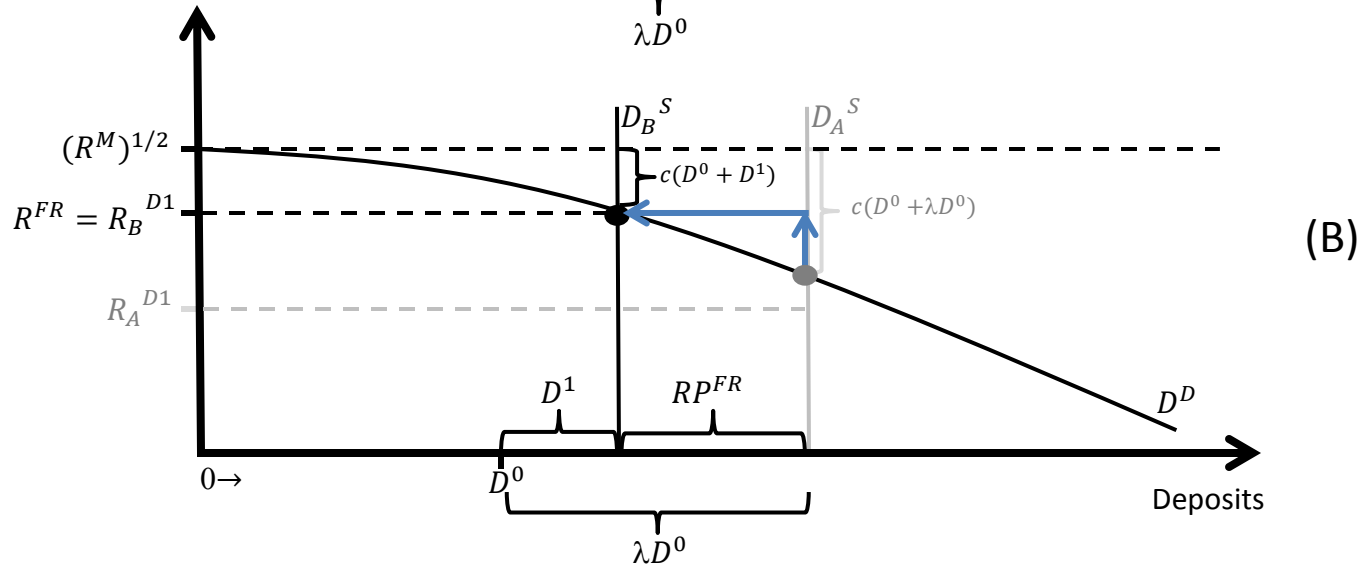
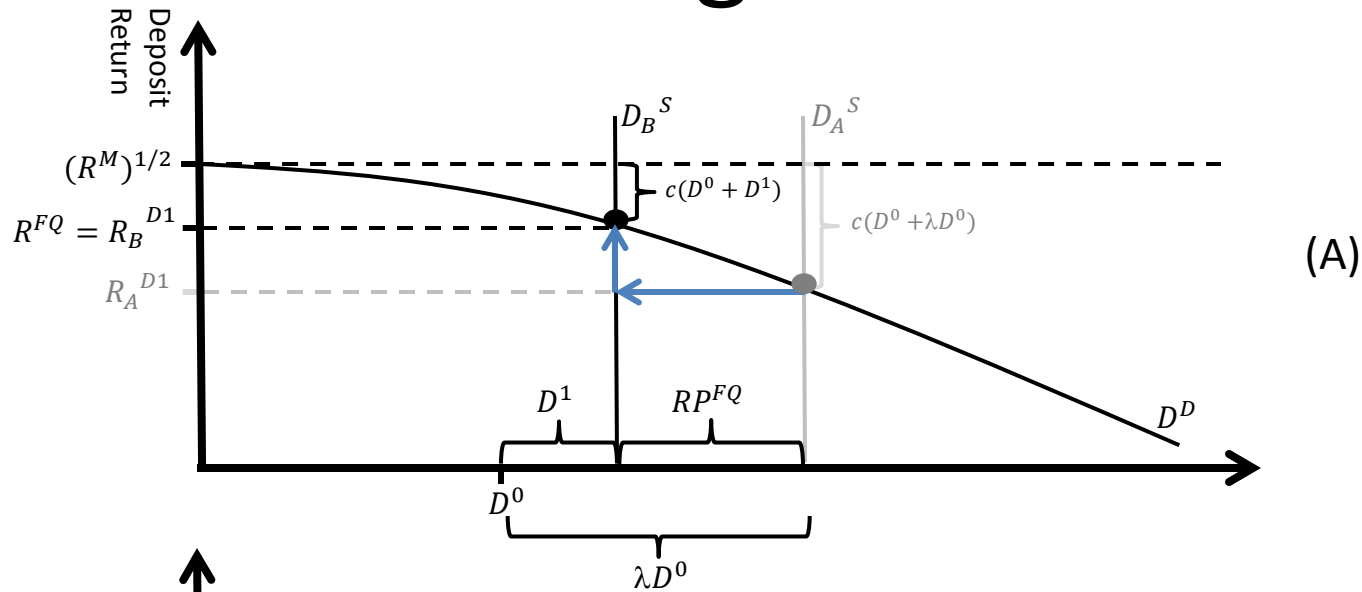

(A) Deposit market with fixed-quantity RRP: Deposits supplied by households mechanically decrease by the amount of RRP supplied, which forces the deposit rate up to equal the market-determined RRP rate. The presence of RRP decreases balance sheet costs, thereby decreasing the spread between the deposit rate and IOR.

(B) Deposit market with fixed-rate RRP: The deposit rate increases to match the exogenous RRP rate and market clearing forces household deposit supply to decrease. As in (A), smaller balance sheet costs decrease the spread between the deposit rate and IOR.

Note: Figures shown with equal volumes of RRP to demonstrate Proposition 5.

Figure 6

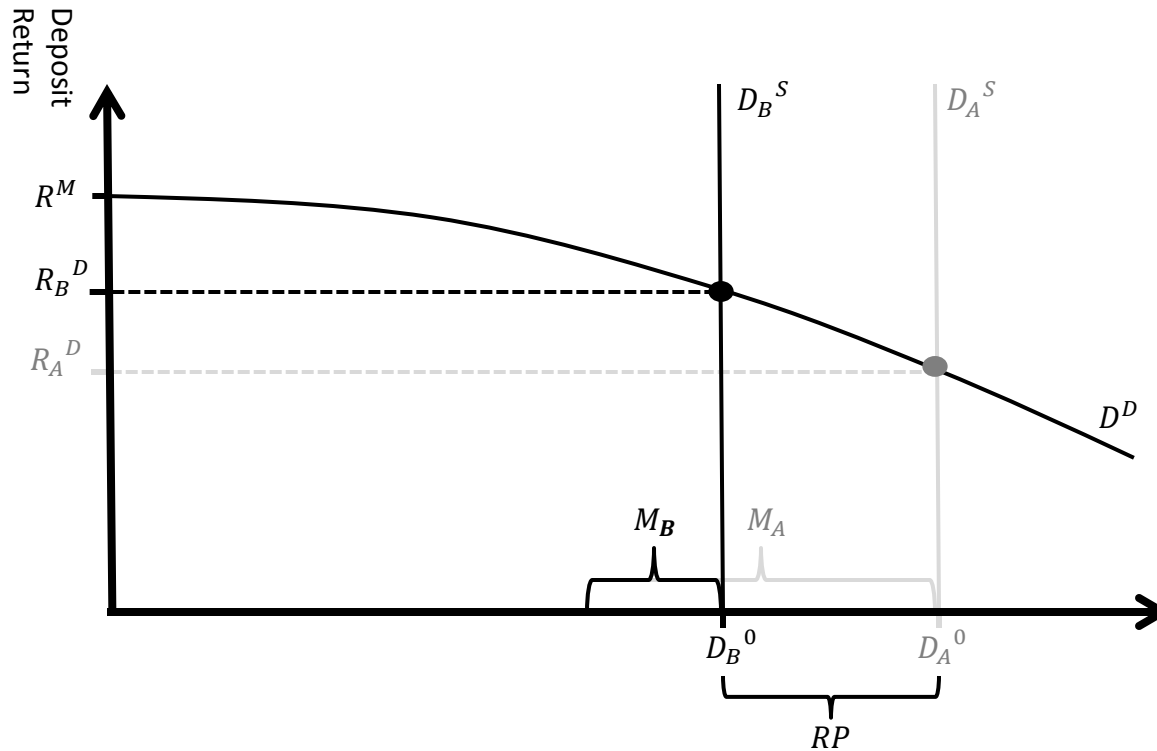

Deposit market with daily RRP: The presence of RRP forces down the household supply of deposits one-for-one with reserves. Fewer deposits imply smaller balance sheet costs, which decreases the spread between the deposit rate and IOR.

Figure 7

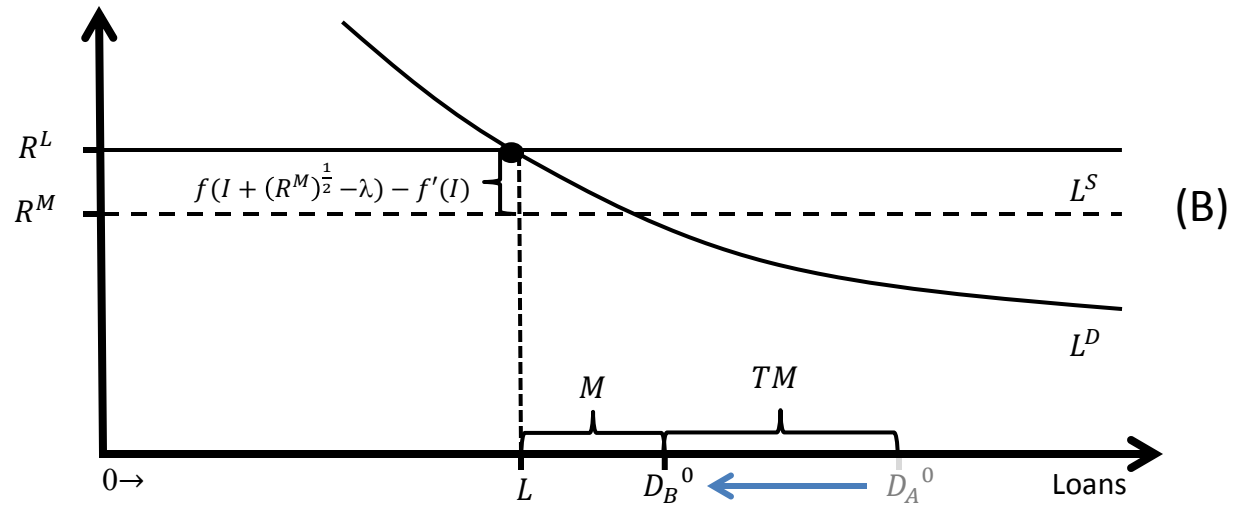
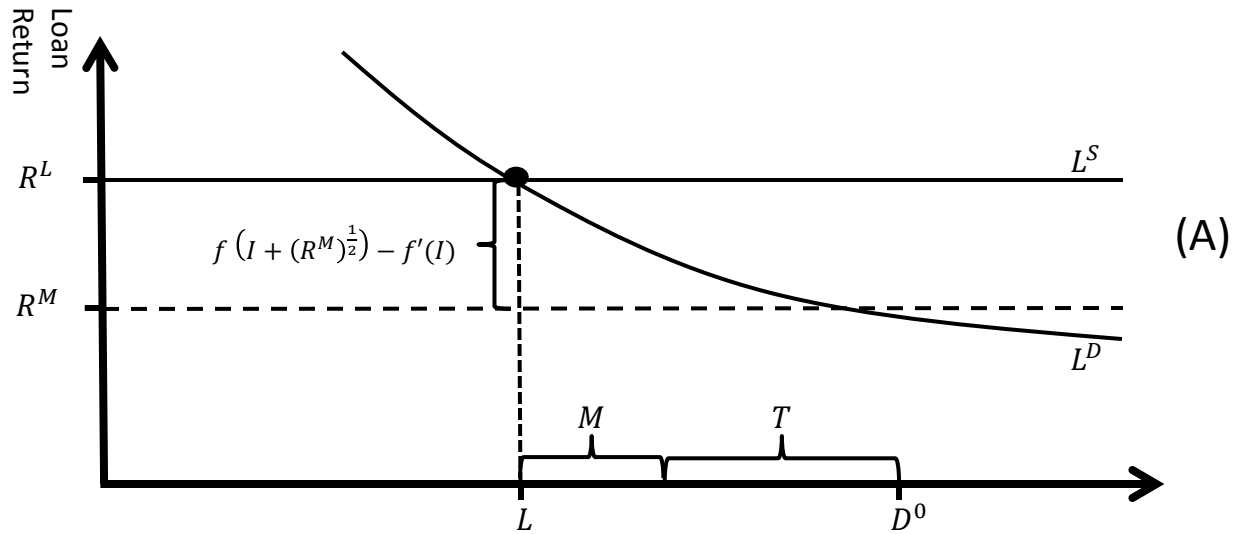

- (A) Loan market with TDF: The TDF soaks up reserves from the banks, activating the interbank market and driving a wedge between the loan rate and IOR. Households supply the same quantity of deposits.
- (B) Loan market with term RRP: The RRP forces down household deposit supply one-for-one with reserves. The drop in reserves drives a wedge between the loan rate and IOR, but the drop in deposits dampens the required volume of interbank lending relative to (A). Hence, the spread between the loan rate and IOR is smaller for term RRP.