

NOTA DI LAVORO

79.2013

Understanding the Consumption Behaviors on Electric Vehicles in China - A Stated Preference Analysis

By **Libo Wu**, School of Economics,
Fudan University, Center for Energy
Economics and Strategy Studies, Fudan
University, Fudan-Tyndall Center, China

Changhe Li, School of Economics,
Fudan University, China

Haoqi Qian, School of Economics,
Fudan University, Center for Energy
Economics and Strategy Studies, Fudan
University, China

ZhongXiang Zhang, School of
Economics, Fudan University, Center
for Energy Economics and Strategy
Studies, Fudan University, China

Climate Change and Sustainable Development

Series Editor: Carlo Carraro

Understanding the Consumption Behaviors on Electric Vehicles in China - A Stated Preference Analysis

By Libo Wu, School of Economics, Fudan University, Center for Energy Economics and Strategy Studies, Fudan University, Fudan-Tyndall Center, China

Changhe Li, School of Economics, Fudan University, China

Haoqi Qian, School of Economics, Fudan University, Center for Energy Economics and Strategy Studies, Fudan University, China

ZhongXiang Zhang, School of Economics, Fudan University, Center for Energy Economics and Strategy Studies, Fudan University, China

Summary

This paper examines how the different characteristics of both electric vehicles themselves and the consumers would influence the consumption behavior on electric vehicles. Data collection is based on the questionnaire design using the orthogonal experimental method and large-scale stated preference survey covering more than 2000 households in 10 central districts of Shanghai. Three types of electric vehicles, i.e. fast charging, battery swapping and slowing charging are investigated according to a set of factors, such as acquisition costs, operation and maintenance costs, charging time and convenience, mileage, preferential policies and so on. We analyze the data with the nested-logit model. Our results suggest that the mode of battery swapping with slowing charging enjoys a relatively higher proportion in Shanghai, though there is no absolutely dominating type. By group classification analysis, the male, the young, the well-educated and the well-paid groups share relatively low proportion of selecting electric vehicles. Furthermore, consumers pay more attention to daily variable usage cost and charging time instead of acquisition costs. All these suggest the necessity for the government to adjust the current supporting policy in order to cultivate the electric vehicle market effectively.

Keywords: Electric Vehicle, Nested-Logit Model, Stated Preference Experiment, Willingness to Pay

JEL Classification: Q41, Q42, Q48, Q54, Q55, Q58, C65, C83

Address for correspondence:

ZhongXiang Zhang
Distinguished Professor and Chairman
Department of Public Economics
School of Economics
Fudan University
600 Guoquan Road
Shanghai 200433
China
Phone: +86 21 65642734
Fax: +86 21 65647719
E-mail: ZXZ@fudan.edu.cn

Understanding the Consumption Behaviors on Electric Vehicle in China - A Stated Preference Analysis

Libo Wu^{◦, ♦, ▫} Changhe Li[◦] Haoqi Qian^{◦, ♦} ZhongXiang Zhang^{◦, ♦, *}

[◦]School of Economics, Fudan University, Shanghai 200433, China

[♦]Center for Energy Economics and Strategy Studies, Fudan University, Shanghai
200433, China

[▫]Fudan-Tyndall Center , Shanghai 200433, China

Abstract

This paper examines how the different characteristics of both electric vehicles themselves and the consumers would influence the consumption behavior on electric vehicles. Data collection is based on the questionnaire design using the orthogonal experimental method and large-scale stated preference survey covering more than 2000 households in 10 central districts of Shanghai. Three types of electric vehicles, i.e. fast charging, battery swapping and slowing charging are investigated according to a set of factors, such as acquisition costs, operation and maintenance costs, charging time and convenience, mileage, preferential policies and so on. We analyze the data with the nested-logit model.

Our results suggest that the mode of battery swapping with slowing charging enjoys a relatively higher proportion in Shanghai, though there is no absolutely dominating type. By group classification analysis, the male, the young, the well-educated and the well-paid groups share relatively low proportion of selecting electric vehicles. Furthermore, consumers pay more

attention to daily variable usage cost and charging time instead of acquisition costs. All these suggest the necessity for the government to adjust the current supporting policy in order to cultivate the electric vehicle market effectively.

Keywords: Electric vehicle; Nested-logit model; Stated preference experiment; Willingness to pay

JEL Classification: Q41; Q42; Q48; Q54; Q55 ; Q58; C65 ; C83

*** Address for correspondence:**

ZhongXiang Zhang
Distinguished Professor and Chairman
Department of Public Economics
School of Economics
Fudan University
600 Guoquan Road
Shanghai 200433
China
Tel: +86 21 65642734
Fax: +86 21 65647719
Email: ZXZ@fudan.edu.cn

1. Introduction

The transport sector is the main source of growing air pollution and greenhouse gas emissions. Greening the transport is widely considered as an effective means of addressing such environmental issues. In the context, electric vehicle (EV) is part of an integrated package of such a greening strategy, and will play an increasing role.

Indeed, EV has an unparalleled advantage in energy efficiency. Its energy efficiency is 3 times that of the traditional internal combustion vehicle and 2 times that of the plug-in vehicle [12]. Meanwhile, calculated in the current power and oil price, the EV fuel cost is much lower than that of internal combustion vehicle [11]. However, the development of electric vehicle is still hindered by various factors. On the one hand, owing to the high battery cost, the acquisition and O&M costs of electric vehicle are higher than that of the internal combustion vehicle. On the other hand, compared to internal combustion vehicle, electric vehicle still suffers some technical defects. Nowadays the on-going EV demonstration projects in China are mainly concentrated in the public transport and utilities sectors. However, little research has paid attention to the demand side of electric vehicles. The factors influencing consumers' demand for green transport remain still unclear. Meanwhile, due to the significant social benefits from EV promotion and application, it is essential for the government to compensate and encourage both the manufacturers and consumers via payment transfer, thus providing a sustainable public supply that has a nature of positive externality. Theoretically, the key issue lies on the consumers' acceptance and preference to green products and the valuation of environmental risk premium, which is directly related to the allocation of government subsidies, the tax structure adjustment and the regulation on traditional internal combustion vehicles.

There have been growing studies on the demand preference of transport mode. In particular, since the 1990s, a large variety of policy needs targeted at

the governance of externalities in the transport sector have made this research area much more active. Design of the congestion tax system, construction of the rapid transportation system, amendment of the fuel-economy standards and development of the alternative energy vehicles are all calling for the micro study about demand preference of transport mode. Based on the behavioral experiments and discrete choice models, the stated preference analysis is the widely-used theoretical approach, especially for the measurement of environmental value which can be progressed without the existence of a realistic trading market.

For example, at the beginning of the 1990s, scholars have conducted a series of studies on consumers' choices of alternative energy and clean fuel vehicles in California, U.S. (Bunch et al. [7], Golob et al. [9], Nesbitt and Sperling [17], Brownstone et al. [4] [5], Martin [15]). Stated preference survey combined with a variety of discrete choice models is widely adopted in these studies. Layton [8] bridged random coefficient models with the preference survey and brought the willingness to pay (WTP) analysis into environmental issues. Adamowicz et al. [2] combine two types of preference methods together to value environmental amenities. And then a question lies ahead is what kinds of positive feedbacks would the consumers give back to in terms of the stimulus plans?

Since this century, as the perspective of scaled up EV application is becoming more evident, some studies on demand-side behavior were undertaken for Canada (Potoglou & Kanaroglou [21]), the United Kingdom (Mourato et al. [16], O'Garra et al. [18] [19], Lane & Potter [13]), Germany (Adamson [3]) and Netherlands (Mabit & Fosgerau [14]). Differing from California, regional environmental problems in these countries are not that severe. The reforming pressure of the transport sector in these countries comes mainly from the need for low carbon transformation. Based on the collected samples, such studies analyzed the relationships among consumers'

preference for different types of clean energy vehicles, consumers' individual characteristics, driving characteristics and vehicle characteristics. For example, Mourato et al. [16] focused on the degree of taxi's acceptance of fuel cell vehicles. Adler et al. [1] devised a three-tier experiment containing gasoline vehicle, hybrid vehicle and diesel vehicle. With the application of nested-logit model, it is found that battery cost and effective incentives are the determining factors for Californian residents' acceptances toward electric vehicle and, meanwhile, daily transport cost and charging time also matter. With the use of E-questionnaire technology, Potoglou and Kanaroglou [21] undertook a study for the Hamilton Urban Circle, Canada, which is similar to the California case of Adler et al. They scheme out three options in the questionnaire: gasoline vehicle, hybrid vehicle and battery swapping vehicle, incorporate the often ignored neighbors' characteristics as one of the factors affecting the choices of transport modes, and analyze the data using a three-tier nested-logit model. According to their research, acquisition cost, tax break and low emission rate are the factors that influence residents' choices most, whereas other incentive measures such as free parking show little effect.

Existing studies have suggested that, no matter whether it is based on independent selection experiment or contingent valuation method, consumers' demand preference for new energy vehicles is closely related to regional, population and time characteristics. Therefore, there is great need to carry out more specific experimental studies in places that are at different development stages, have various transportation modes and have diversifying population characteristics. Such studies aim to find out the influential characteristics of the EV demand, investigate whether and to what extent preferential policies to promote the development of new energy vehicles, such as acquisition subsidy, gasoline tax and congestion fee reduction, electricity price subsidy and reserved parking lots, are effective, and examine whether the conclusions from the stated preference experiment of other regions can be applied directly.

To that end, this paper examines how the different characteristics of both electric vehicles and the consumers would influence consumers' preference, as well as the incentive policy effect in Shanghai¹. In Section 2, we discuss the orthogonal experimental method in our survey and the nested-logit model. In the aforementioned studies for industrialized countries, none of them has taken the charging mode into consideration. In fact, such factor not only has a bearing on charging time and convenience, but also is directly linked to acquisition costs and daily usage cost. In our study, we have taken the factor into consideration, and have addressed the complication of additional choice branch and valuation level. In Section 3, we detail unique survey designs and data collections. Section 4 provides statistic analysis of the results. The paper ends with some concluding remarks and policy implications.

2. Methodology

2.1 Experimental Design

In this paper, we focus on consumers' demand characteristics of three EV modes: fast charging, battery swapping and slow charging. On the basis of the stated preference experiment, we set two categories involving "gasoline

¹ Shanghai is the center of economy, finance, shipping and trade in China, which has a high rising tendency in motorization. From 2000 to 2009, the number of civilian vehicles in Shanghai increased by 280%, resulting in a rapid rise in transport energy demand from 11.6% to 19.1% of the total energy consumption during the period. Among the 22 megacities in Asia, Shanghai tops the list for energy consumption per unit of GDP and CO₂ emission per capita, making Shanghai become a typical high-carbon city (Asian Green City Index, 2011). Meanwhile, car emissions such as NO_x, PM, and O₃ have become the major pollution problems in Shanghai. Shanghai is now the demonstration city of low-carbon and new energy vehicle subsidy. During the WORLD EXPO 2010, more than 1300 new energy vehicles were put into operation, which is to date the largest pilot program of new energy vehicles. Moreover, there has been an increasing awareness for new energy vehicles. All the features mentioned above make Shanghai an ideal city to do the large-scale survey.

vehicle” and “electric vehicle” in the first-tier choice branch, where the electric vehicle has three sub-branches: battery swapping only, fast charging complemented with slow charging (fast charging & slow charging) and battery swapping complemented with slow charging (battery swapping & slow charging). We make this combination of the single and composite modes in order to simulate the features of real-world applications accurately and to address the on-going debate on different types of charging while there is no easy way to figure out which mode could succeed without others’ assistance.

Then we set the characteristic factors corresponding to each type of vehicles. Combining with the information from the electric vehicle demonstration project in Shanghai, as well as the preliminary results of the study², we finally select three main attributes: economic cost attribute, technical attribute and policy factor. Economic cost attribute factor includes three variables: acquisition cost (sum of vehicle body price and battery price), fuel cost (oil cost or power charging cost) and maintenance cost (sum of car body maintenance cost, battery maintenance cost and insurance premium); technology attribute factor consists of three variables: charging time (time for fuel charging or battery charging), charging convenience (charging station distribution density and the proportion of electronic schedule system equipped), and mileage; policy factor involves some preferential policies (congestion fee, distribution of pre-sale charging cards and availability of reserved parking lots). Based on the current domestic standards, related industry reports and interviews with experts of the power utility and auto sectors, three valuation levels are set for each variable.

²Compared with the final questionnaire, the preliminary one includes “noise pollution” and “personal consumption psychology”. The personal consumption psychology is to investigate in which stage the consumers tend to buy the product in the promotion stage. The main electric vehicle market promotion stages include 3 states: the starter stage, the development stage and the mature stage. But the preliminary results show that respondents are not sensitive to these two variables, so we dropped them out from the final questionnaire.

Given four types of vehicles and seven variables with each assigned three levels,, we can get 2187 combination sets in total. However, it would be very costly but unnecessary if all the possible sets are fulfilled in a large scale survey. Therefore, we adopted the orthogonal experimental method as the basic designing method in our survey. Thus, an orthogonal table is built generally for an experimental design and statistical analysis. The method could give consideration to the advantages of both the full-scale testing method and simple comparison method to the maximum extent. Based on the method, we can ensure the high representativeness and convenience of the large experiment. See Table 1 for our final questionnaire settings.

Table 1 Related factors and levels assigned in the EV home-entry investigation questionnaire

Attribute	Car A	Car B	Car C	Car D		
Vehicle type	Gasoline vehicle	Electric vehicle				
Acquisition price	150,000	50,000	150,000	50,000		
		75,000	200,000	75,000		
		100,000	250,000	100,000		
Fuel cost	¥0.8/km	¥0.4/km	¥0.1/km	¥0.3/km		
		¥0.6/km	¥0.15/km	¥0.4/km		
		¥0.8/km	¥0.2/km	¥0.5/km		
Maintenance cost (fix cost and insurance premium)	¥10,000/ year	¥6,000/year	¥30,000/year	¥8,000/year		
		¥5,000/year	¥20,000/year	¥7,000/year		
		¥4,000/year	¥15,000/year	¥6,000/year		
Mileage	400km	125km	125km	125km		
		150km	150km	150km		
		225km	225km	225km		
Preferential policy	No congestion fee	None	None	None		
		pre-sale charging card	pre-sale charging card	pre-sale charging card		
		Reversed parking lots	Reserved parking lots	Reserved parking lots		
Charging mode	Gas station	Battery Swapping	Fast charging	Slow charging	Battery Swapping	Slow charging
Charging Convenience		Charging station density: 10% of the current gas station density	Fast charging station density: 10% of the current gas station density	100% in parking lots	Charging station density: 10% of the current gas station density	100% in the parking lots

	The current gas station density	Charging station density: 50% of the current gas station density	Fast charging station density: 30% of the current gas station density	80% in the parking lots	Charging station density: 30% of the current gas station density	80% in the parking lots
		Charging station density: 70% of the current gas station density	Fast charging station density: 50% of the current gas station density	50% of the parking lots	Charging station density: 50% of the current gas station density	50% of the parking lots
	No electronic schedule system equipped	Electronic schedule system equipped				
Charging time	5 minutes	5minutes	50% in 5 minutes	100% in 5 hours	3 minutes	100% in 3 hours
		10minutes	50% in 10 minutes	100% in 5 hours	3 minutes	100% in 3 hours
		15minutes	50% in 15 minutes	100% in 5 hours	3 minutes	100% in 3 hours

2.2 Nested-logit Model

In our experiment, consumers face a two-tier choice branch. In order to keep authenticity of the result, consumers' choices should be kept independent and options will not influence each other. This is the so-called independence of irrelevant alternatives (IIA), which means that for the consumers, the probability ratio of choosing from two alternatives will not be influenced by the fixed term of the utility function. The more similarities between the characteristics of alternatives, the more likely the IIA would be unsatisfied. In our study, there are many similarities among different kinds of electric vehicles, which share little in common with the gasoline vehicle, thus failing to meet the IIA condition. Thus, we applied the nested-logit model to estimate the influential parameters in the questionnaire. See Figure 1 for the choice structure tree.

Figure 1 Choice structure tree

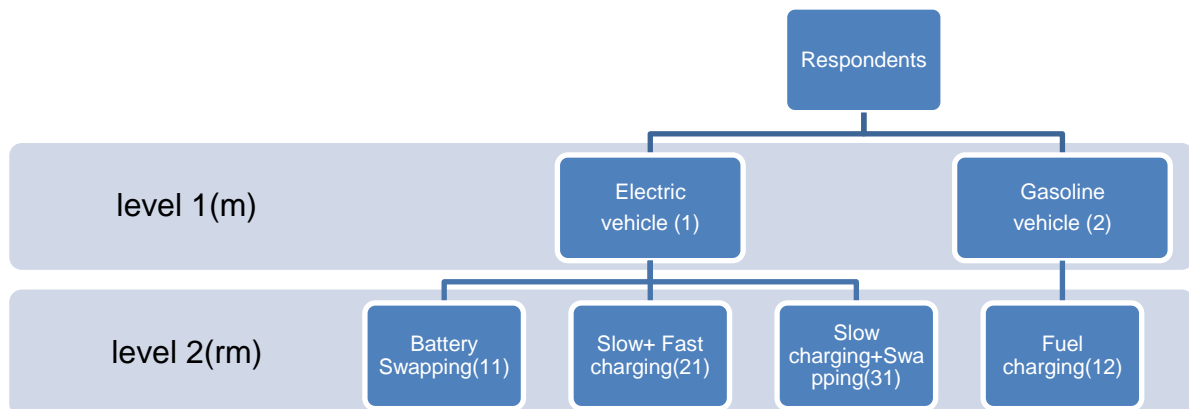

The subscription “ rm ” indicates the consumers' final choice, of which “ m ” represents the EV and gasoline vehicle categories in the first tier; “ $r=1,2,\dots$,” indicates the corresponding sub-category in tier 2 under every choice category in tier 1. Hence, subscription “12” means that consumer has finally chosen the gasoline vehicle, subscription “11” the battery swapping electric vehicle and so forth. Therefore, we can get the probability of the choice of the n^{th} consumer

as follows:

$$P_n(rm) = P_n(r|m)P_n(m)$$

$P_n(r|m)$ is the conditional probability that the r category in level 1 is chosen given that the m category in level 1 is chosen. $P_n(m)$ is the probability that the m category is chosen in level 1. According to the random utility theory, we can get:

$$U_{rnn} = V_{(r|m)n} + \varepsilon_{(r|m)n} + V_{mn} + \varepsilon_{mn}$$

U_{rnn} is the utility when the n th consumer chooses the alternative “ rm ”. $V_{(r|m)n}$ is the changing part of the utility’s fixed term as a result of the combination of “ rm ” and “ m ” when consumer chooses the alternative “ rm ”. $\varepsilon_{(r|m)n}$ is the probability corresponding to $V_{(r|m)n}$. V_{mn} is the fixed term that is irrelevant to “ r ” and changes with m when consumer picks the alternative “ rm ”. ε_{mn} is the probability corresponding to V_{mn} . $\varepsilon_{(r|m)n}$ and ε_{mn} follow a double exponential distribution with a zero mean and a variance σ_1^2, σ_2^2 respectively.

According to the multi nominal logit model, we get:

$$P_n(r|m) = \frac{e^{V_{(r|m)n}}}{\sum_{r'=1}^{R_{mn}} e^{V_{(r'|m)n}}}$$

$$P_n(m) = \frac{e^{\lambda(V_{mn} + V_{mn}^*)}}{\sum_{m'=1}^{M_n} e^{\lambda(V_{m'n} + V_{m'n}^*)}}$$

in which,

$$V_{mn}^* = \ln \sum_{r=1}^{R_{mn}} e^{V_{(r|m)n}}$$

$$\lambda = \frac{\pi}{\sqrt{6}}(\sigma_2^2 + 1)$$

Besides, according to the linear assumption of the utility function, we can rewrite $V_{(r|m)n}$ and V_{mn} as a linear combination of variable \mathbf{X} as follows:

$$V_{(r|m)n} = \boldsymbol{\beta} \mathbf{X}_{(r|m)n} = \sum_{k=1}^{K_1} \beta_k X_{(r|m)nk}$$

$$V_{mn} = \boldsymbol{\theta} \mathbf{X}_{mn} = \sum_{k=1}^{K_2} \theta_k X_{mnk}$$

of which, $\boldsymbol{\beta} = [\beta_1, \beta_2, \dots, \beta_{K_1}]$, is the K_1 -order unknown vector of the alternatives in level 2 which influences consumers' utilities.

$\mathbf{X}_{(r|m)n} = [X_{(r|m)n_1}, X_{(r|m)n_2}, \dots, X_{(r|m)n_{K_1}}]$, is the K_1 -order featured vector. It changes with “ r ” in the featured variables of the alternative “ rm ” picking, that is, the value level of each element in the questionnaire.

$\boldsymbol{\theta} = [\theta_1, \theta_2, \dots, \theta_{K_2}]$, is the K_2 -order unknown vector when the alternatives in level 1 are picked.

$\mathbf{X}_{mn} = [X_{mn1}, X_{mn2}, \dots, X_{mn_{K_2}}]$, is the K_2 -order featured vector, and changes with “ m ” in the featured variables of the alternative “ rm ” picking,

Then we get the final expression of $P_n(rm)$,

$$\begin{aligned} P_n(rm) &= P_n(r|m)P_n(m) \\ &= \frac{e^{\sum_{k=1}^{K_1} \beta_k X_{(r|m)nk}}}{\sum_{r'=1}^{R_{mn}} e^{\sum_{k=1}^{K_1} \beta_k X_{(r'|m)nk}}} \cdot \frac{e^{\lambda_2 \left(\sum_{k=1}^{K_2} \theta_k X_{mnk} + \ln \sum_{r=1}^{R_{mn}} e^{V_{(r|m)n}} \right)}}{\sum_{m'=1}^{M_n} e^{\lambda_2 \left(\sum_{k=1}^{K_2} \theta_k X_{m'nk} + \ln \sum_{r=1}^{R_{mn}} e^{V_{(r|m)n}} \right)}} \end{aligned}$$

Appendix provides the summary of the detailed data required in our study.

3. Survey and Data

Personal in-home surveys have been conducted in the process of data collection. The advantage of this survey method is that through the face-to-face interviews, the first-hand information can be obtained smoothly. By means of interviewers' questions and the explanations to the interviewees, the veracity and effectiveness of the survey can be ensured. The problem with this mode of data collection, however, is that it would not be representative if

the survey is limited within a small-scale range. Therefore, a reasonable sample size must be matched in this survey.

Having considered about the current transportation and economic situations in Shanghai, we took a fixed proportion in-home survey on the basis of the registered population distribution in different districts of Shanghai. Based on *Shanghai Administrative Districts Handbook 2010*, we adopted the PPS (probability proportional to size) sampling method to extract the neighborhoods from the registered population in 10 central districts. Forty respondents were selected in each neighborhood by the method of random start³. Since the outer suburbs are not the priority places and possess a fewer population, our survey focused mainly on the urban and suburban areas in Shanghai (See Table 2). In this survey, over 2000 households are selected. With the cooperation of professional survey firm, we spent about one month (December 28, 2010 – January 30, 2011), organizing the personnel, training interviewers and undertaking in-home interviews. Finally, we collected about 2,000 samples in the downtown area of Shanghai, which is comparable to some aforementioned important studies [1] [33], with 1998 questionnaires confirmed valid. We then paid a return visit to 20% of the valid questionnaires to ensure the authenticity and reliability of the results.

³ Radom start: During the process of audit and research design, a sample will be confirmed in terms of the intersections of the ranks in the random numbers table.

Figure 2 The sampled population distribution

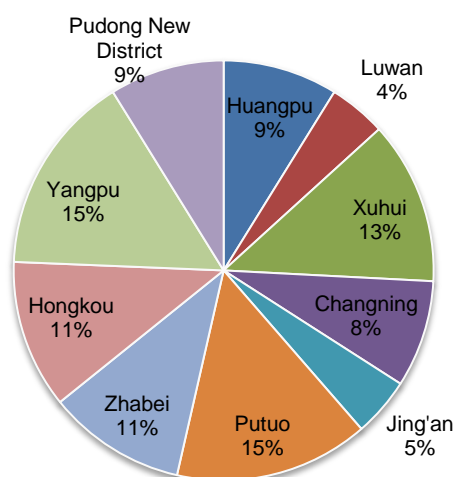

Table 2 Sample distribution of the in-home surveys

Districts	Extracted neighborhoods	Households
Huangpu	4	160
Luwan	2	80
Xuhui	6	240
Changning	4	160
Jing'an	2	80
Putuo	8	320
Zhabei	6	240
Hongkou	6	240
Yangpu	8	320
Pudong New District	4	160
Total	50	2000

Table 3 shows the basic information of the valid respondents (households). It can be seen that the indexes of gender, age, education and monthly family income distribute almost evenly, which could satisfy the basic requirements of experimental studies.

Table 3 Basic information classification of the valid respondents

Gender	Male	54%
	Female	46%
Age	18—29	31%
	30—39	24%
	40—49	20%
	50—59	17%
	60—69	6%
	Over 70	1%
Education	Secondary education or below	9%
	High school /Vocational school	33%
	College	24%
	Undergraduate	30%
	Master or above	4%
Monthly family income (RMB)	Below 1000	1%
	1001—5000	21%
	5001—10000	40%
	10001—15000	23%
	15001—20000	11%
	Above 20000	5%

4. Statistic Results

4.1 Statistic information and classification analysis

In terms of the vehicle categories, battery swapping mode tops the choice accounting for 27.31% of all respondents, followed by slow charging & battery swapping, while gasoline vehicle comes last (Table 4), which as a whole indicates a promising potential EV market in the future.

Table 4 Choices distribution

Vehicle Types	Selected Number	Percentage
Gasoline	1408	23.49%

Battery swapping	1637	27.31%
Slow & fast charging	1526	25.46%
Slow charging & battery swapping	1423	23.74%

From the information classification, we could know the tendencies of different groups. From the gender characteristics, compared with the male respondents, we find that *female enjoys a higher proportion for electric vehicle*. They are more inclined to battery swapping or battery swapping & slow charging electric vehicle. Two reasons may explain the phenomenon. The first is because a higher proportion of male respondents have experienced driving gasoline vehicles, and thus will experience a higher switching cost than the female drivers. The second is that some studies have shown women are more sensitive to the environmental value and thus easier to accept green products (Diamantopoulos et al. [24], Borchers et al. [25], Wiser [26]).

Figure 3 Choices distribution of gender

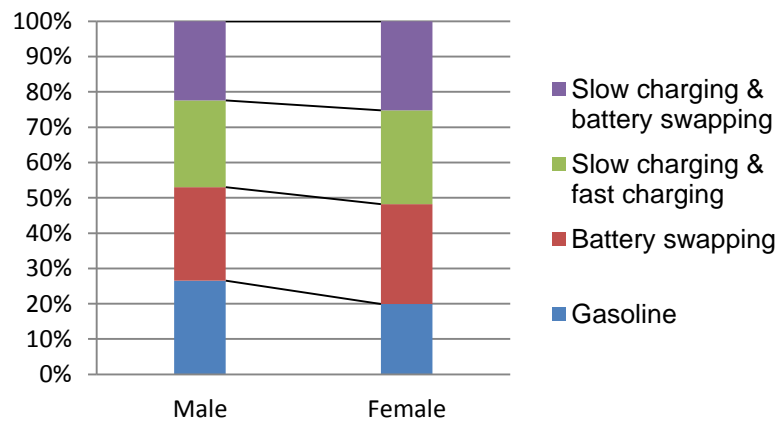

From the age aspect, battery swapping mode is most favorable for the interviewees aged from 18-69 (people aged below 18 and above 70 are restricted from driving according to the Chinese laws). In the group aged from 18-29, battery swapping mode is much more popular while in the group from 30-59, the portion of fast & slow charging mode rises with the increase of age. It clearly shows that the awareness popularity and habit formation are

essential for the promotion and popularization of new charging methods and technologies (See Figure 4).

Figure 4 Choice distribution of age

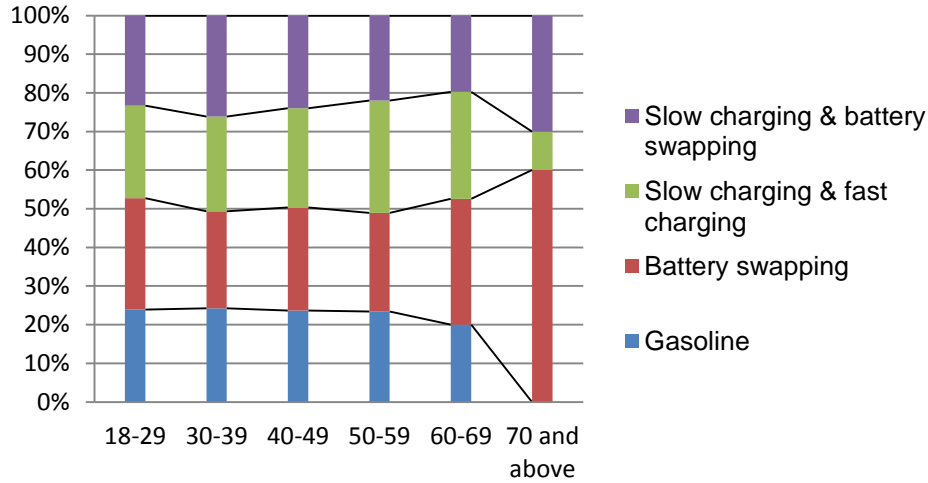

In light of the education, the number of consumers receiving high school, college or undergraduate education accounts for 87% of the total respondents, which assures the representativeness of the sample. These three groups' choices are evenly distributed. High school group prefers battery swapping mode while undergraduate group makes a similar choice percentage between gasoline vehicle and electric vehicle. Besides, the percentage of choosing gasoline vehicle rises with the increasing of educational level which is just opposite for the battery swapping mode electric vehicle. Group with a master degree and above has the largest percentage of gasoline vehicle preference. There are two reasonable explanations for the result. First is because the sample size of master degree and above is only 213 in total and only accounts for 3.55%, which is normal for the uncommon results. The second reason is that well-educated people usually have a higher income or expected income. They have more concerns and discretion towards the development of new vehicles, which has a lack of policy guidance. Meanwhile, the willingness of the well-educated gasoline vehicle owners to change the status quo is relatively low.

Figure 5 Choice distribution of education level

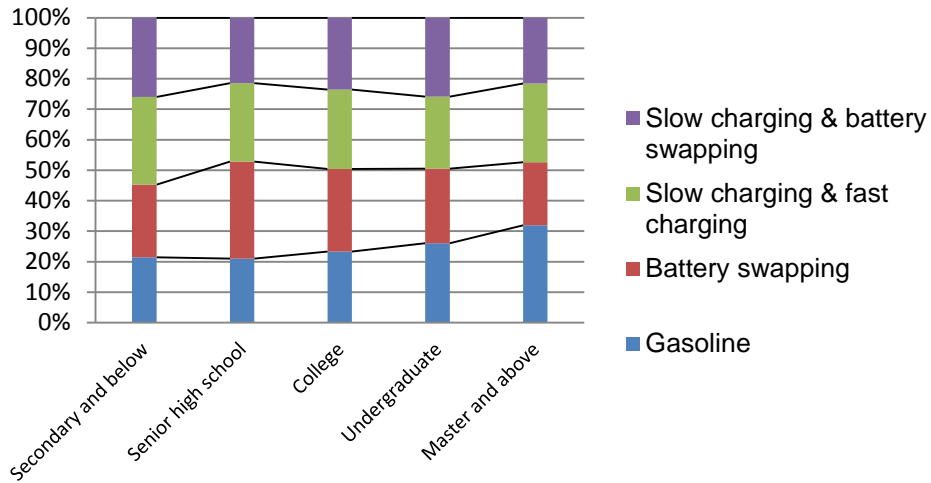

The level of family income is most closely linked with consumer tendencies. In our survey, we focused on the most potential group with a monthly family income exceeding RMB10, 000. According to the data, the number of choosing gasoline vehicle is the largest; the proportion of battery swapping & slow charging mode is the highest among these three EV modes. In terms of the general trend, the percentage of gasoline vehicle rises with the increase in family income. Objectively, strong transport property and wealth personal property attribute coexist in smaller-engined electric vehicle; auto buying of the well-paid group, however, is not simply for transportation need, but much for extravagance and comfort. Furthermore, high-paid group has a higher percentage in gasoline vehicle owning, which faces an exit cost and a license fee limitation for buying a second car.

Figure 6 Choice distribution of family income

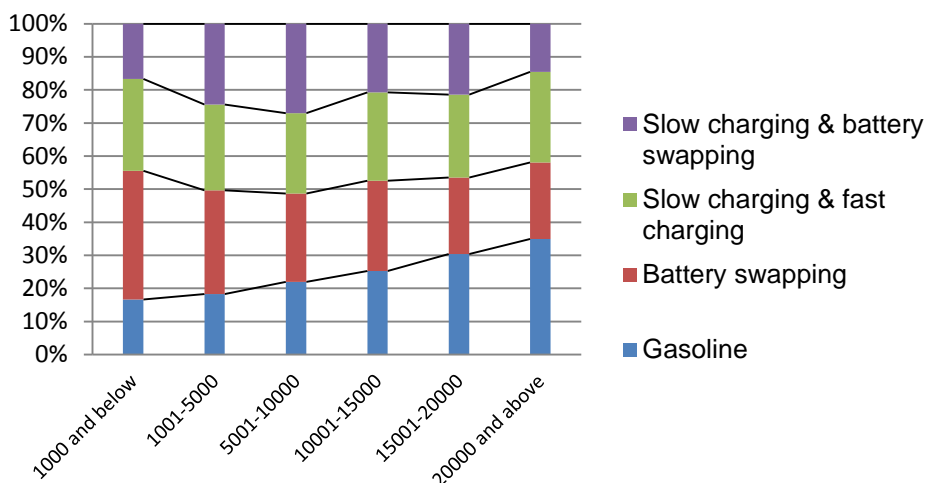

In conclusion, as shown in Table 5, the ratio of choosing electric vehicle decreases with the increase of age, education level and household income. Female consumers have a higher percentage of choosing electric vehicle than the male counterpart. *These findings may be different from common sense, but are of great reference for policy research.* They suggest a regulation of relying on purchasing subsidy policy alone may have little effect for it is a long-term process to change consumers' driving habits and requires multi-cooperation.

Table 5 Choice distributions by different types of household

Classification		Gasoline	Battery Swapping	Slow & fast charging	Slow charging & battery swapping
Gender	Male	856 (26.57%)	853 (26%)	790 (25%)	723 (22%)
	Female	552 (19.91%)	784 (28%)	736 (27%)	700 (25%)
Age	18-29	447 (24%)	539 (29%)	447 (24%)	436 (23%)
	30-39	356 (24%)	368 (25%)	359 (24%)	384 (26%)
	40-49	284 (24%)	320 (27%)	308 (26%)	288 (24%)
	50-59	244 (23%)	267 (26%)	303 (29%)	230 (22%)
	60-69	77 (20%)	125 (33%)	106 (28%)	76 (20%)
	Above 70	0 (0%)	18 (60%)	3 (10%)	9 (30%)
Education level	Secondary education and	120 (21%)	134 (24%)	161(29%)	146 (26)

	below High school/Vocational school	414 (21%)	628 (32%)	509 (26%)	423 (21%)
	College Undergraduate	332 (23%)	386 (27%)	371 (26%)	336 (24%)
	Master and above	474 (26%)	445 (24%)	430 (24%)	472 (26%)
		68 (32%)	44 (21%)	55 (26%)	46 (22%)
Monthly family income	Below 1000	6 (17%)	14 (39%)	10 (28%)	6 (17%)
	1001-5000	232 (18%)	397 (31%)	328 (26%)	309 (24%)
	5001-10000	525 (22%)	636 (27%)	580 (24%)	644 (27%)
	10001-15000	342 (25%)	370 (27%)	363 (27%)	281 (21%)
	15001-20000	197 (30%)	150 (23%)	162 (25%)	139 (21%)
	Above 20000	106 (35%)	70 (23%)	83 (27%)	44 (15%)

4.2 Regression analysis of sensitive factors

Based on the collected data, we use the MDC (multinomial discrete choice) procedure of the SAS software to calculate the parameter regression aiming at the nested-logit model. The MDC procedure is a model designed to the alternative computation, including conditional-logit model, mixed-logit model, nested-logit model and multinomial-probit model. Having a similar framework, these models only differentiate in different premise hypotheses. For the nested-logit model, there are several parameter regression methods. Hensher [10] summarized two methods aiming at the nested-logit model: sequential maximum likelihood method (SML) and full information maximum likelihood method (FIML). Thereafter, with the application of Monte Carlo simulation method, Brownstone and Small [6] compared the estimators computed by SML, FIML and linearized maximum likelihood method (LML). They found that the FIML method has the best property among those three methods. It is not only the most effective one, but also the one that can get an estimator in most cases, whereas LML and SML estimator cannot be worked out under certain conditions. Besides, a serious downward bias exists in the SML parameter estimation in level 2. Based on these types of researches, SAS adopts FIML method, a method with better regression features, to estimate the nested-logit

model.

Table 6 shows the regression result of the nested-logit model, where we can find five parameters including fuel cost, maintenance cost, mileage, slow charging time and the interaction term of slow charging time and fast charging time passed the test of significance.

Table 6 Parameter estimation results under optimal choices of the total respondents

	Parameter	Estimate	Standard Error	t Value	Approx Pr> t	
Level 2	Dummy 1 in L2	-0.0731	.	.	.	
	Dummy 2 in L2	0.077	.	.	.	
	Dummy 3 in L2	-0.0411	.	.	.	
	Purchase price	-4.02E-08	4.98E-07	-0.08	0.9356	
	Fuel cost	-0.007292	0.001358	-5.37	<.0001	
	Maintenance cost	-0.000017	3.80E-06	-4.41	<.0001	
	Specialized parking space	0.2014	.	.	.	
	Pre-sale charging card	0.1769	.	.	.	
	Mileage	0.001455	0.000237	6.15	<.0001	
	Charging convenience	Slow	0.1978	.	.	.
		Fast	-0.248	.	.	.
		Interaction	0.489	.	.	.
	Charging time	Slow	-0.001307	0.000136	-9.58	<.0001
Fast		-0.0866	.	.	.	
Interaction		0.000336	0.0000209	16.07	<.0001	
Level 1	Dummy in L1	-0.0407	.	.	.	
	Congestion charge	0.0902	.	.	.	
	$\lambda 1$	0.8885	.	.	.	
	$\lambda 2$	1.2902	.	.	.	

The negative coefficient of fuel cost indicates that the utilities of purchasing will drop with the increase of fuel cost, thus decreasing the probability of buying a car. For example, if the fuel cost of vehicles A, B and C remains the same, the rise in vehicle D's fuel cost will lead to a declining

probability of vehicle D purchasing and the rising probability of vehicles A, B and C.

The sign of coefficients of maintenance cost and charging time is similar to that of fuel cost, being negative. But compared to the fuel cost, consumers are less sensitive to the maintenance cost.

The positive coefficient of mileage means that the utilities of vehicle purchasing go up with the increase in mileage, leading to the probability rise of car buying.

The coefficient of the interaction term of slow & fast charging time is positive. Whether this reflects the reality needs further discussion. Having considered about the complication of the interaction term theory, we adopted the following equation:

$$U = \beta_0 + \beta_1 \times regular + \beta_2 \times fast + \beta_3 \times regular \times fast$$

From the regression result, we get $\beta_3 > 0$.

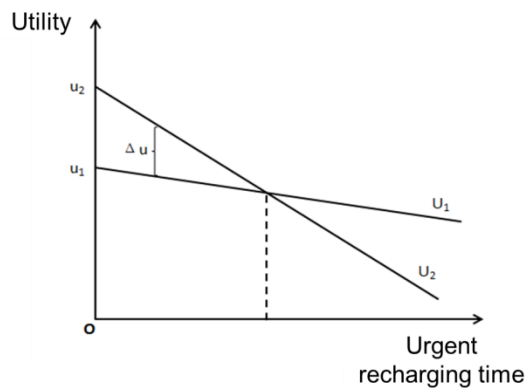

Figure 7 Interaction of slow and fast (urgent) charging time

Now let's consider two types of vehicles, namely type 1 and type 2. Except for the corresponding slow charging time a and b , all other elements of type 1 and type 2 are kept the same. We then get the utilities of type 1 and type 2:

$$U_1 = \beta_0 + \beta_1 \times a + \beta_2 \times fast + \beta_3 \times a \times fast$$

$$U_2 = \beta_0 + \beta_1 \times b + \beta_2 \times fast + \beta_3 \times b \times fast$$

The utility difference is

$$\Delta U = U_1 - U_2 = (a - b)\beta_1 + (a - b)\beta_3 * fast$$

According to the results of the non-interaction term, when the charging time goes up, the utility drops which means that β_1 is negative. When $a > b$, which means the slow charging time of type 1 is longer than that of type 2, the decreasing speed of utility 1 is slower than that of utility 2. This means the longer the slow charging time, the less consumer sensitiveness to the fast charging time and vice versa.

Acquisition price, incentive policy and charging convenience fail to pass the significance test. *The insignificance of purchasing price is actually a very important finding. It reflects that consumers pay much more attention to future variable cost than “one-off” purchasing cost when it comes to car buying.* That is to say, *consumers are rational to the dynamic state behavior and the integrated cost benefit.* The result shows that with the popularity of the EV concept, Shanghai citizens have turned their attention from the initial purchasing cost to the future daily usage cost, pointing out the necessity for the government to adjust the subsidy policy. Therefore, the relative subsidy policies should shift away from car purchasing to electricity price subsidy to lower daily usage cost.

The failure to pass the test also happens in specialized parking lots and pre-sale charging card, which means that consumers are not sensitive to this kind of public incentive policies. In addition, the failure of coefficient of charging convenience is beyond our expectation. Contrast to the relative analysis in the pre-survey, we think that it mainly results from the adjustment of the charging stations coverage (We adjusted the density extent of charging stations from 10%-50%-70% to 90%-100%-120%). The reason of the adjustment is that we found from the pre-survey that the planned infrastructure construction scale in related enterprises is much bigger than what we have expected. In our view, the reason for the insignificance of charging convenience is that it will not be a sensitive factor any more (slight fluctuations within the threshold that have little

influence) if EV charging is as convenient as gasoline vehicle (in consumers' opinion).

It should be pointed out that after classifying the samples in terms of family income, the regression result shows that for the specific low income household who already had their own cars, acquisition price passed the test (nearly 5% significant and negative), and it also goes to the high income car owners (nearly 20% significant and negative), showing that *consumers' insensitiveness to acquisition cost would change in certain conditions*. One reason lies in that private car owners have a better understanding of performance index of the electric vehicle, which gives them a sensible awareness towards price and further explains the price insensitiveness stated above by the application of information symmetry theory. Meanwhile, the EV acquisition is either alternative or complementary for the car owners who have larger demand elasticity than the fresh car buyers. Moreover, we find the low income group is more sensitive to price compared with the high income counterpart. This is in line with the reality because high income group has a higher endurance towards price increase.

4.3 Willingness to pay (WTP)

Willingness to pay for fuel cost measures the extra fuel cost consumers would like to pay for other benefits. We could get WTP, ceteris paribus, when a utility term coefficient is divided by the fuel cost coefficient. We calculated the WTP of purchasing price, maintenance cost, mileage and charging time in different classifications, which can be found in Table 7 (the figure in the table means the fuel cost per hundred kilometers consumers would like to pay; * means insignificant).

Table 7 WTP for fuel cost per hundred kilometers

Classification	Purchase price decline by RMB10,000	Maintenance cost cut by RMB5,000/y	Mileage increase by 50 kilometers	Slow charging time cut by 60
-----------------------	--	---	--	-------------------------------------

				minutes
Whole sample	*	11.66	9.98	10.75
Middle income	*	14.11	8.83	*
High income	*	9.71	9.71	14.03
Car owners	*	10.45	9.00	3.21
Non-car owners	*	12.63	10.33	19.01
In which				
Car owners				
Low income	3.99	*	12.38	41.61
Middle income	*	8.39	7.38	*
High income	3.07	28.59	24.52	35.00
Non-car owners				
Middle income	*	20.04	9.88	*
High income	*	*	12.46	256.32

s

As listed above, in terms of the whole sample, consumers would like to pay an extra RMB11.66/100km for RMB5,000 saving in maintenance cost. It is RMB14.11/100km for middle income family and RMB9.71/100km for high income family. We can see that middle class family is more sensitive to maintenance cost while high income family is relatively sensitive to fuel cost (the greater the figure, the higher sensitiveness for the group within the same column). Similarly, under the whole sample, consumers are willing to pay an extra RMB9.98/100km for 50 km increase in mileage. It is RMB8.83/100km for middle income family and RMB9.71/100km for high income family. It is easy to see that middle income family is more sensitive to maintenance cost while high income family is relatively sensitive to mileage. Consumers' WTP is directly related to the construction direction, price interval and governmental subsidy in the promotion of electric vehicle and EV charging mode. For instance, according to the consumers' WTP results and the prediction data of car possession, we could do some simple analysis of investment earnings: take fuel price increase and battery life research support for example, consumers can endure a mark-up of R9.98/100km if there is a mileage increase of 50km.

When the EV number reaches 36, 700, the optimistic estimate in 2015, if each car runs 10, 000 km per year, a fuel revenue worth RMB36.63 million would be reached ($36,700 \times 10,000 \times 9.98 / 100 = 3663$) to support the relative research and development.

5. Conclusions and Policy Implications

With the application of the stated preference experiment and the nested-logit model, this paper studies the demand preference among different EV types of residents in large cities of China. Since Shanghai possesses a good practice foundation in demonstration application and infrastructure construction, we launched a large sampling survey in 10 central districts of Shanghai and studied on the multiple factors that influence consumer demand behavior.

In this paper, we found that Shanghai residents prefer to choose a battery swapping mode or slow recharging & battery swapping mode. This choice is linked to swapping mode's effectiveness of lowering the initial acquisition cost and the possibility of cutting the maintenance burden. On the whole,, EV swapping station could break through the limitation of land resource to charging stations and reach a high coverage by efficient logistics system. For consumers, the battery swapping & slow charging mode could reduce the maintenance cost and add the convenience degree effectively. Governmental departments could hence guide the battery and automobile manufacturers and electricity suppliers to better optimize the EV developing pattern.

In the group classification analysis, the male, the young, the well-educated and well-paid groups are found to have a relatively low proportion of selecting an electric vehicle and vice versa, which is quite different from that in the developed countries. There are two plausible explanations. On the one hand, because of the relatively low level of economic development, there is a "vanity effect" in the use of gasoline vehicle. On the other hand, sunk cost is an

essential factor keeping the private car owners who possess the above characteristics from choosing an electric vehicle. The study well explains the importance of giving more publicity to electric vehicle and strengthen the awareness of electric vehicle, especially for the environmental value.

From the significant factors of the regression results, we found that fuel cost and maintenance cost occupy a highly significance compared with acquisition price, and respondents (consumers) consider the fuel cost and maintenance cost most, which illustrates that compared with the purchasing subsidy, lower the operation cost from the supply side is much more effective to the cultivation and promotion of the EV market. Only if we guarantee the edging advantages of a low long-term usage cost, can we guide the consumers' choices and promote the development and large-scale operation of the EV market. Meanwhile, both charging convenience and charging time are important factors influencing EV consumers' utilities.

Through a comparison between the studies abroad and our study, we could find the similarities and differences on EV consumer behavior between developing and developed countries. Similarities include: (1) Consumers are not sensitive to the parking preferential policy; (2) low and middle income families enjoy a higher possibility of buying electric vehicle compared with the high-income family, if other conditions remain controlled; (3) Middle-income car owners are more sensitive to price compared with high-income car owners, the same conclusion drawn from the Canadian case done by Potoglou and Kanaroglou [21]. The differences include: (1) This paper shows an insensitiveness to price for the Shanghai consumers; (2) A higher percentage exists in the low and middle income families to buy electric vehicles compared with the high income family founded in South Korea's study conducted by Yoo and Kwak [23].

Stimulus policies' insignificance shows that consumer decisions are not influenced by the governmental policies in the present social circumstances. The result shows that different emphases should be laid on governmental

support in different EV developing stages. In the initial stage, the government should emphasize more on the increase of charging infrastructure coverage and the competitive forces of charging stations. In the developing stage, by the implementation of demand management side policy, clear explicit incentive mechanism could be introduced to the larger-scale realization of EV substitution. At the same time, a clear policy stimulus signal is conducive to increase the stability of relative investment income in the industrial chain, overcome the bottleneck of technology innovation and cultivate the market effectively.

Appendix: The Sheet of nested-logit model data

Options		Level2	Electric Vehicle(1)			Gasoline Vehicle(2)	Unknown parameters	
			Level1	Battery Swapping(11)	Fast & Slow Charging(21)	Slow Charging & Battery Swapping(31)		Fuel Charging(12)
Choice			$\bar{\delta}_{11n}$	$\bar{\delta}_{21n}$	$\bar{\delta}_{31n}$	$\bar{\delta}_{12n}$	λ_2	
Level2	Independent Variables	Dummy	X_{m1}	1			0	θ_1
		Noise Degree	X_{m2}	X_{12n}			X_{22n}	θ_2
		:	:	:			:	:
		The jth Variable Property	X_{mj}	X_{1jn}			X_{2jn}	θ_j
Level1	Independent Variables	Dummy	$X_{(r m)}^{)1}$	1	0	0	0	β_1
			$X_{(r m)}^{)2}$	0	1	0	0	β_2

		$X_{(r m)}$)3	0	0	1	0	β_3
	Acquisition Price	$X_{(r m)}$)4	$X_{(1 1)4n}$	$X_{(2 1)4n}$	$X_{(3 1)4n}$	$X_{(1 2)4n}$	β_4
	Mileage	$X_{(r m)}$)5	$X_{(1 1)5n}$	$X_{(2 1)5n}$	$X_{(3 1)5n}$	$X_{(1 2)5n}$	β_5
	Preferential Policy	$X_{(r m)}$)6	$X_{(1 1)6n}$	$X_{(2 1)6n}$	$X_{(3 1)6n}$	$X_{(1 2)6n}$	β_6
	⋮	⋮	⋮	⋮	⋮	⋮	⋮
	The kth Independent Variable Property	$X_{(r m)}$)k	$X_{(1 1)kn}$	$X_{(2 1)kn}$	$X_{(3 1)kn}$	$X_{(1 2)kn}$	β_k
Interactive Variable	Acquisition cost* Monthly Family Income	$X_{(r m)}$)k+1	$X_{(1 1)(k+1)n}$	$X_{(2 1)(k+1)n}$	$X_{(3 1)(k+1)n}$	$X_{(1 2)(k+1)n}$	β_{k+1}
	Mileage*Charging	$X_{(r m)}$	$X_{(1 1)(k+2)n}$	$X_{(2 1)(k+2)n}$	$X_{(3 1)(k+2)n}$	$X_{(1 2)(k+2)n}$	β_{k+2}

	es	Convenience	$X_{(k+2)}$					
		⋮	⋮	⋮	⋮	⋮	⋮	⋮
		The pth Interactive Variable Property	$X_{(r m)}$ $X_{(k+p)}$	$X_{(1 1)(k+p)n}$	$X_{(2 1)(k+p)n}$	$X_{(3 1)(k+p)n}$	$X_{(1 2)(k+p)n}$	β_{k+p}

References

- [1] T. Adler, L. Wargelin, L. Kostyniuk, C. Kavalec, G. Occhiuzzo, Incentives for alternative fuel vehicles: A large-scale stated preference experiment. In: Proceedings of the 10th International Conference on Travel Behaviour Research, Lucerne, 2003.
- [2] W. Adamowicz, J. Louviere, and M. Williams, Combining revealed and stated preference methods for valuing environmental amenities, *Environ. Econom. Management* 26 (1994) 271-292.
- [3] K. Adamson, Calculating the price trajectory of adoption of fuel cell vehicles, *International Journal of Hydrogen Energy* 30 (2005) 341-350.
- [4] D. Brownstone, D.S. Bunch, K. Train, Joint mixed logit models of stated and revealed preferences for alternative-fuel vehicles, *Transportation Research Part B: Methodological* 5 (2000) 315-338.
- [5] D. Brownstone, D.S. Bunch, T.F. Golob, W. Ren, A transactions choice model for forecasting demand for alternative-fuel vehicles, *Research in Transportation Economics* 4 (1996) 87-129.
- [6] D. Brownstone and K. Small, Efficient Estimation of Nested Logit Models, *Journal of Business and Economic Statistics* 7 (1989) 67-74.
- [7] D. Bunch, M. Bradley, T.F. Golob, R. Kitamura, G.P. Occhiuzzo, Demand for alternative-fuel vehicles in California: a discrete-choice stated preference pilot project, *Transportation Research Part A: Policy and Practice* 27 (1993) 237-253.
- [8] D. Layton, Random Coefficient Models for Stated Preference Surveys, *Journal of Environmental Economics and Management*, 40 (2000) 21-36.
- [9] T. Golob, J. Torous, M. Bradley, D. Brownstone, S. Crane, D. Bunch, Commercial fleet demand for alternative-fuel vehicles in California, *Transportation Research Part A: Policy and Practice* 31 (1997) 219-233.
- [10] D. Hensher, Sequential and full information maximum likelihood estimation of a nested logit model, *Review of Economics and Statistics* LXVIII (1986) 657-667.
- [11] K. He, H. Huo, Q. Zhang, D. He, F. Wang, M. Walsh, P. Michael, Oil consumption and CO₂ emissions in China's road transport: current status, future trends, and policy implications, *Energy Policy* 33 (2005) 1499–1507.
- [12] International Energy Agency, *Energy Technology Perspective 2010*.
- [13] B. Lane and S. Potter, The adoption of cleaner vehicles in the UK: exploring the consumer attitude-action gap, *Journal of Cleaner Production* 15 (2007) 1085–1092.
- [14] S. Mabit and M. Fosgerau, Demand for alternative-fuel vehicles when registration taxes are high, *Transportation Research Part D: Transport and Environment* 16 (2011) 225-231.
- [15] E. Martin, S. Shaheen, T. Lipman, J. Lidicker, Behavioral response to hydrogen fuel cell vehicles and refueling: results of California drive clinics, *International Journal of Hydrogen Energy* 34 (2009) 8670–8680.
- [16] S. Mourato, B. Saynor, D. Hart, Greening London's black cabs: a study of driver's preferences for fuel cell taxis, *Energy Policy* 32 (2004) 685-695.
- [17] K. Nesbitt, D. Sperling, Myths regarding alternative fuel vehicle by light- duty vehicle fleets, *Transport and Environment* 3 (1998) 259-269.

- [18] T.O'Garra, S. Mourato, L. Garrity, P. Schmidt, A. Beerenwinkel, M. Altmann, D. Hart, C. Graesel, S. Whitehouse, Is the public willing to pay for hydrogen buses? A comparative study of preferences in four cities, *Energy Policy* 35 (2007) 3630–3642.
- [19] T. O'Garra, S. Mourato, P. Pearson, Analyzing awareness and acceptability of hydrogen vehicles: a London case study, *International Journal of Hydrogen Energy* 30 (2005) 649-659.
- [20] M. Ouyang, H. Wang, H. Hao, China Vehicle Energy Demand Study, Technique Report of China Automotive Energy Research Center, Tsinghua University ,2009.
- [21] D. Potoglou and P. Kanaroglou, Household demand and willingness to pay for clean vehicles, *Transportation Research Part D: Transport and Environment* 12 (2007) 264-274.
- [22] J. Wang and Z. Guo, Logistic Regression Model—Methods and Applications, Higher Education Press, Beijing, 2001.
- [23] S. Yoo, S. Kwak, Willingness to pay for green electricity in Korea: A contingent valuation study, *Energy Policy* 37 (2007) 5408-5416.
- [24] A. Diamantopoulos, B.B. Schlegelmilch, R.R. Sinkovics, G.M. Bohlen, Can socio-demographics still play a role in profiling green consumers? A review of the evidence and an empirical investigation, *Journal of Business Research* 56 (2003) 465-480.
- [25] A.M. Borchers, J.M. Duke, G.R. Parsons, Does willingness to pay for green energy differ by source? *Energy Policy* 35 (2007) 3327-3334.
- [26] R.H. Wiser, Using contingent valuation to explore willingness to pay for renewable energy: a comparison of collective and voluntary payment vehicles, *Ecological Economics* 62 (2007) 419-432.

NOTE DI LAVORO DELLA FONDAZIONE ENI ENRICO MATTEI

Fondazione Eni Enrico Mattei Working Paper Series

Our Note di Lavoro are available on the Internet at the following addresses:

<http://www.feem.it/getpage.aspx?id=73&sez=Publications&padre=20&tab=1>
http://papers.ssrn.com/sol3/JELJOUR_Results.cfm?form_name=journalbrowse&journal_id=266659
<http://ideas.repec.org/s/fem/femwpa.html>
<http://www.econis.eu/LNG=EN/FAM?PPN=505954494>
<http://ageconsearch.umn.edu/handle/35978>
<http://www.bepress.com/feem/>

NOTE DI LAVORO PUBLISHED IN 2013

CCSD	1.2013	Mikel Bedayo, Ana Mauleon and Vincent Vannetelbosch: Bargaining and Delay in Trading Networks
CCSD	2.2013	Emiliya Lazarova and Dinko Dimitrov: Paths to Stability in Two-sided Matching with Uncertainty
CCSD	3.2013	Luca Di Corato and Natalia Montinari: Flexible Waste Management under Uncertainty
CCSD	4.2013	Sergio Currarini, Elena Fumagalli and Fabrizio Panebianco: Games on Networks: Direct Complements and Indirect Substitutes
ES	5.2013	Mirco Tonin and Michael Vlassopoulos: Social Incentives Matter: Evidence from an Online Real Effort Experiment
CCSD	6.2013	Mare Sarr and Tim Swanson: Corruption and the Curse: The Dictator's Choice
CCSD	7.2013	Michael Hoel and Aart de Zeeuw: Technology Agreements with Heterogeneous Countries
CCSD	8.2013	Robert Pietzcker, Thomas Longden, Wenying Chen, Sha Fu, Elmar Kriegler, Page Kyle and Gunnar Luderer: Long-term Transport Energy Demand and Climate Policy: Alternative Visions on Transport Decarbonization in Energy Economy Models
CCSD	9.2013	Walid Oueslati: Short and Long-term Effects of Environmental Tax Reform
CCSD	10.2013	Lorenza Campagnolo, Carlo Carraro, Marinella Davide, Fabio Eboli, Elisa Lanzi and Ramiro Parrado: Can Climate Policy Enhance Sustainability?
CCSD	11.2013	William A. Brock, Anastasios Xepapadeas and Athanasios N. Yannacopoulos: Robust Control of a Spatially Distributed Commercial Fishery
ERM	12.2013	Simone Tagliapietra: Towards a New Eastern Mediterranean Energy Corridor? Natural Gas Developments Between Market Opportunities and Geopolitical Risks
CCSD	13.2013	Alice Favero and Emanuele Massetti: Trade of Woody Biomass for Electricity Generation under Climate Mitigation Policy
CCSD	14.2013	Alexandros Maziotis, David S. Saal and Emmanuel Thanassoulis: A Methodology to Propose the X-Factor in the Regulated English and Welsh Water And Sewerage Companies
CCSD	15.2013	Alexandros Maziotis, David S. Saal and Emmanuel Thanassoulis: Profit, Productivity, Price and Quality Performance Changes in the English and Welsh Water and Sewerage Companies
CCSD	16.2013	Caterina Cruciani, Silvio Giove, Mehmet Pinar and Matteo Sostero: Constructing the FEEM Sustainability Index: A Choquet-integral Application
CCSD	17.2013	Ling Tang, Qin Bao, ZhongXiang Zhang and Shouyang Wang: Carbon-based Border Tax Adjustments and China's International Trade: Analysis based on a Dynamic Computable General Equilibrium Model
CCSD	18.2013	Giulia Fiorese, Michela Catenacci, Valentina Bosetti and Elena Verdolini: The Power of Biomass: Experts Disclose the Potential for Success of Bioenergy Technologies
CCSD	19.2013	Charles F. Mason: Uranium and Nuclear Power: The Role of Exploration Information in Framing Public Policy
ES	20.2013	Nuno Carlos Leitão: The Impact of Immigration on Portuguese Intra-Industry Trade
CCSD	21.2013	Thierry Bréchet and Henry Tulkens: Climate Policies: a Burden or a Gain?
ERM	22.2013	Andrea Bastianin, Marzio Galeotti and Matteo Manera: Biofuels and Food Prices: Searching for the Causal Link
ERM	23.2013	Andrea Bastianin, Marzio Galeotti and Matteo Manera: Food versus Fuel: Causality and Predictability in Distribution
ERM	24.2013	Anna Alberini, Andrea Bigano and Marco Boeri: Looking for Free-riding: Energy Efficiency Incentives and Italian Homeowners
CCSD	25.2013	Shoibal Chakravarty and Massimo Tavoni: Energy Poverty Alleviation and Climate Change Mitigation: Is There a Trade off?
ERM	26.2013	Manfred Hafner and Simone Tagliapietra: East Africa: The Next Game-Changer for the Global Gas Markets?
CCSD	27.2013	Li Ping, Yang Danhui, Li Pengfei, Ye Zhenyu and Deng Zhou: A Study on Industrial Green Transformation in China
CCSD	28.2013	Francesco Bosello, Lorenza Campagnolo, Carlo Carraro, Fabio Eboli, Ramiro Parrado and Elisa Portale: Macroeconomic Impacts of the EU 30% GHG Mitigation Target
CCSD	29.2013	Stéphane Hallegatte: An Exploration of the Link Between Development, Economic Growth, and Natural Risk
CCSD	30.2013	Klarizze Anne Martin Puzon: Cost-Reducing R&D in the Presence of an Appropriation Alternative: An Application to the Natural Resource Curse
CCSD	31.2013	Johannes Emmerling and Massimo Tavoni: Geoengineering and Abatement: A 'flat' Relationship under Uncertainty

ERM	32.2013	Marc Joëts: Heterogeneous Beliefs, Regret, and Uncertainty: The Role of Speculation in Energy Price Dynamics
ES	33.2013	Carlo Altomonte and Armando Rungi: Business Groups as Hierarchies of Firms: Determinants of Vertical Integration and Performance
CCSD	34.2013	Joëlle Noailly and Roger Smeets: Directing Technical Change from Fossil-Fuel to Renewable Energy Innovation: An Empirical Application Using Firm-Level Patent Data
CCSD	35.2013	Francesco Bosello, Lorenza Campagnolo and Fabio Eboli: Climate Change and Adaptation: The Case of Nigerian Agriculture
CCSD	36.2013	Andries Richter, Daan van Soest and Johan Grasman: Contagious Cooperation, Temptation, and Ecosystem Collapse
CCSD	37.2013	Alice Favero and Robert Mendelsohn: Evaluating the Global Role of Woody Biomass as a Mitigation Strategy
CCSD	38.2013	Enrica De Cian, Michael Schymura, Elena Verdolini and Sebastian Voigt: Energy Intensity Developments in 40 Major Economies: Structural Change or Technology Improvement?
ES	39.2013	Nuno Carlos Leitão, Bogdan Dima and Dima (Cristea) Stefana: Marginal Intra-industry Trade and Adjustment Costs in Labour Market
CCSD	40.2013	Stergios Athanassoglou: Robust Multidimensional Welfare Comparisons: One Vector of Weights, One Vote
CCSD	41.2013	Vasiliki Manousi and Anastasios Xepapadeas: Mitigation and Solar Radiation Management in Climate Change Policies
CCSD	42.2013	Y. Hossein Farzin and Ronald Wendner: Saving Rate Dynamics in the Neoclassical Growth Model – Hyperbolic Discounting and Observational Equivalence
CCSD	43.2013	Valentina Bosetti and Elena Verdolini: Clean and Dirty International Technology Diffusion
CCSD	44.2013	Grazia Cecere, Susanna Mancinelli and Massimiliano Mazzanti: Waste Prevention and Social Preferences: The Role of Intrinsic and Extrinsic Motivations
ERM	45.2013	Matteo Manera, Marcella Nicolini and Ilaria Vignati: Futures Price Volatility in Commodities Markets: The Role of Short Term vs Long Term Speculation
ERM	46.2013	Lion Hirth and Inka Ziegenhagen: Control Power and Variable Renewables A Glimpse at German Data
CCSD	47.2013	Sergio Currarini and Francesco Feri: Information Sharing Networks in Linear Quadratic Games
CCSD	48.2013	Jobst Heitzig: Bottom-Up Strategic Linking of Carbon Markets: Which Climate Coalitions Would Farsighted Players Form?
CCSD	49.2013	Peter Coles and Ran Shorrer: Optimal Truncation in Matching Markets
CCSD	50.2013	Heinrich H. Nax, Bary S. R. Pradelski and H. Peyton Young: The Evolution of Core Stability in Decentralized Matching Markets
CCSD	51.2013	Manuel Förster, Michel Grabisch and Agnieszka Rusinowsk: Anonymous Social Influence
CCSD	52.2013	Nizar Allouch: The Cost of Segregation in Social Networks
ES	53.2013	Fulvio Fontini, Katrin Millock and Michele Moretto: Investments in Quality, Collective Reputation and Information Acquisition
ES	54.2013	Roberta Distante, Ivan Petrella and Emiliano Santoro: Asymmetry Reversals and the Business Cycle
CCSD	55.2013	Thomas Michielsen: Environmental Catastrophes under Time-Inconsistent Preferences
ERM	56.2013	Arjan Ruijs and Herman Vollebergh: Lessons from 15 Years of Experience with the Dutch Tax Allowance for Energy Investments for Firms
ES	57.2013	Luciano Mauro and Francesco Pigliaru: Decentralization, Social Capital and Regional Convergence
CCSD	58.2013	Alexandros Maziotis, Elisa Calliari and Jaroslav Mysiak: Robust Institutions for Sustainable Water Markets: A Survey of the Literature and the Way Forward
CCSD	59.2013	Enrica De Cian, Fabio Sferra and Massimo Tavoni: The Influence of Economic Growth, Population, and Fossil Fuel Scarcity on Energy Investments
CCSD	60.2013	Fabio Sferra and Massimo Tavoni: Endogenous Participation in a Partial Climate Agreement with Open Entry: A Numerical Assessment
ES	61.2013	Daniel Atzori: The Political Economy of Oil and the Crisis of the Arab State System
ERM	62.2013	Julien Chevallier and Benoît Sévi: A Fear Index to Predict Oil Futures Returns
CCSD	63.2013	Dominik Karos: Bargaining and Power
CCSD	64.2013	Carlo Fezzi, Ian J. Bateman, and Silvia Ferrini: Estimating the Value of Travel Time to Recreational Sites Using Revealed Preferences
ES	65.2013	Luca Di Corato, Michele Moretto and Sergio Vergalli: Long-run Investment under Uncertain Demand
ES	66.2013	Michele Moretto, Paolo Panteghini and Sergio Vergalli: Tax Competition, Investment Irreversibility and the Provision of Public Goods
CCSD	67.2013	Dennis Guignet and Anna Alberini: Can Property Values Capture Changes in Environmental Health Risks? Evidence from a Stated Preference Study in Italy and the UK
ES	68.2013	William Brock, Anastasios Xepapadeas and Athanasios Yannacopoulos: Adjustment Costs and Long Run Spatial Agglomerations
ES	69.2013	Sasan Bakhtiari, Antonio Minniti and Alireza Naghavi: Multiproduct Multinationals and the Quality of Innovation
CCSD	70.2013	Rafael González-Val and Fernando Pueyo: Trade Liberalisation and Global-scale Forest Transition
CCSD	71.2013	Elena Claire Ricci: Smart-Grids and Climate Change. Consumer adoption of smart energy behaviour: a system dynamics approach to evaluate the mitigation potential.
CCSD	72.2013	Valentina Bosetti and Marco Maffezzoli: Taxing Carbon under Market Incompleteness
CCSD	73.2013	Francesco Silvestri, Stefano Ghinoi and Vincenzo Barone: Nautical Tourism, Carrying Capacity and Environmental Externality in the Lagoon of Marano and Grado

- CCSD 74.2013 Herman R.J. Vollebergh and Edwin van der Werf: [The Role of Standards in Eco-innovation: Lessons for Policymakers](#)
- ES 75.2013 Gérard Mondello: [Ambiguous Beliefs on Damages and Civil Liability Theories](#)
- CCSD 76.2013 Roberto Antonietti and Alberto Marzucchi: [Green Investment Strategies and Export Performance: A Firm-level Investigation](#)
- CCSD 77.2013 A.K.S. Chand, Sergio Currarini and Giovanni Ursino: [Cheap Talk with Correlated Signals](#)
- CCSD 78.2013 Ebru A. Gencer: [An Overview of Urban Vulnerability to Natural Disasters and Climate Change in Central America & the Caribbean Region](#)
- CCSD 79.2013 Libo Wu, Changhe Li, Haoqi Qian and ZhongXiang Zhang: [Understanding the Consumption Behaviors on Electric Vehicles in China - A Stated Preference Analysis](#)