

Bao, Te; Wang, Yongqin

Working Paper

Incomplete Contract and Divisional Structures

Tinbergen Institute Discussion Paper, No. 09-075/1

Provided in Cooperation with:

Tinbergen Institute, Amsterdam and Rotterdam

Suggested Citation: Bao, Te; Wang, Yongqin (2009) : Incomplete Contract and Divisional Structures, Tinbergen Institute Discussion Paper, No. 09-075/1, Tinbergen Institute, Amsterdam and Rotterdam

This Version is available at:

<https://hdl.handle.net/10419/86697>

Standard-Nutzungsbedingungen:

Die Dokumente auf EconStor dürfen zu eigenen wissenschaftlichen Zwecken und zum Privatgebrauch gespeichert und kopiert werden.

Sie dürfen die Dokumente nicht für öffentliche oder kommerzielle Zwecke vervielfältigen, öffentlich ausstellen, öffentlich zugänglich machen, vertreiben oder anderweitig nutzen.

Sofern die Verfasser die Dokumente unter Open-Content-Lizenzen (insbesondere CC-Lizenzen) zur Verfügung gestellt haben sollten, gelten abweichend von diesen Nutzungsbedingungen die in der dort genannten Lizenz gewährten Nutzungsrechte.

Terms of use:

Documents in EconStor may be saved and copied for your personal and scholarly purposes.

You are not to copy documents for public or commercial purposes, to exhibit the documents publicly, to make them publicly available on the internet, or to distribute or otherwise use the documents in public.

If the documents have been made available under an Open Content Licence (especially Creative Commons Licences), you may exercise further usage rights as specified in the indicated licence.



TI 2009-075/1

Tinbergen Institute Discussion Paper

Incomplete Contract and Divisional Structures

*Te Bao*¹

*Yongqin Wang*²

¹ CeNDEF, University of Amsterdam;

² CCES and School of Economics, Fudan University.

Tinbergen Institute

The Tinbergen Institute is the institute for economic research of the Erasmus Universiteit Rotterdam, Universiteit van Amsterdam, and Vrije Universiteit Amsterdam.

Tinbergen Institute Amsterdam

Roetersstraat 31
1018 WB Amsterdam
The Netherlands
Tel.: +31(0)20 551 3500
Fax: +31(0)20 551 3555

Tinbergen Institute Rotterdam

Burg. Oudlaan 50
3062 PA Rotterdam
The Netherlands
Tel.: +31(0)10 408 8900
Fax: +31(0)10 408 9031

Most TI discussion papers can be downloaded at
<http://www.tinbergen.nl>.

Incomplete Contract and Divisional Structures*

Te Bao

CeNDEF, University of Amsterdam
and Tinbergen Institute

Yongqin Wang

CCES and School of Economics,
Fudan University

August 25, 2009

Abstract

In this paper we want to analyze the internal divisional structure within an organization in the framework of incomplete contract theory. We use the framework of Aghion and Tirole (1997) and define the managerial control structure as “sequence of search”. A key feature of this paper which differentiate it from other works in the literature is that we add an *ex post* bargaining phase in which the managers can agree on the project which maximize their joint private benefit. Our model shows the share of cooperative surplus the managers can get from bargaining and their default pay off plays a key role in determining their search effort. When there is no spill over effect between the agents’ effort, internal separation is always dominated by internal integration with control right assigned to the agent (manager) with high interest congruence with the principal (head quarter). When there are synergy effect and setup cost during integration, the principal need to consider the cost-benefit trade off as Riyanto (2000) suggests. But more importantly, the optimal divisional structure depends heavily on whether the bargaining is interest congruence enhancing (increase the interest congruence between agents and the principal) or destroying (decrease the interest congruence).

JEL Classification: D23, L22

Key words: organizational form, divisional structure, incomplete contract, bargaining

*The authors are grateful to Dilip Mookherjee and participants of the 2009 Fudan-Yale Joint International Conference “Institutions and Economic Development” for helpful comments. Corresponding author: Yongqin Wang, CCES and School of Economics, Fudan University, 600 Guoquan Road, Shanghai, 200433, China. Email address: yongqinwang@fudan.edu.cn

1 Introduction

Researchers in economics and business have long recognized the importance of organizational forms for the performance of teams, corporations, and economies. Milgrom and Roberts (1992) shows the internal reorganization of General Motors in the 1920s by imposing more decentralized forms may be the key factor that leads to its surpassing over more centralized Ford in the next decades. Maskin *et al* (2000) also attribute the striking difference in the performance of China and former Soviet Union economies to the M-form and U-form decision structure in the government divisions which make economic plans.

This paper pays special interest on one kind of organizational forms: divisional structure when there are (potentially) many divisions which performs the same task. There is a rich literature on the organizational form that deals with divisional structure which is partly exogenous due to different functions or self-sufficient regions of the organization. (e.g. Maskin *et al* 2000, Dessein and Santos, 2006.) Besides literature on divisional structure, there are also many seminal works done on leadership, the delegation structure between the leader and the divisional managers. (Rotemberg and Saloner, 1993, Bolton and Dewatripont, 1994). There are a bunch of real world examples which draw our attention to the pure *endogenous* choice on divisional structure where multiple division may coexist while performing very similar kinds of tasks: a university may have many research centers in one research area on top of the department of this field; a large hospital may have more than one department of internal medicine or surgery; a large corporation may have more than one brand of the same product even with very similar positioning, e.g. it may be very hard to tell the difference between daily used goods produced by Lux, Hazeline, Dove, Ponds, which are all owned by Unilever. All these facts suggest there might be forces beyond pure functional concerns that drive the determination of optimal divisional structure making.

The methodology of former literature on divisional structure basically goes to two categories: the communication and information transmission models (Marschak and Radner, 1972, van Zandt, 1990, Bolton and Dewatripont, 1994, Dessein and Santos, 2006), which mainly discuss the trade off between coordination (or communication cost) and specialization (or local adaptation), and incentive models (Rotemberg and Saloner, 1993, Poitevin, 1995, Maskin *et al*, 2000) which focuses on the CEO's best decision on the incentive scheme for the division managers. For more detailed discussion of these literature, Mookherjee (2006) provides a comprehensive survey.

The communication models usually assume better use of local information, and therefore benefit from specialization when the CEO or headquarter makes more separate division,

or delegates more decision power to the local divisions, and poor coordination between divisions, or communication cost for doing so. When the benefit of specialization outweighs the loss of coordination, it is better to have less divisions, or less decision power delegated to the local divisions, and vice versa. The incentive models usually consider different contracts between CEO and division managers, or different working style of CEO (democratic or autocratic) and the induced effort by the managers. A special kind of organizational form will be chosen if it induces the highest amount of manager's effort.

Our work will be similar to the incentive models, but instead of considering *complete contracts* where the principal (CEO or top manager in the headquarter) maps performance to pay-offs or working styles where the principal also needs to make their own production decisions, we consider a model using *incomplete contract* approach. In our model the principal just need to decide whether she wants to have separate divisions, and make each worker the the manager of their own division, or integrate the divisions, and make only one worker the general manager, the other as his subordinates. In other words, we are considering the *internal boundary* of a firm. We are looking at the cost and benefit of integration (separation) of *homogenous* divisions within a firm, as Grossman and Hart (1986) did for the vertical integration (separation) between two firms.

A straight result from this kind of analysis is that the control right over division is usually a strong incentive for the agent, the party assigned with the control is usually more motivated to make effort, while the party losing control is usually discouraged. But a key difference between the internal and external boundary is that the welfare analysis is no more with respect to the joint pay-off of the two agents (division managers), but the goal of the principal (CEO). So we must introduce interest congruence analysis from Aghion and Tirole (1997). As we have at least three parties (one principal and two agents) here, we are faced with a generally more complicated model: both the interest congruence between the principal and agents, and the interest congruence between different agents should be taken into account. Like Grossman and Hart (1986), the agents can make *ex post* bargaining when the joint payoff can be improved from the controlling agent's decision. We show the bargaining in these settings are basically more important here than in the models on external boundary of the firm, because the agents have to be both informed before they bargain, so the bargaining may change the *ex post* interest congruence between the agents and the principal. We find separation is always dominated by integration and giving the control to the manager whose effort is more important when bargaining does not change interest congruence between the principal and agents, and large area of separation domination otherwise.

The structure of this paper is organized as following: Section 2 shows the model setup; Section 3 discuss the simplest case without contract incompleteness; Section 4 discuss the model with incomplete contract but without bargaining; Section 5 discusses the model with incomplete model and bargaining; Section 6 introduces spill-over effect of the agents' effort. Finally, Section 7 concludes.

2 The Model Setup

We want to start with a model with one principal P (we use “she” to address this party, usually the headquarter or the CEO), who is not productive and two agents, A_1 and A_2 (we use “he” to address each of them, usually the local offices or managers of divisions). Similar to Aghion and Tirole (1997) and Riyanto (2000). There are two divisions D_1 and D_2 . There are $n \geq 3$ projects for each division. The project $i \in \{i_1, \dots, i_n\}$ chosen in D_1 is associated with a profit B_i to P , and private benefit b_i^1, b_i^2 to A_1, A_2 . The project $j \in \{j_1, \dots, j_n\}$ chosen in D_2 is associated with a profit B_j to P , and private benefit b_j^1, b_j^2 to A_1, A_2 . **For simplicity we assume the distribution of projects in D_1 and D_2 are exactly the same.** We assume some projects yields “sufficiently negative” payoff so uninformed party will confess ignorance. When no project is chosen, every party get 0. So each agent has income from both D_1 and D_2 .

The agents search for information independently. At private cost $g_{A1}(e)$ agent $A1$ perfectly learns payoff of all projects with probability $e1$. At private cost $g_{A2}(e)$ agent $A1$ perfectly learns payoff of all projects with probability $e2$. For simplicity we assume the function form of cost are the same, meaning $g_{A1}(e) = g_{A2}(e) = g_A(e)$. All the cost functions are increasing and strictly convex.

For each division, the favorite project for P gives her B . The favorite project for agent $A1$ gives him $b1$. A_1 and A_2 get $\beta_1 b$ and $\beta_2 b$ when the favorite of P is chosen (This is just a benchmark, and will actually not happen because the principal does not search). The favorite project for $A2$ gives him $b2$. For simplicity we first assume $b1 = b2 = b$. P does not search, so she has no “favorite project” for the current setting. P receives $\alpha_1 B$ and $\alpha_2 B$ on expectation respectively when the favorite projects for $A1$ and $A2$ is chosen. $A1$ and $A2$ get $\gamma_1 b$ and $\gamma_2 b$ when the other's favorite is chosen.

Intuitively, we can consider P as the CEO of a big firm. D_1, D_2 are two sales offices, and A_1, A_2 are two sales managers. The firm produces several kinds of products, and sells them to several big customers. P may come from financial or R&D department before she

becomes CEO, so she knows nothing about sales. Therefore she must rely on the expertise of A_1 and A_2 to get access to the customers. Different products and customers may bring different private benefit to A_1 and A_2 . For instance, A_1 may personally like one kind of product better and feel satisfaction when getting order for it, and A_2 may have very good relationship with one customer, and enjoy doing business with him. There are many potential sales opportunities from the customers in both sales offices, but in order to make revenue the agents have to invest time and energy to search. If the agents do not search, he is not informed the right demand information of the customer. An uninformed agent does not dare to choose a project, because when doing this he steps the risk of selling to the wrong customer or even dishonest ones, and bringing in loss for the company. A successful deal (project) is good for all parties, because the firm gets profit, the agent signing the contract gets private benefit, and the other agent may be also better off because the successful deal adds to the reputation of the firm.¹

Here the interest congruence between the principal and the agents can be considered as a kind of “productivity” (or loyalty) of the agent. So later we may say agent i is more productive than agent j if $\alpha_i > \alpha_j$. We assume A_1 and A_2 always receive some benefits from the project in both D_1 and D_2 . It sounds like a kind of spill over when the principal makes separation decision (each agent is assigned the control over one division), the agent can still get some benefit from the division under the other agent’s control. This is a kind of spill over between agents which influences only the private benefit of the agents. There is another better known spill over effect, which is the spill over between agents which influences their productivity, and therefore the benefit of the principal. In this paper, we refer “spill over” to the one related to the principal’s benefit only, and treat the one related to the agents’ benefit just as a set of ordinary parameters (γ_1 and γ_2).

We assume $\alpha_1, \alpha_2, \beta_1, \beta_2, \gamma_1, \gamma_2 \in (0, 1]$. Here, because the interest congruence is always none negative, the uninformed party will always accept the project chosen by the informed party. It means all parties always would like to participate in the game (**The IR condition is always satisfied**).

The principal does not search, and only has to decide **the allocation of control** to A_1 and A_2 . She has to decide whether to have the two division controlled separately, or together by a general manager. If they are controlled separately, for simplicity we only discuss the case when A_1 has the right to choose project for D_1 , and A_2 has the right to choose for D_2 , as the reverse case is analogous. If one of them is informed and the other is

¹For example, A_1 ’s favorite customer is a small firm, and A_2 ’s favorite firm is a Fortune 500 firm. When the firm decides to choose A_2 ’s favorite customer, A_1 is also better off, because in the future, he can also boast to the potential customers “our firm does business with Fortune 500 firms”.

	P	A_1	A_2
P	B	$\alpha_1 B$	$\alpha_2 B$
A_1	$\beta_1 b$	b	$\gamma_1 b$
A_2	$\beta_2 b$	$\gamma_2 b$	b
$A_1 \& A_2$ Jointly	$(\beta_1 + \beta_2)b$	$b + \gamma_2 b$	$\gamma_1 b + b$

Table 1: The columns are the situation where the party’s favorite project is chosen. The rows are the party’s payoff given the project is chosen in the column.

not, the uninformed party will accept what the informed party tells him to do because $\gamma_i b$ is surely better than 0. If it is controlled by a single manager, the manager choose projects for both divisions when he is informed, and the other agent can only choose when the manager is uninformed and he is informed. *Control allocation mean sequence to choose his favorite projects when informed.*

Like the story in Grossman and Hart (1986), although A_1 and A_2 can not make side agreement *ex ante*, they may want to bargain with each other *ex post* when they see a possible improvement of joint utility (the joint pay off is larger if A_2 can choose the favorite project of A_1 if $b + \gamma_1 b < \gamma_2 b + b$, or the other way around). We assume they split the cooperative surplus by Generalized Nash Bargaining. A_1 gets w from the cooperative surplus, and A_2 gets $1 - w$.

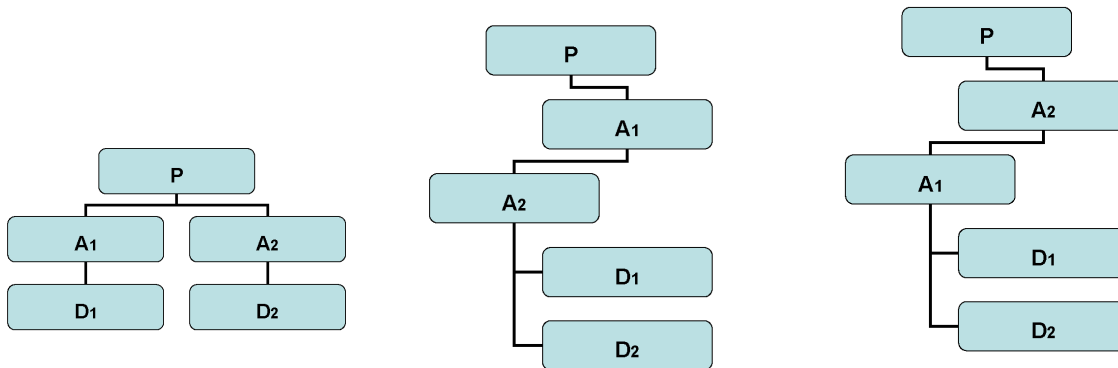

Figure 1: The control structures in a graph. The left one is the organization under separation control. The middle is the case of integration with control right assigned to A_1 , and the right one is the case of integration with control right assigned to A_2 .

Allowing for *ex post* bargaining between the parties is also one feature that differentiate our work from the past searching models on divisional structure . This means although they can not sign contract on which project to choose and what effort to use *ex ante*, because

such contracts between agents with potential threat to the interest of their principal is generally not enforceable. They can however make agreement on which project to choose if any two of them are informed *ex post*. So in this sense the information here is not *hard information* assumed by Aghion and Tirole (1997). Because one party can not convey it to other parties when the others are uninformed. Their default pay-offs in the bargaining will be the controlling party (party i) gets b and the other (party j) gets $\gamma_j b$, so **the allocation of control determines the default payoff**, which we call **bargaining position** in this model. But the controlling party might also choose the other's favorite if joint pay-off can be improved and he can cream off part of the surplus. Such improvement can be achieved via bargaining.

We denote $\Pi_i^P, \Pi_i^1, \Pi_i^2$ as the return to P, A_1, A_2 from division i . For simplicity and relevance to reality we assume $B \gg b$, so $B + \beta_1 b > \alpha_1 B + b$ and $B + \beta_2 b > \alpha_2 B + b$ hold for arbitrary parameters α and β . The joint pay-off can not be improved when the principal's favorite project is chosen. So the principal never wants to bargain with the agents when she is informed. Moreover, as we already assumed the principal does not search (so she is actually never informed). *The possibility for bargaining between the principal and agents are ruled out by the assumption of unproductive (and therefore always uninformed) principal.*

Although the possibility of bargaining between the principal and agents is ruled out, it is surely possible for the agents to bargain. For example, if A_1 and A_2 are in one department, and A_1 is in control, when both A_1, A_2 learns pay-off of all projects. If A_1 just pick up his own favorite, the pay is b to himself and $\gamma_2 b$ for A_2 . When A_1 choose the favorite of A_2 , the payoff is $\gamma_1 b$ for himself and b for A_2 . When $b + \gamma_2 b < b + \gamma_1 b$, A_1 might come to A_2 and say: "look, I can choose your favorite project, but in return for that, I want $w(\gamma_1 - \gamma_2)b$ on top of what I can get for sure if my favorite project is chosen, so that we get $b + w(\gamma_1 - \gamma_2)b : (1 - w)\gamma_1 + w\gamma_2 b$, instead of either $b : \gamma_2 b$, or $\gamma_1 b : b$."

By doing this we can introduce the *ex post* efficiency (within the bargaining parties) into our model. And *ex ante* control structure and bargaining power allocation still matter for incentive to make effort. Bargaining can happen when the joint pay-off (of agents) can be improved. The allocation of control only determines the bargaining position, the default pay-off. Here we use **Bargaining power** to describe the share of cooperative surplus one agent can get, and **Bargaining position** to say his relative default pay-off.

We assume the information on the parameters α, β, γ etc. is common knowledge. Although the principal does not search, she still has an idea of the productivity of the agents.

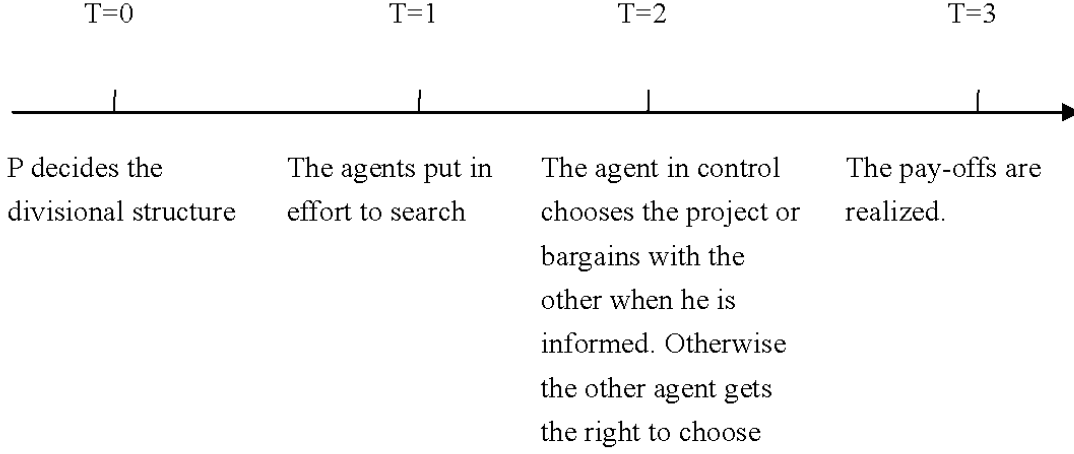

Figure 2: The time line of the game.

3 Social Optimum without Contract Incompleteness

If there is no contract incompleteness, the principal P can make contract to make sure her favorite project is chosen for both divisions when at least one agent is informed. $\Pi_1^P = \Pi_2^P = B$, $\Pi_1^1 = \Pi_2^1 = \beta_1 b$, $\Pi_2^2 = \Pi_1^2 = \beta_2 b$, so the joint pay-off is $S_P = 2(B + \beta_1 b + \beta_2 b)$. The expected social welfare will be:

$$2(e_1 + e_2 - e_1 e_2)(B + \beta_1 b + \beta_2 b) - g_A(e_1) - g_A(e_2) \quad (1)$$

In order to maximize this social welfare function, the efforts by the two agents should satisfy, the superscript * means social optimal:

$$g'_A(e_1^*) = 2(1 - e_2^*)(B + \beta_1 b + \beta_2 b) \quad (2)$$

$$g'_A(e_2^*) = 2(1 - e_1^*)(B + \beta_1 b + \beta_2 b) \quad (3)$$

These first order conditions imply the agents choose effort such that the marginal cost of searching is equal to the marginal return to all three parties. Here because the favorite project of P will be chosen either A_1 or A_2 is informed, so one agent's effort is a pure waste if the other is already informed. In each division, the return to one unit of effort by agent i is one unit chance higher to get B to the principal, $\beta_1 b$ to A_1 and $\beta_2 b$ to A_2 given the other agent is not informed (multiplied by $(1 - e_j^*)$, $j \in \{1, 2\}$, $j \neq i$). There are two divisions,

so the “social” return to each unit of effort is two times the return to three parties in one division.

Because the cost function $g(e)$ of effort is increasing in e , we can infer that the derivative of the equilibrium effort with respect to the variables or parameters in the right hand side of the above equations share the sign of that of the cost function with respect to the same variables or parameters. It is straightforward that $\partial g'_A(e_i^*)/\partial e_j^* < 0$, $\partial g'_A(e_i^*)/\partial B > 0$, $\partial g'_A(e_i^*)/\partial b > 0$, $\partial g'_A(e_i^*)/\partial \beta_1 > 0$, $\partial g'_A(e_i^*)/\partial \beta_2 > 0$, so $\partial e_i^*/\partial e_j^* < 0$, $\partial e_i^*/\partial B > 0$, $\partial e_i^*/\partial b > 0$, $\partial e_i^*/\partial \beta_1 > 0$, $\partial e_i^*/\partial \beta_2 > 0$. The equilibrium effort by A_i is decreasing in the other agent’s effort, and increasing in the benefits of all agents, and the parameters of interest congruence between the principal and agents.

4 Agents’ Effort under Incomplete Contract without Bargaining

Now we introduce contract incompleteness into the model. There are many rationales in the reality for this assumption, e.g. due to unforeseeable contingency of the project.

4.1 The Case of Separation

When $\gamma_1 = \gamma_2$, the joint benefit of A_1 and A_2 are the same, and therefore leaves no room for bargaining. In this case the benefit to the two agents from the two divisions are:

$$\Pi_1^1 = e_1 b + (1 - e_1) e_2 \gamma_1 b$$

$$\Pi_2^1 = e_2 \gamma_1 b + (1 - e_2) e_1 b$$

$$\Pi_1^2 = e_1 \gamma_2 b + (1 - e_1) e_2 b$$

$$\Pi_2^2 = e_2 b + (1 - e_2) e_1 \gamma_2 b$$

Add them up and subtract the cost of searching,

$$\Pi^1 = (2e_1 + 2e_2 \gamma_1 - e_1 e_2 - e_1 e_2 \gamma_1) b - g_A(e_1)$$

$$\Pi^2 = (2e_2 + 2e_1 \gamma_2 - e_1 e_2 - e_1 e_2 \gamma_2) b - g_A(e_2)$$

The agents' effort should satisfy, let hat denotes separation without bargaining:

$$g'_A(\hat{e}_1) = [2 - \hat{e}_2(1 + \gamma_1)]b \quad (4)$$

$$g'_A(\hat{e}_2) = [2 - \hat{e}_1(1 + \gamma_2)]b \quad (5)$$

These first order conditions imply the agents choose effort such that the marginal cost of searching is equal to the marginal return to himself. The marginal benefit from the division where the agent i is in control is one unit chance higher for getting b given the other is not informed (multiplied by $(1 - \hat{e}_j)$, $j \in \{1, 2\}$, $j \neq i$), but there is a marginal opportunity cost that if i does not search, it will increase the possibility that i is not informed but the other agent j is informed, and j 's favorite project will bring him $\hat{e}_j\gamma_i b$. So the net marginal profit from D_i to i is $(1 - \hat{e}_j\gamma_i)b$. The net marginal profit for i from D_j is $(1 - \hat{e}_j)b$, because the effort generates no return if j is informed, and b when j is not informed. So the net marginal return to i from two divisions are $[2 - \hat{e}_j(1 + \gamma_i)]b$.

As we already know B is much larger than b , and the difference between $2(1 - e^*)$ and $[2 - \hat{e}(1 + \gamma)]$ is at most 2, the effort in this case should be lower than first best in most of the cases. So in most cases we have $\hat{e}_i < e_i^*$, $i \in \{1, 2\}$.

4.2 The Case of Integration

We just analyze the case where A_1 is assigned control, and the case where A_2 has control is analogous. In this case it is just like A_1 has two divisions of his own, and A_2 is last to search in both divisions.

$$\Pi^1 = 2[e_1 + (1 - e_1)e_2\gamma_1]b - g_A(e_1)$$

$$\Pi^2 = 2[e_1\gamma_2 + (1 - e_1)e_2]b - g_A(e_2)$$

The agents' effort should satisfy. We use upper bar to denote A_1 control:

$$g'_A(\bar{e}_1) = 2(1 - \gamma_1\bar{e}_2)b \quad (6)$$

$$g'_A(\bar{e}_2) = 2(1 - \bar{e}_1)b \quad (7)$$

These first order conditions imply the agents choose effort such that the marginal cost of searching is equal to the marginal return to himself. And integration under A_1 control is just analogous to the case when both divisions are A_1 's "own division" analyzed in the separation case. Each 1 unit of effort by A_1 gives him more chance to get b but less chance

to get $\gamma_1 b$ from freeriding A_2 's effort. Each unit of effort brings A_2 private benefit b only when A_1 is uninformed.

Compare this to the first order condition in separation, it is clear that for the same e_2 , e_1 is larger in this case and for the same e_1 , e_2 is smaller in this case. Moreover, in both cases, e_1 (e_2) is decreasing in e_2 (e_1). So we can prove by simple contradiction that $\bar{e}_1 > \hat{e}_1, \bar{e}_2 < \hat{e}_2$. By the same argument in the above, \bar{e}_1, \bar{e}_2 is smaller than in the first best. To sum up the case of separation and integration, we can find:

Proposition 1. *Due to conflict of interest, the searching effort chosen by the agents is always smaller under incomplete contract than under the case without contract incompleteness.*

Proposition 2. *Compared to the case of separation, the party who is assigned the control when the divisions are integrated has stronger incentive to search, and the party who loses the control during the integration has lower incentive to search.*

5 Agents' Effort under Incomplete Contract with Bargaining

5.1 The Case of Separation

We can assume the joint pay-off is larger under favorite of A_1 ($b + \gamma_2 b > \gamma_1 b + b$). So in D_1 , there is no room for bargaining, because by choosing favorite of A_2 , the joint pay-off is worse. In D_2 , A_2 can choose favorite of A_1 , but claim part of the surplus in the joint benefit. The sharing rule is set so that a share of w goes to A_1 and $(1 - w)$ goes to A_2 . So on expectation:

$$\begin{aligned}
\Pi_1^1 &= e_1 b + (1 - e_1) e_2 \gamma_1 b \\
\Pi_2^1 &= (1 - e_1) e_2 \gamma_1 b + e_1 e_2 [(1 - w) \gamma_1 + w \gamma_2] b \\
&\quad + (1 - e_2) e_1 b \\
\Pi_1^2 &= e_1 \gamma_2 b + (1 - e_1) e_2 b \\
\Pi_2^2 &= (1 - e_1) e_2 b + e_1 e_2 [1 + (1 - w) (\gamma_2 - \gamma_1)] b \\
&\quad + (1 - e_2) e_1 \gamma_2 b \\
\Pi_1^P &= [e_1 \alpha_1 + (1 - e_1) e_2 \alpha_2] B \\
\Pi_2^P &= [e_1 e_2 \alpha_1 + (1 - e_1) e_2 \alpha_2 + (1 - e_2) e_1 \alpha_1] B \\
&= [e_1 \alpha_1 + (1 - e_1) e_2 \alpha_2] B
\end{aligned}$$

$$\begin{aligned}
\Pi^1 &= e_1 b + 2(1 - e_1) e_2 \gamma_1 b + \\
&\quad e_1 e_2 [(1 - w) \gamma_1 + w \gamma_2] b + (1 - e_2) e_1 b - g_A(e_1) \\
\Pi^2 &= e_1 \gamma_2 b + (1 - e_2) e_1 \gamma_2 b \\
&\quad + 2(1 - e_1) e_2 b + e_1 e_2 [1 + (1 - w) (\gamma_2 - \gamma_1)] b - g_A(e_2) - g_A(e_2) \\
\Pi^P &= 2[e_1 \alpha_1 + (1 - e_1) e_2 \alpha_2] B
\end{aligned}$$

Here for simplicity we assume there is no change in the interest congruence parameter between the agents and the principal during the bargaining. We know that the parameters of interest congruence are based on the parties' *ex ante* expectation on the pay-off structure of the projects. This expectation is like a *prior*, and will be updated once the agent is informed. So we can surely use these parameters to analyze the cases when at least one party is uninformed, but take care when dealing with bargaining where both agents must be informed. We leave the discussion on what will happen if we relax this condition to the next section.

The efforts by the two agents should satisfy the conditions as below, the superscript SP means separation:

$$g'_A(e_1^{SP}) = (2 - e_2^{SP} (1 + \gamma_1 - w(\gamma_2 - \gamma_1))) b \quad (8)$$

$$g'_A(e_2^{SP}) = (2 - e_1^{SP} [1 + \gamma_2 - (1 - w)(\gamma_2 - \gamma_1)]) b \quad (9)$$

These first order conditions imply the agents choose effort such that the marginal cost of searching is equal to the marginal return to himself. In D_1 the marginal return of one

unit of effort by the agents is the same with the case when there is no bargaining. In D_2 , one unit of effort will bring A_1 one unit chance higher to get benefit b if A_2 is not informed, one unit chance higher to get $[(1-w)\gamma_1 + w\gamma_2]b$, and opportunity cost of one unit chance to get $\gamma_1 b$ from freeriding A_2 .

5.2 The Case of Integration

We can still assume the joint pay-off is larger under favorite of A_1 ($b + \gamma_2 b > \gamma_1 b + b$).

If A_1 controls, A_1 always searches first in both divisions, and then A_2 . There is no need for bargaining.

$$\Pi^1 = 2[e_1 b + (1 - e_1)e_2 \gamma_1 b] - g_A(e_1)$$

$$\Pi^2 = 2[e_1 \gamma_2 b + (1 - e_1)e_2 b] - g_A(e_2)$$

$$\Pi^P = 2[e_1 \alpha_1 B + (1 - e_1)e_2 \alpha_2 B]$$

FOC (UP for A_1 control):

$$g'_A(e_1^{UP}) = 2(1 - e_2^{UP} \gamma_1) b \quad (10)$$

$$g'_A(e_2^{UP}) = 2(1 - e_1^{UP}) b \quad (11)$$

If A_2 controls, there is need for bargaining. (DOWN for A_2 control) Say the generalized Nash bargaining determines the share of surplus is $w : (1 - w)$

$$\begin{aligned} \Pi^1 = & 2\{e_2(1 - e_1)\gamma_1 + e_1 e_2[(1 - w)\gamma_1 + w\gamma_2] \\ & + (1 - e_2)e_1\}b - g_A(e_1) \end{aligned}$$

$$\begin{aligned} \Pi^2 = & 2\{e_2(1 - e_1) + e_1 e_2[1 + (1 - w)(\gamma_2 - \gamma_1)] \\ & + (1 - e_2)e_1 \gamma_2\}b - g_A(e_2) \end{aligned}$$

$$\begin{aligned} \Pi^P = & 2[e_2(1 - e_1)\alpha_2 + e_1 e_2 \alpha_1 \\ & + e_1(1 - e_2)\alpha_1]B \end{aligned}$$

$$g'_A(e_1^{DOWN}) = 2(1 - e_2^{DOWN}(1 + \gamma_1 - [(1 - w)\gamma_1 + w\gamma_2]))b \quad (12)$$

$$g'_A(e_2^{DOWN}) = 2(1 - e_1^{DOWN}(1 + \gamma_2 - [1 + (1 - w)(\gamma_2 - \gamma_1)]))b \quad (13)$$

5.3 The Principal's Decision on Divisional Structure

It can be seen that as long as A_1 and A_2 are informed, they always reach the project that maximizes their joint pay-off *ex post*. But this does not necessarily mean the choice of project is always efficient for the principal. Because the informed agents choose A_1 's favorite project if $b + \gamma_2 b > \gamma_1 b + b \Leftrightarrow \gamma_2 > \gamma_1$ ² when the principal is uninformed, but A_1 's favorite project is better for the principal only when $\alpha_1 > \alpha_2$.

Let parameter $\phi = 1 + \gamma_1 - [(1 - w)\gamma_1 + w\gamma_2] = 1 - w(\gamma_2 - \gamma_1) \in [0, 1]$, $\delta = 1 + \gamma_2 - [1 + (1 - w)(\gamma_2 - \gamma_1)] = w\gamma_2 + (1 - w)\gamma_1 \in [0, 1]$, $\rho = \frac{\phi + \gamma_1}{2} \in [0, 1]$, $\sigma = \frac{\delta + 1}{2} \in [0, 1]$, and all functions $g(e) = e^2 b$, this will give us the equation systems:

$$e_1^{SP} = 1 - \rho e_2^{SP}, e_2^{SP} = 1 - \sigma e_1^{SP} \quad (14)$$

$$e_1^{UP} = 1 - \gamma_1 e_2^{UP}, e_2^{UP} = 1 - e_1^{UP} \quad (15)$$

$$e_1^{DOWN} = 1 - \phi e_2^{DOWN}, e_2^{DOWN} = 1 - \delta e_1^{DOWN} \quad (16)$$

Solve them, we can get:

$$e_1^{SP} = \frac{1 - \rho}{1 - \rho\sigma}, e_2^{SP} = \frac{1 - \sigma}{1 - \rho\sigma} \quad (17)$$

$$e_1^{UP} = 1, e_2^{UP} = 0 \quad (18)$$

$$e_1^{DOWN} = \frac{1 - \phi}{1 - \delta\phi}, e_2^{DOWN} = \frac{1 - \delta}{1 - \delta\phi} \quad (19)$$

Let $e_1^{DOWN} = p$, $e_2^{DOWN} = q$, so $e_1^{SP} = m$, $e_2^{SP} = n$, it is easy to prove $\rho < \phi$ and $\sigma > \delta$, so $m > p$, $n < q$, $\phi + \delta = \rho + \sigma = 1 + \gamma_1$. Because $\phi, \delta, \rho, \sigma \in [0, 1]$, p, q, m, n are also in $[0, 1]$. Because these parameters are also the negative cross derivative of one agent's effort e_i on the effort of the other e_j (e.g. $\partial e_1^{SP} / \partial e_2^{SP} = -\rho$, $\partial e_2^{SP} / \partial e_1^{SP} = -\sigma$), this immediately gives us:

Proposition 3. *The effort of agents are always substitutes, the increase (decrease) in one agent's effort always discourages (encourages) the effort by the other agent.*

The welfare for principal under these cases are:

$$\Pi_P^{SP} = 2[n(1 - m)\alpha_2 + m\alpha_1]B \quad (20)$$

$$\Pi_P^{UP} = 2\alpha_1 B \quad (21)$$

²The intuition here the agents want to choose the project that give the party not in control more utility, when the party in control's utility is fixed.

$$\Pi_P^{DOWN} = 2[q(1-p)\alpha_2 + p\alpha_1]B \quad (22)$$

From the above equations, we see the principal's benefit under separation goes to the benefit under A_1 control when p goes to 1, and goes to that of A_2 control when p goes to 0 and q goes to 1. Here if $\alpha_1 > \alpha_2$, $\Pi_P^{UP} > \Pi_P^{SP} > \Pi_P^{DOWN}$; if $\alpha_1 < \alpha_2$, $\Pi_P^{DOWN} > \Pi_P^{SP} > \Pi_P^{UP}$.³ This gives us:

Proposition 4. *If there is no spill-over effect of the agents' effort, it is always optimal for the principal to merge the divisions and give the control to the agent whose effort is more important for him. Separation of divisions is always dominated by integration.*

We can also get some comparatives: because $\gamma_2 > \gamma_1$, $\partial\phi/\partial w = -(\gamma_2 - \gamma_1) < 0$, $\partial\delta/\partial w = \gamma_2 - \gamma_1 > 0$. Moreover, we have $\partial\phi/\partial\gamma_1 = w > 0$, $\partial\phi/\partial\gamma_2 = -w < 0$. $\partial\delta/\partial\gamma_1 = 1 - w > 0$, $\partial\delta/\partial\gamma_2 = w > 0$. We know p is decreasing in ϕ and increasing in δ , and q is decreasing in δ and increasing in ϕ . So

$$\frac{\partial p}{\partial w} = \frac{\partial p}{\partial\phi} \times \frac{\partial\phi}{\partial w} + \frac{\partial p}{\partial\delta} \times \frac{\partial\delta}{\partial w} > 0 \quad (23)$$

$$\frac{\partial p}{\partial\gamma_2} = \frac{\partial p}{\partial\phi} \times \frac{\partial\phi}{\partial\gamma_2} + \frac{\partial p}{\partial\delta} \times \frac{\partial\delta}{\partial\gamma_2} > 0 \quad (24)$$

The sign of $\frac{\partial p}{\partial\gamma_1} = \frac{\partial p}{\partial\phi} \times \frac{\partial\phi}{\partial\gamma_1} + \frac{\partial p}{\partial\delta} \times \frac{\partial\delta}{\partial\gamma_1}$ depends on the relative scale of influence from ϕ and from δ .

Similarly, we can get:

$$\frac{\partial q}{\partial w} = \frac{\partial q}{\partial\phi} \times \frac{\partial\phi}{\partial w} + \frac{\partial q}{\partial\delta} \times \frac{\partial\delta}{\partial w} < 0 \quad (25)$$

$$\frac{\partial q}{\partial\gamma_2} = \frac{\partial q}{\partial\phi} \times \frac{\partial\phi}{\partial\gamma_2} + \frac{\partial q}{\partial\delta} \times \frac{\partial\delta}{\partial\gamma_2} < 0 \quad (26)$$

$$\frac{\partial m}{\partial w} = \frac{\partial m}{\partial\rho} \times \frac{\partial\rho}{\partial w} + \frac{\partial m}{\partial\sigma} \times \frac{\partial\sigma}{\partial w} > 0 \quad (27)$$

$$\frac{\partial m}{\partial\gamma_2} = \frac{\partial m}{\partial\rho} \times \frac{\partial\rho}{\partial\gamma_2} + \frac{\partial m}{\partial\sigma} \times \frac{\partial\sigma}{\partial\gamma_2} > 0 \quad (28)$$

$$\frac{\partial n}{\partial w} = \frac{\partial n}{\partial\rho} \times \frac{\partial\rho}{\partial w} + \frac{\partial n}{\partial\sigma} \times \frac{\partial\sigma}{\partial w} < 0 \quad (29)$$

$$\frac{\partial n}{\partial\gamma_2} = \frac{\partial n}{\partial\rho} \times \frac{\partial\rho}{\partial\gamma_2} + \frac{\partial n}{\partial\sigma} \times \frac{\partial\sigma}{\partial\gamma_2} < 0 \quad (30)$$

³If $\alpha_1 > \alpha_2$, $\alpha_1 = p\alpha_1 + (1-p)\alpha_1 > qp\alpha_1 + (1-p)\alpha_1 > qp\alpha_2 + (1-p)\alpha_1$, so $\Pi_P^{UP} > \Pi_P^{DOWN}$, similarly we can get $\Pi_P^{UP} > \Pi_P^{SP}$ and vice versa.

This result is intuitive: the larger share A_1 can get from bargaining, the more he would like to search, and the more A_2 is discouraged. The larger the γ_2 , the larger chance they will have bargain, so the more A_1 will have incentive to search, and the more A_2 is discouraged. The effect of γ_1 is not clear, but we may still get some qualitative result from reasoning. Both A_1 and A_2 actually have **two folded purposes to do searching**: for A_1 it is (1) search for the project not found by A_2 to get b ; (2) search for the project found by A_2 to get a share from bargaining. For A_2 it is (3) search for the projects not found by A_1 so that he can get b ; (4) search to find more project found by A_1 so that he can get a fraction of surplus $(1 - w)(\gamma_2 - \gamma_1)b$ from bargaining. When γ_1 is high, it seems A_1 should always search less because he get less compared to doing nothing from both (1) and (2). When A_1 searches less, it is better for A_2 to search more because he has larger chance to get b , but the rise in γ_1 also means a rise in A_1 's bargaining position, and therefore less surplus from (4). So the effect of γ_1 on A_2 is not clear.

To sum up, we can get the proposition:

Proposition 5. *An agent will always have more incentive to search if his share of surplus from bargaining is large. The larger (smaller) the default pay-off of the agent whose project is chosen, the more (less) this agent will search, and the less the other will do. The larger the default pay-off of the agent whose project is not chosen, the less (more) the agent whose project is chosen will search. The effect of the default pay-off of the agent whose project is not chosen on his effort to search can be positive or negative.*

6 The Spill-over Effect between Agents

6.1 The indifference frontier

In this section we can consider two kinds of spill-over effect: (1) the efficiency enhancing and destroying effect due to integration, as introduced by Riyanto (2000) and (2) the change of interest congruence in the bargaining.

We can think of the efficiency enhancing effect of integration where Principal's every possible benefit B_i becomes $(1 + \Delta)B_i$ where $\Delta > 0$. This happens when integration promotes synergy⁴ between the departments. Or efficiency destroying effect of integration where $\Delta < 0$, where maybe the effort by one agent has some negative externality on the other. $\Delta = 0$ when there is no externality due to integration.

⁴Or *complementary gains* as in Olsen (1996).

The other kind of spill over effect is when the project is chosen through bargaining between informed A_1 and A_2 , the Principal's conditional expected pay-off of the “ A_1 's favorite project” (given A_2 is also informed about this project) may be different from that of unconditional mean of “ A_1 's favorite project”. So this kind of project might actually has a different interest congruence α_3 to the Principal. And it could be that $\alpha_3 > \alpha_1$, meaning the bargaining between the agents betrays the principal's interest, or also could be $\alpha_3 < \alpha_1$, meaning the bargaining respects the principal's interest better than A_1 's individual decision.

Moreover, we can assume there is a fixed cost C for separation (e.g. new offices, new equipment, or just communication cost). $C > 0$ means it is costly to set up two departments, and $C < 0$ means running two small departments is more cost saving than running one big department.

Substitute these into (17), (18) and (19) we can get:

$$\Pi_P^{SP} = 2n\alpha_2 + 2m\alpha_1 + mn(\alpha_3 - \alpha_1 - 2\alpha_2)B - C \quad (31)$$

$$\Pi_P^{UP} = 2\alpha_1(1 + \Delta)B \quad (32)$$

$$\Pi_P^{DOWN} = 2[q\alpha_2 + p\alpha_1 + pq(\alpha_3 - \alpha_1 - \alpha_2)](1 + \Delta)B \quad (33)$$

Intuitively, the larger the Δ , the more we prefer integration to separation. The larger the C the more we want to integrate. The larger the α_3 the more we prefer the cases with bargaining (separation and A_2 control) to the cases without bargaining (A_1 control). Especially, if $\Delta = C = 0$, $\alpha_3 > \alpha_1$, $\alpha_1 \gg \alpha_3 - \alpha_1$, $\alpha_2 \rightarrow 0$, $m \gg p$, and $m \rightarrow 1$ we can have $\Pi_P^{SP} > 2\alpha_1 B = \Pi_P^{UP}$, $\Pi_P^{SP} > \Pi_P^{DOWN}$, meaning separation dominates integration. To sum up, we have:

Proposition 6. *When spill-over effect of merge is taken into account, both separation and integration can be optimal. It is better for the principal to have integration of control when synergy effect and large set-up cost of new division are large, and separation when they are small. The proper scope of separation and integration also depends on the interest congruence parameters before and after bargaining.*

6.2 Numerical Simulations

Because we have many parameters in this model, it is really difficult to solve analytically the frontier of the optimality for different control allocations. We can do pick some values and do numerical simulation instead.

With respect to synergy and set-up cost

A rough illustration on the effect of synergy Δ and set up cost C : large synergy and cost to set up separate departments make it more favorable for the principal to take integration, and vice versa. So there is a frontier in the graph on which the principal is indifferent to have integration or separation. She prefers to have integration when the combination lies to the northeast of the frontier, and vice versa.

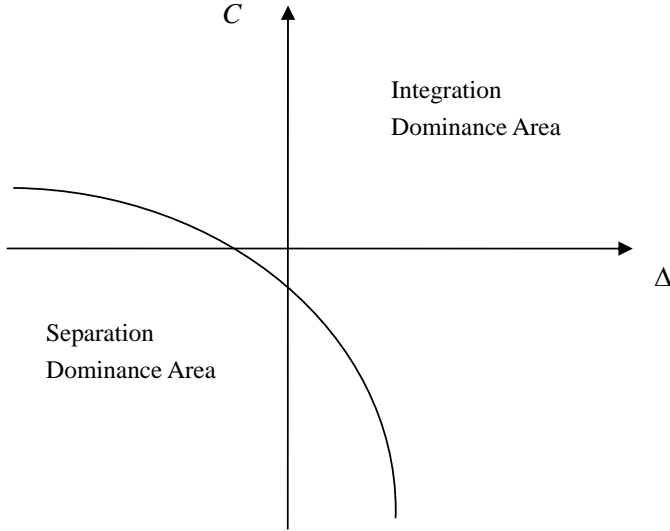

Figure 3: The frontier of the dominance area of separation and integration with respect to Δ and C .

With respect to interest congruence parameter α_i

We let $C = \Delta = 0$, $\alpha_1 = 0.5$, so Π_P^{UP} is normalized to 1. We use α_2 and α_3 as the axis in the xy-plane. α_2 represents the relative productivity of A_2 , α_3 represents the interest congruence enhancing (destroying) effect of bargaining. So it is intuitive to expect the result will favor A_2 control for large α_2 values, and favor separation for large α_3 values. We can start from a very simple combination of parameters: $\gamma_1 = \gamma_2 = w = 0.5$. Which can be shown in the following figure:

The z-axis represents the principal's benefit under these divisional structures. So the optimal control right is the highest surface in the graph. This graph shows integration under either agent 1 or agent 2 control can be optimal. The 2-D graph will be like:

Starting from this, we may continue to investigate qualitatively how the optimal control area changes with the three parameters. First we may want to see the case when γ_1 increases

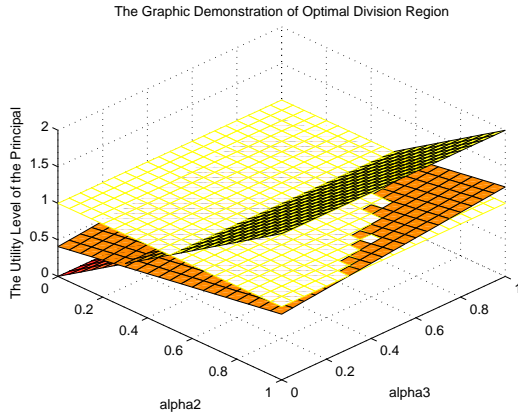

Figure 4: The principal's benefit when $\gamma_1 = \gamma_2 = w = 0.5$. The yellow surface with black grid is the utility under agent 2 control, the white surface with yellow grid is under agent 1 control and the orange one is her utility under separation.

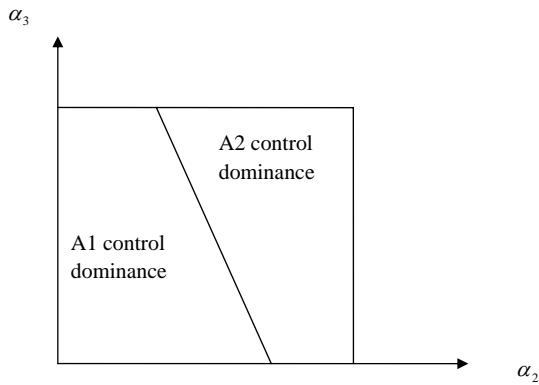

Figure 5: The case when only integration can be optimal.

or decreases.

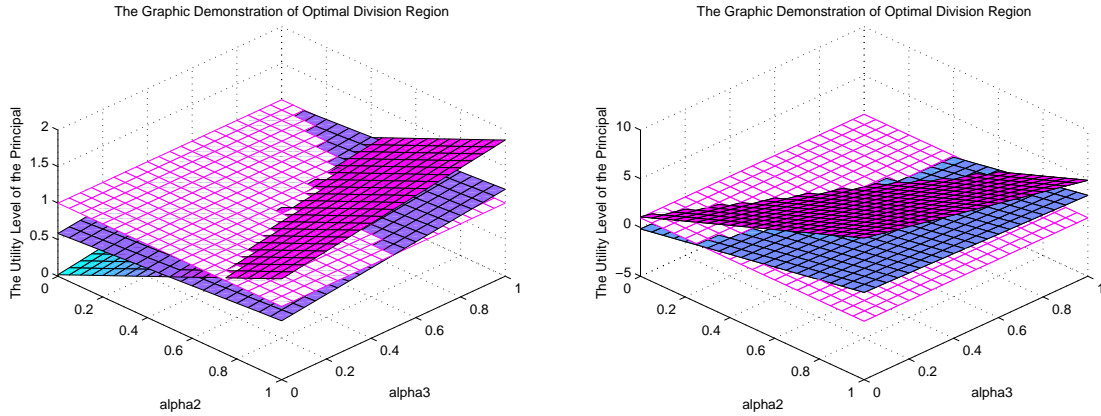

Figure 6: The principal's benefit when $\gamma_1 = 0.1, \gamma_2 = w = 0.5$ (left) and $\gamma_1 = 0.9, \gamma_2 = w = 0.5$ (right). The pink surface with black grid is the utility under agent 2 control, the white surface with pink grid is under agent 1 control and the purple one is her utility under separation.

In this case all three control allocations can be optimal. There is a frontier on which the principal is indifferent between each two control allocations. The 2-D graph will be like.

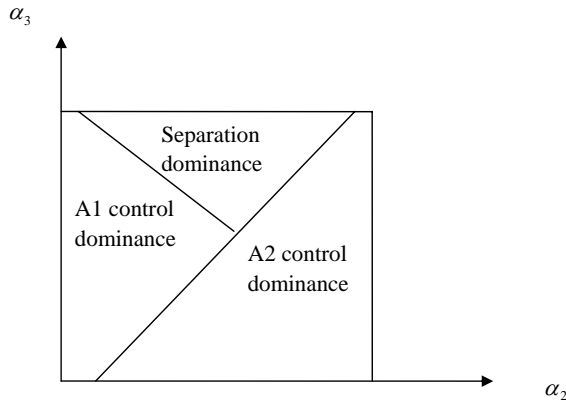

Figure 7: The case when both integration and separation can be optimal.

Then we look at the case when $\gamma_1 = \gamma_2 = 0.5$, and γ_2 changes. We see separation dominance is possible when γ_2 is small, but not possible when γ_2 is large.

Then we look at the case when $\gamma_1 = w = 0.5$, and w changes. We see separation dominance is impossible for both big and small w .

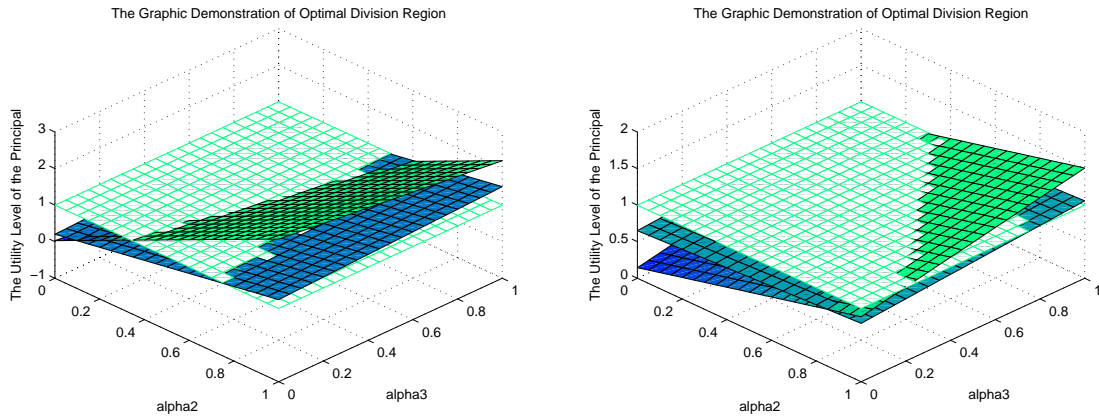

Figure 8: The principal's benefit when $\gamma_1 = 0.5, \gamma_2 = 0.1, w = 0.5$ (left) and $\gamma_1 = 0.5, \gamma_2 = 0.9, w = 0.5$ (right). The green-blue surface with black grid is the utility under agent 2 control, the white surface with green grid is under agent 1 control and the dark green one is her utility under separation.

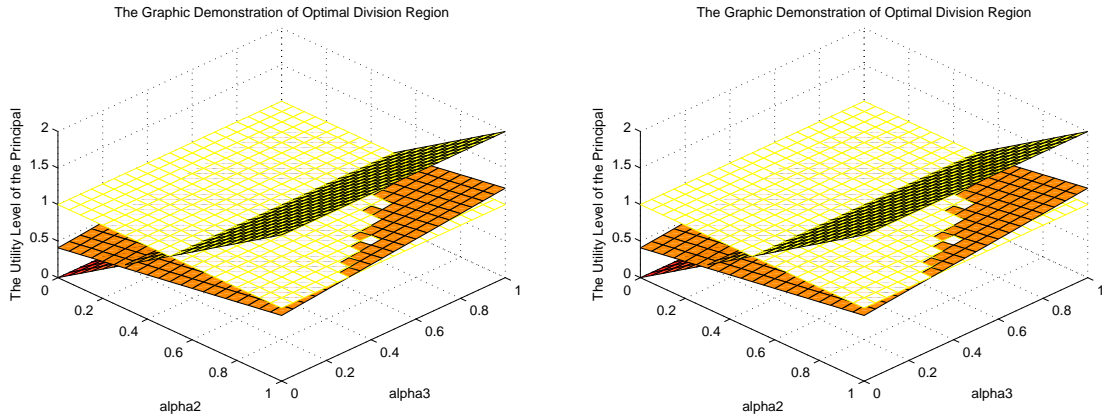

Figure 9: The principal's benefit when $\gamma_1 = 0.5, \gamma_2 = 0.5, w = 0.1$ (left) and $\gamma_1 = 0.5, \gamma_2 = 0.5, w = 0.9$ (right). The yellow-red surface with black grid is the utility under agent 2 control, the white surface with yellow grid is under agent 1 control and the orange one is her utility under separation.

7 Conclusion and Discussion

We build an incomplete contract model where setup (communication) cost, synergy effect, incentive induced by control structure and change in the interest congruence between the principal and agent matter for the decision on internal integration (separation) of divisions at the same time. The first two factor are basically very similar to the adaptation-coordination trade off in communication literature before, and the incentive induced by control gives very similar result as Grossman and Hart (1986), where it is usually better to assign the control right to the people whose incentive is more important to the performance measure we concern (joint payoff in Grossman and Hart (1986), and the principal's benefit in our model). We show that the "integration dominance" argument usually still applies without the change of interest congruence, because intuitively, separation is like a linear combination of both kind of integrations (A_1 control in D_1 and A_2 control in D_2 is equivalent to half A_1 control on both and half A_2 control on both when D_1 and D_2 are assumed to be identical), which is usually dominated by corner solution in this kind of problems. The change of interest congruence during bargaining is a key factor that differentiate internal integration problem with external integration, which may lead to a considerable area of separation dominance not seen before. The rationale for the principal to choose separation is integration may either harms the productive person too much (when she gives control to the unproductive one, whose favorite project happens not to maximize the joint payoff of the two agents), or erase the room for interest congruence enhancing bargaining (when she gives control to the productive one, whose favorite project happens not to maximize the joint payoff of the two agents). Then separation comes as a "compromise" of the two and therefore is better of both extremes. The optimal divisional structure may be a balance of all four forces discussed above. When the incentive problem and synergy effect is more important, and there is positive setup cost for new division, it is better to have integration with productive agent control. When the enhancement of interest congruence is more important, and there is positive cost to merge divisions, it is better to have separation.

The principal plays a central role in the choice of control right allocation in this paper. We can also note several differences between her role in this model and that in the past literatures. First, the principal in our work is not a "searching (productive) principal" in Aghion and Tirole (1997), because she does not search, and therefore does not make decision on each specific projects. We restrict our attention on the principal's decision on the divisional structure, and leave out her role in daily operation. We can think of many real life examples of this assumption. For instance, it is not necessary for the president of a hospital to treat a lot of patients everyday, or the president of a university to do a lot of

research. It is more important for them to make decisions on the general management level and allocate the decision right to the divisions properly to promote the overall efficiency of the organization. Secondly, she is not a “bargaining principal” in the models on the principal’s choice between in-house production and out-sourcing (Hart *et al*, 1997). The principal in our model does not bargain directly with her agents, but plays a central role in the bargaining between the agents, because her decision on the control allocation determines their bargaining position. Finally, she is not a principal making their decision based on the functional features of the divisions (Bolton and Dewatripont, 1994, Hart and Moore, 2005). The principal in our model are deciding the divisional structure on two departments performing the same task.

We are aware that in complete contracting literature, there are also papers that compares the efficiency of contracts under three kinds of organizational structures: *separation*, *integration* and *nested departments* (Baron and Besanko, 1992, Melumad *et al*, 1995, Mookherjee and Tsumagari, 2004, Severinov, 2008). It should be noticed that we use “separation” in complete and incomplete contract for the same meaning, but the “integration” in this paper is more like the “nested departments” or “subcontracting” in complete contract. “Integration” is used in complete contract only for the case when the departments are merged, one agent is made the manager while the other agent is removed from the game. So the result of this paper is different from the result of Mookherjee and Tsumagari (2004), in which subcontracting (similar to the integration case in our model) is proved to be dominated when the supply of agents are substitutes.⁵ It would be interesting to test the different predictions by complete and incomplete contract theory empirically. The current model can be extended and enriched in many ways. We leave the development of a model with more than two agents, and analytical solution of the frontier of the dominance control area for future work.

⁵Our model assumes homo-functional divisions, so the efforts of agents are basically strategic substitutes. Our model suggests that integration is usually dominating separation.

References

1. Aghion, P., and J. Tirole, "Formal and Real Authority in Organizations", *Journal of Political Economy*, Vol. 105, No. 1. (Feb., 1997), pp. 1-29.
2. Baron, D., and D. Besanko, "Information, Control, and Organizational Structure", *Journal of Economics & Management Strategy*, Volume 1 Issue 2, (Jan, 2005), pp. 237-275.
3. Bolton, P., and M. Dewatripont, "The Firm as a Communication Network", *Quarterly Journal of Economics*, Vol. 109, No. 4 (Nov., 1994), pp. 809-839.
4. Dessein, W., and T. Santos, "Adaptive Organizations", *Journal of Political Economy*, 2006, vol. 114, no. 5. 956-995.
5. Grossman, S., and Hart, "The Costs and Benefits of Ownership: A Theory of Vertical and Lateral Ownership, *Journal of Political Economy*, 94, 1986, 691-719.
6. Hart, O., and J. Moore, "On the Design of Hierarchies: Coordination versus Specialization", *Journal of Political Economy*, 2005, vol. 113, no. 4.
7. Hart, O., Shleifer, A., and R. W. Vishny, "The Proper Scope of Government: Theory and an Application to Prisons " *Quarterly Journal of Economics*, Vol. 112, No. 4 (Nov., 1997), pp. 1127-1161.
8. Maskin, E., Qian, Y. and C. Xu, "Incentives, Information, and Organizational Form", *Review of Economic Studies*, Vol. 67, No. 2 (Apr., 2000), pp. 359-378.
9. Milgrom, P. and Roberts, J. (1992) *Economics, Organization, and Management* (Englewood Cliffs, NJ: Prentice Hall).
10. Mookherjee, D., "Decentralization, Hierarchies, and Incentives: A Mechanism Design Perspective", *Journal of Economic Literature*, vol. 44(2) (June, 2006) , pp. 367-390.
11. Mookherjee, D., and M. Tsumagari, "The Organization of Supplier Networks: Effects of Delegation and Intermediation", *Econometrica*, Vol. 72, No. 4 (Jul., 2004), pp. 1179-1219.
12. Melumad, N., Mookherjee D., and S. Reichelstein, "Hierarchical Decentralization of Incentive Contracts", *RAND Journal of Economics*, Vol. 26, No. 4, Symposium on the Economics of Organization (Winter, 1995), pp. 654-672.
13. Olsen, T., "Agency Costs and the Limits of Integration," *RAND Journal of Economics*, 27, 1996, pp.479-501.

14. Poitevin, M., "Contract Renegotiation and Organizational Design", *mimeo*, 1994
15. Riyanto, Y. E. , "Delegation of authority, managerial initiatives, and the design of divisional structure", *mimeo*, 2000.
16. Severinov S., "The value of information and optimal organization", *RAND Journal of Economics*, Vol. 39, No. 1, (Spring 2008), pp. 238-265.
17. Rotemberg J., and G. Saloner, "Leadership Style and Incentives", *Management Science*, Vol. 39, No. 11 (Nov., 1993), pp. 1299-1318.