

Rouwendal, Jan; van der Vlist, Arno

Working Paper

A Dynamic Model of Commutes

Tinbergen Institute Discussion Paper, No. 02-026/3

Provided in Cooperation with:

Tinbergen Institute, Amsterdam and Rotterdam

Suggested Citation: Rouwendal, Jan; van der Vlist, Arno (2002) : A Dynamic Model of Commutes, Tinbergen Institute Discussion Paper, No. 02-026/3, Tinbergen Institute, Amsterdam and Rotterdam

This Version is available at:

<http://hdl.handle.net/10419/85962>

Standard-Nutzungsbedingungen:

Die Dokumente auf EconStor dürfen zu eigenen wissenschaftlichen Zwecken und zum Privatgebrauch gespeichert und kopiert werden.

Sie dürfen die Dokumente nicht für öffentliche oder kommerzielle Zwecke vervielfältigen, öffentlich ausstellen, öffentlich zugänglich machen, vertreiben oder anderweitig nutzen.

Sofern die Verfasser die Dokumente unter Open-Content-Lizenzen (insbesondere CC-Lizenzen) zur Verfügung gestellt haben sollten, gelten abweichend von diesen Nutzungsbedingungen die in der dort genannten Lizenz gewährten Nutzungsrechte.

Terms of use:

Documents in EconStor may be saved and copied for your personal and scholarly purposes.

You are not to copy documents for public or commercial purposes, to exhibit the documents publicly, to make them publicly available on the internet, or to distribute or otherwise use the documents in public.

If the documents have been made available under an Open Content Licence (especially Creative Commons Licences), you may exercise further usage rights as specified in the indicated licence.



TI 2002-026/3

Tinbergen Institute Discussion Paper

A Dynamic Model of Commutes

*Jan Rouwendal**

*Arno J. van der Vlist***

* Wageningen University, Dept. of Spatial Economics, Faculty of Economics and Business Administration, Vrije Universiteit Amsterdam, and Tinbergen Institute,

** Dept. of Spatial Economics, Faculty of Economics and Business Administration, Vrije Universiteit Amsterdam.

Tinbergen Institute

The Tinbergen Institute is the institute for economic research of the Erasmus Universiteit Rotterdam, Universiteit van Amsterdam and Vrije Universiteit Amsterdam.

Tinbergen Institute Amsterdam

Keizersgracht 482
1017 EG Amsterdam
The Netherlands
Tel.: +31.(0)20.5513500
Fax: +31.(0)20.5513555

Tinbergen Institute Rotterdam

Burg. Oudlaan 50
3062 PA Rotterdam
The Netherlands
Tel.: +31.(0)10.4088900
Fax: +31.(0)10.4089031

Most TI discussion papers can be downloaded at
<http://www.tinbergen.nl>

A Dynamic Model of Commutes

Jan Rouwendal* en Arno J. van der Vlist**

* Wageningen University, Free University and Tinbergen Institute

** Free University

This version: January 25, 2002

Key words: commutes, duration analysis, competing risks models.

JEL codes: J61, R23

Abstract

This paper studies the interaction between job mobility and housing mobility by considering the duration of commutes. Conventional models assume that the employment location has priority over the residential location and that the latter is adapted to the former. This implies that the duration of commutes that start with a job change is often short, because of a related house change that follows soon. In the paper we distinguish commutes on the basis of the mobility types that started and ended their existence. The empirical analysis of this paper shows that both job mobility and housing mobility are often followed by repeat-mobility, but also by mobility of the other type. These empirical results refer to a sample of Dutch workers who reported changes on the housing and labor market between 1990 and 1998.

In order to capture these empirical findings in a formal model, we specify duration models that focus on the time during which employment-housing arrangements (hence, commutes) remain unchanged. We start with estimating univariate duration models for commutes and proceed to competing risks models. Estimation results for these models confirm that commutes that start with housing mobility and those that start with job mobility have similar characteristics with respect to induced future mobility. Moreover, we find that the commuting distance has a limited effect on job mobility, that there is no evidence for the existence of a critical commuting distance and that workers belonging to dual earner households are more mobile on both markets than others.

Acknowledgement

This work was partly financed by the Dutch Ministry Transportation (Adviesdienst Verkeer en Vervoer). Comments by Bas van der Klauw, Peter Kooreman and Maarten Lindeboom on an earlier version are gratefully acknowledged. The usual disclaimer applies.

Jan Rouwendal, Department of Spatial Economics, Free University, De Boelelaan 1105, 1081 HV Amsterdam, Netherlands, phone: 31-20-4446093, fax: 31-20-4446004, e-mail: jrouwendal@feweb.vu.nl
Arno van der Vlist, Department of Spatial Economics, Free University, De Boelelaan 1105, 1081 HV Amsterdam, Netherlands, phone: 31-20-4446090, fax: 31-20-4446004, e-mail: avlist@feweb.vu.nl

1 Introduction

The commuting distance is the result of work location and residential location. A change in either of the two will usually imply a change in the commuting distance. In the course of their life most people change job or house a number of times. Sometimes these changes are motivated, at least in part, by a desire to shorten the commute. Although changes in job location and residential location may coincide, usually one changes while the other remains unchanged. Even if, for instance, a change in residential location is motivated by a preceding change in job location, a time period of some months may elapse between the two moves. This suggests that the development of commutes over time should be considered as a process of sequential adjustments of housing and employment to changing needs and opportunities. This is the basic idea of the present paper.

The bulk of the relevant economic literature on commuting presupposes a much simpler mechanism that generates commuting distances. For instance, in the early versions of the monocentric model of an urban economy, all employment is located in the center of the city. Job changes will therefore never imply a change in work *location* and in commuting distance. Moreover, the workers have constant preferences and there is therefore no need to adapt the residential location in response to changes in family size or other socio-economic factors. Later versions of the model of the urban economy have relaxed many of the original assumptions. However, it is well known since the publication of Hamilton's (1982) article on wasteful commuting and the subsequent discussion in the literature (see Small and Song 1992 for a possibly definitive statement) that these models predict actual commuting patterns badly. The introduction of more realistic assumptions about the functioning of the labor market allows for an explanation of excess commuting in terms of optimizing behavior (cf. Rouwendal, 1998).

The focus of urban economics models is on the major characteristics of an urbanized area in a long run equilibrium or steady state. In contrast, recent literature has suggested that commuting behavior is influenced considerably by variables operating at the individual or household level such as the number of workers in a household, the presence of young children (see e.g. Rouwendal and Rietveld, 1994). Indeed, preferences with respect to housing, employment and commuting exhibit substantial heterogeneity (Rouwendal and Meijer, 2001). This suggests that it is important to gain more insight into the behavior of individual workers or households with respect to commuting (cf. Hanson and Pratt, 1988). Accordingly we study in this paper the behavior of individual workers with respect to commuting, without paying explicit attention to the mutual coordination of their decisions by the distribution of housing and employment over the urban area in which they live. This allows us to focus on the micro-aspects of changes in commutes and therefore to avoid the strong a priori hypothesis about the interaction between labor and housing markets that are often associated with a macro-approach.

The approach we use in this paper is based on the idea that workers are adapting their residential and work situations to changing circumstances. Since changing house or job is costly, small changes in circumstances will usually not lead to changes in either house or job. However, small changes may have cumulative effects, for instance when gradually obtained job experience improves the possibilities for a worker to move to a job that requires more human capital and offers higher earnings. On the other hand, there may also be substantial changes in circumstances, such as the threat of becoming unemployed,

that make it desirable to find another job. Similar remarks can be made for the desire to change house. A researcher is usually not informed about all the reasons an individual can have for changing residential or work location. It seems therefore attractive to construct a model in which the possibility that a change in residential or work location takes place is analyzed as a stochastic process. This means that our model should be concerned with the probability that an individual worker with a particular set of characteristics will change house or job in a specific period. The statistical models that analyze such processes are called duration models. Probably the best known of these is the proportional hazard model developed by Cox (1972) and made popular in the econometric literature by Lancaster (1979). In this paper we apply such models to analyze changes in the commute. Duration models have been applied repeatedly to analyze the duration of job spells and residential spells (see the literature review below). Since commutes change when either the job location or the residential location changes, it seems natural to use this approach for studying the dynamics of commutes as well. It may be expected that changes in residential and job location are influenced differently by variables such as being an owner-occupier or the wage rate. If one wishes to disentangle the effects of the explanatory variables on changes in the labor and housing market, one has to take into account explicitly that there are two possibilities for changing a commute, viz. a change in the residential and work location. Statistical models that are able to deal with such a situation are known as competing risks models (see Flinn and Heckman, 1982, for an early econometric application). We will apply such a model as well.

We proceed as follows. In section 2 an overview of some relevant literature is provided. It concludes with the observation that the relation between mobility on the labor and housing market is not well understood. In section 3 we discuss the duration models that we use later in the paper. Section 4 discusses the data. In section 5 we provide a preliminary non-parametric analysis of the hazard rates for ending a commute. We focus on the question whether commutes that start because of job mobility differ from those that start because of housing mobility in their effects on later mobility. According to traditional insights, job mobility would trigger housing mobility, but not the other way around. We find little support for this view. In order to give a more complete analysis in which the role of other explanatory variables such as worker characteristics can be studied, we estimate flexible parametric duration models. Results are presented in section 6 and 7. We pay some attention to the effect of the commuting distance on the hazard for ending a commute. Somewhat surprisingly, we only find a significant effect on job mobility. Moreover, we are unable to detect a threshold effect. Section 8 discusses the implications for the duration of commutes for workers with particular characteristics, such as belonging to a dual earner household. Section 9 concludes.

2 A review of related literature

There is a large literature on residential mobility and dynamic labor market analysis. We make no attempt to survey this literature as a whole, but concentrate on studies that consider the relation between both or that use duration analysis.

Residential mobility

Most studies that use duration analysis concentrate exclusively on either the labor or the housing market. The separation between the two branches of the literature is well illustrated by the fact that Ginsberg (1979a,b) introduced the statistical techniques of duration analysis in the study of residence histories at the same time when Lancaster (1979) did so for unemployment histories.

Ginsberg (1979) deals with heterogeneity by estimating separate models for various groups. He finds that, except for singles and people with high incomes, a constant hazard rate is not supported by the data. The duration effects for the other groups can be described by a Gompertz distribution. His study seems to have gone largely unnoticed. Henderson and Ioannides (1989) develop a model that explains tenure, length of stay as well as housing consumption simultaneously. They use lognormal distributions for the completed spells of renters and owners and estimated separate equations for both.¹ This study inspired that of Gronberg and Reed (1992), which concentrates on residential spells. It assumes constant hazard rates for renters and owners and find that increases in education, age, and being married all decrease the expected length of stay for both owners and renters. These studies hardly pay attention to linkages between labor market and housing market. Income is usually included as an explanatory variable, but other variables, such as the commuting distance or indicators of job mobility are absent. From other contributions to the literature on residential mobility, we know that residential mobility is related to stages in the life course of households, summarized by the age of the head, the size of the household and the amount of space in the dwelling (cf. Deurloo et al., 1987; Clark and Dieleman, 1996). Some recent contributions also include the commuting distance (Van Ommeren, 2000; Van der Vlist et al., 2002) or regional labor market factors (Henley, 1998) into the analysis of residential mobility.

Labor mobility

There have been numerous applications of duration analysis on labor market issues, most of them focusing on the duration of unemployment (see Devine and Kiefer, 1990), which is of less interest for the purposes of the present paper. There are only a few studies of the duration of employment in a particular job. One of these is Van den Berg (1992) who finds (among other things) that transition rates from one job to another increase with the home/work distance, and with education and decrease with age, whereas married workers have lower transition rates than others. He also estimates the cost associated with moving to another job and finds them to be higher for workers with a small commute and for those who expect it to be difficult to sell the present house or to rent another one after moving job. These findings point to important interactions between mobility on the housing and on the labor market and are supported by later work (cf. Van den Berg and Gorter, 1997; Van den Berg and Van Vuuren, 1998). A number of papers dealing with the estimation of equilibrium search models have also reported results on the duration of employment (see e.g. Van den Berg and Ridder, 1998).

Interaction between both types of mobility

The connection between housing tenure structure and labor mobility has been subject to a long standing interest from labor economists. Hughes and McCornick (1987) and

¹ It is well known that homeowners tend to be less mobile than renters.

Muellbauer and Murphy (1991) find that the owner-occupier housing market in the UK account for regional labor mismatches, a low level of labor mobility and other inefficiencies in the British labor market. Regional commuting then can help to overcome the imperfections on the housing market (see also Jackman and Savouri, 1992; Meen and Andrew, 1998; Cameron and Muellbauer, 1998; Whitehead, 1999). These studies focus on an aggregate level of analysis, and are therefore of less interest for the purposes of the present paper.

A number of micro-oriented studies that focus on the relation of the housing and the labor market take either employment fixed or study mobility on the housing market after a change in the job location has occurred.

Wachs et al (1993) study the development of the commuting pattern of some 30.000 employees of a Californian firm during the period 1984-1990. A major finding of this largely descriptive study is that work trip lengths had on average not grown. Since most of the people involved in the study did not change their work location² attention was focused on the determinants of residential relocations. The analysis by and large confirms the authors' hypothesis that the length of the commute is only of secondary importance in the choice of a residential location. They find that workers that commute over longer distances are more inclined to move than others, which suggests that long commutes induce workers to move closer to their workplace. However, they also find that those that move to an owner-occupied house tend on average to increase the length of their commute.

Van Leuvenstein and Koning (2000) use duration analysis to consider a number of hypotheses about the relation between labor market and housing markets. They find that employed workers are less likely to move to another house if they are owner-occupiers, but note also that the positive effect of job mobility on housing mobility is especially high for home owners. Unemployed homeowners and homeowners that do not have a job are more likely to move than renters. Homeowners are less likely to move to another job, but are also less likely to become unemployed or to end participation on the labor market. These results are obtained on the basis of estimating separate duration models for the housing and labor markets.

An attempt to take the simultaneity between durations on the housing and labor market explicitly into account is given by Van Ommeren, Rietveld and Nijkamp (1999). They present estimation results for a bivariate model for job-to-job and residential mobility and interpret the results from the viewpoint of a (conceptual) model of simultaneous search. A main result of the empirical analysis of this paper is that residential and labor mobility are unrelated if the effect of the commuting distance on both is taken into account. In their model there is no duration dependence (i.e. the probability of moving job or house is constant, conditional on the values of the explanatory variables). The correlation between

² Since the firm involved had various locations, some workers changed their job location without a change of employer.

the residential and job durations is found to be insignificant. This finding is somewhat surprising, and Van Ommeren et al. themselves seem to be somewhat skeptical about it.³ It is well known that changes in residence (jobs) are often followed by other changes in residences (jobs) due to, for instance a division of the population in groups with a high and a low propensity to move. Such heterogeneity introduces duration dependence, because people who have held the same residence (job) for a long period are more likely to belong to the 'stayers'. Clark and Withers (1999) have analyzed the effect of job mobility on residential mobility and find that the former often 'triggers' residential mobility. This effect is most pronounced for single renters. This suggests that it might be important to take into account the possibility that a change on the labor or housing market influences the propensity to move on the same or the other market immediately after the move. This can be done by incorporating the commuting distance as an explanatory variable for mobility on both markets, but this is not necessarily the only way in which the two markets are interrelated.

Zax (1991) concentrates on the effect of a specific 'shock' in the housing employment arrangement of households on their decisions with respect to job and residential locations. He studies the effects of a relocation of a firm from the CBD of Detroit to the suburbs on the residential and work locations of its workers by means of a bivariate probit model. As a consequence of the relocation, the commute of some workers decreased, whereas that of others increased. The 'losers' tended either to move house or to change their job, but the occurrence of one reaction diminished the probability of observing the other. Moves and quits should therefore be regarded as substitutes. Zax argues that the costs of mobility on either market, and the possibility to change the commute to any desired length by means of a single move explains this behavior.

Clark and Withers (2001) notice an apparent contradiction in the recent literature on commuting by Dutch authors:⁴

*'On the one hand they identify a correlation between residential and labor-market mobility and on the other they downplay the trigger effect of a job change'*⁵

In this paper we attempt to shed more light on this issue by analyzing the duration of commutes, while focusing explicitly on the interrelation between job changes and residence changes. We start our analysis by focusing on the effects of a move on the housing or labor market on the probability of subsequent moves on either market. We continue with estimating some flexible duration models that allow us to take into account the effect of explanatory variables such as the commuting distance and the correlation between the length of employment and housing spells after a change in either job or house.

³ They state that 'there might be a good reason why our model does not reject the independence hypothesis even when it does not hold. Statistical models do not predict very well residential or job mobility. The regressors [...] are poor approximations.' (Van Ommeren et al., 1999, p. 249).

⁴ They mention Van Ommeren et al. (1997, 1999), Rouwendal and Rietveld (1994) and Rouwendal (1999).

⁵ Clark and Withers (2001), p. 5

Throughout the paper we use a reduced form approach. This is in line with most of the literature discussed above. The development of a full-fledged structural model would (if possible at all) probably require us to introduce restrictive additional assumptions, which can now be avoided. The reduced form approach allows us to concentrate on the properties of the data.

3 Duration models

In this section we present the statistical models that will be used in the empirical analysis of the next section. We start with a brief general introduction of the models and continue with a more detailed discussion of two approaches to competing risks models.

Hazard rates

The time that a commute exists can be regarded as a random variable T . Its distribution depends on the characteristics z of the commuter, and we write it as $F(t|z)$. The vector z refers to characteristics of the household, the job, the house and the commute. The distribution function determines the probability that a commute will end in a particular time interval. It is common in econometric analysis to analyze the duration of phenomena by means of the hazard rate $\lambda(t|z)$, which is defined as:

$$\begin{aligned}\lambda(t|z) &= \lim_{\Delta \downarrow 0} \Pr(t < T < t + \Delta | T > t; z) \\ &= \frac{f(t|z)}{1 - F(t|z)},\end{aligned}\tag{1}$$

where $f(t|z)$ is the density function of T (i.e. $f(t|z) = dF(t|z)/dt$).⁶ For a small time interval the product $\lambda(t|z)\Delta$ is approximately the probability that the duration will end during Δ after t , conditional upon it not having ended earlier. If T is a discrete random variable, with its mass points referring to periods, the discrete hazard is defined as:

$$\lambda_i(T|z) = \frac{f_i(t|z)}{1 - \sum_{j \leq i} f_j(t|z)}.\tag{2}$$

In this equation i is an index for periods. In the next section we will make use of (2) in order to give an exploratory analysis of commuting spells. For a more in-depth analysis we will rely on the more advanced models that will be discussed below.

Generalized Accelerated Failure Time models

We can consider the length of a (commuting) spell t as a random variable, which may be analyzed by specifying a convenient distribution for it. For instance, we may assume:

$$\ln(t) = \varepsilon\tag{3}$$

with ε normal distributed. This implies that the length of a spell is lognormal distributed.

⁶ See e.g. Kiefer (1988) for a more elaborate discussion.

Explanatory variables may be introduced in this model by assuming that they accelerate or decelerate the failure time, i.e. by generalizing (3) to:

$$\ln(a(z)t) = \varepsilon \quad (4)$$

with $a(z)$ a function of the explanatory variables. It is conventional to assume $a(z)=\exp(-\beta z)$. After substitution in (4), this results in:

$$\ln(t) = \beta z + \varepsilon \quad (5)$$

This equation defines the so-called Accelerated Failure Time Model. Henderson and Ioannides (1989) used this model in their analysis of housing spells, with ε normal distributed.

A further generalization can be obtained by replacing time t in (5) by an increasing function of time. Denoting this function as $\Lambda(t)$, we arrive at:

$$\ln(\Lambda(t)) = \beta z + \varepsilon \quad (6)$$

This equation characterizes the class of Generalized Accelerated Failure Time (GAFT) models (see Ridder, 1990), to which most – if not all - duration models used in econometric analysis belong.

The probability that a duration ends between t_1 and t_2 can, according to the GAFT specification, be written as:

$$\begin{aligned} \Pr(t_1 < T < t_2) &= \Pr(\ln(\Lambda(t_1)) - \beta z < T < \ln(\Lambda(t_2)) - \beta z) \\ &= \int_{\ln(\Lambda(t_1)) - \beta z}^{\ln(\Lambda(t_2)) - \beta z} f(\varepsilon) d\varepsilon. \end{aligned} \quad (7)$$

where f is the density function of ε .

The model proposed by Han and Hausman

The function $\Lambda(t)$ can be related to the hazard rate in the following way. Without loss of generality, we can measure z in terms of deviations from a reference value z^* , for instance its mean. It can be shown that for the case in which $z=0$, $\Lambda(t)$ is equal to the integrated hazard rate. We denote this baseline hazard as $\lambda_0(t)=\lambda(t|0)$:

$$\Lambda(t) = \int_0^t \lambda_0(\tau) d\tau \quad (8)$$

Han and Hausman (1990) observe that in economic analysis the data often refer to discrete time periods in which spells and not to exact points in continuous time. They

argue that it is therefore not restrictive to interpret the baseline hazard as a step function.⁷ They define new variables δ_i that refer to the log of the integrated baseline hazard as follows:

$$\delta_i = \ln \left(\int_0^{t_i} \lambda_0(\tau) d\tau \right), \quad i = 1, 2, \dots, T \quad (9)$$

where the t_i 's are the endpoints of the time periods. From now on we will assume that these periods are of unit length, i.e. $t_i = i$, $i = 1, 2, \dots$.

Using this, the probability that a spell ends in period t can, on the basis of (7), be written as:

$$\Pr(t-1 < T < t) = \int_{\delta_{i-1} - \beta \varepsilon}^{\delta_i - \beta \varepsilon} f(\varepsilon) d\varepsilon. \quad (10)$$

The δ_i 's can be considered as parameters to be estimated jointly with the β 's. Han and Hausman propose the use of the normal distribution for f . The model can then be estimated as an ordered probit model. This provides a flexible and convenient specification for a duration model, which will be used in the empirical work reported below.

Generalization to competing risks models

In the context of the present paper, we have to deal with two hazard rates, one referring to job changes, the other to changes in the residential location. In the presence of two possibilities for ending the duration of a commute, one can distinguish T_1 , the time until a change in job location takes place, from T_2 , the time until a change in the residential location takes place. The minimum of the realizations of these two determines the observed duration of a commute. This is the bivariate competing risks model.

We should allow for the possibility that the random variables T_i are dependent and denote their joint distribution function as $F(t_1, t_2 | z)$ and the associated density as $f(t_1, t_2 | z)$. Only the minimum u of t_1 and t_2 is observed by the researcher. The hazard $\lambda(u | z)$ can be written as the sum of two conditional hazards (see the appendix):

$$\lambda(u | z) = \lambda_1 * (u | z, T_2 > u) + \lambda_2 * (u | z, T_1 > u) \quad (11)$$

If time is measured as a discrete variable, a discretized version of (11), which is analogous to (2), should be used.

We conclude this section with a brief description of the generalization of the univariate model of Han and Hausman described above to the competing risks case. We use suffixes for the two risks, 1 refers to residential mobility, 2 for job mobility. This is easily done if the two risks are independent. If there are two independent competing risks, both can be

⁷ See Ridder (1990) for a discussion of identification of the model in situations in which only the time periods in which durations end are observed.

modeled in the way described above. For instance, the probability that a commute ends in period i because of a change in residence is equal to:

$$\Pr(t-1 < T_1 < t, T_2 > T_1 | z) = \int_{\delta_{1,t-1}-\beta_1 z}^{\delta_{1,t}-\beta_1 z} \int_{m_2(\varepsilon_1)}^{\infty} f(\varepsilon_1) f(\varepsilon_2) d\varepsilon_2 d\varepsilon_1 \quad (12)$$

where $m(\varepsilon_1)$ is the lower bound for the integration over ε_2 which should coincide with $t_1=t_2$. The determination of the value of $m(\varepsilon_1)$ is discussed in the appendix. The equation for the case in which the commute ends because of a change in workplace is similar. The generalization to dependent competing risks that is suggested by equation (12) is to substitute a bivariate normal density function for the product of the two univariate normal density functions. This is exactly what Han and Hausman (1990) (see also Sueyoshi, 1992) have done to formulate a flexible and relatively easy-to-handle parametric specification of a competing risks model. Equation (12) then becomes:

$$\Pr(t-1 < T_1 < t, T_2 > T_1 | z) = \int_{-\delta_{1,t-1}-\beta_1 z}^{-\delta_{1,t}-\beta_1 z} \int_{m_2(\varepsilon_1)}^{\infty} f(\varepsilon_1, \varepsilon_2) d\varepsilon_2 d\varepsilon_1 \quad (13)$$

where f now denotes the bivariate normal density function. The correlation coefficient ρ can be estimated jointly with the β 's and δ 's.

4 Data

The data we use in the empirical analysis have been collected in 1998 in order to document and better understand the changes in commutes, and possible interrelations between the commuting, residential relocation and job relocation decisions of households (see MuConsult, 1999). The 456 respondents of this survey were a subset of the respondents of the 1995 Dutch Time Use Survey (in Dutch: TijdsBestedings-Onderzoek, abbreviated as TBO) (CBS, 1995) who had indicated to be willing to be involved in further surveys. When these respondents were again contacted in 1998, a short preliminary questionnaire was used in order to find out which respondents had experienced at least one change on either the labor or housing market. Since the survey was focused on changes in commutes, respondents who had realized at least one move on either the labor or the housing market were deliberately over-represented in the survey. It also turned out that the potential respondents who had moved between 1995 and 1998 (i.e. who could not be contacted in 1998 on their 1995 address) were underrepresented in the survey because it was in some cases impossible to figure out their new address. We corrected for the effects of these two types of selectivity in our database by constructing weights.⁸

In the survey, individuals were asked to report in which month changes took place, and whether the change was a residential or a job relocation. This information enables us to

⁸ The relative probability of being incorporated in the sample was .38 for those who moved house between 1995 and 1998 and .25 for those who did not move at all between 1990 and 1998. The weights are the inverses of the relative probabilities. The weights were scaled in order to keep the number of weighted observations equal to the number of unweighted observation (456).

Table 1 Changes on the housing and labor markets per year

Year	Housing market		Labor market	
		Job to Job	Jobless to Job	Job to Jobless
1990	41	35	2	5
1991	42	30	1	3
1992	52	35	3	2
1993	48	30	5	3
1994	43	36	3	11
1995	45	33	3	6
1996	39	43	6	9
1997	45	47	2	2
1998	24	28	2	1
Average per year	44.7	38.4	3.4	4.6

Computations based on weighted observations. The figures for 1998 refer to approximately half a year (the survey was conducted during the summer). Computation of the averages used the 1998 figures multiplied by 2.

construct the number of transitions, and the associated spells in labor, housing and commuting states for the complete 1990-1998 period.

We start with some descriptive information. Table 1 gives the number of moves on the housing and labor market in the years 1990-1998.

Table 2 provides information about the numbers of housing, job and commuting spells. Most of the spells that are incompletely observed because their start, completion or both are outside the observation period 1990-1998. In the analysis that follows we concentrate on the spells that start in the observation period, i.e. on spells that are either completely observed or right-censored. Commuting spells are time intervals between moves on either the housing or the labor market. They are therefore on average shorter than either housing or job spells. However, from the third panel of Table 2, we observe that the average completely observed commuting spell is just a little bit shorter than the analogous job spell. A similar phenomenon can be observed for right censored spells, whereas for left-censored commuting spells we the difference with the analogous housing spell is small. Note also that the total number of (partially) observed commuting spells, 1074, is substantially less than the sum of the total number of housing en employment spells (835 and 721, respectively).

5 Are job mobility and housing mobility related?

In this section we take a first look at the relation between mobility on the housing market and mobility on the labor market by computing a number of hazard rates from our data. Figure 1 presents the hazard rates for all observations. The hazard rate in year t is equal to the ratio between the number of commuting spells that have been completed in the t -th year of their existence and the number of observed commutes started after 1989 that have lasted at least $t-1$ years. Left censored commuting spells therefore do not play a role in these computations. Right censored spells are contained in the denominator. This computation follows (2).

Table 2 Observed housing, job and commuting spells

Housing spells

Length (years)	Started after 1989 Completed	Started after 1989 Uncompleted	Started before 1990 Completed	Started before 1990 Uncompleted
0-1	35	37	56	-
1-2	25	40	34	-
2-3	23	32	36	-
3-4	27	24	25	-
4-5	19	28	21	-
5-6	9	21	22	-
6-7	5	19	17	-
7-8	3	19	21	-
8-9	0	15	5	221
Total	146	233	235	221
average length of observed spell	2.68	3.75	3.29	8.50

Job spells

Length (years)	Started after 1989 Completed	Started after 1989 Uncompleted	Started before 1990 Completed	Started before 1990 Uncompleted
0-1	67	48	32	-
1-2	37	38	23	-
2-3	24	27	25	-
3-4	20	13	19	-
4-5	6	15	18	-
5-6	8	11	11	-
6-7	5	10	13	-
7-8	1	8	17	-
8-9	0	13	13	201
Total	168	182	170	201
average length of observed spell	1.98	3.12	3.75	8.50

Commuting spells

Length (years)	Started after 1989 Completed	Started after 1989 Uncompleted	Started before 1990 Completed	Started before 1990 Uncompleted
0-1	181	68	76	-
1-2	94	57	42	-
2-3	65	46	33	-
3-4	43	22	26	-
4-5	24	22	22	-
5-6	11	17	12	-
6-7	13	11	20	-
7-8	2	11	16	-
8-9	2	15	8	116
Total	435	268	255	116
average length of observed spell	1.90	2.91	2.98	8.50

Legend All figures are based on weighted observations.

Figure 1 here

Figure 1 shows that the hazard decreases over time. The probability that a commuting spell ends in year t , given that it is still in existence at the end of period $t-1$ is therefore decreasing in t . Commutes that are ‘young’ have a relatively high probability of being completed, whereas for commutes that are ‘old’ this probability is low. This development of the hazard rate over time may be caused by heterogeneity in the population, related for instance to the existence of groups with high and low probabilities for ending a commuting spell. Another possibility is that the move that starts a commute often triggers a next move. We noted earlier that Clark and Withers observe that job mobility gives rise to increased residential mobility. However, it should be clear that this is not the only possible explanation of the pattern shown in Figure 1. Repeat-mobility may also occur on the market where the first move took place.

If the job location has primacy over the residential location as is often supposed in the literature, one would expect that commutes that started with job mobility to be often soon completed because of an adjusting move on the housing market. On the other hand, commutes that started with a move on the housing market should not be expected to give rise to further mobility on either the labor or the housing market. In order to see whether this view is correct, we have split our population of commutes into those that started by a move on the housing market and those that started with a move on the labor market. This resulted in Figure 2. The most important feature of this figure is that the two curves are so close to each other. It appears that there is little difference between the repeat-mobility caused by moves on the housing and labor market. During the first years commutes that started with labor mobility seem to give rise to more mobility than those that started with housing mobility, but the difference seems to be too small to interpret the figure as a confirmation of the conventional view discussed above.

Figure 2 here

In order to analyze this issue still further, we have computed different (conditional) hazard rates for completing a commuting spell by either job mobility or residential mobility. Figure 3 gives the two hazard rates for commutes that started with residential mobility. The most salient aspect of the figure is that residential mobility is often followed by renewed changes on both the housing and the labor market. It might of course be the case that some of the residential moves are made in anticipation of a job change. However, it seems unlikely that this explanation, which defends the primacy of the work location, is able to account completely for the high hazard for job mobility in the first year.

Figure 3 here

Figure 4 shows the two hazard rates for commutes that started with job mobility. A striking aspect of the picture is that it shows that a change in employment is often followed by another change in employment. The hazard rate for residential mobility is

much lower than that for job mobility in the first year of the commute's existence. The decrease in job mobility over time is also much more pronounced than that in residential mobility.

Figure 4 here

Figure 4 confirms the finding of Clark and Withers (1999) that job mobility triggers residential mobility. Figure 3 shows that there is a comparable effect of residential on job mobility that is, at least in the first two years, of the same order of magnitude. Both figures suggest that a move one market gives rise to an increase in the hazard of moving on the other market. These relations are hard to measure with a bivariate duration model as used in Van Ommeren et al. (1999). If it is assumed in such a model that the hazard rates are constant, they will certainly not be measured. Even if the (baseline) hazard rate would be allowed to change over time, this is usually done by relating it to the 'own' elapsed duration. The pictures just presented strongly suggest that it should also be related to the elapsed duration in the other market. If these dynamic effects are not correctly incorporated, the model seems to be misspecified, and the coefficients estimated for the other variables, such as the commuting distance and the correlation between the two spells might be biased. In order to avoid these problems, the duration models that will be used in the next sections concentrate on the length of commuting spells, i.e. on the time during which a particular housing-employment arrangement remains unchanged.

6 Estimation results of the single risk model

In order to make inferences into the importance of explanatory variables such as the commuting distance for ending commutes, we now proceed to a more formal analysis. We do so first by estimating the single risk model proposed by Han and Hausman (1990) that has been discussed in section 3. The model allows us to estimate the parameters of a flexible baseline hazard, as well as of the influence of a number of explanatory variables. The model is estimated on the completely observed and right censored commuting spells for respondents who provided the necessary information for all the explanatory variables. These two requirements reduced the number of (unweighted) observations that we could use to 453. Incomplete spells less than one year must also be deleted, and this reduces the

Table 3 Descriptive statistics

Variable	Mean
Commuting distance (km, one-way)	20.5
Man	0.54
Age (in years)	35.4
Owner-occupier	0.57
Net wage rate (Dfl/hour)	23.23
Working hours (per week)	31.2
Dual earner	0.17

number of observation further to 398.⁹ Table 3 gives descriptive statistics for the explanatory variables that we use.

Table 4 presents estimation results for two versions of the model. Model I (columns 2 and 3) is a basic version, model II (columns 4 and 5) shows the results of adding two additional variables. In the basic version of the model there is no significant influence of the commuting distance on the propensity to end a commute by either moving house or job. The figures in the table show that commuting spells tend to become longer if the commuter is a man, is older, is owner-occupier or has a higher net wage rate. Commuting spells tend to be shorter if the commuter works longer hours per week, or belongs to a dual earner household. The latter results are somewhat surprising. It is often thought that workers belonging to dual earner households have more difficulty in adjusting their residential location to the needs of both workers. The same reasoning would probably lead one to expect that these workers tend to become less mobile as soon as a satisfactory match has been found. The higher mobility of workers belonging to dual earner households might indicate the difficulties they have in finding a more or less permanent employment/housing arrangement. However, it might on the other hand be interpreted as indicating that the workers belonging to this group are more mobile on the labor and/or housing market¹⁰ and, for this reason, can more easily adapt to changing circumstance than others.

The second model introduces two additional variables: a dummy for the origin of the commute, and the squared commuting distance. These will now be discussed.

The figures presented in the previous subsection suggest that commutes that started because of residential mobility do not have different hazard rates than those that started with job mobility. This is confirmed by the highly insignificant coefficient for the dummy indicating this characteristic, which was introduced as an additional variable in model II (see Table 4).

A second variable specific to model II is the squared commuting distance. This variable was added in order to find out if there are non-linear effects present. It has, for instance, been suggested by Getis (1969) that commuters are indifferent with respect to the length of their commute, as long as it is below a certain threshold level. If the threshold is exceeded, longer commutes provide an incentive to change either work or housing location (see also Clark and Withers (2001) for recent research using this hypothesis). If there were indeed such a critical commuting distance, we would expect to find a significant coefficient for the squared commuting distance in model II. In fact we find a negative and insignificant coefficient (see Table 4).¹¹ Threshold effects thus seem to be absent in our data.

One possible explanation of these results is that long commutes are not necessarily a disequilibrium phenomenon. It is probable that workers are willing to trade off various

⁹ The likelihood that a commute exists for less than a year is equal to 1 and these observations therefore do not contain information that can be used for estimating the model.

¹⁰ For instance, because they are less firmly rooted in the residential community if the two earners work full time, or because they can take risky steps on the labor market somewhat easier because if one earner loses his or her job, the other still has it and the associated income loss is relatively small (note that the Netherlands have a relatively well developed system of social security).

¹¹ Introduction of the squared commuting distance as an explanatory variable results in much higher standard errors for the coefficients of the baseline hazard.

Table 4 Estimation results for the single-risk model

Coëfficiënt	Variable	Model I		Model II	
		Estimate	St. error	Estimate	St. error
β_1	Commuting distance (x 10 km)	0.0399	0.031	0.0989	0.072
β_2	„ squared			-0.000506	0.00061
β_3	Man	-0.403	0.17	-0.403	0.17
β_4	Age	-0.119	0.11	-0.131	0.10
β_5	Owner-occupier	-0.500	0.15	-0.511	0.15
β_6	Net wage rate (Dutch guilders/hr)	-0.234	0.037	-0.241	0.037
β_7	Hours per week (/40)	1.00	0.38	0.970	0.38
β_8	Dual earners	1.03	0.20	1.00	0.20
β_9	Started by residential mobility			-0.0329	0.14
δ_1		- .755	0.15	-2.97	2.7
δ_2		- .259	0.15	-2.47	2.7
δ_3	Log of integrated	.189	0.16	-2.02	2.7
δ_4	baseline hazard	.500	0.18	-1.71	2.7
δ_5		.814	0.19	-1.40	2.7
δ_6		1.04	0.23	-1.17	2.7
δ_7		1.48	0.28	-0.74	2.7
Loglikelihood		-395.26		-394.62	
N	398				

aspects of their housing-employment arrangements and long commuting distances may therefore be acceptable if compensation can be found by means of, for instance, a nice residential environment or less expensive housing of good quality. Since shorter commuting distances may be associated with other unsatisfactory aspects of employment-housing arrangement, there is a priori little reason to assume that commuting spells will tend to be shorter if the commuting distance is long.

7 Estimation results of the competing risks model

We continued our empirical analysis by estimating the competing risks models suggested by Han and Hausman (see (12) and (13)).¹² As we noted in the previous section, this model provides a flexible and relatively easy-to-handle way of dealing with the competing risks for ending a commuting spell: residential and job mobility. We started with a model in which the two risks were assumed to be independent, and used the same explanatory variables as in the single risk model. Estimation results are presented in table 5. We also estimated the model in which the two risks were allowed to be correlated. However, the correlation coefficient was insignificant (standard error approximately .6)

¹² Some details about the way we handled the model can be found in the appendix.

Table 5 Estimation results for the competing risks model

Coëfficiënt	Variable	Estimate	St err.
<i>Residential mobility</i>			
β_{11}	Commuting distance (x10 km)	-0.0136	0.055
β_{13}	Man	-0.285	0.22
β_{14}	Age	-0.242	0.13
β_{15}	Owner-occupier	-0.541	0.23
β_{16}	Net wage rate	-0.419	0.13
β_{17}	Hours per week (/40)	1.49	0.65
β_{18}	Dual earners	1.47	0.27
δ_{11}		-1.32	0.24
δ_{12}		-0.92	0.23
δ_{13}	Log of integrated	-0.41	0.24
δ_{14}	baseline hazard	-0.0037	0.27
δ_{15}		0.32	0.30
δ_{16}		0.55	0.36
δ_{17}		0.74	0.39
<i>Job mobility</i>			
β_{21}	Commuting distance	0.0761	0.035
β_{23}	Man	-0.841	0.21
β_{24}	Age	-0.233	0.15
β_{25}	Owner-occupier	-0.440	0.20
β_{26}	Net wage rate	-0.158	0.046
β_{27}	Hours per week	1.03	0.44
β_{28}	Dual earners	1.35	0.28
δ_{21}		-0.861	0.20
δ_{22}		-0.251	0.21
δ_{23}	Log of integrated	0.131	0.23
δ_{24}	baseline hazard	0.309	0.24
δ_{25}		0.573	0.26
δ_{26}		0.742	0.27
δ_{27}		1.20	0.37
Loglikelihood		-435.59	
N	398		

and the loglikelihood remained virtually unchanged. We therefore only present the results of the model with uncorrelated risks.

In the competing risks model we find that the commuting distance has a significant effect on the length of commuting spells, but only because it increases the probability of job mobility. Men are less mobile on the labor market. Age, does not have a significant negative effect on either type of mobility. Owner-occupiers and those with a higher wage are less mobile on both the labor and housing market. Part time workers end a commuting spell less often than others. Workers belonging to dual earner households are more mobile both on the labor and housing market.

We have also experimented with other specifications. The squared commuting distance was used as an explanatory variable. This resulted in a negative coefficient for job mobility and a positive one for residential mobility, but both were very small and statistically insignificant. Dummies for commuting spells that start with residential mobility also gave rise to insignificant coefficients. These results therefore confirmed those of the single risk model.

8 Implied hazard rates for commutes

The competing risks model offers a framework for a more detailed analysis of the processes that determine the length of the commuting spells. However, it is less readily interpretable in terms of the hazards for ending a commute. For this reason we pay some attention to the hazard rates implied by this model.

It is relatively easy to compute the (unconditional) hazards for ending the commutes by a change on the housing market or on the labor market. These unconditional hazards can be interpreted as referring to the situation in which there were only one risk.

The probability $f_{i,t}$ that a commute ends in its t -th year of existence because of risk i for a worker with characteristics z is equal to:

$$f_{i,t} = \int_{\delta_{i,t-1} + \beta_i z}^{\delta_{i,t} + \beta_i z} f(\varepsilon) d\varepsilon, \quad (14)$$

where f denotes the standard normal distribution. The implied hazard is:

$$h_{i,t} = \frac{f_{i,t}}{1 - \sum_{\tau < t} f_{i,\tau}}. \quad (15)$$

In order to compute the hazard h_t , that a commute ends in the t -th year of its existence, we first compute the probability f_t that it will end in its t -th year. This is the probability that the minimum U of the two durations lies between $t-1$ and t :

$$\begin{aligned}
\Pr(t-1 < U < t | z) &= \int_{-\delta_{1,\tau-1}-\beta_1 z}^{-\delta_{1,\tau}-\beta_1 z} \int_{m_2(\varepsilon_1)}^{\infty} f(\varepsilon_1, \varepsilon_2) d\varepsilon_2 d\varepsilon_1 + \\
&\quad \int_{-\delta_{2,\tau-1}-\beta_1 z}^{-\delta_{2,\tau}-\beta_1 z} \int_{m_1(\varepsilon_1)}^{\infty} f(\varepsilon_1, \varepsilon_2) d\varepsilon_1 d\varepsilon_2 \\
&= \int_{-\delta_{1,\tau-1}-\beta_1 z}^{-\delta_{1,\tau}-\beta_1 z} \int_{-\delta_{2,\tau-1}-\beta_1 z}^{\infty} f(\varepsilon_1, \varepsilon_2) d\varepsilon_2 d\varepsilon_1 + \\
&\quad \int_{-\delta_{2,\tau-1}-\beta_1 z}^{-\delta_{2,\tau}-\beta_1 z} \int_{-\delta_{1,\tau-1}-\beta_1 z}^{\infty} f(\varepsilon_1, \varepsilon_2) d\varepsilon_1 d\varepsilon_2 - \\
&\quad \int_{-\delta_{1,\tau-1}-\beta_1 z}^{-\delta_{1,\tau}-\beta_1 z} \int_{-\delta_{2,\tau-1}-\beta_1 z}^{-\delta_{2,\tau}-\beta_1 z} f(\varepsilon_1, \varepsilon_2) d\varepsilon_1 d\varepsilon_2 \\
&= f_{1t} \Pr(T_2 > t-1) + f_{2t} \Pr(T_1 > t-1) - \\
&\quad \Pr(t-1 < T_1 < t, t-1 < T_2 < t)
\end{aligned} \tag{16}$$

In order to interpret this derivation, consider Figure 5. The integral determines the probability mass above the shaded area in this figure. The first right-hand-side of (16) splits this area into two parts: one above CD and the other to the right of CD . The second right hand side gives the same area as the sum of the part above CD and the part to the right of AC , minus the square $ABCD$ (in order to correct for the double counting). The third right hand side rewrites the second so as to relate it to the unconditional probabilities derived earlier.¹³ This third line shows that the probability that a commute will end in the t -th year of its existence is smaller than the sum of the probabilities f_{it} that the commute would end by either of the two risks if the other were not existing. This is intuitively appealing.

The probability derived in (16) may be denoted as a total probability of ending the commute, f_t . It can be used to compute a total hazard h_t in the same way as was done for the unconditional hazards for housing and job mobility in (15).

In order to illustrate this, we have computed the two unconditional hazards as well as the conditional hazards for four particular cases:

- a full time working male single earner (case 1)
- a full time working male dual earner (case 2)
- a part time working female dual earner (case 3)
- a full time working female dual earner (case 4).

With respect to the values of the explanatory variables we assumed that each of these workers has the average commuting distance, age and net wage rate and owns the house. For cases 1 and 2 the dummy for man is equal to 1, for the others to 0. For cases 1,2 and 4 the number of working hours is equal to 40, for case 3 to 20. The dummy for dual earners is in case 1 equal to 0, in the other three cases to 1. Results of the computation hazard rates using the coefficients estimated for the competing risks model are shown in Figures 6-9.

¹³ The transition from the second to the third right-hand-side uses the independence of the two risks.

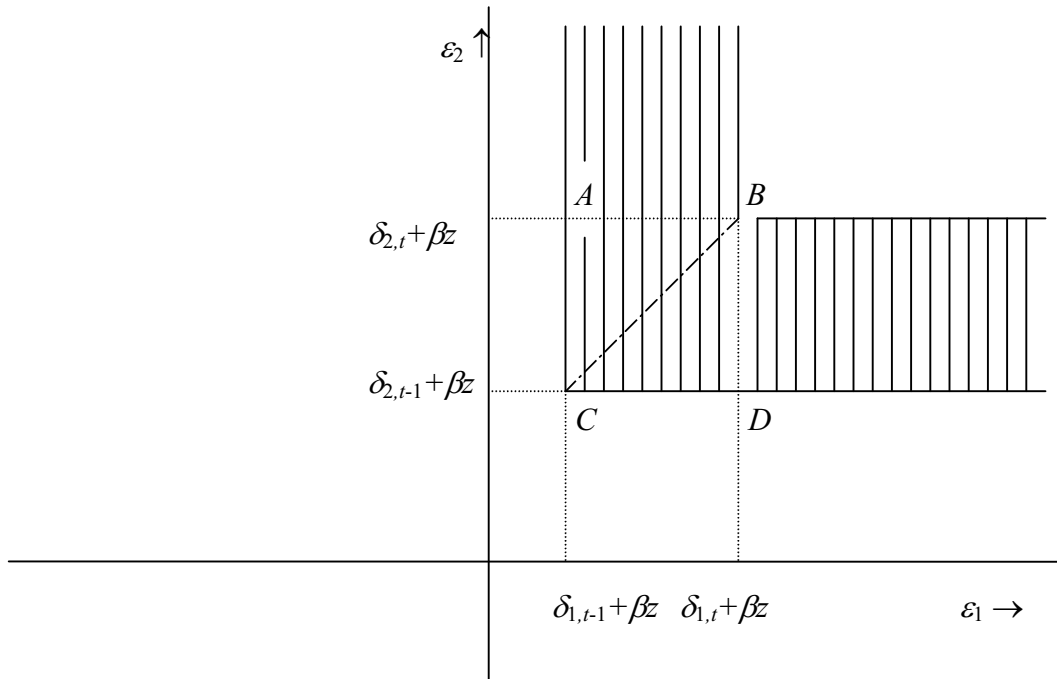

Figure 5 Determination of the probability of ending a commute by competing risks

Figures 6-9 here

Perhaps the most remarkable thing about these figures is that they are so different. For single male earners hazard rates for job and house mobility are both very low immediately after the start of a commute (i.e. a change in the employment-housing arrangement), but they rise gradually in later years. Figures 7 and 8 show that the hazard remains almost constant over time for the male and part time working female dual earners. This is the result of job mobility that tends to decrease somewhat over time, and housing mobility that tends to increase. Finally, for the full time working female dual earner we find a hazard rate that decreases over time, due in large part to decreasing job mobility. The Figures illustrate the flexibility of the model and suggest that various groups of workers are markedly different with respect to their propensity to change either housing or employment.

However, some caveats are in order. The first is that our results are based on a sample of limited size, in which the interesting group of dual earners is a minority. The second is that the Han and Hausman competing risks model does not allow for complete flexibility with respect to the time variation of the hazard rates. The limits of the integrals that are used in the computation of the probabilities that a hazard rate will be ended in a particular period because of risk i all change with the same amount $\beta_i \Delta z$ if we shift attention from one type of individual to another. A more flexible structure would allow these boundaries

to shift differently.¹⁴ However, our results suggest that the popular proportional hazard framework imposes potentially important restrictions on the specification of duration models.

8 Conclusion

In this paper we analyzed commuting spells. Since such spells can end by either residential or job mobility, the relationship between both had to be taken into account. The analysis started with a simple computation of the hazard rates. The resulting pictures strongly suggest that ending a commuting spell is followed by an increase in the propensity to move both on the housing and the labor market. The increase occurs for commuting spells that started with job mobility as well as for those that started with residential mobility.

We thus find that the two types of mobility are closely connected in the sense that observing one type of mobility makes it more likely to observe the other as well. One possible explanation is that long commutes have a small possibility of being observed for a long period. Long commutes might only be acceptable temporarily and for that reason tend to have shorter spells. The traditional view according to which households adapt their residential location to the work location implies increased housing mobility after job mobility. However, it is less able to explain the increased job mobility that occurs after housing mobility.

In order to take these interdependencies into account in a formal analysis, we choose to focus on the duration of commutes (housing-employment arrangements), instead of employment and housing spells. This allows us to model the increased mobility after a change in the commute easier than alternative model specifications would do. Moreover, the Han and Hausman model that we apply allows for flexible modeling of the baseline hazard and has a convenient extension to the competing risks case. The latter allows us to distinguish the two risks of ending a commute explicitly.

We found only limited evidence for an effect of the length of the home-work distance on the length of the commuting spell. Long commuting distances increase the propensity to change job, but not that to change house. Closer investigation learned that our data do not support the hypothesis that home-work distances are unimportant when below a threshold level, but important once it is exceeded.

There were no significant differences between commutes started by residential mobility and job mobility with respect to the additional mobility they generate. Workers belonging to dual earner households appear to be much more mobile than others. More generally, workers with different characteristics can be substantially different in their mobility on housing and labor market.

Since the sample on which our results are based is of limited size, further research is needed to confirm (or reject) these conclusions. We hope this paper can act as a stimulus to such research.

¹⁴ This can be done in the context of the Han-Hausman model by making the parameters $\delta_{i,t}$ functions of z . We felt implementation of this extension not worthwhile, given the limited number of observations that could be used.

References

- Cameron, G. and J. Muellbauer (1998) The Housing Market and Regional Commuting and Migration Choices Scottish Journal of Political Economy **45** 420-466.
- Clark, W.A.V. and S.D. Withers (1999) Changing Jobs and Changing Houses: Mobility Outcomes of Employment Transitions Journal of Regional Science **39** 653-673.
- (2001) Does Commuting Distance Matter? Commuting Tolerance and Residential Change, working paper, forthcoming in Regional Science and Urban Economics.
- Clark, W.A.V. and F. Dieleman (1996) Households and Housing: Choices and Outcomes in the Housing Market. Center for Urban Policy Research, New Jersey.
- Cox, D.R. (1972) Regression Models and Life-Tables Journal of the Royal Statistical Society **B26** 186-220.
- Deurloo, M., F. Dieleman and W.A.V. Clark (1987) Tenure Choice in the Dutch Housing Market. Environment and Planning A **19**: 763-781.
- Devine and Kiefer (1991) Empirical Labor Economics: The Search Approach Oxford University Press, Oxford.
- Flinn, C.J. and J.J. Heckman (1982) Models for the Analysis of Labor Force Dynamics, in: R. Bassmann and G. Rhodes (eds.) Advances in Econometrics **1** JAI Press, Greenwich.
- Getis, A. (1969) Residential Location and the Journey to Work Proceedings of the Association of American Geographers **1** 55-59.
- Ginsberg, R.B. (1979a) Timing and Duration Effects in Residence Histories and other Longitudinal Data; I Stochastic and Statistical Models Regional Science and Urban Economics **9** 311-331.
- (1979b) Timing and Duration Effects in Residence Histories and other Longitudinal Data; II Studies of Duration Effects in Norway, 1965-1971 Regional Science and Urban Economics **9** 369-392.
- Gouriéroux, C. and A. Montfort (1996) Simulation-Based Econometric Methods Oxford University Press, Oxford.
- Gronberg, T.J. and W.R. Reed (1992) Estimation of Duration Models Using the Annual Housing Survey, Journal of Urban Economics **31** 311-324.
- Han, A. and J.A. Hausman (1990) Flexible Parametric Estimation of Duration and Competing Risks Models Journal of Applied Econometrics **5** 1-28.
- Hanson, S. and G. Pratt (1988) Reconceptualizing the Links Between Home and Work in Urban Geography Economic Geography **64** 299-321.
- Henderson, J.V. and Y.M. Ioannides (1989) Dynamic Aspects of Consumer Decisions in Housing markets Journal of Urban Economics **26** 212-230.
- Henley, A. (1998) Residential Mobility, Housing Equity and the Labour Market. Economic Journal, **108**: 414-427.
- Hughes G.A. and B. McCornick (1987) Housing Markets, Unemployment and Labor Market Flexibility in the UK. European Economic Review **31**: 615-641.
- Jackman, R. and S. Savouri (1992) Regional Migration versus Regional Commuting: The Identification of Housing and Employment Flows. Scottish Journal of Political Economy **39**, 272-287.
- Kiefer, N.M. (1988) Economic Duration Data and Hazard Functions Journal of Economic Literature **26** 646-679.

- Lancaster, T. (1979) Econometric Methods for the Duration of Unemployment Econometrica **47** 939-956.
- Leuvenstein, M. van, and P. Koning (2000) The Effects of Home-Ownership on Labour Mobility in the Netherlands: Oswald's Theses Revisited, research memorandum, Netherlands Bureau for Economic Policy Analysis, The Hague.
- Manski, C.F. and S. R. Lerman (1977) The Estimation of Choice Probabilities from Choice-Based Samples Econometrica **45** 1977-1988.
- Meen, G. and M. Andrew (1998) On the Aggregate Housing Market Implications of Labour Market Change. Scottish Journal of Political Economy, 45: 393-419.
- MuConsult (1999) Afstemming Wonen en Werken: Analyse van Verhuisgedrag, final report (in Dutch).
- Pudney, S. (1989) Modelling Individual Choice Basil Blackwell, Oxford.
- Ridder, G. (1990) The Non-Parametric Identification of Generalized Accelerated Failure-Time Models, Review of Economic Studies **57** 167-182.
- Rouwendaal, J. (1998) Search Theory, Spatial, Labor Markets and Commuting, Journal of Urban Economics
- (1999) Spatial Job Search and Commuting Distances Regional Science and Urban Economics **29** 491-517.
 - and E. Meijer (2001) Preferences for Housing, Employment and Commuting: A Mixed Logit Model Journal of Regional Science, forthcoming.
 - and P. Rietveld (1994) Changes in Commuting Distances of Dutch Households Urban Studies **31** 1545-1557.
- Stern, S. (1997) Simulation-Based Estimation Journal of Economic Literature **35** 2006-2039.
- Sueyoshi, G.T. (1992) Semiparametric Proportional Hazards Estimation of Competing Risks Models with Time-varying Covariates Journal of Econometrics **51** 25-58.
- Van den Berg, G.J. (1992) A Structural Dynamic Analysis of Job Turnover and the Costs Associated with Moving to Another Job Economic Journal **102** 1116-1133.
- Van den Berg, G.J. and C. Gorter (1997) Job Search and Commuting Time. Journal of Business & Economic Statistics, 15: 269-281.
- Van den Berg, G.J. and A.P. van Vuuren (1998) Job Search and Non-Monetary Costs of Moving of Moving to a New Residence. mimeo.
- Van der Vlist, A.J., C.Gorter, P. Nijkamp and P. Rietveld (2002) Residential Mobility and Local Housing Market Differences. Discussion Paper 02/003. Tinbergen Institute Amsterdam.
- Van Ommeren, J. N. (2000) Commuting and Relocation of Jobs and Residences. Ashgate
- Van Ommeren, J.N., P. Rietveld and P. Nijkamp (1997) Commuting: In Search of Jobs and Residences Journal of Urban Economics **42** 402-421.
- , - and - (1999) Job Moving, Residential Moving and Commuting: A Search Perspective Journal of Urban Economics **46** 230-253.
- Wachs, M., B. D. Taylor, N. Levine en P. Ong (1993) The Changing Commute: A Case-Study of the Jobs-Housing Relationship over Time Urban Studies **30** 1711-1729.
- Zax, J.S. (1991) The Substitution between Moves and Quits. Economic Journal, 101:1510-1521.

Appendix

A1 The hazard of the minimum of both durations

We take the simultaneous density function $f(t_1, t_2 | z)$ as our starting point and define the distribution function of $U = \min(T_1, T_2)$ as:

$$F(u) = \int_0^u \int_u^\infty f(t_1, t_2 | z) dt_1 dt_2 + \int_u^\infty \int_0^u f(t_1, t_2 | z) dt_1 dt_2 + \int_0^u \int_0^u f(t_1, t_2 | z) dt_1 dt_2.$$

It follows that:

$$f(u) = \frac{\partial F}{\partial u} = \int_u^\infty f(u, t_2 | z) dt_2 + \int_u^\infty f(t_1, u | z) dt_1$$

and, applying the definition of a hazard :

$$\theta(u) = \frac{\int_u^\infty f(u, t_2 | z) dt_2 + \int_u^\infty f(t_1, u | z) dt_1}{\int_u^\infty \int_u^\infty f(t_1, t_2 | z) dt_1 dt_2} = \theta_1^*(u | z, T_2 > u) + \theta_2^*(u | z, T_1 > u)$$

where $\theta_1^*(u | z, T_2 > u)$ is a conditional hazard defined as:

$$\begin{aligned} \theta_1^*(u | z, T_2 > u) &= \lim_{\Delta \downarrow 0} \Pr(u < T_1 < u + \Delta | T_1, T_2 > u, z) \\ &= \frac{\int_u^\infty f(u, t_2 | z) dt_2}{\int_u^\infty \int_u^\infty f(t_1, t_2 | z) dt_1 dt_2} \end{aligned}$$

and an analogous definition applies to $\theta_2^*(u | z, T_1 > u)$.

The unconditional or marginal hazard $\theta_1(u | z)$ is defined as:

$$\begin{aligned}\theta_1(u | z) &= \lim_{\Delta \downarrow 0} \Pr(u < T_1 < u + \Delta | T_1 > u; T_2 = 0; z) \\ &= \frac{\int_0^{\infty} f(u, 0 | z) dt_2}{\int_u^{\infty} f(t_1, 0 | z) dt_1}.\end{aligned}$$

and similar definition applies to $\theta_2(u|z)$. It is now easy to verify that the conditional hazard is equal to the unconditional one if T_1 and T_2 are independent, that is if:

$$f(t_1, t_2 | z) = f_1(t_1 | z) f_2(t_2 | z).$$

A2 Estimation of the competing risks model

The determination of $m_2(\varepsilon_1)$

Our problem is to determine the value of $m_2(\varepsilon_1, v_2)$ in the double integral in (12) and (13). Simplifying the notation in an obvious way, we rewrite this integral as:

$$\int_{a_{1,t}}^{a_{1,t-1}} \int_{m_2(\varepsilon_1)}^{\infty} f(\varepsilon_1, \varepsilon_2) d\varepsilon_1 d\varepsilon_2 .$$

Observe that $m_2(\varepsilon_1)$ should be equal to $a_{2,t-1} = -\delta_{2,t-1} - \beta_2 z$ if $\varepsilon_1 = a_{1,t-1}$ and to $a_{2,t} = -\delta_{2,t} - \beta_2 z$ if $\varepsilon_1 = a_{1,t}$. Linear interpolation leads to the following expression:

$$m_2(\varepsilon_1) = a_{2,t-1} + \frac{\varepsilon_1 - a_{1,t-1}}{a_{1,t} - a_{1,t-1}} (a_{2,t} - a_{2,t-1})$$

which is used in estimating the model. This follows Han and Hausman (1990, p. 8) .

Elaboration of the double integral

In order to deal with the double integral in (6) we constructed a simulation algorithm. The integral can, with an obvious simplification in the notation, be rewritten as:

$$\begin{aligned}\int_a^b \int_{m_2(\varepsilon_1)}^{\infty} f(\varepsilon_1, \varepsilon_2) d\varepsilon_2 d\varepsilon_1 &= \int_a^b \int_{m_2(\varepsilon_1)}^{\infty} f_1(\varepsilon_1) f(\varepsilon_2 | \varepsilon_1) d\varepsilon_2 d\varepsilon_1 \\ &= \int_a^b f_1(\varepsilon_1) \int_{m_2(\varepsilon_1)}^{\infty} f(\varepsilon_2 | \varepsilon_1) d\varepsilon_2 d\varepsilon_1\end{aligned}$$

Where f_1 denotes the marginal density of ε_1 and $f(\varepsilon_2 | \varepsilon_1)$ the conditional density of ε_2 . The former is standard normal, the formula for the latter can be found in many statistics textbooks. Now define:

$$G(\varepsilon_1) = \int_{m_2(\varepsilon_1)}^{\infty} f(\varepsilon_2 | \varepsilon_1) d\varepsilon_2$$

and observe that the value of G can easily be computed by widely available computer routines. Using this definition, we can rewrite the integral further as:

$$\begin{aligned} \int_a^b \int_{m_2(\varepsilon_1)}^{\infty} f(\varepsilon_1, \varepsilon_2) d\varepsilon_2 d\varepsilon_1 &= \int_a^b f_1(\varepsilon_1) G(\varepsilon_1) d\varepsilon_1 \\ &= \int_a^b f_1(\varepsilon_1) d\varepsilon_1 \frac{\int_a^b f_1(\varepsilon_1) G(\varepsilon_1) d\varepsilon_1}{\int_a^b f_1(\varepsilon_1) d\varepsilon_1} \\ &= \int_a^b f_1(\varepsilon_1) d\varepsilon_1 E(G(\varepsilon_1 | a < \varepsilon_1 < b)). \end{aligned}$$

Simulation

The expected value in the last line of this expression can be simulated as follows. We take a large number (250) of draws from the uniform distribution on $[0,1]$. We transform these to random draws from the truncated standard normal distribution on $[a,b]$ by inversion (cf. Gouriéroux and Montfort, 1996, p. 16). We do so by solving the following equation for ε_k :

$$\frac{\Phi(\varepsilon_k) - \Phi(a)}{\Phi(b) - \Phi(a)} = \eta_k.$$

The left hand side of this equation give the values of the truncated standard normal distribution function for ε_k , the right hand side is the k -th draw from the uniform distribution.

The expected value of $G(\cdot)$ can now be approximated as the average of the values of $G(\varepsilon_k)$ over all draws:

$$E(G(\varepsilon | a < \varepsilon < b)) \approx \frac{\sum_k^K G(\varepsilon^k)}{K}$$

where k indexes the drawings and K is their total number.

The approximation of the integral by this simulation method introduces bias in the loglikelihood. This bias disappears when the number of draws is large (see e.g. Stern, 1997).

Further remarks

The formulation of the likelihood is based on (12) (and, for the model that allows for correlation between the two risks on (13)). The expression given in (12) is the likelihood of a commute ended by residential mobility in its t -th year of existence. The likelihood of an observation ended by job mobility is analogous. The likelihood of a right-censored commuting spell at t is also given by a double integral with lower limits equal to $\delta_{i,t-1} + \beta z$, $i=1,2$ and upper limits ∞ . For the computation of this integral no simulation is necessary. We have weighted the loglikelihoods of the individual observations by the weights constructed to correct for the under-representation of the households that changed their residential location between 1995 and 1998 (see the discussion at the beginning of section 4). This attempts to correct for the choice based element contained in this sample selectivity. The weighted estimator is consistent, but asymptotically less efficient than the non-feasible true maximum likelihood estimator (cf. Manski and Lerman (1977)).

Figure 1 Hazard rates (all observations)

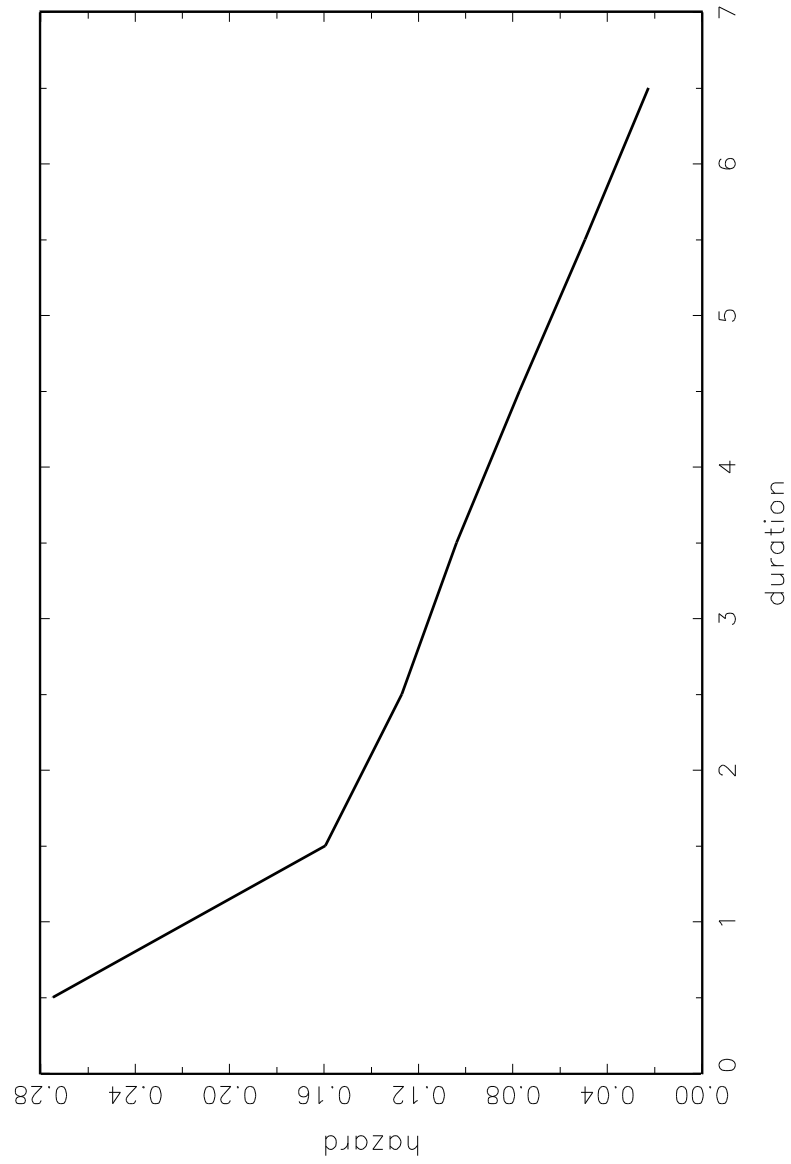

Figure 2 Hazard rates of commutes

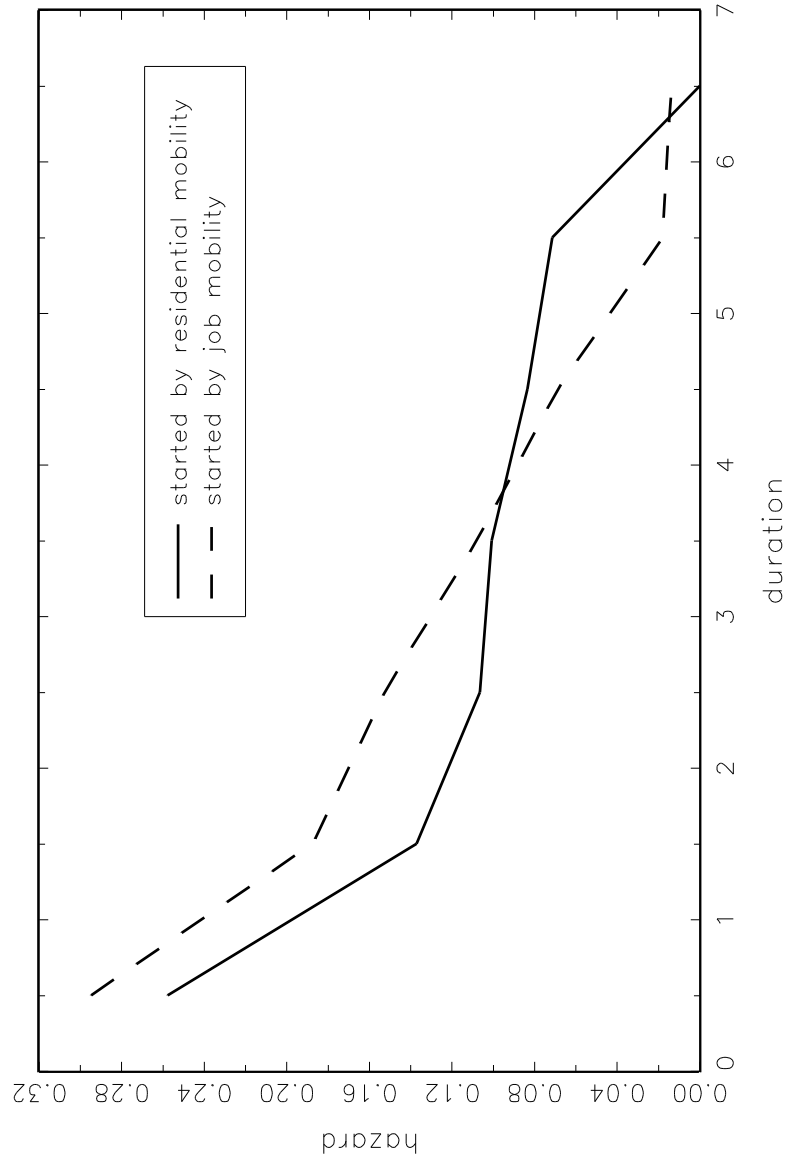

Figure 3 Hazard rates of commutes started by residential mobility

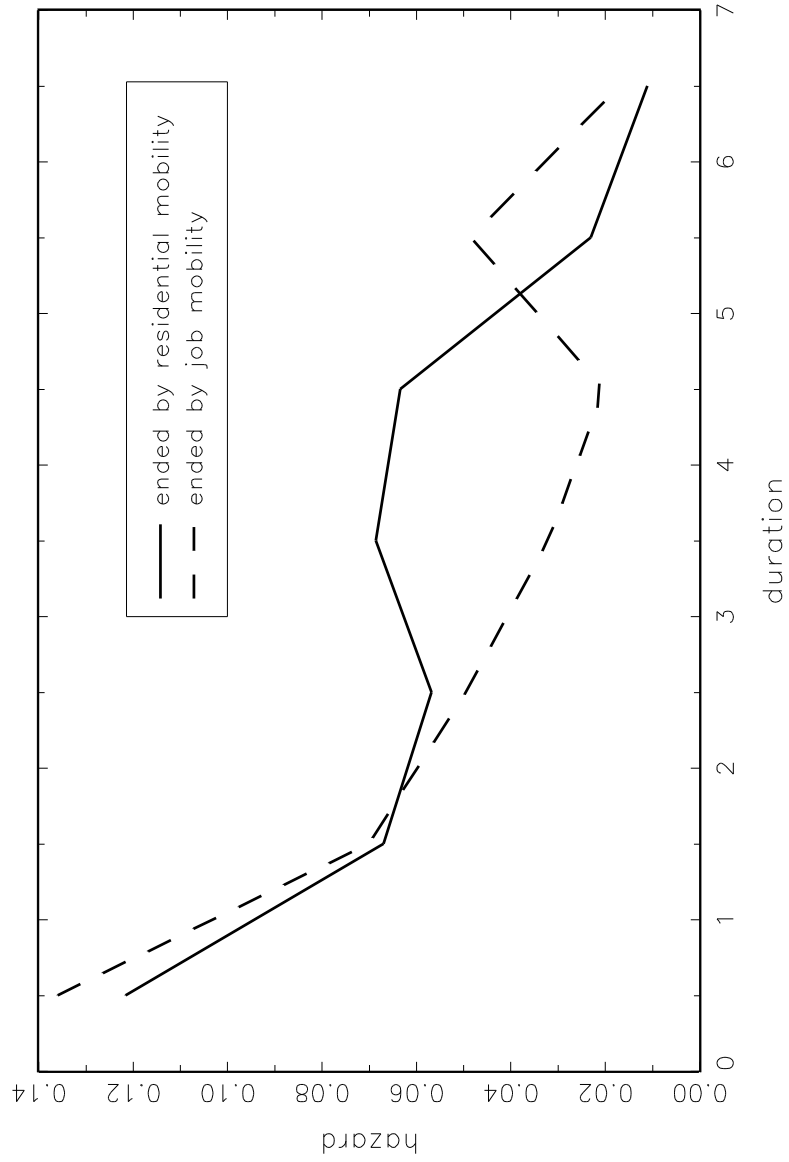

Figure 4 Hazard rates of commutes started by job mobility

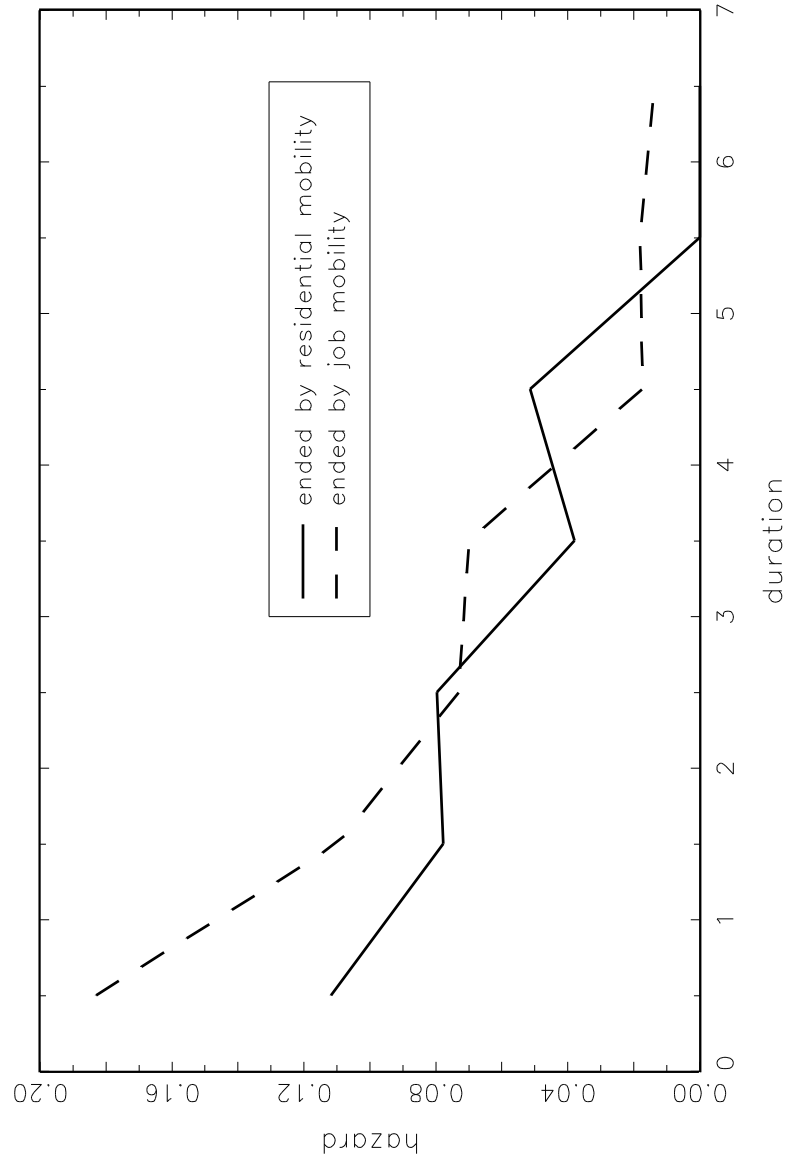

Figure 6 Hazard rates for male single earner

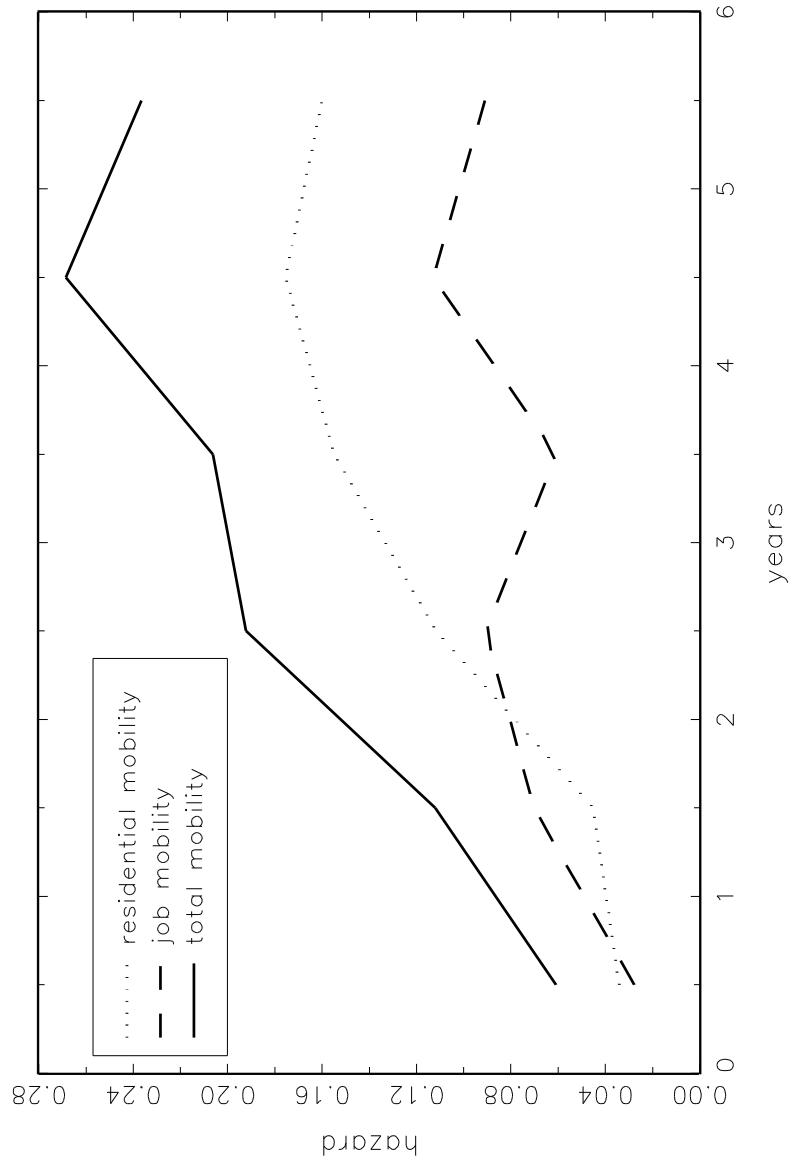

Figure 7 Hazard rates for male dual earner

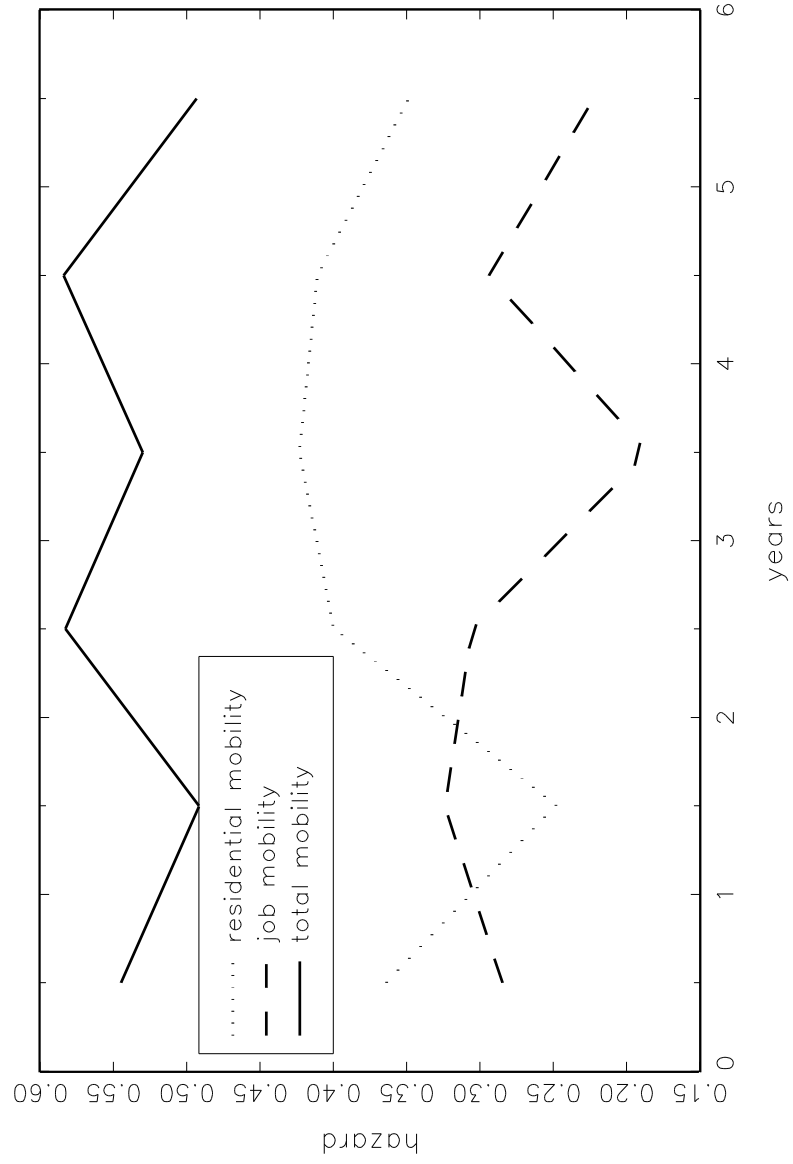

Figure 8 Hazard rates for female dual earner (part time job)

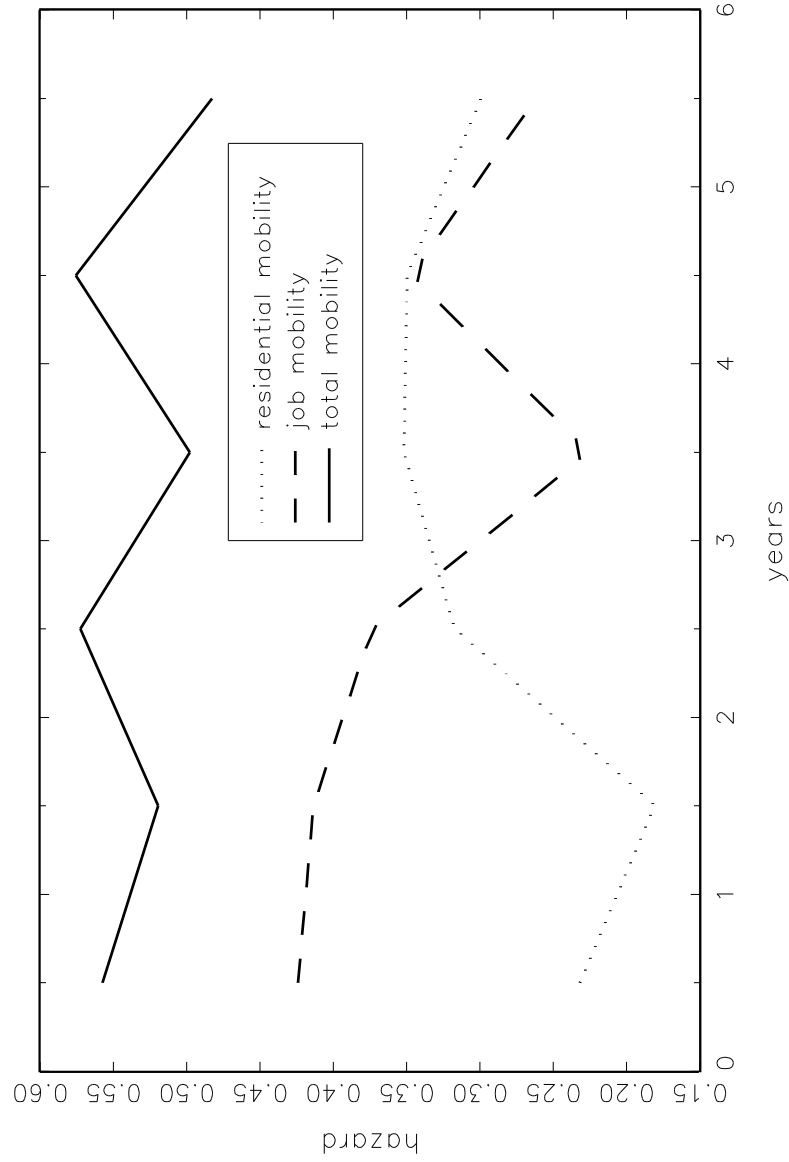

Figure 9 Hazard rates for female dual earner (full time job)

