

Francois, Joseph; Nelson, Douglas R.

Working Paper

Victims of Progress: Economic Integration, Specialization, and Wages for Unskilled Labor

Tinbergen Institute Discussion Paper, No. 00-065/2

Provided in Cooperation with:

Tinbergen Institute, Amsterdam and Rotterdam

Suggested Citation: Francois, Joseph; Nelson, Douglas R. (2000) : Victims of Progress: Economic Integration, Specialization, and Wages for Unskilled Labor, Tinbergen Institute Discussion Paper, No. 00-065/2, Tinbergen Institute, Amsterdam and Rotterdam

This Version is available at:

<https://hdl.handle.net/10419/85679>

Standard-Nutzungsbedingungen:

Die Dokumente auf EconStor dürfen zu eigenen wissenschaftlichen Zwecken und zum Privatgebrauch gespeichert und kopiert werden.

Sie dürfen die Dokumente nicht für öffentliche oder kommerzielle Zwecke vervielfältigen, öffentlich ausstellen, öffentlich zugänglich machen, vertreiben oder anderweitig nutzen.

Sofern die Verfasser die Dokumente unter Open-Content-Lizenzen (insbesondere CC-Lizenzen) zur Verfügung gestellt haben sollten, gelten abweichend von diesen Nutzungsbedingungen die in der dort genannten Lizenz gewährten Nutzungsrechte.

Terms of use:

Documents in EconStor may be saved and copied for your personal and scholarly purposes.

You are not to copy documents for public or commercial purposes, to exhibit the documents publicly, to make them publicly available on the internet, or to distribute or otherwise use the documents in public.

If the documents have been made available under an Open Content Licence (especially Creative Commons Licences), you may exercise further usage rights as specified in the indicated licence.



TI 2000-065/2
Tinbergen Institute Discussion Paper

Victims of Progress

Joseph Francois
Douglas R. Nelson

Tinbergen Institute

The Tinbergen Institute is the institute for economic research of the Erasmus Universiteit Rotterdam, Universiteit van Amsterdam and Vrije Universiteit Amsterdam.

Tinbergen Institute Amsterdam

Keizersgracht 482
1017 EG Amsterdam
The Netherlands
Tel.: +31.(0)20.5513500
Fax: +31.(0)20.5513555

Tinbergen Institute Rotterdam

Burg. Oudlaan 50
3062 PA Rotterdam
The Netherlands
Tel.: +31.(0)10.4088900
Fax: +31.(0)10.4089031

Most TI discussion papers can be downloaded at
<http://www.tinbergen.nl>

Victims of Progress:
Economic Integration, Specialization, and Wages for Unskilled Labor

Joseph Francois
Tinbergen Institute and CEPR

and

Douglas R. Nelson
Murphy Institute of Political Economy

June 2000

Abstract: In this paper we demonstrate that intra-industry trade (or FDI) between identical countries could produce the observed deterioration in the relative wages of unskilled workers. This involves a model of North-North integration through either increased trade flows or increased MNE-based production. Our motivation in this regard is arguments to the effect that trade cannot be responsible for the observed labour market trends because trade with developing countries is quantitatively too small to have significant labour market effects. We also introduce a relatively unexploited class of model that possesses attractive properties with respect to the explicit incorporation of firm-theoretic considerations in trade models.

Victims of Progress:
Economic Integration, Specialization, and Wages for Unskilled Labor

ABSTRACT: In this paper we demonstrate that intra-industry trade (or FDI) between identical countries could produce the observed deterioration in the relative wages of unskilled workers. This involves a model of North-North integration through either increased trade flows or increased MNE-based production. Our motivation in this regard is arguments to the effect that trade cannot be responsible for the observed labour market trends because trade with developing countries is quantitatively too small to have significant labour market effects. We also introduce a relatively unexploited class of model that possesses attractive properties with respect to the explicit incorporation of firm-theoretic considerations in trade models.

Key words: trade and wages; trade and employment; FDI and wages; globalization and employment

JEL classification: F16, F15, J31

CONTACT DETAILS:

Joseph Francois
Faculty of Economics
Erasmus University Rotterdam
Burg Oudlaan 50-H8-26
3062PA Rotterdam NETHERLANDS
voice: +31 10 408 1256
fax: +31 10 408 9146
email: francois@few.eur.nl
homepage: www.intereconomics.com/francois

Douglas Nelson
Murphy Institute of Political Economy
108 Tilton Hall
Tulane University
New Orleans, LA 70118-5698 USA
Voice: +1 504 865 5317
Fax: +1 504 862 8755
Email: dnelson@mailhost.tcs.tulane.edu
homepage: www.tulane.edu/~dnelson/

NON-TECHNICAL SUMMARY

Since the emergence in the 1980s, in virtually all industrial countries, of increasingly unequal returns to labour market participation between skilled and unskilled labour (however defined), there has been an understandable increase in research seeking to evaluate plausible explanations of this phenomenon. One of the primary, though highly controversial, suspects in this literature has been international trade. For the great majority of the research on the link between trade and wages, the logic of the argument is straightforwardly represented by the Stolper-Samuelson theorem, and the source of the problem is seen, more-or-less explicitly, to be trade with developing countries. One of the most compelling arguments against the plausibility of Stolper-Samuelson arguments is that trade with developing countries constitutes too small a share of OECD economic activity to generate effects of the magnitude observed in the 1980s. In this paper, we reexamine the link between trade and wages in a model of intra-industry trade between identical countries—i.e. the sort of trade that makes up the majority of trade in OECD countries.

While it is certainly true that the great majority of research on the trade-wages link is organized more-or-less explicitly in Heckscher-Ohlin terms, it is certainly not the case that this is the first paper to adapt a framework based on imperfect competition to the study of this question. While lacking general equilibrium foundations, a number of labour economists have developed models in which firms and unions bargain over imperfectly competitive rents which are themselves affected by the terms of international competition. Our approach, which is general equilibrium, is very close to the recent one on the effect of multinationalization on relative factor-returns.

We have two goals in this paper. First, starting from a model that exhibits basic intra-industry externalities (along the line of the specialization and monopolistic competition literature), our basic goal is to demonstrate that, at least as a matter of logic, there is no reason why intra-industry trade, between identical countries, could not produce the observed deterioration in the relative wages of unskilled workers. A secondary objective is to introduce a relatively unexploited class of model that possesses particularly attractive properties with respect to the explicit incorporation of firm-theoretic considerations in trade models.

We are motivated in our primary goal by recent arguments to the effect that trade cannot be responsible for observed labour market trends since the late 1970s because trade with developing countries is quantitatively too small to have significant labour market effects. It may be that the relatively small volumes of North-South trade seem unlikely to have generated the sizable relative wage effects observed in the 1980s. However, this should not exonerate trade and FDI from suspicion. The last two decades have seen unprecedented (at least since the start of the first World War) integration -- through both trade and FDI -- of the industrial economies. Such North-North integration is logically consistent with the observed wage pattern. We show here that growing North-North trade and foreign direct investment can generate large factor market effects as part of an otherwise virtuous link between productivity and integration. Unskilled labor is then left behind as a victim of progress.

Victims of Progress: Economic Integration, Specialization, and Wages for Unskilled Labor

Since the emergence in the 1980s, in virtually all industrial countries, of increasingly unequal returns to labour market participation between skilled and unskilled labour (however defined), there has been an understandable increase in research seeking to evaluate plausible explanations of this phenomenon.¹ One of the primary, though highly controversial, suspects in this literature has been international trade. For the great majority of the research on the link between trade and wages, the logic of the argument is straightforwardly represented by the Stolper-Samuelson theorem, and the source of the problem is seen, more-or-less explicitly, to be trade with developing countries. One of the most compelling arguments against the plausibility of Stolper-Samuelson arguments is that trade with developing countries constitutes too small a share of OECD economic activity to generate effects of the magnitude observed in the 1980s.² In this paper, we reexamine the link between trade and wages in a model of intra-industry trade between identical countries—i.e. the sort of trade that makes up the majority of trade in OECD countries.

¹Given the rapid growth in this literature, it is probably not surprising that surveys of this literature are growing at nearly the same rate as the literature itself. On labour market conditions generally, see: Davis (1992), Levy and Murnane (1992), Kusters (1994), Gottschalk and Smeeding (1997), the papers in the *Journal of Economic Perspectives* symposium on “Wage Inequality” (1997, V.11-#2), and the appendix to Gaston and Nelson (1998). Given our particular concern with the link between trade and wage inequality, we mention recent surveys of this topic by OECD (1997), Gaston and Nelson (1998) and Slaughter (1998), as well as the recent volume of papers edited by Collins (1998).

²Though see Leamer (1998) for a strong objection to the *logic* of this sort of size based argument.

While it is certainly true that the great majority of research on the trade-wages link is organized more-or-less explicitly in Heckscher-Ohlin terms, it is certainly not the case that this is the first paper to adapt a framework based on imperfect competition to the study of this question. While lacking general equilibrium foundations, a number of labour economists have developed models in which firms and unions bargain over imperfectly competitive rents which are themselves affected by the terms of international competition (Abowd and Lemieux, 1991; Freeman and Katz, 1991; Borjas and Ramey, 1994, 1995; Gaston and Trefler, 1995). Since we will be developing a general equilibrium analysis, more directly relevant work can be found in the early developments of the monopolistic competition model which examined income distribution effects—e.g. Krugman (1981) and Ethier (1982)—and our analysis is very much in this tradition.³ A very closely related body of research considers the effect of multinationalization on relative wages. Feenstra and Hanson (1996, 1997) develop a model of North-South division of labour in a single industry in which capital mobility (i.e. the multinational division of labour) can raise the relative wage of skilled labour in both countries.⁴ Much more closely related to the model developed here are papers by Markusen and Venables (1996a, 1997) on the effects of North-North multinationalization on relative factor-returns.

In the next section, we develop a model of increasing returns due to specialization at the plant level, which we then embed in a two-factor \times two-good general equilibrium structure. In this framework we consider two types of globalisation: international trade and multi-nationalisation.

³Ethier (1982), in particular, provides a careful analysis of Stolper-Samuelson-like effects in the context of his classic division of labour model. Our paper (Francois and Nelson, 1998) whose framework this paper extends is basically a graphical gloss on Ethier's paper.

⁴Bhagwati and Dehejia (1994) sketch a model with similar concerns.

Because the structure is a bit unusual, we develop it in some detail. However, once the structure has been presented, we are able to take advantage of the graphical apparatus developed in Francois and Nelson (1998) to present our main results on globalisation and relative returns to skilled *versus* unskilled labour quite quickly.

I. Production and General Equilibrium under Specialization Economies

While the notion that the division of labour has both micro and macroeconomic foundations goes back at least to Adam Smith, and most clearly to Allyn Young, it lived a sort of shadowy existence until the development of a number of simple formalizations in the early 1980s permitted direct introduction of these ideas into the main corpus of economic theory.⁵ One of the fundamental barriers to formalization lay in the difficulty of treating the macroeconomic aspect of division of labour seriously in a tractable framework. The macroeconomic aspect of the analysis rests on the recognition that an increasing division of labour involves a fundamental transformation of the technology (increasing “roundaboutness”) at the level of the economy as a whole. In addition, there is the effect, beautifully summarized by Marshall (1890) in terms of “... the part which nature plays in production shows a tendency to diminishing return, the part which man plays shows a tendency to increasing return”. That is, as we are now well aware, any serious treatment of the macroeconomic aspects of the division of labour leads fairly directly to increasing returns and, thus, to nonconvexities in the feasible set.

⁵Buchanan and Yoon (1994) collect a number of key papers from both the shadowy early period (including the relevant passage from Smith, and Young’s classic essay) and the current emergence as a core element of both micro and macroeconomic research. Krugman’s (1995) Ohlin Lectures are a fascinating presentation of the relationship between ideas and models in this area.

The key step in formalizing these essential notions was Wilfred Ethier's (1982) insight that the Spence-Dixit-Stiglitz model of monopolistic competition could be reinterpreted as a model of the division of labour. In addition to a perfectly competitive, constant returns to scale sector, the Ethier model has a sector which uses specialized inputs to produce a final consumption good. Allyn Young-like roundaboutness is represented by the fact that productivity in this sector is increasing in the variety of such inputs. On the other hand, the division of labour among producers of specialized inputs is limited by increasing returns and fixed resources.⁶ As was clear from the start of this literature, this model was characterized by macroeconomic increasing returns as well as the microeconomic increasing returns at the level of specialized inputs.⁷

An interesting alternative representation of the division of labour was suggested by Edwards and Starr (1987) in their formalization of Adam Smith's pin factory example. The Edwards-Starr model represents an increasing division of labour in terms of a family of production functions indexed by the number of distinct tasks into which the production process is divided. Assuming one class of labour, that can be allocated to any of v tasks, Edwards and Starr give the firm's production function as:

⁶This aspect of the model was also essential to the model of Spence (1976) and Dixit-Stiglitz (1977). In the SDS model these are final consumption goods, while in the Ethier model they are producer goods.

⁷In addition to Ethier's original analysis, see Markusen (1990) and Francois and Nelson (1998) for treatments that stress the division of labour/macroeconomic increasing returns aspects of the Ethier model. This property of the Ethier model also led to its adoption as the theoretical basis of one of the fundamental models of endogenous growth (e.g. Romer, 1987).

$$y = f_v(L_1, \dots, L_v) \equiv b_v \prod_{i=1}^v L_i^{a_{i,v}}.$$

For any intensity of division of labour (denoted by v , the number of distinct tasks), the relevant production function is made up of a Cobb-Douglas kernel and a productivity parameter representing increased productivity with an increased division of labour.⁸ The Edwards-Starr analysis is, however, essentially microeconomic. The authors were interested in exploring Smith's insight that since labour comes embodied in discrete lumps (i.e. people), and there are costs of transferring people between jobs, "the division of labour is limited by the extent of the market".

Francois (1990a and b) makes the step to a macroeconomic analysis by introducing a labour constraint in a one-sector model of the Edwards-Starr variety to analyze growth (1990a) and trade (1990b). In making the move to a tractable macroeconomic model, that can be analyzed with standard formal methods, Francois drops the emphasis on lumpy labour in favor of infinitely divisible labour. Without some additional constraint, this would imply an infinitely intensive division of labour. As with Edwards and Starr, this additional constraint emerges from firm-theoretic considerations, but where Edwards and Starr follow Smith in focusing on shop floor production considerations, Francois adopts a more modern firm-theoretic approach based on the increasing costs of managing a more intensive division of labour. In this section we extend Francois' framework to a two sector economy.

⁸ Specifically, Edwards and Starr assume that: $\beta_{v+1} > \frac{v+1}{v} \beta_v$. It is also assumed that $\sum a_{i,v} = 1$.

Suppose that the economy is endowed with skilled (S) and unskilled (L) labour, which is used to produce two final consumption goods: differentiated manufactures (M); and a standardized good (X). Good X is produced from S and L according to a standard neoclassical production function.⁹ Since good X is completely standard, we focus on developing the production of M , which is characterized by increasing returns due to specialization at the plant level, along the lines spelled out in Francois (1990b). We assume that a range of techniques are available and indexed by ν . Increasing the degree of specialization within a plant (choosing a higher ν) increases the productivity of direct labor, but is subject to rising indirect (i.e. skilled) labor costs related to coordination, control, technical process management, etc. Thus, following Edwards and Starr, direct production of variety j of manufactures is specified as follows:

$$\begin{aligned}
 m_j &= \beta_\nu \prod_{i=1}^{\nu} L_i^{\alpha_{i,\nu}} \\
 &= \nu^\delta \prod_{i=1}^{\nu} L_i^{1/\nu}.
 \end{aligned}
 \tag{1}$$

Where m_j is the output of variety j in the plant, L_i represents direct labor employed in activity ν , and the second equality is derived by setting $\mathbf{b}_\nu = \nu^d$ (where $d > 1$) and $\mathbf{a}_{i\nu} = 1/\nu$.

Increased specialization comes at the expense of increased skilled labor requirements as follows:

⁹That is, $X = g(S,L)$, where $g(\cdot)$ is linear homogeneous, twice differentiable, and strictly concave.

$$S_j = m_j^\psi v. \quad (2)$$

where $1 > \boldsymbol{y} > 0$. Equation (2) states that skilled labor requirements increase linearly with the degree of specialization–holding scale (i.e. level of output) constant. They also increase with scale, but at a decreasing rate for a given degree of specialization. Combined, equations (1) and (2) imply an optimal degree of specialization that increases with the level of output, holding factor prices constant. This can be generalized in terms of the set of envelope curves containing the set of efficient techniques for a given level of output m_j :

$$m_j = \left[L^{1/\delta} S^{(\delta-1)/\delta} \right]^{1/\xi}. \quad (3)$$

where $\xi := \frac{(1 + \psi(\delta - 1))}{\delta}$ and $1 > \boldsymbol{x} > 0$. From equation (3), plant-level production is

characterized by increasing returns to scale, while increased output, at a given level of relative labor costs, will be characterized by increased specialization within the plant. In particular, the optimal degree of specialization v^* will be given by:

$$v_j^* = \left[(\delta - 1) \frac{w_L}{w_S} \right]^{1/\delta} m_j^{(1-\psi)/\delta}. \quad (4)$$

where w_L designates the wage of unskilled (i.e. direct) labor, and w_S designates the wage of skilled (i.e. indirect) labor.

Given equation (4), variable production costs at the plant level will be as follows:

$$\begin{aligned}
VC(m_j) &= \left[w_L^{1/\delta} w_S^{(\delta-1)/\delta} \right] \left[(\delta-1)^{1/\delta} \frac{\delta}{\delta-1} \right] m_j^\xi \\
&= f(w_L, w_S) m_j^\xi.
\end{aligned} \tag{5}$$

Plant level costs are characterized by scale economies and a constant cost-disadvantage ratio. For convenience, we define factor bundles b , produced subject to constant returns to scale and normalized so that they have a price equal to the factor price index component of equation (5).

$$c(b) = f(w_L, w_S). \tag{6}$$

Finally, to round out the production side of the m sector, we assume that each variety requires a fixed cost (also measured in units of b) q .

$$FC(m_j) = q \times f(w_L, w_S). \tag{7}$$

We will be dealing with two alternative forms of globalisation. The first involves trade with single plant firms, the other involves multi-plant firms and hence an equilibrium where trade is replaced by multinational enterprises (MNEs). For a given product mix, whether we observe a trade or MNE equilibrium will depend on the difference between trading costs (designated t) and the cost disadvantage from operating a second plant in the host country. For reasons that will become clear, we assume that MNEs both forego potential scale economies when they operate multiple plants, *and* also incur higher costs with production in the host country, designated a . In formal terms, we have:

$$TC_{trade} = \left[(m_j^1 + m_j^2)^\xi + q \right] f(w_L, w_S), \tag{8}$$

$$TC_{MNE} = \left[(m_j^1)^\xi + a(m_j^2)^\xi + q \right] f(w_L, w_S). \quad (9)$$

In writing equations (8) and (9), we have taken advantage of the assumption (introduced explicitly below) that we are working with a symmetric equilibrium, such that $f^1(\cdot) = f^2(\cdot)$, and where a superscript designates country 1 or country 2.

In the case of the trade equilibrium, equation (8) actually describes ex-factory costs. We also assume a trading cost (modelled Samuelson iceberg fashion) of b . Combined with an assumption of average cost pricing, this yields the following delivered average cost pricing equations in the trade equilibrium.

$$AC_{m_j^1} = \frac{\left[(m_j^1 + m_j^2)^\xi + q \right]}{m_j^1 + m_j^2} f(w_L, w_S), \quad (10)$$

$$AC_{m_j^2} = \tau \times AC_{m_j^1}$$

At the subutility level for good m , we assume CES-type preferences for variety:

$$M = \left[\sum_{j=1}^n m_j^p \right]^{1/p}. \quad (11)$$

From equation (11), the combination of the number of available varieties n in equilibrium, and the elasticity of substitution between varieties ρ will determine the elasticity of demand ϵ_j for each

variety. In the large group case, this converges to \mathbf{S} .

$$\varepsilon_j = \varepsilon(\sigma, n), \varepsilon_1, \varepsilon_2 > 0, \varepsilon \rightarrow \sigma \text{ as } n \rightarrow \infty. \quad (12)$$

We leave it to the reader to verify that, in the large group trade equilibria, characterized by single plant firms, the level of output per firm will be fixed, with market expansion leading to pure variety gains for consumers. In the small group case, which will be emphasized here, we will see an expansion of both scale and variety as more resources are devoted to m production.¹⁰

To complete our general equilibrium system, we make the following three assumptions. First, upper-tier preferences are identical and linear homogenous. Second, the transformation function between X and b is strictly concave. Third, the b sector is relatively skill-intensive.

$$\mu = U(X, M); \quad (13)$$

$$X = \gamma(b) \text{ where } \gamma' \text{ and } \gamma'' < 0. \quad (14)$$

$$\left(\frac{w_L}{w_S} \right) = \Omega(b) \text{ where } \Omega' < 0. \quad (15)$$

The third assumption, as embodied in equation (15), can be backed out of a Heckscher-Ohlin production structure for bundles and X , or alternatively out of a specific factors framework, with skilled labor being m specific and unskilled labor being employable in both the m and X sectors.

¹⁰ Formally, zero profits and monopoly pricing require that $1/\mathbf{e} = \text{CDR}$, where $\text{CDR} = 1 - \text{MC}/\text{AC}$, and MC and AC are marginal and average cost. This condition is met in the present model, in the small group case, when firm level output m_j and n increase or fall in tandem. In the small group case, the elasticity of demand equals $\mathbf{S} + \mathbf{x}(1 - \mathbf{S})$, where \mathbf{x} is a quantity weighted measure of market share.

II. The integrated (or autarky) equilibrium

Consider next the general equilibrium properties of the economy outlined above. We start with the integrated or autarky equilibrium, and in particular with the transformation from factor bundles b to the composite manufactured good M . In the M sector, the monopolistically competitive equilibrium will involve versions of equations (8), (10),(11), and (12), along with the monopoly pricing and full employment rules below:

$$(1 - 1/\varepsilon)P_i = \zeta m_i^{\zeta-1} P_b \quad (16)$$

$$n = b / (m_i^\zeta + q_i) \quad (17)$$

With considerable manipulation, the relationship between the number of bundles b and the composite good M under these conditions can be shown to be the following:

$$\begin{aligned}
M = \Theta(b) &= \left(\frac{\frac{b}{\frac{1}{2} \xi q_i - \sigma b + b - 2q_i - \xi \sigma q_i + 2\sigma q_i + \xi \sigma b + A1}}{A2} + q_i \right)^{\frac{\sigma}{\sigma-1}} \times \\
&\quad \left(\frac{1}{2} \frac{\xi q_i - \sigma b + b - 2q_i - \xi \sigma q_i + 2\sigma q_i + \xi \sigma b + A1}{A2} + q_i \right)^{\frac{1}{\xi}} \\
\text{or} &= \left(\frac{\frac{b}{\frac{1}{2} \xi q_i - \sigma b + b - 2q_i - \xi \sigma q_i + 2\sigma q_i + \xi \sigma b - A1}}{A2} + q_i \right)^{\frac{\sigma}{\sigma-1}} \times (18) \\
&\quad \left(\frac{1}{2} \frac{\xi q_i - \sigma b + b - 2q_i - \xi \sigma q_i + 2\sigma q_i + \xi \sigma b - A1}{A2} + q_i \right)^{\frac{1}{\xi}}
\end{aligned}$$

where

$$\begin{aligned}
A1 &= [\xi^2 \sigma^2 b^2 + \xi^2 \sigma^2 q_i^2 + 2\xi \sigma b^2 - 2\xi \sigma^2 b^2 - 2\xi^2 \sigma q_i^2 - 2\xi b q_i + 2\xi^2 b q_i \sigma \\
&\quad + 2\xi b q_i \sigma^2 - + 2\xi^2 b q_i \sigma^2 + \xi^2 q_i^2 + \sigma^2 b^2 - 2\sigma b^2 + b^2]^{\frac{1}{2}} \\
A2 &= 1 + \xi \sigma - \sigma - \xi
\end{aligned}$$

Representative plots of this relationship, from numerical computations, are presented in the appendix.

The economically relevant equilibrium sets defined by equation (18) are characterized by positive first and second derivatives. We are therefore able to represent the economy as in Figure 1. In the lower left quadrant, equation (14) defines the transformation frontier between bundles (b) and X . The lower right quadrant is an identity map taking X from the lower left to the upper right quadrant. The function $M = \Theta(b)$ in the upper left quadrant represents the equilibrium relationship between bundles

and the subutility composite good M . Given specialization externalities, the term $\Theta'' > 0$ captures the benefits of these externalities on the average contribution of bundles b to the composite M .¹¹ (In the standard large group Ethier model, this follows purely from variety effects, while in the present case, this follows from a mix of increased scale and variety.) The mapping, through the function Θ , from b to M then allows us to draw the frontier in the upper right quadrant. Consumption, given homothetic upper-tier preferences, will be at some point like e_0 , with a non-tangency between the private and social product transformation rates. Finally, equation (15) is represented in the fifth quadrant.

3.A. Economic integration through reduction in trading costs

Now that we have established the basic model, we proceed to our analysis of the effect of globalisation on the relative wages of unskilled workers. In this section we consider the effect of international trade, while the next section takes up foreign direct investment. To keep the analysis simple, we work with the completely symmetric case. That is, countries have identical endowments, technologies, and preferences. Samuelson's angel simply divides the integrated equilibrium represented above by allocating factors in equal quantities between the two economies. With costly trade, both economies will look qualitatively like that in figure 1, but since the Θ function is determined by conditions in both countries, as we introduce trading costs, there will be a downward shift in the Θ function as, along the lines of Krugman's (1980) initial discussion of home market effects, we observe a substitution from foreign to home varieties.

¹¹ Note that in the large group case, we fix m_j , so that we can scale b such that $m = b$.

The relationship between trading costs t and the Θ function is represented in Figure 2. (Its derivation is discussed in the appendix). In the figure we have mapped trading costs on the z -axis, bundles on the y -axis, and M on the vertical axis. As we move along the z -axis, each slice of the surface represents a t -dependant Θ function.

Now, from an equilibrium with trading costs, consider the impact of a reduction in trading costs. We represent this process in Figure 3. First, we will have an upward shift in the Θ function as trading costs fall, and a consequent shift in the MX frontier.¹²

Consumers will perceive a gain in the efficiency with which the economy produces M . If substitution effects dominate, and budget shares are shifted toward m production, we will observe the following: an increased degree of specialization at the firm level, with consequent productivity gains, an increase in skilled wages relative to unskilled wages, and an increase in real national income (choosing the composite U as the numeraire). Whether or not unskilled labor gains in real terms, even as it loses in relative terms, will depend on the strength of combined variety and scale effects in the m sector.

A considerable body of empirical research finds that foreign direct investment is closely associated with the relative wage effects driving the trade and wages literature. Thus, the next section considers a simple extension of our model to the case of multinational firms.

¹²There is a whole set of issues related to stability and the location of industry as we move away from symmetric equilibria. This is the subject of the new geography literature. We reserve discussion of stability until a later subsection of the paper.

3.B. Economic integration through reduction in FDI costs for MNEs

Theoretical research on foreign direct investment (FDI) has developed in three waves. In the first, FDI was analyzed in terms of capital arbitrage.¹³ The second wave was initiated by Steven Hymer's (1960) dissertation and focused on firm-theoretic analysis in an essentially partial equilibrium framework. This wave was characterized by two distinct strands, one followed Hymer in focusing on market power considerations, while the other adopted the Coase-Arrow-Williamson internalization approach.¹⁴ The most recent wave attempts to incorporate the firm-theoretic insights of the second wave into a trade-theoretic general equilibrium framework. The first attempts of this sort follow a suggestion by Caves (1971) in treating the multinational enterprise (MNE) as an agent of international arbitrage of firm-specific capital in an essentially perfectly competitive environment. While this was a useful first step, this approach does not really come to grips with the implications of the firm-theoretic approach.¹⁵ Since the mid-1980s a number of scholars have begun to build firm-theoretic features into monopolistic competition models that begin to incorporate the full range of considerations in all the previous research on FDI.

This most recent trend begins with important papers by Helpman (1984, 1985) and Markusen (1984), who model the production and trade decisions of multinational *firms* that produce according to

¹³The papers collected in Machlup, Salant, and Tarshis (1972) are a fair sample of this line of research.

¹⁴Caves (1982) presents a very good survey of the research that makes up the second wave. One should also mention John Dunning's highly influential attempt to synthesize the two strands of the second wave. See Dunning (1981) for a representative sample of this work.

¹⁵However, as an example of just how useful a first step this is, see Jones and Dei's (1983) outstanding graphical exposition and extension of the Caves-Amano-Falvey analysis.

a technology with both firm and plant specific fixed costs. Helpman develops a model of vertical integration, in which headquarters activities (i.e. firm-specific fixed costs) are concentrated in the home country while production (characterized by plant-specific fixed costs) are concentrated abroad. For Helpman, MNEs exist to take advantage of international differences in factor-prices since headquarters and production activities use factors in different proportions. Markusen's model of headquarters activity is somewhat different, with the firm-specific activity a non-rival input to all plants in the firm. Because there are decreasing costs in the headquarters activity, it is concentrated in one country, while national markets are served by local production branches. Where the Helpman (1984) model is essentially a model of international vertical multinationalization, Markusen's model is one of horizontal multinationalization. In the context of this model, Markusen shows that countries which are symmetric in autarky can end up with asymmetric outcomes. In particular, Markusen examines the effect of globalisation on relative returns to production in the two countries.

The approach we adopt in this paper is very close to that in Markusen (1984), though the model of firm activity is distinct. We assume the existence of a MNE and represent increased globalisation as a reduction in the cost of multinational production. Specifically, we assume that equation (9) is less than equation (8) for relevant equilibria, or alternatively that a and foregone scale economies are low relative to \mathbf{t} in the relevant range of equilibria. From such an equilibrium (which may again be represented as in Figure 3), the qualitative implications of a decline in a are comparable to those for a decline in \mathbf{t} . As in the case of increased trade-based economic integration, with increased MNE-based integration we will again observe an improvement in sectoral efficiency as measured by the Θ function, and depending on substitution effects, the following coincident events: an increased degree of

specialization at the firm level, with consequent productivity gains, an increase in skilled wages relative to unskilled wages, and an increase in real national income (choosing the composite U as the numeraire). Whether or not unskilled labor gains in real terms, even as it loses in relative terms, will again depend on the strength of combined variety and scale effects in the m sector.

3.C. Economic integration, stability, and dynamic adjustment

Finally, we examine another, related set of implications from falling trading costs, improved efficiency of MNE production, and the relative wages of unskilled labor. We have so far limited ourselves to regions, in the upper right quadrant of Figure 3, characterized by well-behaved (at least locally) equilibria. From Francois and Nelson (1998), we know that, in the mapping in the upper right quadrant, we will have stable and unstable equilibria, with relative stability depending on the curvature of the g and Θ functions.¹⁶ In terms of Figure 4 this means that, with increased integration, the shift in equilibria may not be local. In particular, if we are shifted into an unstable region, then the initial shift by consumers of expenditure (and hence resource) into m production leads to increases in scale effects (measured by k') that will, at least locally, outweigh the relative curvature of the g function. The result will be a potentially large non-local shift in resources into m production following a relatively mild shock to the productivity of the m sector, abetted either by reduced trading costs, or by increased efficiency of MNE production. In either event, we may then expect an adjustment process that appears to involve productivity gains in the m sector, rising relative wages for skilled labor, falling prices for M (due

¹⁶ Formally, the stability of an equilibria depends on whether $g'' / g' > 0$ or $< k'/k$.

to scale effects and variety effects), and an increasing volume of either international trade or MNE activity.

4. Conclusions

This paper has had two goals. The first has been simply to note that, at least as a matter of logic, there is no reason why intra-industry trade, between identical countries, could not produce the observed deterioration in the relative wages of unskilled workers. We were motivated in this concern by some arguments to the effect that trade cannot be responsible for observed labour market trends since the late 1970s because trade with developing countries is quantitatively too small to have significant labour market effects. North-North integration, through trade or foreign investment, is logically consistent with such a wage pattern. We note in passing that the last two decades have seen unprecedented (at least since the start of the first World War) integration -- through both trade and FDI -- of the industrial economies. Our second goal has been to introduce a relatively unexploited class of model that possesses particularly attractive properties with respect to the explicit incorporation of firm-theoretic considerations in trade models.

The literature on trade and labor markets has focused primarily on mechanisms of the Stolper-Samuelson sort and, thus, at least implicitly, on North-South trade. As we noted in the introduction, the relatively small volumes of North-South trade seem unlikely to have generated the sizable relative wage effects observed in the 1980s. In this paper we have shown that growing North-North trade and foreign direct investment can generate large factor market effects as part of an otherwise virtuous link between productivity and integration. Unskilled labor is left as a victim of progress.

This paper has also sketched a simple model with rudimentary firm structure and used the model to evaluate the implications of international trade and foreign direct investment under fixed market structures. In this we follow the earlier development of models with alternative firm theoretic foundations by Helpman (1984, 1985) and Markusen (1984). In addition, we have argued that models of the Edwards-Starr class, especially as adapted for macroeconomic analysis, provide a particularly promising framework for considering the integration of FDI in trade theoretic models. However, the analysis presented here is a very small first step. A considerably larger step is taken in an extraordinary series of papers by Ethier (1986), Horstmann and Markusen (1992), Markusen and Venables (1996a,b,c, 1997, 1998), and Brainard (1993) that seek to endogenize multinationality itself. The programme, developed in greatest detail by Markusen and Venables, of integrating firm-theoretic considerations with trade theoretic considerations in a general equilibrium theoretical framework strikes us as both interesting and important.

References

- Abowd, John and Thomas Lemieux (1991). "The Effects of International Trade on Collective Bargaining Outcomes: A Comparison of the US and Canada". in J. Abowd and R. Freeman, eds. *Immigration, Trade and Labor Markets*. Chicago: University of Chicago Press, pp. 407-421.
- Aitken, B., Anne Harrison, and Richard Lipsey (1997). "Wages and Foreign Ownership: A Comparative Study of Mexico, Venezuela, and the US". *NBER Working Paper*, #5102.
- Bhagwati, Jagdish and Vivek Dehejia (1994). "Freer Trade and Wages of the Unskilled—Is Marx Striking Again?". In J. Bhagwati and M. Kosters, eds. *Trade and Wages: Leveling Wages Down?* Washington, DC: AEI, pp. 36-75.
- Borjas, George and Valerie Ramey (1994). "The Relationship between Wage Inequality and Trade". In J. Bergstrand, et al. Eds. *The Changing Distribution of Income in an Open US Economy*. New York: Elsevier, pp. 217-241.
- Borjas, George and Valerie Ramey (1995). "Foreign Competition, Market Power, and Wage Inequality". *Quarterly Journal of Economics*; V.110-#4, pp. 1075-1110.
- Brainard, S. Lael (1993). "A Simple Theory of Multinational Corporations and Trade with a Trade-off between Proximity and Concentration". *NBER Working Paper*; #4269.
- Brainard, S. Lael (1997). "An Empirical Assessment of the Proximity-Concentration Trade-off Between Multinational Sales and Trade". *American Economic Review*; V.87-#4, pp. 520-544.
- Brainard, S. Lael and D. Riker (1997). "Are Multinationals Exporting US Jobs?". *NBER Working Paper*, #5958.
- Brecher, Richard and E. Choudhri (1996). "Liberalizing Multinational Investment: The Stolper-Samuelson Question Revisited". in R. Feenstra, G. Grossman and D. Irwin, eds. *The Political Economy of Trade Policy*. Cambridge: MIT, pp. 77-88.
- Buchanan, James and Yong Yoon, eds. (1994). *The Return to Increasing Returns*. Ann Arbor: University of Michigan Press.
- Caves, Richard (1971). "International Corporations: The Industrial Economics of Foreign Investment". *Economica*; V.38-#149, pp. 1-27.
- Caves, Richard (1982). *Multinational Enterprise and Economic Analysis*. Cambridge: Cambridge University Press.

- Collins, Susan, ed. (1998). *Imports, Exports, and the American Worker*. Washington, DC: Brookings.
- Davis, Stephen (1992). "Cross-Country Patterns of Change in Relative Wages". In O. Blanchard and S. Fisher, eds. *NBER Macroeconomic Annual--1992*. Cambridge: MIT, pp. 238-300.
- Dixit, Avinash and Joseph Stiglitz (1977). "Monopolistic Competition and Optimum Product Diversity". *American Economic Review*; V.67-#3, pp. 297-308.
- Dunning, John (1981). *International Production and the Multinational Enterprise*. London: Allen and Unwin.
- Edwards, Brian and Ross Starr (1987). "A Note on Indivisibilities, Specialization, and Economies of Scale". *American Economic Review*; V.77-#1, pp. 192-194.
- Ethier, Wilfred (1982). "National and International Returns to Scale in the Modern Theory of International Trade". *American Economic Review*; V.72-#3, pp. 950-959.
- Ethier, Wilfred (1986). "The Multinational Firm". *Quarterly Journal of Economics*. V.101-#4, pp. 805-833.
- Feenstra, Robert and Gordon Hanson (1996). "Foreign Investment, Outsourcing and Relative Wages". in R. Feenstra, G. Grossman and D. Irwin, eds. *The Political Economy of Trade Policy*. Cambridge: MIT, pp. 89-127.
- Feenstra, Robert and Gordon Hanson (1996). "Globalization, Outsourcing, and Wage Inequality". *American Economic Review*; V.86-#2, pp. 240-245.
- Feenstra, Robert and Gordon Hanson (1997). "Foreign Direct Investment and Relative Wages: Evidence from Mexico's Maquiladoras". *Journal of International Economics*; V.42-#3/4, pp. 371-393.
- Francois, Joseph (1990a). "Trade in Producer Services and Returns Due to Specialization under Monopolistic Competition". *Canadian Journal of Economics*; V.23-#1, pp. 109-124.
- Francois, Joseph (1990b). "Producer Services, Scale, and the Division of Labor". *Oxford Economic Papers*; V.42-#4, pp. 715-729.
- Francois, Joseph and Douglas Nelson (1998). "A Geometry of Specialization". *Tinbergen Institute Discussion Paper*, #97-006/2.

Freeman, Richard and Lawrence Katz (1991). "Industrial Wage and Employment Determination in an Open Economy". in J. Abowd and R. Freeman, eds. *Immigration, Trade and Labor Markets*. Chicago: University of Chicago Press, pp. 235-259.

Gaston, Noel and Douglas Nelson (1998). "Trade and Wages in OECD Countries: Linking Theory and Evidence". forthcoming in *Globalisation and Employment Patterns: Policy, Theory and Evidence*. New York: Oxford: Oxford University Press, forthcoming.

Gaston, Noel and Daniel Trefler (1995). "Union Wage Sensitivity to Trade and Protection: Theory and Evidence". *Journal of International Economics*; V.39-#1/2, pp. 1-25.

Gottschalk, Peter and Timothy Smeeding (1997). "Cross-National Comparisons of Earnings and Income Inequality". *Journal of Economic Literature*; V.35-#2, pp. 633-687.

Helpman, Elhanan (1984). "A Simple Theory of International Trade With Multinational Corporations", *Journal of Political Economy*, V.92-#3, pp. 451-471.

Helpman, Elhanan (1985). "Multinational Corporations and Trade Structure". *Review of Economic Studies*; V.52-#3, 443-447.

Horstmann, Ignatius and James Markusen (1991). "Multinational Firms, Technology Diffusion and Trade". *NBER Working Paper*, #3825.

Horstmann, Ignatius and James Markusen (1992). "Endogenous Market Structures in International Trade (natura facit saltum)". *Journal of International Economics*; V.32-#1/2, pp. 109-129.

Hymer, Stephen (1960, 1976). *The International Operation of National Firms: A Study of Direct Foreign Investment*. Cambridge: MIT Press.

Jones, Ronald and Fumio Dei (1983). "International Trade and Foreign Investment: A Simple Model". *Economic Inquiry*; V.21-#4, pp. 449-464.

Kosters, Marvin (1994). "An Overview of Changing Wage Patterns in the Labor Market". In J. Bhagwati and M. Kosters, eds. *Trade and Wages: Leveling Wages Down?* Washington, DC: AEI, pp. 1-35.

Krugman, Paul (1980). "Scale Economies, Product Differentiation, and the Pattern of Trade". *American Economic Review*; V.70-#5, pp. 950-959.

Krugman, Paul (1981). "Intraindustry Specialization and the Gains from Trade". *Journal of Political Economy*; V.89-#5, pp. 959-974.

- Krugman, Paul (1995). *Development, Geography, and Economic Theory*. Cambridge: MIT Press.
- Leamer, Edward (1998). "In Search of Stolper-Samuelson Linkages between International Trade and Lower Wages". in Collins, ed., pp. 141-214.
- Levy, Frank and Richard Murnane (1992). "U.S. Earnings Levels and Earnings Inequality: A Review of Recent Trends and Proposed Explanations". *Journal of Economic Literature*; V.30-#3, pp. 1333-1381.
- Lipsey, Richard (1994). "Foreign-Owned Firms and US Wages". *NBER Working Paper #4927*.
- Machlup, Fritz, Walter Salant and Lorie Tarshis, eds. (1972) *International Mobility and Movement of Capital*; New York: Columbia University Press/NBER.
- Markusen, James (1984). "Multinationals, Multi-plant Economies and the Gains from Trade", *Journal of International Economics*, V.16-#3/4, pp. 205-226.
- Markusen, James (1990). "Micro-Foundations of External Economies". *Canadian Journal of Economics*; V.23-#3, pp. 495-508.
- Markusen, James (1995). "The Boundaries of Multinational Enterprises and the Theory of International Trade". *Journal of Economic Perspectives*; V.9-#2, pp. 169-189.
- Markusen, James and Anthony Venables (1998). "Multinational Firms and the New Trade Theory". *Journal of International Economics*; V.46-#2, pp. 183-203.
- Markusen, James and Anthony Venables (1996a). "Multinational Production, Skilled Labor, and Real Wages". *NBER Working Paper #5483*.
- Markusen, James and Anthony Venables (1996b). "The Increased Importance of Direct Investment in North Atlantic Relationships: A Convergence Hypothesis". in M. Canzoneri, W. Ethier, and V. Grilli, eds. *The New Transatlantic Economy*. New York: Cambridge/CEPR, pp. 169-189.
- Markusen, James and Anthony Venables (1996c). "The Theory of Endowment, Intraindustry, and Multinational Trade". *NBER Working Paper #5529*.
- Markusen, James and Anthony Venables (1997). "The Role of Multinational Firms in the Wage-Gap Debate". *Review of International Economics*; V.5-#4, pp. 435-451.
- OECD (1997). "Trade, Earnings and Employment: Assessing the Impact of Trade with Emerging Economies on OECD Labour Markets". *OECD Employment Outlook*, July 1997, pp. 93-128.

Riker, David and S. Lael Brainard (1997). "U.S. Multinationals and Competition from Low Wage Countries". *NBER Working Paper*, #5959.

Romer, Paul (1987). "Growth Based on Increasing Returns to Specialization". *American Economic Review*; V.77-#2, pp. 56-62.

Slaughter, Matthew (1997). "Multinational Corporations, Outsourcing, and American Wage Divergence". *NBER Working Paper*, #5253.

Slaughter, Matthew (1998). "What are the Results of Product-Price Studies and What Can we Learn from Their Differences?". ms: Dartmouth College.

Spence, A. Michael (1976). "Product Selection, Fixed Costs and Monopolistic Competition". *Review of Economic Studies*; V.43-#2, pp. 217-235.

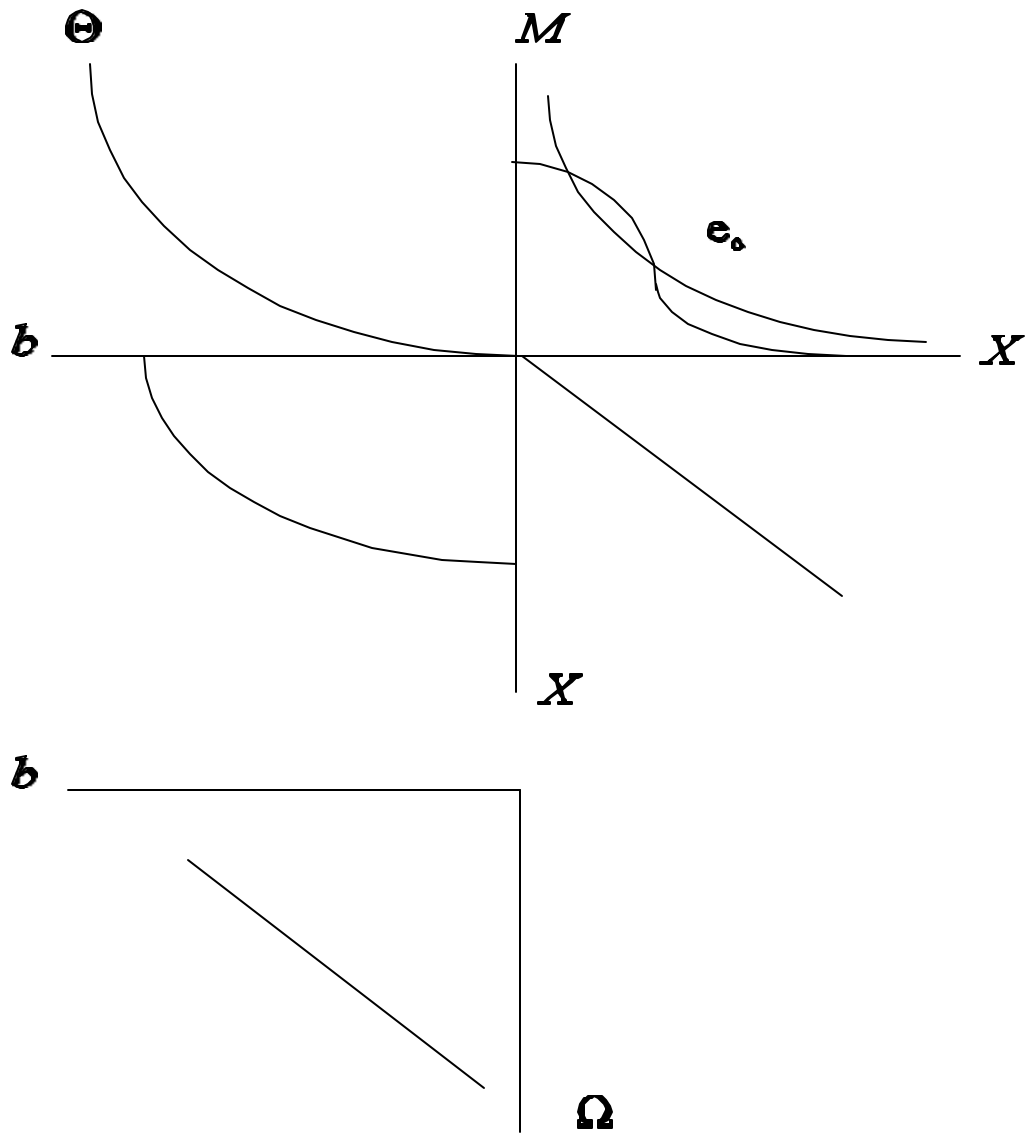
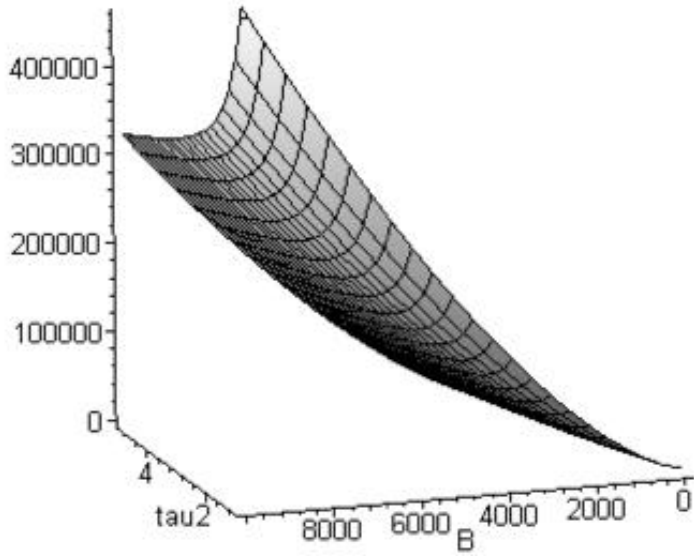

Figure 1

Figure 2



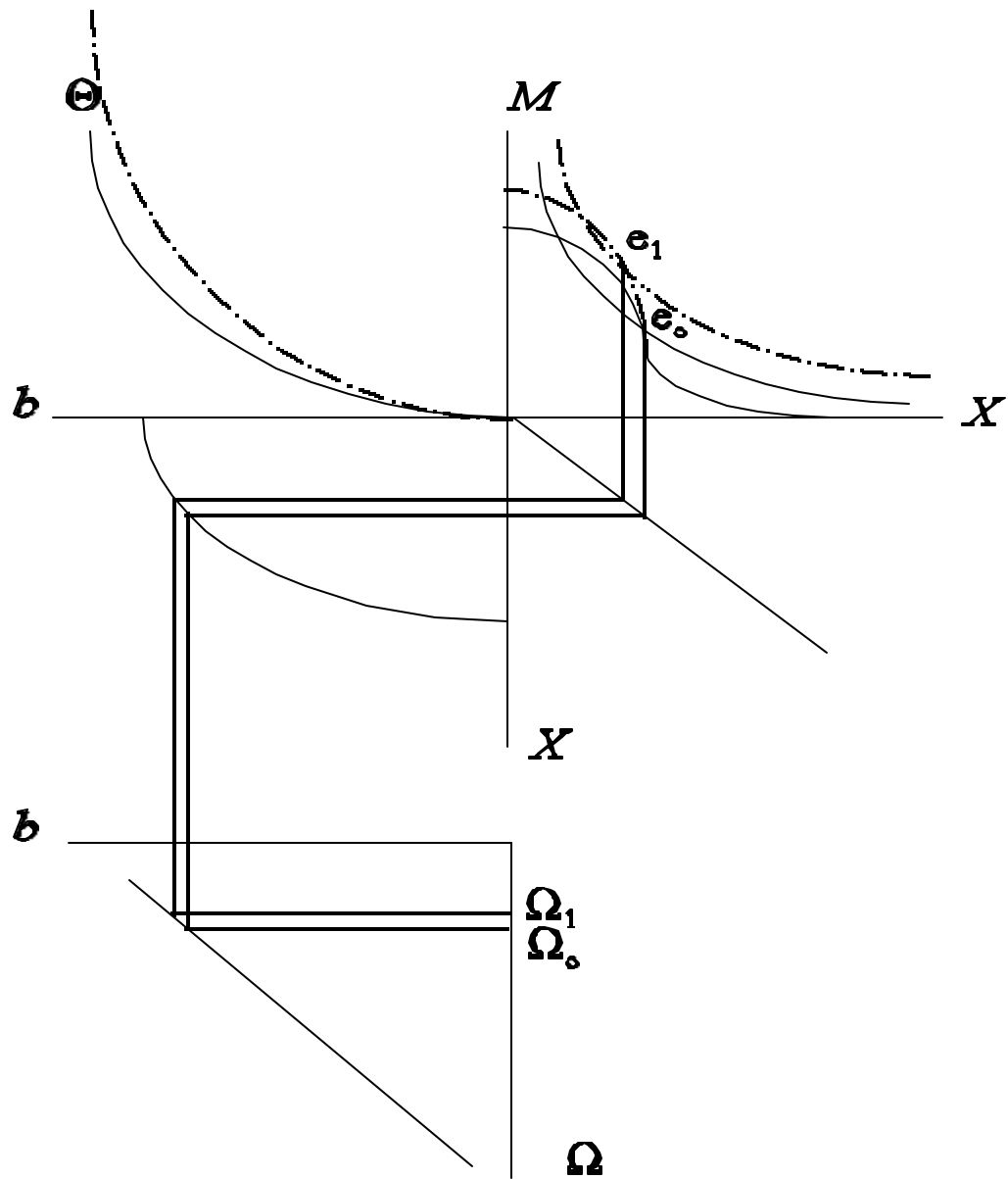

Figure 3

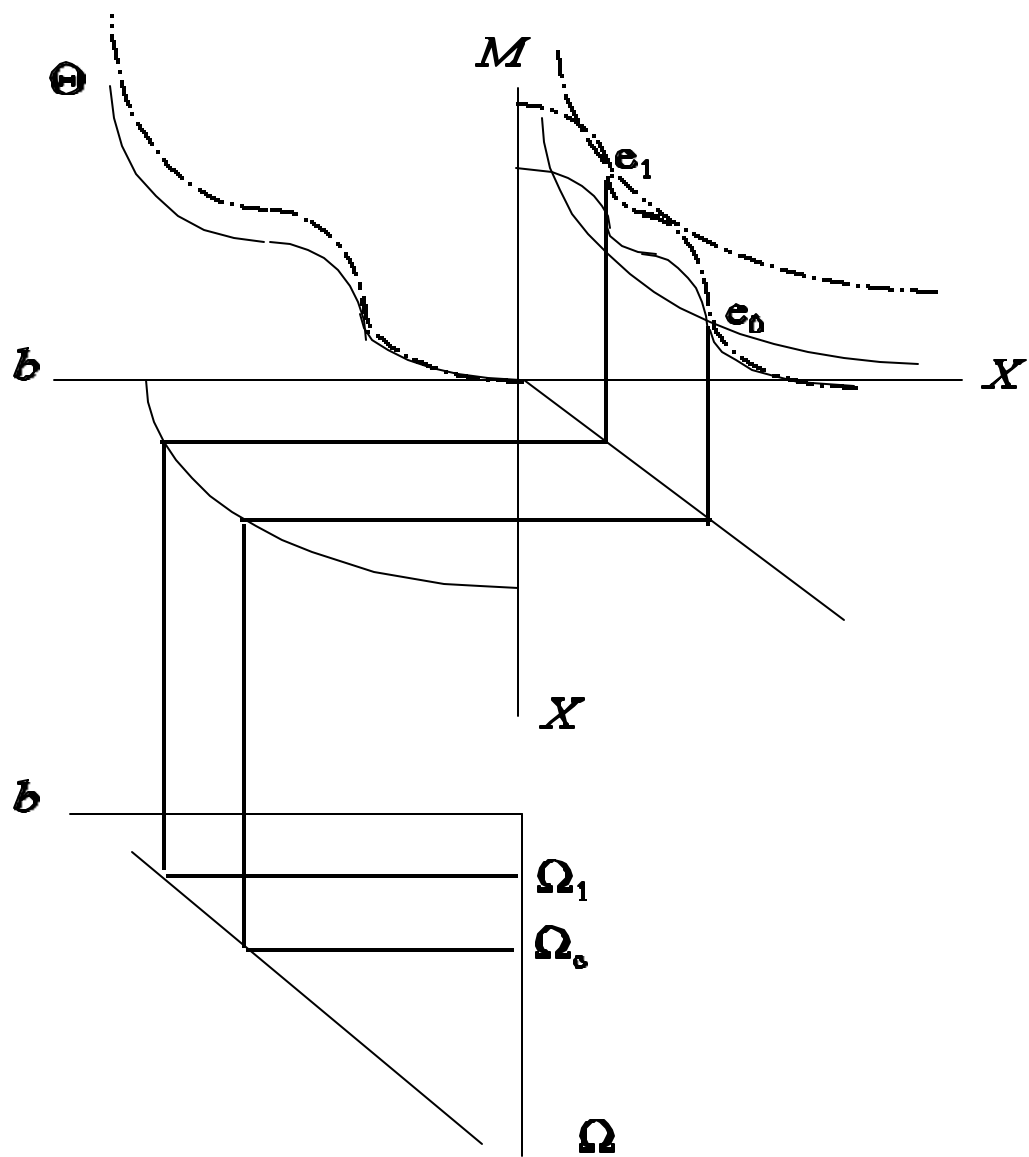

Figure 4

Appendix:

In this appendix we discuss the properties of the Theta function for the model. The Theta function maps the transformation of factor bundles into composite goods for the sector subject to scale economies from specialization.

The Integrated economy :

The basic mapping for the integrated/autarky economy depends on the following relationships:

costs:

$$C_i = (m_i^z + q_i)P_b$$

elasticity of demand:

$$\varepsilon = \sigma + (1 - \sigma)/n$$

average cost pricing:

$$P_i = (m_i^{\zeta-1} + q_i m_i^{-1})P_b$$

monopoly pricing:

$$(1 - 1/\varepsilon)P_i = \zeta m_i^{\zeta-1}P_b$$

full employment:

$$n = b/(m_i^{\zeta} + q_i)$$

CES aggregator for a symmetric equilibrium:

$$M = n^{\frac{\sigma}{\sigma-1}} m_i$$

In the above equations, $\sigma > 1$ is the elasticity of substitution between varieties, $1 > \zeta > 0$ captures scale effects, q_i is a measure of fixed costs (in units of factor bundles), P_b is the price of factor bundles B , P_i is the (identical) price of variety i , m_i is the quantity supplied of variety i , and n is the number of identically sized firms.

From these relationships, we can derive the following relationship between the resource allocation to the M sector (measured in units of b) and the M itself, $M = \Theta(b)$.

$$M = \Theta(b) = \left(\frac{b}{\frac{1}{2} \frac{\xi q_i - \sigma b + b - 2q_i - \xi \sigma q_i + 2\sigma q_i + \xi \sigma b + A1}{A2} + q_i} \right)^{\frac{\sigma}{\sigma-1}} \times \left(\frac{1}{2} \frac{\xi q_i - \sigma b + b - 2q_i - \xi \sigma q_i + 2\sigma q_i + \xi \sigma b + A1}{A2} + q_i \right)^{\frac{1}{\sigma}}$$

$$\text{or} = \left(\frac{b}{\frac{1}{2} \frac{\xi q_i - \sigma b + b - 2q_i - \xi \sigma q_i + 2\sigma q_i + \xi \sigma b - A1}{A2} + q_i} \right)^{\frac{\sigma}{\sigma-1}} \times \left(\frac{1}{2} \frac{\xi q_i - \sigma b + b - 2q_i - \xi \sigma q_i + 2\sigma q_i + \xi \sigma b - A1}{A2} + q_i \right)^{\frac{1}{\sigma}}$$

where

$$A1 = [\xi^2 \sigma^2 b^2 + \xi^2 \sigma^2 q_i^2 + 2\xi \sigma b^2 - 2\xi \sigma b^2 - 2\xi^2 \sigma q_i^2 - 2\xi b q_i + 2\xi^2 b q \sigma + 2\xi b q \sigma^2 - 2\xi^2 b q \sigma^2 + \xi^2 q_i^2 + \sigma^2 b^2 - 2\sigma b^2 + b^2]^{\frac{1}{2}}$$

$$A2 = 1 + \xi \sigma - \sigma - \xi$$

From computational analysis, only one of these relationships is relevant for most parameter value, with a mapping from B to M as illustrated below in Figure A.1 (for $\sigma=3$, $\xi=0.85$, $q_i=1$). A case of both mappings being relevant is illustrated in Figure A.2 (for $\sigma=2$, $\xi=0.5$, $q_i=1$). A case where both exist, but only one is relevant, is mapped in Figure A.3 (for $\sigma=1.5$, $\xi=0.5$, $q_i=1$). In the paper itself, we work with unique positive mappings, like those in Figures A.1 and A.3). Figure 2 in the text is based on Figure A.1, for a range of trading costs.

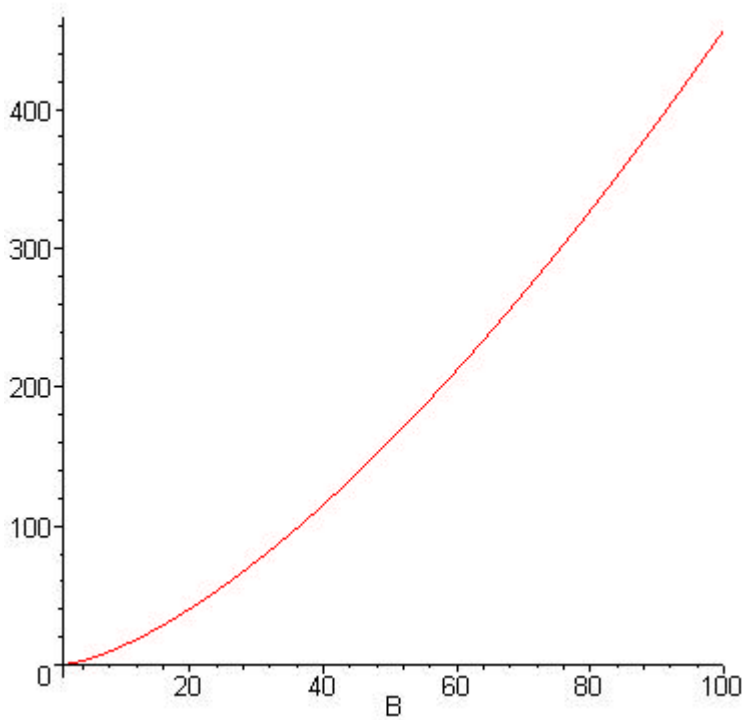

Figure A.1

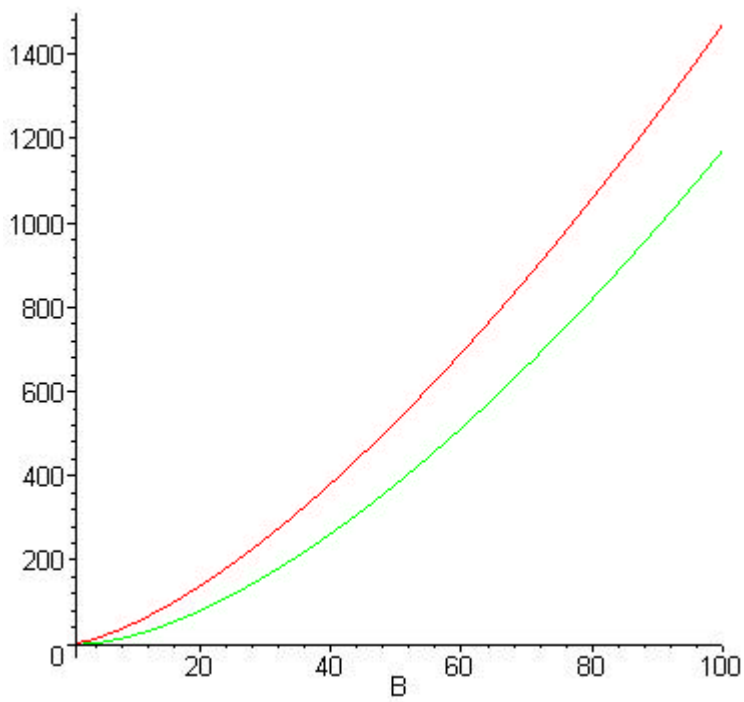

Figure A.2

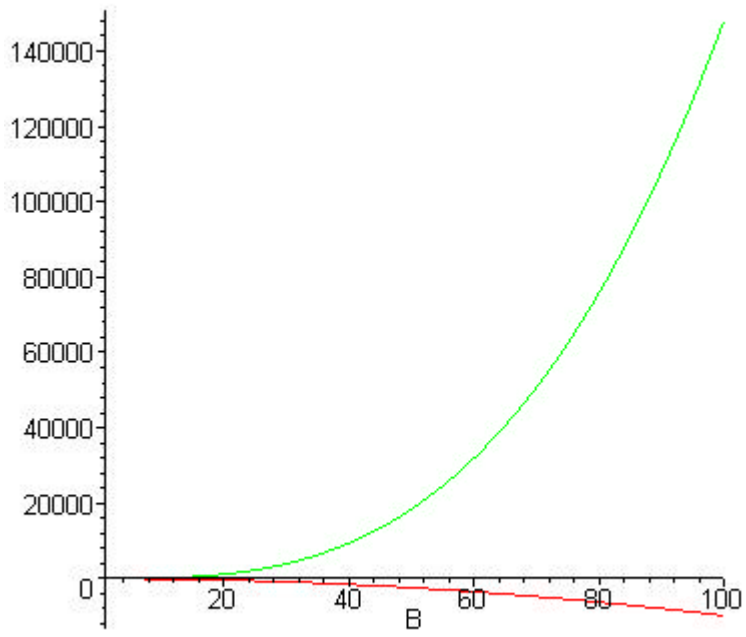

Figure A.3