

Sutherland, Holly; Decoster, André; Matsaganis, Manos; Tsakloglou, Panos

Working Paper

Accurate income measurement for the assessment of public policies: Final report

EUROMOD Working Paper, No. EM7/09

Provided in Cooperation with:

Institute for Social and Economic Research (ISER), University of Essex

Suggested Citation: Sutherland, Holly; Decoster, André; Matsaganis, Manos; Tsakloglou, Panos (2009) : Accurate income measurement for the assessment of public policies: Final report, EUROMOD Working Paper, No. EM7/09, University of Essex, Institute for Social and Economic Research (ISER), Colchester

This Version is available at:

<https://hdl.handle.net/10419/64877>

Standard-Nutzungsbedingungen:

Die Dokumente auf EconStor dürfen zu eigenen wissenschaftlichen Zwecken und zum Privatgebrauch gespeichert und kopiert werden.

Sie dürfen die Dokumente nicht für öffentliche oder kommerzielle Zwecke vervielfältigen, öffentlich ausstellen, öffentlich zugänglich machen, vertreiben oder anderweitig nutzen.

Sofern die Verfasser die Dokumente unter Open-Content-Lizenzen (insbesondere CC-Lizenzen) zur Verfügung gestellt haben sollten, gelten abweichend von diesen Nutzungsbedingungen die in der dort genannten Lizenz gewährten Nutzungsrechte.

Terms of use:

Documents in EconStor may be saved and copied for your personal and scholarly purposes.

You are not to copy documents for public or commercial purposes, to exhibit the documents publicly, to make them publicly available on the internet, or to distribute or otherwise use the documents in public.

If the documents have been made available under an Open Content Licence (especially Creative Commons Licences), you may exercise further usage rights as specified in the indicated licence.

EUROMOD

WORKING PAPER SERIES

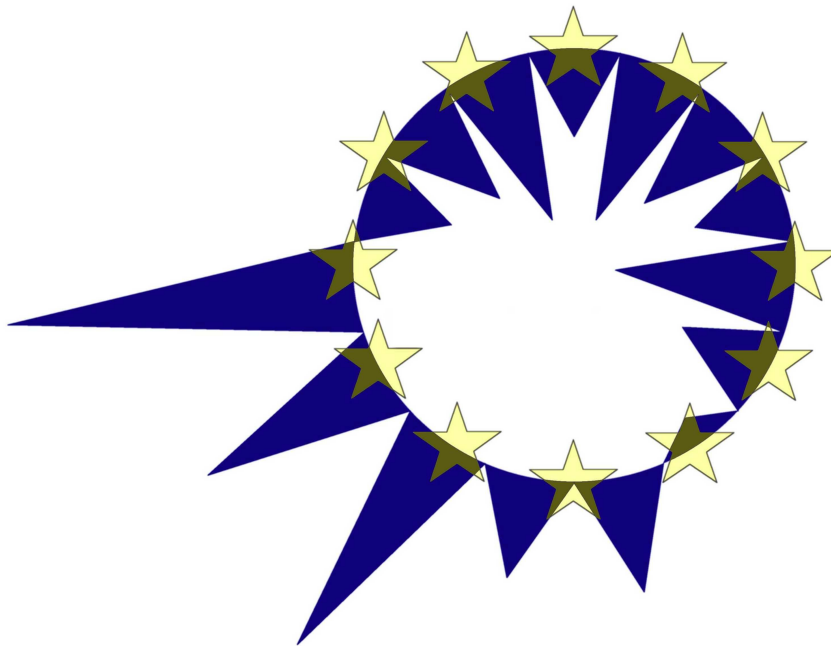

EUROMOD Working Paper No. EM7/09

ACCURATE INCOME MEASUREMENT
FOR THE ASSESSMENT OF PUBLIC POLICIES
FINAL REPORT

Holly Sutherland, André Decoster, Manos
Matsaganis and Panos Tsakloglou

October 2009

ACCURATE INCOME MEASUREMENT FOR THE ASSESSMENT OF PUBLIC POLICIES – FINAL REPORT[§]

Holly Sutherland^{*}, André Decoster⁺, Manos Matsaganis[†] and Panos Tsakloglou[‡]

^{*} AIM-AP coordinator; *Institute for Social and Economic Research, University of Essex*

⁺ Leader of the project on indirect taxes and author of section 4; *University of Leuven*

[†] Leader of the project on measurement error, tax evasion and target inefficiency and author of section 3; *Athens University of Economics and Business*

[‡] Leader of the project on non-cash incomes and author of section 2; *Athens University of Economics and Business*

with

Olivier Bargain, Tim Callan, Conchita D'Ambrosio, Francesco Figari, Darragh Flannery, Maria Flevotomou, Joachim Frick, Michael Fuchs, Chiara Gigliarano, Tim Goedemé, Markus Grabka, Olaf Groh-Samberg, Philip Hayes, Herwig Immervoll, Markus Jäntti, Claire Keane, Christos Koutsambelas, Stijn Lefebure, Orsolya Lelkes, Horacio Levy, Jason Loughrey, Mattia Makovec, Daniela Mantovani, Killian Mullan, Cathal O'Donoghue, Kristian Orsini, Alari Paulus, Bram de Rock, Timothy Smeeding, Kris de Swerdt, Stefano Toso, Gerlinde Verbist, Dirk Verwerft, Heikki Vittamäki, Klaas De Vos and Francesca Zantomio.

Note

This paper is an adapted version of the substantive part of the **Final Report** to the European Commission of the project “*Accurate Income Measurement for the Assessment of Public Policies (AIM-AP)*”, under Priority 7 *Citizens and Governance in a Knowledge-based Society* of Framework Programme 6 [Project no. 028412]. We gratefully acknowledge this funding and the support of our Project Officer, Ian Perry.

[§] We are grateful for access to the following datasets: the EU Statistics in Incomes and Living Conditions (SILC) made available by Eurostat; the Greek Household Budget Survey by the National Statistical Service of Greece; a sample of Greek 2005 income tax data to the (Greek) General Secretariat of Information Systems; the Living in Ireland Survey by the Economic and Social Research Institute; the Austrian SILC by Statistics Austria; the Italian SILC by ISTAT; the "indagine sui bilanci delle famiglie italiane" by Banca d'Italia; the Belgian, Hungarian and Irish Household Budget Surveys through their respective National Statistical Offices; the Panel Survey on Belgian Households (PSBH) by the University of Liège and the University of Antwerp; the Income Distribution Survey by Statistics Finland; the German Socio Economic Panel Study (GSOEP) by the German Institute for Economic Research (DIW Berlin), Berlin; and the Socio-Economic Panel Survey (SEP) by Statistics Netherlands through the mediation of the Netherlands Organisation for Scientific Research - Scientific Statistical Agency. The Family Resources Survey (FRS) was made available by the UK Department of Work and Pensions (DWP) and the Expenditure and Food Survey (EFS) by the UK Office for National Statistics, both through the UK Data Archive. Material from the FRS and EFS is Crown Copyright and is used by permission. The DWP, the ONS and the Data Archive bear no responsibility for the analysis or interpretation of the data reported here. An equivalent disclaimer applies for all other data sources and their respective providers cited in this acknowledgement.

Contents

1. Introduction.....	2
2. The distributional effects of non-cash incomes	3
3. Measurement error, tax evasion and target inefficiency	17
4. Incorporation of the effects of indirect taxes	34
5. AIM-AP results in combination.....	46
6. Project papers and other references	53

1. Introduction

The AIM-AP research programme was established to improve the comparability, scope and applicability of tools, methods and data for the measurement of income and the analysis of the effects of policies on inequality, poverty and social inclusion. It included three linked projects.

1. **The distributional effects of non-cash incomes and the implementation of a more comprehensive income definition.** The aim was to investigate the distributional effects of the following non-cash income components: public education, imputed rents for owner occupied accommodation and public housing, public health care services and home production and employer-provided fringe benefits. The execution of this part of AIM-AP is described in section 2.
2. **The implications of (and methods to account for) errors in targeting social benefits, tax evasion and measurement error in income data** This project relied on a series of national case studies to explore the implications of tax evasion and target inefficiency for measures of income distribution and the impact of tax-benefit policies. The likely presence of measurement error complicates matters considerably and was considered where possible. This part of AIM-AP is described in section 3.
3. **Incorporation of the effects of indirect taxes, along with direct taxes and social benefits, in redistribution analysis** The aim was to develop a generic method of imputation of detailed household expenditures into income surveys for a selected set of EU countries. This permits comparative research on the incidence and distributional analysis of the combined set of policy instruments: direct taxes, benefits, and indirect taxes. The work done under this heading is described in section 4.

All three projects were designed to improve the degree of comparability of measurement and analysis across countries. Each project developed methodologies within a cross-national perspective and some cross-project results are combined, as described in section 5. Where appropriate, the resulting data and method enhancements are being made generally accessible and re-useable by implementing them within EUROMOD, the EU tax-benefit model.¹

¹ For more information about EUROMOD see <http://www.iser.essex.ac.uk/research/euromod/>

2. The distributional effects of non-cash incomes²

In developed countries, about half of welfare state transfers consist of in kind benefits such as education, health insurance, child care, elderly care and other services. In kind as well as cash transfers reduce inequalities in standards of living as documented in research within selected countries but only occasionally cross nationally or for a large set of rich countries [for notable exceptions, see Smeeding et al. (1993) and Marical et al. (2006)].

Besides publicly provided in-kind transfers, there are also substantial private non-cash incomes. One of the most important is imputed rent for owner occupied accommodation. Fringe benefits provided by employers may also be of importance to some households in some countries. Of lesser importance in developed market economies are commodities produced for own consumption or barter without the intervention of the market mechanism. Finally, for an evaluation of the full concept of resources available to the household, one should also take into account home produced and consumed services.

The omission of non-cash incomes from the concept of resources used in distributional studies may call into question the validity of comparisons of distributional outcomes - both time-series comparisons within a particular country and cross-sectional comparisons across countries. For instance, comparing the income distributions of two countries, one where health services are primarily covered by private out-of-pocket payments and another where such services are provided free of charge by the state to the citizens, funded out of taxation or contributions, is likely to lead to invalid conclusions and, perhaps, policy implications.

Existing empirical studies of the distributional effects of both publicly provided and private non-cash incomes using a variety of imputation methods and national or cross-country data sets covering developed countries tend to confirm that non-cash incomes are more equally distributed than monetary incomes.³ The objective of AIM-AP was to analyse in detail the combined distributional effects of imputed rent, public education services and public health care services using common methodologies in roughly similar data sets of seven European countries (Belgium, Germany, Greece, Ireland, Italy, the Netherlands and the United Kingdom), as well as to provide some indications of the likely distributional effects of home production and fringe benefits. Another aim was to incorporate the estimates of imputed rent,

² This section was written by Panos Tsakloglou, the leader of the research in non-cash incomes in AIM-AP.

³ See, for example, Smeeding (1977), O'Higgins and Ruggles (1981), Evandrou et al. (1993), Yates (1994), McLennan (1996), Antoninis and Tsakloglou (2001), Frick and Grabka (2003), Aaberge et al. (2006), Garfinkel et al. (2006), Jones et al. (2008).

public education services and public health care services in the EUROMOD tax-benefit microsimulation model and perform a number of simulations related to these non-cash income components.

2.1. Data and methods

The main guiding principle that is adopted in calculating the monetary value of each of the in-kind transfers and in allocating them to households is to do so in a manner that is comparable across the seven countries considered (although this was not always possible). As far as possible, the micro-data used to provide information on household characteristics and cash income is taken from survey sources that are broadly comparable in terms of methods used to collect them, period in time and content. The national databases used in the analysis and the corresponding reference years are shown in Table 2.1.

Table 2.1. Income data sets used in the analysis

Country	Dataset	Reference year
Belgium (BE)	EU-SILC	2004
Germany (DE)	German Socio-Economic Panel	2002
Greece (EL)	Household Budget Survey	2004
Ireland (IE)	Living in Ireland Survey	2000
Italy (IT)	Italian version of EU-SILC	2004
Netherlands (NL)	Socio-Economic Panel Survey	2001
United Kingdom (UK)	Family Resources Survey	2003

The estimates of inequality and poverty indices derived in the framework of the project rely on static incidence analysis under the assumption that non-cash incomes (and, in particular, public transfers in-kind) do not create externalities. No dynamic effects are considered in the analysis. In other words, it is assumed that the recipients of these incomes and the members of their households are the sole beneficiaries and that these non-cash income components do not create any benefits or losses for the non-recipients. Moreover, in the cases of public education and public health care it is assumed that the value of the transfer to the beneficiary is equal to the average cost of producing the corresponding services. Similar assumptions are standard practice in the analysis of the distributional impact of publicly provided services [Smeeding et al. (1993), Marical et al. (2006)]. The following paragraphs describe briefly how the estimates of non-cash income were derived for each of the three main components

considered (imputed rent, public education and public health care). Issues related to home production and fringe benefits are discussed in the box at the end of section 2.

2.1.1 Imputed rents

Due to data limitations, it was not possible to apply the same methodology to all seven countries involved in the project. For more information see Frick, Grabka, Smeeding and Tsakloglou (2007). In five of the countries (Belgium, Germany, Greece, Italy and UK) the “rental equivalence” (or “opportunity cost”) method was applied. There are three stages in its implementation. First, a regression model is estimated with rent (per square meter or per room) as dependent variable based on the population of tenants in the private, non-subsidized market, while the explanatory variables include a wide range of characteristics of the dwelling, occupancy, and so on. Then, the resulting coefficients are applied to otherwise similar owner-occupiers and tenants paying below-market rent. The estimates thus derived refer to the gross imputed rent. In order to derive estimates of the net imputed rent that can be used for cross-country comparisons, mortgage interest payments (in the case of owner occupiers) and actual rent paid (in the case of tenants paying below market rent) and operating and maintenance costs (for both groups) are subtracted from the gross imputed rent estimate.

In the datasets used in the cases of Ireland and the Netherlands, insufficient information on (market) rents of tenant households was available and, hence, the above method could not be applied. However, in both data sets self-reported information was available on the market value of the accommodation. Therefore, estimates of imputed rent were derived by applying a country-specific interest rate to the market value of the accommodation. Unfortunately, this implies that there is no imputed rent measure for (subsidized) tenants in those two countries, which clearly reduces cross-country comparability of the distributional effects of imputed rent. For this reason many of the comparisons are confined to the five countries with sufficient information on market rent.

The cross-country variation in the proportion of households benefiting from imputed rent is enormous. In all countries except Germany the majority of the population lives in households enjoying the benefits of imputed rents of some kind. Over 90% of the Irish population lives in households enjoying positive imputed rents. The corresponding figure is around 80% in Italy, Greece and the UK, between 60% and 65% in Belgium and the Netherlands and only 45% in

Germany. This pattern is mainly driven by the proportions of owner occupier households but also by the prevalence of subsidized social housing within the rental sector.

2.1.2 Public education

Information on spending per student in primary, secondary and tertiary education is derived from OECD's "Education at a glance 2006". Each student in a public education institution (or a heavily subsidized private education institution) identified in the income survey is assigned a public education transfer equal to the average cost of producing these services in the corresponding level of education. Then, this benefit is assumed to be shared by all household members. In other words, it is implicitly assumed that in the absence of public transfers the students and their families would have to undertake the expenditures themselves. Because of limitations on the information available on education in some of the income surveys we focus on three levels of education (primary, secondary and tertiary), thus leaving aside other levels such as pre-primary and non-tertiary post-secondary education and suppressing distinctions, such as those between general and technical secondary education, as well as Type A and Type B tertiary education which may be important in some countries. R&D expenditures are not included in the benefit received by tertiary education students, since it is assumed that the students are not the primary beneficiaries of this type of public spending. See Callan, Smeeding and Tsakloglou (2007; 2008) for more information.

In each country the beneficiaries of education (all levels considered together) are underrepresented at the top of the income distribution and overrepresented in the three lowest quintiles. There is some variation across countries when each level of education is considered separately. For example, in Belgium, the beneficiaries of public primary education transfers appear to be fairly evenly distributed across quintiles, while in the rest of the countries they seem to be disproportionately concentrated in the three bottom quintiles and substantially underrepresented in the top quintile. Generally, the patterns may be attributed to the combined effect of two factors. The first is demographics: for example, households with young children are less likely to have reached the top of their earnings capacity and/or have a lower share of earners and, hence, are more likely to be concentrated in the lower quintiles. The second factor has to do with participation in two respects. On the one hand young people may not take part in non-compulsory education (or may drop out of compulsory education) and on the other hand they may be in private education, not benefiting (directly) from public provision.

2.1.3 Public health care

With respect to public health care services, the risk-related “insurance value approach” was adopted. More specifically, the ‘insurance value’ is the amount that an insured person would have to pay in each category (in our case, narrowly defined age group) so that the third party provider (government, employer, other insurer) would have just enough revenue to cover all claims for such persons. It is based on the notion that what the public health care services provide is equivalent to funding an insurance policy where the value of the premium is the same for everybody sharing the same characteristics, such as age. Then, this value is added to the resources of each individual belonging to a particular group with the predefined characteristic(s) and, correspondingly to his/her household.

We calculated per capita expenditures for each age group using the OECD Social Expenditure database (SOCX), which provides data that are comparable across countries. Spending per capita is considerably higher for older people in all countries considered, which is reflected in the empirical results of our analysis. For a more detailed discussion see Smeeding, Tsakloglou and Verbist (2008).

For the purposes of the empirical analysis, the non-cash income components are added to the concept of resources of the baseline distribution (distribution of disposable monetary income) and comparisons are made. In order to take into account household economies of scale and differences in needs between adults and children, in both cases, the total household resources are divided by the household equivalence scale and the resulting figure is assigned to all household members. Following Eurostat, the equivalence scale used assigns a weight of 1.0, 0.5 and 0.3 to the household head, each of the remaining adults (aged 14+) and each child in the household, respectively.

2.2. Empirical results

Table 2.2 reports the monetary value of the three non-cash income components as a proportion of the total disposable income of the population in the seven countries under consideration. As noted above, the estimates of imputed rent for Ireland and the Netherlands are not strictly comparable with those of the other countries and, hence, are reported in italics.

When the three non-cash incomes are put together, the effects are substantial but the cross country differences are not very large.⁴ In Greece and the Netherlands they add up to around

⁴ For a longer discussion of the effects of combinations of non-cash incomes see Tsakloglou et al. (2009)

28% of disposable income, in Germany and the UK a little below 31%, in Ireland and Italy a little above 33% and in Belgium 36%. In each country public healthcare plays the largest role but otherwise there is more variation between countries in the individual components, than in the three combined. For example, public education is particularly important in Belgium, where the amounts spent per student are relatively high, and imputed rent is important in Greece and Italy (with high shares of owner occupiers).

Table 2.2. Non-cash income components as a proportion of total disposable income %

Country	Imputed Rent	Public Education	Public Health Care	All
Belgium (BE)	6.0	13.2	16.3	35.5
Germany (DE)	7.2	7.2	16.5	30.9
Greece (EL)	11.1	7.2	10.3	28.6
Ireland (IE)	9.3	11.9	12.2	33.4
Italy (IT)	10.6	9.5	13.7	33.8
Netherlands (NL)	6.1	10.6	11.2	27.9
United Kingdom (UK)	7.9	10.2	12.7	30.8

The distribution of the non-cash incomes across the distribution of cash income is shown in Figure 2.1, where members of the populations are grouped according to quintiles of their equivalised disposable income. The pattern is relatively similar across countries. Non-cash incomes appear to be fairly evenly distributed across quintiles, at least in four of the countries examined here (Belgium, Germany, Greece and Italy). In the Netherlands and, to a lesser extent, in the UK and Ireland non-cash incomes accrue more to the poorer rather than the richer quintiles. Looking at the three individual non-cash income components it can be observed that in absolute terms in all countries the share of imputed rent is higher in the richer rather than the poorer deciles. The opposite is true for public education and public health care services. When viewed in relative rather than absolute terms, the proportional effect of non-cash incomes is of course greater for those with lower incomes and the extent this is so depends on the inequality in the distributions of disposable income. The monetary value of the three non-cash income components taken together as a share of the poorest quintile's disposable income varies between 65% (the Netherlands) and 87% (Italy). The corresponding figures for the top quintile are 13.7% (UK) and 19.5% (Belgium). Non cash incomes add proportionally more to the bottom quintiles than they do to top incomes in all countries but the effect is greater in the UK, Greece, Italy and Ireland, countries with relatively high inequality of disposable incomes.

Figure 2.1. Distribution of non-cash income components across quintiles (as % of total monetary income)

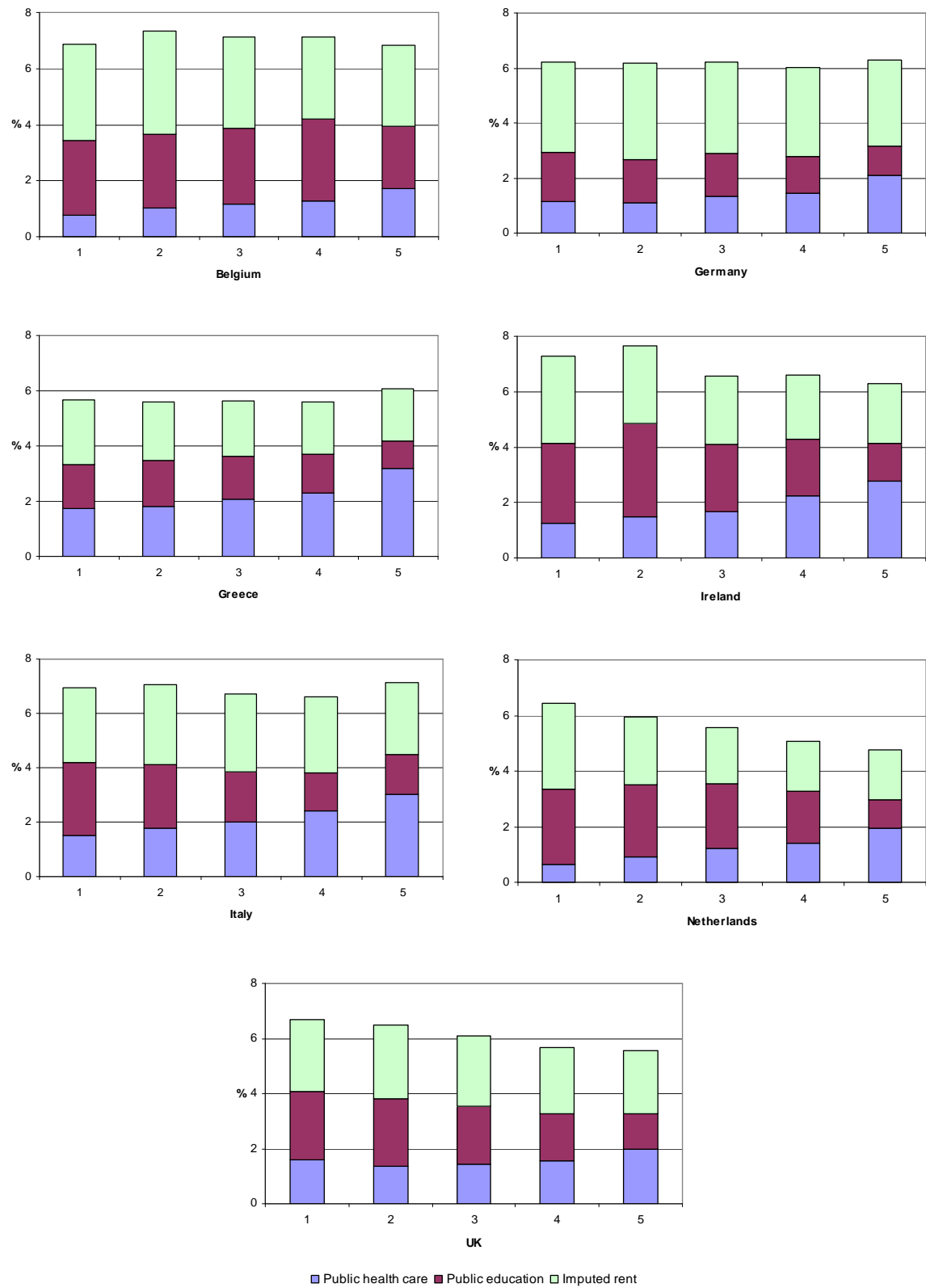

In relative terms, public healthcare and education increase the income share of the poorer rather than the richer quintiles to a greater extent than does imputed rent. The effect on a selection of inequality indices of the inclusion of non-cash incomes in the concept of resources is illustrated in Figure 2.2. The effect is to reduce the values of the indices very substantially: for example the value of the Gini index declines by between 19% (Greece) and 23% (UK). Generally, the proportional changes in the values of the indices are relatively larger in Belgium, UK, Netherlands and Ireland than in Germany, Greece and Italy.

Figure 2.2. Proportional changes in inequality after the inclusion of non-cash income components in the concept of resources

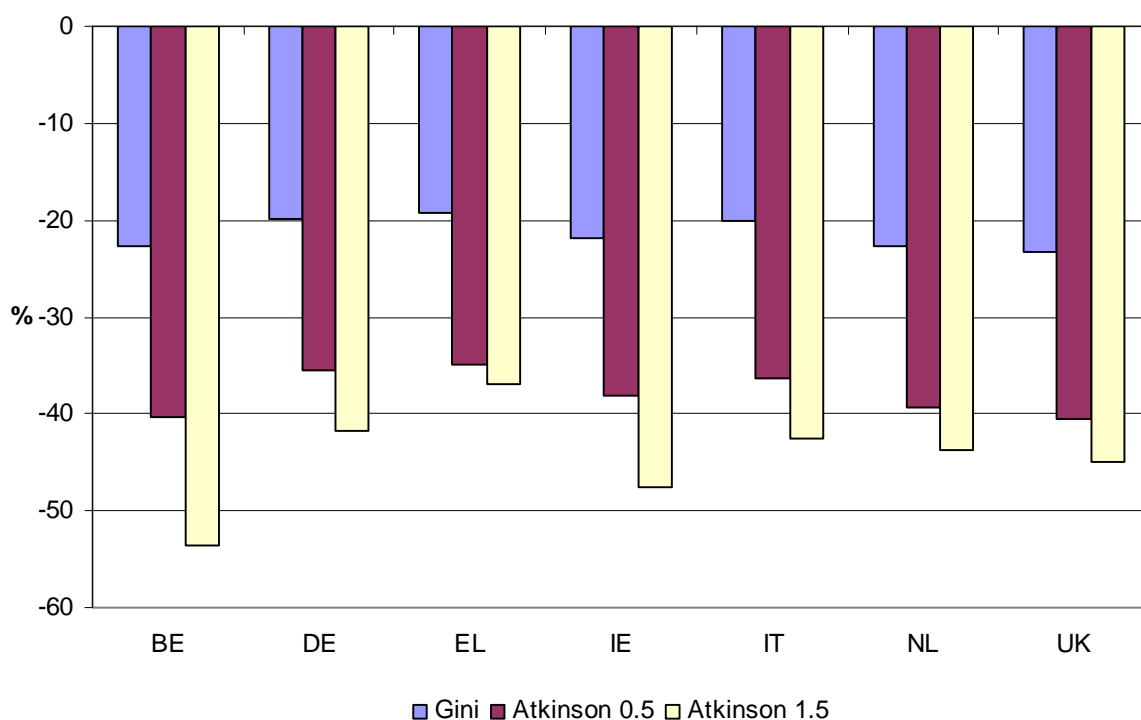

A similar pattern of reduction in relative poverty is observed. Indeed the proportional effect is larger. For example, the poverty rate (using 60% of median of the corresponding distribution as the poverty threshold) declines by between 38% in Italy and 56% in the Netherlands.

Whether in the inclusion of non-cash incomes leads to a re-ranking of the countries regarding their levels of inequality and poverty is summarised in Table 2.3. Starting from the upper half of the table, it can be noted that no re-ranking takes place regarding the two countries with the lowest level of inequality (Belgium and the Netherlands). Re-ranking is observed among countries with medium or high levels of inequality. However, even in this case the re-ranking is not very substantial, with countries moving only one rank up or down in the distribution of augmented income compared with their rank in the distribution of disposable monetary

income. There are only two exceptions to this rule: the UK in the case of the Gini index and Ireland in the case of A1.5 (in both cases falling in the inequality ranking by two ranks). Likewise, the evidence reported in the bottom half of Table 2.3 reveals a limited re-ranking of countries in terms of their poverty levels after the addition of non-cash incomes in the concept of resources. Irrespective of the poverty index used, the Netherlands and Belgium remain the countries with the lowest and second lowest levels of poverty, respectively. Below them, there is limited re-ranking, but in most cases by a single rank only. Only the ranks of Ireland in the case of FGT0 and Greece in the case of FGT2 change by two places when we move from the distribution of disposable income to the distribution of augmented income.

Table 2.3. Inequality and poverty re-rankings after the inclusion of non-cash incomes in the concept of resources

Index of inequality or poverty	BE		DE		EL		IE		IT		NL		UK	
	M	A	M	A	M	A	M	A	M	A	M	A	M	A
Gini	2	2	3	4	6	7	4	3	5	6	1	1	7	5
Atkinson0.5	2	2	3	4	5	5	4	3	6	7	1	1	7	6
Atkinson1.5	2	2	3	4	4	5	5	3	7	7	1	1	6	6
FGT0	2	2	3	4	6	6	7	5	5	7	1	1	4	3
FGT1	2	2	3	4	6	6	5	5	7	7	1	1	4	3
FGT2	2	2	4	5	6	4	3	3	7	7	1	1	5	6

M: Distribution of Disposable Monetary Income

A: Distribution of Augmented Income

1: Lowest; 7: Highest

2.3. Welfare interpretation and equivalence scales

The practice adopted in the analysis so far is in line with the analysis of most studies found in the relevant empirical literature, in the sense that the same equivalence scales – in our case the modified OECD scales used by Eurostat – are used for the distribution of disposable income and for the distribution of augmented income. This may be problematic, particularly in the case of the two largest universal non-cash public transfers (public education and public health care) that are also characterized by strong life-cycle patterns. The reason is that these scales are “conditional” on existing external arrangements [Pollak and Wales (1979), Blundell and Lewbel (1991), Radner (1997)]. By introducing free public education and free public health care in the concept of resources in the “augmented” income distribution, we treat them like private commodities to which the households need to devote resources in order to obtain them. Therefore, the equivalence scales should be modified accordingly. This argument does not apply in the case of imputed rent, home production or fringe benefits.

Sutherland and Tsakloglou (2009) report on an alternative approach which involves the modification of the equivalence scale to take into account measures of additional needs as follows. Assuming that y is household disposable income, k is the amount of extra needs of the household members for health and education (or each of them separately), e the OECD equivalence scale and e' the new scale, the following should be valid for the household to remain at the same welfare level:

$$y/e = (y+k)/e'$$

and e' should be equal to

$$e' = e(y+k)/y$$

Crude approximations for additional needs, k were derived and sensitivity tested using OECD data on average spending on public healthcare and education. These values departed from those used to estimate the value of non-cash incomes partly because of the choice of average cost estimate used as the proxy for needs (e.g. using the EU mean cost of healthcare by age group rather than the national value) and partly because, in the case of education some young people might be assumed to have the need without benefiting from the income (e.g. those in private education). Table 2.4 shows the effect of accounting for needs using two sets of assumptions on one inequality index (Gini coefficient) and it is important to note that this is simply an example, taken from many in Sutherland and Tsakloglou (2009). This particular example illustrates how the reduction in inequality due to the addition of non cash incomes (here restricted to the public components) is much smaller if the corresponding additional needs are accounted for. The different assumptions used in scenarios 1 and 2 make a difference, and some residual cross-national differential effects are evident.

Table 2.4 Change in Gini coefficient with addition of non-cash incomes (a) without equivalence scale adjustment (Baseline) and (b) with adjustment (Scenarios 1 & 2)

	Belgium	Germany	Greece	Italy	UK
Baseline	-22.8	-21.2	-16.5	-20.3	-21.0
Scenario 1	-0.9	-2.3	-1.6	-1.4	-1.0
Scenario 2	-0.3	-0.8	-0.1	0.0	-1.1

Baseline: includes public healthcare and education as well as the public component of imputed rent in the augmented income concept; change is relative to cash disposable income; OECD equivalence scale

Scenario 1: as the baseline but the equivalence scale included estimates of needs based on OECD estimates of mean EU per capita spending on healthcare and per student spending on compulsory education

Scenario 2: as scenario 1 but all levels of education included in needs.

It is likely that the approach outlined above can contribute to a better understanding of the distributional effects of non-cash public transfers. At this stage it may still be relatively crude but can be improved in several ways. The two most promising avenues are likely to be in the direction of uncovering variations in the quality of services directed to particular segments of the population and the identification of systematic under/over users of such services.

2.4 Simulating policy reforms using non-cash income estimates

Three simulation exercises related to non-cash incomes were carried out using EUROMOD. The departure point in the first exercise was the fact that most tertiary education graduates are located close to the top of the income distribution and, therefore, this type of public transfer may increase inequality in the long run. Therefore, we experimented with a number of revenue neutral graduate tax simulations. The starting point for the second exercise was the observation that in most developed countries public health care expenditures rise rapidly and many efforts have been undertaken for their containment. Hence, we examined the distributional effects of a number of alternative scenarios regarding the introduction of co-payments for the provision of public health care services. In general, the effects of the introduction of a graduate tax were inequality-reducing, while those of the co-payments regressive. For more information see Figari et al. (2009).

In the third exercise the implications of treating imputed rent from owner occupation as taxable income, while abolishing any existing mortgage interest tax relief were considered. Since the income tax schedule in all countries is progressive, such a change resulted in substantial declines in aggregate inequality (*vis-à-vis* the distribution of disposable monetary income), as shown in Table 2.5. It also involved large increases in tax revenues. If revenue neutrality is imposed, the distributional impact depends on the mechanism used in order to achieve neutrality. If neutrality is achieved through proportional rebates of tax liability, then inequality increases. In contrast, if revenue neutrality is achieved through a non-refundable lump sum tax credit to income taxpayers (with positive tax liabilities), then inequality declines. In all simulations, cross-country differences in the distributional effects are substantial, largely driven by the share of homeowners in the total population as well as their location in the income distribution.

Table 2.5. Proportional changes in inequality (Gini coefficient) as a result of the inclusion of private imputed rent in the concept of taxable income

	Imputed Rent in taxable income	Plus revenue neutrality through	
		proportional rebate	tax credit
Belgium	-2.0%	2.3%	-1.3%
Germany	-1.3%	0.1%	-1.1%
Greece	-1.6%	1.5%	-0.3%
Italy	-1.0%	1.1%	-1.7%
Netherlands	-2.7%	2.6%	-5.0%
UK	-0.6%	0.9%	-0.5%

2.5. Achievement of objectives and possible policy implications

The aim of the project was to provide estimates of the distributional effects of three large non-cash income components (imputed rent, public education and public health care services) in seven European countries, to analyse their distributional effects and incorporate the corresponding estimates in EUROMOD. In the countries under examination – Belgium, Germany, Greece, Ireland, Italy, the Netherlands and the UK – the total monetary value of these non-cash incomes is around one third of the aggregate disposable income of the population. Using static incidence analysis, under the assumption that incomes in-kind do not create externalities, it is shown that non-cash incomes are far more equally distributed than cash incomes and, as a result, their inclusion in the concept of resources leads to considerable reductions in the measured levels of inequality and relative poverty. However, the relative ranking of countries in terms of inequality and/or poverty indicators is affected only marginally as we move from the distribution of disposable monetary income to the augmented income distribution that includes cash as well as non-cash incomes.

Nevertheless, it is doubtful whether results derived using the standard approach in the fields of public education and public health care can have a straightforward welfare interpretation. The reason is that using this approach we incorporate the value of the public services in the concept of household resources but ignore the problem of extra needs of public services recipients. Once these needs are taken into account with appropriate changes in the household equivalence scales used in the analysis, the results regarding these non-cash income components appear to be far more modest and, under particular circumstances may even appear to be inequality-increasing.

The results of a number of simulations using EUROMOD demonstrate clearly that it is both feasible and desirable to incorporate non-cash income components in standard tax-benefit

microsimulation models and, further, they also show that the distributional effects of various policy simulations may change once the non-cash income components are accounted for.

From this point of view, the objectives of the project were undoubtedly achieved. However, the results of the project also have a number of policy implications. First, international organizations or individual researchers interested in making meaningful cross-country or inter-temporal comparisons of inequality or poverty should take into account non-cash as well as cash income components. However, like monetary income components, care should be taken so that non-cash income components are measured in a consistent way across countries or within a particular country over time. As our results show that even seemingly similar data sets may not be as comparable as they appear at first sight.

Regarding imputed rent, care should be taken that the information available in income surveys can be exploited in order to estimate the net imputed rent of all households (in other words, not only information on gross imputed rent of homeowners). In the case of public education transfers, it is important that the income survey used for the distributional analysis provides as detailed as possible information on the actual use of public education services (that is, the survey should allow the identification of private education students as well as contain a detailed breakdown of the educational status of current students). In the case of public health care transfers, it may be desirable to obtain information that can be used in order to identify population members that are likely to underutilize systematically public health care services (for example, private health insurance policy holders). Last but not least, it is important to account for fringe benefits and, particularly, home production of goods and services. Fringe benefits and home production and consumption of commodities are near cash income components and they can be accounted for relatively easily in income surveys. The latter is likely to be very important in the case of the EU when comparisons are made between “old” EU member states with fully commercialized agriculture with some “new” member states with large agricultural sectors and extensive consumption of own production. Accounting for home production of services is more problematic but, undoubtedly, these services improve the welfare of their recipients and should be included in distributional analyses. In order to obtain information on such services, income surveys should include questions on time use – certainly not an easy task. Moreover, methods of evaluation of the time spent on the production of home services are not uncontroversial.

Last but not least, more research effort is needed in two fronts. First, to identify and use appropriate equivalence scales when including public services with strong life-cycle patterns

in distributional analyses. Second, to move beyond static analysis and examine the distributional effects of (private and public) non-cash incomes in a longitudinal framework.

Home production and fringe benefits

Among the aims of AIM-AP was the analysis of the distributional effects of home production and fringe benefits. This aim was only partially achieved, for the reasons outlined below and reported more fully in Tsakloglou (2009).

The items under this general heading can be grouped into four categories: Consumption of own production of commodities, consumption of own production of services, company cars and other fringe benefits. Different methodologies are usually employed for collecting information on these items.

Regarding consumption of own production of commodities (and consumption of commodities obtained through barter, without the intervention of the market), typically such information is collected through Household Budget Surveys. Households are asked detailed questions about quantities consumed and the Statistical Services carrying out the survey apply the relevant prices. Usually, the price applied is the price prevailing in the local market, but this approach may become problematic if there is no local market for such commodities or the existing market is very “thin”.

In the case of company cars and fringe benefits information is usually collected in the framework of Household Budget Surveys or Income Surveys and is self-reported. The imputation of the value of fringe benefits faces similar difficulties as for the consumption of own production. That for company cars uses information collected from respondents on the specific characteristics of the car and its use for private rather than work purposes over a certain period.

Information on consumption of own production of services is typically collected through the use of time use surveys. Household members are asked detailed questions about their use of time in a typical period and then, for the activities for which a market exists the corresponding time used is evaluated in monetary terms. Several important issues arise: how to classify activities as productive (rather than leisure); what should be the maximum proportion of time that can be considered as devoted to productive activities; how to treat the involuntary “leisure” time of the unemployed; what shadow wage to assign to the non-market productive activities.

The information availability regarding these items in the data sets used in the framework of AIM-AP is shown in Table 2.6. It is immediately evident that the extent of information available is not comparable across countries. In two of the national data sets used (Ireland and the Netherlands) there is no such information at all, in two cases there is only information about company cars (Belgium and UK). Only in the Greek data set is there information about consumption of own production of commodities, while only in the Italian and German data sets is there information about time use (and, hence, consumption of own production of services). Therefore, no comparative analysis was possible.

Table 2.6. Information on consumption of own production and fringe benefits in AIM-AP surveys

	Auto- consumption (commodities)	Auto- consumption (services)	Company car	Other fringe benefits
Belgium			+	
Germany		+	+	+
Greece	+		+	+
Ireland				
Italy		+	+	+
Netherlands				
UK			+	

3. Measurement error, tax evasion and target inefficiency⁵

The aim was to improve income measurement by devising methods for adjusting tax-benefit models, and for correcting the underlying datasets, in the light of our research under AIM-AP on measurement error, tax evasion and target inefficiency.

Our point of departure was the observation that most empirical work on the distributional and fiscal impact of changes in social transfers and the tax system, whether conducted for research purposes or short-term forecasts by government departments, relies on the assumption that policy rules are fully adhered to. Of course, because of tax evasion and errors in targeting benefits, this is not the case in the real world.

The implications of the twin phenomena of tax evasion and target inefficiency are quite clear. Low take up, leakage of benefits to ineligible recipients and misreporting of taxable income will distort the intended impact of changes in social transfers and the tax system, and will limit the validity of projections based the assumption of full compliance to policy rules. And yet, the two phenomena are relatively overlooked as policy issues and, with few exceptions, neglected as research topics.

Part of the explanation for this practice must be the intrinsically obscure nature of the phenomena themselves and the sheer difficulty of adapting datasets in order to account for them. In this sense, our research hoped to make a significant contribution to the state of the art, and set new standards to the treatment of tax evasion and target errors in microsimulation.

On a related note, the possible presence of measurement error complicates matters considerably. If incomes earned or social benefits received are recorded inaccurately in surveys, then estimates of tax evasion and take up of social benefits will inevitably be also biased. We therefore begin with a discussion of our research on measurement error.

3.1. Income measurement error

The raw material for most distributional and fiscal analysis of policy changes is an income and/or expenditure survey, such as the various national Household Budget or Family Expenditure Surveys, the European Community Household Panel and, currently, EU-SILC. Systematic misreporting of some income sources, such as capital income, income from self employment or social transfer income, can provide a misleading view of the income

⁵ The author of this section is Manos Matsaganis, leader of the research on targeting errors, tax evasion and measurement error.

distribution and redistribution profiles. This problem is particularly relevant when income distributions (or levels of redistribution) are compared across countries.

In view of the above, the objective of the proposed research was to arrive at a better understanding of the nature and importance of measurement error in income variables. Our ultimate aim was that of elaborating a standardised procedure for correcting income data and adjusting tax-benefit models for the presence of measurement error. Our starting point was to concentrate on one country: Finland. This choice was guided by the fact that Finnish data are particularly suitable for our purposes. In that country, alongside regular income surveys as elsewhere, administrative registers are available as well, providing detailed information on a range of variables of interest, including household incomes and receipt of social benefits. Of course, the disadvantage was that a single country focus did not involve a comparative dimension.

Our research on measurement error and non take up of social benefits in Finland produced three papers. The first paper, by Jäntti (2007), analysed data from wave 3 of the Finnish part of European Community Household Panel (ECHP), conducted in 1996 and referring to incomes earned in 1995. The Finnish ECHP (also known as the Income Distribution Survey) collected information on all income sources from both interviews (as elsewhere) and from registers (as is typical in Finland). More specifically, the Income Distribution Survey drew extensively on various administrative registers to collect income data. Components of factor income were mostly drawn from tax registers. Information about receipt of income transfers was drawn from the government agencies administering each program. Housing allowances are administered by the Social Insurance Institution. The survey contains information on the annual amount of housing allowances received by every household member along with the number of months during which these were received.

The paper found that entitlement to housing allowances is a complex non-linear function of the true resources, structure and housing costs of a household. As a result of that, the appropriate approach to non take up would be to tackle head-on the issue of measurement errors, modelling the full likelihood of the observed data and using repeated measurements of the underlying true variables in order to identify the parameters that determine that likelihood. The paper concluded that while in principle access to both register and interview data allows one to estimate the true models, there is a substantial discrepancy between households reporting they have received housing allowance and those for whom registers

suggest they have. In other words, the problem of multiple measurements appears to arise with respect to benefit receipt, not just benefit entitlement (Jäntti, 2006).

The second exercise, by Bargain et al. (2007; 2007a), used administrative register data and microsimulation calculations to compare eligibility and actual receipt of social assistance for Finnish working-age families in 1996-2003 (i.e. during and beyond the post-recession period). Access to register data helped minimize under-reporting and measurement errors on benefit entitlement and income levels. Moreover, possible errors due to time-period issues and (unobserved) discretion applied by local agencies were carefully investigated. The authors estimated that perfect targeting would reduce the headcount poverty rate to just 3% of the population, since the rate of non take up is very substantial, remaining above 50% and actually increasing over the period. Extensive sensitivity analysis of estimated non take up rates was provided to test the robustness of these estimates, for instance by introducing artificial income measurement errors by component, assuming such errors are normally distributed with zero mean and standard deviation equal to 10% of each income component. “Beta errors” (that is, illegitimate claimants as a proportion of all benefit recipients) were also found to be substantial, but the overwhelming proportion of relevant cases appeared to receive social assistance for short periods of time only. Overall, the paper showed that the measurement of targeting errors is a difficult task even when access to register data is possible. On the one hand, data requirements are high. On the other hand, much depends on (but little is known about) the supply side: the behaviour of benefit-awarding agencies as regards family needs assessment, and other discretionary decisions under uncertainty and budget constraints (Bargain et al., 2007; 2007a).

The purpose of the third paper (Jäntti, 2009) was to examine the various issues arising from the presence of measurement errors, and their implications for modelling non take up of benefits in the context of static microsimulation models, through an analysis of housing allowances in Finland. To start with, the paper observed that modelling take up is very demanding in terms of data, methods and theory. Considerable additional complications are caused by measurement errors in survey data on resources and on claiming, as well as by timing and definitional differences between what the analyst can observe versus the determinants of actual eligibility as specified by government. Moreover, take up behaviour is highly likely to be imperfectly correlated across different types of benefits. However, substantial non take up of benefits does exist and doing nothing about it is clearly suboptimal. The best solution might be to have data, suitable for use in microsimulation models, with as

little measurement error as possible and/or multiple measurements of the resources that determine benefits and the benefit take up it, taken from validation studies (Bollinger and David, 1997). Analysts in each country could then model the take up behaviour and include the estimated claim costs in simulation models to endogenise take up behaviour (Pudney et al., 2006). It is highly plausible that the cost of claiming depends not only on the size of the benefit and socio-economic circumstances, but on the time path of claimant behaviour. In particular, it seems likely that while the initial cost to claiming can be high, it may be lower in subsequent periods, as the time and effort needed to gather information about benefit participation declines with repeat claiming. As a consequence of that, convincing models of take up behaviour would require high-quality longitudinal data. Such datasets with accompanying simulation models are very rare.

The paper argues that, in the absence of the kind of data that allow for the convincing modelling of take up of multiple benefits in the presence of measurement errors in both benefits and resources, it is not entirely clear what should be done. Ignoring incomplete take up may be the worst option, although there is something to be said also in defence of that option.⁶ One possibility is, again in the absence of proper models of non take up, to work with distributions of claiming costs that are “calibrated” to reproduce the observed rates of non take up. Such distribution can incorporate differences in take up rates across socio-economic groups as well as different income and benefit levels. The simulations by Pudney et al. (2006), using information on estimated pre-reform claiming costs for a single benefit, are an example of this approach, with two important differences. First, they work with an estimated model of take up behaviour. This is clearly superior, but may not be possible in all cases. On the other hand, they work with only a single benefit. The paper suggests simulating costs from a multi-dimensional distribution, calibrated to produce the known take up rates under existing rules, and having a plausible correlation structure across different benefits that can then be applied to the changes whose effects are evaluated using the new benefit rules (Jäntti, 2009).

A fourth paper, by Flevotomou (2009), examined the implications for tax-benefit models of the above reported research on measurement error. The paper takes the problem’s intractability as given and suggests an alternative strategy whereby the implications of

⁶ In particular, microsimulation models can be thought of as modelling the *intended* effects of benefits and benefit reform. However, as current benefits are associated with substantial and measurable non take up, it seems unwise to ignore the take up problem in assessing outcomes from changing benefit rules.

measurement error for tax-benefit models are explored through sensitivity analysis. More specifically, assuming the observed income, needs and all other relevant information in the survey data underlying the simulation of benefit eligibility are all “true”, the analyst may examine the effect of two types of measurement error upon non take up (as well as beta error). In order to account for systematic measurement error, flat rate variations in incomes or needs may be introduced in any tax-benefit model. Furthermore, in order to account for “classical” measurement error, random variations to such measures may be introduced separately or simultaneously. The random component may be specified as a proportional deviation from the underlying true measure that is normally distributed with appropriate mean and standard deviation. Repeated random draws then give distributions of non take up and beta error estimates that can be compared to our baseline estimates to evaluate the impact of measurement error. Substantial differences alert the analyst that should measurement error afflict the underlying data, the validity of results will be undermined even if eligibility is perfectly simulated in the tax-benefit model. The study concludes that measurement error is most likely an inevitable aspect of any source of data. Insofar as it is relevant with respect to variables playing a key role in the take up analysis undertaken in the framework of a tax-benefit model, it may potentially bias results. The econometric difficulties inherent in models with measurement error may make a direct approach for tackling the problem less appealing than an indirect approach whereby its effects are examined via sensitivity analysis.

On the whole, our research affords an improved understanding of measurement error. Part of this is the realisation that the quality of existing datasets and the general state of the art render unrealistic any attempt to provide a standardised procedure for correcting data for measurement error (let alone to use results from the analysis of one dataset in country x to adjust a different dataset in country y). Nevertheless, in the light of our research, we are able to specify the requirements – in terms of data quality and research design – for a direct estimation of measurement error, and to recommend an indirect methodology for accounting for measurement error in the context of microsimulation.

3.2. Income tax evasion

Income tax evasion raises significant issues from the point of view of distributional analysis. In terms of horizontal equity, individuals with similar income may differ in terms of inclination and opportunity to under-report it. As a result, tax evasion will violate notions of fairness and equal treatment, and will undermine the idea of reciprocity which lies at the heart of the social contract between taxpayers and the state.

In terms of vertical equity, “if the poor had more opportunity of evading taxes than the rich, or were better at it, then the egalitarian policy maker might have good reason to smile indulgently on evasion: up to a point anyway” (Cowell, 1987). However, it may also be that evasion softens rather than strengthens intended the redistributive effect of the tax schedule. Either way, ignoring tax evasion is likely to cause decision makers and policy analysts seriously to misjudge the distributive and fiscal effect of changes in social benefits and the tax system. Also, tax evasion has profound implications on efficiency as well: on the one hand, reduced tax receipts may lead to increased tax burdens on those who do not evade; on the other hand, different opportunities to evade associated with different occupations and/or sectors of the economy distort labour supply decisions.

The available estimates of the size of the shadow economy, e.g. by Schneider and his colleagues (Schneider and Ernste, 2000; Schneider and Klinglmair, 2004; Schneider and Torgler, 2007), can be criticised on methodological grounds (Caridi and Passerini, 2001; Breusch, 2006; Hanousek and Palda, 2006). Yet, the order of magnitude revealed by these studies shows that the issues raised by the existence of a shadow economy and, by implication, tax evasion cannot be easily dismissed.

The direct relevance of tax evasion to the evaluation of changes in tax policy is rather obvious. In addition, where the practice of assessing eligibility to benefits relies on tax returns, tax evasion will also be linked to target inefficiency, in the form of leakage of benefit to ineligible recipients. In view of that, ignoring tax evasion is likely to cause analysts seriously to misjudge the distributive and fiscal effect of changes in social benefits and the tax system. In view of that, the objective of our research was twofold: to provide estimates of the distributional impact of tax evasion in three EU countries (Hungary, Greece and Italy), as well as to elaborate methods for adjusting tax-benefit models and for correcting underlying datasets for income tax evasion.

All three studies relied on the assumption that respondents to income surveys truthfully reveal their income as they have no incentive to conceal it, while the opposite is the case when individuals fill in their tax return. Therefore, by comparing the responses to income surveys and the tax returns of identical or similar individuals, the analyst can estimate the extent and distribution of income under-reporting for the purposes of tax evasion. Even though this assumption seems quite reasonable, and has been used to great effect (recently by Fiorio and D’Amuri, 2005), it is not necessarily true. For instance, that income surveys are unreliable is the very point of departure of the consumption-based approach to the study of

tax evasion (see Pissarides and Weber, 1989; Lyssiotou et al., 2004). As a result of that, our estimation of tax evasion will most probably be biased downwards, i.e. it will provide a lower-bound estimate of the true size of tax evasion.

The study of tax evasion in Italy, by Mantovani and Nienadowska (2008), compared income data on 21,141 individuals in 8,011 households from the 2002 Bank of Italy survey of household income and wealth, with statistics on taxable income, tax paid and the number of taxpayers as published by the Italian Ministry of Finance.

Even though the paper replicates earlier approaches (Marenzi, 1996; Bernasconi and Marenzi, 1999; Fiorio and D'Amuri, 2005), it offers in addition a more explicit consideration of the possibility that the observed redistributive effects of tax compliance behaviour may result from re-ranking produced by tax evasion. Since available data do not allow for any reasonable estimate of re-ranking effects, two extreme scenarios are analysed and compared: one constructed under the assumption that re-ranking is negligible, the other assuming that the observed negative correlation between income level and rate of under-reporting is entirely due to re-ranking. The results suggest that assumptions on re-ranking effects play a major role in redistributive effect estimations. The first scenario shows almost no effects of tax evasion on the distribution of equivalized household income, while the second scenario conjures a distribution of equivalized household income that is significantly more unequal because of tax evasion.

The average rate of income under-reporting in Italy is estimated at 12%. Fiscal and distributional effects were computed using EUROMOD. Tax evasion reduces personal income tax receipts by approximately 21%. Under tax evasion the poverty rate and the poverty gap are higher than they would be under full compliance (by 4% and 5% respectively). Income inequality increases even more significantly (the Gini coefficient by 6%, the S80/S20 ratio by 3%, the Atkinson index for $e=0.5$ by 11%, the Atkinson index for $e=2$ by 4% and the Theil index by 14%), suggesting that high earners tend to evade proportionately more. This implies that the progressivity of the tax system is lower under tax evasion. The effects are rather large, as shown by various indices of progressivity and redistribution, suggesting a decline of 18% according to the Kakwani index, of 25% according to the Suits index, and of as much as 40% according to the Reynolds-Smolensky index (Mantovani and Nienadowska, 2008).

At first, the study on Hungary by Benedek and Lelkes (2007) relies on a very large, random sample of administrative tax records, not accessible for research so far, containing information on the 2005 income tax returns of more than 332,000 individuals (incomes earned in 2004). The study compares that sample with the Hungarian part of the EU-SILC 2005 survey (incomes earned in 2004). In the revised version (Benedek and Lelkes, 2008), the authors use a random sample of the following year's administrative tax records of about 228,000 individuals (a sampling fraction of 5.4%), and compare that with the Household Budget Survey of the Hungarian Central Statistical Office. Both datasets contain information on incomes earned in 2005.

The paper finds a striking feature of income distribution in the form of the minimum wage spike, which is more pronounced in the tax records than in the income survey, in particular among entrepreneurs. The average rate of under-reporting in Hungary is estimated at 11%, although this conceals large differences between the self-employed (who fail to report the greatest part of their incomes) and dependent workers. Men were more likely to conceal their incomes than women, but this is due to a composition effect (most self-employed workers are men). Due to measurement error in the income survey, these estimates are likely to be lower bound. Fiscal and distributional effects were estimated using EUROMOD. Tax evasion reduces fiscal revenues from personal income taxes by about 19%. Poverty does not change much, but income inequality becomes significantly higher under tax evasion (the Gini coefficient, the S80/S20 ratio and the Atkinson index for $e=2$ increased by 7% to 8%, the Atkinson index for $e=0.5$ rose by 18%, while the Theil index increases by 25%). In terms of tax progressivity and redistribution, large negative effects are estimated, ranging from 11% (Kakwani index) to 14% (Suits index) and to 27% (Reynolds-Smolensky index) (Benedek and Lelkes, 2008).

The study on Greece, by Flevotomou and Matsaganis (2008), compares an unaudited sample of tax returns, containing information on the incomes earned in 2004 by 41,300 tax payers in 27,400 tax units (a sampling fraction of 0.53%), with data drawn from the 2004/05 Household Budget Survey, containing information on 17,400 individuals in 6,600 households (incomes earned in 2004).

The paper estimates the aggregate rate of income under-reporting for the purposes of tax evasion in Greece at almost 10%. The distribution of under-reporting by income group suggests a U-shape: it appears to be higher in low-income groups than middle-to-high income groups, and highest in top incomes. In terms of income source, under-reporting is virtually

zero with respect to income from dependent employment and pensions, but seems to exceed 24% with respect to income from self-employment and up to 53% from agriculture. Under-reporting by geographical area appears to be lowest in Athens (6%) and highest in central western regions and the Peloponnese (16%), while it is estimated as 13% in the Islands and as 12% in central and northern Greece. Using the tax-benefit model EUROMOD the authors find that, because of the progressive schedule of income taxation in Greece, 10% income under-reporting translates into a 26% shortfall in tax receipts. The paper also estimates the distributional impact of tax evasion in terms of poverty, income inequality, and progressivity of the tax system. The results suggest that tax evasion causes the poverty rate (FGT=0) and the poverty gap (FGT=1) to rise by approximately 2% above what it would have been under full tax compliance. Moreover, tax evasion increases income inequality more markedly, by 3% (Atkinson $e=2$) to 9% (Theil), depending on the indicator examined (the effect on the Gini index is 4%, on the S80/S20 index it is 5%, while on the Atkinson index for $e=0.5$ it is 7%). Finally, tax evasion appeared to have the largest effect in terms of tax progressivity: the decline in the Kakwani index is estimated at 10%, that in the Suits index at 16%, while the reduction in the Reynolds-Smolensky is estimated at 24% (Flevotomou and Matsaganis 2008).

Table 3.1 below summarises the main findings of our research on tax evasion in three EU countries.

Table 3.1 Tax evasion in three EU countries

Best / mid-point estimates	Italy	Hungary	Greece
Estimated rate of income under-reporting	-12%	-11%	-10%
Estimated effect on tax receipts	-21%	-19%	-26%
Estimated effect on poverty			
poverty rate (FGT=0)	+4%	-1%	+2%
poverty gap (FGT=1)	+5%	-3%	+2%
Estimated effect on inequality			
Gini	+6%	+7%	+4%
S80/S20	+3%	+7%	+5%
Atkinson ($e=0.5$)	+11%	+19%	+7%
Atkinson ($e=2.0$)	+4%	+8%	+3%
Theil	+14%	+24%	+9%
Estimated effect on tax progressivity + redistribution			
Kakwani	-18%	-11%	-10%
Reynolds-Smolensky	-40%	-27%	-24%
Suits	-25%	-14%	-16%
Main groups of taxpayers involved	self-employed	entrepreneurs	self-employed, farmers

Another paper, by Flevotomou and Matsaganis (2009), on the implications of tax evasion for tax-benefit models, aims to provide the tax-benefit modeller with guidelines and advise on conceptual and technical aspects of such exercise. The study begins by setting out the objectives and the general strategy. It then highlights two critical issues: first, ensuring that the tax returns sample obtained is representative of the population of tax filers; and, second, ensuring that the distribution of tax filers across income brackets in the tax returns sample is similar to that underlying the income survey. Furthermore, the study discusses some key conceptual and practical aspects of the methodology, including the requirement that income concepts and demographic variables should be identically defined in the two data sources. More generally, tax returns data usually provide information on personal characteristics that may be exploited in order to define relevant sub-groups. The study presents specific ways to incorporate results in EUROMOD, and concludes by pointing to the limitations and possible extensions of this work.

Summing up, our research estimates the size and incidence of income under-reporting in three European countries by comparing data from unaudited tax returns to those from income surveys, and provides new evidence on the much under-researched question of the distributional impact of tax evasion by feeding these findings into the European tax-benefit model EUROMOD. Moreover, we have been able to elaborate practical methods for dealing with tax evasion in microsimulation, with specific applications to EUROMOD. Nevertheless, more research and better data are needed to refine further our methodology and to provide more accurate estimates of the distributional effects of income tax evasion.

3.3 Errors in targeting benefits

Not all individuals claim the social benefits to which they are entitled. In particular, even though universal (e.g. child benefits) and contributory benefits (e.g. social insurance pensions) tend to be received by all eligible claimants, the take up of means-tested benefits is known to be significantly less than complete. For instance, a recent survey found that in many European countries the take up of social assistance typically spans a range from 40% to 80% (Hernanz et al., 2004). Non take up of social benefits may be caused by a variety of factors, including high claiming costs, administrative errors, fear of stigma, lack of information about entitlements and so on (Atkinson, 1996; Duclos, 1995). The shift in favour of means-tested benefits observed in several European countries since the early 1980s (Gough et al., 1997), and the rise of refundable tax credits since the mid-1990s (Brewer,

2003), raise questions concerning the extent and distributional implications of target inefficiency.

Furthermore, the converse problem (i.e. the payment of benefit to illegitimate recipients) may also manifest itself. Social benefits may be paid to households or individuals who would have been deemed ineligible had they disclosed to benefit-awarding agencies all relevant information about their material conditions and other characteristics.

The implications of target inefficiency (involving both non take up and beta error, as the leakage or over-payment of benefit is termed) are clear. Low take up by eligible recipients and over-payment of benefits to ineligible ones distorts the intended impact of social benefits, while at the same time limiting the accuracy of estimates concerning the effect of policy changes under the assumption of full compliance to benefit rules. Nevertheless, the problem remains overlooked as a policy issue and, with few exceptions, neglected as a research topic.

Clearly, in the context of microsimulation, failing to take account of errors in targeting benefits by assuming that all individuals eligible for benefit actually do claim, and that not a single ineligible one receives benefit, is likely to prove inadequate and unrealistic in almost all cases. In view of that, our research aimed to provide new evidence on non take up in six EU countries (Austria, Finland, Germany, Greece, Ireland and Spain), and to elaborate procedures for adjusting tax-benefit models in order that they can deal with errors in targeting social benefits.

The Finnish study, by Bargain et al. (2007; 2007a), uses data from the Finnish Income Distribution Survey on more than 12,600 households to analyse the non take up of social assistance (Toimeentulotuki) in 1996-2003, using the Finnish microsimulation model TUJA. The authors find the take up of social assistance to be low (between 50% and 60%) and actually declining over the period concerned. In 2003 the estimated rate of take up was 49% of eligible households and, in expenditure terms, 45% of benefit available. Moreover, the rate of beta error (that is, the number of non-eligible claimants receiving benefit as a proportion of all recipients) is estimated at 15%. The authors also estimate a simple probit model on a detailed set of socio-demographic characteristics, and find the main correlates of non take up to be the expected size of entitlement, age, education, presence of a child aged 0-2, unemployed head of household and home ownership (Bargain et al., 2007; 2007a).

The German study, by Frick and Groh-Samberg (2007; 2007a), analyses data on 12,600 households from the German socio-economic panel (SOEP) in order to estimate the degree of

non take up of social assistance (Hilfe zum Lebensunterhalt) in 2002 and to analyse potential determinants of non take up behaviour. The authors find the non take up of social assistance to be extremely widespread, with a rate of 67% of all (simulated) eligible households not receiving social assistance according to self-reported information in the underlying survey data of the SOEP. Eligibility and expected size of benefit entitlement are simulated using the DIW Berlin microsimulation model.

Compared to previous studies, non take up of social assistance appears to have risen in recent times in line with the overall increase in poverty and social assistance receipt in Germany since the mid 1970s. However, consistent time series analyses on non take up of social assistance are not available for Germany, and thus any inference on trends remains uncertain due to problems of comparability across different studies. Concerning the simulation of eligibility and the identification of households not taking up entitlements, emphasis is given to the role of measurement error. Regression analysis on non take up confirms the results of previous studies and expectations about the relevance of the expected utility of claiming benefit as well as the information and stigma costs associated with this process. The authors find clear evidence that non take up of social assistance is higher for lower levels of need and in cases of good prospects for leaving dependence on benefits fairly soon. In view of the paper's results on the impact of measurement error, especially the sensitivity of estimated take up rates to incomes just around the eligibility threshold, a substantial part of the puzzling picture of non take up can be explained by "rational poverty" (Riphahn, 2001). In other words for households (just) below the eligibility threshold, the costs of claiming are greater than the utility they can expect from claiming, at least in the short run. Future work along these lines may include panel analyses exploiting the longitudinal nature of the microdata at hand. The German SOEP also provides information on eligibility and claiming behaviour in years other besides 2002. Especially, the identification of otherwise unobservable individual and household characteristics by means of random and fixed effects models may help to reduce further the impact of measurement error, found to be of substantial importance (Frick and Groh-Samberg, 2007; 2007a).

The Austrian study, by Fuchs (2007; 2007a; 2009), estimates the take up of social assistance cash benefits (Hilfe zur Sicherung des Lebensunterhalts) in Austria in 2003. The paper is based on the comparison of detailed microdata on over 4,500 households from the 2004 EU-SILC database, with official figures on recipients and expenditure, as well as with simulated potential entitlements using the tax-benefit microsimulation model EUROMOD. To account

for likely measurement errors both in the reported income data as well as in the simulation of household needs, participation rates are calculated for various assumptions with respect to the underlying parameters. The author finds that less than half of the households potentially entitled to the benefit actually do claim, although the estimated rate of take up in terms of expenditure is higher. Regression models controlling for possible endogeneity of independent variables confirms the hypotheses derived from theoretical models of take up with respect to the expected size of entitlement, information and administrative costs, the psychological costs of claiming social benefits and so on (Fuchs, 2007; 2007a; 2009).

The Irish study, by Callan and Keane (2008), aims to identify the extent of non take up of two means-tested benefits. In the case of Family Income Supplement, existing evidence suggests a low take up rate. Such evidence has shaped debate on strategies for income support to children in the Irish context, and has provided support for arguments in favour of a new integrated benefit for low income families, irrespective of whether their main income source is a welfare payment or a wage. (Such a benefit would be similar in structure, and perhaps in delivery, to the Working Families Tax Credit introduced in the UK.) The authors analysed data from the Irish part of the 2005 EU-SILC, containing information on 3,750 households, using the microsimulation model SWITCH to simulate eligibility to benefit. Their results indicate that substantial difficulties with take up remained, with no more than half of the benefit being claimed. In the second part of the Irish study the likely extent of a new means-tested benefit, a non-cash benefit entitling recipients to free visits to family doctors (known as the GP Visit card), is also examined. Initially it was expected that about 200,000 people would qualify for the benefit. Slow initial uptake led to a considerable relaxation of income limits, as a result of which the population of potential beneficiaries was increased. The authors' simulations of the eligible population, when combined with administrative data on the numbers of GP visit cards issued, suggests that the rate of take up could be below 40%, and perhaps as low as 17%. These findings imply that attention must be given to gathering up-to-date and relevant data in order to understand and monitor the situation with respect to benefit take up (Callan and Keane, 2008).

The Spanish study, by Levy (2008), uses the 2005 wave of the EU-SILC database to analyse the take up of two non-contributory elements in the Spanish pension system: supplements to minimum pensions and pensions for old persons with inadequate social insurance contributions. The study estimates "caseload" take up rates for pension supplements in the range from 76% to 80%, and for the non-contributory pension scheme a substantially lower

take up rate of between 60% and 66%. As a proportion of the total amount claimed, the estimated rate of take up is between 91% and 93% for pension supplements, and between 60% and 66% for non-contributory pensions. In light of these estimates, non take up in Spain is as significant as in other European countries for which evidence is available.

A key finding is that pension supplements automatically assigned by administrative officials show a substantially higher take up than non-contributory pensions requiring active action by the recipient in the claiming process. Thus, one of the main lessons from the study of take up in the empirical literature is confirmed: “Programmes for which no ‘extra action’ is required have the highest take up rates. In contrast, other programmes, which do require extra action, have much lower take up rates.” (Remler et al., 2001). Secondly, the non take up rates presented in the paper are likely to be overestimated. A more accurate eligibility screening test based on more reliable microdata might produce significantly lower non take up estimates. This is particularly the case for non-contributory pensions. The fact the average unclaimed non-contributory pension is not lower than the average claimed one reinforces this view and highlights the importance of dealing with measurement error on the part of the analyst. In the words of Duclos: “The greater the inaccuracy of the analyst’s measurement of eligibility relative to the own inaccuracy of the agency, the more estimated take up tend to underestimate the true take up” (1995). The paper concludes that richer data than those used here would naturally add to our understanding of the size and determinants of take up (Levy, 2008).

The Greek study, by Flevotomou and Matsaganis (2009a), aims to provide preliminary estimates on the extent and covariates of two means-tested retirement benefits in Greece (the Pensioner Social Solidarity Benefit ΕΚΑΣ and the Social Pension), using data from the 2004/5 Household Budget Survey. The best estimates of take up of ΕΚΑΣ and the Social Pension are 75% and 62% respectively. Beta error, at least originating from income under-reporting, did not appear to be an issue. The proportion of non-eligible recipients is estimated as 16% and 10% of all recipients of ΕΚΑΣ and Social Pension respectively. This, however, could be the result of imperfect simulation of benefit entitlement. Supporting evidence, provided by sensitivity analysis, shows that variations in incomes have little effect on beta error rates. In contrast, estimated rates of take up appear more susceptible to income measurement error, more so in the case of ΕΚΑΣ than of the Social Pension. Among the correlates of take up (identified through the estimation of a probit model), expected entitlement as proportion of recipient’s income was significant for both benefits, albeit in the

case of the social pension in an unexpected direction (i.e. higher expected entitlement seems to increase the probability of non take up). Also, a quadratic U-shaped age effect was established for ΕΚΑΣ. Additional factors that lower the probability of non take up of ΕΚΑΣ are social insurance affiliation to either ΙΚΑ or ΤΕΒΕ, and widowhood. The latter is negatively correlated with non take up of social pension as well, as was residence in Central/Western Greece or in the Islands (Flevotomou and Matsaganis, 2009a).

Table 3.2 summarises the main findings on errors in targeting benefits in six EU countries.

Table 3.2 errors in targeting benefits in six EU countries

Best / mid-point estimates	Finland	Austria	Germany	Ireland
Benefit examined	social assistance	social assistance	social assistance	family income supplement
Estimated rate of take up				
<i>as % of households eligible</i>	49%	44%	33%	70%
<i>as % of benefit available</i>	45%	52%	43%	64%
Estimated rate of beta error	15%	32%	13%	not applicable ⁷
Correlates of non take up	expected size of entitlement, age, education, presence of child 0-2, head unemployed, home ownership	expected size of entitlement, household with unemployed or inactive head, not resident in Vienna	expected size of entitlement, family with children, need of care, disability, resident in metropolitan area	expected size of entitlement; married or cohabiting

Table 3.2 (cont'd)

Best / mid-point estimates	Spain		Greece	
Benefit examined	supplement to minimum pension	social pension	supplement to minimum pension	social pension
Estimated rate of take up				
<i>as % of households eligible</i>	78%	37%	75%	62%
<i>as % of benefit available</i>	92%	37%	79%	62%
Estimated rate of beta error	n.a.	n.a.	16%	10%
Correlates of non take up	n.a.	n.a.	expected size of entitlement, widowhood, age, social insurance agency	expected size of entitlement, widowhood, region

A further paper on the implications of non take up for tax-benefit models, by Matsaganis et al. (2009), begins by outlining three alternative approaches for systematically assessing the effects of non take up using the tax-benefit model EUROMOD. Approach I (“Identify eligible non claimants on the basis of individual characteristics”) might use a probit-type

⁷ Survey data allow eligibility at time of interview to be assessed, but entitlement to Family Income Supplement in Ireland lasts 12 months, so that the rate of beta error cannot be estimated.

model to estimate the probability of take up conditional on the characteristics of benefit units. Approach II (“Identify eligible non claimants on the basis of expected size of entitlement alone”) would achieve reconciliation with external information on overall rates of non take up through calibration. Under approach III (“Identify eligible non claimants randomly”), the predicted rate of take up would be set equal to official figures or other external information. In other words, the number of predicted beneficiaries drawn from the pool of potentially eligible population would be set so as to match the required rate of take up.

The paper argues that, unsophisticated though it may be, approach III represents an effective improvement on current practice, which is simply to assume 100% take up. As an illustration of the chosen approach, the paper presents the results of an exercise aiming to estimate the effects of non take up on target efficiency and on the poverty-reducing performance of social assistance in five European countries. The social assistance schemes selected are: Revenu Minimum d’Insertion in France, Pomoc Społeczna in Poland, Rendimento Mínimo Garantido (Rendimento Social de Inserção) in Portugal, Ekonomiskt Bistånd (Socialbidrag) in Sweden, and Income Support in the UK. Furthermore, the paper offers a technical account of the implementation of approach III in EUROMOD with respect to two non-contributory benefits in Greece. Finally, the paper concludes that even though the simple approach may overstate the effects of non take up if compared to the alternative of identifying eligible non claimants on the basis of expected size of entitlement, the findings are strong enough to suggest that policy interest in the take up of social benefits ought to be encouraged further (Matsaganis et al., 2009).

In conclusion, our research provides new estimates on the size and distribution of errors in targeting benefits in six European countries, and discusses alternative approaches to dealing with non take up in the context of microsimulation, the simplest of which was successfully incorporated in EUROMOD.

3.4 Simulations and cross-country comparisons

One objective of this research was to incorporate practical methods for dealing with tax evasion and targeting errors into EUROMOD, drawing on the country case studies. It was anticipated that the potential of this research was to serve as “demonstrator” for more comprehensive developments in the future, as well as to improve the accuracy of EUROMOD estimates in countries where tax evasion and/or targeting errors are known to occur on a greater scale than elsewhere.

The study by Flevotomou and Matsaganis (2009b) discusses how the two phenomena of tax evasion and targeting errors have been jointly studied in the context of Greece (the only country in this project where both phenomena are analysed), using EUROMOD. The benefits considered are two income-tested benefits targeted at the elderly: the Pension Social Solidarity Benefit *EKAΣ* and the Social Pension. The paper finds that the introduction of tax evasion does not confirm a prior expectation about its influence on “leakage” of benefit to illegitimate claimants: some small effect was found for *EKAΣ*, where about 0.8% of the so-called beta error caseload (508 out of 61,028 cases) is identified as passing the eligibility test because of income under-reporting to the tax authorities. In the case of the social pension, tax evasion has no effect whatsoever on the composition of the beta error caseload. Results could be country-specific or driven by the limitations of the current study. With regard to tax evasion, an obvious improvement would be to relax the somewhat crude assumption that all members of a given category under-report their incomes by the same ratio through the introduction of stochastic variation in the adjustment factors used to simulate the ‘reported’ income distribution. Another extension would be to extend the scope of analysis by incorporating not only tax evasion but also evasion of social insurance contributions into the tax-benefit model. Further, albeit not crucial when looking at old-age benefits, the study of the interaction of non take up and tax evasion in a more general setting may be informed by examining the dynamic effects of taxation through its impact on decisions concerning labour supply and demand, the allocation of disposable income between consumption and savings, the allocation of consumption between different goods and services and so on. Such behavioural responses may be accounted for in a tax-benefit model through its linkage to an externally estimated labour supply function. Finally, a limitation of our non take up analysis is that we rely on a single random draw in order to identify eligible non-recipients. In order to point out any robust effects, a larger number of replications should be modelled. Finally, the work presented in this paper provides guidance to modellers as to how tax evasion and non take up can be jointly studied and practically implemented in a tax-benefit model.

4. Incorporation of the effects of indirect taxes⁸

Microsimulation models like EUROMOD are indispensable when making an ex ante evaluation of possible reforms in the tax system. The availability of data at the household level enables a detailed distributional analysis of winners and losers and a check of whether the incentives given to different types of households correspond to the goals of the policy maker. The obtained results are not only useful in closing the feedback loop with theoretical design by revealing possible weaknesses and indirect effects of a policy measure, but also help in making more accurate predictions about outcomes in terms of budgetary and behavioural effects.

Like most other tax benefit models, EUROMOD until now more or less disregarded an important government instrument: indirect taxation. There was a pioneering attempt by O'Donoghue, Baldini and Mantovani (2004) to calculate indirect taxes for several EUROMOD countries. But the results of this exploratory work have never been really integrated into the EUROMOD architecture.

Two observations may suffice to stress the seriousness of omitting taxes on consumption. First, a look at the government budgets in the EU reveals that most countries get 20 to 40% of their revenue from indirect taxation. Often it is relatively more important than “traditional” revenue generating instruments like the personal income tax or the social security contributions of employees and employers combined. Second, a lot of contemporary tax reform proposals involve the shift from taxes on labour to taxes on consumption or pollution, assuming that this would create a more incentive-compatible structure underlying the welfare state. In the current setting, EUROMOD could only simulate the first part of the reform, leaving a complete analysis of the distributional effects in the air.

Hence a goal of AIM-AP was to enrich certain selected EUROMOD datasets with expenditure data and provide them with an indirect tax system so as to simulate a combined reform of direct and indirect taxation. Figures 4.1 and 4.2 summarize the different steps taken in the imputation and simulation phases of the project, respectively. The complete description of the algorithm can be found in Decoster et al. (2009b).

⁸ Written by Andre Decoster, Jason Loughrey, Cathal O'Donoghue and Dirk Verwerft, the main participants in the indirect tax part of AIM-AP

Figure 4.1: Calculation of aggregate indirect tax rates and imputation step

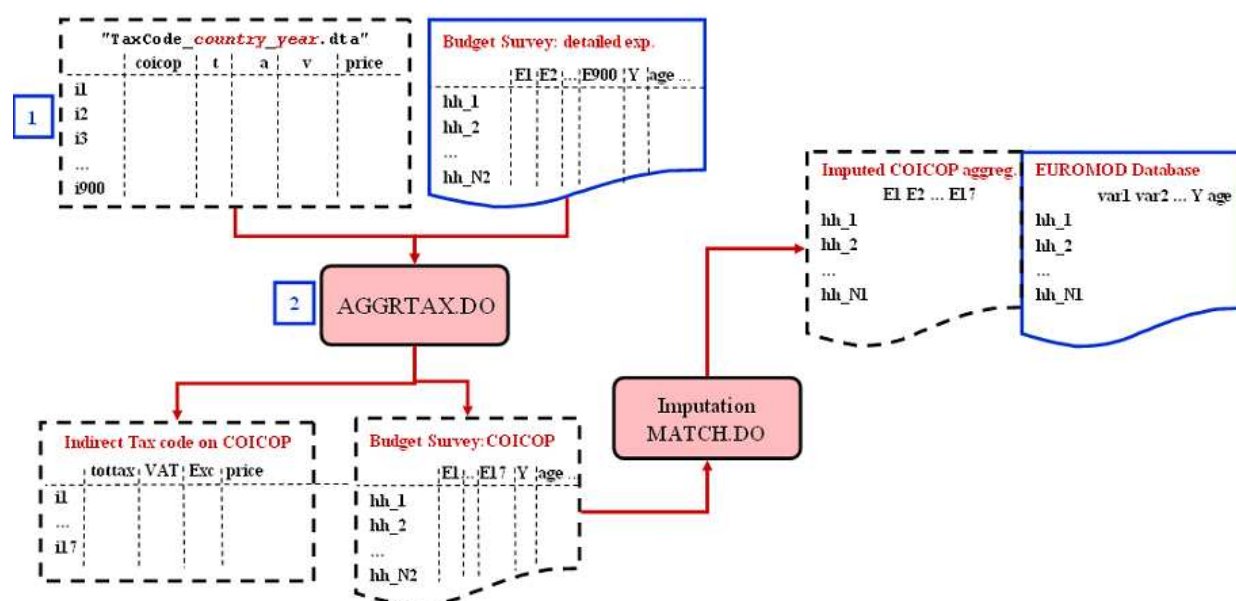

First, appropriate expenditure and tax data were gathered and wherever necessary harmonized to the corresponding EUROMOD dataset (indicated by number 1 in Figure 4.1). This is considered in the next section (4.1). A next step was the aggregation of expenditure items into the COICOP scheme (part of step 2 in Figure 4.1).⁹ Then a method was devised to impute expenditure data into the EUROMOD dataset (the imputation step in Figure 4.1). Section 4.2 reports on this. Afterwards, the country-specific indirect tax system was implemented as described in section 4.3. Section 4.4 then contains a synopsis of the results of the imputation step, describing the importance of the indirect tax system in the enriched EUROMOD dataset. Finally, an example of a combined labour and consumption tax simulation was carried out for all selected countries (Figure 4.2). Section 4.5 discusses the results of this simulation and section 4.6 concludes.

⁹ Classification of Individual Consumption by Purpose. This is for instance the official categorization prescribed by the EU for the determination of the harmonized consumer price index (HICP). The aggregation used here is based on the COICOP aggregation, but it does not entirely coincide with it. For instance, we distinguish between public and private transport because of the different indirect tax rates, whereas they constitute one aggregate in the COICOP scheme.

Figure 4.2: Sequence to simulate indirect taxes in EUROMOD

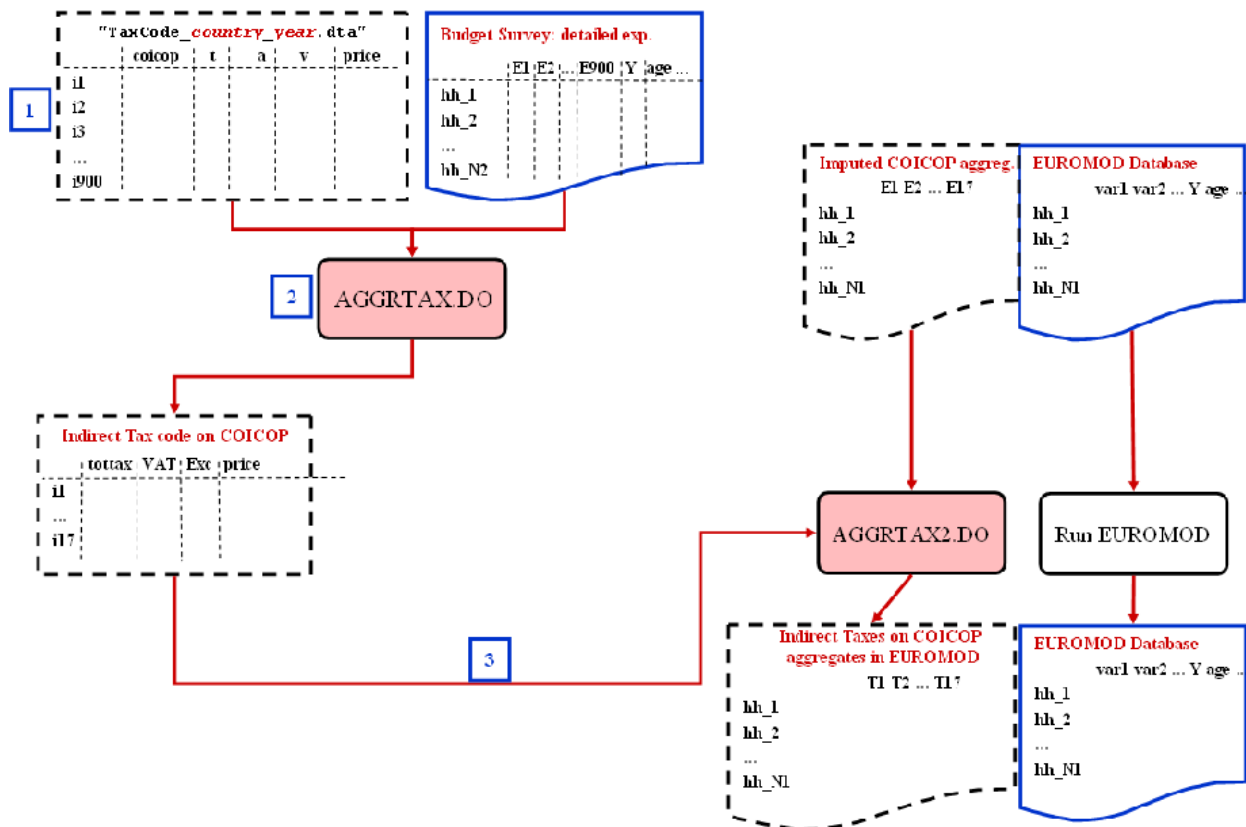

4.1 Preparing the data

In a trade-off between dataset availability and covering an as wide as possible array of tax systems, the analysis was carried out for five countries presented in Table 4.1. The EUROMOD and expenditure datasets within each country were chosen so that the data were gathered in the same year. This ensured the comparability of monetary variables across the datasets. The case of Greece is not treated here. Since the income survey underlying the EUROMOD dataset already contains the necessary expenditure information, the matching is straightforward. The Greek results are discussed partly in section 4.3 and partly in the project’s combined exercise (see section 5).

EUROMOD datasets contain for each observation, socio-demographic background variables – such as age, educational level and professional status – as well as income and tax data. Expenditure datasets also contain some variables of the first type, but in general they only contain a disposable income variable and no taxation data. Moreover, expenditures are included at a detailed level. Both datasets were reduced to the household level: monetary variables were summed within each household, while the demographic information of the household head – as defined by the survey – was used to characterize the entire household.

To ensure cross-country comparability and to avoid the problem of zero values on too many variables (which could jeopardize the imputation step), expenditures were aggregated according to the COICOP scheme into 15 non-durable categories, durables and home production.

Table 4.1: selection of countries and datasets

Country	Income Survey	Year	Expenditure survey	Year
Belgium	EU-SILC	2004	Household Budget Survey	2003
Greece	Household Budget Survey	2004/2005	Household Budget Survey	2004/2005
Hungary	EU-SILC	2005	Household Budget Survey	2005
Ireland	Living in Ireland	2000	Household Budget Survey	1999/2000
United Kingdom	Family Resources Survey	2003/2004	Expenditure and Food Survey	2003/2004

The next step consisted of identifying for each country a set of variables common to both the EUROMOD input data and the expenditure survey. These common variables are important in the imputation and consist of disposable income on the one hand and an as large as possible set of demographic variables on the other – age, sex, region, educational level, professional status, number of persons, children and people active in the labour force – that can be found in both datasets for most countries. This step is discussed in detail in Decoster, De Swerdt, Loughrey, O’Donoghue and Verwerft (2008).

4.2 Imputing expenditures

The next issue to be addressed was how to impute the expenditure data into the EUROMOD dataset. Several different ways to achieve this were identified (see e.g. Rodgers, 1984; Hardle and Mammen, 1993; Blundell et al., 1998; Yoshizoe and Araki, 1999; Moriarity and Scheuren, 2001; Sutherland et al., 2002), but the main idea underlying all of them is that a household in the EUROMOD dataset should get more or less the expenditure information of a household in the expenditure survey that is “most alike” with respect to the common variables. Note that the common variables are the only way to determine how similar households in both datasets are. The methods fall into two groups.

A first possibility is to estimate budget shares on the common variables in the expenditure survey and then predict values in the EUROMOD dataset. If this is done parametrically, one basically gets an Engel curve, which describes the allocation of a household’s expenditures over the different consumption aggregates as a function of disposable income. For instance, it

is often observed that a richer household spends relatively less on food and more on communication and entertainment. These effects can be captured and transposed to the EUROMOD dataset by this method.

A second line of thinking is that the similarity of households between datasets can be described by the distance they exhibit over common variables (distance seen as the absolute value of the difference). One can then give each variable a weight according to the importance one attributes to it in describing differences and similarities between households. A very interesting measure in this respect is the Mahalanobis distance (Mahalanobis, 1936), whose weighting scheme is sensitive to the variance of and the correlations between the variables. These methods have the advantage that they are not bound to a functional form or to the assumption of the standard regression model. Moreover, if one really wants to impute expenditure information at the most detailed level, they are the only possibility since regression methods are very bad at replicating a lot of zero expenditures.

A comparative study was carried out by splitting a dataset artificially and imputing expenditures from one half into the other (see Decoster et al., 2008a). The imputed value could then be compared to the real value. Surprisingly, the parametric estimation of Engel curves turned out to be the best one, in this respect and, since it is fairly easy and fast to implement, it is also the most efficient method. In the actual imputation, a special variant was devised that could cope better with some zero expenditure categories like tobacco or rents. To illustrate the adequacy of the matching procedure, the average budget shares per aggregate and per country are compared between the observed (expenditure survey) and imputed (EUROMOD dataset) data in Table 4.2. One should bear in mind, however, that for imputation of detailed expenditures, distance methods like the Mahalanobis distance are preferable.

4.3 Aggregation of expenditures and tax rates

The aggregation of expenditures into COICOP aggregates poses some additional difficulties. Perhaps of minor concern is the aggregation process itself. Although there are cases like a “grouped bill of water, electricity and heating” that belong to more than one COICOP aggregate and hence necessitate the use of distribution keys, in most cases the detailed categories can be reduced to a COICOP aggregate in a straightforward way.

Table 4.2: Comparison of actual and imputed budget shares per country and category

Country	BE		HU		IE		UK	
Commodity	Budget Survey	EURO-MOD income survey	Budget Survey	EURO-MOD income survey	Budget Survey	EURO-MOD income survey	Budget Survey	EURO-MOD income survey
Food, non-alcoholic beverages	18.9	17.9	26.0	24.9	20.6	26.8	17.5	15.1
Alcoholic beverages	2.0	1.7	1.1	0.6	5.4	4.5	1.9	1.9
Tobacco	1.3	1.3	2.8	2.6	2.9	3.4	2.1	2.2
Clothing and footwear	5.2	5.0	5.4	5.0	5.2	4.3	5.5	5.2
Home fuels and electricity	6.2	6.2	12.8	13.1	5.8	7.2	4.9	4.7
Rents	7.4	8.6	0.8	1.0	3.0	3.0	4.5	4.1
Household services	5.2	5.2	9.0	9.9	4.4	4.5	6.2	5.7
Health	6.9	7.0	3.8	4.8	1.8	1.2	0.9	0.9
Private transport	9.7	8.9	6.4	4.1	4.4	5.3	9.1	8.0
Public transport	0.7	0.7	2.3	2.0	1.5	1.5	1.7	1.5
Communication	3.5	3.4	5.9	6.2	3.0	4.0	3.6	3.2
Recreation and culture	8.1	7.4	4.7	5.2	6.5	6.7	9.6	9.0
Education	0.6	0.4	0.8	0.9	1.0	1.0	1.2	1.1
Restaurants and hotels	8.7	8.1	2.4	1.8	5.1	4.8	10.5	10.0
Other goods and services	9.5	9.0	5.6	6.2	14.8	12.2	7.7	7.6
Durables	6.1	9.2	6.5	8.0	14.6	10.0	12.9	19.8
Home production			3.6	3.5				
All commodities	100.0	100.0	100.0	100.0	100.0	100.0	100.0	100.0

A major problem arises for the construction of aggregate tax rates, especially with respect to the policy simulation phase. To explain this, it is necessary to look at the indirect tax system in more detail. We consider the indirect tax system as being composed of three consumption taxes: value added taxes, excises and ad valorem taxes. As an illustration, Table 4.3 presents the VAT rates in each of the five countries in the year of the expenditure survey.

Table 4.3: VAT rates per country in year of expenditure survey

Country	VAT rates			
	Standard		Reduced	
Belgium	21	12	6	0
Greece	18	8	4	0
Hungary	25	15	5	0
Ireland	20		12.5	0
United Kingdom	17.5		5	0

Attaching a specific tax rate to each consumption variable in the expenditure survey is in general unproblematic because of the level of detail that is available. However, each COICOP aggregate tends to be composed of expenditure items with different tax rates. This means that the “aggregate” tax rate will have to be a weighted mean of the tax rates of the detailed items included in the aggregate. In the program `aggrtax.do` (described in more detail in Decoster et al., 2008), mentioned in Figure 4.1, these weights are roughly the expenditures of the respective items.¹⁰ If households in the population spend more on bread than on caviar, then the tax rate on bread will have more weight than that on caviar in determining the tax rate on the aggregate “food and non-alcoholic drinks”. The results are summarized in Table 4.4 for the five countries.

All this has serious implications for the policy simulation phase of the project. In many cases a change in government tax policy involves a change in a statutory rate of VAT, excise or ad valorem tax at the most detailed level of consumption items. In the enriched EUROMOD dataset however, expenditures are only available at the aggregate level, with aggregate tax rates that are related to the statutory rates in a complex way. Hence, to simulate tax policy changes, the expenditure survey at the most detailed level is still required to translate the new statutory rates into new aggregate tax rates.

As such, this is not much of a practical problem. It merely stresses the fact that combined simulations with indirect taxation cannot straightforwardly be fully integrated within the EUROMOD modelling framework (although the datasets can be enriched with new expenditure variables, for general purposes). The reason is as stated before: the continuing dependency on external data for the recalculation of aggregate tax rates.

¹⁰ The picture becomes more complicated because of excises and ad valorem taxes, that are not expressed as a rate on the producer price. The idea is to approximate the actual paid taxes by an implicit rate.

Table 4.4: Aggregate tax rates per country

	Aggregate	BE	EL	HU	IE	UK
1	Food, non alcoholic beverages	6.4	7.9	15.5	3.9	2.1
2	Alcoholic beverages	40.9	24.8	65.3	29.9	65.9
3	Tobacco	207.5	278.6	300.9	317.0	522.3
4	Clothing and footwear	20.8	18.0	25.0	16.0	14.5
5	Home fuels and electricity	23.1	46.1	15.0	12.9	5.0
6	Rents	0.0	0.0	0.0	0.0	0.0
7	Household services	15.9	14.0	20.9	17.2	12.6
8	Health	2.9	4.1	5.5	1.1	0.0
9	Private transport	34.5	40.6	86.9	72.3	56.4
10	Public Transport	5.8	8.0	25.0	0.0	0.0
11	Communication	20.0	17.9	24.9	19.8	17.0
12	Recreation and culture	13.2	9.7	11.9	12.8	13.9
13	Education	1.9	0.3	0.0	1.7	0.0
14	Restaurants	11.9	16.8	14.0	12.9	18.0
15	Other goods and services	7.7	6.8	22.8	2.8	8.8
16	Durables	21.0	17.9	24.1	15.1	17.5
17	Home production		0.0	0.0		
	Total indirect tax rate	12.3	14.2	22.8	14.0	16.1
	total VAT-rate	10.6	11.8	18.7	10.8	11.6
	total Excise-rate	1.7	2.4	4.1	3.2	4.5

Note: tax rates in this table are tax liabilities divided by expenditures **minus taxes**, hence on a tax exclusive basis

4.4 Results: the influence of indirect taxation

Before turning to the simulation, it is instructive to look at the influence of indirect taxation on the total tax and transfer system in the baseline situation. Table 4.5 gives for each country the average net tax liability per decile of equivalent disposable income, with and without indirect taxes. For each country we give the effect of social security contributions (SIC), social benefits (SB) and personal income taxes (PIT) in the first column. In the second column we add the indirect tax liability to this.

Table 4.5: Tax incidence by decile of equivalized disposable income, without and with indirect tax

Country	BE (EUR)		HU (EUR)		IE (EUR)		UK (GBP)	
Decile	SIC + SB+ PIT	Total	SIC + SB+ PIT	Total	SIC + SB+ PIT	Total	SIC + SB+ PIT	Total
1	-7109	-5076	-1109	-526	-6303	-4308	-4900	-3707
2	-10074	-8146	-1441	-742	-6565	-3744	-6395	-5057
3	-10547	-8320	-1824	-1050	-2609	580	-6486	-5025
4	-7488	-4905	-1894	-1067	-3912	-1195	-6120	-4535
5	-4703	-1770	-2321	-1430	3711	7743	-4911	-3181
6	-632	2579	-2192	-1189	6295	11081	-2570	-655
7	5244	8862	-1712	-606	11307	16706	-1	2235
8	10786	14767	-1234	47	16164	21838	3493	6048
9	17044	21548	-309	1186	22396	28028	7987	11010
10	34006	39516	4612	6723	34641	40356	21352	25399
Mean	2576	5822	-916	154	7394	11538	990	3196
CI of income before tax	0.572	0.572	0.619	0.619	0.503	0.503	0.565	0.565
CI of income after tax.	0.280	0.290	0.272	0.280	0.362	0.380	0.337	0.346
RS Index	0.292	0.283	0.347	0.339	0.142	0.123	0.228	0.218

The concentration indices (CI) of income before and after tax are shown at the bottom of the table.¹¹ The figures show that the tax systems in all countries are progressive, whether one counts the indirect taxes or not. However, the Reynolds-Smolensky index (RS), a measure for the degree of redistribution, drops almost two percentage points for Ireland and about one point for the other countries. This clearly shows that indirect taxation has a regressive effect on the overall system. A more extensive view of these results can be found in Decoster et al. (2009).

The question remains to what cause this regressive influence can be attributed. Some preliminary conclusions can be drawn. First, there is some evidence for a different effect of different indirect taxes: value added taxes are in general progressive or less regressive than excises. Reranking the observations into equivalent total non-durable expenditures gives a

¹¹ The calculation and interpretation of these indices is analogue to that of the Gini coefficient. The only difference lies in the fact that the ordering variable is not the same as the variable under analysis. So in this case the incomes before and after tax are analyzed using equivalent disposable income as a ranking variable.

RS-index close to 0 for all countries, indicating that the taxes faced by the “big and small spenders” are more or less proportional.

But the real regressive effect seems to stem from different savings rates, implicit in our analysis and data and equivalent to income less expenditure, as a proportion of income. Savings are very regressive in both rankings, meaning that higher income households have higher “indirect tax free” amounts of money. This is translated in the fact that indirect tax rates with respect to disposable income show a very regressive picture ranked according to equivalent disposable income, while indirect tax rates with respect to total expenditures reveal a progressive structure. So “big earners” indeed spend their money on higher taxed goods, but the fact that they save more of their money (tax free) makes the system as a whole regressive.

4.5 Combined simulations of direct and indirect taxes

The imputation of the expenditure and indirect tax data enables the simulation of a shift from taxes on labour to taxes on consumption. The simulation partly takes place outside the EUROMOD framework for reasons mentioned earlier. In the following paragraph the simulation method is described and the results are summarized. Details can be found in Decoster et al. (2009a).

The same policy measure is tested for all the countries: a 25% decrease in social security contributions of the employees is implemented in EUROMOD and this decrease is totally absorbed by a rise in gross income of the employees. The households see their disposable income increase, hold their savings constant and also the quantity of durables (though the price of this quantity may rise). Then the new amount of money that they can spend on non-durables is divided over the aggregates using the Engel curves estimated in the estimation step. Hence this allows for a change in expenditure behaviour among consumers, though only as a reaction on the total amount of non-durable expenditures, but not on cross-price effects. Then the government pursues budget neutrality by adopting a new standard VAT rate that compensates for the loss in “tax” revenue. The program does this by incrementally increasing the standard VAT rate and simulating the households’ reactions until budget neutrality is reached.

The revenue effects of this simulation are summarized in Table 4.6. The loss from the drop in contributions is somewhat over-compensated by the rise in VAT rate. (The reason for this maladjustment is that only integer standard VAT rates (or multiples of 0.5 in the case of

Ireland and the UK) were allowed in determining the revenue-neutral VAT rate.) For Belgium, part of the compensation takes places through a rise in PIT, since the PIT is calculated on the primary income minus the net transfers to the state.

Table 4.6: Revenue effects of the simulation (in millions of EUR for BE, HU and IE; in millions of GBP for the UK)

	BE		HU		IE		UK	
	base-line	simulation	base-line	simulation	base-line	simulation	base-line	simulation
SIC employee	17,490	-3,900	2,777	-693	168,875	-33,902	42,283	-9,713
PIT	35,500	+1,763	4,608	+0	1136,416	+0	164,813	+0
Indirect tax	14,400	+2,309	4,300	+731	443,139	34,791	71,717	+10,655
VAT rate	21%	26%	25%	34%	20%	23.5%	17.5%	21.5%

Table 4.7 presents the distributional effects of this policy measure. The evaluation measure WG (welfare gain) is the sum of the change in total non-durable expenditures on the one hand and the effect of increasing prices on the other hand. Clearly, all the decile groups see their non-durable expenditures increase on average. However, it is still possible that individual households see their non-durable expenditures fall, namely when the price rise in durables entirely consumes their rise in disposable income. The price effect is negative for everyone since there are no goods for which the price decreases. Taken together, the change in non-durable expenditures is not sufficient for the lower decile groups to be compensated for the change in prices, while for the higher deciles this is the other way around. On the basis of this table one can state that the policy measure proposed is regressive in every country.

4.7 Conclusions

The goal was to incorporate indirect taxes in the EUROMOD framework, in order to enable combined changes in direct and indirect tax policy. It was found that the best and most efficient way to impute expenditure data in EUROMOD is by parametric estimation of Engel curves. The method used here is designed to be robust for a small number of zero expenditure variables, but the parametric design is not suited for estimating large numbers of variables where most of the households have zero expenditure, as is the case in detailed expenditure surveys. Therefore, an aggregation step is required. The COICOP aggregation scheme was adopted here.

Table 4.7: decomposition of welfare change into income effect and price change – by decile
(figures are in money metric utility, i.e. in EUR for BE, HU and IE, and in GBP for the UK)

Decile equiv. non durable expend.	BE			HU			IE			UK		
	Change nondur. exp.	Price effect	WG	Change nondur. exp.	Price effect	WG	Change nondur. exp.	Price effect	WG	Change nondur. exp.	Price effect	WG
1	43	-193	-150	22	-70	-47	0	-59	-58	9	-50	-42
2	79	-262	-183	34	-90	-56	38	-152	-114	39	-99	-60
3	159	-308	-149	57	-105	-48	108	-202	-94	90	-134	-44
4	237	-366	-129	82	-124	-41	213	-277	-64	134	-168	-34
5	389	-417	-28	112	-139	-27	321	-313	8	196	-200	-4
6	482	-455	26	141	-157	-16	364	-328	36	278	-233	45
7	614	-509	105	192	-183	9	390	-338	52	360	-269	91
8	735	-557	178	231	-205	26	483	-403	80	473	-316	158
9	837	-607	230	310	-237	73	523	-399	124	620	-376	245
10	1162	-858	305	527	-339	188	722	-531	191	764	-570	194
Mean	473	-453	20	171	-165	6	316	-300	16	296	-241	55

Aggregation necessitates the use of weighted average tax rates and hence requires the use of the detailed expenditure dataset in the policy simulation step as a link between the change in the official tax rates and the change in aggregate tax rates. As a consequence, integrating indirect tax simulation entirely into the EUROMOD programming environment would be an unwieldy solution.

Nevertheless, enriching the EUROMOD input datasets with expenditures and indirect tax information has other advantages. For example, we are able to use the values of total expenditure as a ranking variable in the distributional analysis of reforms to direct taxes and benefits, as an alternative to ranking by income; we are able to include indirect taxes in analysis of tax burdens (see section 5 below).

Distance matching can be used as a method to impute detailed expenditure data and hence avoid the dependence on the original expenditure dataset, but is revealed as being less reliable. However, if one desired full integration in EUROMOD this might be the only solution.

The results of the matching process show that indirect taxation is an influential, regressive component in the total tax system. It is therefore important to include it in microsimulation studies. The regressivity is due to the regressivity of the savings rate. Households earning more save more, and this compensates for the fact that they buy goods with higher indirect tax rates.

Decreasing the social security contributions of the employees and financing this by an increase in the standard VAT rate is a very regressive measure in all countries studied. This is of course the consequence of replacing a progressive taxation scheme by a regressive one.

5. AIM-AP results in combination

With the aim of bringing together the results of the three AIM-AP projects described in sections 2 to 4 above, two exercises were carried out, designed to illustrate the possibilities offered by the enhancements to income measurement that we have studied. The first of these used EUROMOD for the only country that was included in all AIM-AP projects, namely Greece. The second involved producing a range of statistics based on the non-cash incomes and indirect taxes parts of AIM-AP for the four countries for which this was possible: Belgium, Greece, Ireland and the UK. These two exercises are discussed in turn.

5.1 Direct and indirect taxes, cash and non-cash benefits, tax compliance and imperfect targeting in a microsimulation framework: Greece

The only country for which information is available on non-cash income components (imputed rent, public education transfers in-kind, public health care transfers in-kind, home production of commodities and fringe benefits) as well as tax evasion, imperfect targeting and indirect taxation is Greece. Using EUROMOD the combined effects of these factors on measured inequality (of the augmented income distribution) are examined, as well as effects on poverty and aggregate progressivity. The “augmented” income measure takes account of income tax evasion and non take-up of two Greek benefits (see section 3.3 above), is calculated net of indirect taxes (see section 4 above) and includes non-cash incomes (see section 2 above). In a variant, public health care and education are not included. When inequality decomposition by factor components is employed, the results show that in the augmented income distribution, all four non-cash income components (imputed rent, consumption of own production of commodities and fringe benefits, public education in-kind transfers and public health care in-kind transfers) contribute to a reduction in measured inequality, whereas the opposite is observed with respect to imperfect targeting, tax evasion and indirect taxation (both VAT and excise duties). At the margin, the quantitatively strongest inequality-reducing effects are due to imputed rents and public health care transfers and the strongest inequality-increasing effects are attributed to the impact of the VAT and tax evasion. These results are also confirmed using tax progressivity analysis.

EUROMOD was also made use of to assess two policy scenarios. These are both tax neutral and their distributional effects are examined under alternative concepts of resources: disposable income and augmented income as explained above (both versions, with and without public education and health care transfers). In both simulations VAT rates are increased by two percentage points. In the first simulation, the extra tax revenues are distributed across all income tax payers by an increase in the income tax threshold. In the second simulation, the extra tax revenues are distributed proportionally to income tax payers according to their tax liabilities.

In both scenarios, the overall results of both reforms are regressive, irrespective of the distribution used to evaluate them. A priori, this could be expected in the case of tax refund through the equiproportional reduction in tax liabilities, since indirect taxes account for a larger share of the income of the poor than the rich. The regressive result in the case of the increase in the taxable threshold should be attributed primarily to the fact that many of those

in the poorest decile groups of the distribution pay no income tax and, hence, do not benefit in this policy reform scenario and, also, to the fact that many taxpayers taken off the tax as a result of the reform do not benefit as much as the rest of the (richer) taxpayers. Looking at the size of the proportional increases of the inequality and poverty indices, it can be noted that the results are stronger when the augmented distribution is used (either with or without public education and health care services in kind). Hence, a distribution-conscious planner might have hesitated more in implementing either reform scenario if information was available on tax evasion, imperfect targeting and non-cash incomes rather than in the absence of this information.

5.2 Statistics using cash and non-cash incomes and direct and indirect taxes

The second exercise is designed to illustrate the potential of augmenting measures of income and indicators of the effects of public policy with non-cash incomes and indirect taxes, using EUROMOD. A set of illustrative statistics is provided, without commentary, for Belgium, Greece, Ireland and the UK in a document entitled *EUROMOD Statistics: cash and non-cash incomes; direct and indirect taxes*. This includes tables and charts as follows:

- Composition of household income
 - *original income*
 - *cash benefits by type*
 - *income taxes and employee (and self-employed) contributions*
 - *indirect taxes*
 - *non-cash incomes by type*
 - all households and bottom and top decile groups
 - average amount per household (national currency)
 - as a proportion of disposable income
- Inequality of income measure
 - *original income*
 - *original income + imputed rent (private)*
 - *gross income*
 - *gross income + imputed rent (private)*
 - *disposable income*
 - *disposable income + imputed rent (private)*
 - *disposable income - indirect taxes ("post indirect tax" income)*
 - *disposable income - indirect taxes + imputed rent (private)*
 - *disposable income + rent subsidy (public)*
 - *disposable income + public education*
 - *disposable income + public healthcare*
 - *disposable income + public non-cash*
 - *disposable income + all non-cash)*

- *disposable income - indirect taxes + public non-cash*
- *disposable income - indirect taxes + all non-cash*
- Quintile share (quintile of equivalised disposable income)
- Inequality indices (Gini, A(0.5), A(1.5))
- Absolute change in inequality (Gini, A(0.5), A(1.5)), relative to original income
- Effect on quintile (disposable income) shares of adding/deducting
 - *Gross cash benefits (+)*
 - *Direct taxes (-)*
 - *Indirect taxes (-)*
 - *Public non-cash benefits (+)*
 - *Private imputed rent(+)*
- Household effective tax rates
 - Numerator: Incomes taxes plus employee/self employed contributions
 - plus indirect taxes
 - plus employer contributions
 - Denominator: Gross incomes
 - plus employer contributions
 - plus private imputed rent
 - plus all non-cash incomes
- P90, mean, median, P10

Here we summarise three examples of the statistics and figures that are available.¹²

Household income composition

Figure 5.1 plots the composition of augmented household income, showing each component as a proportion of disposable income, first for all households and then for the bottom and top decile groups (where these are defined using the distribution of disposable income). The additional components – indirect taxes shown negatively and four categories of non-cash income shown positively – each play a significant role in augmented income for households as a whole (with the exception of public rent subsidies). Their importance in the composition of augmented income varies to some extent across countries, as does the importance of the components of disposable income, also shown. For example, indirect taxes play a large role in Greece, both relative to other taxes and relative to other countries. Public health care and, to a lesser extent, public education play a large role in Belgium relative to other countries but in this case appear

¹² Note that the estimates are preliminary and subject to revision. Any revisions will be posted on the AIM-AP web pages at www.iser.essex.ac.uk/research/euromod/aim-ap-project

act as a complement to cash benefits rather than a substitute. In Belgium there is generally a larger redistributive system (as indicated by the total height of the bar) than in the other countries, at least in terms of the benefits and taxes included in augmented income. This is also reflected in the relatively high proportion of the taxes (of those we consider) that are paid by the Belgians in the top decile group. Focussing on the bottom decile group, there is more diversity across countries in the composition of income. The main differences are due to indirect tax – which is the largest of the taxes paid in all countries but particularly large in Greece – and to private imputed rent, which also plays a relatively important role among poorer households in Greece; and public rent subsidies have a non-negligible role in the UK. Apart from these, the main compositional differences can be attributed to the different types of cash income and to direct taxes.

Figure 5.1 Composition of augmented household income, % of disposable income

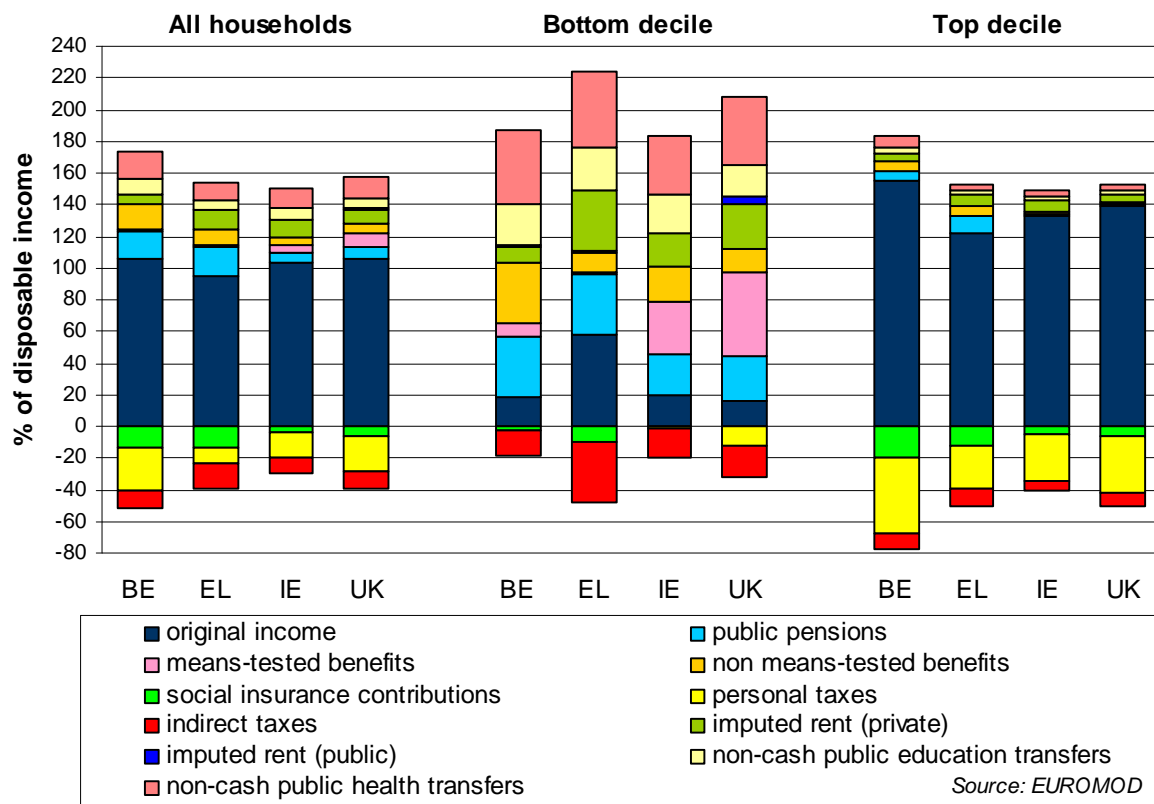

Notes: deciles are based on equivalised household disposable income (using the modified OECD scale); public pensions include old age and health related pensions received by people aged 65+, war pensions, early retirement and non-integral social pensions are included in other benefits.

Effects on inequality

The second example shows, in Figure 5.2, the absolute change in inequality (as measured by the Gini coefficient) due to five income components: cash benefits, direct taxes, indirect

taxes, non-cash benefits (public) and private imputed rent. In all countries cash benefits (which here include public pensions) have the largest effect. The analysis for Greece summarised above which showed that direct taxes and all types of non-cash income are inequality-reducing, while indirect taxes, when deducted from income, increase inequality, is confirmed here and the same general pattern applies in all four countries. However, there are differences. The negative effect of indirect tax and the positive effect of imputed rent on income equality seem to be largest effects in Greece. Direct taxes have an inequality-reducing effect that is larger than that of non-cash benefits in Belgium but smaller in the other three countries.

Figure 5.2: Absolute change in income inequality as measured by the Gini coefficient

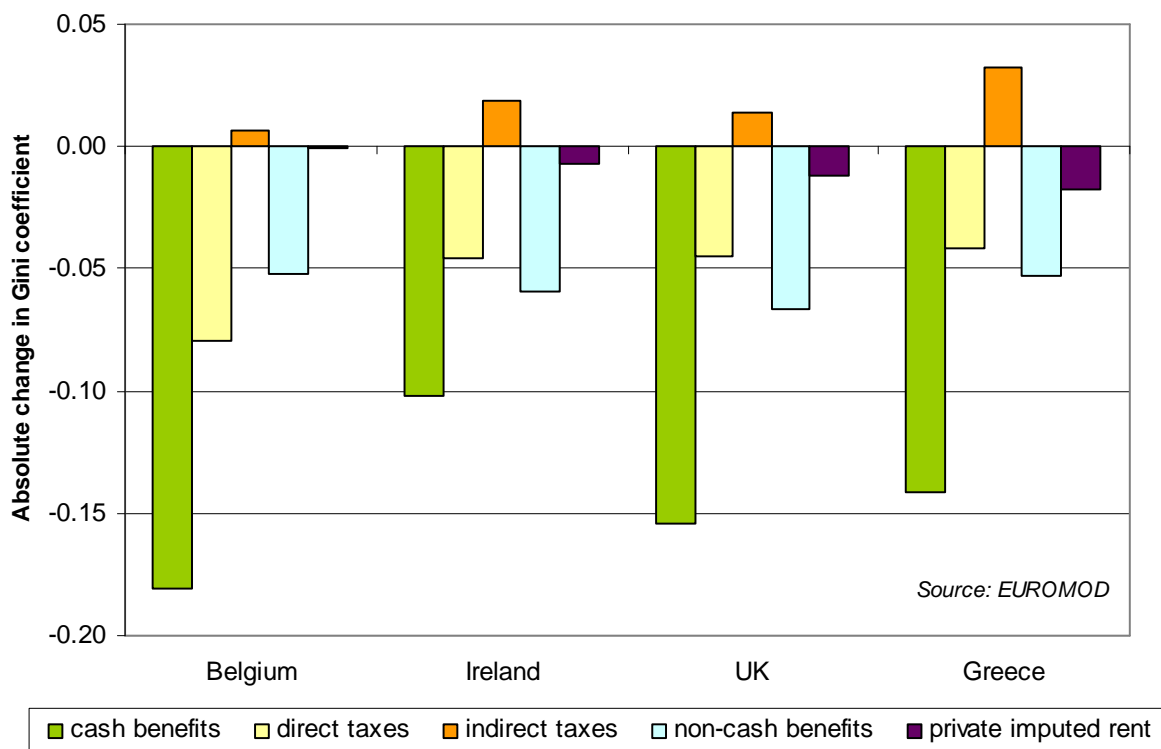

Notes: effects on inequality are calculated as follows: cash benefits = gross income (3) - original income (1), direct taxes = disposable income (5) - gross income (3), indirect tax = post-indirect-tax income (7) - disposable income (5), non-cash benefits = disposable income and public non-cash income (12) - disposable income (5), private impute rent = disposable income and private imputed rent (6) - disposable income (5).

Average (mean) household effective tax rates

When average tax rates at the household level are calculated using direct taxes (income taxes and employee contributions) as a proportion of gross cash incomes (original income plus cash benefits), the UK has the highest tax rate at 18%, with Belgium having the second highest

(15%) and Greece the third (14%): see Table 5.1. However when tax rates are calculated over a broader range of taxes and incomes, the rankings change. The example shown in Table 5.1 includes indirect taxes in the estimate of tax and three main elements of non-cash incomes (public health care and education and imputed rent: both public and private) in gross income. In this case Belgium has the highest tax rate (25%) with Greece coming second (23%) and the UK third (22%). A cross-national assessment of the relative size of the tax wedge is affected by the scope of the taxes and incomes used in the calculation. It is important, therefore, to have as broad a definition as possible at our disposal.

Table 5.1 Average (mean) household effective tax rates using two definitions

	Income tax + employee contributions / Original income + cash benefits	Income tax + employee contributions + indirect taxes / Original income + private imputed rent + cash benefits + non-cash benefits
Belgium	15.2%	25.0%
Greece	13.7%	23.3%
Ireland	10.8%	17.1%
UK	17.6%	21.7%

5.3 Further work

It is worth emphasising that the cross-national picture changes somewhat if one considers the proportional, rather than absolute, reduction in inequality. For example, Figure 5.2 shows the absolute reduction in the Gini coefficient due to non-cash incomes to be the smallest in Belgium of the four countries considered. However, Figure 2.2 (in section 2 above) shows it to be one of the largest (across 7 countries) in proportional terms. Belgium has one of the lowest rates of cash income inequality, which explains these different rankings, using absolute and proportional change. This example points to the need to consider several perspectives: something made possible by the statistics resulting from the AIM-AP project, by the many papers and publications that are outputs of the project (see the following pages for a list) and by the fact that some of the methods and data produced during AIM-AP are made available within EUROMOD for future use.

6. Project papers and other references

AIM-AP papers and other outputs

This section lists all the project papers and other outputs, including those not referenced explicitly in this report. Those marked * are project deliverables and are available from www.iser.essex.ac.uk/research/euromod/aim-ap-project/deliverables-publications

- * D'Ambrosio C. and Gigliarano C. (2007) "The distributional impact of 'imputed rent' in Italy"
- * D'Ambrosio C. and Gigliarano C. (2007) "The distributional effects of public health transfers in kind: the Italian case"
- * D'Ambrosio C. and Gigliarano C. (2008) "The distributional impact of fringe benefits in Italy"
- * Bargain O., Immervoll H. and Viitamäki H. (2007) "Accounting for measurement errors: the non take up of social assistance in Finland".
Bargain O., Immervoll H. and Viitamäki H. (2007a) "How Tight are Safety Nets in Nordic Countries? Evidence from Finnish Register Data", IZA Discussion Paper No. 3004.
- Benedek D. and Lelkes O. (2007) "Estimating the incidence of income tax evasion in Hungary".
- * Benedek D. and Lelkes O. (2008) "The distributional implications of income tax evasion in Hungary".
- * Callan T. (2007) "Imputed Rent in Ireland: Distributional Implications"
- * Callan T. and Coleman K. (2007) "Non-cash Incomes from Publicly Provided Education: National Report for Ireland"
- * Callan T. and Keane C. (2008) "Non take up of means-tested benefits: National Report for Ireland".
- * Callan T. and Keane C. (2008a) "The Distributional Impact of Publicly Provided Healthcare Services in Ireland"
- * Callan T. and Keane C. (2009) "Non-Cash benefits in Ireland: Distributional Implications"
Callan T. and Keane C. (2009a) "Non-cash benefits and the distribution of economic welfare", *Economic and Social Review*, Vol. 40, No. 1, Spring, pp.49-71. .
- * Callan T., Smeeding T.M. and Tsakloglou P. (2007) "Distributional effects of public education transfers in seven European countries"
Callan T., Smeeding T.M. and Tsakloglou P. (2008) "Short-run distributional effects of public education transfers to tertiary education students in seven European countries", *Education Economics*, 16:3 275-288.
- * Decoster A., De Rock B., De Swerdt K., Loughrey J., O'Donoghue C. and Verwerft D. (2008) "Matching indirect tax rates on budget surveys for five selected countries".
- * Decoster A., De Rock B., De Swerdt K., Loughrey J., O'Donoghue C. and Verwerft D. (2008a) "Comparative analysis of different techniques to impute expenditures into an income dataset"

- * Decoster A., De Swerdt K. Loughrey J., O'Donoghue C. and Verwerft D. (2008) "Harmonisation of budget and income surveys"
 - * Decoster A., De Swerdt K. Loughrey J., O'Donoghue C. and Verwerft D. (2009) "Imputation of expenditures into the income datasets"
 - * Decoster A., De Swerdt K. Loughrey J., O'Donoghue C. and Verwerft D. (2009a) "Comparative analysis of the distributional impact of combined changes in direct and indirect taxes and benefits for five European countries"
 - * Decoster A., De Swerdt K. Loughrey J., O'Donoghue C. and Verwerft D. (2009b) "Users' guide to simulate indirect taxes in EUROMOD"
- Decoster A., Loughrey J., O'Donoghue C. and Verwerft D. (2009) "Incidence and welfare effects of indirect taxes".
- * Figari F., Paulus A., Sutherland H., Tsakloglou P., Verbist G. and Zantomio F. (2009) "Distributional effects of policy simulations related to non-cash income components"
 - * Flannery D., Hayes P., Hynes S., Loughrey J., O'Donoghue C., De Rock B., and Decoster A. (2007) "Selection of the countries and detailed description of the indirect tax legislation".
 - * Flevotomou M. (2009) "Implications of measurement error for tax benefit models".
 - * Flevotomou M. and Matsaganis M. (2008) "Estimating tax evasion in Greece".
 - * Flevotomou M. and Matsaganis M. (2009) "Implications of tax evasion for tax benefit models".
 - * Flevotomou M. and Matsaganis M. (2009a) "Estimating the size and determinants of benefit non take up in Greece".
 - * Flevotomou M. and Matsaganis M. (2009b) "The effect of tax evasion and targeting errors across countries: the case of Greece".
 - * Frick J.R., Grabka M.M. and Groh-Samberg O. (2007) "Estimates of Imputed Rents and Analysis of their Distributional Impact in Germany"
 - * Frick J.R., Grabka M.M. and Groh-Samberg O. (2007a) "Estimates of Publicly Provided Education Services and Analysis of their Distributional Impact in Germany"
- Frick J.R., Grabka M.M. and Groh-Samberg O. (2007b) "Economic Gains from Publicly Provided Education in Germany". IZA Discussion Paper No. 2911, July, Bonn: IZA.
- * Frick J.R., Grabka M.M. and Groh-Samberg O. (2008) "Estimates of Publicly Provided Health Services and Analysis of their Impact on Income Inequality and Poverty"
 - * Frick J.R., Grabka M.M. and Groh-Samberg O. (2008a) "Estimates of Home Production and Fringe Benefits and Analysis of their Distributional Impact"
 - * Frick J.R., Grabka M.M. and Groh-Samberg O. (2009) "Aggregate Estimates of Non-Cash Income Components and Analysis of their Distributional Impact in Germany"
 - * Frick J.R., Grabka, M.M., Smeeding T.M. and Tsakloglou P. (2007) "Distributional effects of imputed rents in seven European countries"
 - * Frick J.R. and Groh-Samberg O. (2007) "Estimating the size and determinants of benefit non take up in Germany".

- Frick J.R. and Groh-Samberg O. (2007a) “To Claim or Not to Claim: Estimating Non-Take-Up of Social Assistance in Germany and the Role of Measurement Error”. SOEPpapers on Multidisciplinary Panel Data Research at DIW Berlin, No. 53/2007, Berlin: DIW Berlin.
- * Fuchs M. (2007) “Accounting for measurement errors: the non take up of social assistance in Austria”.
- Fuchs M. (2007a) “Social assistance – no, thanks? Empirical analysis of non-take-up in Austria 2003”, EUROMOD Working Paper 4/07.
- Fuchs M. (2009) “Nicht-Inanspruchnahme von Sozialleistungen am Beispiel der Sozialhilfe”, in: Dimmel N., Heitzmann K., Schenk M. (eds.), *Handbuch Armut Österreich*, Studienverlag Innsbruck, 290-301.
- * Gagliarano C. and D’Ambrosio C. (2009) “Aggregate distributional effects of non-cash incomes in Italy”
- * Goedemé T. and Verbist G. (2007) “The distributional impact of public education in Belgium”
- * Jäntti M. (2007) “The non take up of social transfers and measurement error: housing allowances in Finland”.
- * Jäntti M. (2009) “Issues in modelling the take up of social transfers in the presence of measurement errors for static microsimulation models”.
- * Koutsambelas C., Flevotomou M., Matsaganis M. and Tsakloglou P. (2009) “Direct and indirect taxes, cash and non-cash benefits, tax compliance and imperfect targeting in a microsimulation framework: Greece 2004/5”
- * Koutsambelas C. and Tsakloglou P. (2007) “Estimates of imputed rents and their distributional impact in Greece”
- * Koutsambelas C. and Tsakloglou P. (2007) “Distributional effects of public education transfers in Greece”
- * Koutsambelas C. and Tsakloglou P. (2008) “Health Services in Greece and the distributional impact of in-kind public transfers in Greece”
- * Koutsambelas C. and Tsakloglou P. (2008) “Distributional effects of consumption of own production and fringe benefits: Greece 2004”
- * Koutsambelas C. and Tsakloglou P. (2009) “Aggregate distributional effects of non- cash incomes in Greece”
- * Levy H. (2008) “Take up rates of means-tested benefits for the elderly in Spain”.
- * Makovec M. (2007) “The distributional impact of public education expenditure in Italy”
- * Mantovani D. and Nienadowska S. (2008) “Tax evasion in Italy”.
- * Matsaganis M., Flevotomou M., Paulus A. and Sutherland H. (2009) “Implications of non take up for tax-benefits models”.
- * Mullan K., Sutherland H. and Zantomio F. (2007) “The distributional impact of imputed rents in the United Kingdom”
- Mullan K., Sutherland H. and Zantomio F. (2008) “Accounting for imputed rents in child and pensioner poverty analysis”.

- * Mullan K., Sutherland H. and Zantomio F. (2008) “The distributional impact of public health expenditure in the United Kingdom”
- * Smeeding T.M., Tsakloglou P. and Verbist G. (2008) “Distributional effects of public health care transfers in seven European countries”
- Sutherland H. and Tsakloglou P. (2009) “Accounting for the distributional effects of in-kind public benefits”.
- * Sutherland H. and Zantomio F. (2007) “The distributional impact of public education expenditure in the UK”
- * Sutherland H. and Zantomio F. (2009) “The distributional impact of non-cash incomes in the United Kingdom: the combined effect of imputed rents and public expenditure for education and healthcare”
- * Tsakloglou P. (2009) “Distributional effects of home production and fringe benefits”
- * Tsakloglou P., Callan T., Coleman K., D'Ambrosio C., de Vos K., Frick J.R., Gigliarano C., Goedemé T., Grabka M.M., Groh-Samberg O., Keane C., Koutsambelas C., Lefebure S., Makovec M., Mullan K., Smeeding T.M., Sutherland H., Verbist G. and Zantomio F. (2009) “Distributional effects of non-cash incomes in seven European countries”
- * Verbist G., Goedemé T. and Lefebure S. (2009) “The aggregate distributional impact of non-cash incomes in Belgium”
- * Verbist G. and Lefebure S. (2007) “The distributional impact of imputed rents in Belgium”
- Verbist G. and Lefebure S. (2008) “The Inclusion of Non-cash Housing Advantages in the Income Concept. Estimates and Distribution Effects for Belgium”, CSB Working Paper 08/01, Antwerp, Centre for Social Policy
- * Verbist G. and Lefebure S. (2008) “The Distributional Impact of Health Care Services in Belgium”
- * Verbist G. and Lefebure S. (2008) “The Distributional Impact of Other Non-Cash Incomes in Belgium”
- * de Vos K. (2007) “The distributional impact of imputed rents in the Netherlands”
- * de Vos K. (2007) “The distributional impact of public education transfers in the Netherlands”
- * de Vos K. (2008) “The distributional impact of public health expenditures in the Netherlands”
- * de Vos K. (2009) “The aggregate distributional impact of private and publicly provided non-cash income components in the Netherlands”

References to other work

- Aaberge R. and Langørgen A. (2006) “Measuring the Benefits from Public Services: The Effects of Local Government Spending on the Distribution of Income in Norway”, *Review of Income and Wealth* 52, pp. 61-83.
- Antoninis M. and Tsakloglou P. (2001) “Who benefits from public education in Greece? Evidence and policy implications”, *Education Economics* 9, pp. 197-222.

- Atkinson A.B. (1996) "On targeting and family benefits". In: Atkinson A.B. (ed) *Incomes and the welfare state*. Cambridge: Cambridge University Press.
- Bernasconi M. and Marenzi A. (1999) "Gli effetti redistributivi dell'evasione fiscale in Italia". *Ricerche quantitative sulla politica economica*. Rome: Bank of Italy.
- Blundell R., Duncan A. and Pendakur K. (1998) "Semiparametric estimation and consumer demand". *Journal of Applied Econometrics* 13, pp. 435-461.
- Blundell R. and Lewbel A. (1991) "The information content of equivalence scales", *Journal of Econometrics* 50, pp. 49-68.
- Bollinger C.R. and David M.H. (1997) "Modeling discrete choice with response error: food stamp participation". *Journal of the American Statistical Association* 92 (439) 827-835.
- Breusch T. (2006) Book review of C. Bajada and F. Schneider (eds) (2005) "Size, causes and consequences of the underground economy: an international perspective". *Economic Record* 492-494.
- Brewer M. (2003) "The new tax credits". IFS Briefing Note 35. London: Institute for Fiscal Studies.
- Caridi P. and Passerini P. (2001) "The underground economy, the demand for currency approach and the analysis of discrepancies: some recent European experience". *Review of Income and Wealth* 47 239-250.
- Cowell F. (1987) "The economic analysis of tax evasion" in: J. D. Hey and P.J. Lambert (eds) *Surveys in the economics of uncertainty*, Blackwell, Oxford.
- Duclos J.-Y. (1995) "Modelling the take-up of state support". *Journal of Public Economics* 58 391-415.
- Evandrou M., Falkingham J., Hills J. and Le Grand J. (1993) "Welfare benefits in kind and income distribution", *Fiscal Studies* 14, pp. 57-76.
- Fiorio C.V. and D'Amuri F. (2005) "Workers' tax evasion in Italy". *Giornale degli Economisti e Annali di Economia* 64 241-264.
- Frick J.R. and Grabka M.M. (2003) "Imputed Rent and Income Inequality: A Decomposition Analysis for the U.K., West Germany, and the USA", *Review of Income and Wealth* 49, pp. 513-537.
- Garfinkel I., Rainwater L. and Smeeding T. (2006) "A Re-examination of Welfare State and Inequality in Rich Nations: How In-Kind Transfers and Indirect Taxes Change the Story", *Journal of Policy Analysis and Management* 25, pp. 855-919.
- Gough I., Bradshaw J., Ditch J., Eardley T. and Whiteford P. (1997) "Social assistance in OECD countries". *Journal of European Social Policy* 7 (1) 17-43.
- Hanousek J. and Palda F. (2006) "Problems measuring the underground economy in transition". *Economics of Transition* 14 707-718.
- Hardle W. and Mammen, E. (1993) "Comparing nonparametric versus parametric regression fits". *The Annals of Statistics* 21 (4), pp. 1926-1947.
- Hernanz V., Malherbet F. and Pellizzari M. (2004) "Take-up of welfare benefits in OECD countries: a review of the evidence". OECD Social, Employment and Migration Working Paper 17, OECD, Paris.

- Jones F., Annan D. and Shah S. (2008) "The redistribution of household income, 1997 to 2006/7", *Economic and Labour Market Review* 2(12), Office of National Statistics, London.
- Lyssiotou P., Pashardes P. and Stengos T. (2004) "Estimates of the black economy based on consumer demand approaches". *Economic Journal* 114 622-40.
- Mahalanobis P. C. (1936) "On the generalised distance in statistics". *Proceedings of the National Institute of Sciences of India* 2 (1), pp. 49–55.
- Marenzi A. (1996) "Prima analisi sulla distribuzione dell'evasione Irpef per categorie di contribuenti e per livelli di reddito". In: N. Rossi (ed) "*Competizione e giustizia sociale*". Terzo Rapporto Cnel. Bologna: il Mulino.
- Marical F., Mira d'Ercole M., Vaalavuo M. and Verbist G. (2006) "Publicly-provided Services and the Distribution of Resources", OECD Social, Employment and Migration Working Paper No. 45, OECD, Paris.
- McLennan W. (1996) "The Effects of Government Benefits and Taxes on Household Income: 1993-94 Household Expenditure Survey Australia" Australian Bureau of Statistics Report No. 6537.0.
- Moriarity C. and Scheuren F. (2001) "Statistical Matching: Pitfalls of current procedures", *Proceedings of the Annual Meeting of the American Statistical Association, August 5-9, 2001*.
- O'Donoghue C., Baldini M. and Mantovani D. (2004) "Modelling the redistributive impact of indirect taxes in Europe: an application to EUROMOD", EUROMOD Working paper No. EM7/01.
- O'Higgins M. and Ruggles P. (1981) "The distribution of public expenditures and taxes among households in the United Kingdom", *Review of Income and Wealth* 27, pp. 298-326.
- Pissarides C.A. and Weber G. (1989) "An expenditure-based estimate of Britain's black economy". *Journal of Public Economics* 39 17-32.
- Pollak R. and Wales T. (1979) "Welfare comparisons and equivalence scales", *American Economic Review* 69 (Papers and Proceedings), pp. 216-221.
- Pudney S., Hancock R. and Sutherland H. (2006) "Simulating the reform of means-tested benefits with endogeneous take-up and claim costs". *Oxford Bulletin of Economics and Statistics* 68 (2) 135–166.
- Radner D.B. (1997) "Noncash income, equivalence scales and the measurement of economic well-being", *Review of Income and Wealth* 43, pp. 71-88.
- Remler D.K., Rachlin J.E. and Glied S.A. (2001) "What can take-up of other programmes teach about how to improve take-up of health insurance programmes?" Working Paper no. 8185. Cambridge, MA: National Bureau of Economic Research.
- Riphahn R. (2001) "Rational poverty or poor rationality? the take-up of social assistance benefits". *Review of Income and Wealth* 47 (3) 379-398.
- Rodgers W. L. (1984) "An evaluation of statistical matching". *Journal of Business & Economic Statistics* 2 (1), pp. 91-102.
- Schneider F. and Ernste D. (2000) "Shadow economies: size, causes and consequences". *Journal of Economic Literature* 38 77-114.

- Schneider F. and Klinglmaier R. (2004) "Shadow economies around the world: what do we know?". Discussion Paper no. 1043. Bonn: Institute for the Study of Labor.
- Schneider F. and Torgler B. (2007) "Shadow economy, tax morale, governance and institutional quality: a panel analysis". Working Paper no. 1923. Munich: Center for Economic Studies.
- Smeeding T.M. (1977) "The antipoverty effectiveness of in-kind transfers", *Journal of Human Resources* 12, pp. 360-378.
- Smeeding T.M., Saunders P., Coder J., Jenkins S.P., Fritzell J., Hagenaars A.J.M., Hauser R. and Wolfson M. (1993) "Poverty, inequality and living standard impacts across seven nations: the effects of non-cash subsidies for health, education and housing", *Review of Income and Wealth* 39, pp. 229-256.
- Sutherland H., Taylor R. and Gomulka J. (2002) "Combining household income and expenditure data in policy simulations", *Review of Income and Wealth*, 48 (4) 75-94.
- Yates J. (1994) "Imputed Rent and Income Distribution," *Review of Income and Wealth* 40, pp. 43-66.
- Yoshizoe Y. and Araki M. (1999) "Statistical Matching of Household Survey Files", Tech. Rep. Working Paper No. 10. Aoyama Gakuin University. <http://www.e.u-tokyo.ac.jp/itme/dp/dp10.pdf>.