

Müller, Wieland

Working Paper

Strategies, heuristics and the relevance of risk aversion in a dynamic decision problem

SFB 373 Discussion Paper, No. 1999,61

Provided in Cooperation with:

Collaborative Research Center 373: Quantification and Simulation of Economic Processes, Humboldt University Berlin

Suggested Citation: Müller, Wieland (1999) : Strategies, heuristics and the relevance of risk aversion in a dynamic decision problem, SFB 373 Discussion Paper, No. 1999,61, Humboldt University of Berlin, Interdisciplinary Research Project 373: Quantification and Simulation of Economic Processes, Berlin,
<https://nbn-resolving.de/urn:nbn:de:kobv:11-10046519>

This Version is available at:

<https://hdl.handle.net/10419/61720>

Standard-Nutzungsbedingungen:

Die Dokumente auf EconStor dürfen zu eigenen wissenschaftlichen Zwecken und zum Privatgebrauch gespeichert und kopiert werden.

Sie dürfen die Dokumente nicht für öffentliche oder kommerzielle Zwecke vervielfältigen, öffentlich ausstellen, öffentlich zugänglich machen, vertreiben oder anderweitig nutzen.

Sofern die Verfasser die Dokumente unter Open-Content-Lizenzen (insbesondere CC-Lizenzen) zur Verfügung gestellt haben sollten, gelten abweichend von diesen Nutzungsbedingungen die in der dort genannten Lizenz gewährten Nutzungsrechte.

Terms of use:

Documents in EconStor may be saved and copied for your personal and scholarly purposes.

You are not to copy documents for public or commercial purposes, to exhibit the documents publicly, to make them publicly available on the internet, or to distribute or otherwise use the documents in public.

If the documents have been made available under an Open Content Licence (especially Creative Commons Licences), you may exercise further usage rights as specified in the indicated licence.

Strategies, Heuristics and the Relevance of Risk Aversion in a Dynamic Decision Problem*

Wieland Müller
Humboldt-University Berlin[†]

August 20, 1999

Abstract

In this paper I consider a complex decision problem where subjects have to cope with a time horizon of uncertain duration and must update their termination probabilities which depend on stochastic events during “life”. First I describe how economic theory suggests to solve the decision problem. But since real decision makers can hardly be expected to behave according to the theoretical solution in the problem at hand, I describe several heuristics or rules of thumb and investigate their theoretical performance. Then observed behavior and the way how people tackled the problem is described. In the second part of the paper I discuss how much of the data can be explained by assuming that experimental subjects are risk averse.

1. Introduction

How people solve dynamic decision problems does not seem to be a well developed area of experimental research, but recently things have begun to change. There are experimental studies like Johnson, Kotlikoff and Samuelson (1987), Hey and Dardanoni (1988) and more recently Fehr and Zych (1995) and Anderhub *et al.* (1997) that investigate dynamic decision making in saving and consumption contexts in either a deterministic or a stochastic environment. These studies provide interesting insights into human decision making in dynamic situations but their main focus is on whether people behave according to theoretical predictions.

It is only recently that attention has been paid to the question of how people actually solve dynamic decision problems. For example, Carbone and Hey (1997) investigate what people do when faced with a fairly easy dynamic decision problem. The authors find that only a few subjects use Backward Induction (**BI**) in a consistent and thorough manner, although most people try to use **BI**. Köhler (1996) gives a report of an experimental

*I thank Vital Anderhub, Dirk Engelmann, Werner Güth, Steffen Huck and Martin Strobel for helpful comments. Financial support from the TMR project “Savings and Pensions” of the European Commission and the Deutsche Forschungsgemeinschaft, Sonderforschungsbereich 373 “Quantifikation und Simulation ökonomischer Prozesse”, Humboldt-Universität zu Berlin is gratefully acknowledged.

[†]Institute for Economic Theory III, Spandauer Strasse 1, 10178 Berlin, Germany, Fax +49 30 20935704, email: *wmueller@wiwi.hu-berlin.de*

investigation of consumption under uncertainty. Subjects are offered a trial facility which enables them to try out different consumption patterns before the actual decision is made. Köhler identifies three different types of strategies within the trial calculations: in a “learning”-strategy a subject performs more than one trial in one of the first two periods; a “rolling”-strategy is performed if no two consecutive periods elapse without trials and in a “fixed end”-strategy a subject performs trials in three consecutive periods each time assuming the same end period.

This study tries to contribute to the discussion of intertemporal decision making by further investigating an experiment by Anderhub *et al.* (1997). While the latter study explores whether subjects’ behavior is at least qualitatively as prescribed by the optimal solution, we here focus on strategies or heuristics that have been used and subjects’ attitudes towards risk.

In their experiment Anderhub *et al.* (1997) basically design a consumption environment with an uncertain time horizon. Moreover, a new feature is added to this more traditional setup by only successively revealing the individual termination probability. More precisely, in each of the twelve rounds of the experiment a participant is given an amount of money, S_1 , which he is asked to distribute over an uncertain number of periods. At the beginning of a round a participant only knows that he is going to “live” for at least three and at most for six periods. However, after the third period independent and identical chance moves decide whether or not a participant is going to experience a new period. There are three different termination probabilities, $0 < w_1 < w_2 < w_3 < 1$. When deciding on a round’s first consumption level, $x_1 (\leq S_1)$, each of the three probabilities appear as equally likely to decide after the third period whether or not this round continues with a new period. Before deciding on the second consumption level, $x_2 (\leq S_1 - x_1)$, one of the three probabilities is randomly excluded so that at this stage a participant should update his individual termination probability accordingly. After the decision on the second consumption choice is made one of the two remaining probabilities is randomly eliminated. Thus it is only when a participant decides on the round’s third consumption level, $x_3 (\leq S_1 - x_1 - x_2)$, that he knows which of the three possible termination probabilities will be the actual one in the present and up to the fifth period of the current round. In a case where a subject reaches the sixth period the round ends with certainty. The payoff of one round is equal to the product of all consumption levels chosen in the periods of that round. (For instance, if a round ends in the fifth period the payoff for that round is $x_1 \cdot x_2 \cdot x_3 \cdot x_4 \cdot x_5$. Note, on the one hand, that in a case where a subject reaches a period without having any money left a zero-payoff results. On the other hand, any money not spent in the course of a round is worthless.)

When solving such a dynamic decision problem involving uncertainty economic theory expects subjects to rely on **BI**. The analytical solution of this specific problem, however, is extremely difficult to obtain. In fact one has to rely on numerical techniques in order to derive the optimal solution assuming a risk-neutral decision maker (see Section 3.1). For the optimal solution to be a useful prediction of actual play, subjects should be able to arrive at this solution, though not necessarily by using the same techniques (Friedman, 1953). In the light of the difficulties involved with the derivation of optimal behavior for the problem at hand, it is questionable if the optimal solution is a useful predictor or a “useful approximation” (see Roth 1996) for the behavior of boundedly rational decision makers. However, the problem at hand—although somewhat artificial in nature—is

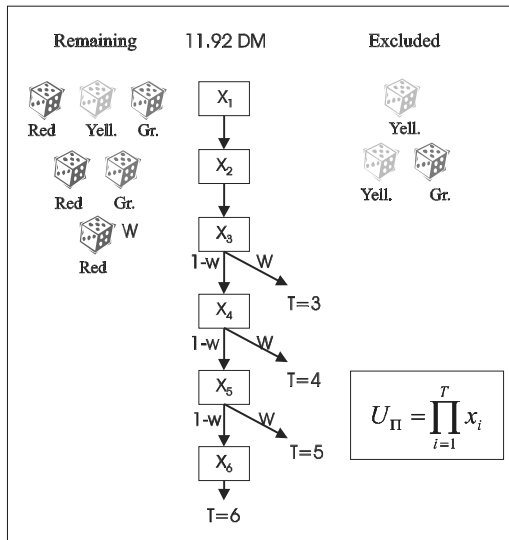

Figure 2.1: Example of one round

of practical relevance since it involves aspects of savings decisions that also occur in real life. More generally, the findings in this area of research do not only have implications for consumer behavior. They also tell us something about decisions made by managers or politicians. Therefore, it is both interesting and important to find out how human decision makers behave in a situation as complex as the one at hand.

The experimental situation certainly belongs to the class of problems, in which as argued by Hey (1983, p. 137) “it is simply impossible to carry out the backward induction procedure” at least for an experimental subject who faces a narrow time constraint. Thus it is more likely that subjects rely on heuristics and apply some forward-looking procedures as already mentioned by Hey (1983). This is also suggested by the data generated in this experiment.

The remainder of the paper is organized as follows: After introducing the experimental design in section 2, in section 3 the optimal solution of the decision problem will be presented as well as several simpler strategies and heuristics. In section 4 observed (average and individual) behavior will be described. Section 5 theoretically investigates the effects of risk aversion for the experimental situation and shows that these results are relevant for explaining observed data. Finally, the findings are summarized in section 6.

2. The Experiment

The experiment consists of 12 rounds. At the beginning of each round a participant is given an amount of 11.92 DM (refer to Figure 2.1). In each round the task is to distribute this amount over an uncertain number of periods. All a participant knows at the beginning of each round is that the round will consist of at least 3 and at most of 6 periods, i.e. the actual number of periods, T , in one round of the game is a stochastic variable whose range is the set of numbers $\{3, 4, 5, 6\}$. After the third period an identical and independent random move decides whether or not a subject reaches the next period. Thus after deciding on the consumption level x_i ($3 \leq i \leq 5$) with probability $w \in (0, 1)$

the round ends in which case the subject earns the payoff $U = \prod_{k=1}^i x_k$ in that round. With probability $1 - w$ the round continues with period $i + 1$. In the case where a subject reaches the sixth period of a round the computer invests any money left over. There are three different termination probabilities, namely $w \in \{\frac{1}{2}, \frac{1}{3}, \frac{1}{6}\}$. At the beginning of each round the players do not know which of the three termination probabilities will be applied from the third period on. The information about this is only successively revealed during the first two periods of a round. The players are told that after confirming the choice of x_1 one of the three probabilities is randomly excluded and that after confirming the choice of x_2 one of the remaining two probabilities is randomly excluded. Thus, a player does not know before the third period which of the three probabilities will be applied from then on. The three different termination probabilities were represented by dice of different colors: $w = \frac{1}{2}$ was represented by a red die, $w = \frac{1}{3}$ by a yellow die and $w = \frac{1}{6}$ by a green die. Players are told that from the third period on the relevant die will be thrown by the computer and they are informed which points the die has to show in order to reach a new period. For instance, if the red die shows the numbers 4, 5 or 6 the participant reaches the next period (see Appendix D.1 for details). In the example shown in Figure 2.1 first the yellow and then the green die was excluded so that it is the red die (standing for the termination probability $w = \frac{1}{2}$) deciding from the third period on whether or not there is a new period.

Because of the three different dice or termination probabilities there are altogether 6 possible sequences of initial chance moves (first red die excl. then yellow die excl. such that the green die applies, and so on ...). Each participant plays all six sequences in a random order before they are repeated in another random order.¹ The first (second) random order including rounds 1 to 6 (7 to 12) will be referred to as the first (second) cycle. The random orders are separately drawn for each subject.

Moreover, before the first decision, participants are asked whether they want to be paid according to the average payoff of all twelve rounds or according to the payoff of one randomly selected round which, of course, is drawn after the experiment. The computerised experiment was run in several sessions with a total of 50 participants who earned on average DM 27.62.

3. How to solve the decision problem?

3.1. Economic theory

- *Backward Induction & Principle of Optimality (BI)*

Standard economic theory expects a decision maker to work backwards through the decision tree taking into account the principle of optimality. This principle states that the decision at any node in the tree has to be optimal given optimal behavior thereafter. For the problem at hand this implies that a subject first has to determine optimal behavior in the fifth period for every possible history in the game. Then a subject has to determine optimal behavior in the fourth period taking into account the optimal behavior in the fifth period and so on until the first period is reached. Note that when deciding on the

¹This procedure was chosen in order to obtain comparable decisions. We did not find evidence that participants noticed this weak regularity.

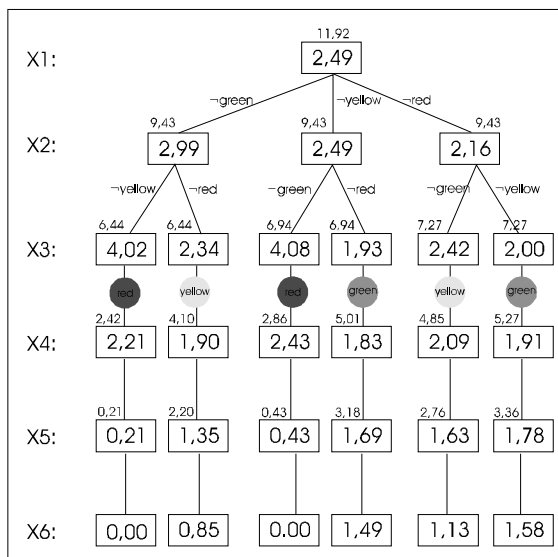

Figure 3.1: Optimal consumption behavior

optimal behavior in the second (in the first) period the termination probability can assume two (three) values. This together with the special form of the payoff function makes it extremely difficult to solve this game analytically (even by assuming a risk-neutral decision maker). Anderhub *et al.* (1997) rely on numerical methods to find the solution for a risk-neutral decision maker. The trajectories of the solution are displayed in Figure 3.1. (The small numbers on top of the boxes indicate the residual funds available to the decision maker at the beginning of a new period.)

The **BI** solution will serve as a benchmark for good performance. Throughout the paper this solution will be referred to as the *optimal* solution. Note that the optimal solution reacts sensitively to all chance moves. For example if the order of die exclusion is \neg green, \neg yellow such that the red die (highest termination probability) is the remaining one the termination probability has to be gradually updated upwards. The obvious consequence is that consumption must increase during the first three periods. Similarly, if the order of exclusion is \neg red, \neg yellow such that the green die (lowest termination probability) is the remaining one the termination probability has to be gradually updated downwards with the consequence that consumption must decrease during the first three periods. Furthermore, consumption decreases from the third period on for all six sequences of initial chance moves.

3.2. (Simple) Strategies and Heuristics

In this section several strategies and heuristics will be described that are tailored to the problem at hand.

- *Expected number of periods (ENP)*

The idea of this strategy is to set current consumption equal to current wealth divided by the expected number of remaining periods (see Figure 3.2). For example at the beginning

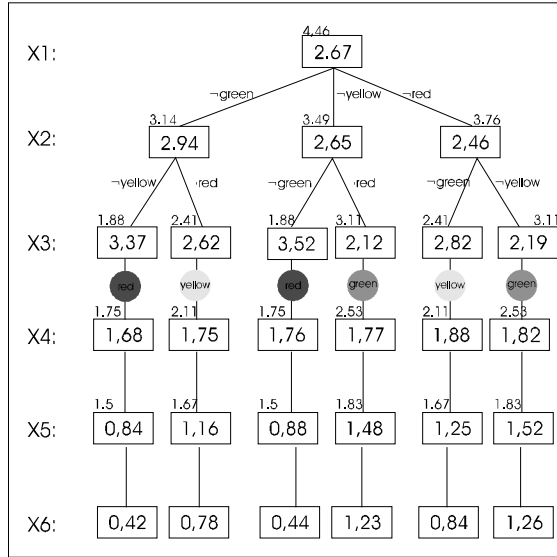

Figure 3.2: Expected number of period strategy

of each round the expected number of periods² is 4.46. Thus, this strategy suggests to set $x_1 = 11.92/4.46 \approx 2.67$. Note that this strategy proceeds forward when determining the decision. The most difficult task is of course to compute the expected number of remaining periods. Whereas there is little chance that the **BI** solution might be computed or heuristically approximated by an experimental subject—at least in the earlier periods—this is more likely for **ENP**. This is especially true for later periods for which the exact computation of the expected number of remaining periods becomes easier.

- *Equiprobability (EQP)*

The *Equiprobability* heuristic that is often mentioned in the literature (see for instance Johnson and Payne, 1985) ignores the fact that different outcomes occur with different probabilities and treats all events as equally likely. Mathematically, the problem can be stated as follows

$$\frac{1}{4}(x_1x_2x_3 + x_1x_2x_3x_4 + x_1x_2x_3x_4x_5 + x_1x_2x_3x_4x_5x_6) \rightarrow \max!$$

subject to $x_i \geq 0$ ($i = 1, 2, \dots, 6$) and $\sum_{i=1}^6 x_i \leq 11.92$.

The necessary and sufficient conditions imply

$$x_1^* = x_2^* = x_3^* = 2.50, \quad x_4^* = 2.22, \quad x_5^* = 1.60, \quad x_6^* = .60.$$

- *Avoidance of Payoff Uncertainty (APU)*

Adopting this strategy a player tries to achieve the same payoff for all possible courses of the game. Thus he has to make sure that $x_1x_2x_3 = x_1x_2x_3x_4 = x_1x_2x_3x_4x_5 = x_1x_2x_3x_4x_5x_6$ from which one concludes $x_4^* = x_5^* = x_6^* = 1$ and $x_1 + x_2 + x_3 = 11.92 - 3 = 8.92$ implying $x_1^* = x_2^* = x_3^* = 8.92/3 = 2.97$ ($x_1 = 2.98$).

²These numbers appear at the top left-hand side of the boxes in Figure 3.2.

Strategy/ Heuristic	Exp. Payoff	Std. Dev.	Eff.	Min. Payoff	Max. Payoff	δ_{opt}	δ_{obs}
BI	35.16	18.25	1.00	0	57.78	0	.35
ENP	33.59	11.44	.96	14.38	50.14	.31	.09
EQP	30.64	12.69	.87	15.25	55.15	.48	.37
APU	26.29	0	.75	26.29	26.29	.74	.41
2	30.55	23.04	.87	8.00	61.44	.70	.68
MAX	24.89	29.68	.71	0	78.86	.89	.89
Av. Obs. Beh.	Ø 27.62	15.6	.79	0	78.86	.35	0

Table 3.1: Strategies and Heuristics

In order to relate the various strategies and heuristics described above to the optimal solution (**BI**) Table 3.1 shows some of their characteristics such as expected, minimal, and maximal payoff and efficiency which is defined as the expected payoff of a given strategy/heuristic divided by the expected payoff of the optimal solution implying, for example, the value 1 for the latter. Furthermore, the value δ_{opt} gives the mean of the absolute deviation (cell by cell) of a given strategy/heuristic from the optimal solution. Formally, $\delta_{opt} = \frac{1}{28} \sum_{k=1}^{28} |x_k^{(\cdot)} - x_k^{BI}|$ where $x_k^{(\cdot)}$ (x_k^{BI}) are the consumption levels of a given strategy or heuristic (of the **BI** solution) for each of the 28 nodes of the decision tree. For example, the **ENP** strategy differs on average by .31 payoff units per cell from the optimal solution. (For the rows “2” and “MAX” and the value δ_{obs} see the next section.)

4. Observed Behavior

4.1. Average observed behavior

Figure 4.1 shows the mean, minimum, maximum and the variance of observed decisions at all nodes (the numbers of cases are given above each box). The line above or below each box indicates whether the given mean value lies above or below the corresponding value of the optimal solution.

At the end of the previous section the measure δ_{opt} was introduced in order to relate the various strategies and heuristics to the optimal solution. The measure δ_{obs} is similarly constructed but this time with reference to average observed behavior as shown in Figure 4.1. Thus, δ_{obs} measures the mean absolute deviation (per cell) of a particular strategy/heuristic from average observed behavior (see Table 3.1). The result is striking since according to this measure the strategy **ENP** fits the data best and is about four times closer to (average) observed behavior than the optimal solution.

The fact that the strategy **ENP** explains average decisions much better than the optimal solution remains true if one uses the dynamically adjusted solutions in order to compute the δ_{obs} -measure, i.e. observed data was compared with the decisions that would have been the correct ones (according to both strategies) given the—for the most part—wrong decisions in former periods. The values of the measure δ_{obs} are now .09 and .27 payoff units for the dynamically adjusted strategy **ENP** and the dynamically adjusted optimal solution, respectively.³ Thus the forward working strategy **ENP** seems to be a serious

³Note that this time only the decisions up to the fifth round were included in order to compute the

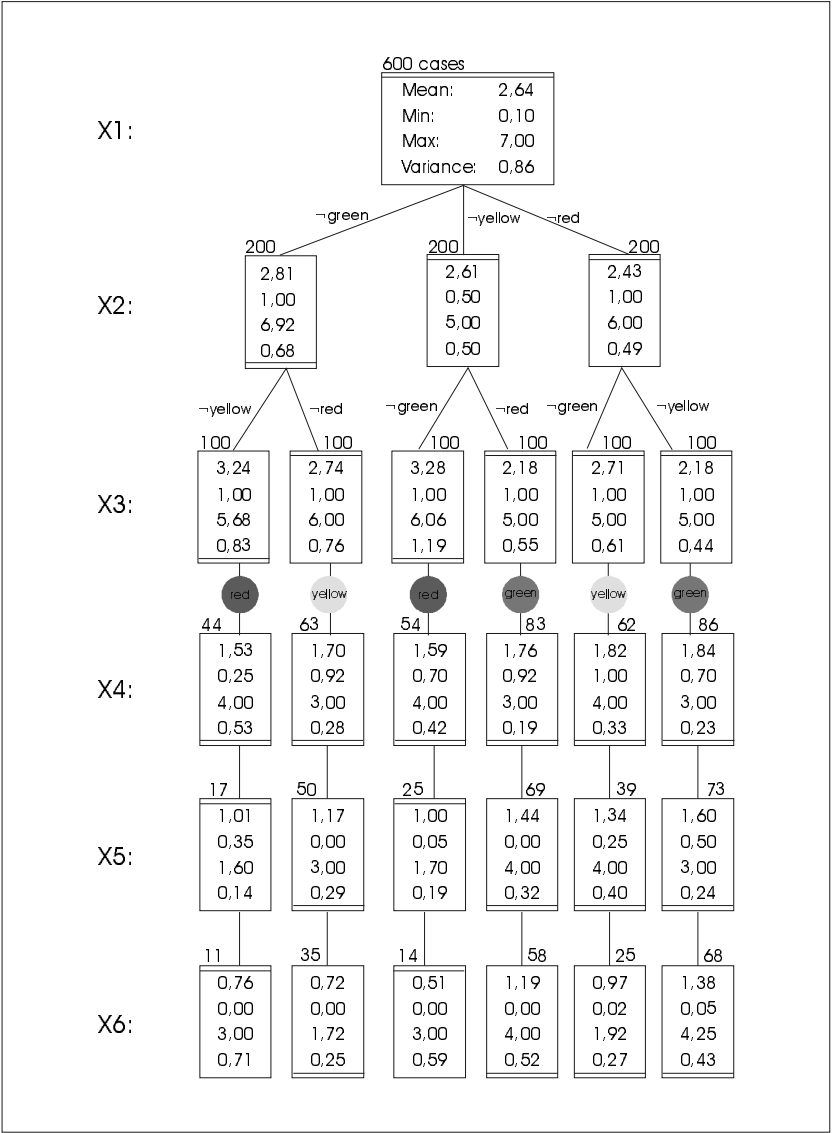

Figure 4.1: Average observed behavior

alternative to the backward working optimal solution.

4.2. Behavioral patterns

Although aggregated behavior is quite impressive in the sense that it reacts to information qualitatively in the same way as the optimal solution does, behavior on the individual level varies considerably. First of all individuals seem to differ in the degree to which they understand the rules and the highly stochastic nature of the decision problem. There are only few participants who act consistently and at least in a qualitatively correct way across rounds and periods. Some participants start out very consistently at the beginning of one round but then their decisions become less thought-out.

In this section observed behavior will be described in more detail. This is done in order to find out whether there is evidence on the individual level for the strategies and heuristics described above and whether there are other rules of thumb used by experimental subjects. Initially, it seems almost impossible to categorize the individual data. But by looking very closely at the individual decisions it is possible to “understand” about half of the data. Because of the complexity of the problem it is reasonable to concentrate our attention to the second cycle of the game. Although one cannot assume that play has converged in the second cycle it is at least more likely that at this stage subjects have understood the rules of the game and that they are familiar using the computer.

The patterns of behavior as described below are not always based on clear definitions. They solely try to reflect certain features of behavior that become apparent when one looks at the data. The hope, however, is to provide some stylized facts about the important question of how subjects try to solve the dynamic decision problem.

- *Qualitatively optimal behavior*

Subjects in this group display the same qualitative behavior as the optimal solution (or all strategies which do not ignore information). They start in each of the six rounds with the same moderate value for x_1 and their reactions to all the information is qualitatively correct (and also consistent with respect to x_2) i.e., they increase/decrease consumption after “bad news”/“good news”. Furthermore, consumption decreases from the third period on. An example is shown in Table 4.1.⁴

- *Consistent but not qualitatively optimal behavior*

Subjects in this group meet three optimality criteria: (1) they rely on the same x_1 -choice in all six rounds of the second cycle, (2) they react consistently to the exclusion of the first die i.e., after the exclusion of a particular die at the first chance move they rely on the same⁵ choice for x_2 and (3) consumption is monotonically decreasing from the third period on. Because of the first two features it is very likely that subjects in this group had a certain plan when generating their decisions. But despite these consistencies subjects in this group are different from subjects in the above group since their reactions

measure δ_{obs} .

⁴Note that the decisions are not ordered according to the number of rounds but according to the sequences of initial chance moves. Furthermore, recall that $S_4 = 11.92 - \sum_{i=1}^3 x_i$, i.e. S_4 denotes the remaining fund available before deciding about x_4 .

⁵Actually, these values vary at most by 0.10 units, if at all.

rd.	x_1	1. die	x_2	2. die	x_3	rem. die	S_4	x_4	x_5	x_6	payoff
7	2.93	gr.	3.30	yell.	4.10	red	1.59	1.00	0.45		17.84
8	2.93	yell.	2.93	gr.	4.23	red	1.83	1.20			43.58
9	2.93	gr.	3.30	red	3.20	yell.	2.49				30.94
11	2.93	red	2.80	gr.	3.30	yell.	2.89				27.07
10	2.93	yell.	2.93	red	2.50	gr.	3.56	1.67	1.11	0.78	31.03
12	2.93	red	2.80	yell.	2.50	gr.	3.69	1.60	1.20	0.89	35.00

Table 4.1: Example for qualitatively optimal behavior

rd.	x_1	1.die	x_2	2.die	x_3	rem.die	S_4	x_4	x_5	x_6	payoff
8	3.92	gr.	2.00	Yell.	3.00	red	3.00	1.00	1.00		23.52
10	3.92	yell.	2.00	Gr.	3.00	red	3.00	1.00			23.52
7	3.92	gr.	2.00	Red	3.00	yell.	3.00				23.52
12	3.92	red	2.00	Gr.	3.00	yell.	3.00	1.00	1.00	1.00	23.52
9	3.92	yell.	2.00	Red	2.00	gr.	4.00	2.00	1.00	1.00	31.36
11	3.92	red	2.00	Yell.	2.00	gr.	4.00	2.00			31.36

Table 4.2: Example for consistent but qualitatively not optimal behavior

to information is not qualitatively correct. They either choose a rather low/high x_1 -value such that consumption in the second period always increases/decreases or their reactions to the exclusion of the second die are qualitatively incorrect.

Some subjects in this group display another interesting tendency: they partially ignore information. One example is shown in Table 4.2. This subject totally ignores the information concerning the exclusion of the first die and partially ignores the information concerning the exclusion of the second die. (S)He relies on the same choice in the second period and on only two different choices in the third period. It is likely that the representation of the decision tree in this subject's mind is as shown in Figure 4.2. This subject's behavior is also interesting in the uncertain periods: Within the first four sequences (s)he saves exactly DM 3 for the uncertain periods and spends exactly DM 1 in each of the uncertain periods with the result that the payoff that was built during the first periods is maintained. This is a variant of the **APU** strategy. However, since this subject does not allocate the money evenly during the first three periods (s)he incurs a loss of DM 2.77 as compared to the proper **APU** strategy. The behavior of this subject is different if the green die applies. Now DM 4 are saved for the uncertain periods in order to spend DM 2 in the fourth period and DM 1 each time the fifth or sixth period is reached. This might be inferred from this subject's decisions.

- “*Go-for-the-maximum*” policy

The highest possible payoff that can be earned in one round is DM 78.86 by (correctly) guessing that the current round will consist of exactly 4 periods and allocating the initial amount of DM 11.92 evenly ($11.92/4 = 2.98$) to these periods. There was one very risk-loving subject who was aware of this fact and who tried to reach the maximal payoff at least when the red or yellow die applied. In the course of the 12 rounds this subject

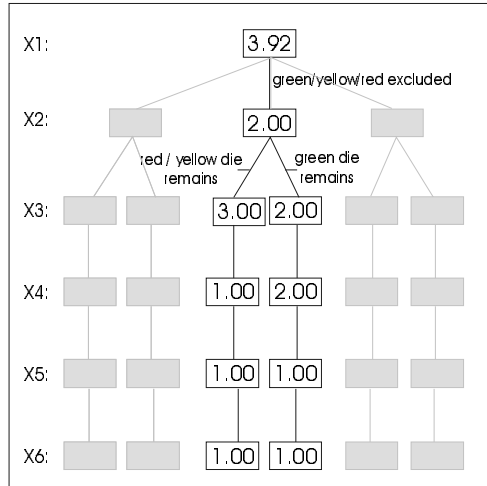

Figure 4.2: Representation of the problem by the subject of Table 4.3.

earned 3 times the maximal payoff.⁶ This subject deviates from the risky behavior only within the first two rounds where (s)he experiments a bit or when the green die applies.⁷ Some characteristics of this strategy are shown in Table 3.1.

- *Cautious policy*

The behavior of subjects in this group is best described as “cautious”. These subjects save far more during the certain periods than prescribed by the optimal solution. Subjects in this group also show very irrational behavior. For example one subject chose only DM 0.10 in the first period of round 4. Another subject had DM 3.00 left in two rounds in which (s)he reached the sixth period with the red die.

- *Wait-and-see policy*

The subjects in this group act cautiously but reasonably during the first two periods. They almost entirely ignore the information concerning the exclusion of the first die and it seems as if they wait until the uncertainty about the termination probability is resolved. Then they strongly react to the information regarding the remaining die via the x_3 - choice.

- *“2”-heuristic*

This heuristic simply prescribes $x_1^* = x_2^* = x_3^* = x_4^* = x_5^* = 2.00$ and $x_6^* = 1.92$ disregarding the possible sequences of initial chance moves and probabilities. This heuristic is based on the observation that if one experiences 6 periods in one round it would be optimal (ex post) to choose $11.92/6 \approx 1.99$ in every period. (See also Table 3.1.)

⁶In the fourth period of round 7 this subject chose only 2.90 instead of 2.98 in the fourth period implying a payoff of only 76.74.

⁷For those readers interested in such details: This subject decided before the game to be paid according to a randomly chosen round and although he earned the highest average payoff (DM 40.88) his actual payment was only DM 2.73.

This simple strategy is of significance with regard to observed behavior. There is one subject who applied this strategy in all 12 rounds of the game.⁸ Furthermore, if one relaxes the above conditions and allows for $1.90 \leq x_1, x_2, x_3, x_4, x_5, x_6 \leq 2.10$ one observes that this strategy is used in 43 cases by 18 different subjects including the one who used this strategy throughout the experiment.⁹ Altogether, this strategy was used in 7.2 % of all cases.

- *Trial policy*

Subjects in this group give the impression that they did not fully understand the rules of the game or that it was too much for them to deal with the problem reasonably at least at the beginning of each round. The standard deviations of the decisions in the first two periods confirm what immediately seems to be the case: These subjects' behavior varies much more as compared to all of the other subjects¹⁰. It seems as if they simply try out certain kinds of behavior and that they are still experimenting in the second cycle.

Other patterns observed include a strong reaction to the first excluded die by choosing above-average x_2 values or mixing up the probabilities of the dice. In the latter case subjects save more than twice as much for the uncertain periods in case the red die (highest termination probability) remains than in case the green die (lowest termination probability) remains. Another policy observed is that some subjects allocate their money during the first three periods in such a way that they have a certain (and different) amount left for each of the three different remaining termination probabilities.

The patterns¹¹ described above suggest that subjects do not work backwards through the decision tree in order to solve the problem but rather apply some forward-looking strategies and/or heuristics. Recall that with regard to the δ_{obs} - measure (see subsection 6.4.1) the strategy **ENP** fits average observed data about three (four) times better than the optimal **BI** solution. It is true that we could not find strong evidence that subjects used **ENP** properly. There are several possible explanations for that. It might be that subjects were simply not willing to spend the effort necessary to compute the expected number of remaining periods exactly. They may have used rough estimates of these numbers that varied from round to round. However, lacking another serious alternative it is useful to examine how well the two competing strategies—**BI** and **ENP**—do against the data. For each subject the predictions provided by the two strategies for periods 2 to 5 were calculated using the observed decisions of earlier periods i.e., it was calculated what the strategies would have prescribed for a certain decision node given the actual wealth. For periods 2 to 5 the adjustment equation given in Table 4.3 was estimated for the pooled sample with all but two subjects. The decisions of the two subjects who adopted the “go-for the maximum” and the pure “2” strategy, resp., (as described above) were removed

⁸In the first period he actually chose DM 1.99 when called upon to act.

⁹This kind of strategy can be clearly observed in sequences where the green die remained (29 cases). It was used in 9 cases when the yellow red die remained and in 5 cases when the red die remained.

¹⁰The mean of the standard deviations of the decisions in the first two periods for all subjects is .34, and excluding that group .24, whereas it is 1.49 for the group of these four subjects alone.

¹¹The number of subjects belonging to the groups described above are usually small (2 to 4 members). The only exception is the group “*Consistent but not qualitatively optimal behavior*” that consists of 8 subjects.

Estimating equation:

$$x_t^{obs} = \beta_0 + \beta_1 x_t^{ENP} + \beta_2 x_t^{BI} + \varepsilon; \quad t = 2, \dots, 5$$

	β_0	β_1	β_2	adj. R^2
$t = 2 :$	-.182 (.490)	.538** (.206)	.140 (.161)	.317
$t = 3 :$	-.417 (.334)	.743** (.108)	.091 (.083)	.556
$t = 4 :$.874** (.175)	.657** (.076)	-.234** (.078)	.639
$t = 5 :$.261 (.133)	.567* (.270)	.266 (.332)	.846

Table 4.3: Results of the regression.

Note: ** (*) significant at 1 % (5 %) level. Standard deviations in parentheses. Subject dummies were used.

from the data set since these strategies do not react on information about the exclusion of dice. Furthermore, only decisions made in the second cycle, i.e. in rounds 7 to 12 were included. The independent variable in the adjustment equation given in Table 4.3, x_t^{obs} , is the observed decision in round t ($t = 2, \dots, 5$). The two explanatory variables included are the decisions predicted by **ENP**, x_t^{ENP} , and **BI**, x_t^{BI} . The coefficients in Table 4.3 indicate how important the explanatory variables are for each period.

Note first of all that the explanatory variables become more and more relevant the higher the number of periods which is indicated by the adjusted R^2 measure. Furthermore, the coefficient β_1 —measuring the relative importance of the **ENP** strategy—is always positive and much higher than the coefficient β_2 suggesting that subjects use at least a variant of the forward-looking strategy **ENP** rather than the backwards working strategy **BI**. The coefficient β_1 is especially high (and rather close to 1) in the third period. In later periods this coefficient decreases and in the fifth period the optimal solution becomes more important for explaining observed behavior.

This section’s findings are summarized by formulating

Result 1. *Most subjects do not work backwards through the decision tree in order to solve the decision problem but apply some forward-looking strategies or heuristics. Regression results emphasize that subjects use **ENP** rather than **BI** for generating their decisions.*

5. Attitudes towards risk

5.1. Aggregated behavior

This section will address the question of whether risk-aversion can at least explain the direction of deviations from the optimal solution observed in subjects’ average decisions. For example, Figure 3.1 shows that when the red die remains the optimal solution prescribes the investment of all the money left in the fifth period when the residual fund falls

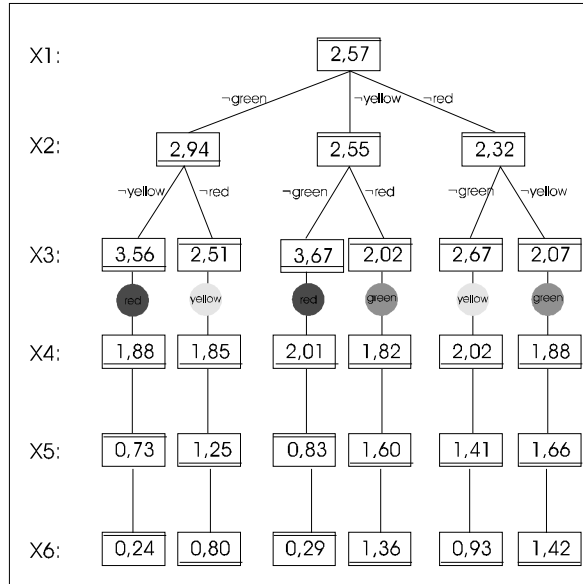

Figure 5.1: Optimal solution for $\alpha = .5$

below a certain level (see below for the derivation of this result). Should one expect a risk-averse subject to choose such an extreme action? After all this choice would result in a zero payoff if the subject experiences the sixth period. Thus one may expect that the optimal solution that allows for risk-aversion would never prescribe the investment of all remaining money until the last period is reached¹².

In order to see which consequences risk aversion has, the optimal solution was recomputed¹³ using the utility function $u(x) = x^\alpha$ which exhibits constant relative risk-aversion (or decreasing absolute risk-aversion). This can be seen if we note that $u'(x) = \alpha x^{\alpha-1}$ and $u''(x) = \alpha(\alpha-1)x^{\alpha-2}$ implying $r_R(x, u) := -xu''(x)/u'(x) = 1 - \alpha$, i.e. the coefficient of relative risk-aversion at x , $r_R(x, u)$, equals the constant $1 - \alpha$. Figure 5.1 shows the result of the computation for $\alpha = 0.5$.

The line above or below each box in Figure 5.1 again indicates whether the corresponding value lies above or below the optimal value as shown in Figure 3.1. If one compares these deviations from optimality with the deviations from optimality indicated in Figure 4.1 that summarizes average observed behavior, it turns out that there is a complete correspondence, i.e. whenever risk aversion predicts to spend less (more) at a given decision node than is prescribed by the optimal solution (Figure 3.1) a deviation in the same direction can be observed in Figure 4.1 showing average observed behavior. As computer simulations have shown, this is true for *all* $\alpha \in [0, 1)$. Thus we can state

Result 2. *Risk-aversion predicts the direction of deviations of average observed behavior from the optimal path, i.e. from the optimal solution that assumes risk-neutral behavior.*

It is interesting to note that the optimal solution that allows for risk-aversion (using the utility function over money $u(x) = x^\alpha$) converges to the **ENP** solution shown in Figure

¹²There were 9 out of 600 cases where a subject experienced a period without having money left.

¹³I thank Martin Strobel for adapting the computer program.

sequence	first chance move	second chance move	$\overline{\mu}_k$ (obs.)	$\mu_k(\alpha = 0) \dots \mu_k(\alpha = 1)$
1	\neg green	\neg yellow	0.73	0.75 ... 0.80
2	\neg yellow	\neg green	0.72	0.74 ... 0.76
3	\neg green	\neg red	0.69	0.69 ... 0.66
4	\neg red	\neg green	0.65	0.67 ... 0.59
5	\neg yellow	\neg red	0.63	0.62 ... 0.58
6	\neg red	\neg yellow	0.60	0.61 ... 0.56

Table 5.1: Ranked sequences

3.2 as α goes to 0 and it converges to the strategy that was characterized as “go-for-the-maximum”-policy as α goes to ∞ .¹⁴

With the help of Result 2 an observation mentioned in Anderhub *et al.* (1997) can be explained, namely that with regard to the optimal solution there is underconsumption during the first three certain periods in case the red die remains and overconsumption otherwise.

To be more precise, recall that there are six possible sequences of initial chance moves ($(\neg$ green, \neg yellow) or $(\neg$ green, \neg red) or ...). Now, let $\mu = \frac{x_1+x_2+x_3}{11.92}$ denote the relative amount consumed during the three certain periods $t = 1, 2, 3$. Using the utility function over money $u(x) = x^\alpha$, $\alpha \in [0, 1]$, and recomputing the optimal solution one can construct the functions $\mu_k(\alpha)$ that assign to each α the corresponding values of μ_k . Here $k = 1, \dots, 6$ indicates the sequence of initial chance moves. Table 5.1 shows the means $\overline{\mu}_k$ ($k = 1, \dots, 6$) of the observed values together with the range of the functions $\mu_k(\alpha)$. (Note that the functions $\mu_k(\alpha)$ vary monotonically from $\mu_k(0)$ to $\mu_k(1)$. This is what the dots in Table 5.1 indicate. The values for $\alpha = 1$ correspond to risk-neutral behavior.)

The two results that immediately follow are

Result 3. *The observed means $\overline{\mu}_k$ are ranked in the same order as the values $\mu_k(\alpha)$ (for any fixed value of $\alpha \in [0, 1]$).*¹⁵

and

Result 4. *Risk-aversion predicts underconsumption (when compared to the optimal solution, i.e. for $\alpha = 1$) during the first three certain periods when the red die remains and otherwise it predicts overconsumption.*

5.2. Behavior in the fifth period

The last subsection focused on the relevance of risk aversion for explaining deviations of average observed behavior from the optimal solution. In this paragraph attention is paid to individual decisions. We will, however, restrict ourselves to the decision problem in the fifth period. The reason for that is simple: allowing for risk aversion makes the derivation of analytical results even more complicated. For the most simple case, i.e. the decision

¹⁴Actually, the latter is already the case for $\alpha = 5.86$ without any changes for greater values of α .

¹⁵This result is already mentioned in Anderhub *et al.* (1997).

in the fifth period, it is, however, still possible to derive at least some comparative static results.

Consider an individual having utility function over money $u = u(x)$ with $u'(x) > 0$ for all $x \geq 0$. Given $C := x_1 x_2 x_3 x_4 > 0$, termination probability $w \in (0, 1)$ and $S_5 = (11.92 - \sum_{i=1}^4 x_i) > 0$ (wealth at the beginning of period 5) the decision problem in the fifth period is to maximize

$$U(x_5) = wu(C \cdot x_5) + (1 - w)u((C \cdot x_5)(S_5 - x_5)).$$

If x_5^* is optimal it must satisfy the necessary condition

$$wu'(C \cdot x_5) + (1 - w)(S_5 - 2x_5)u'((C \cdot x_5)(S_5 - x_5)) = 0 \quad (5.1)$$

or equivalently

$$S_5 - 2x_5^* = -\frac{w}{(1 - w)} \frac{u'(C \cdot x_5)}{u'((C \cdot x_5)(S_5 - x_5))}. \quad (5.2)$$

Since, according to our assumptions, $u'(x) > 0$ for all $x \geq 0$ it follows from (5.2) that $S_5 - 2x_5^* \leq 0$ or $x_5^* \geq \frac{S_5}{2}$ must hold, i.e. choices with $x_5^* < \frac{S_5}{2}$ are not compatible with utility maximization of any kind. This observation together with the budget constraint lead to

Remark 1. *For any kind of utility maximizing behavior in the fifth period it must hold that $\frac{S_5}{2} \leq x_5^*(S_5) \leq S_5$.*

Note that the condition given in Remark 1 must be fulfilled no matter whether (and to which degree) an individual is risk-averse or risk-loving. In our experiment we observe in 24 out of 273 cases that the condition of Remark 1 is violated.

In order to make sharper predictions about the behavior in the fifth period that is compatible with utility maximization one has to further specify the utility function $u = u(x)$. A class of utility functions that is amenable to some comparative static analysis is the class of utility functions that exhibit constant relative risk-aversion given by

$$u(x) = \begin{cases} (1 - \alpha)x^{1-\alpha} & \text{for } \alpha \neq 1 \\ \ln x & \text{for } \alpha = 1. \end{cases}$$

According to this utility function an agent is risk-averse, risk-neutral, risk-loving, respectively, for $\alpha > 0$, $\alpha = 0$, $\alpha < 0$, respectively. From now on let us assume $\alpha \geq 0$ such that the necessary condition (5.1) that now reads

$$w + (1 - w)(S_5 - x_5)^{-\alpha}(S_5 - 2x_5) = 0, \quad \alpha \neq 1 \quad (5.3)$$

is also sufficient.

From (5.3) it follows that for a risk-neutral individual, i.e. for $\alpha = 0$ the optimal policy in the fifth period is given by

$$x_5^*(S_5, w) = \min \left\{ \frac{1}{2} \left(S_5 + \frac{w}{(1 - w)} \right), S_5 \right\}. \quad (5.4)$$

Note that $\frac{1}{2} \left(S_5 + \frac{w}{(1-w)} \right) \leq S_5$ if and only if $\frac{w}{(1-w)} \leq S_5$.

For a slight degree of risk-averse or risk-loving behavior, respectively, i.e. for α in a small neighborhood of 0, equation (5.3) is not explicitly solvable for x_5 .¹⁶ A comparative static analysis, however, is possible. For that purpose write equation (5.3) as

$$F(S_5, w, \alpha, x_5) = 0 \quad (5.5)$$

where

$$F(S_5, w, \alpha, x_5) = w + (1-w)(S_5 - x_5)^{-\alpha}(S_5 - 2x_5), \quad \alpha \neq 1,$$

and assume that $x_5 < S_5$ and $S_5 > \frac{w}{(1-w)}$. Note that the partial derivatives of the function $F = F(S_5, w, \alpha, x_5)$ are continuous with respect to all variables. Consider now the case where $\alpha = 0$. We then know that equation (5.5) is satisfied by points of the form $(S_5, w, 0, x_5^*(S_5, w, 0))$. Furthermore, the partial derivative of the function F with respect to x_5 evaluated at this point equals $2(w-1) < 0$. Thus, according to the implicit-function theorem it is justified to write $x_5 = x_5(S_5, w, \alpha)$ emphasizing that in a neighborhood of the point $(S_5, w, 0)$ the optimal policy x_5^* is an implicit function of the variables S_5, w and α . Moreover, one has

$$\begin{aligned} \left. \frac{\partial x_5^*}{\partial \alpha} \right|_{(S_5, w, 0)} &= - \left. \frac{\frac{\partial F(\alpha, w, S_5, x_5)}{\partial \alpha}}{\frac{\partial F(\alpha, w, S_5, x_5)}{\partial x_5}} \right|_{(S_5, w, 0, x_5^*(S_5, w, 0))} \\ &= - \frac{1}{2(-1+w)} \left(\ln \frac{1-S_5 + wS_5 + w}{-1+w} \right) w \end{aligned}$$

implying

Remark 2. For the optimal policy in the fifth period it holds that

$$\left. \frac{\partial x_5^*}{\partial \alpha} \right|_{(S_5, w, 0)} > \begin{cases} 0 & \text{for } \frac{w}{1-w} < S_5 < \frac{2-w}{1-w} \\ 0 & \text{for } S_5 = \frac{2-w}{1-w} \\ 0 & \text{for } S_5 > \frac{2-w}{1-w}. \end{cases}$$

Thus a slightly risk-averse (risk-loving) individual who still “lives” in the fifth period will tend to spend more (less) than a risk-neutral individual when $\frac{w}{1-w} < S_5 < \frac{2-w}{1-w}$ and will tend to spend less (more) than a risk-neutral individual when $S_5 > \frac{2-w}{1-w}$. The intuition behind this result is clearly that saving might also be risky since the money is lost should the round end in the fifth period.

In order to relate the observed decisions made in the fifth period to the theoretical results derived above, note that for $x_5 \neq S_5, \frac{S_5}{2}, S_5 - 1$ it follows from equation (5.3) that

$$\alpha = - \frac{\ln \left(\frac{w}{(S_5 - 2x_5)(-1+w)} \right)}{\ln(S_5 - x_5)}. \quad (5.6)$$

With the help of equation (5.6) one can check which observed (x_5, S_5) -combinations can be rationalized by risk-aversion. This is shown in Figures 5.2 - 5.4 in which we can see

¹⁶For $\alpha = 1$ the optimal policy is given by $x_5^*(w, S_5) = \frac{S_5}{2-w}$.

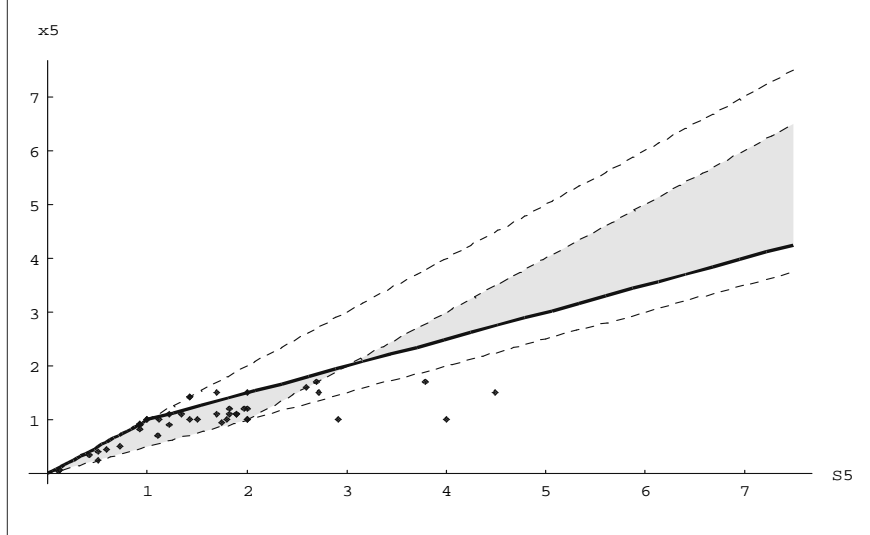

Figure 5.2: Observed (x_5, S_5) -decisions in case of $w = 1/2$ (red die).

the regions¹⁷ that correspond to risk-averse choices (grey shaded areas) together with all observed (x_5, S_5) -combinations.¹⁸

When determining the number of (x_5, S_5) -combinations that are compatible with utility maximization by risk-averse subjects with the help of equation (5.6), one has to exclude certain (x_5, S_5) -combinations. This is due to singularities in equation (5.6) that arise if $x_5 = S_5$, $x_5 = S_5/2$ or $x_5 = S_5 - 1$. Altogether there are 273 cases in which subjects had to decide in the fifth period. But from Remark 1 it follows that values x_5 with $x_5 < \frac{S_5}{2}$ cannot be rationalized by any utility function. As mentioned above there are 24 such cases. Moreover, there are 12 cases with $x_5 = S_5$ (including 5 cases in which it was optimal to set $x_5 = S_5$), 27 cases with $x_5 = \frac{S_5}{2}$, 23 cases with $x_5 + 1 = S_5$ and 15 cases where the two latter conditions apply at the same time, namely, cases with $S_5 = 2$ and $x_5 = 1$ (see Table 5.2).

From the remaining 172 (x_5, S_5) -combinations 89 cases are compatible with utility maximization plus risk-aversion and 83 cases are not compatible. This is also shown in Table 5.2. Note that in the case of the red die being applied almost all cases (from those listed in the last two rows in Table 5.2) can be rationalized by risk-aversion. This is not true in the case of the green die. In this case only 38 % (35 out of 92) of the choices can be rationalized by risk-aversion. This implies that subjects either did not have the assumed preferences or that their attitudes towards risk vary with the termination probability

¹⁷See Appendix A.

¹⁸The results concerning the areas of risk aversion as shown in Figure 5.2 - 5.4 are also true for another class of utility functions. Consider the utility function over money $u(x) = -\exp(-\alpha x)$, $\alpha > 0$, that depict constant absolute risk-aversion. The necessary and sufficient condition (5.1) now reads

$$w \exp(-\alpha c x_5) + (1 - w) (S_5 - 2x_5) \exp(-\alpha c x_5 (S_5 - x_5)) = 0$$

$$\text{or equivalently (for } x_5 \neq S_5, \frac{S_5}{2}, S_5 - 1) \alpha = -\frac{\ln\left(\frac{w}{(S_5 - 2x_5)(-1+w)}\right)}{c x_5 (S_5 - x_5 - 1)}.$$

$$\text{One now easily sees that the following is true } \text{sgn}\left(-\frac{\ln\left(\frac{w}{(S_5 - 2x_5)(-1+w)}\right)}{\ln(S_5 - x_5)}\right) = \text{sgn}\left(-\frac{\ln\left(\frac{w}{(S_5 - 2x_5)(-1+w)}\right)}{c x_5 (S_5 - x_5 - 1)}\right).$$

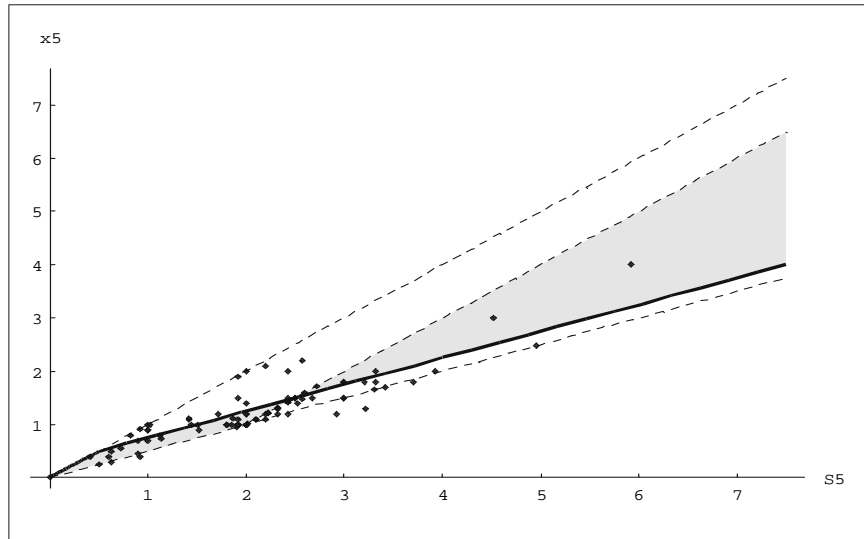

Figure 5.3: Observed (x_5, S_5) -decisions in case of $w = 1/3$ (yellow die).

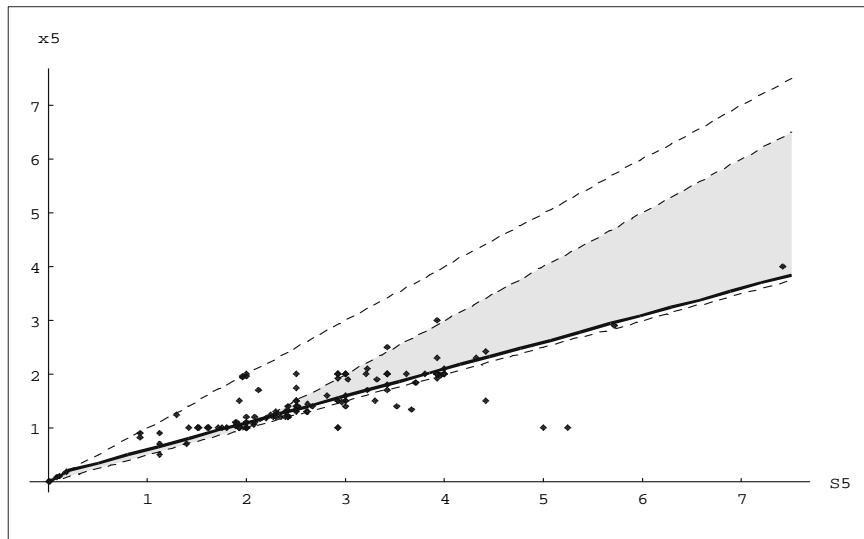

Figure 5.4: Observed (x_5, S_5) -decisions in case of $w = 1/6$ (green die).

	Red ($w = \frac{1}{2}$)	Yellow ($w = \frac{1}{3}$)	Green ($w = \frac{1}{6}$)	Σ
$\#(x_5 = S_5)$	5	4	3	12
$\#(x_5 = S_5/2 \text{ and } x_5 \neq S_5 - 1)$	3	8	16	27
$\#(x_5 = S_5 - 1 \text{ and } x_5 \neq S_5/2)$	2	12	9	23
$\# \left(\begin{array}{l} x_5 = S_5/2 \text{ and } x_5 = S_5 - 1 \\ \Rightarrow x_5 = 1, S_5 = 2 \end{array} \right)$	2	4	9	15
$\#(\text{not rationalizable})$	4	7	13	24
$\# \left(\begin{array}{l} \text{decisions rationalizable} \\ \text{by risk-aversion} \end{array} \right)$	24	30	35	89
$\#(\text{other cases})$	2	24	57	83

Table 5.2: Observed decisions in the fifth period.

which is puzzling from a normative point of view. This is summarized by

Result 5. *If the subjects' preferences can be described by the class of utility functions that exhibit constant relative or constant absolute risk-aversion, then subjects do not act consistently across situations in the sense that they do not show the same attitude towards risk across situations represented by different termination probabilities.*

How can this result be explained? Consider the decision problem to be solved in the fifth period. The choices in periods 1 to 4 may have led to the capital stock $C := x_1x_2x_3x_4$. By the choice of x_5 a subject creates his own lottery in which he is willing to participate. For given $w \in (0, 1)$ and $S_5 > 0$ the choice of $x_5 \leq S_5$ leads to the following lottery: with probability $p_1 = w$ the prize is $L_1 := x_1x_2x_3x_4x_5$ and with probability $p_2 = 1 - w$ the prize is $L_2 := x_1x_2x_3x_4x_5(S_5 - x_5)$. For example, as mentioned above, in 38 out of 273 cases (14 %) subjects chose $x_5 = S_5 - 1$ and thus made sure they did not lose any of the money accumulated during periods 1 to 5 ($L_1 = L_2$). Now note that in the case of the red and green die the amount of money left for the fifth period is on average 1.62 and 2.77 DM, respectively (see Figure 4.1). Thus in the case of the green die a subject can choose a lottery such that $L_2 > L_1 > C$, i.e. in this case a subject can successively (strictly) increase the payoff in every period.

This is not possible with the red die since on average $S_5 < 2$ in this case. Here a subject realizes that he can only participate in lotteries with either $L_1 \geq C$ and $L_2 < L_1$ or $L_1 < C$ and $L_2 \geq L_1$, i.e. it is possible that the payoff shrinks from one period to another. Thus with the green die the experimental situation might usually be perceived as an opportunity to earn successively more money which would make subjects more risk-loving. However, with the red die the possibility of losing some of the accumulated wealth leads subjects to be more risk-averse.

Thus a possible explanation for the Result 5 is that the experimental situation in period 5 is perceived differently depending on the termination probability (or depending on the order of die exclusion and the remaining wealth). This triggers different attitudes towards risk not only across but also within subjects.

6. Summary

The main motivation for this study was the wish to uncover how people tackle dynamic decision problems and to understand what role risk aversion plays in these situations. For that purpose an experimental situation was designed comprised of consumption and savings decisions. The combination of an uncertain time horizon with the successive revealing of the termination probability is the specific characteristic of this experimental situation. Anderhub *et al.* (1997) who also investigate this setup find that on average subjects update their termination probabilities in a qualitatively correct way, i.e. qualitatively in the same way as the optimal solution. Despite these regularities found in average decisions behavior on the individual level is quite dispersed. However, by closely inspecting individual decisions one is able to make out a number of behavioral patterns that range from consistent and thought-out to very inconsistent and irrational behavior and from very risky to cautious behavior. Other findings concerning behavioral rules found in the data are that some individuals systematically neglect information concerning the exclusion of dice and thereby reduce the complexity of the decision tree. Or that subjects start out investing only a small part of their wealth at the beginning of a period and reacting strongly to the information regarding the remaining die. Subjects applying the latter behavioral policy seem to wait until the uncertainty about the termination probability has been removed. We find that most subjects perform reasonably well by applying several interacting heuristics. However, these cannot be easily separated. The interacting heuristics and reasoning processes by which most of the decisions are generated can be best approximated by the strategy that sets current consumption equal to current wealth divided by the expected number of periods. This insight is suggested by a distance measure that relates strategies and heuristics to average observed behavior and by results of regressions that are based on individual decisions. We find, furthermore, that risk-aversion completely predicts the direction of deviations of average observed behavior from the optimal path. Moreover, risk-aversion correctly predicts underconsumption (when compared to the solution assuming risk-neutrality) when the actual termination probability is high and overconsumption when the actual termination probability is on a medium or a low level. The inspection of the decision in the fifth period suggests that subjects do not act consistently across situations in the sense that they do not show the same attitude towards risk across situations represented by different termination probabilities.

References

- [1] Anderhub, V., Güth, W., Härdle, W., Müller, W. and Strobel, M. (1997): On saving, updating and dynamic programming: An experimental analysis, Sonderforschungsbereich 373, Discussion paper No. 32, Humboldt University Berlin.
- [2] Camerer, C. (1995): Individual decision making, in: *Handbook of Experimental Economics*, Kagel, J.H. and A.E. Roth eds., Princeton University Press.
- [3] Carbone, E. and Hey, J.D. (1997): How people tackle dynamic decision problems?, mimeo, University of York

- [4] Fehr, E. and P. Zych (1995): Die Macht der Versuchung: Irrationaler Überkonsum in einem Suchtexperiment, *Zeitschrift für Wirtschafts- und Sozialwissenschaften* 114, Heft 4, 569-604
- [5] Friedman, M. (1953): *Essays in Positive Economics*, Chicago: University Press.
- [6] Hey, J. D. (1983): 'Whither uncertainty?', *Economic Journal* 93 (conference supplement), pp. 129-138.
- [7] Hey, J. and V. Dardanoni (1988): Optimal consumption under uncertainty: An experimental investigation, *Economic Journal*, 98, pp. 105-116.
- [8] Johnson, E. J. and Payne, J. W. (1985): Effort and accuracy in choice, *Management Science*, Vol. 31, No. 4, April 1985, 395-414.
- [9] Johnson, S., L. Kotlikoff and W. Samuelson (1987): Can people compute? An experimental test of the life cycle consumption model, Working Paper, Harvard University.
- [10] Koehler, J. (1996): Making saving easy: An experimental analysis of savings decisions, Preliminary version, Department of Economics and Related Studies, University of York.
- [11] Roth, A.E. (1996): Comments on Tversky's 'Rational Theory and Constructive Choice', in *The Rational Foundations of Economic Behavior*, K. Arrow, E. Colombaro, M. Perlman, and C. Schmidt, eds., Macmillan, 198-202.

APPENDIX A

Areas of risk-aversion

Remark 3. Let $\alpha = -\frac{\ln\left(\frac{w}{(S_5 - 2x_5)(-1+w)}\right)}{\ln(S_5 - x_5)}$ and $w \in (0, 1)$ then it holds that

$$\alpha \begin{cases} = 0 \\ > 0 \end{cases} \begin{cases} \text{iff } x_5 = \frac{1}{2} \left(S_5 + \frac{w}{(1-w)} \right) \text{ and } S_5 > \frac{w}{(1-w)} \\ \text{iff } \begin{cases} 0 < S_5 < \frac{w}{1-w} \text{ and } \frac{1}{2} S_5 < x_5 < S_5 & \text{or} \\ \frac{w}{1-w} < S_5 < 2 \text{ and } \frac{1}{2} S_5 < x_5 \leq \frac{1}{2} \left(S_5 + \frac{w}{1-w} \right) & \text{or} \\ 2 < S_5 < \frac{2-w}{1-w} \text{ and } S_5 - 1 < x_5 \leq \frac{1}{2} \left(S_5 + \frac{w}{1-w} \right) & \text{or} \\ S_5 > \frac{2-w}{1-w} \text{ and } \frac{1}{2} \left(S_5 + \frac{w}{1-w} \right) \leq x_5 < S_5 - 1 & \end{cases} \end{cases}$$

APPENDIX B

Translated Instructions

Your task in every round is to distribute an amount of money as good as possible to several periods. The better you do this, the higher is your payoff. Altogether you play 12 rounds. In the beginning of the experiment you can choose, whether we should draw lots to select one round for which you are paid. Otherwise you will receive the mean of your payoffs of all rounds. In any case you get your payoff in cash after evaluation of the data.

The general task of one round is to distribute a certain amount of money to several periods. Your payoff of one round is calculated by the product of the amounts allocated to the single periods. The difficulty is, that there is no certainty about the number of periods you have to distribute your money. The game can last for three, four, five, or six periods. Every round will last at least for three periods. Whether you reach the fourth, fifth or sixth period, will be determined by throwing a die. There are altogether three different dices with the colors red, yellow and green. The following table shows, in which cases you reach a next period.

COLOR OF DIE	NO FURTHER PERIOD IF DIE SHOWS	NEW PERIOD IF DIE SHOWS
RED	1, 2, 3	4, 5, 6
YELLOW	1, 2	3, 4, 5, 6
GREEN	1	2, 3, 4, 5, 6

The number of periods of one round can not be higher than six. In the beginning of a round you do not know which dice is used for you. You get this information after you have made some decisions. The general course of the game is as follows:

1st period) You will get a total amount of money S , which you can spend in the coming periods. Altogether you can only spend this total amount. You can choose an amount x_1 , which you want to spend in the first period. Think very careful, how much you want to spend and how much you want to save for the following periods. After your decision one of the three dices is excluded. Now you know, that only the two other dices are candidates for the chance move if you reach the fourth, fifth and sixth period.

2nd period) You are choosing an amount x_2 , which you want to spend in the second period. You can not spend more than you have left from the total amount after the first period. After your decision another die is excluded. Now you know, which dice remains to be thrown for the fourth, fifth and sixth period.

3rd period) You are choosing an amount x_3 , which you want to spend in the third period. After this decision the computer will throw the remaining dice in order to decide whether you reach the fourth period. If you do not reach the fourth period, the round ends here. The amount which is not spent until now is lost.

4th period) If you have reached the fourth period, you choose an amount x_4 . For reaching the fifth period, the die will be thrown again.

5th period) If you have reached the fifth period, you choose an amount x_5 . For reaching the sixth period, the die will be thrown again.

6th period) If your have reached the sixth period, you do not have to make a decision, because all remaining money is spent automatically.

Your payoff is calculated by the product of all amounts you spent in the periods you reached. For instance if you experienced exactly four periods, your payoff is determined by $G = x_1 \times x_2 \times x_3 \times x_4$. When you have reached for instance all six periods, your payoff is determined by $G = x_1 \times x_2 \times x_3 \times x_4 \times x_5 \times x_6$ where x_6 is the amount you have left after the fifth period. Please think about the following: If you spend in one period an amount of 0, your payoff will be also 0, because one of the factors is 0. This can happen, for instance, if you spend all money in the fourth period and reach the fifth period. Then you have to spend 0 in the fifth and perhaps also in the sixth period and therefore you

get the payoff 0. You have to weigh up between the risk of spending all your money early or making your money useless if the game ends.