

Cheong, Siew Ann et al.

Article

The Japanese economy in crises: A time series segmentation study

Economics: The Open-Access, Open-Assessment E-Journal

Provided in Cooperation with:

Kiel Institute for the World Economy – Leibniz Center for Research on Global Economic Challenges

Suggested Citation: Cheong, Siew Ann et al. (2012) : The Japanese economy in crises: A time series segmentation study, Economics: The Open-Access, Open-Assessment E-Journal, ISSN 1864-6042, Kiel Institute for the World Economy (IfW), Kiel, Vol. 6, Iss. 2012-5, pp. 1-81, <https://doi.org/10.5018/economics-ejournal.ja.2012-5>

This Version is available at:

<https://hdl.handle.net/10419/56495>

Standard-Nutzungsbedingungen:

Die Dokumente auf EconStor dürfen zu eigenen wissenschaftlichen Zwecken und zum Privatgebrauch gespeichert und kopiert werden.

Sie dürfen die Dokumente nicht für öffentliche oder kommerzielle Zwecke vervielfältigen, öffentlich ausstellen, öffentlich zugänglich machen, vertreiben oder anderweitig nutzen.

Sofern die Verfasser die Dokumente unter Open-Content-Lizenzen (insbesondere CC-Lizenzen) zur Verfügung gestellt haben sollten, gelten abweichend von diesen Nutzungsbedingungen die in der dort genannten Lizenz gewährten Nutzungsrechte.

Terms of use:

Documents in EconStor may be saved and copied for your personal and scholarly purposes.

You are not to copy documents for public or commercial purposes, to exhibit the documents publicly, to make them publicly available on the internet, or to distribute or otherwise use the documents in public.

If the documents have been made available under an Open Content Licence (especially Creative Commons Licences), you may exercise further usage rights as specified in the indicated licence.



<http://creativecommons.org/licenses/by-nc/2.0/de/deed.en>

The Japanese Economy in Crises: A Time Series Segmentation Study

Siew Ann Cheong

Nanyang Technological University

Robert Paulo Fornia

University of Colorado at Boulder

Gladys Hui Ting Lee

Nanyang Technological University

Jun Liang Kok

Nanyang Technological University

Woei Shyr Yim

Nanyang Technological University

Danny Yuan Xu

Bard College, Amundale-on-Hudson

Yiting Zhang

Nanyang Technological University

Abstract The authors performed a comprehensive time series segmentation study on the 36 Nikkei Japanese industry indices from 1 January 1996 to 11 June 2010. From the temporal distributions of the clustered segments, we found that the Japanese economy never fully recovered from the extended 1997–2003 crisis, and responded to the most recent global financial crisis in five stages. Of these, the second and main stage affecting 21 industries lasted only 27 days, in contrast to the two-and-a-half-years across-the-board recovery from the 1997–2003 financial crisis. We constructed the minimum spanning trees (MSTs) to visualize the Pearson cross correlations between Japanese industries over five macroeconomic periods: (i) 1997–1999 (Asian Financial Crisis), (ii) 2000–2002 (Technology Bubble Crisis), (iii) 2003–2006 (economic growth), (iv) 2007–2008 (Subprime Crisis), and (v) 2008–2010 (Lehman Brothers Crisis). In these MSTs, the Chemicals and Electric Machinery industries are consistently hubs. Finally, we present evidence from the segment-to-segment MSTs for flights to quality within the Japanese stock market.

Special Issue **New Approaches in Quantitative Modeling of Financial Markets**

JEL C21, C31, E32, O53

Keywords Japanese industries, macroeconomic cycle, financial crisis, economic recovery, financial time series, segmentation, clustering, cross correlations, minimal spanning tree

Correspondence Siew Ann Cheong, Division of Physics and Applied Physics, School of Physical and Mathematical Sciences, Nanyang Technological University, 21 Nanyang Link, Singapore 637371, Republic of Singapore, e-mail: cheongsa@ntu.edu.sg

Citation Siew Ann Cheong, Robert Paulo Fornia, Jun Liang Kok, Gladys Hui Ting Lee, Danny Yuan Xu, Woei Shyr Yim, and Yiting Zhang (2012). The Japanese Economy in Crises: A Time Series Segmentation Study. *Economics: The Open-Access, Open-Assessment E-Journal*, Vol. 6, 2012-5. <http://dx.doi.org/10.5018/economics-ejournal.ja.2012-5>

© Author(s) 2012. Licensed under a [Creative Commons License - Attribution-NonCommercial 2.0 Germany](http://creativecommons.org/licenses/by-nc/2.0/)

1 Introduction

Under the austere leadership of Junichiro Koizumi between 2001 and 2006, Japan emerged from the ‘lost decade’, ending a protracted period of recession and unimpressive economic growth since the asset bubble burst in 1986. Unfortunately, this long-awaited growth — and Japan’s ambitions to return to its heydays of the 1970s and 1980s, is almost immediately pitted against the most severe global financial crisis in recent history. A great slump in global investment and demand for Japanese exports in late 2008 sent Japan plunging back into recession. The rapid succession of five prime ministers in four years following Koizumi (see Table 1) most certainly does not help the cause of this only fully modernized country in Asia, which is also the third largest economy in the world.

Table 1: List of Japanese Prime Ministers since September 2006

Name	Term of Office	Party	Remark
Shinzo Abe	26 Sep 2006–26 Sep 2007	Liberal Democratic Party	resign
Yasuo Fukuda	26 Sep 2007–24 Sep 2008	Liberal Democratic Party	resign
Taro Aso	24 Sep 2008–16 Sep 2009	Liberal Democratic Party	defeated in elections
Yukio Hatoyama	16 Sep 2009–8 Jun 2010	Democratic Party of Japan	resign
Naoto Kan	8 Jun 2010–present	Democratic Party of Japan	

On the surface, only the exits of Yasuo Fukuda and Taro Aso are tied to Japan’s economic performance. However, observers agree that under the leadership of Yukio Hatoyama, the DPJ had struggled with the country’s economic woes, and delivering its electoral promises. The current DPJ Prime Minister, Naoto Kan, who took office a little more than half a year ago, does not seem to be faring any better (Fox News, 2010). Certainly, there was no lack of effort on the part of Naoto Kan (Today, 2011). Are there perhaps deep structural problems with the Japanese economy that Japan’s leaders do not understand? Are these structural problems preventing the country from responding more positively to all the stimulus measures that have been tried? Clearly, a time bomb is ticking away, with Japan’s huge and growing deficit (Yoshino and Mizoguchi, 2010; Japan Economy News & Blog, 2010), coupled with its rapidly ageing population (Faruqee and Mühleisen, 2003;

MacKellar, 2004). There is thus an urgent need to restart the Japanese economic engine.

To such a complex multifaceted problem there have been dissonant views. Reflecting on the 'lost decade', Iida and Matsumae (2009) argued that it is fundamentally misguided to rake up a huge deficit to finance public works, finance this deficit by issuing bonds, and hope that the public spending will revive the economy. Posen (1998), on the other hand, believe that austerity and government inaction are responsible for the 'lost decade', and argued for deficit spending by the government to drive spending and investment in the private sectors. In particular, he believe the Bank of Japan raised interest rates too late to arrest the asset bubble, and lowered interest rates too late to stimulate recovery. Performing a vector autoregression analysis, Bayoumi (2001) found the disruption of financial intermediation as a result of falling property prices to contribute most significantly to Japan's sluggish economic performance. On the other hand, after examining the Japanese economy for the 1990s, Hayashi and Prescott (2002) concluded that the 'lost decade' was not due to a breakdown in the financial system. Citing the lack of evidence for corporations large and small being shut out of profitable investment opportunities due to lack of access to capital markets, they argued instead that the main problem faced by Japan then and now is a low productivity growth rate. Amyx (2004) concurred in part, when she blamed in her book the institutional rigidity and social reluctance to embrace change for Japan's prolonged economic recession.

In contrast to the widely disparate opinions on what are the causes of Japan's economic woes, experts all agree on the need for reforms (Hoshi and Kashyap, 2004; Bigsten, 2005; Kurihara, 2007). In the depth of the 2007–2010 global financial crisis, the DPJ government led by Yukio Hayotama reversed Junichiro Koizumi's 2005 decision to privatize Japan Post, one of Japan's largest companies, and also the largest holder of personal savings in the world. This move have been criticized as a reform in the wrong direction (Wall Street Journal, 2009). To prevent an economic meltdown, the International Monetary Fund (IMF) urged Japan to increase its consumption taxes to combat rising public debts (Reuters, 2010). In Japan, such a move is of course tantamount to political suicide. In any case, there are also doubts on whether raising consumption taxes would be effective, given how reluctant Japanese consumers are to spend money, even after the Bank of Japan put in place a zero interest rate policy that makes saving an extremely unattractive

option. Naturally, money is still flowing around in Japan. For the government to develop sound macroeconomic policies to unclog blocked arteries, it is important to understand how money flows at all levels in the Japanese economy. In this paper, we hope to provide some insights on this problem.

Recently, we adapted a recursive entropic scheme to segment biological sequences, for use on high-frequency financial time series. Through segmenting the Dow Jones Industrial Average (DJIA) Index time series between January 1997 and August 2008, we found that the US economy went from a low-volatility growth phase into a high-volatility crisis phase twice during this period (Wong et al., 2009). The first crisis phase was from mid-1998 to mid-2003, triggered by the Asian Financial Crisis and sustained by the dotcom bubble bursting, whereas the second crisis phase started in mid-2007, apparently triggered by the February 2007 Chinese Correction, and leading on to the Subprime Crisis. When we extended this study to the cross section of ten Dow Jones US (DJUS) Economic Sector Indices, we found a slow one-and-a-half-year complete recovery from the 2000–2003 technology crisis and a rapid two-month descent into the Subprime Crisis (Lee et al., 25 Nov 2009). Comparing the sequence of seven closely-timed interest rate cuts by the Federal Reserve against the time series segment boundaries, we also found the first two cuts lowered market volatility across a broad spectrum of economic sectors, the next two cuts raised market volatility across an equally broad cross section of economic sectors, and then finally, the last three cuts to have no permanent effect on market volatilities.

Delving deeper into the cross section study, we computed the pairwise Pearson cross correlations between the ten DJUS economic sectors over the two crisis periods, the growth period between them, and also within time series segments of various volatilities (Zhang et al., 2011). Constructing the minimal spanning trees (MSTs) of these cross correlations, we found that the growth sectors such as industrials, consumer goods, and consumer services consistently form the core of the MSTs, whereas quality sectors such as basic materials, oil & gas, healthcare, and utilities frequently reside on the fringe of the MSTs. More importantly, we found that economic growth is robustly characterized by a star-like MST (which has a smaller network diameter, because of the presence of highly-connected and central nodes), whereas economic crisis is robustly characterized by a chain-like MST (which has a larger network diameter, because of the absence of highly-

connected and central nodes). In this paper, we perform a detailed time series segmentation and MST analysis on the 36 Nikkei 500 Japanese industry indices between 1 January 1996 to 11 June 2010, to better understand the dynamics of the Japanese economy, contrast it against the US macroeconomic dynamics, and perhaps offer policy-relevant insights.

Our paper is organized as follows. In Section 2, we will describe the data sets used, the statistical principles behind the recursive segmentation procedure and the grouping of time series segment into different volatility clusters, as well as how MSTs are constructed from the cross correlations. In Section 3, we will examine the temporal distributions of clustered segments of the 36 Nikkei industry indices. Here, we report our finding that the Japanese economy took two and a half years to recover from the 1997–2003 continuum of financial crises, but only 27 days for 21 out of 36 industries to succumb to the Subprime Crisis. In Section 4, we construct the MSTs over the growth and crisis periods, to identify the core industries in the Japanese economy. Here, we report our finding that the Chemicals and Electric Machinery industries are consistently hubs in these MSTs, indicating that the overall mood in the Japanese economy is strongly dependent on the performance of these two industries. Measuring the diameter of these MSTs, we also find the MSTs to be growing more ‘open’ over the years. In Section 5, we analyze the MSTs of consecutive time series segments, and report signatures of flights to quality episodes within the Japanese stock market. Here we find that the Foods, Nonferrous Metals, and Railway/Bus industries to be the preferred quality industries. Finally, we conclude in Section 6.

2 Data and Methods

2.1 Data

Tic-by-tic data of the 36 Nikkei Japanese industry indices (see Table 2) from 1 January 1996 to 11 June 2010 was downloaded from the Thomson-Reuters Tickhistory database (<https://tickhistory.thomsonreuters.com/>). Our main interest lies in the identification of macroeconomic phases, which should not be shorter than a day. Therefore we use only the half-hourly index values

$X_i = \{X_{i,1}, X_{i,2}, \dots, X_{i,t}, \dots, X_{i,N}\}$ for $N = 51,900$ half-hours, and $i = 1, \dots, 36$ are the industry indices shown in Table 2. We use this data frequency because it provides adequate statistics to identify segments as short as a day, but not shorter. Higher data frequencies are possible, since the indices are updated every minute during the trading hours, but we do not use these, because they will lead to short intraday segments which we are not interested in.

Table 2: The 36 Nikkei 500 industry indices

<i>i</i>	Symbol	Industry	<i>i</i>	Symbol	Industry
1	NAIR	Air Transport	19	NMNG	Mining
2	NAUT	Automotive	20	NNFR	Nonferrous Metals
3	NBKS	Banking	21	NOIL	Oil & Coal Products
4	NCHE	Chemicals	22	NPRC	Precision Instruments
5	NCMU	Communications	23	NREA	Real Estate
6	NCON	Construction	24	NRET	Retail
7	NELC	Electric Power	25	NRRL	Railway/Bus
8	NELI	Electric Machinery	26	NRUB	Rubber Products
9	NFIN	Other Financial Services	27	NSEA	Marine Transport
10	NFIS	Fisheries	28	NSEC	Securities
11	NFOD	Foods	29	NSPB	Shipbuilding
12	NGAS	Gas	30	NSTL	Steel Products
13	NGLS	Glass & Ceramics	31	NSVC	Services
14	NISU	Insurance	32	NTEQ	Other Transport Equipment
15	NLAN	Other Land Transport	33	NTEX	Textiles & Apparel
16	NMAC	Machinery	34	NTIM	Pulp & Paper
17	NMED	Pharmaceuticals	35	NTRA	Trading Companies
18	NMIS	Other Manufacturing	36	NWHO	Warehousing

Each of the 36 Nikkei 500 industry indices is a price-weighted average of stocks which are components of the Nikkei 500 index. The Nikkei 500 index was first calculated on January 4, 1972 with a value of 223.70, and its 500 component stocks are selected from the first section of the Tokyo Stock Exchange based on trading volume, trading value and market capitalization for the preceding three years. The makeup of the Nikkei 500 is reviewed yearly, and each year approximately 30 stocks are replaced. The present components, sorted according to industry, are listed in Tables A1–A36 in the Appendix.

2.2 Segmentation

In the economics and finance literature, we find various methods to segment highly nonstationary financial time series into stationary segments called *regimes* or *trends*. Following the pioneering works by Goldfeld and Quandt (1973), and by Hamilton (1989), there is by now an enormous literature on detecting *structural breaks* or *change points* separating stationary segments. A few of these are based on the original Markov switching models (Kim and Nelson, 1999), but most are based on autoregressive models and unit-root tests.¹ This time series segmentation problem is also starting to attract the attention of econophysicists. Before our own works, Vaglica et al. (2008) broke the transaction histories of three highly liquid stocks on the Spanish stock market into directional segments to study trading strategies adopted in this market. Tóth et al. (2010) later segmented the time series of market orders on the London Stock Exchange, modeling each segment by a stationary Poisson process.

Because different indices have different benchmark values, it is more reasonable to compare their fractional changes. Instead of the half-hourly index time series $X_i = \{X_{i,1}, \dots, X_{i,N}\}$, we consider the half-hourly log-index movement time series $x_i = \{x_{i,1}, \dots, x_{i,t}, \dots, x_{i,n}\}$, where $x_{i,t} = \ln X_{i,t+1} - \ln X_{i,t}$ and $n = N - 1$. To determine the M_i stationary segments in a given time series x_i , we typically assume a common statistical model for the log-index movements in all M_i segments. We know from the seminal work of Mantegna and Stanley (1995) that high-frequency index movements are best modeled by Lévy stable distributions. However, parameter estimation (Fama and Roll, 1971; Hill, 1975; Koutrouvelis, 1980, 1981; McCulloch, 1986; Zolotarev, 1986; Nolan, 1998, 2001) and probability density calculation (Worsdale, 1975; Panton, 1992; McCulloch and Panton, 1997; Nolan, 1997, 1999) for Lévy stable distributions are computationally expensive, and not suited to the recursive scheme we employ to segment the time series. Our experience segmenting biological sequences tells us that statistically significant segment boundaries can be discovered by any segmentation procedure, whatever

¹ See Bai (1994), Bai (1995), Chong (1995), Loader (1996), Bai (1997), Lumsdaine and Papell (1997), Bai and Perron (1998), Lavielle and Moulines (2000), Chong (2001), Hansen (2001), Zivot and Andrews (2002), Bai and Perron (2003), Perron and Zhu (2005), Guo and Wohar (2006), Carrion-i-Silvestre et al. (2009).

the assumed model. We therefore believe that the most statistically significant segment boundaries in financial time series would also be equally insensitive to choice of model. Indeed, in a limited study we have performed (Eng, Apr 2010), where we compare normally-distributed log-index movement segments against Lévy-stably-distributed log-index movement segments of the 2002–2003 DJIA half-hourly time series, we find that the strongest segment boundaries are in good agreement (no more than two days apart). With this reassurance, we chose to intentionally mis-specify the model, assuming that the log-index movements in segment m_i follow a stationary Gaussian process with mean μ_{i,m_i} and variance σ_{i,m_i}^2 . Unlike the Lévy stable distribution, the Gaussian parameters μ_{i,m_i} and σ_{i,m_i}^2 can be estimated very cheaply.

To find the unknown segment boundaries t_{i,m_i} separating segments m_i and $m_i + 1$, we use the recursive segmentation scheme introduced by Bernaola-Galván et al. (1996) and Román-Roldán et al. (1998). In this segmentation scheme, we check how likely it is for the point t in the time series $x = (x_1, \dots, x_t, x_{t+1}, \dots, x_n)$ to be a segment boundary, by computing the likelihoods

$$L_1 = \prod_{s=1}^n \frac{1}{\sqrt{2\pi\sigma^2}} \exp \left[-\frac{(x_s - \mu)^2}{2\sigma^2} \right], \quad (1)$$

and

$$L_2(t) = \prod_{s=1}^t \frac{1}{\sqrt{2\pi\sigma_L^2}} \exp \left[-\frac{(x_s - \mu_L)^2}{2\sigma_L^2} \right] \prod_{s=t+1}^n \frac{1}{\sqrt{2\pi\sigma_R^2}} \exp \left[-\frac{(x_s - \mu_R)^2}{2\sigma_R^2} \right]. \quad (2)$$

Here, L_1 is the likelihood that x is generated by a single Gaussian process with mean μ and variance σ^2 , whereas $L_2(t)$ is the likelihood that x is generated by two statistically distinct processes: the left segment $x_L = (x_1, \dots, x_t)$ by a Gaussian process with mean μ_L and variance σ_L^2 , and the right segment $x_R = (x_{t+1}, \dots, x_n)$ by a Gaussian process with mean μ_R and variance σ_R^2 . Because the two additional parameters, the two-segment model always fits x better than the one-segment model, i.e. $L_2(t) > L_1$. This improvement in fit can be measured using the Jensen–Shannon divergence (Lin, 1991)

$$\Delta(t) = \ln \frac{L_2(t)}{L_1} \geq 0, \quad (3)$$

which is the logarithm of the ratio of likelihoods. When we replace the Gaussian parameters $\mu, \mu_L, \mu_R, \sigma^2, \sigma_L^2, \sigma_R^2$ by their maximum likelihood estimates $\hat{\mu}, \hat{\mu}_L, \hat{\mu}_R$ and $\hat{\sigma}^2, \hat{\sigma}_L^2, \hat{\sigma}_R^2$, the Jensen–Shannon divergence $\Delta(t)$ simplifies to

$$\Delta(t) = n \ln \hat{\sigma} - t \ln \hat{\sigma}_L - (n - t) \ln \hat{\sigma}_R + \frac{1}{2} \geq 0. \quad (4)$$

Here, the $+\frac{1}{2}$ constant offset to $\Delta(t)$ comes from the normalizations

$$\begin{aligned} \sum_{s=1}^n (x_s - \hat{\mu})^2 &= (n - 1) \hat{\sigma}^2, \\ \sum_{s=1}^t (x_s - \hat{\mu}_L)^2 &= (t - 1) \hat{\sigma}_L^2, \\ \sum_{s=t+1}^n (x_s - \hat{\mu}_R)^2 &= (n - t - 1) \hat{\sigma}_R^2, \end{aligned} \quad (5)$$

of the unbiased estimators $\hat{\sigma}^2, \hat{\sigma}_L^2$, and $\hat{\sigma}_R^2$, with the maximum likelihood means given by

$$\hat{\mu} = \frac{1}{n} \sum_{s=1}^n x_s, \quad \hat{\mu}_L = \frac{1}{t} \sum_{s=1}^t x_s, \quad \hat{\mu}_R = \frac{1}{n - t} \sum_{s=t+1}^n x_s. \quad (6)$$

If we now examine the Jensen–Shannon divergence at all possible times t , we typically find a spectrum like that shown in the top of Fig. 1. This typical Jensen–Shannon divergence spectrum consists of one very strong peak at t^* , for which

$$\Delta^* = \Delta(t^*) = \max_t \Delta(t) \quad (7)$$

is maximized. This is therefore the optimum point to break the time series $x = (x_1, \dots, x_n)$ into two statistically distinct segments $x_L^* = (x_1, \dots, x_{t^*})$ and $x_R^* = (x_{t^*+1}, \dots, x_n)$. This one-into-two segmentation is then applied recursively onto x_L^* and x_R^* to obtain shorter and shorter segments (see the bottom of Fig. 1, for example). When new segment boundaries are introduced, the positions of the old segment boundaries may no longer be optimal. Therefore, at each stage of the

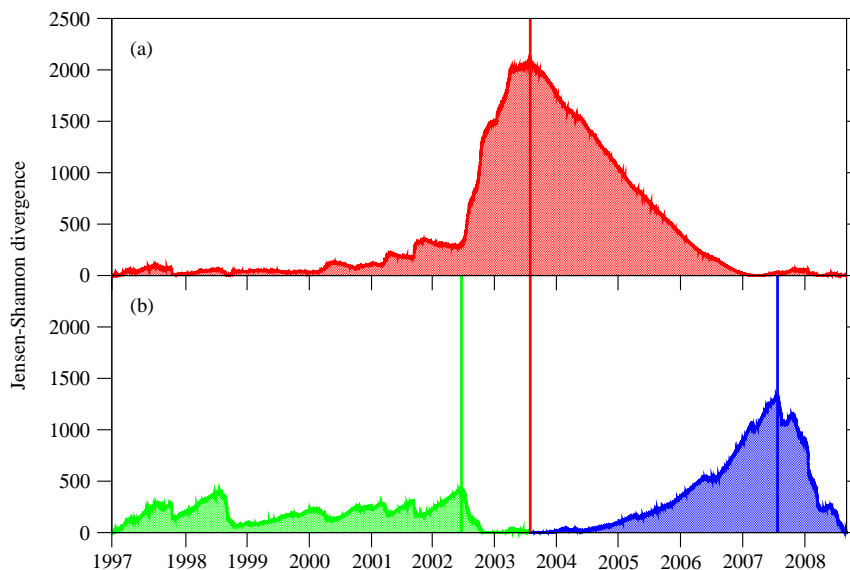

Figure 1: The Jensen–Shannon divergence spectrum for (a) the DJIA time series from Jan 1997 to Aug 2008 (red). This is a typical spectrum consisting of one very strong peak, in this example, at mid-2003. Also shown (b) are the Jensen–Shannon divergence spectra for the left segment (green, 1997 to mid-2003) and the right segment (blue, mid-2003 to Aug 2008) obtained at the second stage of the recursive segmentation. In this example, the two segments have divergence maxima at mid-2002 and mid-2007 respectively.

recursive segmentation, we optimize the positions of all segment boundaries m within the time series subsequences bound by segment boundaries $m \pm 1$ (see Fig. 2, for example). We do this iteratively until all segment boundaries have converged onto their optimum positions (Cheong et al., 2009a).

As we continue to discover segment boundaries using the optimized recursive segmentation procedure, we will at some point exhaust all the statistically significant ones, and start to pick up those which are statistically insignificant. This is reflected in the Jensen–Shannon divergence of newly discovered segment boundaries becoming smaller and smaller in general. We must therefore terminate the recursive segmentation when all or nearly all the statistically significant segment boundaries have been found. In the literature, we find three ways to do this. In

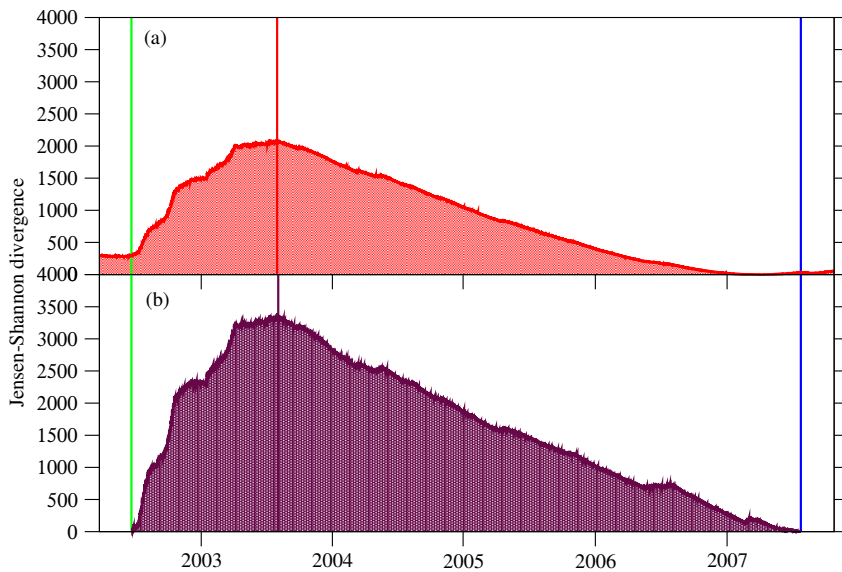

Figure 2: The Jensen–Shannon divergence $\Delta(t)$ of the Dow Jones Industrial Average time series computed in (a) the first stage of the recursive segmentation over the entire half-hourly time series from January 1997 to August 2008. The optimum segment boundary was identified to be at $t_1^* \approx$ mid-2003. After the second stage of the recursive segmentation, two new segment boundaries were discovered at $t_2^* \approx$ mid-2002 and $t_3^* \approx$ mid-2007. When $\Delta(t)$ was recomputed (b) over the interval (t_2^*, t_3^*) , the optimum position for t_1^* is now shifted slightly to $t_1'^*$.

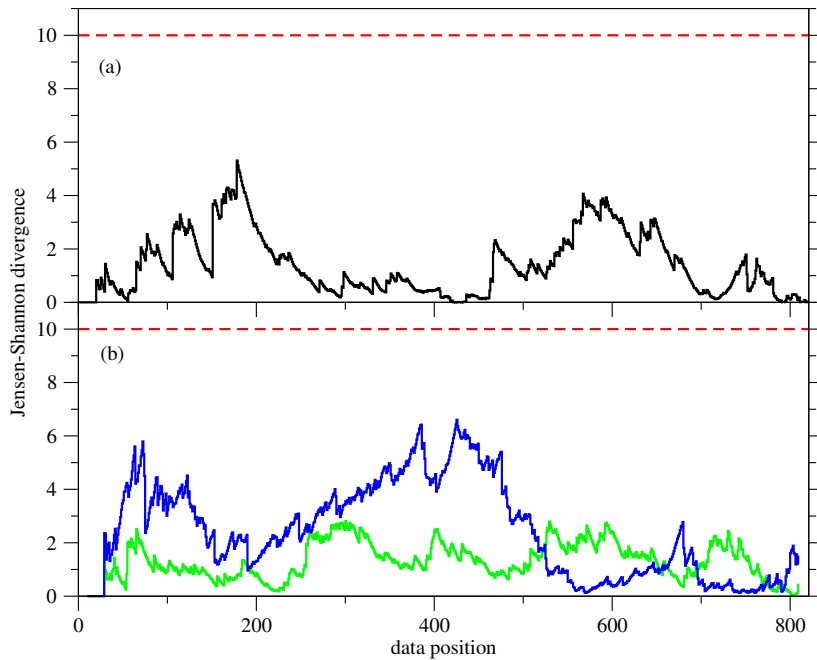

Figure 3: The Jensen–Shannon divergence $\Delta(t)$ of (a) a moderate-length (821 half hours, or equivalently, about 55 trading days) times series segment of the Dow Jones Industrial Average. Contrast this to (b), where $\Delta(t)$ is obtained from a 821-point time series generated by a stationary Gaussian process. In this example, the peak $\Delta_{\max} \approx 5.5$ at the data position of about 200 is only as strong as the typical divergence maximum obtained from a stationary Gaussian process of the same duration. We therefore do not introduce further segment boundaries.

the first approach, the Jensen–Shannon divergences of new segment boundaries are tested for statistical significance against various χ^2 distributions with the appropriate degrees of freedom (Bernaola-Galván et al., 1996; Román-Roldán et al., 1998). When no new segment boundaries are more significant than the chosen confidence level p , the recursive segmentation terminates. In the second approach, new segment boundaries are accepted if the information criteria of the segmented time series exceeds the information criteria of the unsegmented time series (Li, 2001b,a). Here, the recursive segmentation terminates when further segmentation does not produce a time series model that explain the data better. In the third approach, new segment boundaries are accepted if their Jensen–Shannon divergences are larger than the amplitudes of typical fluctuations in the Jensen–Shannon divergence spectra (Cheong et al., 2009a). Recursive segmentation stops when the signal-to-noise ratios $\Delta/\delta\Delta$ of all new segment boundaries fall below a chosen threshold value.

To simplify the recursive segmentation, we adopted a conservative threshold of $\Delta_0 = 10$, i.e. recursive segmentation terminates when no new optimized segment boundaries with Jensen–Shannon divergence greater than a cutoff of $\Delta_0 = 10$ are found. We then examine the segments found by this simplified procedure. We find empirically that the short and medium terminal segments can no longer be further segmented. The long terminal segments, on the other hand, frequently have internal segment structures masked by their context (Cheong et al., 2009b). These we further segment, by progressively lowering the threshold $\Delta_0 \rightarrow \Delta'_0 < 10$ until a segment boundary with strength $\Delta > \Delta_0$ appears. Based on our previous experiences (Wong et al., 2009; Lee et al., 25 Nov 2009; Zhang et al., 2011), this semi-automatic recursive segmentation produces acceptable results.

2.3 Segment Clustering

The number of time series segments obtained for each Nikkei 500 industry is shown in Table 3. The smallest number of time series segments is 59, for the Textiles & Apparel industry, and the largest number of time series segments is 162, for the Securities industry. Whatever the industry, successive segments are statistically distinct from each other. However, segments that are far apart can actually be statistically similar. Based on the standard macroeconomic classification

Table 3: Number of time series segments for the 36 Nikkei 500 industry indices

<i>i</i>	Symbol	Segments	<i>i</i>	Symbol	Segments
1	NAIR	82	19	NMNG	116
2	NAUT	115	20	NNFR	123
3	NBKS	138	21	NOIL	94
4	NCHE	117	22	NPRC	104
5	NCMU	138	23	NREA	126
6	NCON	109	24	NRET	153
7	NELC	139	25	NRRL	142
8	NELI	147	26	NRUB	116
9	NFIN	125	27	NSEA	118
10	NFIS	105	28	NSEC	162
11	NFOD	113	29	NSPB	90
12	NGAS	60	30	NSTL	141
13	NGLS	124	31	NSVC	117
14	NISU	104	32	NTEQ	59
15	NLAN	98	33	NTEX	95
16	NMAC	124	34	NTIM	95
17	NMED	118	35	NTRA	130
18	NMIS	121	36	NWHO	86

of different market periods into four *phases* or *regimes*: (i) a growth phase; (ii) a contraction phase; (iii) a correction phase; and (iv) a crash phase, we also expect the numerous time series segments to be organized into roughly four *segment classes*. To determine these segment classes, we performed hierarchical agglomerative clustering of the segments within each Nikkei 500 industry independently (see Jain et al. (1999) for a review of the broad area of statistical clustering). We chose the complete linkage algorithm, favored by social scientists for producing compact and internally homogeneous clusters (Baker, 1972), because our goal is to discover macroeconomic phases with well-defined statistical properties. In contrast, the more popular single link algorithm (Sneath, 1957; Johnson, 1967), which is more meaningful in the biological sciences because it corresponds more closely with the nature of evolutionary changes, tends to produce loose and elongated clusters (Baker, 1974).

Using the Jensen–Shannon divergences between segments as their statistical distances, we typically end up with a dendrogram like that shown in Fig. 4 for

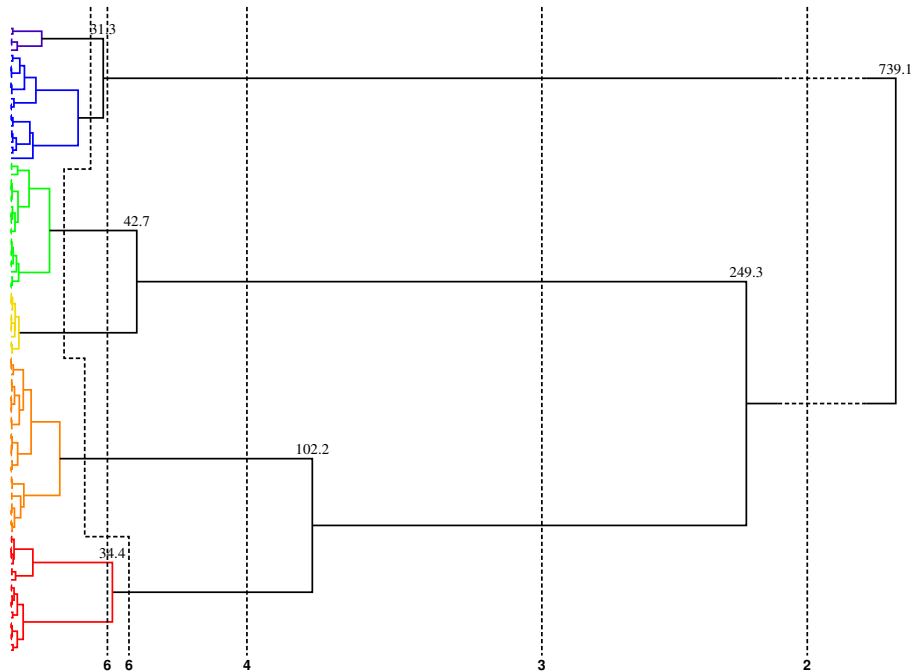

Figure 4: The complete-link hierarchical clustering dendrogram for the time series segments of the Dow Jones Industrial Average between January 1997 and August 2008. In this tree, we show the Jensen–Shannon divergence values at which the top branches diverge. If we choose a uniform threshold $249.3 < \Delta < 739.1$, we can identify two clusters. On the other hand, if we choose a uniform threshold $102.2 < \Delta < 249.3$, we will end up with three clusters. We can also identify six clusters, if we choose a uniform threshold $31.3 < \Delta < 34.4$. Alternatively, individualized thresholds can be selected to obtain the six robust clusters reported in Wong et al. (2009), which are colored in increasing order of market volatility as deep blue, blue, green, yellow, orange, and red.

the Dow Jones Industrial Average. Different number of clusters can be identified by varying a uniform threshold. Fewer clusters means that we have a coarser description, whereas more clusters means that we have a finer description of the dynamics within the time series. Within this nested hierarchy of coarse-grained description of the Japanese macroeconomic dynamics, some descriptions are more useful than others because they are statistically more robust. In Fig. 4, for example, we see that a four-cluster description is more robust, because it extends over a larger range of uniform thresholds $42.7 < \Delta < 102.2$, whereas a five-cluster and six-cluster descriptions are less robust, because they extend over smaller range of uniform thresholds $34.4 < \Delta < 42.7$ and $31.3 < \Delta < 34.4$, respectively.

Ultimately, different choices of robust clusters tell the same story with different contrasts, very much like red-tinted and blue-tinted versions of the same photograph. With this understanding in mind, we selected four to five clusters for each of the 36 Nikkei 500 industries, depending on which description is the most robust statistically. Thereafter, we color the time series segments blue to green to yellow to orange to red, in increasing order of volatility, as shown in Table 4. With this color scheme, we plot the *temporal distributions of clustered segments* for the 36 Japanese industries. The analyses presented in this paper are based on features identified from the temporal distributions of clustered segments for the 36 Nikkei 500 industry indices.

In general, extremely-high-volatility red segments are very short, and coincide with periods of greatest market uncertainties. Therefore, their interpretation as the crash phase of the market is unambiguous. In our previous work on the US market (Wong et al., 2009; Lee et al., 25 Nov 2009; Zhang et al., 2011), and also ongoing study on the European markets, we saw that moderate-volatility green segments are also short, and coincide with periods where the market underwent corrections according to commentators. We therefore associated these as the correction phase, and chose to interpret the longer green time series segments in the Japanese market as evidence for structural differences between Japan and the US/European markets. Similarly, based on the timings of the low-volatility blue segments and high-volatility yellow/orange segments in the US and European markets (and to a great extent, also in the Japanese market), we associate these with the growth and crisis phases respectively.

Table 4: Color scheme for the five volatility clusters, and the macroeconomic phases they correspond to

<i>Volatility</i>	Low	Moderate	High	Very high	Extremely high
<i>Color</i>	Blue	Green	Yellow	Orange	Red
<i>Phase</i>	Growth	Correction	Crisis		Crash
NAIR	0.003076	0.004810	0.007298	0.014102	-
NAUT	0.001897	0.003320	0.005405	0.008208	0.018155
NBKS	0.001619	0.002490	0.003930	0.007180	0.017130
NCHE	0.002267	0.003435	0.004619	0.007269	0.016209
NCMU	0.002468	0.003643	0.005877	0.009537	0.017001
NCON	0.002091	0.003201	0.004171	0.006756	0.015177
NELC	0.001194	0.002046	0.003509	0.006230	0.014315
NELI	0.002138	0.003524	0.005038	0.007979	0.015629
NFIN	0.002729	0.005090	0.007090	0.011174	0.028018
NFIS	0.001912	0.003815	0.006567	0.012460	0.028647
NFOD	0.001620	0.002680	0.003687	0.005215	0.009986
NGAS	0.002490	0.003694	0.005027	0.007378	0.016906
NGLS	0.002359	0.003845	0.005440	0.009608	0.022268
NISU	0.002864	0.004335	0.006487	0.014458	-
NLAN	0.002434	0.003489	0.004706	0.006529	0.016302
NMAC	0.002102	0.003545	0.005543	0.008346	0.017493
NMED	0.001855	0.002942	0.003914	0.007098	0.014396
NMIS	0.002002	0.002963	0.004201	0.007217	0.018282
NMNG	0.004580	0.007369	0.011228	0.022301	-
NNFR	0.001628	0.003456	0.005484	0.008297	0.017209
NOIL	0.002745	0.004461	0.006435	0.012054	0.023781
NPRC	0.002317	0.004005	0.005991	0.010417	0.020013
NREA	0.003226	0.004716	0.006432	0.011102	0.020469
NRET	0.002099	0.003547	0.005641	0.008193	0.013952
NRRL	0.001387	0.002583	0.003982	0.006202	0.011068
NRUB	0.002961	0.004065	0.005662	0.009723	0.019501

Table 4: (continued)

<i>Volatility</i>	Low	Moderate	High	Very high	Extremely high
<i>Color</i>	Blue	Green	Yellow	Orange	Red
<i>Phase</i>	Growth	Correction	Crisis		Crash
NSEA	0.004104	0.006678	0.010820	0.019426	-
NSEC	0.002294	0.003608	0.005474	0.008804	0.018534
NSPB	0.002998	0.005229	0.008543	0.014320	0.024994
NSTL	0.002709	0.004478	0.007228	0.014450	-
NSVC	0.001870	0.002692	0.003736	0.005765	0.011990
NTEQ	0.004331	0.006241	0.007555	0.009718	0.023070
NTEX	0.002045	0.003111	0.004462	0.007923	0.018235
NTIM	0.002452	0.003986	0.005250	0.006507	0.013207
NTRA	0.002439	0.003710	0.005263	0.007669	0.017821
NWHO	0.003358	0.005089	0.007388	0.012246	0.027377

This association may seem unusual, but let us explain. In the economics literature, growth is defined as positive change to the gross domestic product (GDP), which is an aggregate measure of all goods produced and services rendered, over a given period of time. Frequently, this period is one year, although quarterly estimates and monthly corrections to the GDP are also announced. Similarly, recession is defined as sustained decrease in the GDP, or the performance of a broad spectrum of industries. The duration over which the GDP must slide before the period is technically accepted as a recession vary from country to country. In the US, GDP change must be negative for three consecutive quarters before the economy is considered in recession. Therefore, economic contraction typically occurs at the end of a crisis phase. Also shown in Table 4 are the average standard deviation in each phase for the 36 Nikkei 500 industries.

From the study of dynamical systems, variables such as the GDP are called slow variables, because they are expected to change slowly with time, whereas variables such as stock indices are called fast variables, because they are observed to change rapidly with time. Economists already understand that fast variables are slaved to slow variables, and sometimes use the long-term trend in stock indices as a proxy for the GDP and economic performance. However, we understand that in addition to its long-term trend, the fluctuations of a fast variable is also

strongly influenced by the state of the slow variables. This means that the stock index fluctuations during economic growth should be statistically distinct from that during economic crisis. This is a generic feature of the dynamics of systems with many interacting degrees of freedom. In this paper, we exploit this observation to associate time series segment clusters characterized primarily by their volatilities, and macroeconomic phases, typically characterized by their slowly evolving long-term trends.

2.4 Corresponding Segments

The most striking features found in the panel of temporal distributions are *corresponding segments* that appear in all or most of the indices. In the economics and finance literature, the consensus that arise from the study of *comovements*,² *common jumps*,³ *common shocks*,⁴ or *common breaks*⁵ is that the statistical significance of a change point is amplified by the cross section it occurs concurrently over.

In our study, the corresponding segments do not necessarily start at the same time. Our use of high-frequency data allows us to identify change points that are individually optimum for the 36 Nikkei 500 industry indices. For the same reason, our corresponding segments also do not end at the same time. Each corresponding segment therefore provides us with three independent parameters: (i) the starting time, (ii) the duration, and (iii) the Jensen–Shannon divergence value at the start of the corresponding segment. The starting times allow us to roughly map out the progress of volatility shocks, whereas the duration and Jensen–Shannon divergence tell us how strongly the shock impact the different industries in the Japanese economy.

To accommodate the different start and end times, segments in the Nikkei 500 industries are marked as corresponding segments if they (i) have similar volatilities

² See Panton et al. (1976), Stockman and Tesar (1995), Karolyi and Stulz (1996), Croux et al. (2001), Forbes and Rigobon (2002), Barberis et al. (2005), Baxter and Kouparitsas (2005).

³ See Barndorff-Nielsen and Shepard (2006), Bollerslev et al. (2008), Jacod and Todorov (2009).

⁴ See Canova and Marrinan (1998), Rigobon (2003), Andrews (2005).

⁵ See Bai et al. (1998), Carrion-i-Silvestre et al. (2005), Im et al. (2005), Bai (2009), Bai and Carrion-i-Silvestre (2009), Kim (2009).

(high and high, or low and low); or (ii) are flanked by volatility movements in the same directions (low-to-high and moderate-to-high, or high-to-low and moderate-to-low). These corresponding segments are identified visually, aided by the heat-map-like color scheme in the temporal distributions shown in Fig. 5.

2.5 Cross-correlations

Segmentation followed by segment clustering gives us a coarse-grained dynamical picture of the Japanese economy that is easy to understand and appreciate. However, in this process we also threw out a lot of useful time series information. Once we have a handle on the gross temporal evolution of the Japanese economy, we can recover the high-frequency time series information, by computing the normalized cross-correlation matrix C , whose matrix element

$$C_{ij} = \frac{\frac{1}{T-1} \sum_{t=1}^T (x_{it} - \bar{x}_i)(x_{jt} - \bar{x}_j)}{\sqrt{\frac{1}{T-1} \sum_{t=1}^T (x_{it} - \bar{x}_i)^2 \frac{1}{T-1} \sum_{t=1}^T (x_{jt} - \bar{x}_j)^2}} \quad (8)$$

is the zero-lag cross-correlation between Japanese industries i and j .

Cross-correlations between different stocks, and between different benchmark indices have been widely studied in the finance literature, in the bid to to understand the meltdown of global financial markets during the present financial crisis.⁶ The econophysics community also pioneered a sophisticated method based on random matrix theory to decompose the cross correlations between different financial time series into a trivial noise part and a nontrivial signal part.⁷ In all these studies, the cross-correlations were computed either over the entire data period, or over sliding windows. In this study, we calculate the cross-correlation matrix over three different time scales: (i) the entire duration of the time series, (ii) two-year intervals strictly within the growth and crisis macroeconomic phases, and (iii) over individual corresponding segments. As shown in Fig. 5, the interval chosen to compute cross correlations within a corresponding segment is such that it includes as little of the preceding and succeeding segments as possible.

⁶ See Lo (2009), Tudor (2009), Cheung et al. (2010), Münnix et al. (30 Jun 2010), Wong and Li (2010).

⁷ See Laloux et al. (1999), Plerou et al. (2002), Utsugi et al. (2004), Wilcox and Gebbie (2004), Wilcox and Gebbie (2007), Çukur et al. (2007), Kulkarni and Deo (2007), Shen and Zheng (2009).

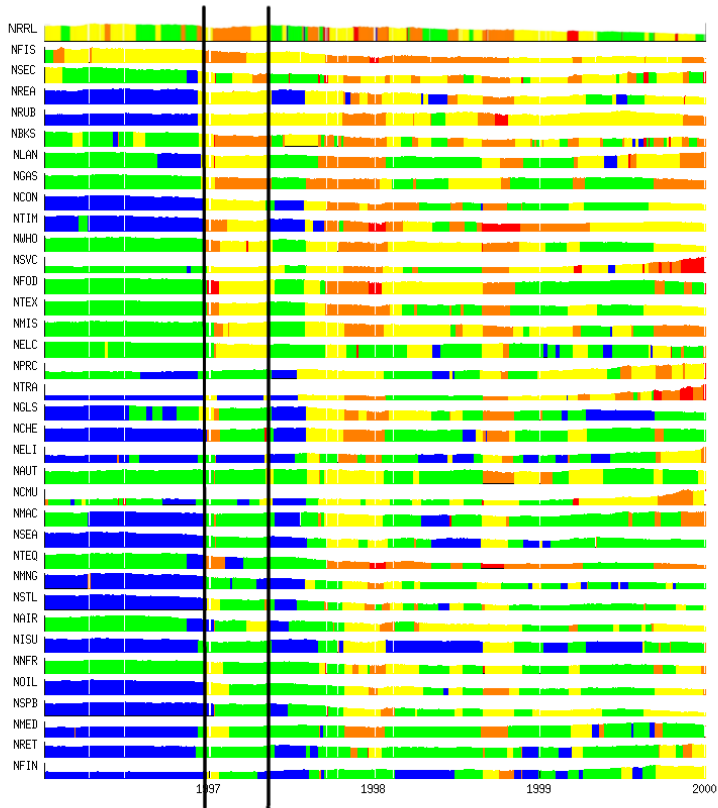

Figure 5: Temporal distributions of the 36 Nikkei 500 industry indices between 1996 and 2000. The corresponding segments in this plot are evident from their common color, or the color movements flanking them in different industries. As an example, we use the black vertical lines to mark a corresponding segment that started at the beginning of 1997, and ending roughly one third through 1997. Roughly half of the Japanese industries are in the high-volatility phase, whereas the remaining half are in the moderate-volatility phase. For the purpose of cross correlation computations, the interval marked by the black vertical lines are chosen such that it includes as little of the low/moderate-volatility phase preceding it, and as little of the low/moderate-volatility phase succeeding it as possible.

2.6 Minimal Spanning Trees

For our cross correlations matrix of the 36 Nikkei 500 Japanese industries, there are 630 independent matrix elements. This is far too many for a human mind to process. To better understand what stories these cross correlation matrices are telling us, we can look at their simplified graphical representations constructed through correlations filtering (Matteo and Aste, 12 Dec 2005), or using community detection methods⁸ to develop a coarse grain description of the cross correlations within the Japanese economy. For this study, we do the former, and visualize the cross correlation matrices as *minimal spanning trees* (MSTs), whereby cycles are not admitted.

Kruskal (1956) first used the MST (also called *minimum spanning tree*) to simplify weighted graphs. The MST was later used by Gower and Ross (1969) to visualize cross correlations. Even though economists regularly deal with cross correlations, the MST visualization is not widely used (Hill, 1999, 2001). However, its application in econophysics took off right after Mantegna and coworkers showed that the MST is a robust caricature of the cross correlations matrix (Mantegna, 1999; Bonanno et al., 2000; Miccichè et al., 2003). The MST is now part of the basic tool suite for statistical analysis of financial market data.⁹ In particular, Onnela et al. (2003a,b,c), used MSTs extensively to study the dynamics of cross correlations during market crashes, while many others used clustering techniques based on the MST to discover different sectors in a stock market.¹⁰ At a higher level, the MST have been used to visualize how the interdependences of the European economies are evolving (Gligor and Ausloos, 2007; Gilmore et al., 2008), and how global markets are linked to each other (Miśkiewicz and Ausloos, 2006; Coelho et al., 2007a; Eryiğit and Eryiğit, 2009).

⁸ See Girvan and Newman (2002), Newman (2004), Duch and Arenas (2005), Newman (2006), Reichardt and Bornholdt (2006), Lancichinetti and Fortunato (2009), Fortunato (2010).

⁹ See Bonanno et al. (2003), Jung et al. (2006), Brida and Risso (2007), Borghesi et al. (2007), Brida and Risso (2008), Eom et al. (2009), Brida and Risso (2010).

¹⁰ See Onnela et al. (2004), Bonanno et al. (2004), Boginski et al. (2005), Tumminello et al. (2007), Coelho et al. (2007b), Jung et al. (2008).

To construct the MST of a given cross-correlation matrix, we compute the statistical distance (Mantegna, 1999)

$$0 \leq d_{ij} = \sqrt{2(1 - C_{ij})} \leq 2 \quad (9)$$

between two financial time series i and j with correlation $-1 \leq C_{ij} \leq 1$. Following Kruskal's algorithm (Kruskal, 1956), we first draw a link connecting the time series pair (i_1, j_1) with the smallest distance $d_{i_1 j_1} = \min_{(i,j)} d_{ij}$. Following this, we draw a link connecting the pair (i_2, j_2) with the next smallest distance $d_{i_2 j_2} = \min_{(i,j) \neq (i_1, j_1)} d_{ij}$. We repeat this process with pairs (i_k, j_k) with increasingly larger distances $d_{i_k j_k}$. If no cycles are formed after drawing a link between i_k and j_k , the link is accepted. Otherwise, it is rejected. The whole process stops when all time series are incorporated into the spanning graph.

3 Growths and Crises in the Japanese Economy

The temporal distributions of all 36 Nikkei 500 Japanese industry indices are shown in Fig. 6, using the color map shown in Table 4. Here, low-volatility growth segments are colored blue, moderate-volatility correction segments are colored green, high-volatility and very-high-volatility crisis segments are colored yellow and orange respectively, and extremely-high-volatility segments are colored red. From Fig. 6, we see that there is only a short period of consistent growth in all Japanese industries in 2005. This suggests that the Japanese economy never fully recovered from the back-to-back Asian Financial and Technology Bubble Crises, before its growth was again derailed by the Subprime Crisis.

From this cross section of temporal distributions, there is a wealth of insights on the Japanese macroeconomic dynamics that we can extract (see Yim (Nov 2010) for details). For example, we know that the Japanese markets became more volatile right after the 9 September 1998 interest rate cut of 0.25% by the Bank of Japan, but did not react to the 12 February 1999 interest rate cut of 0.1% during the Asian Financial Crisis. In contrast, during the Subprime Crisis, the 0.2% rate cut on 31 October 2008 was not effective in calming the Japanese markets, but the 0.2% rate cut by the Japanese central bank on 19 December 2008 was more effective. Even

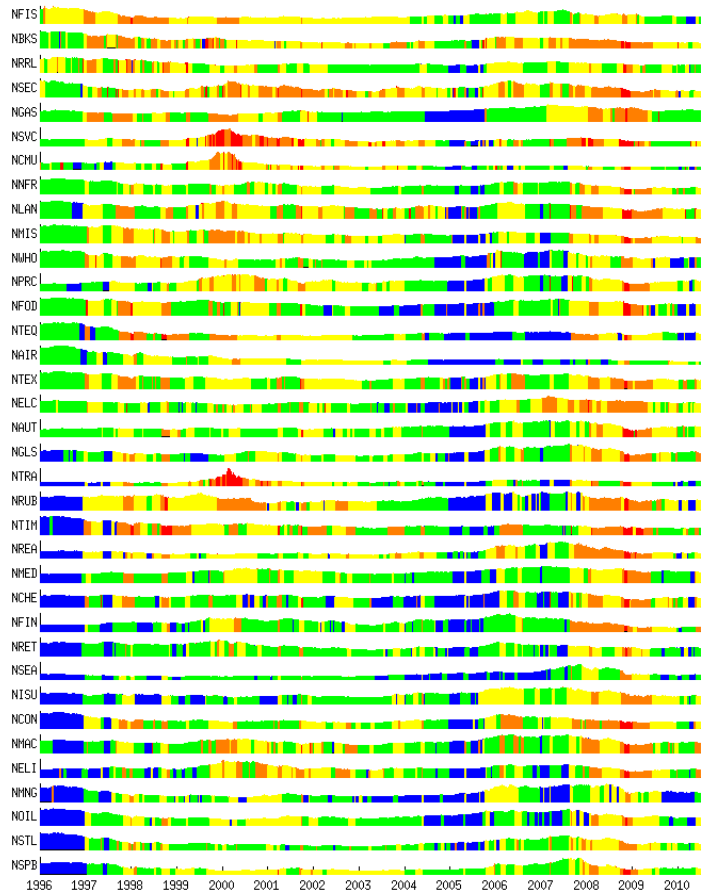

Figure 6: Temporal distributions of the 36 Nikkei 500 Japanese industry indices from 1 January 1996 to 11 June 2010. In this figure, the growth segments are colored blue, correction segments are colored green, crisis segments are colored yellow or orange, and crash segments are colored red.

then, only 12 out of 36 industries responded positively to the 19 December 2008 rate cut. Another example, based on the volatility movements at the end of 1996 and beginning of 1997, we see that the Asian Financial Crisis contagion spread across the entire Japanese economy in less than two months.

In this paper, we will focus on the 2005 near recovery of the Japanese economy, and the 2007 fall of the Japanese economy due to the Subprime Crisis. From Fig. 7, we see that NMNG (Mining) has a swath of blue growth segments that started the earliest, and NFIS (Fisheries) has the shortest swath of blue growth segments that started late. NSPB (Shipbuilding) has no blue growth segments between 2002 and 2005 at all. From Fig. 7 it is also clear that complete recovery in the Japanese economy took a long time. To put a number on this duration, we adopted the working definition of economic recovery as the start of sustained growth periods lasting longer than two months. The choice of two months is arbitrary, and we could also work with a one month duration or a three month duration. In practice, we find that for most Japanese industries, the start of economic recovery is not ambiguous, because their first sustained blue segments lasted significantly longer than two months.

With this operational definition, we can identify the low-volatility blue segment the economic recovery started in each industry. The starting time of the segment so identified can be determined down to half an hour, because that is the temporal resolution we used in our time series segmentation. However, it is not so important whether the segment started right after the market opened, after lunch, or close to when the market closed, so we take the day the segment started in to be the start of economic recovery. In this way, we could ‘date’ the start of economic recovery in each Nikkei 500 Japanese industry. As shown in Table 5, the Japanese economy took two years and two months to nearly completely recover from the back-to-back Asian Financial and Technology Bubble Crises, led by NMNG (Mining) and NELC (Electric Power). In contrast, the US economy took one and a half years to completely recover from the Technology Bubble Crisis, led by the Oil & Gas and Basic Materials sectors (Lee et al., 25 Nov 2009). While the time scales of complete economic recovery appear to be different, very similar industries led the recovery process. In Table 5, NSEC (Securities) and NFIS (Fisheries) are not included, because their blue growth segments are shorter than two months. NSPB (Shipbuilding) is not included, because it has no blue growth segments at all.

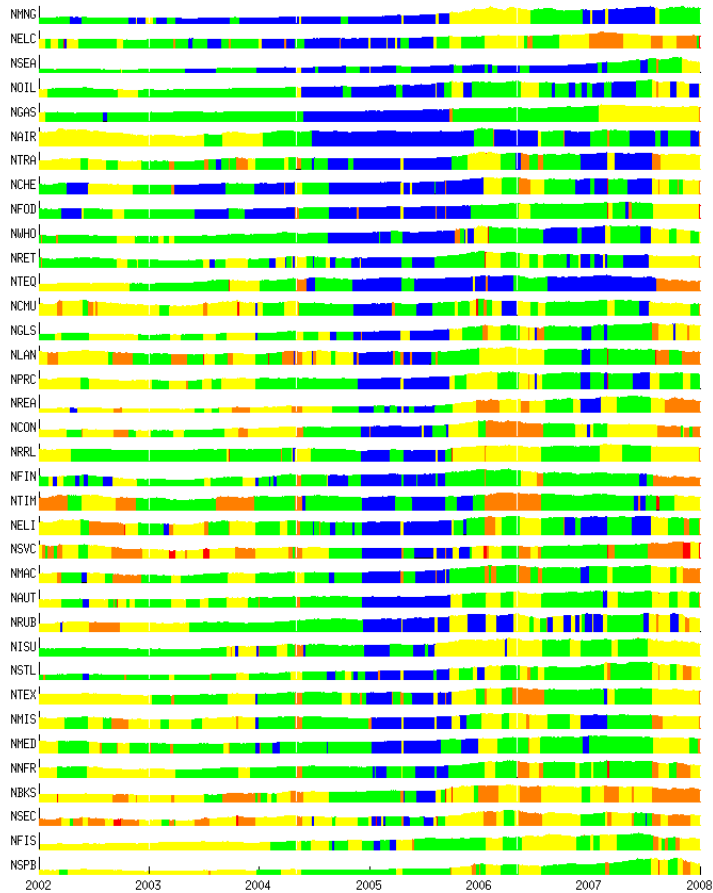

Figure 7: Temporal distributions of the 36 Nikkei 500 Japanese industry indices from January 2002 to December 2007. In this figure, the growth segments are colored blue, correction segments are colored green, crisis segments are colored yellow or orange, and crash segments are colored red.

Table 5: Start dates of economic recovery in the 36 Nikkei 500 Japanese industries, from the earliest to the latest

Industries	Start of recovery
NMNG	27 March 2003
NSEA	24 December 2003
NELC	8 January 2004
NOIL	21 May 2004
NGAS	25 May 2004
NAIR	21 June 2004
NTRA, NWHO	16 August 2004
NCHE, NFOD	19 August 2004
NRET, NTEQ, NGLS	5 November 2004
NCMU	8 November 2004
NPRC	22 November 2004
NREA	24 November 2004
NLAN	25 November 2004
NCON, NRRL, NFIN	2 December 2004
NTIM, NELI, NSVC, NMAC, NAUT	3 December 2004
NRUB, NISU	10 December 2004
NSTL	16 December 2004
NTEX	17 December 2004
NMIS, NMED	5 January 2005
NNFR	30 May 2005
NBKS	2 June 2005

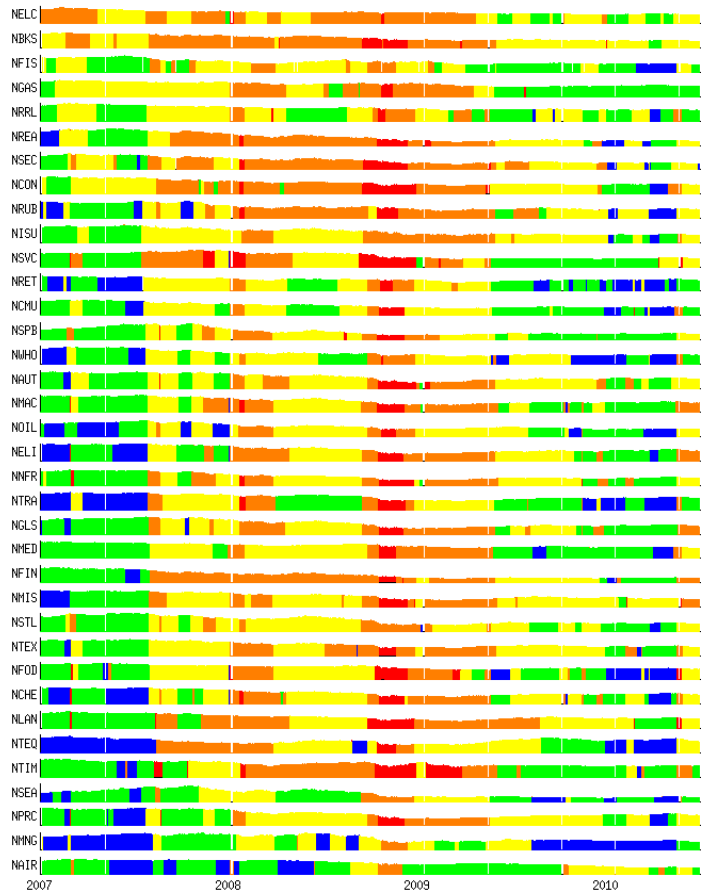

Figure 8: Temporal distributions of the 36 Nikkei 500 Japanese industry indices from January 2007 to June 2010. In this figure, the growth segments are colored blue, correction segments are colored green, crisis segments are colored yellow or orange, and crash segments are colored red.

Next, we look at how the Japanese economy succumbed to the Subprime Crisis. In line with the working definition we adopted for economic recovery, we say that crisis started in an industry when we find a high-volatility yellow segment lasting longer than two months. Again, the choice of two months is arbitrary, though in practice, we find that the transition from mostly blue and green segments to mostly yellow and orange segments is very sharp in most industries. This means that the start times we determined this way are very insensitive to the duration we adopt in our working definition. These start times are precise down to the half hour, but we report in Table 6 only the dates. As we can see from the temporal distributions in Fig. 8, the Japanese economy fell in five stages (Table 6). Based on the timings, it appears that stage 1 is related to, but not simply a reaction to, the Chinese Correction of end February 2007. Stage 2, which affected 21 out of 36 Nikkei 500 industries, appears to be triggered by the start of the Subprime Crisis in US. The remaining stages involved one to two industries. If we measure the time elapse between NFIS (Fisheries) and NAIR (Air Transport), the financial crisis took one year and eight months to unfold in Japan. However, the most important time scale in Japan's response to the Subprime Crisis is that associated with stage 2. Here, the Subprime Crisis swept through NISU (Insurance), NSVC (Services), NRUB (Rubber Products) to NTEQ (Other Transport Equipment) in a mere 27 days. This is half the time it took for the US economy to fall from first to the last economic sector, with Consumer Goods (the sector homebuilders belong to) leading the pack. We find it bizzare for Rubber Products to be one of the three industries leading Japan's macroeconomic response to the crisis. In Table 6, NELC (Electric Power) and NBKS (Banks) are not included, because the sustained crisis phase started in these industries around January 2006 and August 2006 respectively.

Finally, as late as June 2010, we see from Fig. 8 that most Japanese industries are still in the sustained crisis phase. However, NMNG (Mining), NWHO (Warehousing), NTRA (Trading Companies), and NRET (Retail) showed signs of early recovery from mid 2009 onwards. If the Japanese economy again takes two and a half years to completely recover, this will happen in the beginning of 2012.

Table 6: Start dates of Subprime Crisis in the 36 Nikkei 500 Japanese industries, from the earliest to the latest

	Industries	Start of crisis
Stage 1		
	NFIS, NGAS	30 January 2007
	NRRL	31 January 2007
	NREA	7 February 2007
	NSEC	12 February 2007
	NCON	27 February 2007
Stage 2		
	NISU, NSVC, NRUB	12 July 2007
	NRET	16 July 2007
	NCMU	17 July 2007
	NSPB	19 July 2007
	NWHO	20 July 2007
	NAUT, NMAC, NOIL, NELI, NNFR, NTRA	24 July 2007
	NGLS	25 July 2007
	NMED, NFIN, NMIS, NSTL, NTEX, NFOD, NCHE	26 July 2007
	NLAN	8 August 2007
	NTEQ	9 August 2007
Stage 3		
	NSEA	3 October 2007
	NTIM	8 October 2007
Stage 4		
	NPRC	3 January 2008
	NMNG	10 January 2008
Stage 5		
	NAIR	13 August 2008

4 Macroeconomic Correlations between the Japanese Industries

Based on the temporal distributions shown in Fig. 6, as well as popular accounts of the economic sagas that unfolded between 1996 and 2010, we selected five macroeconomic periods: (i) the Asian Financial Crisis (1997 to 1999); (ii) the Technology Bubble Crisis (2000 to 2002); (iii) economic growth (2003 to 2006); (iv) Subprime Crisis (2007 to 2008); and (v) Lehman Brothers Crisis (2008 to 2010) for more careful study. We calculated the cross correlations between the 36 Nikkei 500 Japanese industry indices over these five macroeconomic periods, and compared them against cross correlations over the entire 14-year period. The smallest, average, and largest cross correlations seen in these periods are shown in Table 7. As we can see from the averages and maxima, cross correlations have generally increased between the late 1990s and late 2000s. Also shown in Table 7 are the diameters for the MSTs of these five periods.

Table 7: Smallest, average, and largest cross correlations between the 36 Nikkei 500 Japanese industry indices

Period	Minimum	Average	Maximum	MST diameter
Entire time series	0.216	0.507	0.805	5
Asian Financial Crisis	0.234	0.485	0.767	5
Technology Bubble Crisis	0.115	0.509	0.836	10
Growth	0.126	0.498	0.819	9
Subprime Crisis	0.284	0.660	0.918	8
Lehman Brothers Crisis	0.259	0.630	0.919	8

We also examined the average cross correlations of each Nikkei 500 industry with the rest of the Japanese economy. In Table 8, the three industries with the lowest average cross correlations in each period are colored cyan, whereas the three industries with the highest average cross correlations are colored yellow. NAIR (Air Transport), NFIS (Fisheries), NGAS (Gas), and NMNG (Mining) are consistently weakly correlated with the rest of the Japanese economy, whereas NCHE (Chemicals), NELI (Electrical Machinery), and NMAC (Machinery) are consistently strongly correlated with the rest of the Japanese economy. This suggests that NCHE, NELI, and NMAC play central roles, whereas NAIR, NFIS, NGAS, and NMNG play peripheral roles in the Japanese economy.

Table 8: The average cross correlations of the 36 Nikkei 500 industries with the rest of the Japanese economy over the macroeconomic periods

Industry	Entire	1997–1999	2000–2002	2003–2006	2007–2008	2008–2010
NAIR	cyan 0.348	cyan 0.373	0.349	0.359	0.505	cyan 0.381
NAUT	0.582	0.536	0.592	0.580	0.732	0.691
NBKS	0.591	0.563	0.596	0.585	0.718	0.702
NCHE	yellow 0.639	yellow 0.621	yellow 0.633	yellow 0.624	yellow 0.766	yellow 0.743
NCMU	0.492	0.406	0.517	0.527	0.675	0.652
NCON	0.582	0.572	0.570	0.558	0.708	0.694
NELC	0.387	cyan 0.387	0.374	0.363	0.525	0.480
NELI	yellow 0.601	0.533	yellow 0.625	yellow 0.613	yellow 0.765	yellow 0.737
NFIN	0.507	0.399	0.525	0.523	0.660	0.642
NFIS	0.348	0.428	cyan 0.265	cyan 0.278	cyan 0.453	cyan 0.420
NFOD	0.551	yellow 0.588	0.517	0.518	0.657	0.628
NGAS	cyan 0.347	cyan 0.372	cyan 0.339	cyan 0.305	cyan 0.494	cyan 0.433
NGLS	0.588	0.578	0.572	0.559	0.725	0.688
NISU	0.516	0.494	0.522	0.504	0.646	0.634
NLAN	0.497	0.467	0.474	0.456	0.680	0.639
NMAC	0.580	0.504	yellow 0.620	yellow 0.598	yellow 0.749	yellow 0.730
NMED	0.515	0.538	0.496	0.496	0.644	0.602
NMIS	0.536	0.491	0.555	0.535	0.715	0.671
NMNG	cyan 0.363	0.430	cyan 0.288	cyan 0.274	0.490	0.523
NNFR	yellow 0.607	yellow 0.587	0.616	0.594	0.744	0.713
NOIL	0.477	0.514	0.417	0.407	0.645	0.638
NPRC	0.530	0.443	0.541	0.537	0.720	0.699
NREA	0.535	0.524	0.521	0.510	0.668	0.644
NRET	0.521	0.487	0.590	0.572	0.668	0.618
NRRL	0.481	0.429	0.538	0.526	0.649	0.609
NRUB	0.472	0.438	0.468	0.454	0.663	0.640
NSEA	0.482	0.487	0.462	0.448	0.605	0.583
NSEC	0.557	0.481	0.597	0.583	0.706	0.679
NSPB	0.484	0.466	0.479	0.452	0.653	0.640
NSTL	0.546	0.527	0.538	0.526	0.684	0.675
NSVC	0.531	0.415	0.605	0.585	0.711	0.678
NTEX	0.583	0.561	0.573	0.566	0.736	0.698
NTIM	0.446	0.496	0.403	0.417	0.543	0.522
NTEQ	0.437	0.425	0.464	0.434	0.626	0.587
NTRA	0.506	0.436	0.613	0.598	0.738	0.717
NWHO	0.489	0.479	0.467	0.462	0.680	0.653

Indeed, when we plot the MSTs of the 36 Nikkei 500 Japanese industries over the entire time series and also over the five macroeconomic periods, as shown in Fig. 9, we see that NCHE (Chemicals) and NELI (Electrical Machinery) are hubs (highly connected nodes) in all the MSTs, while NMAC (Machinery) is a hub during the Lehman Brothers Crisis from 2008 to 2010. We also see that NGAS (Gas), NFIS (Fisheries), NMNG (Mining) and NAIR (Air Transport) are at the fringe of the MSTs. In Table 9, we show the degree k (the number of links a given node has) and betweenness centrality b (the fraction of shortest paths passing through a given node) of the hubs over these six macroeconomic time periods. From the betweenness centrality values seen in Table 9, we see that NELI and NMAC are becoming more central, while NCHE is becoming less so, even as it remains an important hub in the Japanese economy. When an industry has fewer than four links in a given period, we do not consider it a hub, and do not report its degree and betweenness centrality in this period.

Table 9: Degrees and betweenness centralities of hubs in the MSTs for the Japanese economy

Hub	Entire		1997–1999		2000–2002		2003–2006		2007–2008		2008–2010	
	k	b	k	b	k	b	k	b	k	b	k	b
NCHE	16	0.922	12	0.887	12	0.711	13	0.740	8	0.551	10	0.711
NELI	7	0.400	6	0.356	7	0.721	9	0.710	9	0.824	7	0.721
NMAC	-	-	-	-	-	-	-	-	4	0.384	6	0.310
NFOD	4	0.260	6	0.395	-	-	-	-	-	-	5	0.390
NGLS	-	-	6	0.310	-	-	-	-	-	-	-	-
NNFR	4	0.211	-	-	4	0.260	-	-	4	0.260	-	-

In Zhang et al. (2011), we saw clear transitions between a compact MST topology during growth and an open topology during crisis, going as far back as 2001. We understand these topology changes as follows. In a period of growth, publicly listed companies can tap the positive energy in the stock market to expand their businesses by direct sales of reserve stocks, or by securing bank loans offering their stocks as collateral, or by using their stock market position to attract further private investments. When one sector in the US economy take advantage of growth in another sector to accelerate its own growth, their indices become preferentially correlated. This leads to a compact MST centered around the engine of economic growth, which is the Industrials in the US economy. Conversely, during crisis

times, companies source out more suppliers to avoid disruptions to their production and hence their cash flow, and also actively explore alternative customer bases to avoid over-reliance on any single group of customers. In a stock market with well-informed investors, this supply chain management strategy naturally weakens preferential correlations between the stock prices of companies that used to leverage on each other to grow. We therefore interpret the open MST topology as statistical evidence for sectors of the US economy strategically reducing any preferential connections.

Looking more carefully at the Japanese MSTs, we see that these are more ‘open’ during the Technology Bubble, growth, Subprime and Lehman Brothers periods than that during the Asian Financial Crisis. We can make this comparison more quantitative by measuring the diameters of the MSTs, shown in Table 7. To put it simply, the diameter of a MST is the largest number of links that one has to traverse to get from one node to another. However, even during the growth period, the Japanese MST did not ‘close back in’ after the Technology Bubble Crisis ended. While the MST does not give the full correlational relationships between the industries, financial contagion in general spreads faster on a ‘closer’ MST than on a more open MST. At the same time, positive sentiments also propagate faster on a ‘closer’ MST, making this a conducive environment for economic growth. This is in contrast to what we saw in Zhang et al. (2011), where we find the US economic MST huddled up during growth (to accelerate it), and opens up during crises (to slow down the spread of contagion). We believe this is the learned response of a mature economy. The Japanese economy, on the other hand, seems to have learnt the isolation response only after the Asian Financial Crisis, but not yet the coordinated response to enable growth.

5 Flight to Quality in the Japanese Stock market

In recent empirical studies, Connolly et al. (2005, 2007) studied return comovements of stocks in different countries, and the return comovements of stocks and bonds in the same country, to better understand the phenomenon of flight to quality. They are followed by Baur and Lucey (2009, 2010), who investigated the flight to quality between stocks, bonds, and gold. In these studies, the emphasis has

been on the movement of money between different asset classes. However, the same flight to quality phenomenon can also happen within the stock market itself, where investors dump growth stocks in crisis times to buy quality stocks instead. In this section, we show evidence for such flights to quality within the Japanese market, identifying the ‘growth’ industries investors exited from, and the ‘quality’ industries they then invested in.

In Fig. 10, we see that the period between January 2007 to June 2010 covering the Subprime and Lehman Brothers Crises can be divided into eight corresponding segments. The MSTs of these eight corresponding segments are shown in Fig. 11. As expected, because this is a crisis period, most of the MSTs are ‘open’, with the exception of (e) and (h). In Fig. 11(e), which is for the extremely-high-volatility Lehman Brothers saga itself, the MST is anomalously close. In Fig. 11(h) for the early 2010 period showing signs of early recovery, the MST is also becoming close. When we look at the MST network properties shown in Table 10, sorting the hubs first according to their degrees, and then according to their betweenness centralities, we see the Japanese economic MST opening up from Subprime1 to Subprime2, in timely response to the start of the Subprime Crisis. Thereafter, the MST closed in from Subprime3 to Subprime4, before opening up again from Subprime5 to Subprime6, in delayed response to the Lehman Brothers Crisis. Finally, the MST closed in from Subprime7 to Subprime8, to show signs of early economic recovery.

Next, we look at the MST hubs listed in Table 10. In Fig. 11(a), Fig. 11(b), and Fig. 11(c), the dominant hubs are (a) NELI (Electric Machinery) and NMAC (Machinery), (b) NCHE (Chemicals), NELI, and NBKS (Banks), and (c) NCHE, NELI, and NMAC respectively. These hubs can all be considered growth industries. In Fig. 11(d), apart from NELI and NMAC, we find that NNFR (Nonferrous Metals) and NRRL (Railway/Bus) are also dominant hubs. The latter two industries are generally considered quality industries. Going from Fig. 11(c) to Fig. 11(d), we see that the most prominent change in the MST structure is the dissipation of the cluster of industries surrounding NCHE, and to a lesser extent, the dissipation of the cluster surrounding NMAC, and clusters growing around NNFR and NRRL. This tells us that the peripheral industries went from being most strongly correlated with NCHE and NMAC to being most strongly correlated with NNFR and NRRL. We believe this is a signature of money leaving the NCHE and NMAC

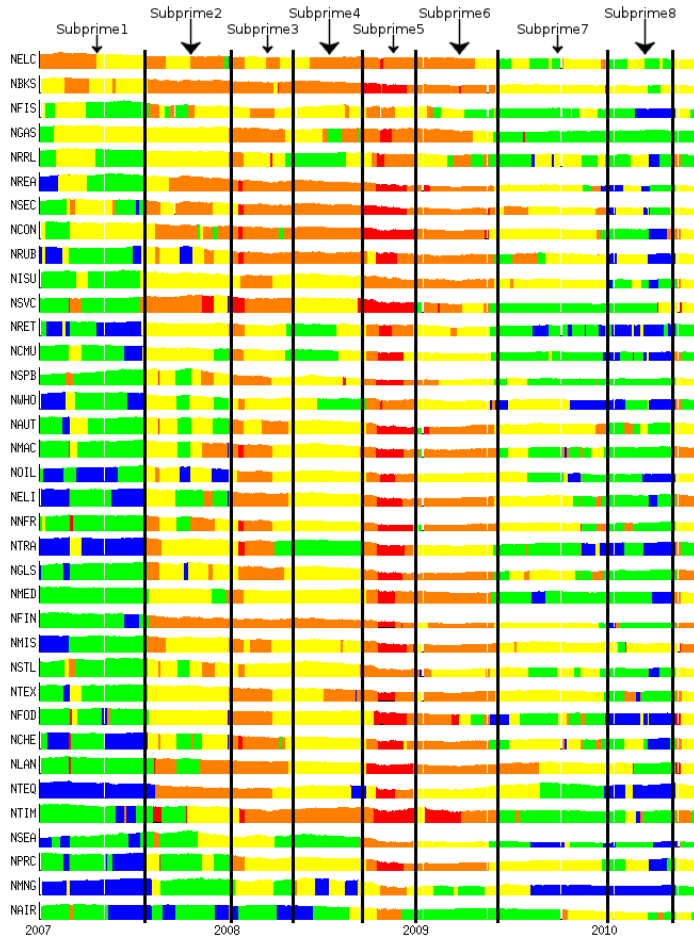
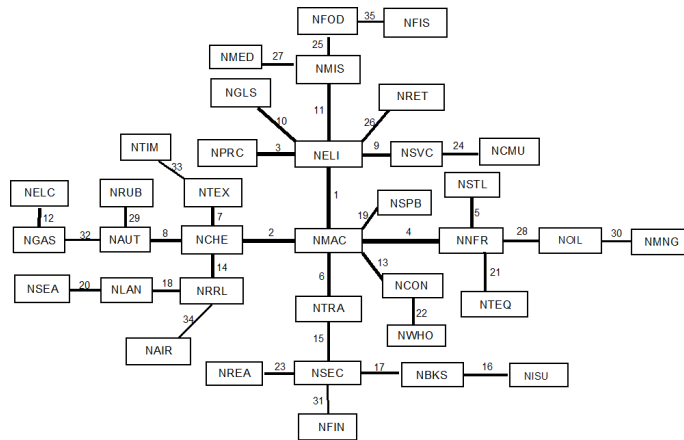
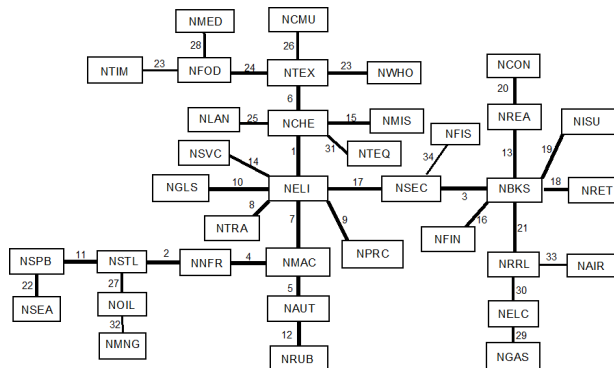

Figure 10: Temporal distributions of the 36 Nikkei 500 Japanese industry indices between January 2007 and June 2010. Within this period, we can identify eight corresponding segments, labeled ‘Subprime1’ to ‘Subprime8’.



(a)



(b)

Figure 11: MSTs for the eight corresponding segments from (a) Subprime1 to (h) Subprime8. In this figure, the number beside each link indicates the order in which the link was added to the MST, whereas the thicknesses of the links indicate how strong the correlations are between industries.

Table 10: Network diameters of the MSTs of the eight Subprime Crisis corresponding segments, and the degrees and betweenness centralities of the hubs (nodes with at least four links) present in these MSTs

Segment	Diameter	Hub	k	b
Subprime1	9	NMAC	6	0.808
		NELI	6	0.473
		NCHE	4	0.503
		NNFR	4	0.260
		NSEC	4	0.260
Subprime2	11	NELI	7	0.767
		NBKS	6	0.473
		NCHE	5	0.460
		NTEX	4	0.305
Subprime3	10	NCHE	12	0.802
		NMAC	6	0.468
		NELI	5	0.594
		NBKS	4	0.305
		NNFR	4	0.260
Subprime4	9	NNFR	7	0.440
		NELI	6	0.721
		NMAC	5	0.632
		NRRL	5	0.352
		NWHO	4	0.451
		NCHE	4	0.260
Subprime5	9	NELI	19	0.914
Subprime6	13	NCHE	7	0.735
		NMAC	6	0.468
		NFOD	6	0.433
		NELI	5	0.594
Subprime7	13	NMAC	7	0.665
		NELI	6	0.657
		NCHE	5	0.308
		NSEC	4	0.546
		NRRL	4	0.260
Subprime8	8	NCHE	12	0.871
		NELI	6	0.437
		NRRL	5	0.308
		NBKS	4	0.419

industries, and entering the NNFR and NRRL industries, i.e. a flight to quality from NCHE/NMAC to NNFR/NRRL.

In Subprime5, which corresponds to the collapse of Lehman Brothers, one part of the MST became elongated, whereas the other part become very compact and centered around NELI, which became the only hub in the MST (see Fig. 11(e)). Comparing Fig. 11(e) and Fig. 11(f), we see that the cluster of industries around NELI very quickly dissipated and reformed around and surprisingly, NFOD (Foods), which is another industry perceived to be a quality industry. This partial migration of correlations to both growth and quality industries in going from Subprime5 to Subprime6, suggests that there are two fairly distinct groups of investors. The first group is optimistic, returning to the growth industries right after the Lehman Brothers collapse, whereas the second group is pessimistic, choosing to invest in a quality industry instead. Going through all eight MSTs, we see that the growth hubs are fairly robust and persistent, and recovers rapidly after short disappearances. The quality hubs, on the other hand, do not survive for very long. We take this to mean that Japanese investors are actually more optimistic than most people give them credit for. Why does the Japanese economy not grow then? We believe the growth industries are not harnessing enough of this positive energy that is coursing through the Japanese markets to realize their full potentials.

Before we conclude, let us mention that this flight-to-quality phenomenon is also observed for the Asian Financial Crisis period, which consists of seven corresponding segments spanning January 1996 to December 1999. Here, however, we find a different story. Although the growth (NCHE, NELI, NBKS) and quality (NFOD, NNFR, NGLS (Glass & Ceramics) instead of NRRL) hubs are by and large the same, the quality hubs (NFOD in particular) are longer-lived. This suggests that Japanese investors are more pessimistic during the Asian Financial Crisis than they are during the Subprime Crisis. This pessimistic outlook near the end of the last millenium might have contributed to Japan's slow economic recovery from the Technology Bubble Crisis.

6 Conclusions

To summarize, in this paper we segmented the time series of the 36 Nikkei 500 Japanese industry indices between January 1996 and June 2010, and then clustered the time series segments into four to five volatility clusters, each representing a distinct macroeconomic phase. By examining the temporal distributions of clustered segments, we found that the Japanese economy started recovering from the back-to-back Asian Financial and Technology Bubble Crises in the second quarter of 2003. Complete recovery of the Japanese economy, at the end of the second quarter of 2005, took well over two years. In contrast, 21 out of 36 Japanese industries succumbed to the Subprime Crisis in only 27 days starting 12 July 2007. To compare, we note from our previous work that the Subprime Crisis swept through all ten US economic sectors in two months, whereas complete economic recovery from the Technology Bubble Crisis took one-and-a-half years. We saw also that as late as June 2010, many Japanese industries were still in the sustained crisis phase, and argued that full recovery will take place in early 2012.

Next, we calculated the Pearson cross correlations between Japanese industries over five macroeconomic periods: (i) 1997–1999 (Asian Financial Crisis), (ii) 2000–2002 (Technology Bubble Crisis), (iii) 2003–2006 (economic growth), (iv) 2007–2008 (Subprime Crisis), and (v) 2008–2010 (Lehman Brothers Crisis), to compare against cross correlations calculated over the entire period of study. We found that cross correlations are in general increasing over the $14\frac{1}{2}$ years studied. To better understand these cross correlations, we constructed their associated MSTs, and found that the Chemicals and Electric Machinery industries consistently hubs. Based on their diameters, we also found the MSTs to be increasingly ‘open’ over the years. ‘Closed’ MSTs are conducive for economic growth but at the same time allows rapid propagation of financial contagion, whereas ‘open’ MSTs offers partial isolation from progressive crises. Comparing the macroeconomic MSTs of US and Japan, we saw the Japanese economy is still not as nimble as its US counterpart.

Finally, we analyzed the rearrangement dynamics of the segment-to-segment MSTs during the Subprime Crisis. We presented evidence showing how growth industries like the Chemicals, Electric Machinery, and Machinery can sometimes fall out

of favor with investors, who flocked briefly to quality industries such as Foods, Nonferrous Metals, and Railway/Bus. Comparing the lifetimes of flight to quality episodes within the Japanese stock market during the Asian Financial Crisis and the Subprime Crisis, we argued that investors were significantly more pessimistic during the former. We suggested that this outlook may have persisted through the Technology Bubble Crisis, culminating in Japan's late economic recovery.

Acknowledgement: This research is supported by the Nanyang Technological University startup grant SUG 19/07. RPF and DYX acknowledge financial support from the Nanyang Technological University Summer Research Internship Programme.

Appendix

In this appendix, the lists of component stocks are taken from Nikkei's website, <http://e.nikkei.com/e/app/fr/market/constituents.aspx>, whereas the market capitalizations are obtained from Reuters, <http://www.reuters.com/>.

Table A1: Air transport

Stock Code	Company Name	Market Capitalization (million JPY)
9202	All Nippon Airways Co., Ltd.	643,864.62
9234	Kokusai Kogyo Holdings Co., Ltd.	13,240.51

Table A2: Automotive

Stock Code	Company Name	Market Capitalization (million JPY)
7261	Mazda Motor Corp.	309,785.69
7211	Mitsubishi Motors Corp.	548,257.81
7240	NOK Corp.	227,677.20
7270	Fuji Heavy Industries Ltd.	429,010.50
3116	Toyota Boshoku Corp.	214,126.59
7202	Isuzu Motors, Ltd.	549,777.88
7248	Calsonic Kansei Corp.	84,704.91
7205	Hino Motors, Ltd.	222,362.80
7262	Daihatsu Motor Co., Ltd.	530,059.62
7251	Keihin Corp.	109,572.10
7222	Nissan Shatai Co., Ltd.	92,928.66
7242	Kayaba Industry Co., Ltd.	146,500.70
7201	Nissan Motor Co., Ltd.	3,187,104.00
7272	Yamaha Motor Co., Ltd.	462,379.81
7282	Toyoda Gosei Co., Ltd.	213,216.41
7269	Suzuki Motor Corp.	990,809.62
7276	Koito Manufacturing Co., Ltd.	198,735.80
7259	Aisin Seiki Co., Ltd.	789,728.00
7203	Toyota Motor Corp.	11,361,150.00
7312	Takata Corp.	187,696.00
7267	Honda Motor Co., Ltd.	5,506,743.00

Table A3: Banks

Stock Code	Company Name	Market Capitalization (million JPY)
8339	The Tokyo Tomin Bank, Ltd.	40,611.23
8415	Kiyo Holdings, Inc.	85,237.83
8303	Shinsei Bank, Ltd.	272,284.31
8366	The Shiga Bank, Ltd.	112,020.10
8404	Mizuho Trust & Banking Co., Ltd.	387,018.69
8328	Sapporo Hokuyo Holdings, Inc.	156,966.80
8411	Mizuho Financial Group, Inc.	3,236,671.00
8377	Hokuhoku Financial Group, Inc.	229,619.00
8333	The Joyo Bank, Ltd.	265,275.41
8379	The Hiroshima Bank, Ltd.	223,845.30
8356	The Juroku Bank, Ltd.	99,740.48
8334	The Gunma Bank, Ltd.	213,394.70
8308	Resona Holdings, Inc.	1,016,043.00
8304	Aozora Bank, Ltd.	298,676.69
8309	Chuo Mitsui Trust Holdings, Inc.	484,260.50
8327	The Nishi-Nippon City Bank, Ltd.	183,248.50
8332	The Bank of Yokohama, Ltd.	534,900.88
8359	The Hachijuni Bank, Ltd.	242,834.20
8341	The 77 Bank, Ltd.	151,778.41
8354	Fukuoka Financial Group, Inc.	275,983.59
8306	Mitsubishi UFJ Financial Group, Inc.	5,589,604.00
8336	The Musashino Bank, Ltd.	90,548.94
8544	The Keiyo Bank, Ltd.	121,286.80
8331	The Chiba Bank, Ltd.	421,790.41
8355	The Shizuoka Bank, Ltd.	457,666.19
8403	The Sumitomo Trust and Banking Co., Ltd.	721,980.38
8369	The Bank of Kyoto, Ltd.	266,200.81
8418	Yamaguchi Financial Group, Inc.	193,771.20
8385	The Iyo Bank, Ltd.	223,405.00
8382	The Chugoku Bank, Ltd.	212,307.80
8358	Suruga Bank Ltd.	183,020.70
8316	Sumitomo Mitsui Financial Group, Inc.	3,817,950.00

Table A4: Chemicals

Stock Code	Company Name	Market Capitalization (million JPY)
4912	Lion Corp	124,132.90
4045	Toagosei Co Ltd	109,292.90
4004	Showa Denko K K	239,538.09
4028	Ishihara Sangyo Kaisha Ltd	34,730.19
4043	Tokuyama Corp	141,617.09
4631	DIC Corp	165,487.00
4044	Central Glass Co Ltd	69,835.99
4208	Ube Industries Ltd	264,401.19
4183	Mitsui Chemicals Inc	284,121.59
4005	Sumitomo Chemical Co Ltd	667,144.81
4042	Tosoh Corp	172,533.50
4403	NOF Corp	68,814.11
4634	Toyo Ink Mfg Co Ltd	122,152.80
4204	Sekisui Chemical Co Ltd	342,587.09
4061	Denki Kagaku Kogyo K K	196,257.59
4023	Kureha Corp	68,676.52
4188	Mitsubishi Chemical Holdings Corp	715,486.88
4041	Nippon Soda Co Ltd	50,924.82
4202	Daicel Chemical Industries Ltd	178,457.00
4088	Air Water Inc	194,635.41
4118	Kaneka Corp	196,000.00
4203	Sumitomo Bakelite Co Ltd	129,109.60
4091	Taiyo Nippon Sanso Corp	264,832.00
4272	Nippon Kayaku Co Ltd	128,665.00
3407	Asahi Kasei Corp	770,036.38
4612	Nippon Paint Co Ltd	144,378.91
4613	Kansai Paint Co Ltd	194,653.00
4182	Mitsubishi Gas Chemical Co Inc	270,264.41
4401	ADEKA Corp	78,567.80
4911	Shiseido Co Ltd	595,200.00
4021	Nissan Chemical Industries Ltd	146,376.00
4452	Kao Corp	1,121,879.00
4205	Zeon Corp	173,810.30
3405	Kuraray Co Ltd	386,309.41
4114	Nippon Shokubai Co Ltd	199,916.00

Table A4: (continued)

Stock Code	Company Name	Market Capitalization (million JPY)
4217	Hitachi Chemical Co Ltd	331,508.59
4185	JSR Corp	407,881.00
4901	Fujifilm Holdings Corp	1,296,342.00
4063	Shin-Etsu Chemical Co Ltd	1,728,427.00
6988	Nitto Denko Corp	741,948.50

Table A5: Communications

Stock Code	Company Name	Market Capitalization (million JPY)
9433	KDDI Corp.	2,372,469.00
9435	Hikari Tsushin, Inc.	97,969.05
9412	SKY Perfect JSAT Holdings Inc.	102,312.80
9401	Tokyo Broadcasting System Holdings, Inc.	181,294.09
9449	GMO Internet Inc.	37,601.29
9432	Nippon Telegraph And Telephone Corp.	5,417,985.00
9404	Nippon Television Network Corp.	301,838.09
9984	Softbank Corp.	40,805.88
9427	Eaccess Ltd.	159,828.00
4676	Fuji Media Holdings, Inc.	264,801.41
9437	NTT Docomo, Inc.	6,515,952.00
9613	NTT Data Corp.	686,383.50

Table A6: Construction

Stock Code	Company Name	Market Capitalization (million JPY)
1983	Toshiba Plant Systems & Services Corp	91,211.53
1951	Kyowa Exeo Corp	98,019.93
1820	Nishimatsu Construction Co Ltd	39,469.97
1802	Obayashi Corp	274,173.69
1808	Haseko Corp	97,758.18
1942	Kandenko Co Ltd	103,260.00
1801	Taisei Corp	245,157.80
1812	Kajima Corp	263,270.69
1803	Shimizu Corp	302,789.59
1833	Okumura Corp	80,370.80
1860	Toda Corp	109,703.30
1721	Comsys Holdings Corp	120,723.70
1928	Sekisui House, Ltd	547,600.00
1925	Daiwa House Industry Co Ltd	646,715.81
1963	JGC Corp	508,002.81
1878	Daito Trust Construction Co Ltd	711,027.12

Table A7: Electric power

Stock Code	Company Name	Market Capitalization (million JPY)
9508	Kyushu Electric Power Co., Inc.	832,192.81
9509	Hokkaido Electric Power Co., Inc.	361,044.50
9506	Tohoku Electric Power Co., Inc.	752,815.31
9504	The Chugoku Electric Power Co., Inc.	603,335.88
9505	Hokuriku Electric Power Co.	410,781.69
9503	The Kansai Electric Power Co., Inc.	1,828,652.00
9507	Shikoku Electric Power Co., Inc.	558,008.38
9513	Electric Power Development Co., Ltd.	429,416.41
9502	Chubu Electric Power Co., Inc.	1,487,196.00
9501	The Tokyo Electric Power Co., Inc.	1,118,484.00
9511	The Okinawa Electric Power Co., Inc.	67,119.69

Table A8: Electric Machinery

Stock Code	Company Name	Market Capitalization (million JPY)
7718	Star Micronics Co Ltd	44,194.78
6665	Elpida Memory Inc	217,949.59
6508	Meidensha Corp	70,340.05
6701	NEC Corp	445,409.31
6703	Oki Electric Industry Co Ltd	44,617.76
6764	Sanyo Electric Co Ltd	702,018.12
6796	Clarion Co Ltd	36,474.00
6479	Minebea Co Ltd	179,226.30
6773	Pioneer Corp	110,219.70
6707	Sanken Electric Co Ltd	56,596.13
6588	Toshiba Tec Corp	97,969.54
6674	GS Yuasa Corp	216,713.20
6925	Ushio Inc.	218,937.80
6502	Toshiba Corp	20,876.91
6504	Fuji Electric Holdings Co Ltd	188,860.70
6501	Hitachi, Ltd	1,852,706.00
6841	Yokogawa Electric Corp	164,129.59
7752	Ricoh Co Ltd	703,197.00
6756	Hitachi Kokusai Electric Inc.	67,972.93
6997	Nippon Chemi-Con Corp	48,859.78
6807	Japan Aviation Electronics Industry, Ltd	51,689.46
6503	Mitsubishi Electric Corp	2,061,314.00
6753	Sharp Corp	846,353.31

Table A8: (continued)

Stock Code	Company Name	Market Capitalization (million JPY)
6632	JVC Kenwood Holdings, Inc.	50,179.07
6723	Renesas Electronics Corp	263,622.69
6976	Taiyo Yuden Co Ltd	123,252.50
7757	Nidec Sankyo Corp	109,313.60
6448	Brother Industries, Ltd	329,712.59
6702	Fujitsu Ltd	977,048.62
7735	Dainippon Screen Mfg. Co Ltd	210,290.80
6767	Mitsumi Electric Co Ltd	92,485.52
6770	Alps Electric Co Ltd	136,351.50
6752	Panasonic Corp	2,440,788.00
6952	Casio Computer Co Ltd	175,504.20
6967	Shinko Electric Industries Co Ltd	110,705.80
6991	Panasonic Electric Works Co Ltd	686,482.38
7751	Canon Inc.	4,721,523.00
6724	Seiko Epson Corp	251,570.09
6506	Yaskawa Electric Corp	246,780.59
6995	Tokai Rika Co Ltd	122,221.70
6923	Stanley Electric Co Ltd	237,736.70
6728	Ulvac, Inc.	85,237.70
6845	Yamatake Corp	148,654.80
6869	Sysmex Corp	284,563.31
6592	Mabuchi Motor Co Ltd	154,718.41
6902	Denso Corp	2,245,535.00
4062	Ibiden Co Ltd	379,716.00
6857	Advantest Corp	285,380.50
6758	Sony Corp	2,612,034.00
6965	Hamamatsu Photonics K.K.	268,885.59
6981	Murata Manufacturing Co Ltd	1,252,466.00
8035	Tokyo Electron Ltd	827,198.00
6586	Makita Corp	519,432.50
6963	Rohm Co Ltd	582,265.00
6762	TDK Corp	611,667.88
6806	Hirose Electric Co Ltd	351,382.09
6954	Fanuc Ltd	2,890,866.00
6971	Kyocera Corp	1,520,909.00
6727	Wacom Co Ltd	41,422.33
6861	Keyence Corp	1,130,363.00

Table A9: Other financial services

Stock Code	Company Name	Market Capitalization (million JPY)
8572	Acom Co., Ltd.	161,384.20
8515	Aiful Corp.	22,436.44
8258	Cedyna Financial Corp.	129,151.20
8511	Japan Securities Finance Co., Ltd.	50,785.40
8595	Jafco Co., Ltd.	100,017.60
8586	Hitachi Capital Corp.	129,570.00
8253	Credit Saison Co., Ltd.	241,634.50
8574	Promise Co., Ltd.	71,883.93
8570	Aeon Credit Service Co., Ltd.	174,390.30
8593	Mitsubishi UFJ Lease & Finance Co., Ltd.	285,771.09
8473	SBI Holdings, Inc.	198,238.50
8591	Orix Corp.	877,512.00

Table A10: Fisheries

Stock Code	Company Name	Market Capitalization (million JPY)
1379	Hokuto Corp	62,247.85
1332	Nippon Suisan Kaisha Ltd	70,733.47
1334	Maruha Nichiro Holdings Inc	68,610.07

Table A11: Foods

Stock Code	Company Name	Market Capitalization (million JPY)
2212	Yamazaki Baking Co Ltd	206,845.59
2809	Kewpie Corp	151,422.41
2002	Nisshin Seifun Group Inc	236,694.91
2871	Nichirei Corp	110,352.10
2503	Kirin Holdings Co Ltd	1,038,340.00
2501	Sapporo Holdings Ltd	122,525.10
2875	Toyo Suisan Kaisha Ltd	198,920.59
2810	House Foods Corp	142,318.30
2502	Asahi Breweries Ltd	694,429.31
2264	Morinaga Milk Industry Co Ltd	75,939.19
2531	Takara Holdings Inc	90,563.09
2602	The Nisshin Oillio Group Ltd	69,162.38
2801	Kikkoman Corp	164,309.30
2897	Nissin Foods Holdings Co Ltd	346,400.41
2593	Ito En Ltd	129,795.20
2802	Ajinomoto Co Inc	606,228.31
2579	Coca-Cola West Co Ltd	166,021.80
2282	Nippon Meat Packers Inc	227,074.70
2267	Yakult Honsha Co Ltd	365,013.69
2270	Megmilk Snow Brand Co Ltd	91,340.65
2269	Meiji Holdings Co Ltd	259,943.50
2914	Japan Tobacco Inc	3,140,000.00

Table A12: Gas

Stock Code	Company Name	Market Capitalization (million JPY)
9532	Osaka Gas Co., Ltd.	699,316.31
9531	Tokyo Gas Co., Ltd.	1,017,309.00
9533	Toho Gas Co., Ltd.	235,594.09

Table A13: Glass & ceramics

Stock Code	Company Name	Market Capitalization (million JPY)
5232	Sumitomo Osaka Cement Co Ltd	110,277.50
5233	Taiheiyo Cement Corp	149,197.20
5202	Nippon Sheet Glass Co Ltd	205,106.09
3110	Nitto Boseki Co Ltd	47,801.77
5302	Nippon Carbon Co Ltd	24,966.58
5214	Nippon Electric Glass Co Ltd	568,277.81
5301	Tokai Carbon Co Ltd	88,852.52
5332	TOTO Ltd	254,960.50
5201	Asahi Glass Co Ltd	1,232,987.00
5334	NGK Spark Plug Co Ltd	248,826.59
5310	Toyo Tanso Co Ltd	82,795.24
5333	NGK Insulators Ltd	472,584.31

Table A14: Insurance

Stock Code	Company Name	Market Capitalization (million JPY)
8763	The Fuji Fire and Marine Insurance Co., Ltd.	102,234.90
8630	NKSJ Holdings, Inc.	902,145.19
8795	T&D Holdings, Inc.	669,554.12
8766	Tokio Marine Holdings, Inc.	1,831,098.00
8725	MS&AD Insurance Group Holdings, Inc.	1,189,955.00
8729	Sony Financial Holdings Inc.	676,425.00

Table A15: Other land transport

Stock Code	Company Name	Market Capitalization (million JPY)
9062	Nippon Express Co., Ltd.	332,499.69
9075	Fukuyama Transporting Co., Ltd.	110,704.20
9065	Sankyu Inc.	128,800.80
9076	Seino Holdings Co., Ltd.	123,984.80
9064	Yamato Holdings Co., Ltd.	588,342.50

Table A16: Machinery

Stock Code	Company Name	Market Capitalization (million JPY)
6367	Daikin Industries Ltd	730,146.88
7011	Mitsubishi Heavy Industries Ltd	1,228,008.00
6366	Chiyoda Corp	198,107.00
6310	Iseki & Co Ltd	42,522.24
6361	Ebara Corp	197,934.91
7004	Hitachi Zosen Corp	90,752.35
6330	Toyo Engineering Corp	59,958.48
6472	NTN Corp	197,544.00
6326	Kubota Corp	1,044,166.00
7013	IHI Corp	283,142.31
6474	Nachi-Fujikoshi Corp	103,913.70
6302	Sumitomo Heavy Industries Ltd	318,939.69
6395	Tadano Ltd	70,059.70
6371	Tsubakimoto Chain Co	79,433.89
6103	Okuma Corp	111,729.60
6436	Amano Corp	61,349.66
6104	Toshiba Machine Co Ltd	70,592.58
6581	Hitachi Koki Co Ltd	92,919.95
6471	NSK Ltd	373,208.50
6135	Makino Milling Machine Co Ltd	78,803.56
6349	Komori Corp	49,716.82
5631	The Japan Steel Works Ltd	236,622.00
6383	Daifuku Co Ltd	63,997.05
6473	JTEKT Corp	325,761.41
6113	Amada Co Ltd	263,277.41
6136	OSG Corp	111,522.50
6460	Sega Sammy Holdings Inc	394,818.31
6268	Nabtesco Corp	253,534.70
6417	Sankyo Co Ltd	424,061.09
6201	Toyota Industries Corp	792,770.31
6305	Hitachi Construction Machinery Co Ltd	440,985.81
6301	Komatsu Ltd	2,791,490.00
6370	Kurita Water Industries Ltd	310,619.81
6481	THK Co Ltd	271,194.09
6273	SMC Corp	11,599.56

Table A17: Pharmaceuticals

Stock Code	Company Name	Market Capitalization (million JPY)
4535	Taisho Pharmaceutical Co Ltd	521,908.59
4506	Dainippon Sumitomo Pharma Co Ltd	284,100.69
4540	Tsumura & Co	176,150.70
4151	Kyowa Hakko Kirin Co Ltd	431,786.19
4521	Kaken Pharmaceutical Co Ltd	99,841.88
4530	Hisamitsu Pharmaceutical Co Inc	306,431.00
4508	Mitsubishi Tanabe Pharma Corp	743,317.31
4568	Daiichi Sankyo Co Ltd	1,135,127.00
4519	Chugai Pharmaceutical Co Ltd	783,560.31
4507	Shionogi & Co Ltd	485,972.41
4503	Astellas Pharma Inc	1,443,671.00
4523	Eisai Co Ltd	916,391.88
4502	Takeda Pharmaceutical Co Ltd	3,123,130.00

Table A18: Other manufacturing

Stock Code	Company Name	Market Capitalization (million JPY)
7936	Asics Corp.	212,960.59
7984	Kokuyo Co., Ltd.	79,691.59
7832	Namco Bandai Holdings Inc.	216,720.00
7951	Yamaha Corp.	172,598.09
7911	Toppan Printing Co., Ltd.	440,629.91
7912	Dai Nippon Printing Co., Ltd.	672,461.38
7966	Lintec Corp.	171,274.20
7915	Nissha Printing Co., Ltd.	75,244.28

Table A19: Mining

Stock Code	Company Name	Market Capitalization (million JPY)
1518	Mitsui Matsushima Co Ltd	23,847.87
1662	Japan Petroleum Exploration Co Ltd	176,602.00
1605	Inpex Corp	1,735,998.00

Table A20: Nonferrous metals

Stock Code	Company Name	Market Capitalization (million JPY)
5929	Sanwa Holdings Corp	67,833.09
5715	Furukawa Co Ltd	33,569.82
5981	Tokyo Rope Mfg Co Ltd	45,713.76
5701	Nippon Light Metal Co Ltd	82,314.03
5812	Hitachi Cable Ltd	72,559.52
5711	Mitsubishi Materials Corp	365,540.91
5801	Furukawa Electric Co Ltd	221,187.50
5803	Fujikura Ltd	132,797.70
5938	JS Group Corp	646,457.12
5706	Mitsui Mining and Smelting Co Ltd	156,992.70
5714	DOWA Holdings Co Ltd	151,873.59
5707	Toho Zinc Co Ltd	50,945.71
5802	Sumitomo Electric Industries Ltd	876,510.38
5901	Toyo Seikan Kaisha Ltd	280,919.81
5991	NHK Spring Co Ltd	189,639.41
5727	Toho Titanium Co Ltd	122,392.60
5713	Sumitomo Metal Mining Co Ltd	840,452.50
3436	SUMCO Corp	388,431.91
5726	Osaka Titanium Technologies Co Ltd	198,720.00
5947	Rinnai Corp	298,190.50

Table A21: Oil & coal products

Stock Code	Company Name	Market Capitalization (million JPY)
5002	Showa Shell Sekiyu K K	300,726.59
5020	JX Holdings Inc	1,417,436.00
5007	Cosmo Oil Co Ltd	212,774.00
5012	TonenGeneral Sekiyu K K	561,790.88
5017	AOC Holdings Inc	45,424.71
5019	Idemitsu Kosan Co Ltd	388,400.00

Table A22: Precision instruments

Stock Code	Company Name	Market Capitalization (million JPY)
7701	Shimadzu Corp.	208,729.50
7762	Citizen Holdings Co., Ltd.	156,608.20
7731	Nikon Corp.	641,005.38
4902	Konica Minolta Holdings, Inc.	349,835.09
7733	Olympus Corp.	600,079.31
7741	HOYA Corp.	812,176.81
4543	Terumo Corp.	881,462.81
6146	Disco Corp.	182,263.70

Table A23: Real estate

Stock Code	Company Name	Market Capitalization (million JPY)
8848	Leopalace21 Corp.	19,123.39
8803	Heiwa Real Estate Co., Ltd.	37,656.39
8840	Daikyo Inc.	52,104.52
8815	Tokyu Land Corp.	190,937.59
8804	Tokyo Tatemono Co., Ltd.	131,650.00
8801	Mitsui Fudosan Co., Ltd.	1,215,485.00
3231	Nomura Real Estate Holdings, Inc.	239,506.80
8830	Sumitomo Realty & Development Co., Ltd.	771,735.38
8802	Mitsubishi Estate Co., Ltd.	1,931,262.00
4666	Park 24 Co., Ltd.	119,161.70
8905	Aeon Mall Co., Ltd.	312,819.09
8933	NTT Urban Development Corp.	229,396.59

Table A24: Retail

Stock Code	Company Name	Market Capitalization (million JPY)
3086	J.Front Retailing Co., Ltd.	175,349.91
8028	FamilyMart Co., Ltd.	302,817.69
8184	Shimachu Co., Ltd.	89,057.32
8242	H2O Retailing Corp.	113,500.70
8263	The Daiei, Inc.	36,166.27
8267	Aeon Co., Ltd.	740,412.81
8252	Marui Group Co., Ltd.	161,242.20
8233	Takashimaya Co., Ltd.	169,714.59
3050	DCM Holdings Co., Ltd.	68,511.63
2651	Lawson, Inc.	404,710.50
3099	Isetan Mitsukoshi Holdings Ltd.	282,555.69
8270	Uny Co., Ltd.	138,797.50
7532	Don Quijote Co., Ltd.	206,753.91
8273	Izumi Co., Ltd.	126,794.40
2730	Edion Corp.	74,705.60
3382	Seven & i Holdings Co., Ltd.	1,813,660.00
3337	Circle K Sunkus Co., Ltd.	106,694.80
2670	ABC-Mart, Inc.	219,332.70
7453	Ryohin Keikaku Co., Ltd.	89,007.26
9843	Nitori Holdings Co., Ltd.	402,841.09
8282	K'S Holdings Corp.	141,643.09
8227	Shimamura Co., Ltd.	248,426.50
9831	Yamada Denki Co., Ltd.	504,507.69
9983	Fast Retailing Co., Ltd.	1,083,012.00
2681	Geo Corp.	52,374.68

Table A25: Railway/bus

Stock Code	Company Name	Market Capitalization (million JPY)
9021	West Japan Railway Co.	651,000.00
9001	Tobu Railway Co., Ltd.	350,626.31
9005	Tokyu Corp.	437,179.91
9048	Nagoya Railroad Co., Ltd.	199,238.20
9041	Kintetsu Corp.	470,558.19
9042	Hankyu Hanshin Holdings, Inc.	495,848.69
9008	Keio Corp.	316,877.81
9009	Keisei Electric Railway Co., Ltd.	160,342.41
9006	Keikyu Corp.	326,500.50
9007	Odakyu Electric Railway Co., Ltd.	518,107.81
9020	East Japan Railway Co.	1,836,000.00
9022	Central Japan Railway Co.	1,395,350.00

Table A26: Rubber products

Stock Code	Company Name	Market Capitalization (million JPY)
5105	Toyo Tire & Rubber Co Ltd	51,380.34
5110	Sumitomo Rubber Industries Ltd	222,797.50
5101	The Yokohama Rubber Co Ltd	137,039.30
5108	Bridgestone Corp	1,449,762.00

Table A27: Marine transport

Stock Code	Company Name	Market Capitalization (million JPY)
9132	Daiichi Chuo Kisen Kaisha	41,904.32
9110	NS United Kaiun Kaisha, Ltd.	40,614.54
9101	Nippon Yusen K.K	549,278.00
9107	Kawasaki Kisen Kaisha, Ltd.	234,207.00
9104	Mitsui O.S.K. Lines, Ltd.	570,573.31

Table A28: Securities

Stock Code	Company Name	Market Capitalization (million JPY)
8698	Monex Group, Inc.	61,186.85
8607	Mizuho Investors Securities Co., Ltd.	96,123.91
8606	Mizuho Securities Co., Ltd.	367,631.69
8609	Okasan Securities Group Inc.	64,546.64
8616	Tokai Tokyo Financial Holdings, Inc.	79,393.79
8601	Daiwa Securities Group Inc.	642,022.00
8703	kabu.com Securities Co., Ltd.	53,134.43
8604	Nomura Holdings, Inc.	1,602,946.00
8628	Matsui Securities Co., Ltd.	121,976.90

Table A29: Shipbuilding

Stock Code	Company Name	Market Capitalization (million JPY)
7003	Mitsui Engineering & Shipbuilding Co., Ltd.	166,197.41
7007	Sasebo Heavy Industries Co., Ltd.	28,018.21
7012	Kawasaki Heavy Industries, Ltd.	586,362.19

Table A30: Steel products

Stock Code	Company Name	Market Capitalization (million JPY)
5410	Godo Steel Ltd	32,918.80
5405	Sumitomo Metal Industries Ltd	860,269.38
5479	Nippon Metal Industry Co Ltd	17,075.70
5480	Nippon Yakin Kogyo Co Ltd	21,571.36
5407	Nisshin Steel Co Ltd	166,081.50
5406	Kobe Steel Ltd	657,277.88
5401	Nippon Steel Corp	1,769,815.00
5481	Sanyo Special Steel Co Ltd	69,857.84
5423	Tokyo Steel Manufacturing Co Ltd	149,792.09
5541	Pacific Metals Co Ltd	119,420.10
5411	JFE Holdings Inc	1,452,532.00
5471	Daido Steel Co Ltd	190,305.59
5563	Nippon Denko Co Ltd	50,247.29
5486	Hitachi Metals Ltd	368,390.69
5444	Yamato Kogyo Co Ltd	185,676.00
5463	Maruichi Steel Tube Ltd	198,340.00

Table A31: Services

Stock Code	Company Name	Market Capitalization (million JPY)
9681	Tokyo Dome Corp.	28,565.51
4756	Culture Convenience Club Co., Ltd.	115,353.70
8056	Nihon Unisys, Ltd.	57,792.68
3626	IT Holdings Corp.	70,231.28
4680	Round One Corp.	35,126.67
9737	CSK Corp.	33,992.73
9766	Konami Corp.	210,801.50
9697	Capcom Co., Ltd.	105,309.60
9684	Square Enix Holdings Co., Ltd.	163,941.59
9602	Toho Co., Ltd.	221,119.00
4716	Oracle Corp. Japan	433,402.41
4661	Oriental Land Co., Ltd.	560,992.12
4307	Nomura Research Institute, Ltd.	391,275.00
4739	Itochu Techno-Solutions Corp.	165,507.00
2327	NS Solutions Corp.	80,346.66
4544	Miraca Holdings Inc.	181,522.20
4324	Dentsu Inc.	571,668.12
9735	Secom Co., Ltd.	891,162.88
4704	Trend Micro Inc.	303,313.50
7974	Nintendo Co., Ltd.	3,153,552.00
2432	DeNA Co., Ltd.	455,403.91
4689	Yahoo Japan Corp.	1,771,467.00
4321	Kenedix, Inc.	39,454.22
3789	So-net Entertainment Corp.	72,700.56
3715	Dwango Co., Ltd.	38,531.00
2371	Kakaku.com, Inc.	132,334.41

Table A32: Other transport equipment

Stock Code	Company Name	Market Capitalization (million JPY)
7231	Topy Industries, Ltd.	49,840.45
7102	Nippon Sharyo, Ltd.	54,004.05
7224	ShinMaywa Industries, Ltd.	41,186.28

Table A33: Textiles & apparel

Stock Code	Company Name	Market Capitalization (million JPY)
3103	Unitika Ltd	29,510.08
3107	Daiwabo Holdings Co Ltd	31,911.16
3101	Toyobo Co Ltd	105,968.10
3002	Gunze Ltd	62,980.55
3402	Toray Industries Inc	952,785.12
3591	Wacoal Holdings Corp	144,095.00
3401	Teijin Ltd	349,589.31
3105	Nisshinbo Holdings Inc	138,211.59

Table A34: Pulp & paper

Stock Code	Company Name	Market Capitalization (million JPY)
3864	Mitsubishi Paper Mills Ltd	29,462.25
3941	Rengo Co Ltd	141,220.20
3861	Oji Paper Co Ltd	402,336.31
3865	Hokuetsu Kishu Paper Co Ltd	90,401.97
3893	Nippon Paper Group Inc	206,584.91

Table A35: Trading companies

Stock Code	Company Name	Market Capitalization (million JPY)
8113	Unicharm Corp.	629,112.12
8020	Kanematsu Corp.	34,222.58
2768	Sojitz Corp.	205,245.91
3315	Nippon Coke & Engineering Co., Ltd.	52,608.80
3332	JFE Shoji Holdings, Inc.	83,819.30
8078	Hanwa Co., Ltd.	77,680.39
8016	Onward Holdings Co., Ltd.	103,580.10
7459	Medipal Holdings Corp.	172,634.30
8060	Canon Marketing Japan Inc.	146,094.30
8002	Marubeni Corp.	1,027,123.00
8053	Sumitomo Corp.	1,479,463.00
8001	Itochu Corp.	1,366,175.00
9987	Suzuken Co., Ltd.	196,823.50
8015	Toyota Tsusho Corp.	454,608.59
9962	Misumi Group Inc.	176,076.00
b 8036	Hitachi High-Technologies Corp.	208,811.91
8058	Mitsubishi Corp.	3,922,156.00
8031	Mitsui & Co., Ltd.	2,721,781.00
2784	Alfresa Holdings Corp.	159,295.91

Table A36: Warehousing

Stock Code	Company Name	Market Capitalization (million JPY)
9364	Kamigumi Co., Ltd.	192,316.30
9303	The Sumitomo Warehouse Co., Ltd.	77,198.88
9301	Mitsubishi Logistics Corp.	157,625.59

References

- Amyx, J. (2004). *Japan's financial crisis: Institutional rigidity and reluctant change*. Princeton University Press.
- Andrews, D. (2005). Cross-section regression with common shocks. *Econometrica*, 73(5): 1551–1585. URL <http://ideas.repec.org/a/ecm/emetrp/v73y2005i5p1551-1585.html>.
- Bai, J. (1994). Least squares estimation of a shift in linear processes. *Journal of Time Series Analysis*, 15(5): 453–472. URL <http://onlinelibrary.wiley.com/doi/10.1111/j.1467-9892.1994.tb00204.x/abstract>.
- Bai, J. (1995). Least absolute deviation estimation of a shift. *Econometric Theory*, 11(3): 403–436. URL http://econpapers.repec.org/article/cupetheor/v_3a11_3ay_3a1995_3ai_3a03_3ap_3a403-436_5f00.htm.
- Bai, J. (1997). Estimation of a change point in multiple regression models. *The Review of Economics and Statistics*, 79(4): 551–563. URL <http://ideas.repec.org/a/tpr/restat/v79y1997i4p551-563.html>.
- Bai, J. (2009). Panel data models with interactive fixed effects. *Econometrica*, 77(4): 1229–1279. URL <http://ideas.repec.org/a/ecm/emetrp/v77y2009i4p1229-1279.html>.
- Bai, J., and Carrion-i-Silvestre, J. (2009). Structural changes, common stochastic trends, and unit roots in panel data. *Review of Economic Studies*, 76(2): 471–501. URL <http://ideas.repec.org/a/bla/restud/v76y2009i2p471-501.html>.
- Bai, J., Lumsdaine, R., and Stock, J. H. (1998). Testing for and dating common breaks in multivariate time series. *Review of Economic Studies*, 65(3): 395–432. URL <http://ideas.repec.org/a/bla/restud/v65y1998i3p395-432.html>.
- Bai, J., and Perron, P. (1998). Estimating and testing linear models with multiple structural changes. *Econometrica*, 66(1): 47–78. URL <http://ideas.repec.org/a/ecm/emetrp/v66y1998i1p47-78.html>.

- Bai, J., and Perron, P. (2003). Computation and analysis of multiple structural change models. *Journal of Applied Econometrics*, 18(1): 1–21. URL <http://ideas.repec.org/a/jae/japmet/v18y2003i1p1-22.html>.
- Baker, F. (1972). Numerical taxonomy for educational researchers. *Review of Educational Research*, 42(3): 345–358. URL <http://rer.sagepub.com/content/42/3/345.full.pdf>.
- Baker, F. (1974). Stability of two hierarchical grouping techniques case 1: Sensitivity to data errors. *Journal of the American Statistical Association*, 69(346): 440–445. URL <http://www.jstor.org/stable/2285675>.
- Barberis, N., Shleifer, A., and Wurgler, J. (2005). Comovement. *Journal of Financial Economics*, 75(2): 283–317. URL <http://ideas.repec.org/a/eee/jfinec/v75y2005i2p283-317.html>.
- Barndorff-Nielsen, O., and Shepard, N. (2006). Econometrics of testing for jumps in financial economics using bipower variation. *Journal of Financial Econometrics*, 4(1): 1–30. URL <http://ideas.repec.org/a/oup/jfinec/v4y2006i1p1-30.html>.
- Baur, D., and Lucey, B. (2009). Flights and contagion — An empirical analysis of stock-bond correlations. *Journal of Financial Stability*, 5(4): 339–352. URL <http://ideas.repec.org/a/eee/finsta/v5y2009i4p339-352.html>.
- Baur, D., and Lucey, B. (2010). Is gold a hedge or a safe haven? An analysis of stocks, bonds, and gold. *The Financial Review*, 45(2): 217–229. URL <http://ideas.repec.org/a/bla/finrev/v45y2010i2p217-229.html>.
- Baxter, M., and Kouparitsas, M. (2005). Determinants of business cycle comovement: A robust analysis. *Journal of Monetary Economics*, 52(1): 113–157. URL <http://ideas.repec.org/a/eee/moneco/v52y2005i1p113-157.html>.
- Bayoumi, T. (2001). The morning after: explaining the slowdown in Japanese growth in the 1990s. *Journal of International Economics*, 53(2): 241–259. URL <http://ideas.repec.org/a/eee/inecon/v53y2001i2p241-259.html>.

- Bernaola-Galván, P., Román-Roldán, R., and Oliver, J. (1996). Compositional segmentation and long-range fractal correlations in DNA sequences. *Physical Review E*, 53(5): 5181–5189. URL http://linkage.rockefeller.edu/wli/moved.8.04/dna_corr/bernaola96.pdf.
- Bigsten, A. (2005). Can Japan make a comeback? *The World Economy*, 28(4): 595–606. URL <http://ideas.repec.org/a/bla/worlde/v28y2005i4p595-606.html>.
- Boginski, V., Butenko, S., and Pardalos, P. (2005). Statistical analysis of financial networks. *Computational Statistics & Data Analysis*, 48(2): 431–443. URL <http://ideas.repec.org/a/eee/csdana/v48y2005i2p431-443.html>.
- Bollerslev, T., Law, T., and Tauchen, G. (2008). Risk, jumps, and diversification. *Journal of Econometrics*, 144(1): 234–256. URL <http://ideas.repec.org/a/eee/econom/v144y2008i1p234-256.html>.
- Bonanno, G., Caldarelli, G., Lillo, F., and Mantegna, R. (2003). Topology of correlation-based minimal spanning trees in real and model markets. *Physical Review E*, 68(4): 046130. DOI 10.1103/PhysRevE.68.046130. URL <http://link.aps.org/doi/10.1103/PhysRevE.68.046130>.
- Bonanno, G., Caldarelli, G., Lillo, F., Miccichè, S., Vandewalle, N., and Mantegna, R. (2004). Networks of equities in financial markets. *The European Physical Journal B*, 38(2): 363–371. URL <http://www.springerlink.com/content/9v2k3000052etkr3/>.
- Bonanno, G., Vandewalle, N., and Mantegna, R. (2000). Taxonomy of stock market indices. *Physical Review E*, 62(6): R7615–R7618. URL http://econpapers.repec.org/paper/arxpapers/cond-mat_2f0001268.htm.
- Borghesi, C., Marsili, M., and Miccichè, S. (2007). Emergence of time-horizon invariant correlation structure in financial returns by subtraction of the market mode. *Physical Review E*, 76(2): 026104. URL <http://ideas.repec.org/p/arx/papers/physics-0702106.html>.

- Brida, J., and Risso, W. (2007). Dynamics and structure of the main Italian companies. *International Journal of Modern Physics C*, 18(11): 1783–1793. URL http://papers.ssrn.com/sol3/papers.cfm?abstract_id=1016048.
- Brida, J., and Risso, W. (2008). Multidimensional minimal spanning tree: The Dow Jones case. *Physica A*, 387(21): 5205–5210. URL <http://www.sciencedirect.com/science/article/pii/S0378437108004299>.
- Brida, J. G., and Risso, W. A. (2010). Dynamics and structure of the 30 largest North American companies. *Computational Economics*, 35(1): 85–99. URL <http://ideas.repec.org/a/kap/compec/v35y2010i1p85-99.html>.
- Canova, F., and Marrinan, J. (1998). Sources and propagation of international output cycles: Common shocks or transmission? *Journal of International Economics*, 46(1): 133–166. URL <http://ideas.repec.org/a/eee/inecon/v46y1998i1p133-166.html>.
- Carrion-i-Silvestre, J., Barrio-Castro, T. D., and López-Bazo, E. (2005). Breaking the panels: An application to the GDP per capita. *Econometrics Journal*, 8(2): 159–175. URL <http://ideas.repec.org/a/ect/emjrn/v8y2005i2p159-175.html>.
- Carrion-i-Silvestre, J., Kim, D., and Perron, P. (2009). GLS-based unit root tests with multiple structural breaks under both the null and the alternative hypotheses. *Econometric Theory*, 25(6): 1754–1792. URL http://ideas.repec.org/a/cup/etheor/v25y2009i06p1754-1792_99.html.
- Çukur, S., Eryiğit, M., and Eryiğit, R. (2007). Cross correlations in an emerging market financial data. *Physica A*, 376: 555–564. URL <http://www.mendeley.com/research/darboux-theorems-and-wronskian-formulas-for-integrable-systems-i-constrained-kp-flows/>.
- Cheong, S.-A., Stodghill, P., Schneider, D., Cartinhour, S., and Myers, C. (2009a). Extending the recursive Jensen–Shannon segmentation of biological sequences. URL http://arxiv.org/PS_cache/arxiv/pdf/0904/0904.2466v1.pdf. Q-bio/0904.2466.

- Cheong, S.-A., Stodghill, P., Schneider, D., Cartinhour, S., and Myers, C. R. (2009b). The context sensitivity problem in biological sequence segmentation. URL <http://arxiv.org/abs/0904.2668>. Q-bio/0904.2668.
- Cheung, W., Fung, S., and Tsai, S.-C. (2010). Global capital market interdependence and spillover effect of credit risk: evidence from the 2007-2009 global financial crisis. *Applied Financial Economics*, 20(1): 85–103. URL <http://ideas.repec.org/a/taf/apfie/v20y2010i1-2p85-103.html>.
- Chong, T.-L. (1995). Partial parameter consistency in a misspecified structural change model. *Economics Letters*, 49(4): 351–357. URL <http://ideas.repec.org/a/eee/econlet/v49y1995i4p351-357.html>.
- Chong, T.-L. (2001). Structural change in AR(1) models. *Econometric Theory*, 17(1): 87–155. URL http://ideas.repec.org/a/cup/etheor/v17y2001i01p87-155_17.html.
- Coelho, R., Gilmore, C., Lucey, B., Richmond, P., and Hutzler, S. (2007a). The evolution of interdependence in world equity markets — Evidence from minimum spanning trees. *Physica A*, 376: 455–466. URL <http://arxiv.org/abs/physics/0607022>.
- Coelho, R., Hutzler, S., Repetowicz, P., and Richmond, P. (2007b). Sector analysis for a FTSE portfolio of stocks. *Physica A*, 373: 615–626. URL <http://arxiv.org/abs/physics/0601189>.
- Connolly, R., Stivers, C., and Sun, L. (2005). Stock market uncertainty and the stock-bond return relation. *Journal of Financial and Quantitative Analysis*, 40(1): 161–194. URL <http://www.jstor.org/stable/27647190>.
- Connolly, R., Stivers, C., and Sun, L. (2007). Commonality in the time-variation of stock-stock and stock-bond return comovements. *Journal of Financial Markets*, 10(2): 192–218. URL <http://ideas.repec.org/a/eee/finmar/v10y2007i2p192-218.html>.
- Croux, C., Forni, M., and Reichlin, L. (2001). A measure of comovement for economic variables: Theory and empirics. *Review of Economics and Statistics*,

- 83(2): 232–241. URL <http://ideas.repec.org/a/tpr/restat/v83y2001i2p232-241.html>.
- Duch, J., and Arenas, A. (2005). Community detection in complex networks using extremal optimization. *Physical Review E*, 72(2): 027104. DOI <http://arxiv.org/abs/cond-mat/0501368>.
- Eng, L. (Apr 2010). *Financial Time Series Segmentation Based on Lévy Stable Distributions*. Master's thesis, Nanyang Technological University.
- Eom, C., Oh, G., Jung, W.-S., Jeong, H., and Kim, S. (2009). Topological properties of stock networks based on minimal spanning tree and random matrix theory in financial time series. *Physica A*, 388: 900–906. URL <http://www.sciencedirect.com/science/article/pii/S0378437108009862>.
- Eryiğit, M., and Eryiğit, R. (2009). Network structure of cross-correlations among the world market indices. *Physica A*, 388: 3551–3562. URL <http://dkydros.files.wordpress.com/2010/02/turkey-pmfg.pdf>.
- Fama, E., and Roll, R. (1971). Parameter estimates for symmetric stable distributions. *Journal of the American Statistical Association*, 66(334): 331–338. URL <http://www.jstor.org/stable/2283932>.
- Faruqee, H., and Mühleisen, M. (2003). Population aging in Japan: demographic shock and fiscal sustainability. *Japan and the World Economy*, 15(2): 185–210. URL <http://ideas.repec.org/a/eee/japwor/v15y2003i2p185-210.html>.
- Forbes, K., and Rigobon, R. (2002). No contagion, only interdependence: Measuring stock market comovements. *Journal of Finance*, 57(5): 2223–2261. URL <http://web.mit.edu/kjforbes/www/Papers/NoContagion-JOF.pdf>.
- Fortunato, S. (2010). Community detection in graphs. *Physics Reports*, 486(3–5): 75–174. URL http://arxiv.org/PS_cache/arxiv/pdf/0906/0906.0612v2.pdf.
- Fox News (2010). *Japan's prime minister survives leadership vote, now must revive sputtering economy*. URL <http://www.foxnews.com/world/2010/09/14/japan-pm-faces-powerful-challenger-leadership-vote-country-new-leader/>.

- Gilmore, C., Lucey, B., and Boscia, M. (2008). An ever-closer union? Examining the evolution of linkages of European equity markets via minimum spanning trees. *Physica A*, 387: 6319–6329.
- Girvan, M., and Newman, M. (2002). Community structure in social and biological networks. *Proceedings of the National Academy of Sciences of the United States of America*, 99(12): 7821–7826. URL <http://www.santafe.edu/media/workingpapers/01-12-077.pdf>.
- Gligor, M., and Ausloos, M. (2007). Cluster structure of EU-15 countries derived from the correlation matrix analysis of macroeconomic index fluctuations. *The European Physical Journal B*, 57: 139–146. URL <http://arxiv.org/abs/physics/0607098>.
- Goldfeld, S., and Quandt, R. (1973). A Markov model for switching regressions. *Journal of Econometrics*, 1(1): 3–15. URL <http://ideas.repec.org/a/eee/econom/v1y1973i1p3-15.html>.
- Gower, J., and Ross, G. (1969). Minimum spanning trees and single linkage cluster analysis. *Journal of the Royal Statistical Society Series C*, 18(1): 54–64. URL <http://www.jstor.org/stable/2346439>.
- Guo, W., and Wohar, M. (2006). Identifying regime changes in market volatility. *Journal of Financial Research*, 29(1): 79–93. URL <http://ideas.repec.org/a/bla/jfnres/v29y2006i1p79-93.html>.
- Hamilton, J. (1989). A new approach to the economic analysis of nonstationary time series and the business cycle. *Econometrica*, 57(2): 357–384. URL <http://ideas.repec.org/a/ecm/emetrp/v57y1989i2p357-84.html>.
- Hansen, B. (2001). The new econometrics of structural change: Dating breaks in U.S. labor productivity. *The Journal of Economic Perspectives*, 15(4): 117–128. URL http://www.uibk.ac.at/econometrics/dl/jep01fall/09_structchange.pdf.
- Hayashi, F., and Prescott, E. (2002). The 1990s in Japan: A lost decade. *Review of Economic Dynamics*, 5(1): 206–235. URL <http://ideas.repec.org/a/red/issued/v5y2002i1p206-235.html>.

- Hill, B. (1975). A simple general approach to inference about the tail of a distribution. *The Annals of Statistics*, 3(5): 1163–1174. URL <http://www.nslj-genetics.org/wli/zipf/hill75-as.pdf>.
- Hill, R. (1999). Comparing price levels across countries using minimum-spanning trees. *The Review of Economics and Statistics*, 81(1): 135–142. URL <http://www.jstor.org/stable/2646792>.
- Hill, R. (2001). Measuring inflation and growth using spanning trees. *International Economic Review*, 42(1): 167–185. URL <http://ideas.repec.org/a/ier/iecrev/v42y2001i1p167-85.html>.
- Hoshi, T., and Kashyap, A. (2004). Japan's financial crisis and economic stagnation. *The Journal of Economic Perspectives*, 18(1): 3–26. URL <http://pzacad.pitzer.edu/~lyamane/hoshi1.pdf>.
- Iida, Y., and Matsumae, T. (2009). *The dynamic effects of Japanese macroeconomic policies: Were there any changes in the 1990s?* Economic and Social Research Institute. URL http://www.esri.go.jp/jp/archive/e_dis/e_dis210/e_dis209a.pdf.
- Im, K.-S., Lee, J., and Tieslau, M. (2005). Panel LM unit-root tests with level shifts. *Oxford Bulletin of Economics and Statistics*, 67(3): 393–419. URL http://econpapers.repec.org/article/blaobuest/v_3a67_3ay_3a2005_3ai_3a3_3ap_3a393-419.htm.
- Jacod, J., and Todorov, V. (2009). Testing for common arrivals of jumps for discretely observed multidimensional processes. *Annals of Statistics*, 37(4): 1792–1838. URL <http://www.kellogg.northwestern.edu/faculty/todorov/html/papers/jt.pdf>.
- Jain, A., Murty, M., and Flynn, P. (1999). Data clustering: A review. *ACM Computing Surveys*, 31(3): 264–323. URL <http://doi.acm.org/10.1145/331499.331504>.
- Japan Economy News & Blog (2010). *IMF: Japan's national debt to hit 250% of GDP in 2015*.

- Johnson, S. (1967). Hierarchical clustering schemes. *Psychometrika*, 32(3): 241–254. URL <http://ideas.repec.org/a/spr/psycho/v32y1967i3p241-254.html>.
- Jung, W.-S., Chae, S., Yang, J.-S., and Moon, H.-T. (2006). Characteristics of the Korean stock market correlations. *Physica A*, 361: 263–271. URL <http://arxiv.org/abs/physics/0504009>.
- Jung, W.-S., Kwon, O., Wang, F., Kaizoji, T., Moon, H.-T., and Stanley, H. (2008). Group dynamics of the Japanese market. *Physica A*, 387: 537–542. URL <http://ideas.repec.org/p/arx/papers/0708.0562.html>.
- Karolyi, G., and Stulz, R. (1996). Why do markets move together? An investigation of U.S.–Japan stock return comovements. *Journal of Finance*, 51(3): 951–986. URL <http://ideas.repec.org/a/bla/jfinan/v51y1996i3p951-86.html>.
- Kim, C.-J., and Nelson, C. (1999). Has the U.S. economy become more stable? A Bayesian approach based on a Markov-switching model of business cycle. *Review of Economics and Statistics*, 81(4): 608–616. URL <http://ideas.repec.org/a/tpr/restat/v81y1999i4p608-616.html>.
- Kim, D. (2009). Estimating a common deterministic time trend break in large panels with cross sectional dependence. Discussion paper, University of Virginia, Charlottesville. URL <http://www.columbia.edu/~ao2027/Dukpa.pdf>. Working paper.
- Koutrouvelis, I. (1980). Regression-type estimation of the parameters of stable laws. *Journal of the American Statistical Association*, 75(372): 918–928. URL <http://www.jstor.org/stable/2287182>.
- Koutrouvelis, I. A. (1981). An iterative procedure for the estimation of the parameters of stable laws. *Communications in Statistics — Simulation and Computation*, 10(1): 17–28. URL <http://www.tandfonline.com/doi/abs/10.1080/03610918108812189>.
- Kruskal, J. (1956). On the shortest spanning subtree of a graph and the traveling salesman problem. *Proceedings of the American Mathematical Society*, 7(1): 48–50. URL <http://www.jstor.org/stable/2033241>.

- Kulkarni, V., and Deo, N. (2007). Correlation and volatility in an Indian stock market: A random matrix approach. *The European Physical Journal B*, 60: 101–109. URL <http://www.springerlink.com/content/38m04076514r4051/>.
- Kurihara, J. (2007). Demystifying Japan's Economic Recovery. *Business Economics*, 42(3): 29–35. URL http://econpapers.repec.org/article/palbuseco/v_3a42_3ay_3a2007_3ai_3a3_3ap_3a29-35.htm.
- Laloux, L., Cizeau, P., Bouchaud, J.-P., and Potters, M. (1999). Noise dressing of financial correlation matrices. *Physical Review Letters*, 83(7): 1467–1470. URL <http://arxiv.org/abs/cond-mat/9810255>.
- Lancichinetti, A., and Fortunato, S. (2009). Community detection algorithms: A comparative analysis. *Physical Review E*, 80(5): 056117. URL <http://arxiv.org/abs/0908.1062>.
- Lavielle, M., and Moulines, E. (2000). Least-squares estimation of an unknown number of shifts in a time series. *Journal of Time Series Analysis*, 21(1): 33–59. URL <http://onlinelibrary.wiley.com/doi/10.1111/1467-9892.00172/pdf>.
- Lee, G., Zhang, Y., Wong, J., Prusty, M., and Cheong, S. (25 Nov 2009). Causal links in US economic sectors. URL <http://arxiv.org/abs/0911.4763>. ArXiv:0911.4763.
- Li, W. (2001a). DNA segmentation as a model selection process. In *Proceedings of the International Conference on Research in Computational Molecular Biology (RECOMB)*, pages 204–210. URL <http://arxiv.org/abs/physics/0104026>.
- Li, W. (2001b). New stopping criteria for segmenting DNA sequences. *Physical Review Letters*, 86(25): 5815–5818. URL <http://arxiv.org/abs/physics/0104027>.
- Lin, J. (1991). Divergence measures based on the Shannon entropy. *IEEE Transactions on Information Theory*, 37(1): 145–151. URL <http://ieeexplore.ieee.org/stamp/stamp.jsp?tp=&arnumber=61115&userType=inst>.
- Lo, A. (2009). Regulatory reform in the wake of the financial crisis of 2007–2008. *Journal of Financial Economic Policy*, 1(1): 4–43. URL <http://ideas.repec.org/a/eme/jfeppp/v1y2009i1p4-43.html>.

- Loader, C. (1996). Change point estimation using nonparametric regression. *Annals of Statistics*, 24(4): 1667–1678. URL <http://www.jstor.org/stable/2242744>.
- Lumsdaine, R., and Papell, D. (1997). Multiple trend breaks and the unit-root hypothesis. *Review of Economics and Statistics*, 79(2): 212–218. URL <http://www.jstor.org/stable/2951453>.
- MacKellar, L. (2004). *Economic impacts of population aging in Japan*. Cheltenham: Edward Elgar Publishing.
- Mantegna, R. (1999). Hierarchical structure in financial markets. *The European Physical Journal B*, 11: 193–197. URL <http://arxiv.org/abs/cond-mat/9802256>.
- Mantegna, R., and Stanley, H. (1995). Scaling behaviour in the dynamics of an economic index. *Nature*, 376: 46–49. URL <http://www.nature.com/nature/journal/v376/n6535/abs/376046a0.html>.
- Matteo, T. D., and Aste, T. (12 Dec 2005). Extracting the correlation structure by means of planar embedding. In *Proceedings of the SPIE Conference on Complex Systems*, volume 6039, pages 227–236. URL http://people.physics.anu.edu.au/~tdm110/Articoli_web/My%20articles/2006/SPIEDiMatteo_1.pdf.
- McCulloch, J. (1986). Simple consistent estimators of stable distribution parameters. *Communications in Statistics — Simulation and Computation*, 15(4): 1109–1136. URL <http://dx.doi.org/10.1080/03610918608812563>.
- McCulloch, J., and Panton, D. (1997). Precise tabulation of the maximally-skewed stable distributions and densities. *Computational Statistics & Data Analysis*, 23(3): 307–320. URL <http://ideas.repec.org/a/eee/csdana/v23y1997i3p307-320.html>.
- Miccichè, S., Bonanno, G., Lillo, F., and Mantegna, R. (2003). Degree stability of a minimum spanning tree of price return and volatility. *Physica A*, 324: 66–73. URL http://econpapers.repec.org/paper/arxpapers/cond-mat_2f0212338.htm.
- Miśkiewicz, J., and Ausloos, M. (2006). An attempt to observe economy globalization: The cross correlation distance evolution of the top 19 GDPs.

- International Journal of Modern Physics C*, 17(3): 317–331. URL <http://arxiv.org/abs/physics/0509165>.
- Münnix, M., Schäfer, R., and Grothe, O. (30 Jun 2010). Estimating correlation and covariance matrices by weighting of market similarity. URL <http://arxiv.org/abs/1006.5847>. ArXiv:1006.5847.
- Newman, M. (2004). Detecting community structure in networks. *The European Physical Journal B*, 38(2): 321–330. URL <http://www-personal.umich.edu/~mejn/papers/epjb.pdf>.
- Newman, M. (2006). Modularity and community structure in networks. *Proceedings of the National Academy of Sciences of the United States of America*, 103(23): 8577–8582. URL <http://www.mendeley.com/research/modularity-community-structure-networks-56/>.
- Nolan, J. (1997). Numerical calculation of stable densities and distribution functions. *Stochastic Models*, 13(4): 759–774.
- Nolan, J. (1998). Parameterizations and modes of stable distributions. *Statistics & Probability Letters*, 38(2): 187–195. URL <http://ideas.repec.org/a/eee/stapro/v38y1998i2p187-195.html>.
- Nolan, J. (1999). An algorithm for evaluating stable densities in Zolotarev’s (M) parameterization. *Mathematical and Computer Modelling*, 29(10–12): 229–233. URL <http://www.sciencedirect.com/science/article/pii/S0895717799001053>.
- Nolan, J. (2001). Maximum likelihood estimation and diagnostics for stable distributions Lévy Processes Theory and Applications. In T. M. O.E. Barndorff-Nielsen, and S. Resnick (Eds.), *Lévy Processes Theory and Applications*, pages 379–400. Boston: Birkhäuser. URL <http://academic2.american.edu/~jpnolan/stable/mle.pdf>. O. E. Barndorff-Nielsen and T. Mikosch and S. I. Resnick.
- Onnela, J.-P., Chakraborti, A., Kaski, K., and Kertész, J. (2003a). Dynamic asset trees and Black Monday. *Physica A*, 324: 247–252. URL <http://arxiv.org/abs/cond-mat/0212037>.

- Onnela, J.-P., Chakraborti, A., Kaski, K., Kertész, J., and Kanto, A. (2003b). Asset trees and asset graphs in financial markets. *Physica Scripta*, T106: 48–54. URL <http://lib.tkk.fi/Diss/2006/isbn9512282704/article3.pdf>.
- Onnela, J.-P., Chakraborti, A., Kaski, K., Kertész, J., and Kanto, A. (2003c). Dynamics of market correlations: Taxonomy and portfolio analysis. *Physical Review E*, 68(5): 056110. URL <http://lib.tkk.fi/Diss/2006/isbn9512282704/article4.pdf>.
- Onnela, J.-P., Kaski, K., and Kertész, J. (2004). Clustering and information in correlation based financial networks. *The European Physical Journal B*, 38: 353–362. URL <http://lib.tkk.fi/Diss/2006/isbn9512282704/article5.pdf>.
- Panton, D. (1992). Cumulative distribution function values for symmetric standardized stable distributions. *Communications in Statistics — Simulation and Computation*, 21(2): 485–492.
- Panton, D. B., Lessig, V. P., and Joy, O. M. (1976). Comovement of international equity markets: A taxonomic approach. *Journal of Financial and Quantitative Analysis*, 11(3): 415–432. URL http://ideas.repec.org/a/cup/jfinqa/v11y1976i03p415-432_02.html.
- Perron, P., and Zhu, X. (2005). Structural breaks with deterministic and stochastic trends. *Journal of Econometrics*, 129(1–2): 65–119. URL <http://ideas.repec.org/a/eee/econom/v129y2005i1-2p65-119.html>.
- Plerou, V., Gopikrishnan, P., Rosenow, B., Amaral, L., Guhr, T., and Stanley, H. (2002). Random matrix approach to cross correlations in financial data. *Physical Review E*, 65(6): 066126. URL <http://polymer.bu.edu/hes/articles/pgrags02.pdf>.
- Posen, A. (1998). *Restoring Japan's economic growth*. Washington, DC: Petersen Institute.
- Reichardt, J., and Bornholdt, S. (2006). Statistical mechanics of community detection. *Physical Review E*, 74(1): 016110. URL <http://pre.aps.org/abstract/PRE/v74/i1/e016110>.

- Reuters (2010). *IMF urges tax increase to tackle Japan debt*. URL <http://www.reuters.com/article/2010/07/14/imf-japan-idUSNLLLEIE69620100714>.
- Rigobon, R. (2003). On the measurement of the international propagation of shocks: Is the transmission stable? *Journal of International Economics*, 61(2): 261–283. URL <http://ideas.repec.org/a/eee/inecon/v61y2003i2p261-283.html>.
- Román-Roldán, R., Bernaola-Galván, P., and Oliver, J. (1998). Sequence compositional complexity of DNA through an entropic segmentation method. *Physical Review Letters*, 80(6): 1344–1347. URL <http://www.nslj-genetics.org/dnacorr/roman98.pdf>.
- Shen, J., and Zheng, B. (2009). Cross-correlation in financial dynamics. *Europhysics Letters*, 86: 1–6. URL <http://iopscience.iop.org/0295-5075/86/4/48005>.
- Sneath, P. H. A. (1957). The application of computers to taxonomy. *Journal of General Microbiology*, 17: 201–226. URL <http://www.ncbi.nlm.nih.gov/pubmed/13475686>.
- Stockman, A., and Tesar, L. (1995). Tastes and technology in a two-country model of the business cycle: Explaining international comovement. *The American Economic Review*, 85(1): 168–185. URL <http://ideas.repec.org/a/aea/aecrev/v85y1995i1p168-85.html>.
- Today (2011). *New faces to revive Japan's economy*. URL <http://www.todayonline.com/World/EDC110115-0000209/New-faces-to-revive-Japans-economy>.
- Tóth, B., Lillo, F., and Farmer, J. (2010). Segmentation algorithm for non-stationary compound Poisson processes. *The European Physical Journal B - Condensed Matter and Complex Systems*, 78(2): 235–243. URL <http://tuvalu.santafe.edu/~jdf/papers/SegmentationAlgorithm.pdf>.
- Tudor, C. (2009). Understanding the roots of the US Subprime Crisis and its subsequent effects. *The Romanian Economic Journal*, 31: 115–148. URL <http://www.rejournal.eu/Portals/0/Arhiva/JE%2031/JE%2031%20-%20Cristiana%20TUDOR.pdf>.

- Tumminello, M., Matteo, T. D., Aste, T., and Mantegna, R. (2007). Correlation based networks of equity returns sampled at different time horizons. *The European Physical Journal B*, 55: 209–217. URL http://people.physics.anu.edu.au/~tas110/Pubblicazioni/EPJB_CorrReturn07.pdf.
- Utsugi, A., Ino, K., and Oshikawa, M. (2004). Random matrix theory analysis of cross correlations in financial markets. *Physical Review E*, 70(2): 026110. URL <http://arxiv.org/abs/cond-mat/0312643>.
- Vaglica, G., Lillo, F., Moro, E., and Mantegna, R. (2008). Scaling laws of strategic behavior and size heterogeneity in agent dynamics. *Physical Review E*, 77(3): 1–6. URL <http://pre.aps.org/abstract/PRE/v77/i3/e036110>.
- Wall Street Journal (2009). *Japanese reform gets lost in the mail*. URL <http://online.wsj.com/article/SB10001424052748703363704574502651479212142.html>.
- Wilcox, D., and Gebbie, T. (2004). On the analysis of cross-correlations in South African market data. *Physica A*, 344: 294–298. URL <http://www.sciencedirect.com/science/article/pii/S0378437104009537>.
- Wilcox, D., and Gebbie, T. (2007). An analysis of cross-correlations in an emerging market. *Physica A*, 375: 584–598.
- Wong, D., and Li, K.-W. (2010). Comparing the performance of relative stock return differential and real exchange rate in two financial crises. *Applied Financial Economics*, 20(1): 137–150. URL <http://ideas.repec.org/a/taf/apfie/v20y2010i1-2p137-150.html>.
- Wong, J., Lian, H., and Cheong, S. (2009). Detecting macroeconomic phases in the Dow Jones Industrial Average time series. *Physica A*, 388(21): 4635–4645. URL <http://dr.ntu.edu.sg/handle/10220/6107>.
- Worsdale, G. (1975). Tables of cumulative distribution functions for symmetric stable distributions. *Journal of the Royal Statistical Society Series C (Applied Statistics)*, 24(1): 123–131. URL <http://www.jstor.org/stable/2346710>.
- Yim, W. (Nov 2010). *Between Japanese economic sectors*. Master’s thesis, Nanyang Technological University.

- Yoshino, N., and Mizoguchi, T. (2010). The role of public works in the political business cycle and the instability of the budget deficits in Japan. *Asian Economic Papers*, 9(1): 94–112. URL http://econpapers.repec.org/article/tprasiaec/v_3a9_3ay_3a2010_3ai_3a1_3ap_3a94-112.htm.
- Zhang, Y., Lee, G., Wong, J., Kok, J., Prusty, M., and Cheong, S. (2011). Will the US economy recover in 2010? A minimal spanning tree study. *Physica A*, 390(11): 2020–2050. URL <http://www.sciencedirect.com/science/article/pii/S0378437111000847>.
- Zivot, E., and Andrews, D. (2002). Further evidence on the Great Crash, the oil-price shock, and the unit-root hypothesis. *Journal of Business and Economic Statistics*, 20(1): 25–44. URL <http://ideas.repec.org/a/bs/jnlbes/v20y2002i1p25-44.html>.
- Zolotarev, V. (1986). *One-dimensional stable distributions*. Providence: American Mathematical Society.

Please note:

You are most sincerely encouraged to participate in the open assessment of this article. You can do so by either recommending the article or by posting your comments.

Please go to:

<http://dx.doi.org/10.5018/economics-ejournal.ja.2012-5>

The Editor