

Jay, Stephan; Neumann, Karl-Heinz; Plückebaum, Thomas

Conference Paper

Critical market shares for investors and access seekers and competitive models in fibre networks

22nd European Regional Conference of the International Telecommunications Society (ITS): "Innovative ICT Applications - Emerging Regulatory, Economic and Policy Issues", Budapest, Hungary, 18th-21st September, 2011

Provided in Cooperation with:

International Telecommunications Society (ITS)

Suggested Citation: Jay, Stephan; Neumann, Karl-Heinz; Plückebaum, Thomas (2011) : Critical market shares for investors and access seekers and competitive models in fibre networks, 22nd European Regional Conference of the International Telecommunications Society (ITS): "Innovative ICT Applications - Emerging Regulatory, Economic and Policy Issues", Budapest, Hungary, 18th-21st September, 2011, International Telecommunications Society (ITS), Calgary

This Version is available at:

<https://hdl.handle.net/10419/52199>

Standard-Nutzungsbedingungen:

Die Dokumente auf EconStor dürfen zu eigenen wissenschaftlichen Zwecken und zum Privatgebrauch gespeichert und kopiert werden.

Sie dürfen die Dokumente nicht für öffentliche oder kommerzielle Zwecke vervielfältigen, öffentlich ausstellen, öffentlich zugänglich machen, vertreiben oder anderweitig nutzen.

Sofern die Verfasser die Dokumente unter Open-Content-Lizenzen (insbesondere CC-Lizenzen) zur Verfügung gestellt haben sollten, gelten abweichend von diesen Nutzungsbedingungen die in der dort genannten Lizenz gewährten Nutzungsrechte.

Terms of use:

Documents in EconStor may be saved and copied for your personal and scholarly purposes.

You are not to copy documents for public or commercial purposes, to exhibit the documents publicly, to make them publicly available on the internet, or to distribute or otherwise use the documents in public.

If the documents have been made available under an Open Content Licence (especially Creative Commons Licences), you may exercise further usage rights as specified in the indicated licence.

22nd European Regional ITS Conference
Budapest, 18-21 September, 2011

**Stephan Jay
Karl-Heinz Neumann
Thomas Plückebaum**
**Critical market shares for investors and access seekers
and competitive models in fibre networks**

Abstract

In this paper we consider and evaluate NGA architectures which meet the foreseeable future bandwidth demand and allow for highest bandwidth and quality for end-users and which no longer rely on copper cable elements. These are FTTH architectures only. From all available FTTH architectures we concentrate on the two most relevant architectures in Europe, Ethernet Point-to-Point and GPON. We assume the incumbent to be the investor in the NGA network infrastructure. If the NGA architecture is based on a Point-to-Point fibre plant we have modelled the competitors as using unbundled fibre loops as the wholesale access service. If the architecture is based on a Point-to-Multipoint fibre plant, we consider an active wholesale access (bitstream access) at the MPoP or at the core network node locations. Our basic modelling relies upon an engineering bottom-up cost modelling approach. We model the total cost of the services considered under efficient conditions, taking into account the cost of all network elements needed to produce these services in the specific architecture deployed. This approach is coherent with a Long Run Incremental Cost approach as applied in regulatory economics. Our modelling approach generates a broad set of results including the relative performance of the various network architectures, investment requirements and the degree of profitable coverage. In this paper, however, we focus on the results on the potential for competition and potential market structures in an NGA environment.

JEL codes L10, L13, L14

Keywords NGA architecture, cost modelling, FTTH, coverage, access models, unbundling

Authors' affiliation and corresponding author's e-mail address

**WIK Wissenschaftliches Institut für Infrastruktur
und Kommunikationsdienste GmbH
Rhöndorfer Str. 68
53604 Bad Honnef
Germany
E-Mail: k-h.neumann@wik.org**

Critical market shares for investors and access seekers and competitive models in fibre networks

Paper to be presented at the
22nd European Regional ITS Conference
in Budapest, 18 – 21 September 2011

Authors:
Stephan Jay
Karl-Heinz Neumann
Thomas Plückebaum

WIK Wissenschaftliches Institut für Infrastruktur
und Kommunikationsdienste GmbH
Rhöndorfer Str. 68
53604 Bad Honnef
Germany
E-Mail: k-h.neumann@wik.org

Summary

In this paper we consider and evaluate NGA architectures which meet the foreseeable future bandwidth demand and allow for highest bandwidth and quality for end-users and which no longer rely on copper cable elements. These are FTTH architectures only. From all available FTTH architectures we concentrate on the two most relevant architectures in Europe, Ethernet Point-to-Point and GPON. In order to overcome some restrictions and weaknesses being discussed for GPON we also include into our considerations two (G)PON variants, one implementing GPON on top of a passive Point-to-Point fibre plant and a future version of PON, increasing the bandwidth and quality of the current PON systems by using WDM technology on a Point-to-Multipoint fibre topology.

We assume the incumbent to be the investor in the NGA network infrastructure. If the NGA architecture is based on a Point-to-Point fibre plant we have modelled the competitors as using unbundled fibre loops as the wholesale access service. If the architecture is based on a Point-to-Multipoint fibre plant, we consider an active wholesale access (bitstream access) at the MPoP or at the core network node locations. In total we consider the architectures and wholesale scenarios as presented in Table 1.

Table 1: Overview of the architecture scenarios considered

Scenario name	Incumbent architecture	Competitor (Entrant) wholesale base
P2P unbundling	Ethernet P2P	Fibre LLU at MPoP
GPON over P2P unbundling	GPON over P2P	Fibre LLU at MPoP
WDM PON unbundling	WDM PON	WDM unbundling at Core Nodes
GPON bitstream core	GPON	Bitstream access at Core Nodes
GPON bitstream MPoP	GPON	Bitstream access at the MPoP

Our basic modelling relies upon an engineering bottom-up cost modelling approach. We model the total cost of the services considered under efficient conditions, taking into account the cost of all network elements needed to produce these services in the specific architecture deployed. This approach is coherent with a Long Run Incremental Cost approach as applied in regulatory economics.

For the model we have not chosen a dedicated European country but will choose a settlement structure which is typical for European countries and designed the hypothetical country for approximately 22 million households or a population of around 40 Mio. inhabitants. This country is referred to as “Euroland”.

Our modelling approach generates a broad set of results including the relative performance of the various network architectures, investment requirements and the degree of profitable coverage. In this paper, however, we focus on the results on the potential for competition and potential market structures in an NGA environment.

The major market structure implications are derived from the concept of critical market shares. A critical market share is the minimum market share of the potentially addressable access market which an operator needs to run a viable business model. In case of the investor it is similar to the take-up rate of the fibre network. In case of the access seeker the critical market share is determined on the basis of an LRIC-based wholesale ULL product. Our cost modelling approach determines the critical market share for the steady state by comparing total costs of services with the APRUs of a relevant composite commodity of the relevant services (single play, double play, triple play) and user groups (business and residential users). The critical market shares determine the (maximum) number of firms in the market. In case of the investor they also show in which areas a fibre network may be replicated.

We have also calculated the impact of deviations from LRIC based wholesale prices on the structural conditions of competition. Even a moderate increase of the wholesale prices by 10% reduces the viability of competition and the competitive coverage in most cases. The most significant impacts occur in the LLU unbundling scenarios. Critical market shares of competitors in all scenarios increase significantly. In a set of further sensitivities we also show the impact of a Brownfield scenario on the critical market shares and on competition. In a Brownfield scenario the incumbent can use (parts of) the duct infrastructure of the copper network for rolling out its fibre network. We will derive the impacts on competition under different assumptions on the reflection of cost savings on the wholesale price.

1 Introduction¹

There is an ongoing discussion in the market which NGA architecture best suits future needs, which investment and cost differences do exist and to which part they may contribute to the overall result. The discussion can be subsumed as P2P vs. GPON, which is somewhat misleading as our study reveals. The discussion is driven by the fact that the high capital cost and the long asset life time of fibre mean that the technology choices made today will dictate the opportunities for telecommunication business of all market players, incumbents, competitors, content providers and business and residential users for many years in the future.

All FTTH architectures offer higher bandwidth per end customer than today, but differ in absolute bandwidth values and also may slightly differ in quality caused by different overbooking behaviour. These differences take place not only in the incumbent's network, who is deploying the NGA network, but also in the competitors' networks relying on the wholesale products of the incumbent. There are already different opportunities in the type of the products (physical unbundled fibre lines or bitstream), but also in the locations where to access the wholesaler's network. Access at the Metropolitan Point of Presence² (MPoP) can be given in a physically unbundled manner or as bitstream only, depending on the underlying fibre topology (fibre point-to-point (P2P) or fibre point-to-multi-point (PMP)). Two European countries have defined bitstream access at the MPoP to be in Market 4 and called it Virtual Unbundled Local Access³ or virtual Unbundled Local Loop⁴. Access at other locations in the concentration or core network only can be provided as bitstream.

There also could be differences caused by a weak or strong regulation or by the method wholesale prices are calculated, e.g. based on LRIC and current cost in a Greenfield or on historic cost in a Brownfield approach, where already existing ducts are considered with an reduced amount of investment.

We have analysed the cost and their differences between fibre FTTH network architectures and their related different wholesale approaches by using the well-known and understood steady state approach we already have chosen for other NGA analyses in the past⁵. We expanded this by a dynamic cost consideration taking into account the different investment behaviour of the FTTH architectures.

2 Modelling approach

We will not describe the modelling approach chosen in all details here since it follows the same principles like the previous studies already mentioned above. Our steady state model assumes a situation somewhere in the future when the NGA network has been rolled out and customer acquisition has achieved its final stable state. The cost of the NGA networks are modelled in detail in a bottom-up LRIC manner up to the MPoP.

¹ This article is based on the study Hoernig et al. (2010).

² For definition see EU NGA Recommendation 2010.

³ VULA by OFCOM (UK).

⁴ vULL by RTR (A).

⁵ Elixmann et al. (2008), Ilic et al. (2009a), Ilic et al. (2009b).

The cost of the concentration and core network are taken from cost functions we have derived out of previous NGN modelling for comparable circumstances. This approximation we believe to be appropriate since the total cost share of this network parts are minor compared to the costs of the access network as we will show later.

In order to deal with the on-going discussions about space and energy consumption of the various FTTH architectures we also modelled the appropriate capex and opex cost in a bottom up manner. Opex for other aspects and for common costs are considered as equipment specific mark-ups.

Our steady state approach first of all determines the critical market share an operator requires in a cluster to achieve a profitable business with a given customer mix and ARPU of 44.25 € per month. This value includes the coverage of cost of fibre inhouse cabling and CPE.

The critical market share describes the point where the average cost per customer becomes lower than the ARPU, thus the point where the business starts to become profitable⁶. We assume an upper limit of 70% of end customers to be connectable (retail and wholesale) taking into consideration that there also exist cable and mobile only customers as well as non-users. Thus a cluster is not profitable if the required critical market share exceeds this limit (70%).

For the dynamic effects of investment and cost we added a cost consideration over a time frame of 20 years, taking into account the network build phase over time, starting with the densest populated and therefore most attractive clusters first and restricting the roll out to the profitable clusters only. The acquisition of customers begins with the availability of the access line at the customer premise (home passed) and ends five years later at the maximum market share of 70% (retail and wholesale access lines), taking into account that customer acquisition takes time due to existing end customer contract duration and permissions of the house owners to connect the buildings.⁷

The cost differences of the approaches will be compared based on the respective net present values (NPV). The weighted average cost of capital are assumed to be 10% p.a. Price changes and inflation are assumed to be of equal size.

3 Scenarios considered

Much of the discussion about the appropriate FTTH architecture meeting future needs is focussed on Ethernet Point-to-Point vs. GPON Point-to-Multi-Point. Due to the relative short life times of the transmission equipment (approximately 8 years) compared with the fibre infrastructure (approximately 20 - 40 years or even longer) the decision of today that most affects the future networking society is the choice of fibre topology.

A fibre P2P topology provides each end customer with an individual unshared fibre up to the MPoP (Figure 1). It allows deploying any active technology that operates on indi-

⁶ Adequate cost of capital are already included in the cost.

⁷ The dynamic analysis is not presented in this paper. Regarding this we refer to the study Hoernig et al. (2010).

vidual fibres. The most familiar one today may be the Ethernet switch technology which terminates the customer lines with simple Router CPEs at the customer and a switch at the central site. P2P fibre allows to unbundle the single fibre at the MPoP location. Furthermore, it allows to transmit customer individual bandwidth and protocols over each single fibre and over different distances, thus offering very high flexibility and openness also for future bandwidth use, only being limited by the optical constraints of the fibre.

Figure 1: General network topology

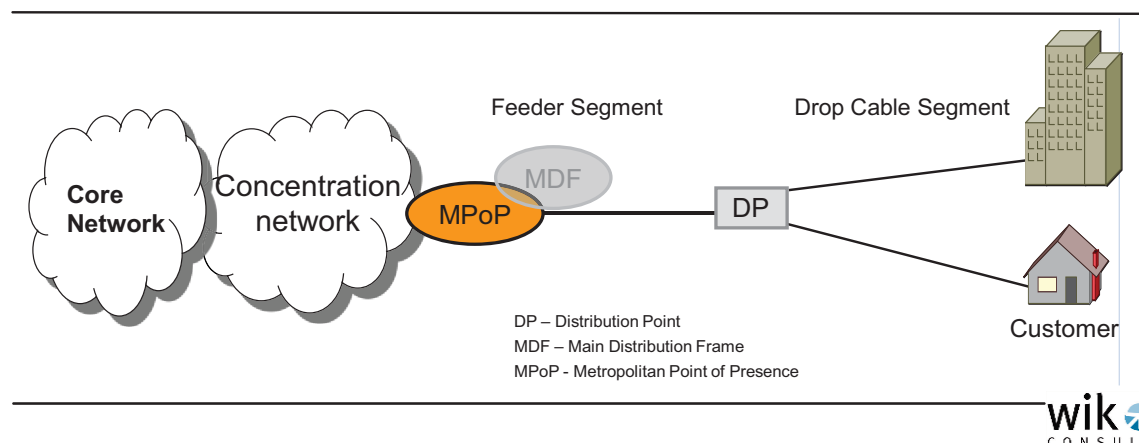

Fibre PMP topologies concentrate many drop fibres from end customers onto one single feeder fibre by a passive optical splitter, which may be located close to the end customer buildings at a Distribution Point (DP, Figure 1). An advantage of this topology is the lower number of fibres used in the feeder cable segment. This holds advantages when ducts with spare capacity already exist and can host the additional few fibres, but not the thicker feeder cables of a P2P topology. Fibre PMP may only be physically unbundled at the splitter locations closest to the end customer, which makes this access option in most relevant cases economically unattractive respectively unprofitable⁸.

This fibre topology requires a central access control system administrating the sending rights of each end user, thus avoiding signal/transmission distortion. GPON systems fulfil this task with the OLT (optical line terminator) at the central site, interacting with dedicated ONTs (optical network terminators) at the customer premises. But the fibre use is limited to the options a GPON systems offers, so today it is limited in bandwidth to 2.5 Gbps down- and 1.25 Gbps upstream, shared by all users of the OLT⁹. Future standards will enhance the maximum bandwidth by a factor of four and double the customers per splitter. The OLTs communicate with the concentration network nodes over standard Ethernet interfaces, thus also allowing Ethernet bitstream at the MPOP locations.

One option to overcome the PMP fibre limitations to bitstream-only wholesale is to combine a fibre P2P topology with central splitters in the MPoP and GPON systems. This allows to profit from the GPON advantages of active interface reduction through the optical splitters and OLTs instead of the per customer interfaces of the Ethernet

⁸ See Elixmann et al. (2008).

⁹ With 64 users at a splitter the average bandwidth per user is 40 Mbps downstream, a relative high value compared to DSL technology.

solution. This approach also allows to unbundle the end customer fibre at the MPoP location and opens all options of flexibility and future use inherent in P2P fibre topology as described already above. Compared to the PMP GPON deployment this approach requires a higher number of feeder fibres, bigger ODFs¹⁰ at the MPoP and additional space for the central splitters which replace the decentral splitters at the DPs.

The recent development of WDM technology also allows to consider different WDM PON scenarios working on PMP fibres. For our study we have chosen one where each customer is served by a dedicated colour offering a maximum bandwidth of 1 Gbps each. Up to 1000 customers may be concentrated by splitters onto one OLT. The maximum distance for the customer access line here increases from 20 km (GPON) to approximately 100 km, allowing to close many of the existing MDFs/MPoPs and substituting (bypassing) the concentration network. The single colours of such a WDM PON architecture may be unbundled at the WDM PON OLT site at the core layer node locations.

In total we consider 5 architectural scenarios, each paired with the highest possible wholesale option of the ladder of investment we believe to be relevant (respectively profitable with a recognizable coverage) (Table 2).

Table 2: The architecture scenarios considered

Scenario	Incumbent	Competitor (Entrant)
1	Ethernet P2P	Fibre LLU at MPoP
2	GPON over P2P	Fibre LLU at MPoP
3 a	GPON over PMP	Bitstream access at Core Nodes
3 b	GPON over PMP	Bitstream access at the MPoP
4	WDM PON	WDM Unbundling at Core Nodes

All competitor scenarios are modelled with a collocated Ethernet switch of the access seeker at the MPoP site relevant to the scenario (each MPoP or core node locations only).

Our basic modeling relies upon an engineering bottom-up cost modeling approach. This means that we model the total cost of the services considered under efficient conditions, taking into account the cost of all network elements needed to produce these services in the specific architecture deployed. This approach is coherent with an LRIC approach as applied in regulatory economics. In the static model presented here we compare the cost of a specific NGA deployment in a future steady state, in which the roll-out is completed and the FTTH network has (fully) substituted the copper access network.¹¹

¹⁰ Optical Distribution Frame.

¹¹ The different NGA architectures have a different time pattern of the investment regarding certain network elements. The steady state analysis is not able to cover this aspect. In Hoernig et al. (2010) we have therefore also developed a dynamic approach which takes into consideration a ramp-up period to deploy the FTTH network. Besides a network deployment period this approach also takes into consideration that demand will be growing over time to reach the target level of a 70% take-up. The model takes a 20 year perspective and therefore also takes replacement investment of the electronic equipment into consideration.

The access network is modeled in detail in a bottom-up approach. The cost model follows a Greenfield approach for all network elements.¹² Concentration and core network costs are approximated by a cost function consisting of fixed and variable costs. Besides scaling these cost functions they are the same for the incumbent and the entrant. For simplicity the core and concentration network is also assumed to be the same for all access architectures considered.

Wholesale prices of the various access models are based on the LRIC of the network elements of the incumbent. They are calculated at a take-up rate of 70% of the FTTH network.

Figure 2: Scenario P2P with fibre LLU

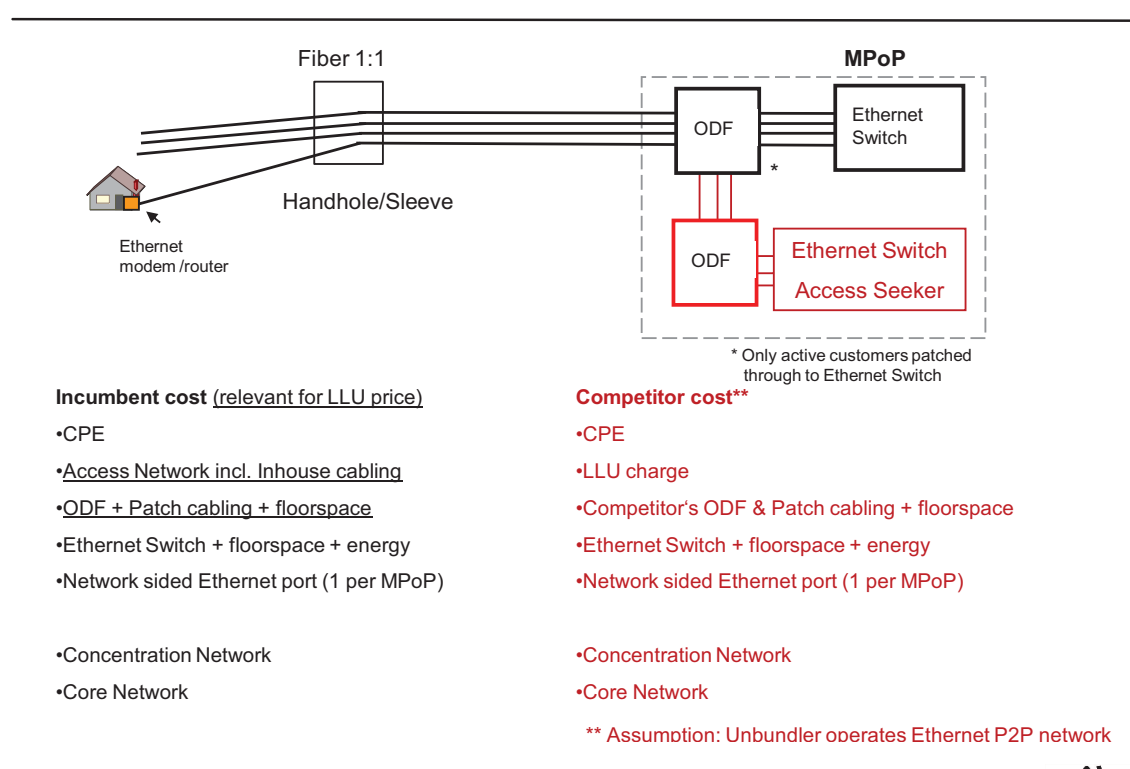

Figure 2 describes for the P2P and fibre LLU scenario which cost elements are considered for the incumbent and the unbundling-based competitor. Figure 2 also shows which elements of the incumbent's network are used to calculate the wholesale charge for fibre LLU (underscored cost positions). The elements and costs of the access network of the competitor are shown in red. In the same way the incumbent's and the competitor's costs are calculated for the other scenarios.

¹² In reality there often is available infrastructure from legacy networks which may be reused to generate investment savings. This possibility could have an impact on the investment decision. For results on such a "Brownfield" approach see Hoernig et al. (2010).

4 Major model assumptions

4.1 Euroland as reference country

For the purpose of this study we did not analyse a concrete country but chose typical European settlement structures of different countries and combined them to a hypothetical country of approximately 22 million households, which we clustered into 8 areas and called "Euroland" (Table 3).

Table 3: Key parameters of Euroland

Geotype	Cluster ID	Potential customers per km ²	Total potential customers per cluster	Share of total customers	Number of MDF	Potential customers per MDF
Dense urban	1	4,000	1,763,916	8%	69	25,564
Urban	2	1,600	2,163,672	10%	168	12,879
Less Urban	3	800	2,646,000	12%	252	10,500
Dense Suburban	4	470	2,062,480	9%	280	7,366
Suburban	5	280	2,460,360	11%	303	8,120
Less Suburban	6	150	2,989,056	14%	417	7,168
Dense Rural	7	60	4,331,208	20%	1,421	3,048
Rural	8	< 60	3,448,368	16%	2,488	1,386
			21,865,060	100%	5,398	

The degree of aerial cabling in the feeder cable segment has a relevant influence on the deployment cost. For Euroland we assumed an increasing share of aerial cabling for the less dense areas of up to 60%, so staying in between Germany (appr. 15%) and Portugal (appr. 95%) in the rural cluster.

4.2 Major assumptions on capex and opex

The cost model annualizes the investment positions derived in a bottom-up manner by multiplying them with the corresponding capital cost factor. This factor is specified according to the tilted annuity formula which takes into account the weighted average cost of capital (WACC) as relevant interest rate (10% was used), the economic lifetime and the average relative price change that is to be expected over the considered time period.

Economic lifetimes are considered separately for all investment components required directly or indirectly for the network deployment (20 years passive infrastructure, 7 years active network components, 5 years CPE).

In addition, the model considers costs resulting from operating the network and carrying out regular maintenance works (OPEX). In general, these costs are calculated as a mark-up which is applied to the direct and indirect investment positions, distinguishing between passive (0.5% mark-up) and active equipment (8% mark-up). The model determines the cost of energy and floorspace rental in a bottom-up manner.

A “retail cost” of 5 € per subscriber per month was assumed. These costs cover customer acquisition, sales and marketing, customer care and billing. We believe this to be at the lower end of such costs at least if compared with today’s market level. Finally, a common cost mark-up of 10% is applied to the sum of operational and capital expenses.

4.3 Wholesale cost and prices

Wholesale prices for the competitor’s business case have been determined as monthly cost per line based on the long-run incremental cost (LRIC) of the network elements of the incumbent which are used for wholesale access, i.e. they directly base on the cost determined for the incumbent. Since a significant part of costs is fix, the total cost per customer strongly depends on the number of customers on the incumbent’s network. Wholesale prices have been determined under the assumption that the incumbent’s network operates at a 70% take-up. This rate corresponds to the expected steady-state market share of the FTTH network against the competition of mobile and cable networks. This also means that these are the lowest possible wholesale prices under the LRIC assumptions. Depending on the scenario, they include active equipment in the MPoP (e.g. scenario GPON with bitstream access at MPoP) or even transport through the incumbent’s concentration network (e.g. scenario GPON with bitstream access at core layer). The cost of the optical inhouse cabling is also part of the wholesale charge. All initial analysis is cluster-specific, so the wholesale price in Cluster 1 is independent from the wholesale price in other clusters.

5 Results

5.1 Coverage of the different architectures

In the static model presented here we compare the cost of a specific NGA deployment in a future steady state, in which the roll-out is completed and the FTTH network has (fully) substituted the copper access network. By increasing the market share and comparing the resulting cost per customer with an assumed average revenue per customer (ARPU) we determine the point, where, if at all, the revenue equals the cost. This is the “critical market share” necessary to make the NGA business profitable and hence it determines the viability range of a network operator.

The critical market share may not exceed a dedicated percentage of the potential subscriber base. In the telecommunications market all fixed network operators together will never achieve 100% market share since there are always potential subscribers who are not willing to use a fixed NGA network, but instead favor the use of a mobile network only, the use of a cable-TV network or even do not use telecommunications access at all. Thus, we believe the maximum achievable market share of an FTTH network of all potential subscribers is in the range of 70%. To assess this level of penetration it has to be considered that it is a steady state level where the FTTH network is the only fixed-line infrastructure and the copper network has been switched off. Today, the market share of the (copper-based) fixed line network exceeds the level of 70% in most EU countries.

Since we assume that the fixed network can reach a market share of up to 70% of the total potentially addressable market (access lines), an incumbent operator can profitably cover a significant part of Euroland with FTTH (about 50% of the population could be covered with P2P or WDM PON, about 64% could be covered with GPON over P2P and GPON). Table 4 describes the results of all architectures, already combined with the results of the Brownfield considerations, which we introduce later. These results are derived for a ARPU of 44 € per user and month.

Table 4: Incumbent critical market shares (Greenfield vs. Brownfield)

Cluster ID	P2P - Greenfield (Scenario 1)	P2P - Brownfield	GPON over P2P - Greenfield (Scenario 2)	GPON over P2P - Brownfield	GPON - Greenfield (Scenario 3 a/b)	GPON - Brownfield	WDM PON - Greenfield (Scenario 4)	WDM PON - Brownfield
1	29%	25%	26%	23%	26%	23%	25%	22%
2	41%	34%	38%	32%	38%	31%	39%	31%
3	53%	45%	49%	41%	48%	40%	50%	41%
4	52%	45%	47%	41%	47%	40%	49%	41%
5	67%	60%	61%	55%	60%	52%	63%	54%
6	76%	68%	70%	63%	69%	59%	72%	62%
7	> 100%	> 100%	> 100%	95%	98%	86%	> 100%	89%
8	> 100%	> 100%	> 100%	> 100%	> 100%	> 100%	> 100%	> 100%

Figure 3 illustrates how the critical market shares are derived from the cost curves of the incumbent and the competitor in a particular cluster and scenario.

Figure 3: P2P Cost curves of incumbent and competitors (Cluster 4)

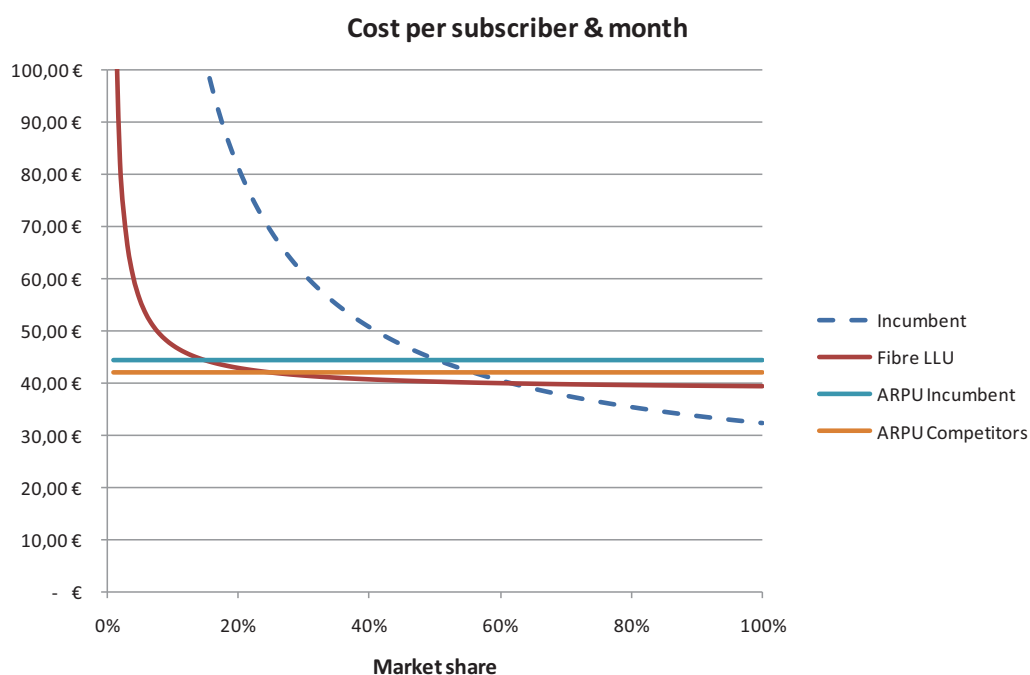

Theoretically, a FTTH infrastructure can be replicated by a second investor only in the Dense Urban Cluster 1 or for about 8% of the population. In all other viable areas the FTTH investor needs a critical market share of close to or above 50% to become profitable.

Competition cannot follow the incumbent in all areas of the FTTH roll-out. Independent of the network architecture and the access scenario considered, the viability of any competitive model ends at least one cluster less than the viability of the incumbent's roll-out (Table 5). The critical market shares of the different scenarios indicate that in all architectures and competition scenarios potentially several competitors could survive in the market. The highest potential number of competitors may occur in the case of bitstream access and wavelength unbundling at the core (Scenarios 3a and 4).

Table 5: Competitors critical market shares (Greenfield vs. Brownfield)

Cluster ID	LLU - Greenfield (Scenario 1/2)	LLU - Brownfield	Bitstream Core - Greenfield (Scenario 3a)	Bitstream Core - Brownfield	Bitstream MPoP - Greenfield (Scenario 3b)	Bitstream MPoP - Brownfield	WDM unbundling - Greenfield (Scenario 4)	WDM unbundling - Brownfield
1	9%	8%	4%	3%	6%	6%	4%	4%
2	10%	8%	3%	2%	5%	4%	3%	3%
3	24%	12%	4%	3%	8%	6%	6%	4%
4	25%	15%	5%	4%	10%	7%	6%	4%
5	> 100%	> 100%	16%	6%	28%	11%	92%	8%
6	> 100%	> 100%	> 100%	12%	> 100%	22%	> 100%	32%
7	> 100%	> 100%	> 100%	> 100%	> 100%	> 100%	> 100%	> 100%
8	> 100%	> 100%	> 100%	> 100%	> 100%	> 100%	> 100%	> 100%

As expected, business models on the basis of unbundling require (significantly) higher critical market shares than business models based on bitstream access. The unbundling model requires already a critical market share of 24% in Cluster 3, while bitstream access is viable at 4% to 8% critical market share in the same cluster.

5.2 Investment and cost differences and their significance

In the relevant clusters 1-6 the cost comparison of our four architectures in the steady state modelling has shown the following results: GPON is the cheapest technology, followed by GPON over P2P, WDM PON and P2P. With the exception of Cluster 1 where WDM PON and GPON over P2P switch ranks, this is consistent over the relevant clusters (Table 6).

Table 6: Total cost per customer per month at 70% take-up (in €)

Cluster	P2P	GPON over P2P	GPON	WDM PON
1	29.85	27.67	26.55	27.49
2	34.17	32.00	31.18	32.42
3	38.19	36.03	35.37	36.62
4	37.73	35.58	35.04	36.33
5	43.02	40.87	40.14	41.50
6	46.21	44.07	43.50	44.83

Single cost items like energy and floor space exhibit significant differences among architectures. P2P causes nearly double as much energy cost at the MPoP as GPON and nearly 6 times higher energy costs than WDM PON. P2P has more than 2.5 times higher floor space costs than GPON and even nearly 90 times more than WDM PON. These huge differences, however, only have a very limited impact on the overall cost performance of architectures because the cost share of each of these factors is not more than 1%.¹³

The other major difference between P2P and PMP fibre topologies is the number of fibres in the feeder cable segment. In the case of the P2P architectures, which are in this respect most fibre consuming, the cost of the feeder segment contribute with 4% to the total cost, thus the saving contribution of a PMP feeder segment can only be of relative significance if this architecture does not require civil engineering work (e.g use of existing ducts), while P2P does.

This section analyses investment and its breakdown into access network and MPoP related elements. Figure 4 shows investment values for each architecture and cluster at 70% take-up per subscriber. It is evident that a GPON roll-out requires less investment than all other architectures regardless of the cluster geotype. Except for the third cluster WDM PON shows the second lowest investment and the smallest difference to GPON. As expected P2P is the most investment intensive technology in all clusters.

¹³ In a consideration including CPEs the energy balance switches to P2P, since the OLTs are more power consuming than Ethernet CPEs.

Figure 4: Total investment per subscriber and cluster at 70% market share (excl. invest in IPTV equipment)

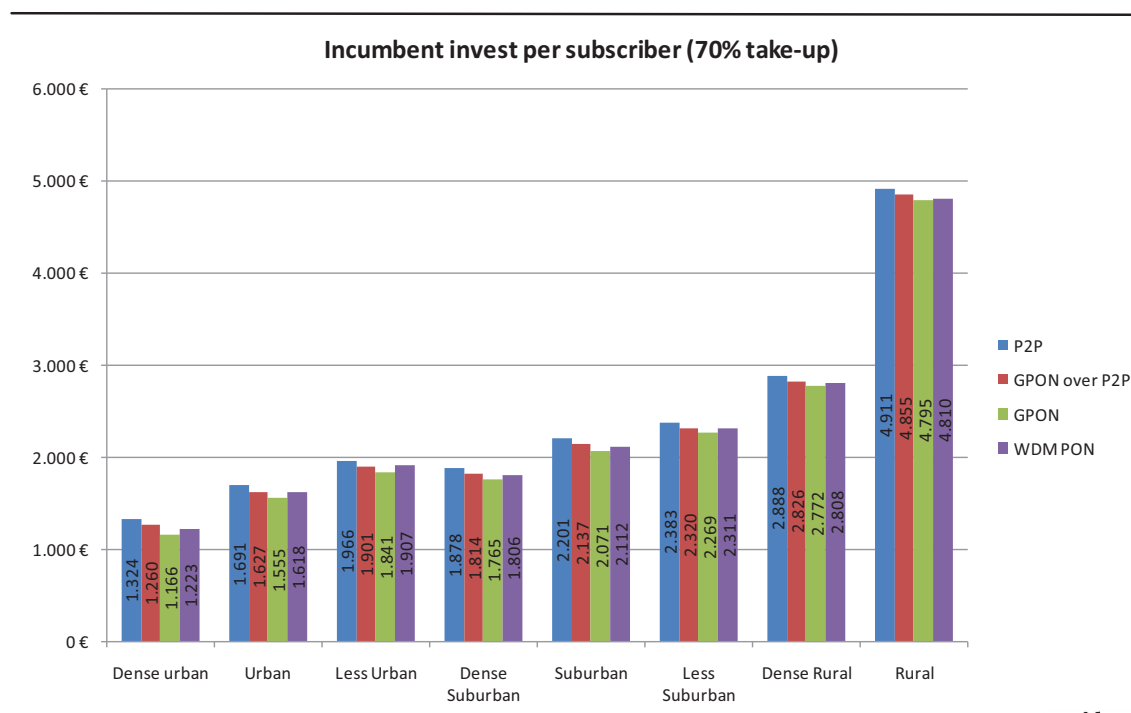

Despite of the differences in the implementation of the four technologies, the overall investment deltas between the architectures are relatively small. This follows mainly from the fact that the network elements which are most investment intensive (inhouse cabling and drop cable) and which are identical for all alternatives account for around 75% of total investment, while the feeder segment in which investment savings of e.g. GPON vs. P2P can reach over 100% in the dense areas, has a share of total investment of less than 10% in dense clusters. The difference in feeder investment is not as large as one would initially foresee. The reason is that in this Greenfield deployment civil works have to be undertaken in all cases anyway. Only where the higher fibre count of P2P exceeds the capacity of the standard trench and a wider trench is required does this actually lead to additional civil works cost for P2P. In Euroland this is only the case in the densest Cluster 1. In all other clusters the standard trench has enough capacity to host all required cables. Therefore, from Cluster 2 on the higher fibre count of P2P only leads to additional invest in cables but not to invest in trenches and duct infrastructure. The lower the fibre count becomes as the clusters become less dense, the less pronounced are the differences between P2P and GPON.¹⁴ Therefore, the overall investment deltas between P2P and GPON remain moderate and range from 14% (Cluster 1) to 2% (Cluster 8).

¹⁴ A Brownfield sensitivity in Section 5.3 will show how strong the differences between P2P and PON architectures become when taking the feeder fibre count into account for selecting usable duct infrastructure.

In the previous section the focus was on the analysis of the *investment* required for the roll-out of a certain technology. We now analyze the *cost composition* of the incumbent and competitors as we consider the annualized cost of NGA investment and direct cost which include floorspace rental, energy, concentration and core network as well as retail costs.

Figure 5 and Figure 6 show exemplary for Cluster 3 cost shares of the incumbent's deployment at maximum penetration (70%) for different FTTH architectures. In line with the investment values analysed above, the drop cable segment exhibits the highest cost share regardless of the technology deployed (between 39% and 42%). The second largest cost component is the inhouse cabling (14%-16%), except for WDM PON case where the cost for CPE dominates with 16% cost share due to the higher equipment price assumed. Retail cost ranges between 13% and 15% along the different architectures, CPE cost – between 9% and 11% (except for WDM PON). As expected, the costs of Ethernet ports have a significant impact only in case of P2P where it generates 9% of the total cost. Contrary to this, the PON architectures' cost of active equipment (OLTs and PON Ethernet ports) in the MPoP account for a maximum of 2% of the total cost.

Figure 5: P2P Cost structure of incumbent at 70% market share (Cluster 3)

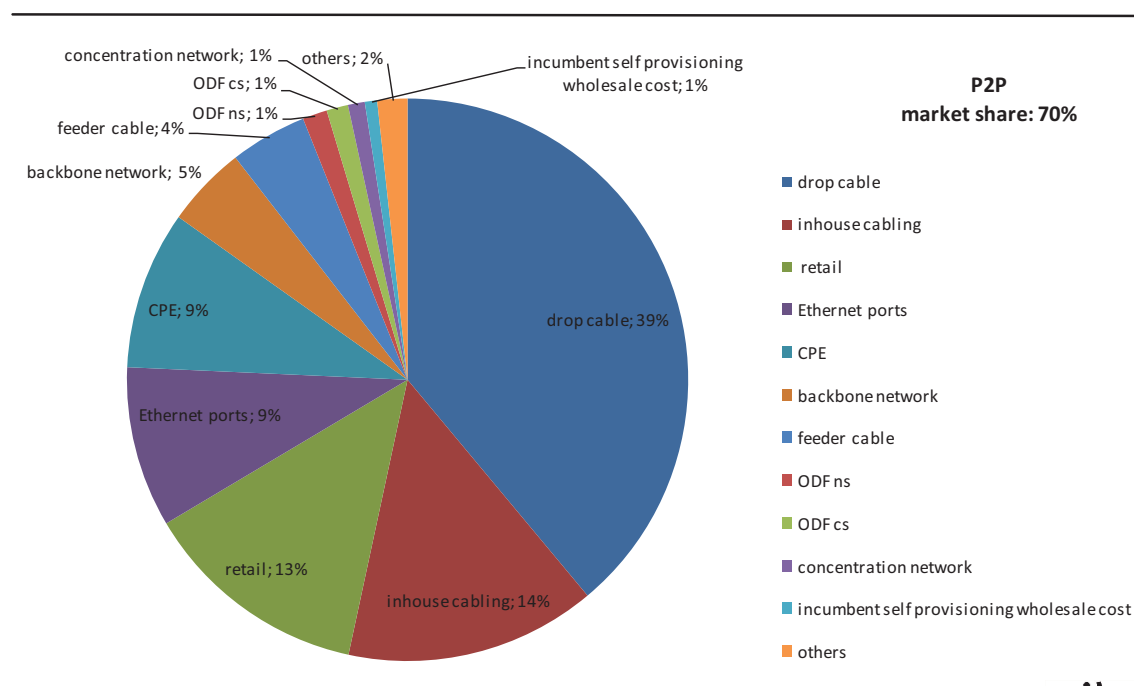
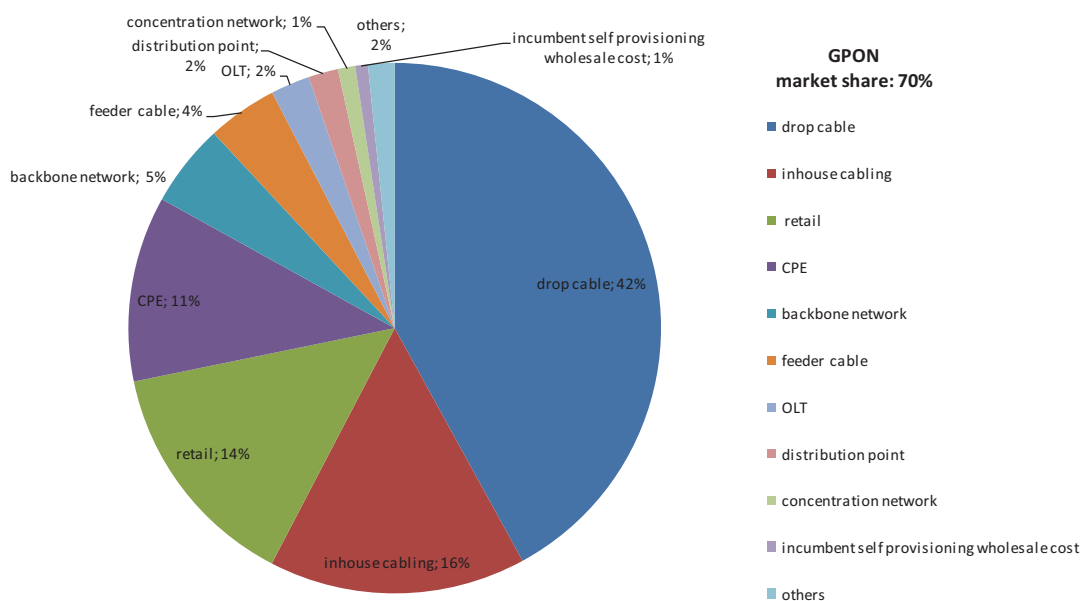

Figure 6: GPON Cost structure of incumbent at 70% market share (Cluster 3)



The next two figures depict the cost composition of a competitor for two of the five wholesale scenarios and at 20% market share (examples shown for Cluster 3). One can see that the cost structure of a competitor in a FTTH network is strongly dominated by the wholesale price. In the bitstream scenario the cost share of the wholesale price amounts to 65% on average. The cost share of the wholesale provision will be reduced to 57% in case of fibre unbundling.

Figure 7: Cost structure of fibre unbundler at 20% market share (Cluster 3)

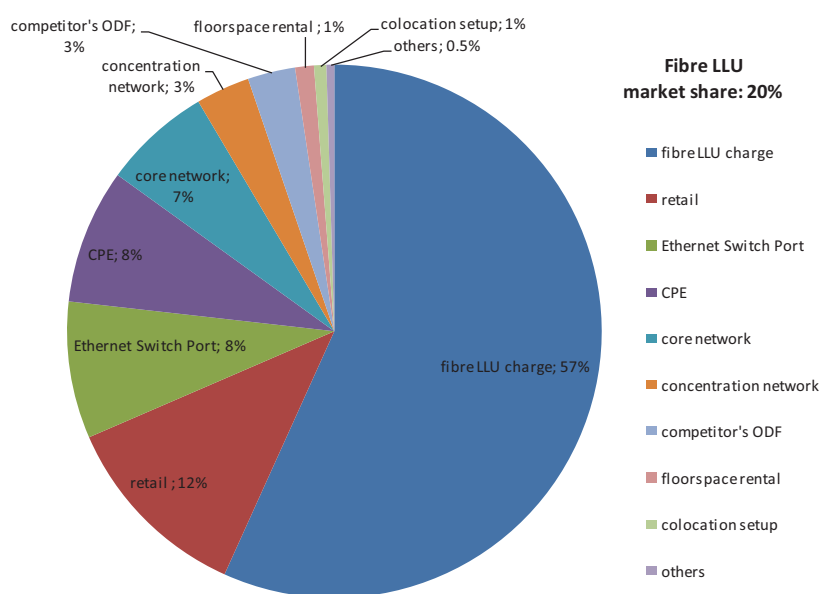
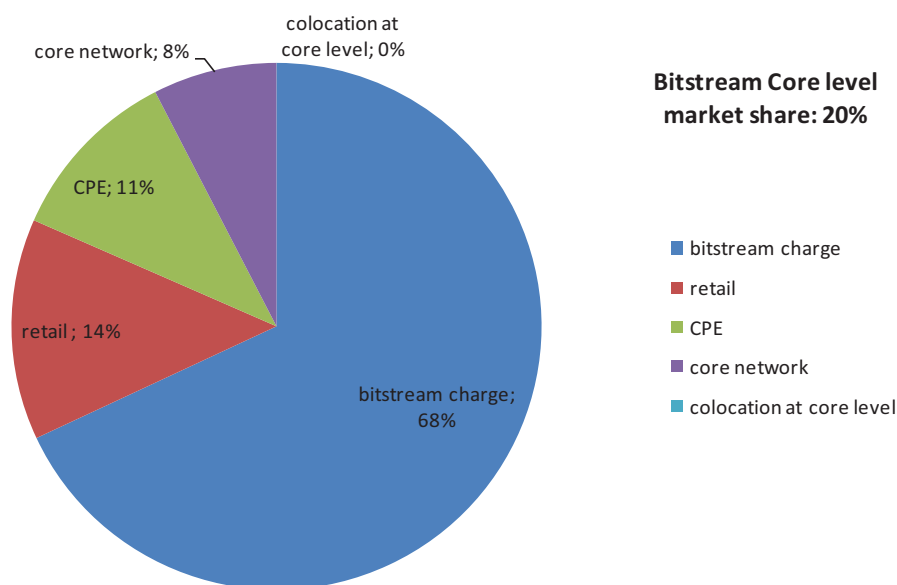

Figure 8: Cost structure of a bitstream core access seeker (GPON) at 20% market share (Cluster 3)



As explained before, wholesale prices for the competitor's business case have been determined based on the LRIC incurred for the incumbent at a 70% take-up which is the maximum penetration rate we assume for the incumbent's network. Depending on the scenario they can - in addition to the cost of the access network (which includes the optical inhouse cabling cost) – include cost for active equipment in the MPoP or cost for transport in the concentration/backhaul network.

Figure 9 provides an overview of the resulting wholesale prices. In line with the components included in the wholesale charge, bitstream access at the core level is more expensive than access at the MPoP or WDM unbundling along all clusters. Note that a comparison between the fibre unbundling charge and the wholesale prices of the other competition scenarios is not directly possible, since they are based on different access technologies according to the scenario definition. Accordingly the most valid interpretation is the comparison of the two GPON bitstream scenarios. The wholesale price increase for the bitstream access at the core level is relatively small. The reason is that the concentration network transport component of the access charge at the core level is based upon a 70% network load which results in very low transport cost per customer, considering that the dominant part of the concentration network costs is fix.

Furthermore, it is interesting to note that in some clusters the WDM PON access charge is below the GPON access charge level, but as we have seen GPON always leads in terms of overall cost and thus critical market shares. The reason is primarily the CPE price that is borne by every subscriber. We have run a sensitivity on the WDM PON CPE price and other parameters in Hoernig et al. (2010) which we refer to.

Figure 9: Wholesale prices

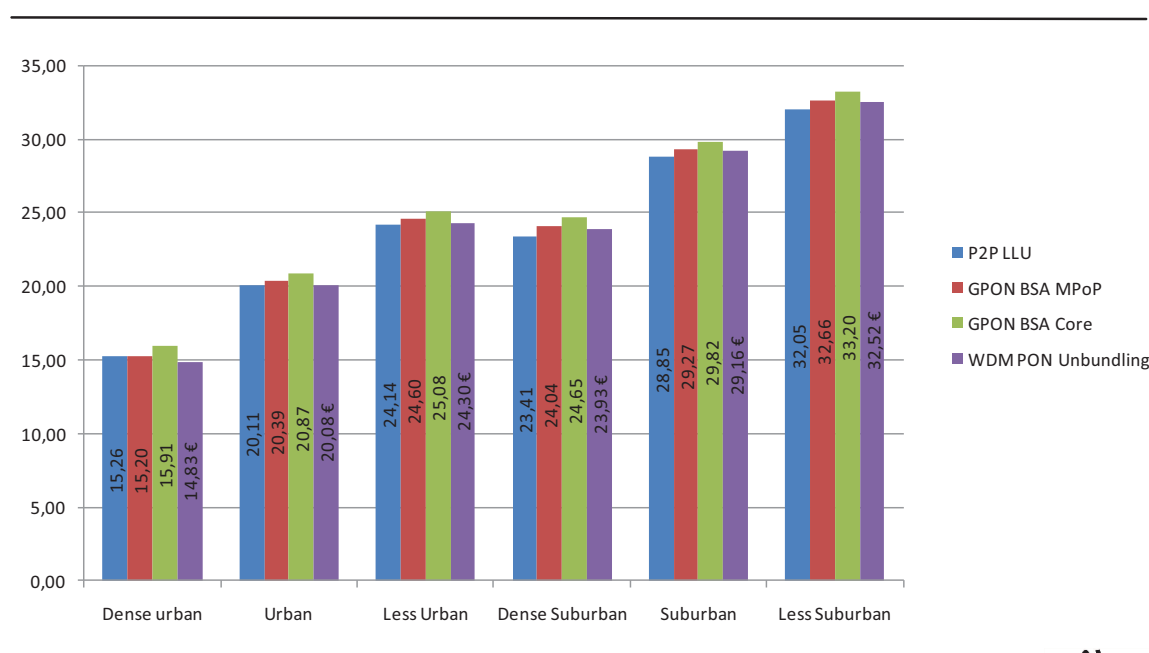

5.3 Brownfield sensitivity

Lower investment requirements in a Brownfield approach enable incumbents to increase the profitable coverage with P2P and WDM PON up to the Less Suburban Cluster 6 (Table 4). Utilizing existing duct infrastructure benefits the two PMP architectures GPON and WDM PON most, because they have fewer fibres in the feeder and backhaul segments and hence a higher chance of avoiding civil works. The investment savings by segment are as follows:

- The effective reduction in the drop segment ranges from 7% to 20% depending on the cluster, and is the same for all architectures, since the architectures do not differ in this segment.
- In the feeder segment, the savings for P2P are around 7% and for GPON around 40%.
- The savings in the backhaul segment amount to around 40% for WDM PON.

The segment specific savings in investment translate to overall cost savings of 5% (Cluster 1) to 11% (Cluster 8) for the WDM PON architecture which benefits most. Cost savings for GPON are higher than for P2P but lower than for WDM PON, and range from 5% (Cluster 1) to 9% (Cluster 4). The lowest cost savings occur with P2P from 4% (Cluster 1) to 7% (Cluster 3).

If the wholesale prices also reflect the investment savings of the incumbent (Brownfield case) costs the critical market shares of competitors decrease in all competition scenarios (not shown in a table here). In addition, they can also expand competitive coverage by one cluster with the exception of the LLU scenarios.

6 Final Remarks

This article can only highlight some of the most relevant results of the cost modelling. As a contribution to the discussion of P2P vs. GPON we described a GPON over P2P architecture which benefits from both worlds, by supporting future proof P2P fibre topologies and taking advantage from the GPON interface reduction, also enabling fibre LLU and thus keeping the lowest base of infrastructure competition one may imagine. Ethernet P2P architectures offer the highest degree of flexibility and future proof.

WDM PON as an upcoming technology may be the future upgrade path of GPON and PMP fibre plants, if the supplier world can agree on standards allowing to use harmonized optical spectrums.

There are differences in the cost of the different architectures, but in a total cost perspective they are not as big as they are if being compared in a microscopic view, e.g. focusing only on MPoP energy and space. If compared as net present values of a 20 year period dynamic consideration they become even smaller.

While this study deals with the characteristic and cost differences of the FTTH architectures the final answer of what will be the best architecture will be given by the market.

References

- Elixmann, D., Ilic, D., Neumann, K.-H., & Plückebaum, T. (2008). *The Economics of Next Generation Access*. Study for the European Competitive Telecommunications Association ECTA. Available at:
http://www.wik.org/uploads/media/ECTA_NGA_masterfile_2008_09_15_V1.pdf
- European Commission (2010). Commission Recommendation on Regulated Access to Next Generation Access Networks (NGA). Brussels, 20/09/2010 C(2010) 6223.
- Hoernig, S., Jay, S., Neumann, K.-H., Peitz, M., Plückebaum, T., & Vogelsang, I. (2010). *Architectures and Competitive Models in Fibre Networks*. Available at: www.wik.org and www.vodafone.com/eu.
- Ilic, D., Neumann, K.-H., & Plückebaum, T. (2009a). *The Economics of Next Generation Access – Addendum*. Study for the European Competitive Telecommunications Association (ECTA). Available at:
http://www.wik.org/uploads/media/Ecta_Study_Addendum_2009.pdf
- Ilic, D., Neumann, K.-H., & Plückebaum, T. (2009b). *Szenarien einer nationalen Glasfaserausbaustrategie in der Schweiz*. Study on behalf of Bundesamt für Kommunikation (BAKOM). Available at:
http://www.wik.org/uploads/media/Glasfaserausbaustrategie_Schweiz_2009_12_11.pdf