

Mölleryd, Bengt G.

Conference Paper

Network sharing and co-investments in NGN as a way to fulfill the goal with the digital agenda

22nd European Regional Conference of the International Telecommunications Society (ITS): "Innovative ICT Applications - Emerging Regulatory, Economic and Policy Issues", Budapest, Hungary, 18th-21st September, 2011

Provided in Cooperation with:

International Telecommunications Society (ITS)

Suggested Citation: Mölleryd, Bengt G. (2011) : Network sharing and co-investments in NGN as a way to fulfill the goal with the digital agenda, 22nd European Regional Conference of the International Telecommunications Society (ITS): "Innovative ICT Applications - Emerging Regulatory, Economic and Policy Issues", Budapest, Hungary, 18th-21st September, 2011, International Telecommunications Society (ITS), Calgary

This Version is available at:

<https://hdl.handle.net/10419/52153>

Standard-Nutzungsbedingungen:

Die Dokumente auf EconStor dürfen zu eigenen wissenschaftlichen Zwecken und zum Privatgebrauch gespeichert und kopiert werden.

Sie dürfen die Dokumente nicht für öffentliche oder kommerzielle Zwecke vervielfältigen, öffentlich ausstellen, öffentlich zugänglich machen, vertreiben oder anderweitig nutzen.

Sofern die Verfasser die Dokumente unter Open-Content-Lizenzen (insbesondere CC-Lizenzen) zur Verfügung gestellt haben sollten, gelten abweichend von diesen Nutzungsbedingungen die in der dort genannten Lizenz gewährten Nutzungsrechte.

Terms of use:

Documents in EconStor may be saved and copied for your personal and scholarly purposes.

You are not to copy documents for public or commercial purposes, to exhibit the documents publicly, to make them publicly available on the internet, or to distribute or otherwise use the documents in public.

If the documents have been made available under an Open Content Licence (especially Creative Commons Licences), you may exercise further usage rights as specified in the indicated licence.

Bengt G Mölleryd

Network sharing and Co-investments in NGN as a way to fulfill the goal with the Digital Agenda

Abstract

The European Commission and most European countries have set ambitious broadband targets aiming to provide up to 100 Mbits to the end-customers. On back of a declining fixed market, negative growth for operators and a slow take up of fiber while maintaining high capex levels operators will ultimately be forced to take innovative approaches towards broadband investments. This paper relates co-investments in NGA to the regulatory framework in the form of SMP regulation and competition law making the conclusion that the current regulatory framework is sufficient to avoid a distorted competition on the market. A number of examples of ongoing co-investment projects are presented underscoring a growing interest for co-investments and indicating that co-investments, at this point, are not hampering competition. The mobile industry has gradually moved towards network sharing indicating a tendency towards vertical disintegration, although so far only a tendency. The ongoing structural separation of Telecom New Zealand with the establishment of a separate network and wholesale company is an indication of this development. The paper concludes by stating that regulators have appropriate tools to handle potential competition issues regarding co-investments, that co-investments could be a vehicle for reaching the broadband targets, that there are efficiency gains for operators to make by lower Opex and capex, and ultimately giving network companies the means to utilize their balance sheet in order to increase the return.

Keywords: NGA, co-investment, SMP regulation, horizontal and vertical agreements, capex, network sharing, financial gearing

Bengt G Mölleryd¹

PTS, Swedish Post and Telecom Agency, P.O. Box 5398, SE-102 49 Stockholm, Sweden
Email: bengt.molleryd@pts.se

¹ Bengt G Mölleryd is also a guest researcher at Wireless@KTH, Royal Institute of Technology, Stockholm, Sweden

1 Introduction

1.1 Ambitious broadband targets require new approaches

The European Commission has launched a Digital Agenda with the target to provide “fast” broadband with speeds above 30 Mbps for all Europeans by 2020, and “ultra-fast” broadband with speeds above 100 Mbps for 50 % of all European households by 2020.² Given the limited extent of fiber in access networks throughout Europe in combination with a slow take up it is a major undertaking to reach the long term broadband targets. The European operators are facing a deteriorating fixed line business and declining sales which put pressure on cash flow forcing operators to explore new ways to finance and deploy the Next Generation Access Networks. This is illustrated by continued high levels of capex-to-sales with declining sales for European incumbents.

Figure 1 Sales growth and capex/sales 2005-2010 for European incumbents³ (left)

Figure 2 NGA coverage and take-up for FTTH, FTTB in Europe (right)

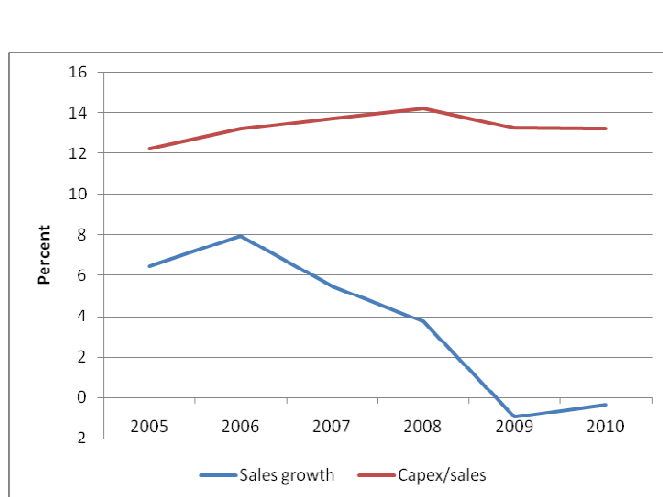

Source: Bloomberg

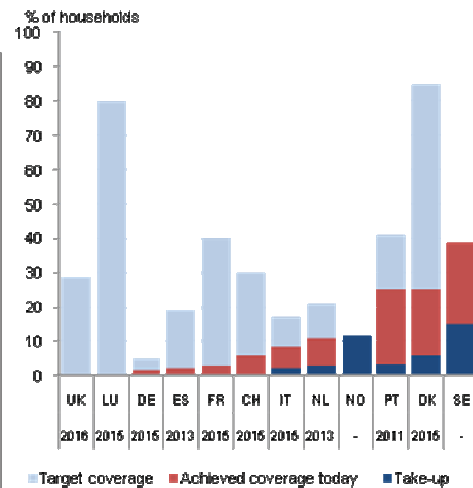

Source: Cullen International

The need to take innovative approaches towards broadband investments is underscored by the vast amount of capital required to deploy fiber networks and that the coverage is limited in Europe.⁴

Although mobile networks, through HSPA and LTE can provide cost effective mobile broadband access it is only likely to be a sufficient alternative for part of the retail market, as fiber in the access network have the potential to provide users with unlimited capacity. Unlimited capacity is an important feature as the forthcoming bandwidth requirements are forecasted to be massive.⁵

² A Digital Agenda for Europe, see link: <http://eur-lex.europa.eu/LexUriServ/LexUriServ.do?uri=COM:2010:0245:FIN:EN:PDF>

³ The calculations is based on data for the following operators: British Telecom, Deutsche Telekom, France Telecom, KPN, Swisscom, Telefonica and TeliaSonera

⁴ Capex required to deploy fiber access networks varies considerable depending upon access to the existing ducts and local conditions with a range from EUR 1000 up to EUR 3000 per connection.

⁵ See Cisco Networking Visualisation index

http://www.cisco.com/en/US/solutions/collateral/ns341/ns525/ns537/ns705/ns827/white_paper_c11-481360_ns827_Networking_Solutions_White_Paper.html

An example of an innovative approach towards network deployment and investment is network sharing, which nowadays is common among mobile operators around the world, dominated by passive network sharing of sites and towers.⁶ Network sharing enables operators, according to Friscano (2008), to reduce network operational expenditures (Opex) with up to 20 %, and even reaching cost reduction up to 33 % through active radio access sharing. The Swedish mobile operators have pursued network sharing for 3G during the last ten years resulting in 3G networks with extensive coverage, giving a head start for the 4G deployment.

A driving force behind the development of tower or network sharing companies is that it facilitates higher financial gearing compared to the regular operator business as it generates stable cash-flow with a lower operational risk. It could be illustrated by US tower companies which in average has a debt ratio of 6.4 times net debt⁷ in relation to earnings before interest, tax, depreciation and amortization (EBITDA) compared to 1.3, 1.8 and 2.0 for European mobile operators, European integrated operators and US operators respectively.

Figure 3 Average ratio of net debt/EBITDA 2006-2010⁸

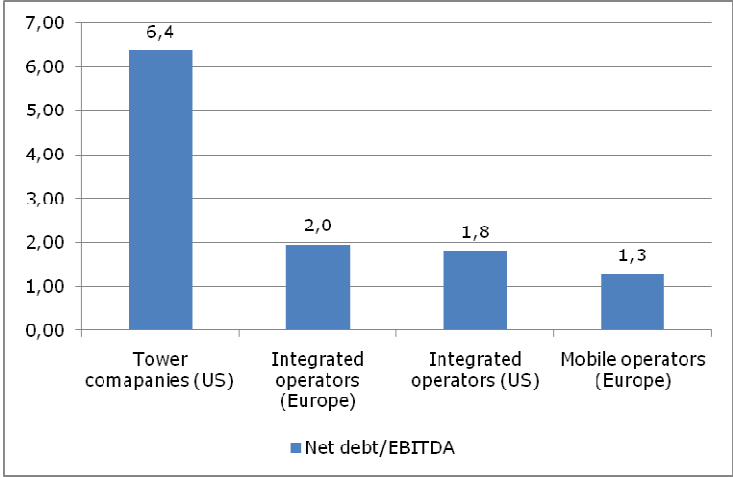

Source: Bloomberg

Concurrently, co-investments in fiber networks are receiving more attention throughout Europe, with a number of co-investments projects ongoing (see chapter 3 where a number of examples are presented). This development is supported by the European Commission which underscores that co-investments in NGA networks can reduce both costs and risks and thereby having the potential to propel a more extensive deployment of FTTH.⁹

⁶ Mobile operator collaborates extensively on passive infrastructure sharing in most markets around the world. There are listed tower companies in the US like Crown Castle, American Tower, and SBA Communications, and privately held companies in India: Bharti Infratel, Reliance Infratel, Wireless-TT Info Services and Indus Towers.

⁷ Net debt stands for long and short term interest bearing debt minus cash and cash equivalent

⁸ Included operators are Tower companies: Crown Castle, American Tower and SBA Communication, Integrated operators Europe: Belgacom, BT, Cable Wireless, Deutsche Telekom, France Telecom, KPN, Magyar Telekom, OTE, Portugal Telecom, Swisscom, TDC, Telecom Italia, Telefonica, Telekom Austria, Telekomunikacja Polska, TeliaSonera, Vivendi, Telenor and Tele2; US integrated operators: AT&T, Sprint and Verizon; Mobile operators Europe: Bouyes, Drillisch, Elisa, Mobistar, Sonacom, Tele2, Telenor and Vodafone

⁹ COMMISSION RECOMMENDATION of 20/09/2010 on regulated access to Next Generation Access Networks (NGA) {SEC(2010) 1037}

The growing interest for network sharing among mobile operators indicates a movement, although yet only a tendency, towards vertical disintegration with dedicated network operators working on the wholesale market separated to providers of end-customer services, illustrated by the emergence of a tower industry and a growing number of network sharing companies around the world.¹⁰

Infrastructure sharing on fixed networks has primarily been achieved through regulated access of the incumbents' access networks. The SMP process¹¹, which according to the European regulatory framework, gives National Regulatory Authorities tools to intervene and determine obligations for incumbents (or other operators that are designated to have SMP status) to open the access network which is a prerequisite to provide services to end customers.¹² Given that the deployment of NGA require extensive investments the incumbents are likely to play a vital role in the co-investment projects.

1.2 Research question

This paper takes its starting point in the NGA recommendation, published by the European Commission in September 2010, which underscores that co-investments could be a way to facilitate fiber deployment in the access networks. The focus on this paper is to analyze the significance of co-investments schemes of fiber in Europe.

The research question is to analyze the relationship between co-investment schemes, SMP regulation, exclusivity agreements and the impact on competition.

The paper addresses issues like how exclusivity agreements in co-investment schemes correspond to competition law and the regulatory framework in Europe. This implies that key issues will be horizontal and vertical agreements between undertaking.

Furthermore, the analysis of co-investments of fiber networks is compared with the development of network sharing on mobile networks, and exploring issues that are of significance for the development of co-investment schemes.

This paper is of an exploratory character and aim to be a contribution to the ongoing discussion of NGA deployment and examine the role that co-investment and infrastructure sharing can play in reaching long term broadband targets.

1.3 Disposition

The paper is structured as follows. The following chapter discusses the concept of co-investments, introduces a theoretical framework, with concepts such as horizontal and vertical agreements and how co-investments in NGA could be viewed through the SMP framework and Competition Law Framework. Chapter 3 presents a couple of co-investment projects for NGA in Europe, and the ongoing structural separation in New Zealand, followed by co-investments in submarine cable systems and mobile network sharing. The final chapter concludes the paper and proposes ideas for further research.

¹⁰ There are for example three network sharing companies in Sweden: 3G Infrastructure Services (owned by Telenor and HI3G), Svenska UMTS nät AB (owned by Tele2 and TeliaSonera), Net4Mobility (owned by Tele2 and Telenor), Everything Everywhere in the UK (owned by Deutsche Telekom and France Telecom).

¹¹ SMP stands for Significant Market Power and stipulates that a company has dominating position on a predefined market, see more <http://www.ictregulationtoolkit.org/en/PracticeNote.2616.html>

¹² A Albors-Llorens, The Essential Facilities Doctrine in EC Competition Law, The Cambridge Law Journal 1999, page 490

2 About co-investments

2.1 About co-investments

Co-investments in fiber access networks (FTTH) could be agreements between two or more operators, like for example an incumbent and one or several alternative operators, that want to deploy FTTH networks through a joint venture or other form of collaboration. It could be collaboration between an operator and infrastructure provider or utility, it could be in the form of a private public partnership. This implies that co-investments refer to joint ownership and control of a single network infrastructure. It is by this mean a horizontal agreement.

Co-investment agreements could, for example, relate to an agreement to share civil engineering works for joint roll-out. The co-investment could comprise agreements between companies operating at different network levels or distribution chains, so called vertical agreements.

The incentive for operators to enter co-investment and network sharing agreements are that they can result in substantial economic benefits and is a way to share risks, combine know-how and launch services faster.

Ultimately, co-investments could result in increased investments in NGA, and thereby be a movement on the investment ladder.¹³ Moreover, it can lead to effective competition given that a sufficient number of the operators are part of co-investment schemes in combination with that wholesale access are provided to third parties. The interest for co-investments for SMP operators is further underscored by the potential for National Regulatory Authorities (NRAs²) to lift or ease *ex ante* regulation according to the NGA recommendation.¹⁴ However, co-investments constitute a potential risk for competition problems such as cartel agreements, agreement to fix prices or output, or to share markets.¹⁵ The main source of competition problems that may arise from production agreements is the coordination of the parties' competitive behavior as suppliers.

2.2 Theoretical framework

The telecommunications industry has during the last twenty years gone through a fundamental development from being a monopoly on most markets to full liberalization. However, the former monopolists, the so called incumbents, have been doing quite well on the market with market shares on fixed broadband around 40% on most European markets while the emergence of alternative operators has been weaker than expected.

As part of the liberalization process the incumbents has gradually concentrated its operations. Historically operators used to manufacture all equipment and control all of the different subsystems in the telecommunications value chain, but operators has gradually divested or outsourced non-core operations and continuously slimmed their organizations during the last twenty years. Moreover, the commodization has made it unnecessary for operators to develop

¹³ Co-investment in NGAs and competitive assessment of horizontal cooperation agreements Gonçalo Machado Borges 22.10.2010

Commission Notice – Guidelines on the applicability of Article 81 of the EC Treaty to horizontal cooperation agreements (2001/C 3/02).

¹⁴ Commission staff working document, accompanying document to the Commission Recommendation on regulated access to Next Generation Access Networks (NGA), page 21 - "Certain arrangements for co-investment by several players could result in the lifting of *ex ante* regulation"

¹⁵ http://europa.eu/legislation_summaries/competition/firms/126062_en.htm

unique solutions as it is more cost efficient to use standardized products and software and all-IP networks.

This development is an all new trend. Telecom investments has traditionally been seen as very specific to a certain solution or system, labeled as asset specificity, implying that investments cannot be removed without considerable loss in value. It is labeled as sunk cost.

The fundamental idea and theoretical construct for vertical integration can be found in Coase (1937) which underscores that vertical integration decrease the costs of coordination between firms. The significance of transaction cost for vertical integration was also underscored by Williamson (1985). The underlying argument, according to Jaspers and Ende (2006), for vertical integration is that a high frequency of transactions makes it more efficient to handle it internally, that uncertainties of relationship between different parties regarding terms and conditions makes it more efficient to conduct it internally, and that the return on investments is more certain if a company controls the entire value chain. It is also driven by the assumption that the vertically integrated firm is able to capture a fair share of the benefits from the more efficient coordination and value generation, so called appropriation.

However, it could be argued that the migration towards all IP-networks facilitates a separation of different network layers, a vertical disintegration, as there are few common functions or assets between transport and service provision in NGA, as it is a flexible multi-service platform. The core competence for operators is moving towards having the ability to coordinate systems, in combination of building and developing customer base.

2.3 Horizontal agreements¹⁶

Horizontal agreements comprise collaboration between two or more - actual or potential – competitors that operate on the same level on the market. It could, for example, be a joint production of services like network capacity.

Horizontal agreements are generally viewed as potentially more harmful on competition than vertical agreements as they facilitate coordination of the companies' behavior as they produce similar or substitutable goods or services to its competitors. This could for example be fixing prices, output volumes, and other market behavior.¹⁷ Consequently, it could have a negative effect on competition in the market where the parties are operating, as well as it could affect the competitive behavior of parties in a downstream or upstream market.

However, there are potential positive effects of horizontal agreements as they could generate substantial economic benefits, like lower costs, risk sharing, and lead to more rapid launch of new services, like broadband services.

The regulatory framework underscores that agreements on specialization in the provision of services can give rise to benefits and that the positive effects could outweigh negative effects on competition. If the involved parties' market shares do not exceed 20%, it is presumed that the positive effects will outweigh the negative.¹⁸

¹⁶ Commission Regulation (EC) No 330/2010 on the application of Article 101 (3) of the EC Treaty to categories of specialization agreements horizontal,

¹⁷ European Commission, Guidelines on Vertical Restraints, 2010/c 130/01), 2 para 6

¹⁸ Commission Regulation (EC) No 2658/2000 of 29 November 2000 on the application of Article 81(3) of the Treaty to categories of specialization agreements

The evaluation of horizontal agreements consists of a trade-off between economic benefits and risks for distortion of competition. A key question is if the horizontal agreement is indispensable to achieve the positive effects, and whether these efficiencies could be achieved through less restrictive means. It is also a question if the cooperation is the only commercially justifiable way to achieve the legitimate purpose which the parties aim to achieve through the horizontal agreement.

Horizontal agreements could be compatible with the regulatory framework if they generate economic benefits such as improved productivity, lower prices or higher quality and those positive effects spill over on consumers.

The impact of horizontal agreements, like joint production of network capacity, on competition depends to a large extent on the degree of commonality of costs and how large the proportion of total cost that is involved. The higher the degree of commonality of costs the greater the likelihood for negative impact on competition as it facilitates coordination of prices and output.

Horizontal agreements which aim to restrict competition are incompatible with the regulation. The same goes for horizontal agreements where a company is dominant or becoming dominant through a horizontal agreement.

In case a restriction of competition through a horizontal agreement is a prerequisite to achieve economic benefits it could receive a favorable view. But if there are less restrictive means to achieve similar benefits the claimed efficiencies cannot be used to justify restrictions of competition.

2.4 Vertical agreements

Vertical agreements concerns agreements or concerted practices between companies at different levels of a production or distribution chain, implying that products or services for the involved parties are complementary to each other. The rationale for entering into vertical agreements is that it can enhance economic efficiency within a chain of production through improved coordination reducing transaction and distribution costs.

Although vertical agreements could raise concern as they restrict competition they are generally regarded as less harmful on competition than horizontal agreements.¹⁹ The key factors in evaluating vertical agreements are market shares and the intensity of competition from other suppliers.

Vertical agreements entered into by companies with market shares below 30% are not likely to raise any concern from the regulators provided that the agreements do not comprise severe restrictions of competition. It is presumed that the beneficial effects of such agreements will outweigh the negative effects.²⁰ In case the involved companies have market shares above 30% it is not certain that vertical agreements would generate sufficient advantages to offset the negative effects on competition. Agreements that restrict or distort competition are incompatible with the regulatory framework if it cannot outweigh anti-competitive effects. For most vertical restraints, competition concerns only arise if there is insufficient competition at one or more levels of the market.

¹⁹ http://www.kkv.se/upload/Filer/Trycksaker/Rapporter/Pros&Cons/rap_pros_and_cons_vertical_restraints.pdf

²⁰ COMMISSION REGULATION (EC) No 2790/1999 of 22 December 1999 on the application of Article 81(3) of the Treaty to categories of vertical agreements and concerted practices

Hub and spoke agreements are vertical relationships which, according to Bardell, could be transformed into horizontal cartels. The basis is that operators or companies must determine their policies and actions independently. But if, for example, companies share information about future action, without a formalized agreement, it facilitates a co-ordination between players and therefore constitutes a co-ordination of their action. This constitutes a risk for distortion of competition as an exchange of information could remove uncertainties concerning a company's planned actions.²¹ Altogether, it is a form a subtle cartel which could distort the competitive situation on the market.

Vertical agreements that aim to restrict or even distort competition, such as fixed prices, trading conditions, control of production and harm consumers and which are not indispensable to reach the positive effects are in conflict with the regulatory framework.

2.5 Exclusivity agreements

Besides entering into horizontal or/and vertical agreements in order to pursue co-investments the involved parties could also enter into exclusivity agreements regarding access to the deployed fiber networks. An exclusivity agreement could cover aspects like limitations on distribution of services.

Exclusivity agreements could be based on horizontal as well as vertical agreements comprising production cooperation between two or more companies. Exclusivity agreements imply that the involved parties introduce some kind of restriction on access to the jointly deployed infrastructure. Vertical agreements could, for example, stipulate that operators active in layer 1 and layer 2 agrees not to open the network for other parties and not to resell access services to other parties.

The view on exclusivity agreements for co-investment projects depends on the number of operators involved, requirements and obligations to provide access on networks deployed by co-investment projects and what kind of impact it has on the level of competition in the downstream market.²² An exclusivity agreement has to be regarded as a supplement to the actual co-investment agreement as this is the basis for the network. The exclusivity agreement is thereby a supplement, a consequence of the initial co-investment that is the basis for the agreement.

However, in case any of the involved parties have SMP designation it would supersede any exclusivity agreement as the operator presumably has an obligation to provide access.

2.6 Operators join forces through co-investments

Agreements between two or more parties to jointly produce certain services will benefit from the EU block exemption on specialization agreements, provided that the combined market share of the parties do not exceed 20%.²³ It is recognized therein that such an agreement may be combined with an exclusive supply agreement and still be covered by the exemption.²⁴

²¹ Presentation prepared by Helen Bardell, Partner – Baker & McKenzie LLP, London for the BIICL Conference - 19th April 2010. http://www.biicl.org/files/5000_helen_bardell_hub_and_spoke_-_slides.ppt

²² 28 NGA Recommendation

²³ Commission Regulation (EC) No 2658/2000 of 29 November 2000 on the application of Article 81(3) of the Treaty to categories of specialization agreements

²⁴ Article 3 (a).

This implies that the beneficial effects of such agreements, and the necessity to include an exclusivity clause, are recognized.

Co-investments between operators should, according to the NGA recommendation, not result in a regulatory treatment different from situations where dominant firms deploy networks on their own. The key question is how to regard the restriction on competition. Assuming that the network would not exist without the co-investment there should be no competition problem as there would otherwise not be any network in place.

Co-investments constitute a potential risk for competition problems, as it implies a coordination of the parties' competitive behavior, which could result in cartel agreements, fixed prices or agreements to share markets.²⁵

2.7 The SMP framework has an impact on exclusivity agreements

The European regulatory framework for SMP regulation takes its starting point in the essential facility doctrine, which is defined as a facility or infrastructure which is instrumental in order to provide services to end-customers. This implies that an operator with a dominant position that owns or controls such a facility and refuses to make it available to competitors abuses its position of dominance.²⁶ The key issue is who is controlling the facility, regardless if it is owned by a single company or if it is jointly-owned or controlled.

Given that the access market for fixed infrastructure is dominated by incumbents, with SMP status, co-investments for fiber access networks are likely to involve SMP operators. The SMP operators are commonly obliged to open their access network in order to facilitate competition. And depending upon how the NRAs are defining the access market regulators are likely to decide that SMP operators have an obligation to open their copper as well as fiber access network for competition.

This would suggest that exclusivity agreements in co-investment schemes comprising SMP operators could challenge the obligation to provide access for competing operators. Altogether, it is likely to vary between different countries but it is safe to say that the outcome of the SMP process for market 4 and 5 have an impact on how to regard exclusivity agreements in co-investment projects for the access network.²⁷

The regulatory framework for electronic communication is based on anticipatory intervention which gives the NRAs' the means to intervene *ex ante* in order to safeguard and facilitate competition, and ultimately enabling end-customers to select among a variety of price worthy services. Operators that are designated to have a significant market power on market 4 and 5 are obliged to open the access network for competing operators and provide services. This implies that exclusivity agreements, in case it restricts access to the network, would be incompatible with the SMP obligation. Given that the three criteria test²⁸, which underscores that the presence of high and non-transitory barriers to entry is a requisite to NRA's to impose obligations on a SMP operator it would be incompatible with exclusivity agreements that restricts entry to access networks.

²⁵ http://europa.eu/legislation_summaries/competition/firms/126062_en.htm

²⁶ A Albers-Llorens, The "Essential Facilities Doctrine in EC Competition Law, The Cambridge Law Journal 1999, page 490

²⁷ As defined by the European Commission in article 7 of the Framework Directive Market 4 is Wholesale (physical) network infrastructure access and Market 5 is Wholesale broadband access

²⁸ The three criteria test analyze whether there are high and non-transitory barriers to entry, a market structure which does not tend towards effective competition within the relevant time period and that competition law is insufficient to alone address the market failures.

Assuming that a number of smaller players that together has a dominant position on the market and enter exclusivity agreement it is unclear whether NRAs' could impose SMP status on a group of companies in a joint venture through a co-investment scheme and decide on obligations to open the access network.

2.8 Competition Law framework

The general view is that vertical agreements are less harmful on competition compared to horizontal agreements. The basis for the Competition Law Framework is that it gives Competition Authorities the mandate to intervene *ex-post* in cases where market participants, according to Competition Authorities, violate the Competition Law framework.

Initially, the assessment requires a definition of the relevant market in order to estimate the market shares for the involved parties.²⁹ If the combined market share is below 30% vertical agreements are covered by the Block Exemption Regulation.³⁰ This signals that the agreement is compatible with the regulatory framework, but it is not always the case.

But if the market share is above 30% it is required to examine whether the vertical agreement distorts competition. This calls for a consideration of factors such as the market position of the suppliers, competitors and the buyer, entry barriers and the nature of the product or service.

Furthermore, despite that vertical agreement could distort competition it could be granted an exemption even if the market shares of the parties exceed 30%. But it requires that the vertical agreement improves production or distribution of the products or services, promote technological and economic development, and ultimately give the customers a fair share of the advantages. This implies that exclusivity agreements that involve large players which aim to generate monopoly profits through an exclusivity agreement would most likely not be compatible with the Competition Law framework.

On the other hand, an agreement that safeguards a sufficient degree of downstream competition and involves a number of players, including a wholesale party, would be compatible with the Competition Law framework.³¹

The Competition Law framework stipulates that the view on horizontal agreements is largely determined by the degree of commonality of costs. This implies that if the exclusivity agreement concerns the construction of a fiber network the production cost for the jointly developed network should be compared with the overall cost base in order to estimate the degree of commonality of costs. If the commonality of cost is high and easy to coordinate prices operators have limited ability to differentiate its services compared to its partners.

This suggests that it can be a concern for the Competition Authorities. But given that vertically integrated operators approximately spend 40% of their operational expenses on marketing, subscriber acquisition cost and roughly 30-50% on network capacity the degree of commonality of cost would rather be low or medium. This would suggest that co-investments

²⁹ Commission Regulation (EC) No 330/2010 on the application of Article 101 (3) of the EC Treaty to categories of specialization agreements horizontal,

³⁰ Regulation No 2790/1999

³¹ NGA Recommendation, annex

in fiber access networks would be acceptable for Competition Authorities.³² But depending upon if there is an operator with significant market power it would be subject for SMP regulation.

³² As stated in paragraph 3 of the Commission Guidelines on the applicability of Article 101 of the Treaty on the Functioning of the European Union (TFEU) to horizontal cooperation agreements. Horizontal Guidelines, paragraph 23. Co-investment in NGAs and competitive assessment of horizontal cooperation agreements Gonçalo Machado Borges 22.10.2010. Commission Notice – Guidelines on the applicability of Article 81 of the EC Treaty to horizontal cooperation agreements (2001/C 3/02).

3 Co-investment projects

3.1 A number of project ongoing

We are in the following highlighting a number of co-investment schemes in the Netherlands, Italy, France, Switzerland and New Zealand. The final case in this section presents co-investments in submarine cable systems, which have been an established practice in the telecom industry.

Given that Europe has ambitious broadband targets and that the current coverage of fiber is limited it is a major undertaking for Europe. Although cable has the capacity for broadband the fiber roll out is yet to take place and the following examples underscores that extensive work is ongoing and that it taking new forms.

Figure 4 NGA total coverage and take-up for FTTH, FTTC and FTTN/DOCSIS 3.0 (HFC)

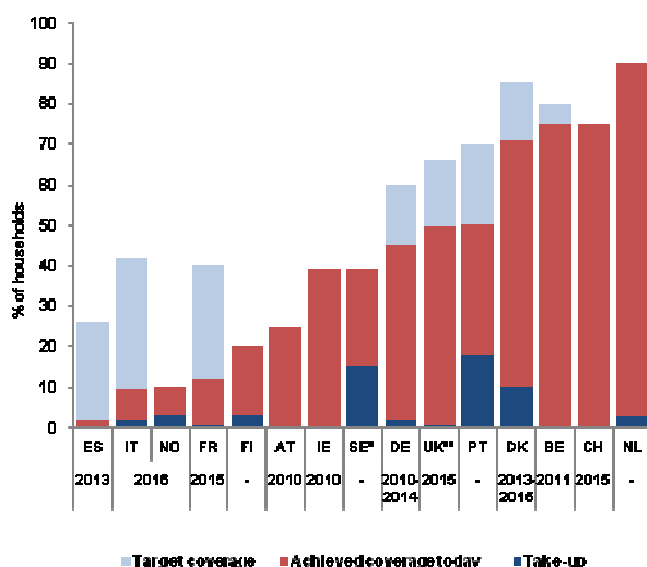

Source: Cullen International

3.2 The Netherlands

Reggefiber is a joint venture between KPN and the investment company Reggeborgh, where they own 41% and 59% respectively. The company is deploying a fiber network in part of the Netherlands with the ambition to connect at least 2 million households by 2013. By end of Q2 2011 Reggefiber connected 768K households and with 61K active subscribers for KPN and 154K with other ISPs. The aim is to reach 40% of the 7.3 million Dutch households by the end of 2011.³³ Reggefiber has SMP status and an obligation to provide fiber unbundling. Although OPTA (the NRA) has given Reggefiber the ability to set prices that gets reasonable return the prices offered by the company is below the price cap that OPTA has set.³⁴

The Rabobank Real Estate Group established the Communication Infrastructure Fund CIF in 2008 with the aim to invest in communication infrastructure, such as fixed line and masts with a capital base of EUR 1 bn. The aim is to make long term investment in FTTH. The fund acquired a cable company in 2008 with 170K connected households and has developed its

³³ KPN earnings call Q2 2011

³⁴ Source Cullen International, Fiber unbundling – regulation and prices, August 2011

wholesale business from that base. It is an infrastructure provider that invites operators and service providers to use its network.³⁵

Figure 5 Infrastructure provider CIF

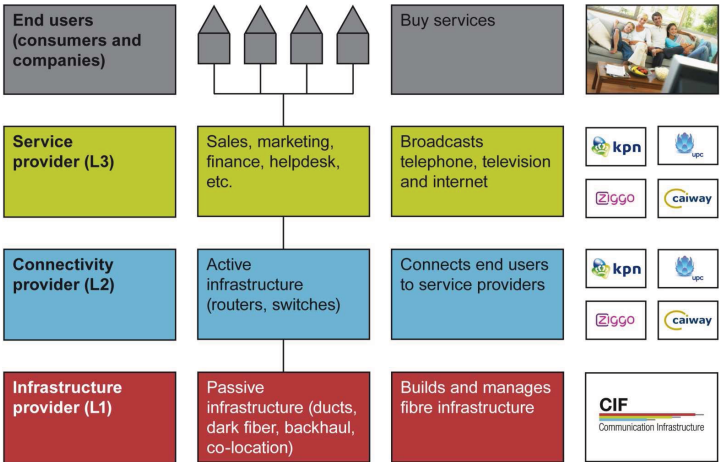

Source: CIF³⁶

3.3 Italy

The Italian Government and the main Italian telecom operators (BT Italia, Fastweb, H3G, Telecom Italia, Tiscali, Vodafone and Wind) have made an agreement regarding the creation of a co-investment vehicle in the form of a public-private partnership (PPP) that aim to deploy fiber network (including ducts, dark fiber from the optical distribution frame (ODF) to end-user premises, in-house cabling) in areas where the operators do not plan to build their own fiber networks. The co-invested network which will be run by a new company aim to reach 50% of the households in Italy and the estimated capex is around EUR 8.3 bn. The plan is to establish a neutral infrastructure.³⁷

Figure 6 NewCo hybrid PON/P2P FTTH architecture

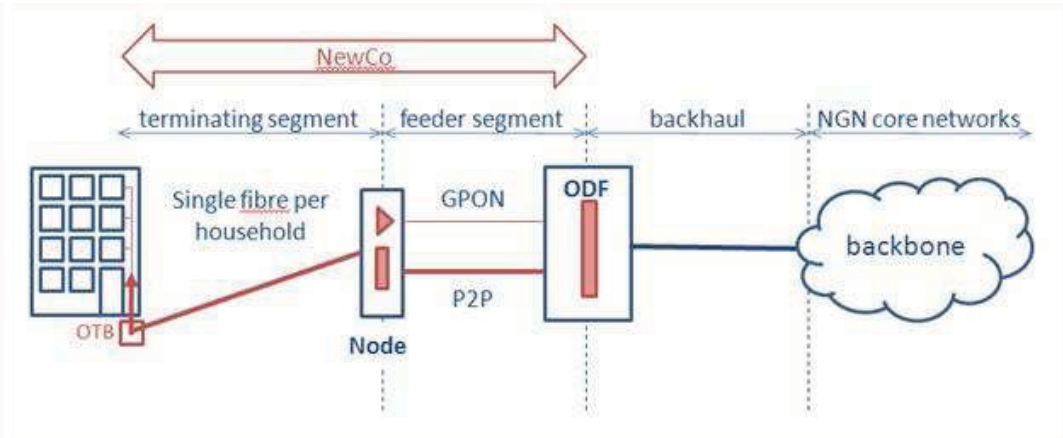

Source Cullen International

³⁵ Source Martijn Visser presentation at PTS market day March 2011: see link <http://www.pts.se/sv/Bransch/Telefoni/Arrangemang/PTS-marknadsdag/Marknadsdag-2011/>
³⁶ ibid
³⁷ Source: Cullen International

3.4 France

Bouygues Telecom and SFR made in the end of 2009 an agreement for a co-investment to roll out FTTH networks in densely populated areas in France. SFR provides NGA services based on FTTH since 2010, and Bouygues Telecom plans to start commercial operations in the second half of 2011.³⁸

According to the Telecommunications Law in France all network operators that deploy fiber inside buildings an obligation to meet reasonable access requests, and on request install additional fiber for other operators on their expense and thereby turn into a co-investment.³⁹

France Telecom has revealed that it is planning to seek partnerships to finance fiber rollout in the market. The company stated that cooperation with other potential fiber operators and co-investment deals will be major elements in achieving ambitious goals for fiber coverage in the country.⁴⁰

3.5 Switzerland

There are co-operation agreements between Swisscom and some utilities in Switzerland. A common approach is that co-investment is a geographical split where each operator builds at least four fibers in each house it covers and gives access to one or several fibers to the other operator in the collaboration and thereby gets access to a larger area than what it is capable to build its self. The access to fiber could be in the form of indefeasible rights of use (IRU) which are granted for longer time periods, like 30 years. A common cost allocation is that the incumbent bears 60% of the investment and the utility 40%.⁴¹

3.6 New Zealand

The Government, Telecom New Zealand and Enable Networks have made an agreement to complete the deployment of a fiber network, labeled as Ultra Fast Broadband, with the aim to reach 75% of the households in New Zealand by 2019. The network will provide open access to service providers as part of the agreement is a structural separation of Telecom Zealand which will be split into two separate companies taking effect by the end of 2011, by spinning off the fixed network and wholesale division Chorus. Telecom New Zealand has made an agreement with Crown Fiber Holding (which has been set up to manage the government's investment) which allows the network and wholesale business for Telecom New Zealand Chorus to take the cornerstone role in the deployment of the national fiber network. Crown Fiber Holding (the New Zealand state) will invest EUR 540m in Chorus, which will be a listed company, in combination with that Chorus will invest EUR 280-400m partly by capital injection and by rising capital on the financial market. The financial target for Chorus is that net debt in relation to EBITDA should not exceed 3.5 on a long run basis.⁴² This implies that the new network unit will have a gearing that is roughly three times as high compared to what Telecom New Zealand has reported during 2005-2010. As a comparison BT has a ratio of net debt to EBITDA around 1.6.

³⁸ Source: Cullen International

³⁹ Source: Cullen International

⁴⁰ Source: Cullen International

⁴¹ BEREC report Annex I to the BEREC Report Next Generation Access – Collection of factual information and new issues of NGA roll-out Country Case Studies, February 2011, and Cullen International

⁴² Telecom New Zealand, Business Update Call date 2011-05-23, Investor September 2011 (see link: <http://phx.corporate-ir.net/External.File?item=UGFyZW50SUQ9MTA2Nzc4fENoaWxkSUQ9LTF8VHlwZT0z&t=1>) and Q4 2011 earnings call, date 2011-08-18, and information from <http://ufb.telecom.co.nz/>

Figure 7 Net debt in relation to EBITDA

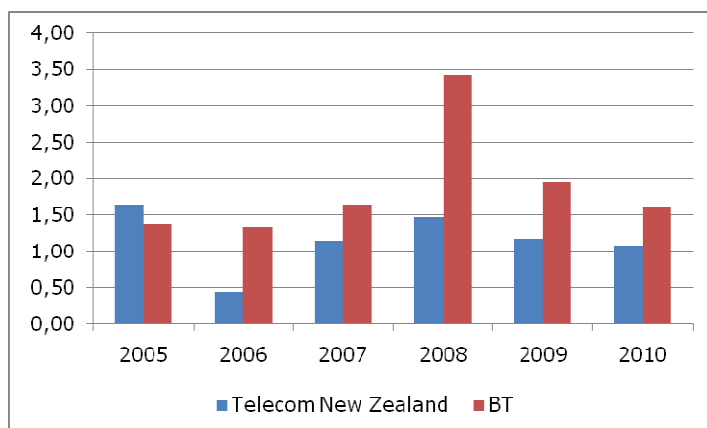

Source: Bloomberg

3.7 Submarine cable systems

The telecommunications industry has used the co-investment model for deployment of submarine cable systems by forming consortiums where participants agree to jointly fund a submarine cable upfront, and then receive shares of capacity in exchange in proportion to the investment. This enables network operator to compete on the downstream market by securing the right to exploit capacity by only paying a part of the capital intense submarine cable. The submarine project is funded and the aim is just to cover cost in order to supply network capacity to its participants. On the negative side is that the consortium structure could be slow to plan and upgrade networks.⁴³

3.8 Co-investment in mobile networks

Network sharing is common in the mobile industry, and the degree of network sharing goes from sharing passive infrastructure to active network sharing. Mobile network operators are commonly sharing site and mast on most markets.⁴⁴

Austria: T-Mobile and Orange are pursuing RAN sharing in rural areas.

Denmark: Telenor and TeliaSonera are pursuing RAN sharing.

Norway: Tele2 and Network Norway set up a joint venture for rollout of a national 2G and 3G network.

Sweden:

- TeliaSonera and Tele2 have one joint venture company Svenska UMTS Nät (SUNAB) which has deployed a national 3G network.
- Telenor and Hi3G have a joint venture company 3G Infrastructure Services (3GIS) which has deployed a national 3G network outside the major cities in Sweden.

⁴³ http://www.vodafone.com/content/dam/vodafone/about/public_policy/position_papers/vodafone_comments_final.pdf

⁴⁴ Information regarding network sharing in the different countries are based on corporate information and Cullen International, and Mobile Network Sharing – Swedish experiences by Bengt Mölleryd, <http://www.slideshare.net/Garry54/mobile-network-sharing-swedish-experiences>

- Telenor and Tele2 have set up a joint venture, Net4Mobility which is rolling out a national 2G and 4G network.

Figure 8 Network sharing companies in Sweden



UK:

- T-Mobile and Orange has set up a joint venture Everything Everywhere that is merging the owners respectively 2G and 3G networks.
- Vodafone and O2 has set up a company Cornerstone that is building new sites and consolidating existing 2G and 3G sites.
- T-Mobile and H3G has set up a joint venture Mobile Broadband Network to share masts and 3G access networks

4 Conclusions

This paper has addressed a number of different aspects regarding co-investments on NGA, giving the basis to make three conclusions. The examples revealed in this paper shows that we are just in the beginning of a new era in the changing telecom landscape. Specialization requires competitors to cooperate in order to free up resources and specialize in their core business.

Firstly, the issue of impact on competition on the wholesale as well as downstream market could be addressed by regulatory authorities as well as competition authorities within the current regulatory framework. This implies that operators with SMP status would be forced to provide access to other operators in order to avoid that competition are distorted or network clubs are formed. The development of network sharing on the mobile market demonstrates that competitors can collaborate on the upstream market while competing fiercely on the downstream market. Network sharing between mobile operators have been decisive in order to fulfill coverage requirements which suggest that co-investments for NGA could be a vehicle that contributes to the fulfillment of the broadband targets. If co-investments in NGA, including exclusivity agreements, are proven necessary to further competition and to realize beneficial effects on the market could it be a sign that the markets are developing into the kind of dynamic markets where SMP regulation is unnecessary.

Secondly, the rationale for operators to enter co-investment projects in NGA is similar to the formation of co-investments in submarine cables or mobile network schemes as it facilitates for the participants to lower both capital and operational expenditures and facilitates access to a larger network that otherwise would be the case.

Thirdly, co-investments companies or network companies have the ability to more actively utilize the balance sheet in order to increase financial leverage as the provision of network capacity have lower risk and generates a stable cash flow. This implies that there should be economic benefits to move towards a vertical disintegration in an all IP world.

Given that this paper is of explorative character it addresses a number of issues that are relevant for further research. An interesting issue is how competition is impacted by collaboration between competitors on an upstream market and how “Chinese walls” could be used in order to eliminate negative effects on competition. A key question is whether the transition to all IP networks fundamentally alters the basis for how operators are organized and could co-investments be instrumental in this development? Finally, is Telecom New Zealand showing the way for how the future operators should be structured in order to meet the current and future challenges?

References

Albors-Llorens, A. The “Essential Facilities Doctrine in EC Competition Law, The Cambridge Law Journal 1999, page 490

Borges, Gonçalo M., Co-investment in NGAs and competitive assessment of horizontal cooperation agreements, PLUG APRITEL, 22.10.2010

Coase R. H, The Nature of the Firm, *Economica*, New Series, Volume 4, Issue 16, Nov.,1937, page 386-405

COMMISSION RECOMMENDATION of 20/09/2010 on regulated access to Next Generation Access Networks (NGA) {SEC(2010) 1037}

COMMISSION RECOMMENDATION, COMMISSION STAFF WORKING DOCUMENT
Accompanying document to the COMMISSION RECOMMENDATION on regulated access to Next Generation Access Networks (NGA) {C(2010) 6223}

Commission Notice – Guidelines on the applicability of Article 81 of the EC Treaty to horizontal cooperation agreements (2001/C 3/02).

Frisanco, T. et.al, Infrastructure Sharing and Shared Operations for Network Operators, IEEE, ICC 2008

Indestege, Dries, The Netherlands – infrastructure sharing and co-investment, Cullen International, November 5, 2010

Jaspers, F, and J.van den Ende, The organizational form of vertical relationships: Dimensions of integration, *Industrial Marketing Management*, page 819-828, 2006

Williamson, O. E., *The economic institutions of capitalism*. New York: The Free Press, 1985