

Kunert, Joachim; Auer, Corinna; Erdbrügge, Martina; Göbel, Roland

Working Paper

An experiment to compare the combined array and the product array for robust parameter design

Technical Report, No. 2003,13

Provided in Cooperation with:

Collaborative Research Center 'Reduction of Complexity in Multivariate Data Structures' (SFB 475), University of Dortmund

Suggested Citation: Kunert, Joachim; Auer, Corinna; Erdbrügge, Martina; Göbel, Roland (2003) : An experiment to compare the combined array and the product array for robust parameter design, Technical Report, No. 2003,13, Universität Dortmund, Sonderforschungsbereich 475 - Komplexitätsreduktion in Multivariaten Datenstrukturen, Dortmund

This Version is available at:

<https://hdl.handle.net/10419/49369>

Standard-Nutzungsbedingungen:

Die Dokumente auf EconStor dürfen zu eigenen wissenschaftlichen Zwecken und zum Privatgebrauch gespeichert und kopiert werden.

Sie dürfen die Dokumente nicht für öffentliche oder kommerzielle Zwecke vervielfältigen, öffentlich ausstellen, öffentlich zugänglich machen, vertreiben oder anderweitig nutzen.

Sofern die Verfasser die Dokumente unter Open-Content-Lizenzen (insbesondere CC-Lizenzen) zur Verfügung gestellt haben sollten, gelten abweichend von diesen Nutzungsbedingungen die in der dort genannten Lizenz gewährten Nutzungsrechte.

Terms of use:

Documents in EconStor may be saved and copied for your personal and scholarly purposes.

You are not to copy documents for public or commercial purposes, to exhibit the documents publicly, to make them publicly available on the internet, or to distribute or otherwise use the documents in public.

If the documents have been made available under an Open Content Licence (especially Creative Commons Licences), you may exercise further usage rights as specified in the indicated licence.

An experiment to compare the combined array and the product array for robust parameter design

by J. Kunert¹⁾, C. Auer¹⁾, M. Erdbrügge¹⁾, and R. Göbel²⁾,

¹⁾ Department of Statistics, University of Dortmund, Germany

²⁾ Chair of Forming Technology (LFU), University of Dortmund, Germany

Abstract:

The paper reports a robust parameter design experiment, where we have used Taguchi's product array and a combined array simultaneously. This was done as part of a research project dealing with experimental design to optimise the process of sheet metal spinning.

We found that the classical analysis of the product array identified a control factor, which has an influence on the variance of the response. There were no indications of this effect in the combined array.

A confirmation experiment supports the finding that this factor in fact is a control factor. It seems that its effect on the variance is due to several two- and three-factor interactions that were not large enough to be found in the combined array. In the authors' opinion this shows that the use of a product array and the classical analysis provides robustness against imprecise model assumptions.

Keywords: Robust parameter design; noise factor; design factor; signal to noise ratio; product array; combined array; interaction plot.

Author's mailing address:

Joachim Kunert

Fachbereich Statistik

Universität Dortmund

D44221 Dortmund

Germany

e-mail: joachim.kunert@udo.edu

1. Introduction:

In robust parameter design (see e.g. Grize, 1995), the experimenter searches for settings of controllable factors ("design factors") that produce results that are near the target, with little variation. The variation is caused by two sources. Part of the variation comes from factors that can be controlled in an experiment but will be hard to control in practice ("noise factors"). Examples for noise factors are variations in the raw material, temperature in the surroundings, etc.. Additionally, there are uncontrollable external factors, causing variation even if all factors in the experiment are kept constant ("pure error").

For experiments with noise factors, Taguchi (see e.g. Taguchi and Wu, 1985) proposed to measure the variation with the help of an outer array. The outer array, also called noise array, is an experimental design of the noise factors. Additionally, an experimental design of the design factors is constructed. This is called inner array. In the experiment the inner and the outer array are combined to a product array. For each setting of the design factors from the inner array, the outer array is carried out completely. The classical analysis is based on the means and the variances of the response variable, calculated over each of the outer arrays. See Fig. 1 for a graphical display of a product array.

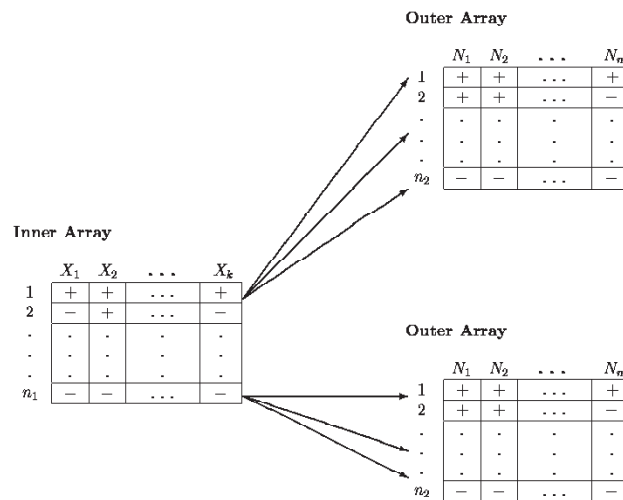

Figure 1: The structure of a product array

This approach was criticised by many statisticians, see e.g. Myers, Khuri and Vining (1992) or Shoemaker, Tsui and Wu (1991). The first point to criticise is that the classical analysis does not use all the available information. For instance, it would be important to know which of the noise factors causes the variation. Therefore, several authors propose not to use the mean and the variance calculated over the noise array, but to do a so-called interaction analysis, i.e. analyse the experiment with the usual analysis for factorial designs. To find effects on the variance, they propose to search for interactions between noise factors and design factors, see e.g. Shoemaker and Tsui (1993) and Steinberg and Bursztyn (1994, 1998).

A further point being criticised is that the product array takes a relatively large number of runs. If we consider the product array as one experiment, we find that all interactions between design and noise factors, even interactions of higher order, are estimable. On the other hand, the inner and the outer array will generally be highly fractionated and will not allow estimation of interactions between the design factors themselves. Therefore, these authors have proposed to use a combined array instead of the product array. The combined array is one experimental design in design and noise factors. Then, in general, the settings of the noise factors are no longer identical for each setting of the design factors. This allows a higher resolution of the design with the same number of experimental runs.

The arguments are convincing. However, the advantages of the combined array largely rely on the assumption that the results of the experiment can satisfactorily be described by a model with only a few main effects and low order interactions. The arguments are mainly based on theoretical considerations and reanalyses of published experiments. It seems that in the literature there is no practical comparison of both approaches for the same experimental situation, where both experiments were carried out simultaneously, a product array and a combined array. We think that such a comparison could contribute to the discussion, maybe by helping to see which model assumptions are relevant for practical problems and which are not.

The collaboration of mechanical engineers and statisticians in a joint project at the university of Dortmund gave us the chance to do such an experiment. The joint project deals with statistical design of experiments to analyse and optimise metal forming processes. This is done for the example of sheet metal spinning. The project is a part of the collaborative research center "Complexity reduction in multivariate data structures" (SFB 475) which is sponsored by the German research council (DFG).

In our experiment we considered 6 design factors A, B, C, D, E, F and 3 noise factors m, n, o, each at two levels. See the appendix for details about the factors and the response variable A_{20} and for some background information.

The data were collected in two different experimental designs. One is a product array, the other one a combined array. The product array that we used here consisted of a fractional factorial 2^{6-3} -Design with resolution III for the design factors ("inner array"). For the noise array we used a fractional factorial 2^{3-1} -design, also with resolution III. This gave us $8 \times 4 = 32$ runs. The combined array consisted of a fractional factorial 2^{9-4} -design of resolution IV, also in 32 runs.

The experiment was carried out in a random order of the runs. More precisely, we had blocks of two, such that each block contained one run from the product array and one run from the combined array. The order of the runs within the arrays was randomized as well as the order of the two runs within each block.

For the analysis, we considered the data from each array separately, as if the experiment had consisted of 32 runs only. For the product array we did two analyses, both of which are reported in Section 2. The first analysis, which we call "classical analysis" (like Grize, 1995), uses the means and the variances over the noise array, the second one, called "interaction

analysis", uses the single observations. The analysis of the combined array, which necessarily is an interaction analysis, is reported in Section 3.

While some results between the two designs agree very well, we also find differences. The largest difference lies in the question whether there is a control factor, i.e. a factor with an effect on the variance or not. The results that we got from the two designs are compared with each other and with the results of two confirmation experiments in Section 4.

2. Analysis of the product array

The observations of our product array are displayed in Table 1. The structure of the design can be seen from the fact that the setting of the first six factors, the design factors, stays constant for each group of four runs. The setting of the three last factors, the noise factors, repeats every four runs.

A	B	C	D	E	F	m	n	o	A_{20}
-	-	-	-	+	+	-	-	-	5.87
-	-	-	-	+	+	-	+	+	7.25
-	-	-	-	+	+	+	-	+	6.36
-	-	-	-	+	+	+	+	-	6.19
-	-	+	+	-	-	-	-	-	3.22
-	-	+	+	-	-	-	+	+	3.55
-	-	+	+	-	-	+	-	+	2.99
-	-	+	+	-	-	+	+	-	3.90
-	+	-	+	-	+	-	-	-	2.94
-	+	-	+	-	+	-	+	+	3.26
-	+	-	+	-	+	+	-	+	3.37
-	+	-	+	-	+	+	+	-	3.80
-	+	+	-	+	-	-	-	-	2.22
-	+	+	-	+	-	-	+	+	3.43
-	+	+	-	+	-	+	-	+	2.32
-	+	+	-	+	-	+	+	-	3.60
+	-	-	+	+	-	-	-	-	4.14
+	-	-	+	+	-	-	+	+	5.18
+	-	-	+	+	-	+	-	+	4.43
+	-	-	+	+	-	+	+	-	4.91
+	-	+	-	-	+	-	-	-	5.04
+	-	+	-	-	+	-	+	+	6.20
+	-	+	-	-	+	+	-	+	3.79
+	-	+	-	-	+	+	+	-	5.73
+	+	-	-	-	-	-	-	-	2.97
+	+	-	-	-	-	-	+	+	1.01
+	+	-	-	-	-	+	-	+	1.55
+	+	-	-	-	-	+	+	-	1.74
+	+	+	+	+	+	-	-	-	4.46
+	+	+	+	+	+	-	+	+	5.28
+	+	+	+	+	+	+	-	+	4.57
+	+	+	+	+	+	+	+	-	5.14

Table 1: The design and the observations of the product array

The inner array consists of 8 runs. It is a resolution III design with the following confounding structure for the main effects and two-factor interactions:

$$A = C:F = D:E, B = C:E = D:F, C = A:F = B:E, D = A:E = B:F, E = A:D = B:C, F = A:C = B:D, A:B = C:D = E:F.$$

The outer array is a 2^{3-1} designs with four runs and the defining relation $o = -n:m$.

To analyse the data from a product array, Taguchi proposed to calculate the mean and standard deviation over each of the outer arrays. From those, he calculated two response-variables for the inner array which are analysed separately. The first variable is the logarithm of the mean. The second variable is the logarithm of the ratio between mean and standard deviation. This concept was generalised by e.g. Box (1988). He proposed to transform the variables before calculating the means and standard deviations, and then to analyse the means and the logarithm of the standard deviations directly. As Box (1988) has shown, this analysis is equivalent to Taguchi's original analysis, if the transformation of the data consists of taking the logarithm. To select an appropriate transformation, Box (1988) proposed the use of so-called λ -plots.

A problem with the λ -plots lies in the fact that they do not necessarily provide a unique solution. To a certain extent, the transformation is chosen subjectively and this requires experience.

A	B	C	D	E	F	mean	variance
-	-	-	-	+	+	6.4	0.35
-	-	+	+	-	-	3.4	0.16
-	+	-	+	-	+	3.3	0.13
-	+	+	-	+	-	2.9	0.52
+	-	-	+	+	-	4.7	0.22
+	-	+	-	-	+	5.2	1.10
+	+	-	-	-	-	1.8	0.69
+	+	+	+	+	+	4.9	0.17

Table 2: The means and the variances over the outer array

An alternative method to select an appropriate transformation is the β -plot. This was proposed for product arrays by Logothetis (1990). The β -plot is based on the mean and the standard deviation derived from the outer array for each run of the inner array. For our data, these are reported in Table 2. We plot the logarithm of the standard deviation against the logarithm of the mean. In the traditional β -plot, we then calculate the simple linear regression of the logarithm of the standard deviation on the logarithm of the mean. The transformation is calculated from the slope of the regression line. Engel (1992) points out that this β -plot does not have to be consistent in the presence of control factors and proposes a variant of the β -plot.

Kunert and Lehmkuhl (1998) show that Engel's (1992) version does not have to be consistent either. They propose a further variant of the β -plot, which is consistent if there is at most one control-factor. This variant consists of two steps. In the first step, it fits two parallel regression lines for each factor in the inner array, one for each level of the factor. In a second step, it selects the factor for which the resulting covariance analysis has the largest coefficient of

determination. The transformation is calculated from the slope of the two lines for this selected factor. For details see Kunert and Lehmkuhl (1998).

For the data in Table 2, the original β -plot on the left of Figure 2 gives hints that the variance might be decreasing when the mean increases. However, the variant of the β -plot on the right of Figure 2 shows that this can be explained if we assume that there is a control factor: the variance appears to get smaller when factor D is at level +1, not with increasing mean. We therefore decided not to transform the data.

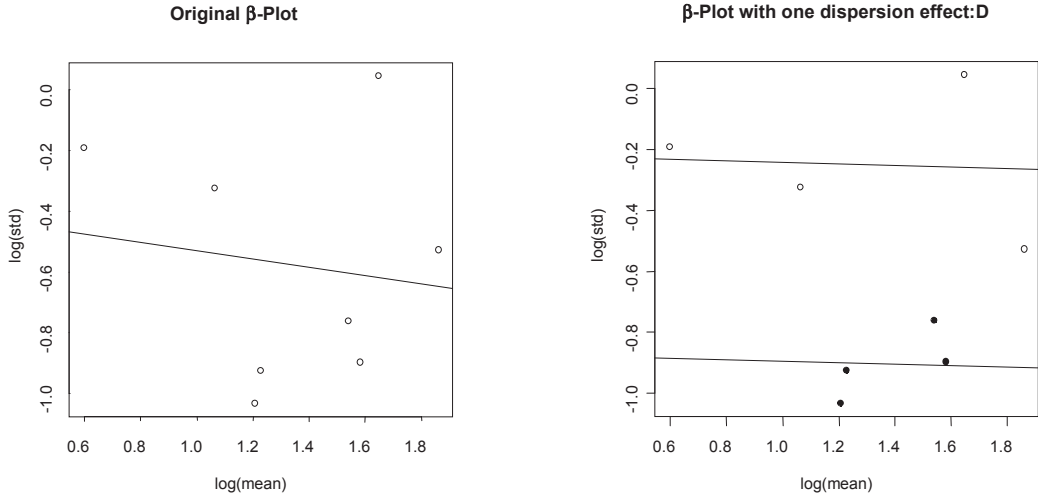

Figure 2: The β -plots for the data from the product array (the dark circles in the right plot are for D at +)

The estimates for the influence of the design factors on the means are

$$A = 0.06, B = -0.85, C = 0.01, D = -0.00, E = 0.63, F = 0.88, A:B = 0.05$$

and the overall mean is 4.07.

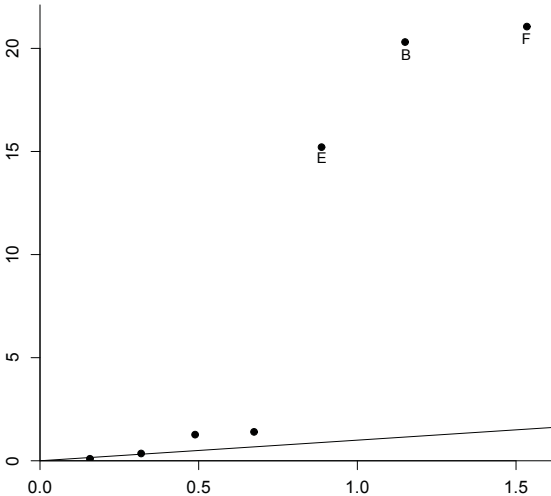

Figure 3: The half-normal plot for the means from the product array

From these estimates, we calculated the half-normal plot for the means, displayed in Figure 3. Our version of the half normal plot standardises the contrast estimates by dividing each by

Dong's ASE. This estimate has a reasonably small bias, but a smaller variance than competing estimates (see Kunert, 1997). For our data, applying the ASE yields a standard deviation of the estimates of the effects on the mean of 0.042. In the half-normal plot, we draw the i -th largest absolute value of the standardised contrasts against

$$\Phi^{-1}\left(\frac{1}{2} + \frac{i}{2(m+1)}\right), 1 \leq i \leq m,$$

where m is the number of contrasts and Φ is the distribution function of the standard normal distribution. We add a straight line through the origin with slope 1. The half-normal plot in Figure 3 indicates that factors F, B and E have a significant influence on the mean.

If, on the other hand, we use the logarithm of the empirical variance over the outer array as response variable, we get the following estimates for the effects of the design factors

$$A = 0.25, B = -0.07, C = -0.10, D = -0.66, E = -0.10, F = -0.05, A:B = -0.12.$$

From these estimates, we derive the half-normal plot displayed in Figure 4, where we have used the fact that the ASE for these data equals 0.23.

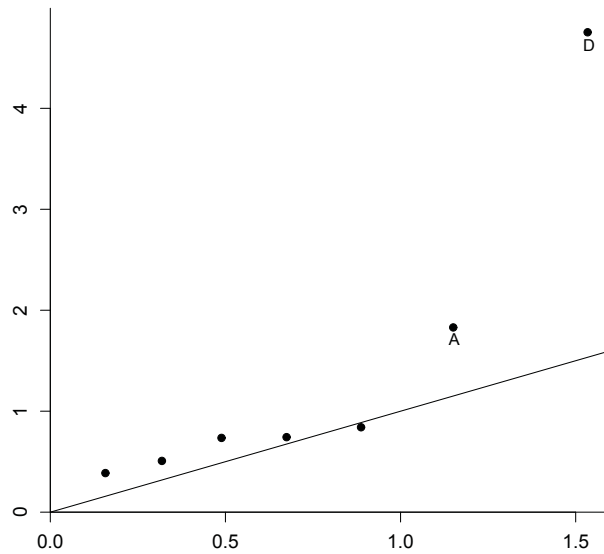

Figure 4: Half-normal plot for the variances from the product array

This plot gives hints that D might be a control factor. This agrees with the impression that we got from the beta-plot: It seems that there is a smaller variance if D is at level +.

Summarizing, the classical analysis would recommend to set factor D at level +1. Since we want to get A_{20} as small as possible, we would choose the factors B, E and F in such a way that their estimated effects add to a small predicted A_{20} . Hence, we would try to choose the setting displayed in Table 3, where the setting of the factors in brackets could be changed, if convenient.

A	B	C	D	E	F
(-)	+	(-)	+	-	-

Table 3: Recommended setting from the classical analysis of the product array

For this setting, the estimated effects give the prediction

$$A_{20}\text{-pred} = 4.07 + B - E - F = 4.07 - 0.85 - 0.63 - 0.88 = 1.71.$$

Note that there are four independent estimates used for this prediction, all with the same variance. We hence estimate that the variance of this prediction equals $4 \times \text{ASE}^2 = 0.00705$. This corresponds to a standard deviation of 0.084.

Note that each estimate is the mean of 8 means. If we define the standard deviation of a single mean over the noise array by τ^2 , then the estimates for the effects of factors have variance $\tau^2 / 8$, and the ASE is an estimate for $\sqrt{\tau^2 / 8}$. Therefore, we estimate τ^2 as 0.014.

In all, we expect that the squared deviation from the prediction should be

$$4 \frac{\tau^2}{8} + \tau^2 = \frac{3\tau^2}{2},$$

if a mean over the noise array is determined at the setting in Table 3. This is estimated by $12 \text{ASE}^2 = 0.021$. Hence, we would expect that the mean of an outer array that we run at the setting in Table 2 should be within the interval $1.71 \pm 2 \times \sqrt{0.021} = [1.42, 2.00]$. See Section 4 for results of confirmation runs at this setting.

As a second analysis of the product array, we did an interaction analysis, analysing the single observations from Table 1. The product array, if considered as a single factorial design, has a confounding structure as follows (main effects and two-factor interactions only):

$$A = C:F = D:E, B = C:E = D:F, C = A:F = B:E, D = A:E = B:F, E = A:D = B:C,$$

$$F = A:C = B:D, A:B = C:D = E:F, m = -n:o, n = -m:o, o = -m:n,$$

as already seen for the outer and inner array. Additionally, we have that

A:m, A:n, A:o, B:m, B:n, B:o, C:m, C:n, C:o, D:m, D:n, D:o, E:m, E:n, E:o, F:m, F:n, F:o are clear, and even that the three three-factor interactions

A:B:m, A:B:n and A:B:o

are not confounded with any two factor interactions or main effects.

Name	Inter- cept	F	B	E	n	C:n	E:o	A:B:n	B:n	D:m
Size	4.08	0.88	-0.85	0.63	0.31	0.20	0.18	-0.18	-0.13	0.12
E:n	A:m	F:o	F:n	A:o	B:o	B:m	A	A:B	m	D:o
0.10	-0.10	0.10	0.09	-0.09	-0.09	0.08	0.06	0.05	-0.05	0.05
A:n	o	C:m	F:m	C:o	E:m	A:B:m	A:B:o	C	D	D:n
-0.05	-0.04	-0.03	-0.03	-0.03	0.032	-0.02	-0.01	0.01	-0.00	-0.00

Table 4: Estimated size of the effects on the single observations

For these effects we got the estimates in Table 4, which are sorted according to their absolute size. It is clear that the design factors must (and do indeed) give the same estimates as in the analysis of the means over the noise array. The factors F, B and E produce the three largest effects (except for the intercept). The fourth largest effect comes from the noise factor n. The half-normal plot in Figure 5 is based on the 31 independent contrast estimates in Table 4. Therefore it gives about 20 degrees of freedom for the ASE (see Kunert, 1997). From the estimates in Table 4 we calculate an ASE of 0.09.

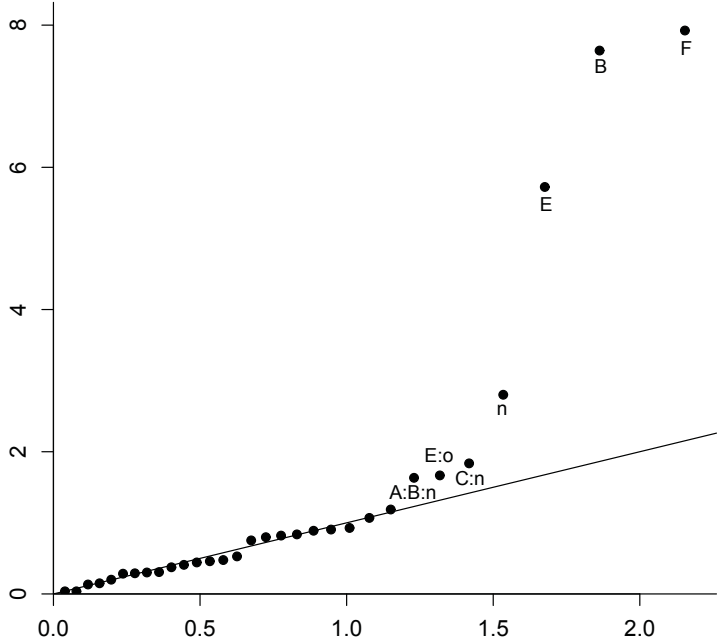

Figure 5: Half-normal plot derived from the single observations of the product array.

The plot in Figure 5 clearly indicates that the effects of F, B, E, n are significantly different from zero. If we do not wish to control the experiment-wise error level, we can find additional factors for which there are hints that they are also active. This can be done by applying individual t-tests. The two-sided t-test with 20 degrees of freedom and the level $\alpha = 0.1$ has critical value 1.72. We therefore conclude that a contrast in Table 4 is likely to be important if its estimate is larger than $1.72 \times ASE = 0.16$. We hence should also consider the interactions C:n, E:o and A:B:n. Since A:B:n is not confounded with any main effect or two-factor interaction, we therefore have at least one important three factor interaction. This causes problems in the interpretation – there might be other important three-factor interactions that are confounded with main-effects or a two-factor interactions. Furthermore, A:B:n is confounded with C:D:n and E:F:n.

For effects on the mean, the analysis based on Table 4 agrees with the findings of the classical analysis. We identify the same design factors as significant. Since we want to get a small A_{20} , we therefore arrive at the same setting as in Table 3, giving the same predicted average over the

noise design. However, we have the additional information that the noise factor n should have an influence, and we have hints that there are three interactions with noise factors.

Before we try to identify which of the interactions $A:B:n$, $C:D:n$ and $E:F:n$ are responsible for the size of $A:B:n$ in Table 4 and whether $C:n$ and $E:o$ are really the two-factor interactions that we think they are, we check whether the identified interactions can sufficiently well approximate the observed variance structure in the data.

We hence have fitted all observations of the product array to the model with the seemingly important factors F , B , E , n , $C:n$, $E:o$ and $A:B:n$. Note that this fit stays the same, whichever of a group of confounded factors is regarded as being active. From the fitted observations, we calculated the predicted mean and variance over the outer array for each setting of the inner array. These are listed in Table 5, which also contains the observed mean and variance already displayed in Table 2.

A	B	C	D	E	F	fitted mean	observed mean	fitted variance	observed variance
-	-	-	-	+	+	6.4	6.4	0.05	0.35
-	-	+	+	-	-	3.4	3.4	0.19	0.16
-	+	-	+	-	+	3.5	3.3	0.16	0.13
-	+	+	-	+	-	3.0	2.9	0.68	0.52
+	-	-	+	+	-	4.7	4.7	0.16	0.22
+	-	+	-	-	+	5.2	5.2	0.68	1.10
+	+	-	-	-	-	1.7	1.8	0.05	0.69
+	+	+	+	+	+	4.7	4.9	0.19	0.17

Table 5: Predicted and observed means and the variances over the outer array

We observe that the means are fitted very well. For the variances, we have a sufficiently good fit for all but two settings. At these two, however, the fit is very poor. Our interaction analysis predicts a small variance, namely 0.05 for the two settings with both C and D at level -1 . As a consequence, it assumes that there should be a large effect of factor C and of the interaction $A:B$ on the variance. In reality, however, we observed the relatively large variances 0.35 and 0.69 for these two settings. It seems that there is something important that is not explainable by the effects identified in our interaction analysis.

Can we find a reason why in the classical analysis factor D and not C seems to have an effect on the variance? Note in Table 4 that the interaction of factor D with any of the three noise factors is small compared to the ASE. There are also no hints from the half-normal plot in Figure 5 that any of those interactions might be active. The only possible interaction is due to the fact that $A:B:n$ is confounded with $C:D:n$.

To get some deeper insight, we plot the difference of each single observation from the mean over the respective outer array. This is displayed in Figure 6. Here we have separated the observations in such a way that those differences where D is at level $-$ are to the left, while on the right of Figure 6 we have the differences with D at $+$.

All observations with factor m at level -1 are plotted as a star, all observations with m at level $+1$ as a circle. The graph supports the view that there is less variability for D at $+$. We also have included an interaction plot for D and m, i.e. two lines, one of which combines the mean of the observations with (D+, m+) with the mean of those with (D-, m+). The other one combines the mean of (D+, m-) with the mean of (D-, m-).

Note that the interaction plot for D and m shows that the difference between the means is (slightly) smaller for D at $+$ than for D at $-$. However, this cannot sufficiently explain why the points to the right show so much less variation. A similar picture is achieved if we draw the corresponding lines for D and o or (to a much lesser extend) for D and n.

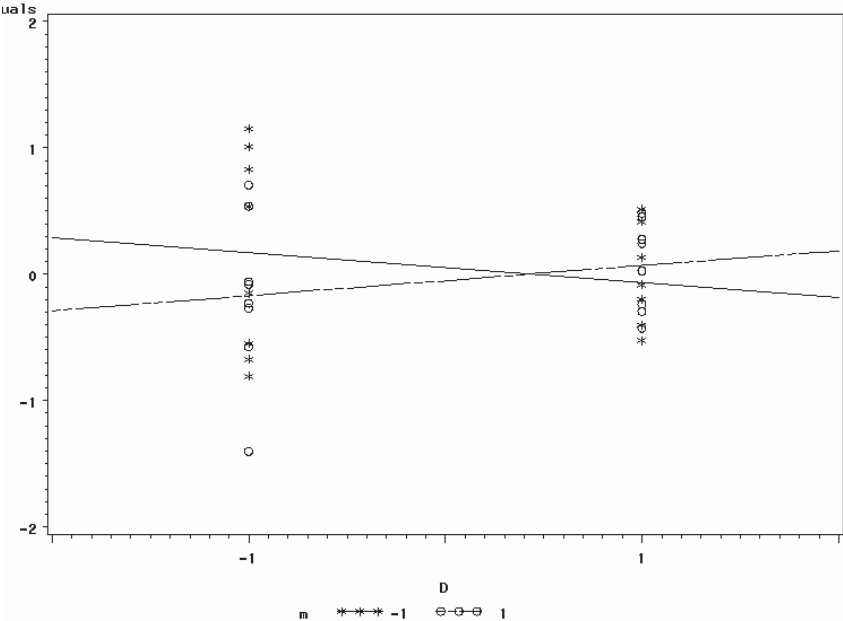

Figure 6: Interaction Plot D:m from the product array. The differences from the means of the noise arrays are added to the graph.

The effect of factor D might be due to interactions which are present, but too small to be significant. However, the apparent effect of factor D on the variance cannot be explained by adding all main effects of the noise factors and all two-factor interaction effects of the noise factors with factor D to the model that produced Table 5. We still expect the smallest variances for the settings with both C and D at -1 and expect a larger effect of C on the variance than of D.

We then tried a series of prediction models, by adding the factors in the order given by Table 4. Here, we needed a model containing all factors up to factor m. This model could predict the sizes of the variances properly. However, it is clear that it is not really sensible.

Since there are hints for an interaction between C and n, we might want to look at the interaction plot for C and n. If we draw a graph analogous to Figure 6, we get the rather different picture in Figure 7.

While the interaction plot shows that the means of all observations with n at - and n at + differ less for C at - than for C at +, the observed deviations from the mean appear to be equally large. This cannot be explained by two-factor interactions between C and the other noise factors. We get a similar picture for the other two interaction plots for C.

From these analyses, we get the impression that maybe C and D have effects on the residual variance that overlay the effects on the means. Maybe C produces a larger residual variance at level +1, while D produces a smaller residual variance at level +1. However, these presumptions were not supported by the confirmation runs that we carried out later, see section 4.

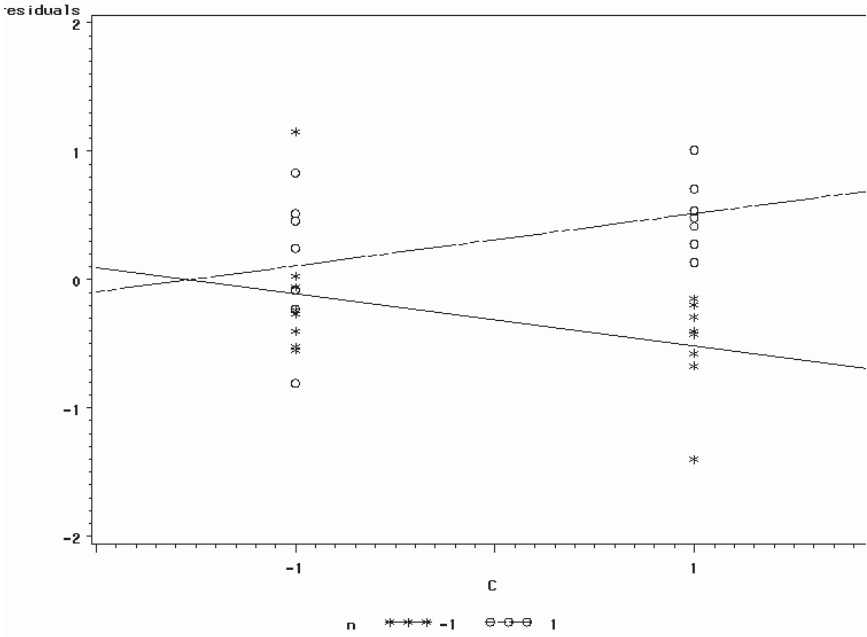

Figure 7: Interaction Plot C:n from the product array. The residuals from the means of the noise arrays are added to the graph.

Hence, from our search for control factors, we draw the following conclusions:
 While the classical analysis simply states that D has an effect on the variance, we had hoped that the interaction analysis would give some more insight why this might be the case. However, it did not make things much clearer.

3. Analysis of the Combined Array

The observations of the combined array are displayed in Table 9. The design of the combined array used in our study is taken from the tables in Wu and Zhu (2001). The design is constructed as follows. We start with a complete 2^5 -design in the factors A, B, C, D, and E. Then factor F is confounded with A:B:C, m with A:B:D, n with A:C:D and o is confounded with B:C:D:E.

A	B	C	D	E	F	m	n	o	A20
-	-	-	-	-	-	-	-	-	4.89
-	-	-	-	+	-	-	-	+	4.73
-	-	-	+	-	-	+	+	+	5.29
-	-	-	+	+	-	+	+	-	5.28
-	-	+	-	-	+	-	+	+	5.91
-	-	+	-	+	+	-	+	-	6.01
-	-	+	+	-	+	+	-	-	4.54
-	-	+	+	+	+	+	-	+	5.30
-	+	-	-	-	+	+	-	+	4.16
-	+	-	-	+	+	+	-	-	3.96
-	+	-	+	-	+	-	+	-	4.05
-	+	-	+	+	+	-	+	+	3.98
-	+	+	-	-	-	+	+	-	3.28
-	+	+	-	+	-	+	+	+	3.24
-	+	+	+	-	-	-	-	+	2.18
-	+	+	+	+	-	-	-	-	2.52
+	-	-	-	-	+	+	+	-	5.83
+	-	-	-	+	+	+	+	+	6.19
+	-	-	+	-	+	-	-	+	5.54
+	-	-	+	+	+	-	-	-	5.77
+	-	+	-	-	-	+	-	+	3.04
+	-	+	-	+	-	+	-	-	3.08
+	-	+	+	-	-	-	+	-	3.90
+	-	+	+	+	-	-	+	+	3.77
+	+	-	-	-	-	-	+	+	1.44
+	+	-	-	+	-	-	+	-	2.52
+	+	-	+	-	-	+	-	-	2.66
+	+	-	+	+	-	+	-	+	1.55
+	+	+	-	-	+	-	-	-	4.67
+	+	+	-	+	+	-	-	+	4.08
+	+	+	+	-	+	+	+	+	5.14
+	+	+	+	+	+	+	+	-	4.79

Table 6: The data from the combined array

If we assume that the only relevant effects are main effects and first order interactions, then the confounding structure of the combined array is as follows:

The main effects

A, B, C, D, E, F, m, n, o

are clear, for the two-factor interactions we have

$A:B = C:F = D:m$, $A:C = B:F = D:n$, $A:D = B:m = C:n$, $A:F = B:C = m:n$, $A:m = B:D = F:n$,

$A:n = C:D = F:m$, $B:n=C:m =D:F$,

while

$A:E$, $B:E$, $C:E$, $D:E$, $E:F$, $E:m$, $E:n$, $A:o$, $B:o$, $C:o$, $D:o$, $E:o$, $F:o$, $m:o$, $n:o$

are clear.

Note that this way we had some two factor interactions between design factors and noise factors confounded with some other two-factor interactions. Before the experiment was run, we had expected that o should be the most important noise factor. This is why we wanted to get the interactions with o clear. The advantages of the design compared to the product array lie in the fact that none of the main effects is confounded with a two-factor interaction. Furthermore, there are no contrasts that are only used for three-factor interactions, which we expected to be all negligible.

As a first step of the analysis, we should decide whether to transform the data. One possibility would be to choose the transformation where we have as few interactions as possible. We decided, however, to leave the data untransformed for this experiment. (This decision was supported by the results for the product array – although this is not strictly in agreement with our intention to do separate analyses).

Table 7 lists all 32 estimates that we derived from these data. They are sorted according to their absolute sizes.

Name	Inter-									
cept	F	B	A:F	n	A	A:D	A:C	A:B	F:o	
Size	4.17	0.83	-0.78	0.42	0.25	-0.17	0.17	0.14	0.13	0.11
m:o	B:o	A:o	B:n	C	o	B:E	C:o	E:n	A:n	m
0.10	-0.10	-0.09	-0.08	-0.07	-0.07	-0.07	0.06	0.05	-0.05	0.04
E:m	A:E	D:E	n:o	D	D:o	E	E:F	A:m	E:o	C:E
-0.04	-0.04	-0.03	0.03	-0.02	0.02	0.01	0.01	-0.01	0.00	0.00

Table 7: Estimated size of the effects in the combined array

The half-normal plot in Figure 8 is derived from the estimates of all 31 contrasts in Table 7. It shows that F , B , $A:F$ and n are significant. Like in the interaction analysis of the product array, it is based on 31 independent estimates and gives about 20 degrees of freedom for the ASE, which equals 0.09 here. We hence might again consider all those factors as important for which the estimate is at least $1.72 \times ASE = 0.17$. This makes us add A and $A:D$ to the list of possibly active factors.

For the two presumably important interactions we have the alias-structures

$A:F = B:C = m:n$, and $A:D = B:m = C:n$.

F is clearly active, while we have hints that A is also active. This makes it plausible that the size of the estimate for the interaction $A:F$ is truly due to $A:F$, rather than $B:C$ or $m:n$. For the

interaction A:D, we have no immediate interpretation. For each of the three confounded interactions there is just one factor which appears to have a main effect. However, if C:n was active C would be a possible control factor.

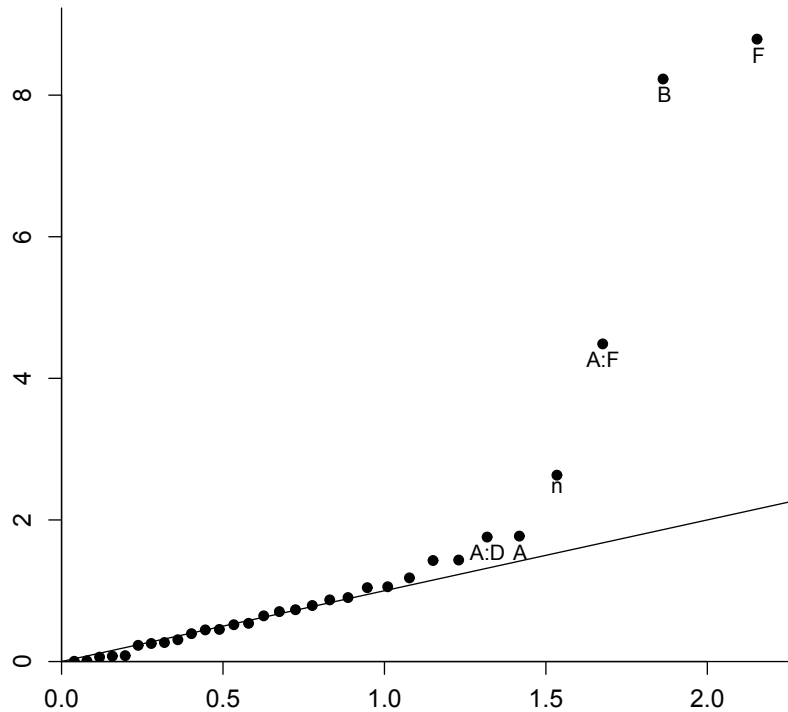

Figure 8: Half-normal plot for the data from the combined array

Before searching for control factors, however, we search for a setting of the design factors that minimises the mean of A_{20} over the noise factors (i.e. the noise-factors m, n and o can be neglected for this aim).

If we think that F, B, A:F, n, A and A:D are active, we therefore would choose the setting in Table 8, where the setting of factor E could be changed if convenient.

A	B	C	D	E	F
+	+	-	-	(-)	-

Table 8: A second setting to minimize the mean, derived from the combined array

We have fixed the setting of C at the level -1 because of the possibility that the size of A:F may be due to B:C.

For this setting we get the prediction

$$A_{20}\text{-pred} = 4.17 + A + B - F - A:F - A:D = 4.17 - 0.17 - 0.78 - 0.83 - 0.42 - 0.17 = 1.80.$$

For a run with this setting of the design factors, the outcome should depend on the setting of the noise factor n. Hence, we would predict to observe $1.80 + 0.25 = 2.05$ if n is at +, while we expect $1.80 - 0.25 = 1.55$ if n is at level -1 .

Do we find hints from the combined array that there are control factors?

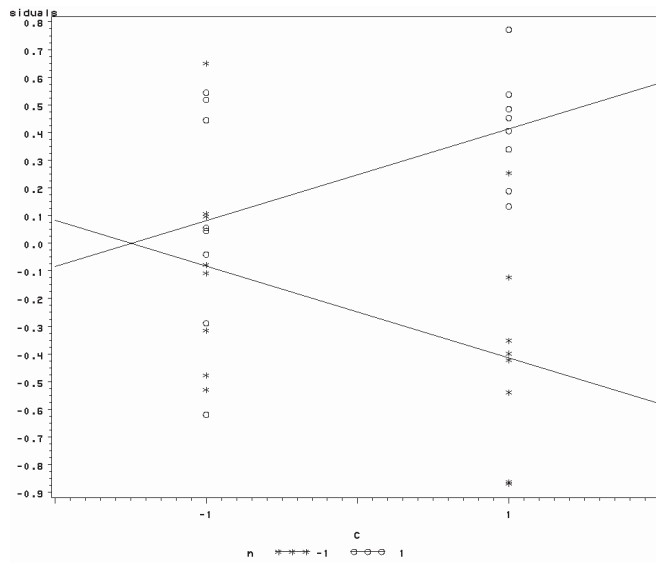

Figure 9: Combined Array. Interaction Plot C:n with the residuals after fitting the design factors A, B, C, D, E, F and the interaction A:F

The most likely candidate seems to be factor C, which possibly has an interaction with the noise factor n, if the size of A:D is due to C:n. The interaction plot in Figure 9 shows that then the means of the observations with n at + and with n at - are nearer to each other if C is at -. We have also included in the graph the residuals after fitting the main effects of all design factors and the significant interaction A:F. From this graph, we get the impression that the variance might get smaller if we changed C from + to -.

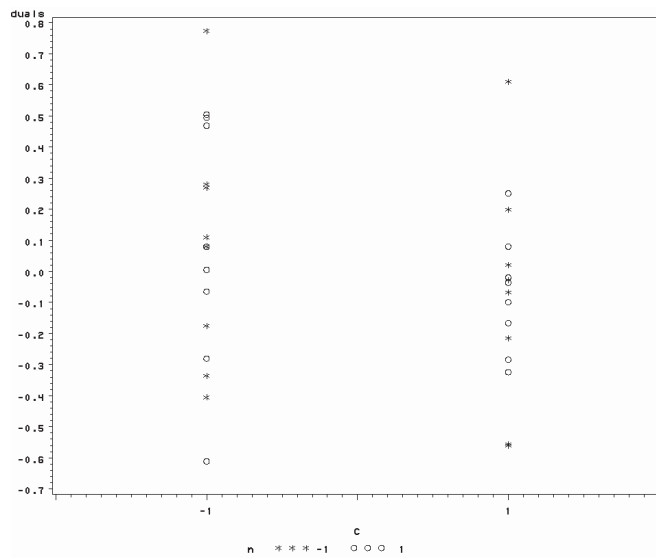

Figure 10: Influence of C on the variance in the combined array. Residuals from the model which explains A_{20} by F, B, A:F, n, A, A:D

However, this does not give an unbiased estimate of what the variances will be for the different settings of C since the noise factors do not have exactly the same settings for C at + and for C at -. Hence, the estimate of variance may be biased. Following the arguments of Box and

Meyer (1986), we have to correct for all important effects before looking at the residual variance. Therefore we should look at the residuals that we get if the model with factors F, B, A:F = B:C, n, A, A:D = C:n is fitted.

For these residuals, displayed in Figure 10, we observe an empirical variance of 0.145 if C is at – and of 0.086 for C at +. Hence, these two graphs together seem to indicate that there are two opposing effects for factor C: The means of the observations with n at + and n at – are nearer to each other if C is at –. However, the residuals appear to have a slightly smaller variance if C is at +. It is hard to guess what is the net effect of factor C on the variance. However, C seems to be a candidate for a control-factor, that might introduce a smaller variance if C is at level –.

The analysis of the combined array so far provides no hints that factor D might have an influence on the variance. However, the relatively large interaction A:C is confounded with D:n. Hence it might be of interest to draw the same plots for D that we have done for C in Figures 9 and 10. Here we find that the difference between the means of the runs with n at – and the runs with n at + is smaller if D is at –, see Figure 11.

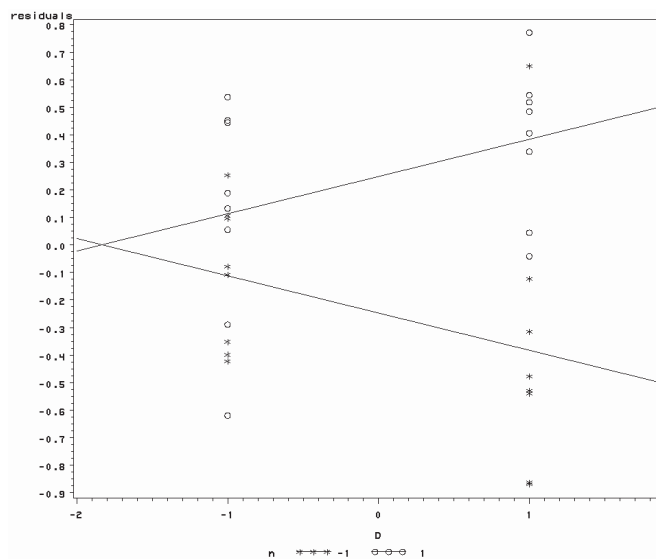

Figure 11: Combined Array. Interaction Plot D:n with the residuals after fitting the design factors A, B, C, D, E, F and the interaction A:F

This graph seems to indicate that D also has a smaller variance if it is at level –. It should, however, be kept in mind that D:n is confounded with A:C. Therefore, the plot in Figure 11 looks exactly the same, whether the interaction A:C is active or whether the interaction D:n is active.

To see a possible influence of D on the residual variance, we consider the residuals after fitting all the significant factors from the half-normal plot. These residuals are displayed in Figure 12. Here we find that the empirical variance of the residuals is 0.09 if D is at – and 0.15 if D is at +.

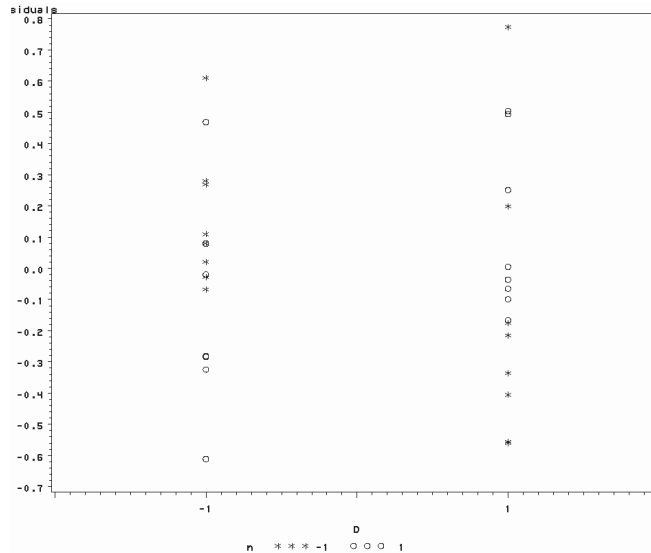

Figure 12: Influence of D on the variance in the combined array. Residuals from the model which explains A_{20} by F, B, A:F, n, A, A:D

These two graphs make it plausible that D might have an influence on the variance, with smaller variance if D is at level $-$.

4. Confirmation runs

If we compare the alias-structures of the two designs, we find that the largest contrasts (ordered according to size) are very similar, see Table 9.

Product Array		Combined Array	
size	Alias-structure	size	Alias-structure
0.88	F = A:C = B:D	0.83	F
-0.84	B = C:E = D:F	-0.78	B
0.63	E = A:D = B:C	0.42	A:F = B:C = m:n
0.31	n = -m:o	0.25	n
0.20	C:n	-0.17	A=C:D:n
0.18	E:o	0.17	A:D = B:m = C:n
-0.18	A:B:n = C:D:n = E:F:n		

Table 9: The largest contrasts from the two designs

It seems obvious that the largest two contrasts in both designs are due to the main effects F and B. It also seems evident that the third largest contrast should be due to B:C. It is of interest, though, that B:C appears to be a lot smaller for the combined array than for the product array. An advantage of the combined array becomes directly visible, however: It is clear that the main effect of factor E is not active.

The fourth contrast in both designs is due to n. The fifth contrast in the product array and the sixth contrast in the combined array appear to be due to C:n. Noting that the three-factor interaction C:D:n in the combined array is confounded with A makes it plausible that the seventh contrast in the product array and the fifth contrast in the combined array are due to

C:D:n. This only leaves E:o unresolved. Note that E:o is estimated as 0.00 in the combined array. The two experiments on their own provide no convincing arguments why E:o is present in one design and absent in the other.

How about the variance? Here we have a striking difference. We concluded from the classical analysis of the product array that factor D should have an influence on the variance, with smaller variance if D is at +. From the combined array, we had hints that the effect of D should be the other way round, a smaller variance if D is at -.

For C the analysis of both designs makes it plausible that there is a smaller effect of n if C is at -, but that there may be a smaller residual variance if C is at +.

To check which predictions are valid, we did two series of confirmation experiments. Immediately after the experiments, we did a first series of confirmation runs, to check the predictions for the means. Table 9 contains the settings and the results for this first series. Unfortunately, these runs were not all done at the settings we had intended. We report their results for the sake of completeness.

run no.	A	B	C	D	E	F	m	n	o	A ₂₀
1	-	+	-	+	-	-	-	-	+	1.61
2	-	+	-	+	-	-	+	+	-	3.26
3	-	+	-	+	-	-	+	+	-	2.78
4	-	+	-	+	-	-	+	+	+	2.60
5	-	+	-	-	-	-	-	-	-	1.58
6	-	+	-	-	-	-	-	-	+	1.03
7	-	+	-	-	-	-	+	+	-	3.18
8	-	+	-	-	-	-	+	+	+	2.50
9	+	+	-	-	-	-	-	-	-	1.42
10	+	+	-	-	-	-	+	+	+	1.34
11	+	+	+	+	-	-	-	-	-	2.71
12	+	+	+	+	-	-	+	+	+	3.84

Table 9: The first set of confirmation runs

The first four runs are at the setting of the design factors in Table 3 that was found in the product array. For the second group of four runs the setting of factor D was changed. We had originally wanted to do one run of the outer array for each of these two settings. Unfortunately, due to an error, we did the runs 1 to 8 displayed in Table 9 instead.

The runs 9 and 10 were at the setting in Table 8, proposed by the combined array. For the runs 11 and 12 we changed the setting of both C and D. If B:C was not present, they should give similar values as 9 and 10. Hence, runs 11 and 12 are (additional) hints that B:C is active.

An interesting point in Table 9 is that runs 9 and 10 give smaller observations of A₂₀ than the runs at the recommended setting from the product array. We first thought that this should be due to the main effect of factor A. Note that runs 9 and 10 differ from 5 and 8 only in the

setting of A. With hindsight, however, we think that this difference is due to the interaction A:C, see below.

The fact that run 10 had a smaller A_{20} than run 9 (in spite of the large effect of n) can be explained if we assume that C:n and C:D:n are active. However, this cannot explain why there is a much larger A_{20} in run 8 than in run 5. One explanation may be random fluctuation. Note that run 9 was also done in the combined array, when it produced an A_{20} of 2.97. (All other runs from both sets of confirmation experiments were not done in the product array or the combined array.)

A	B	C	D	E	F	m	n	o	A_{20}
-	+	-	+	-	-	-	-	-	2.10
-	+	-	+	-	-	-	+	+	2.55
-	+	-	+	-	-	+	-	+	1.65
-	+	-	+	-	-	+	+	-	2.31
-	+	-	+	-	-	-	-	-	1.84
-	+	-	+	-	-	-	+	+	2.76
-	+	-	+	-	-	+	-	+	1.90
-	+	-	+	-	-	+	+	-	2.61
-	+	-	-	-	-	-	-	-	1.91
-	+	-	-	-	-	-	+	+	1.64
-	+	-	-	-	-	+	-	+	1.06
-	+	-	-	-	-	+	+	-	2.55
-	+	-	-	-	-	-	-	-	1.68
-	+	-	-	-	-	-	+	+	1.58
-	+	-	-	-	-	+	-	+	1.03
-	+	-	-	-	-	+	+	-	2.43
-	+	+	+	-	-	-	-	-	2.45
-	+	+	+	-	-	-	+	+	2.77
-	+	+	+	-	-	+	-	+	2.14
-	+	+	+	-	-	+	+	-	2.90
-	+	+	+	-	-	-	-	-	2.76
-	+	+	+	-	-	-	+	+	2.71
-	+	+	+	-	-	+	-	+	2.29
-	+	+	+	-	-	+	+	-	3.46
-	+	+	-	-	-	-	-	-	2.80
-	+	+	-	-	-	-	+	+	3.37
-	+	+	-	-	-	+	-	+	2.36
-	+	+	-	-	-	+	+	-	4.57
-	+	+	-	-	-	-	-	-	2.58
-	+	+	-	-	-	-	+	+	3.43
-	+	+	-	-	-	+	-	+	2.44
-	+	+	-	-	-	+	+	-	4.58

Table 10: Eight confirmation runs of the noise array at the recommended setting from the product array

The most interesting question, however, was to find out whether factor D has an effect on the variance or not. We therefore decided to do a second confirmation study to consider the variance. In this study we checked the four possible combinations of C and D, and did two runs of the complete noise array at each of them. For the other factors we chose the setting proposed in Table 3. This gave another 32 runs, the results of which are displayed in Table 10.

Table 11 reports the means that we have observed over these noise arrays, two for each setting of the design factors.

A	B	C	D	E	F	mean1	mean 2
-	+	-	-	-	-	2.15	2.28
-	+	-	+	-	-	1.79	1.68
-	+	+	-	-	-	2.56	2.80
-	+	+	+	-	-	3.27	3.26

Table 11: The means of the eight runs of the noise array in the confirmation experiment

From the classical analysis of the product array, all 8 means should be near 1.71. The fact that the last four means in Table 11 are larger can be explained by B:C.

The confirmation experiments gave means of 2.15 and of 2.28 for the two arrays which were run for exactly the setting in Table 3. This is not as good as predicted. They are even outside the prediction interval derived in Section 2.

From our analysis of the data in the product array, we would have no explanation why the mean observation of these confirmation runs was not as good as predicted. Again, the comparison with the combined array makes it plausible at first sight that this should be due to the effect of factor A. If, however, we change D to +, this gives means of 1.79 and 1.68. Quite surprisingly, both are very near the predicted value of 1.71. Note that there were no indications of a main effect of D or an interaction C:D, neither from the product array nor the combined array. An attempt to explain which factors are active will follow below.

Calculating the variances over the eight noise arrays in Tables 10, we get the results displayed in Table 12.

A	B	C	D	E	F	Variance1	Variance 2
-	+	-	-	-	-	0.38	0.33
-	+	-	+	-	-	0.15	0.23
-	+	+	-	-	-	0.92	0.97
-	+	+	+	-	-	0.12	0.23

Table 12: Empirical variances over the noise array in the confirmation experiments

These results are striking. They clearly support the prediction that D at + should reduce the variance. Note that the four smallest variances appear when D is at +. This cannot be explained by chance alone.

The variances in this confirmation experiment agree very well with the findings of our product array, when we had observed variances 0.35, 0.52, 1.10, 0.69 for D at level –, and 0.16, 0.13, 0.22, 0.17 for D at level +.

Is there an explanation why D has an influence on the variance, and why we could not see it from the combined array?

Since each run in this confirmation experiment is done twice, we could estimate the variance of the pure error by taking half the squared difference between the two observations. For the four factor combinations of C and D considered in the confirmation experiment, we estimated the variance of the pure error, by averaging over the four differences. This gave the results in Table 13.

C	D	pure error
–	–	0.009
–	+	0.033
+	–	0.007
+	+	0.054

Table 13: Confirmation Experiments: Estimated pure error

The results of Table 13 show that the pure error does not provide an explanation for the effect of D on the variance. In fact, D seems to increase the variance of the pure error when set at +, as expected from the analysis of the combined array. Note that the effect of factor C on the residual variance is a lot smaller.

Therefore, there must be some factors and interactions that do the trick. The confirmation experiment in Table 10 provides sufficiently many observations to fit the linear model that tries to explain A_{20} as a function of C, D, C:D, m, n, o, C:m, D:m, C:D:m, C:n, D:n, C:D:n, C:o, D:o, C:D:o, with 16 degrees of freedom for the estimation of the variance.

Name	Intercept	C	n	C:D	o	D:o	C:D:n	D:n
Size	2.48	0.50	0.41	-0.27	-0.25	0.14	-0.12	-0.10
D:m	C:n	C:m	C:D:o	m	D:o	D	C:D:m	
-0.08	0.08	0.07 (n.s.)	-0.06 (n.s.)	0.04 (n.s.)	-0.04 (n.s.)	-0.03 (n.s.)	-0.02 (n.s.)	

Table 14: Estimated effects from the second confirmation experiment

The estimates derived from this model are listed in Table 14. Except where marked by (n.s.), these effects are significant at the 1% level. In the light of both experiments, it seems surprising at first sight, that the factor C is so large here. However, note that factors A, B, E and F are kept constant during the whole confirmation study, with A, E and F at level – and B at +. Therefore, C is confounded with B:C and a large size of C had to be expected.

How about the other effects? At least those factors that are larger than 0.20 should also be visible in the proper experiments. This clearly is the case for n. Why did we never see C:D? In the product array C:D is confounded with A:B, which was estimated as 0.05, in the combined array C:D is confounded with A:n, which was estimated as -0.05. So it seems that the interaction C:D is not really active. The most reasonable explanation is that the C:D observed in the confirmation experiment is one of the three factor interactions confounded with it, -A:C:D, B:C:D, -E:C:D or -F:C:D. Since B:C is so important, we think it might be B:C:D, which is confounded with A in the product array and with E:o in the combined array. This, nicely explains the absence of E:o in the product array. However, we then need an explanation why A is not present in the product array.

After some search, we think we have found a model that gives a possible explanation for the results of all four series of experiments. In addition to the general mean, this model assumes 3 active main effects, 7 active two-factor interactions and 3 active three-factor interactions. They are listed, with their approximate sizes, in Table 15.

Source	Intercept	F	B	B:C	n	E:o	B:C:D
Size	4.10	0.80	-0.80	0.70	0.40	0.20	-0.20
C:F	A:C	E:D:o	C:D:n	C:n	D:n	D:m	
0.20	0.20	-0.15	-0.10	0.10	-0.10	-0.10	

Table 15: A model to explain the results of our experiments

For the product array, this model would make us expect to estimate the contrasts as displayed in Table 16. With the exception of D:m, we find that all estimates are quite near the predicted values from the model. Remember that the ASE for these estimates was equal to 0.09.

For the combined array we get the predicted and observed estimates in Table 17. Here we get a satisfactory fit for all estimates with the possible exception of n. We also get a plausible explanation why three of the contrasts are small, although they contain presumably active factors.

Table 18 lists the estimates from the second confirmation experiment and their predictions from the model in Table 15. Here we have some problems with C, while the other predictions fit reasonably well.

Name	Intercept	F	B	E	n	C:n	E:o	A:B:n	B:n	D:m
Source	Intercept	F+A:C	B	B:C	n	C:n	E:o	C:D:n	-	D:m
predicted Size	4.10	1.0	-0.80	0.70	0.40	0.10	0.20	-0.10	0	-0.10
observed Size	4.08	0.88	-0.85	0.63	0.31	0.20	0.18	-0.18	-0.13	0.12

E:n	A:m	F:o	F:n	A:o	B:o	B:m	A	A:B	m	D:o
-	-	-	-	E:D:o	-	-	B:C:D	-	-	-
							+C:F			
0	0	0	0	-0.15	0	0	0.00	0	0	0
0.10	-0.10	0.10	0.09	-0.09	-0.09	0.08	0.06	0.05	-0.05	0.05

A:n	o	C:m	F:m	C:o	E:m	A:B:m	A:B:o	C	D	D:n
-	-	-	-	-	-	-	-	-	-	D:n
0	0	0	0	0	0	0	0	0	0	-0.10
-0.05	-0.04	-0.03	-0.03	-0.03	0.03	-0.02	-0.01	0.01	-0.00	-0.00

Table 16: Product Array. Estimable contrasts with their observed size from the interaction analysis and their prediction from the model in Table 15

Name	Intercept	F	B	A:F	n	A	A:D	A:C	A:B	F:o
Source	Intercept	F	B	B:C+	n	C:D:n	C:n	A:C+	D:m+	-
				E:D:o				D:n	C:F	
predicted Size	4.10	0.80	-0.80	0.55	0.40	-0.10	0.10	0.10	0.10	0
observed Size	4.17	0.83	-0.78	0.42	0.25	-0.17	0.17	0.14	0.13	0.11

m:o	B:o	A:o	B:n	C	o	B:E	C:o	E:n	A:n	m
-	-	-	-	-	-	-	-	-	-	-
0	0	0	0	0	0	0	0	0	0	0
0.10	-0.10	-0.09	-0.08	-0.07	-0.07	-0.07	0.06	0.05	-0.05	0.04

E:m	A:E	D:E	n:o	D	D:o	E	E:F	A:m	E:o	C:E
-	-	-	-	-	-	-	-	-	E:o+	-
									B:C:D	
0	0	0	0	0	0	0	0	0	0.00	0
-0.04	-0.04	-0.03	0.03	-0.02	0.02	0.01	0.01	-0.01	0.00	0.00

Table 17: Combined Array. Estimable contrasts with their observed size and their prediction from the model in Table 15

Name	Intercept	C	n	C:D	o	D:o	C:D:n
Source	Intercept	B:C-A:C	n	B:C:D	-E:o	-E:D:o	C:D:n
	-F+B	-C:F					
predicted Size	2.50	0.30	0.40	-0.20	-0.20	0.15	-0.10
observed Size	2.48	0.50	0.41	-0.27	-0.25	0.14	-0.12

D:n	D:m	C:n	C:m	C:D:o	m	D:o	D	C:D:m
D:n	D:m	C:n	-	-	-	-	-	-
-0.10	-0.10	0.10	0	0	0	0	0	0
-0.10	-0.08	0.08	0.07	-0.06	0.04	-0.04	-0.03	-0.02

Table 18: Second confirmation experiment. Estimable contrasts with their observed size and their prediction from the model in Table 15

The first confirmation experiment was not designed to produce estimates. We therefore used the model in Table 15 to predict the observations in the single runs. This gave predictions 2.25, 2.55, 2.55, 2.45, 2.05, 1.35, 2.65, 1.95, 1.65, 1.55, 2.95 3.05 for runs 1 to 12 of Table 10, respectively. We think that this is a reasonable fit to the single observations, if one remembers that the variance of the single observations is larger than the variance of the estimates.

Finally, we observe that the effect on the variance can be explained if we are willing to accept this model. Fitting the observations from the second confirmation experiment and calculating the variances from these, we predict the variances as displayed in Table 19.

C	D	fitted variance
-	-	0.30
-	+	0.14
+	-	0.83
+	+	0.14

Table 19: Second Confirmation Experiment: Estimated variance over the noise array

This agrees quite well with the observed variances. We therefore think that the discrepancies between the results of the combined array and the product array come from the fact that there was an important three-factor interaction that we did not consider in the combined array and a number of two-factor interactions that are not large enough to be significant.

5. Conclusions

In our experiment, we managed to identify a control factor with the help of the classical analysis of the data from the product array. We did not manage to identify this factor with the interaction analysis. From our analysis of the combined array, we even expected quite the opposite effect of D.

The confirmation study supported the findings of the classical analysis. It also provided a plausible interpretation of why D has this effect. This interpretation involved a relatively large number of two- and three-factor interactions. This, however, might turn out to be important. The interaction analysis cannot deal in a satisfactory manner with a large number of active interactions, especially if some of them involve three factors.

In the authors' opinion, the experiment has shown one advantage of the product array and the classical analysis that should not be neglected: We managed to identify an important aspect of the process, without understanding what was really going on.

Since we did not expect three factor interactions, we did not see the effect on the variance with the interaction analyses that needed more model assumptions. It seems that the product array and the classical analysis is more robust to invalid model assumptions.

Acknowledgement:

Financial support of the Deutsche Forschungsgemeinschaft (SFB 475, Reduction of complexity in multivariate data structures) is gratefully acknowledged.

References:

- Box, G.E.P. (1988): Signal-to-Noise Ratios, Performance Criteria, and Transformations. *Technometrics* 30, 1 - 17.
- Box, G.E.P. and Meyer, R.D. (1986): Dispersion Effects from Fractional Designs. *Technometrics* 28, 19 - 27 (Correction: *Technometrics* 29 (1987), 250)
- Engel, J. (1992): Modelling Variation in Industrial Experiments. *Applied Statistics* 41, 579 - 593
- Göbel, R., Auer, C., Erdbrügge, M. (2002): Comparison of Multivariate Methods for Robust Parameter Design in Sheet Metal Spinning. *ENBIS Conference*, 23-24 September, 2002, Rimini, Italy.
- Göbel, R.; Erdbrügge, M.; Kunert, J.; Kleiner, M. (2001): Multivariate optimisation of the metal spinning process in consideration of categorical quality characteristics. *ENBIS Conference*, 17-18 September, 2001, Oslo, Norway.
- Grize, Y. L. (1995): A Review of Robust Process Design Approaches. *Journal of Chemometrics* 9, 239-262.

- Kunert, J. (1997): On the use of the factor-sparsity assumption to get an estimate of the variance in saturated designs. *Technometrics* 39, 81 - 90
- Kunert, J. und Lehmkuhl, F. (1998): The generalized β - method in Taguchi experiments. *MODA 5 - Advances in Model-Oriented Data Analysis*. A.C. Atkinson, L. Pronzato, H.P. Wynn (eds.), Physica Verlag (1998), 223 - 230
- Logothetis, N. (1990): Box-Cox transformation and the Taguchi method. *Applied Statistics* 39, 31-48.
- Myers, R.H., Khuri, A.I, and Vining, G. (1992): Response Surface Alternatives to the Taguchi Robust Parameter Design Approach. *The American Statistician* 46, 131-139
- Shoemaker, A.C., Tsui, K.-L., and Wu, C.F. J. (1991): Economical Experimentation Methods for Robust Design. *Technometrics* 33, 415 - 427
- Shoemaker, A.C., and Tsui, K.-L. (1993): Response Model Analysis for Robust Design Experiments. *Commun. Statist. – Simula* 22, 1037-1064
- Steinberg, D.M., and Bursztyn, D. (1994): Dispersion Effects in Robust-Design Experiments with Noise Factors. *Journal of Quality Technology* 26, 12-20
- Steinberg, D.M., and Bursztyn, D. (1998): Noise Factors, Dispersion Effects and Robust Design. *Statistica Sinica* 8, 67-85
- Taguchi, G. and Wu, Y. (1985): *Introduction to Off-line quality control*. Central Japan Quality Control Association, Tokyo
- Wu, C.F.J. and Zhu, Y. (2001): Optimal selection of single arrays for parameter design experiments. *Statistica Sinica*, to appear

Appendix: Some engineering background for sheet metal spinning.

Sheet metal spinning is a very old manufacturing process which is used to form various metals into axially symmetric hollow bodies, such as parts for the chemical, lamp, automotive or aerospace industry. Some typical products are shown in Figure A1.

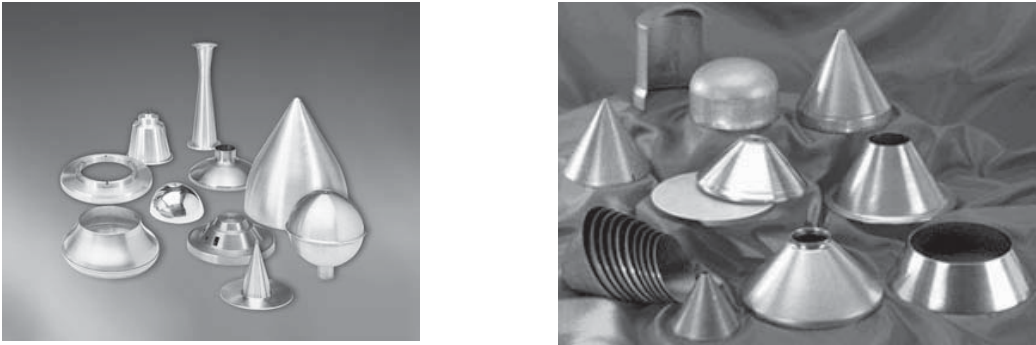

Figure A1: Typical products formed by sheet metal spinning

Figure A2 visualises the principle of the process and the progress of forming the workpiece. The roller tool operates locally on a so-called "partial deformation zone". The sheet metal blank rotates and is progressively formed during multiple passes until it fits to the geometry of the spinning mandrel. To prevent the occurrence of wrinkling, an additional blank supporting tool is used.

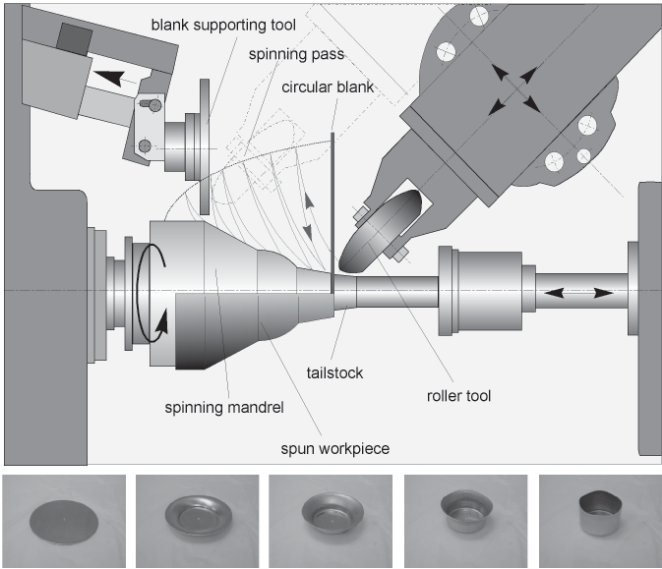

Figure A2: Principle of the sheet metal spinning process

The quality of the process is measured by different response variables. In earlier work, we derived statistical models for the dependencies of several of these quality characteristics on the process parameters, see Göbel, Erdbrügge, Kunert and Kleiner (2001) and Göbel, Auer and Erdbrügge (2002). In that work, we concentrated mainly on the depth of the cup and the

reduction in diameter of the workpiece, both measured after the first few passes, and the quality failures wrinkling and cracking. We managed to find parameter settings which were reasonably good in the first two criteria while avoiding wrinkling or cracking.

In the present experiment, the variable of interest is wall thickness, which should be as uniform as possible. In every forming stage, the material is shifted by the roller tool, leading to a typical gradient of the wall thickness as shown in Figure A3. Since a high reduction of the wall thickness limits the usability of the product, it is an important quality characteristic of the spinning process.

We measure the reduction of thickness by the area A_{20} between the initial thickness t_0 and the sheet thickness. Because of differences in the length of the formed cup, the area is normalized to a length of 100 mm or 20 measurement points, respectively.

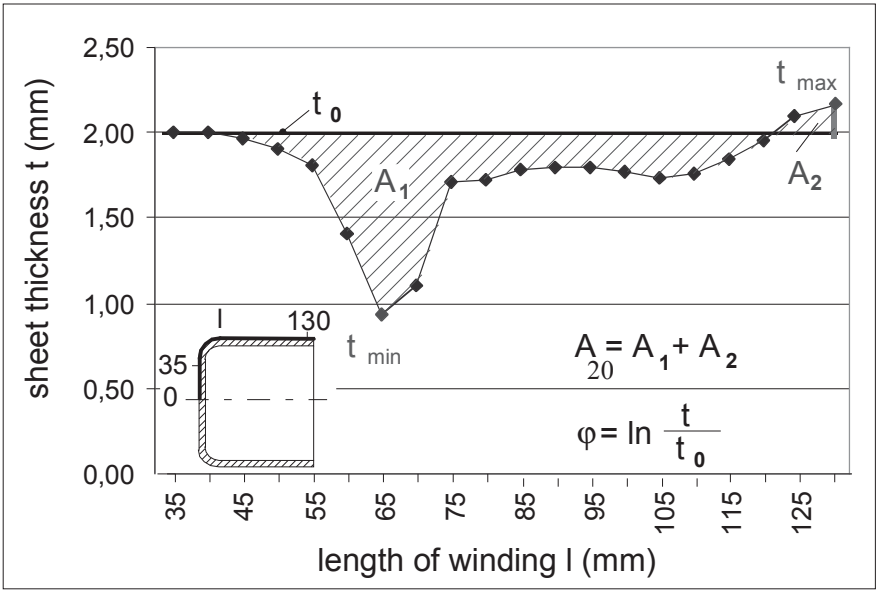

Figure 4: Typical curve of the sheet thickness and definition of describing parameters

The results of our earlier work were used to define an experimental region in which we expected nearly no wrinkling or cracking, but a strong depth of the formed cup as well as a strong reduction of the initial sheet diameter.

For all runs of the experiment, a cylindrical cup with an inner diameter of 100mm was formed. The circular blanks had a diameter of 230mm and had a sheet thickness of 2mm. The material of the circular blanks consisted of different aluminium alloys. Only the first forming stages were considered, with an overall axial feed of the roller tool of 42mm. The roller tool and the blank supporting tool were identical for all runs. The feed rate was set to 1mm/rev. The critical failures wrinkling and cracking in fact occurred only rarely in our experiment.

Six design factors, describing the geometry of the spinning passes, were used for the experiment. For each of these design factors a high and a low level was defined, see Table A1.

	Design factors	Unit	-1	+1
A	Number of passes	[---]	4	8
B	Geometry of the path to the rim of the workpiece	[---]	concave	convex
C	Radius of the path to the rim of the workpiece	[mm]	100	300
D	Geometry of the path to the inside of the workpiece	[---]	concave	convex
E	Radius of the path to the inside of the workpiece	[mm]	100	300
F	Ending point of the tool path	[---]	10%	40%

Table A1: Design factors used in the experimental design

There were three noise factors, two of which define differences in the raw material. While factor m indicated two alloys of different hardness, the factor n was created by using heating to introduce artificial ageing (and therefore softening) of the workpieces. Additionally, the accuracy of the detection of the rim of the circular blank was introduced as a third noise factor o. For an optimal forming process it is desirable to design the path of the roller tool in such a way that it exactly reaches the rim of the blank. If the tool moves too far, it loses contact and the workpiece is damaged during the reverse motion. If the tool reverts too early, a thick unformed region develops and will be shifted by the roller tool in the next forming steps. This may result in a reduction of sheet thickness in other regions of the workpiece. But the location of the rim is affected by a large number of parameters and is very hard to determine before the process is actually run. All three noise factors are summarised in Table A2.

	Noise factors	Unit	-1	+1
m	Alloy	[---]	AlMg1	AlMg3
n	Heating	[---]	Yes	No
o	Endpoint of the path at the rim of the workpiece	[mm]	-6	0

Table A2: Noise factors used in the experimental design