

Rosellón, Juan; Vogelsang, Ingo; Weigt, Hannes

Working Paper

Long-run cost functions for electricity transmission

DIW Discussion Papers, No. 1020

Provided in Cooperation with:

German Institute for Economic Research (DIW Berlin)

Suggested Citation: Rosellón, Juan; Vogelsang, Ingo; Weigt, Hannes (2010) : Long-run cost functions for electricity transmission, DIW Discussion Papers, No. 1020, Deutsches Institut für Wirtschaftsforschung (DIW), Berlin

This Version is available at:

<https://hdl.handle.net/10419/46204>

Standard-Nutzungsbedingungen:

Die Dokumente auf EconStor dürfen zu eigenen wissenschaftlichen Zwecken und zum Privatgebrauch gespeichert und kopiert werden.

Sie dürfen die Dokumente nicht für öffentliche oder kommerzielle Zwecke vervielfältigen, öffentlich ausstellen, öffentlich zugänglich machen, vertreiben oder anderweitig nutzen.

Sofern die Verfasser die Dokumente unter Open-Content-Lizenzen (insbesondere CC-Lizenzen) zur Verfügung gestellt haben sollten, gelten abweichend von diesen Nutzungsbedingungen die in der dort genannten Lizenz gewährten Nutzungsrechte.

Terms of use:

Documents in EconStor may be saved and copied for your personal and scholarly purposes.

You are not to copy documents for public or commercial purposes, to exhibit the documents publicly, to make them publicly available on the internet, or to distribute or otherwise use the documents in public.

If the documents have been made available under an Open Content Licence (especially Creative Commons Licences), you may exercise further usage rights as specified in the indicated licence.

Discussion Papers

1020

Juan Rosellón • Ingo Vogelsang • Hannes Weigt

**Long-Run Cost Functions for Electricity
Transmission**

Berlin, June 2010

Opinions expressed in this paper are those of the author(s) and do not necessarily reflect views of the institute.

IMPRESSUM

© DIW Berlin, 2010

DIW Berlin
German Institute for Economic Research
Mohrenstr. 58
10117 Berlin
Tel. +49 (30) 897 89-0
Fax +49 (30) 897 89-200
<http://www.diw.de>

ISSN print edition 1433-0210
ISSN electronic edition 1619-4535

Available for free downloading from the DIW Berlin website.

Discussion Papers of DIW Berlin are indexed in RePEc and SSRN.
Papers can be downloaded free of charge from the following websites:

http://www.diw.de/de/diw_01.c.100406.de/publikationen_veranstaltungen/publikationen/diskussionspapiere/diskussionspapiere.html
<http://ideas.repec.org/s/diw/diwwpp.html>
http://papers.ssrn.com/sol3/JELJOUR_Results.cfm?form_name=journalbrowse&journal_id=1079991

Long-Run Cost Functions for Electricity Transmission¹

Juan Rosellón

Centro de Investigación y Docencia Económicas (CIDE) and German Institute for
Economic Research (DIW Berlin)

Ingo Vogelsang

Department of Economics, Boston University

Hannes Weigt

Dresden University of Technology (TU Dresden)

Abstract

Electricity transmission has become the pivotal industry segment for electricity restructuring. Yet, little is known about the shape of transmission cost functions. Reasons for this can be a lack of consensus about the definition of transmission output and the complexity of the relationship between optimal grid expansion and output expansion. Knowledge of transmission cost functions could help firms (Transcos) and regulators plan transmission expansion and could help design regulatory incentive mechanisms. We explore transmission cost functions when the transmission output is defined as point-to-point transactions or financial transmission right (FTR) obligations and particularly explore expansion under loop-flows. We test the behavior of FTR-based cost functions for distinct network topologies and find evidence that cost functions defined as FTR outputs are piecewise differentiable and that they contain sections with negative marginal costs. Simulations, however, illustrate that such unusual properties do not stand in the way of applying price-cap incentive mechanisms to real-world transmission expansion.

Keywords: Electricity transmission, cost function, incentive regulation, merchant investment, congestion management.

JEL-code: L51, L 91, L94, Q40

¹ Earlier versions of this article were presented at the IDEI/Bruegel conference "Regulation, Competition and Investment in Network Industries" in Brussels in 2007 and the IDEI conference "The Economics of Energy Markets" in Toulouse in 2010. We wish to thank Jan Abrell, Christian von Hirschhausen, Thomas-Olivier Leautier, Florian Leuthold, Shmuel S. Oren, and Jean Tirole for their helpful comments.

1 Introduction

Under the restructuring of electricity sectors around the world electricity transmission has been playing a pivotal role. Electricity transmission enables electricity trade within and across countries. It can enhance competition. It can increase the reliability of the electricity system and substitute for lack of generation in certain areas. Congestion and failure of electricity transmission can lead to brownouts and blackouts over large regions. Before restructuring transmission was usually vertically integrated with often large generation companies and sometimes also with distribution companies. More recently, independent transmission entities (Transcos) have been emerging.

All these developments have raised interest in electricity transmission services and led to extensive research studying the economic properties of transmission systems.² We know that electricity transmission differs in many ways from other transportation systems, such as pipelines, railroads or the road system, and from other network industries, such as telecommunications. The physical laws of electricity make transmission complex and unusual. It is therefore not surprising that – to the best of our knowledge - no one so far has characterized a cost function for transmission grids. Two specific reasons appear to be responsible for this lack. One is that there is no full agreement on an obvious output, to which costs could be related. Thus, there may exist cost characterizations for the transmission grid as a set of line capacities, but, in our view, such capacities are definitely not the transmission outputs. The second reason for a lack of cost function characterizations is that the effects of Kirchhoff's laws lead to bewildering irregularities in the relationship between outputs and capacities. An example of such irregularities is the famous Wu et al. (1996) paper on (the pitfalls of) folk theorems on transmission access. As a result transmission cost functions are likely to have strange properties that would make them interesting for an audience outside electricity. Where else can you expect to have negative marginal costs?

Thus, the current paper provides a first characterization of the general shapes of transmission cost functions (based on a more tentative earlier attempt in Hogan, Rosellón and Vogelsang, 2007; in the following: HRV).

Besides satisfying an intellectual curiosity the knowledge about properties of such cost functions can be put to use, among others, as a planning tool for Transcos and regulators. If one knows their cost functions one can plan cost-minimizing transmission systems over a wide range of potential outputs. This would also take care of reliability issues requiring the availability of alternative paths in case of network failures or of unplanned electricity injections at some nodes because of

² Examples include Schweppe et al. (1988), Hogan (1992), Bushnell and Stoft (1996, 1997), Chao and Peck (1996), Oren et al. (1995), Pérez-Arriaga et al., 1995), Rubio-Oldérez and Pérez-Arriaga (2000), Wu et al. (1996), Joskow and Tirole (2000, 2005).

generation failure at other nodes. The knowledge of a transmission cost function could also help assess investments in renewable energies, such as wind power, that may require substantial transmission investments. In addition, the knowledge of transmission cost functions can aid the implementation of incentive mechanisms for transmission investment. We will show that specifically for the HRV mechanism, but it should in principle hold as well for Bayesian mechanisms by using techniques similar to Gasmi et al. (2002).

The regulatory analyses on incentives for electricity transmission expansion postulate transmission cost and demand functions with fairly general properties, and then adapts regulatory adjustment processes to the electricity transmission expansion problem. Under well-behaved cost and demand functions (and assuming a natural monopoly³), appropriate weights (such as Laspeyres weights) grant convergence to equilibrium conditions (Vogelsang, 2001, Tanaka, 2007, Rosellón, 2007, and Léautier, 2000). A criticism of this approach is that the properties of transmission cost and demand functions are little known but are suspected to differ from conventional functional forms (Hogan, 2000, 2002a, Vogelsang, 2006, and HRV, 2007). Hence the assumed cost and demand properties may not hold in a real network with loop-flows since decreasing marginal cost segments and discontinuities in the costs can arise during an expansion project. Furthermore, a conventional linear definition of the transmission output – similar to the output definition for other economic commodities – is in fact difficult since the physical flow through loop-flowed meshed networks is complex and highly interdependent among transactions (Bushnell and Stoft, 1997, and Hogan, 2002a, 2002b).

In this paper, we study long-run electricity transmission cost functions based upon a definition of transmission output in terms of point-to-point transactions or financial transmission right (FTR) obligations. We build on the HRV (2007) model which combines merchant and regulatory approaches in an environment of price-taking generators and loads.⁴ The HRV model also shows that FTR-based cost functions exhibit very normal economic properties in a variety of circumstances. This particularly holds if the topology of all nodes and links is given and only the capacity of lines can be changed, implying that abnormally behaving cost functions require changes to network topology.⁵ We study in more detail these conclusions, and test the behavior of FTR-based cost functions for distinct network topologies. We focus on two basic cases. In the first we

³ Dismukes, Cope III and Mesyanzhinov (1998) empirically show the validity of the natural-monopoly assumption for electricity transmission.

⁴ The model is an extension of Vogelsang (2001) for meshed projects. While designed for Transcos, it can be applied under an ISO setting.

⁵ By a network topology, we mean a set of nodes with their locations and a set of lines with associated impedances between these nodes.

adjust line capacities, but nodes, lines, impedances and thus the power transmission distribution factors (PTDFs) do not change.⁶ This framework allows us to single out the effect of loop-flows on transmission costs. In the second case we allow for changes in line impedances (and thus the PTDFs) correlated to the changes of line capacities. These cases provide insights about the relationship between PTDFs, transmission capacity, and transmission costs.

The plan of the paper is as follows. In Section 2 we discuss the characterization of transmission outputs in terms of FTRs. In Section 3 we address the mathematical cost-function model as well as its adaptation to a computer programming model. In this section, we also describe the dataset used to make simulations as well as the different functional forms to be tested. The results of simulations are presented and discussed for fixed and variable line reactances in Section 4. This section also identifies the challenges associated with consideration of the effects on cost functions of changes in network topology. In Section 5 we illustrate through simulation results how the properties we found for transmission cost functions are conducive to the functioning of the HRV regulatory mechanism. Section 6 concludes.

2 Characterization of Electricity Transmission Outputs

In a vertically separated setting with transmission provided by a stand-alone Transco, the grid is used by generators that want to deliver electricity to load-serving entities (loads, or LSEs), and by entities that want to purchase from generators with or without the help of intermediaries. Transmission makes these transactions possible thus the Transco's chief service is to provide delivery between generation nodes and consumption nodes. Bushnell and Stoft (1997), and Hogan (2002a, 2002b) argue that the definition of the output for transmission is difficult since the physical flow through a meshed transmission network is complex and highly interdependent among transactions.

Under a network with loop flows, outputs could be defined as bilateral trades between pairs of nodes that aggregate to net injections at all nodes. This idea derives from the FTR literature which does not consider transmission activity as an output (or throughput) process, but instead concentrates on "point-to-point" (PTP) financial transactions based on rights, obligations and options (Hogan, 2002b). Physical transmission rights are also discussed in the FTR literature.

⁶ The network topology is described by the network incidence matrix (Léautier, 2000, p. 83). Given the topology there is a set of power transfer distribution factors (PTDF) that govern the flows on the individual lines.

However, as mentioned above tracing the physical flow is impractical. The superiority of FTRs over physical rights has been analytically demonstrated as well (Joskow and Tirole, 2000).⁷

The difference between an FTR and a physical right can be analyzed via a three-node-network setting (see Figure 1). Assuming equal line characteristics, power injected and withdrawn at two nodes within the system (e.g., 9 MW) will cause 2/3 of the energy (6 MW) to flow on the direct connection (n2-n3) and 1/3 (6 MW) will flow over the longer connection (n2-n1, n1-n3). Given a transmission amount of 9 MW the corresponding FTR would be a point-to-point right of 9 MW from node 2 to node 3, whereas the corresponding physical representation would be a 6 MW right for the direct link (n2-n3) and two 3-MW rights for the flow over the other two lines (n2-n1, n1-n3) (Figure 1, case 1). Assuming a second injection-withdrawal pair of 3 MW between node 1 and node 3, the corresponding power flow values will lead to counter flows on the line between node 1 and node 2 (Figure 1, case 2).

The changed market conditions of case 2 have an impact on the underlying physical rights: In case netting is not allowed, the counter-flow effect will not be accounted and although only 2 MW will flow from node 2 to node 1 both market participants will be required to hold a physical right of 3 and 1 MW respectively. In case netting is respected, the required physical position of the 9 MW injection would change reducing the required capacity right for the counter flow link to 2 MW. FTRs do not account for a specific power flow pattern, and thus the holder of the 9 MW FTR will not have to alter any position due to changes in the market dispatch. Any impact on the power flow and congestion situation will be fully reflected by changes in the nodal prices.

In this paper, we capture the delivery function of electricity among nodes via FTRs that are defined between nodes. An FTR q_{ij} represents the right to inject electricity in the amount of q at node i and to take delivery of the same amount at node j (this definition for FTRs works for obligations, as opposed to other hedging instruments such as options). The FTR does not specify the path taken between i and j . It is a flow concept and therefore applies to a discrete point in time and to PTP transactions.

Therefore, to analyze the cost behavior of extending meshed networks we must define the transmission output as PTP transactions. Whereas in directed networks like natural gas or oil an additional unit of output that normally can be associated with a well-defined cost parameter or function, additional output in electricity networks depends on the grid conditions, and cannot be considered separately from the output setting.

⁷ PTP forward obligations have proved to be the most feasible financial instrument in practice, compared to PTP options and flowgate rights. PTP-FTR obligations can be either “balanced” or “unbalanced”. A perfect hedge is achieved through a balanced PTP-FTR, while an unbalanced PTP-FTR obligation can be seen as a forward sale of energy. See also Hogan (2002b).

Figure 1: Power flows and transmission rights

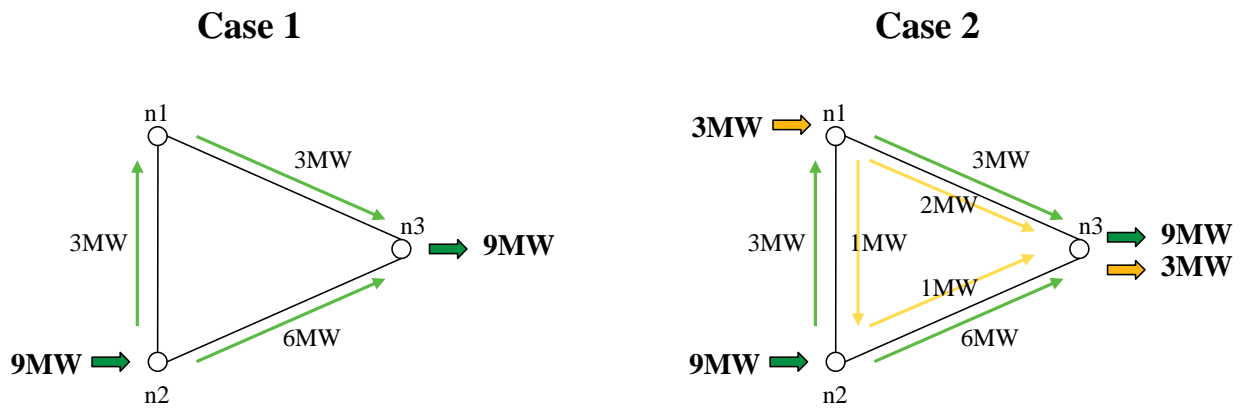

Source: Own representation

3 Model, Topologies and Data

3.1 The FTR cost-function model

The potential problems of transmission cost functions alluded to earlier derive from loop-flows that may produce decreasing or even negative marginal costs and discontinuities. Theoretically these problems can be solved with free disposal, but electricity cannot be freely disposed.⁸ One purpose of our study is to establish that the problem of non well-behaved, non-continuous transmission cost functions is related to demand changes that lead to a change in network topology (as suggested by HRV, 2007). We restrict our analysis to cases where the network topology is not changed, first studying cases with no changes in impedances, and then addressing the effects of loop-flows in switched networks.

We define network topology as a set of nodes and their locations and a set of lines between nodes. Generation nodes and consumption nodes are naturally given by the set of transmission outputs (FTRs), while free nodes are deliberately chosen for optimization of the network topology. A three-node network could be associated either with three lines connecting all three nodes, with three possible combinations of two lines, or with three possibilities of one line. Obviously, in the cases of a single line one node would be an orphan and could not be used for injecting or consuming electricity. The network topology is described by the network incidence matrix (Léautier, 2000, p.

⁸ A downward-sloping total cost curve for an FTR (i.e., with negative marginal costs) means that a larger FTR is provided at a lower cost. The question is if the unused part of the FTRs can be thrown away. It could be argued that the additional amount of FTRs can only be provided by actually injecting and taking out the required additional electricity. This would incur an additional cost of generation, which would contradict free disposal.

83). For a given network topology we assume that the line capacity is variable so that it can be changed between 0 and ∞ , but at a cost. There may be a fixed cost at zero capacity.

To derive an FTR-based cost function for transmission we examine the properties of power-flows in meshed networks. We use the DC load-flow model (DCLF) as proposed by Schweppe et al. (1988), which focuses on real power-flows and neglects reactive power-flows within a network. Although a simplification, the approach still yields reasonable results for locational price signals and grid utilization (see e.g., Overbye et al., 2004).

The complete approximation of the DCLF from the physical fundamentals of transmission lines is presented e.g., in Stigler and Todem (2005). The principle of a DCLF is that flows pf_{ij} on a line depend on the voltage angle difference Θ_{ij} and the line series susceptance B_{ij} between the two nodes i and j :

$$(1)^9 \quad pf_{ij} = B_{ij} \cdot \Theta_{ij} \quad \text{power-flow between } i \text{ and } j$$

The power-flow on one line also has an impact on the energy balance of its connected nodes. For each node i in a system the net injection q_i must equal the sum of power-flows on connected lines:

$$q_i = \sum_j pf_{ij} \quad \text{energy balance at } i \quad (2)$$

If more energy is to be delivered to or from node i all power-flows and nodes on lines connected to that node are affected, continuing throughout the network. Therefore, the resulting power-flow pattern depends on all system conditions.

To assess the costs of transmission, we define the transactions q_{ij} between two nodes i and j as the relevant output. These FTR PTP transactions are determined as a specific load value, e.g., in MW that must be transmitted between the two nodes. There is no pre-specified line utilization associated with an FTR. Market participants can bid for specific FTRs and the system operator allocates them accordingly, maximizing the revenue from the FTRs given the network's available transmission capacity. FTRs are assumed to be obligations, thus the associated energy transfer can be taken for granted.

⁹ The reactance X represents the opposition of a line towards alternating current, based on the inductance and/or capacitance of the line. Together with the resistance R , they define the impedance of a line and thus determine the amount of power flowing over this line given the net injections. The line series susceptance B_{ij} is then derived via: $B_{ij} = \frac{X_{ij}}{X_{ij}^2 + R_{ij}^2}$

Generally, the resistance is assumed to be significantly smaller than the reactance ($X \gg R$), and thus we do not consider it further in this analysis simplifying the susceptance to: $B_{ij} = \frac{1}{X_{ij}}$

We define the transmission costs function $c(\cdot)$ of network extension as the least costs combination of line capacities k necessary to satisfy Q_{ij} (the matrix consisting of a specific set of FTR combinations q_{ij}):

$$c(Q_{ij}) = \min_{k_i} \sum_{i,j} f_{ij}(k_{ij}) \quad \text{transmission cost function} \quad (3)$$

Thus, our approach is one of long-run cost functions, where capacity is optimally adjusted to each output.¹⁰

Next, each line capacity k_{ij} is associated with a specific cost value via an extension function $f(\cdot)$.

Minimization is subject to technical restrictions representing the network's power-flow characteristics:

$$\left| pf_{ij} \right| \leq k_{ij} \quad \forall ij \quad \text{line capacity constraint} \quad (4)$$

$$\sum_j q_{ij} - \sum_j q_{ji} = \sum_j pf_{ij} \quad \forall i \quad \text{energy balance constraint} \quad (5)$$

First, power-flows pf_{ij} on the lines must remain within the capacity limits k_{ij} defined by the system operator when designing the grid (equation 4). Second, at each node i the sum of outgoing FTRs (q_{ij}) and ingoing FTRs (q_{ji}) must equal the sum of power-flows on connected lines pf_{ij} (equation 5). Let $i = 1, \dots, I$ and $j = 1, \dots, J$. Then:

$$\begin{aligned} c(Q_{ij}) &= \min \sum_{i=1}^I \sum_{j=1}^J f_{ij}(k_{ij}) \\ &= \min \sum_{i=1}^I \sum_{j=1}^J f_{ij}(|pf_{ij}|) \\ &= \min \sum_{j=1}^J f_{ij}(ptdf_{1j}q_{1j} + ptdf_{2j}q_{2j} + \dots + ptdf_{ij}q_{ij}) + f_{2j}(\dots) + \dots + f_{ij}(\dots) \end{aligned}$$

where $ptdf_{ij}$ is the power factor distribution factor associated to the line that goes from node i to node j . The variables in parenthesis are the k_{ij} 's, for example:

$$k_{ij} = ptdf_{1j}q_{1j} + ptdf_{2j}q_{2j} + \dots + ptdf_{ij}q_{ij}$$

Marginal costs will then be of the form:

$$\frac{\partial c(Q_{ij})}{\partial q_{ij}} = \sum_{i=1}^I \sum_{j=1}^J ptdf_{ij} \frac{\partial f_{ij}}{\partial k_{ij}}$$

¹⁰ In practice, transmission costs should presumably also be complemented with adjustment mechanisms (or weights) among distinct types of users, specification of governance for changes in capacities and line structures, as well as with uncertainty about technology changes (such as in "smart grids").

Since the $f_{ij}(\cdot)$ are the costs of individual lines, they are then monotonically increasing functions. The marginal costs of FTRs are linear combinations of the marginal costs of all lines. The weights of these linear combinations—the ptdfs-- are constant (at least in the same period). As a result, marginal costs of FTRs should be well-behaved as long as marginal costs of lines do not differ too widely from each other and as long as marginal costs of all individual lines are well-behaved. However, the opposite might also be said: if marginal costs of each line differ too widely from each other then the marginal costs of FTRs will most likely be ill behaved. We will next get evidence of this theoretical implications with simulations over simple networks for, first, the case of no ptdf change over time and, second, when ptdf changes are allowed. To examine the characteristics of the FTR-based cost function in (3) and restrictions (4) and (5), we incorporate the model in a General Algebraic Modeling System (GAMS) as a non-linear minimization tool, with the overall grid extension costs as an objective function and looped over a specific set of FTRs.

3.2 Network topologies and dataset

We use a numeric data set representing idealized market characteristics to test our FTR-based cost function model. We consider two grid topologies to carry out our simulations (Figure 2):

1. An initial grid topology that comprises a three-node network with two generation nodes and one demand node representing the basic loop-flowed network structure.
2. An extended six-node network with two generation nodes and one demand node.

FTRs are defined from the generation node to the demand node, and vary between 1 MW and 10 MW respectively, to estimate the resulting global-cost function.

For network extension behavior, we next analyze two cases:

1. Only the capacity of a line can be changed whereas the line's reactance remains unchanged. Thus, an extension only impacts the transmission capacity of the system, but does not alter the power-flow pattern and PTDF structure. This approach is theoretical, since in reality pure capacity increases are only possible for small-scale extensions. It assesses the impact of loop flows on transmission costs without the interfering influence of power-flow changes.
2. Line extensions are combined with a change of the line's reactance and the added capacity changes the network's power-flow pattern as well as the PTDFs. This approach resembles the real world problem that a new or upgraded line affects the entire network, and leads to externalities for other market participants.

We test four forms of line extension costs functions $f_{ij}(k_{ij})$: constant marginal cost, decreasing marginal cost (economies of scale), increasing marginal costs (diseconomies of scale), and lumpy behavior.¹¹

Linear function (constant marginal cost):	$f_{ij} = b_{ij} k_{ij}$
Logarithmic function (economies of scale):	$f_{ij} = \ln(a_{ij} + b_{ij} k_{ij})$
Quadratic function (diseconomies of scale):	$f_{ij} = b_{ij} k_{ij}^2$
Lumpy function:	$f_{ij} = b_{ij} k_{ij}$ with $k_{ij} \in Z^+$

The first three extension functions represent a continuous approach, which is a rough approximation of the lumpy investment pattern of electricity networks and the fourth directly accounts for the integer nature of line extensions. For all scenarios network topology is fixed; new connections cannot be built and existing connections cannot be abolished. We assume that each line has the same starting characteristics for capacity and reactance.

When only the line capacities are extended, the presented extension cost functions are sufficient to derive a numerical solution. In the case of a connection between extensions and line reactances, the law of parallel circuits¹² is applied to derive a functional connection between capacity extensions and line characteristics $B_{ij}(k_{ij})$. Thus, doubling the capacity results in a bisection of a line reactance. Whereas the first approach does not require specific start values for line capacities, the latter approach needs initial network characteristics to obtain results. We test the cases using a series of numerical analyses, varying the underlying parameter. An overview of the basic data set is provided in Table 1.

¹¹ Although diseconomies of scale are rather unlikely in electricity networks they are included for the sake of completeness.

¹² In a parallel circuit the total resistance of the system is defined by $R_{total} = 1 / \sum_i \frac{1}{R_i}$.

Figure 2: Network topologies

Three-node network

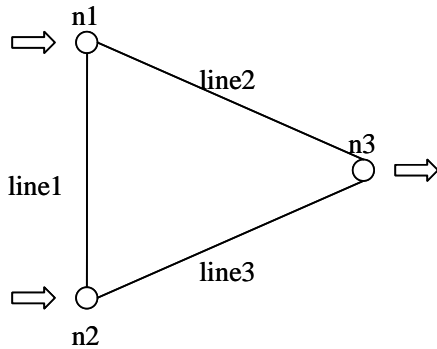

Six-node network

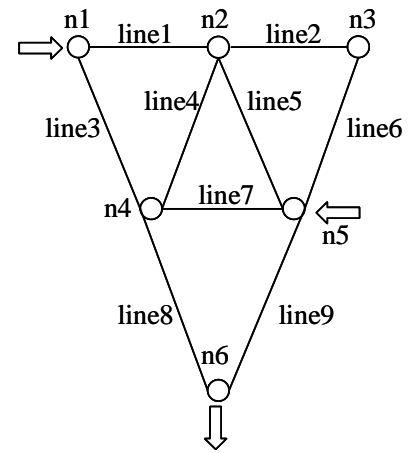

Source: Own representation

Table 1: Scenario overview for cost function calculation

	Fixed line reactances	Variable line reactances
Starting line reactances	1	1
Line extension functional parameters	$a_{ij} = b_{ij} = 1$	$a_{ij} = b_{ij} = 1$
Starting capacity values [MW]	$k_{ij} = 0$	$k_{ij} = 2$
Three node network		
FTR range [MW]	FTR 1 to 3: 1 to 5 FTR 2 to 3: 1 to 10	
Six node network		
FTR range [MW]	FTR 1 to 6: 1 to 5 FTR 5 to 6: 1 to 10	

Source: Own assumptions

4 Scenarios and Results

We first present the results for the cases with fixed-line reactances and thus the impact of loop flows on extension costs. To single out the effects we start with the extension of one FTR while the other is kept fixed, and then allow both FTRs to be extended. We then analyze the case with a linkage of capacity and reactances – case of variable line reactances – to estimate the combined impact on extension costs. We end with a discussion of the results.

4.1 Fixed line reactances

In the fixed-reactance case, the loop flows are predetermined and cannot be altered in any sense when the net input is modified at nodes. The resulting cost function will represent a network with line capacities that fully resemble the power-flow on each line.

4.1.1 Extending one FTR

In the three-node system line 1 (between nodes 1 and 2) is subject to power-flows in opposite directions depending on the value of the two FTRs. Given a fixed level of one FTR ($1 > 3$, fixed at 2.5 MW), an increase in the second FTR ($2 > 3$) will first lead to a decrease in the flow on line 1 towards zero until both FTRs have the same value. Afterwards, the flow will again increase, although in the opposite direction. The resulting capacity cost for increasing the FTR value will show a “kink” at the level of the fixed FTR which in our example is equal to 2.5 (Figure 3, left side). In the linear and logarithmic cases the kink can clearly be distinguished. In the quadratic case the slope of the line extension function around zero is almost horizontal with gradual changes. Thus, the loop-flow kink does not occur. In the lumpy case the needed capacity on the loop-flowed line is the lowest when both injections cancel each other out. Any divergence from that state, no matter how small, will make it necessary to install the next integer capacity level which results in a sharp decrease and increase of the cost function around that point which can be observed at a level of 2.5 MW (Figure 3, left side).

In the six-node case the number of loop-flowed lines is extended to five (lines 1, 2, 5, 6, and 7). However, lines 2, 5, and 6 will cancel out their flows at the same FTR level because of network symmetry; thus, only three counter-flow kinks are obtained. Furthermore, the counter-flow on line 1 will only be observed if the FTR from node 1 to node 6 is low compared to the FTR from node 5 to 6 due to the small power-flow share caused by the second FTR on line 1. For the 2.5 MW case we only observe two kinks (Figure 3, right side), one at 1.25 MW (canceling out the flows on line 7) and the second at 5 MW (canceling out the flows on lines 2, 5, and 6). The last kink occurs at a FTR value of 20 MW, which is outside the observation range. In particular the lumpy-cost curve shows the impact of several interacting loop flows: shortly after the first kink resulting from the counter-flow on line 7 at 1.25 MW, the cost function first increases and then decreases. This negative marginal cost range is caused by the reduced power-flow on line 1. Thus, the increasing and decreasing ranges of several counter-flows can lead to overlapping cost effects.

Figure 3: Cost function fixing one FTR, three-node and six-node network, fixed reactances

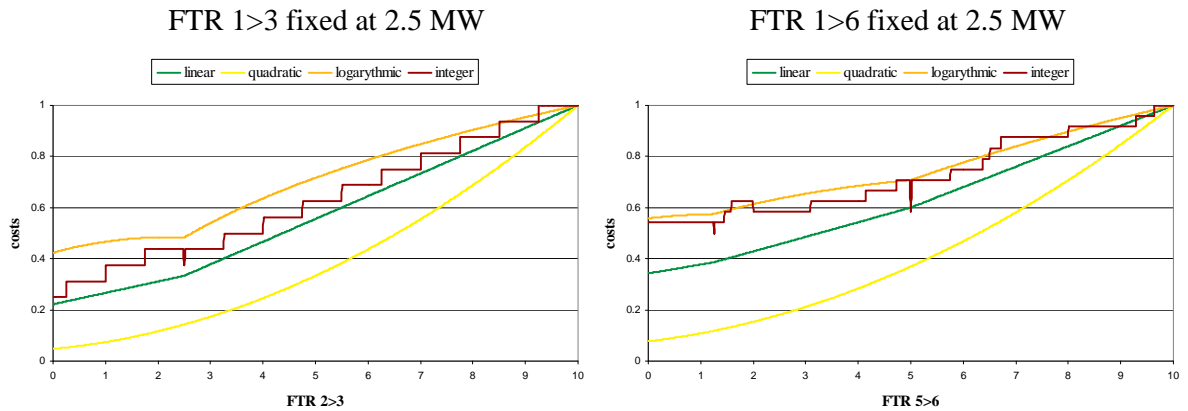

Source: Own calculation

4.1.2 Extending two FTRs (global cost function case)

If both FTRs are varied the resulting cost function behavior will still represent the counter-flow conditions. In the three-node case, we observe the kink of line 1 moving gradually with the increasing FTRs, which is best visualized in the logarithmic case (Figure 4, left side). The same holds true for the linear extension case, whereas the quadratic case again shows no signs of kinks.¹³ The lumpy investment case shows a more varied structure (Figure 4, right side). This is due to the combined extension of both FTRs: as the flows split up 2:1 respectively at specific extension steps, it becomes necessary to extend two or even all three lines in the system.¹⁴ Specifically, we see several areas with negative marginal costs. Thus, the global cost function is a combination of counter-flow based cost reduction on line 1, and possible capacity steps of 1, 2, or 3 MW depending on the net injection.

The same outcome holds true in the six-node case. The resulting global cost function shows three kinked lines (which correspond to the previous three kinked points), which again are best visualized in the logarithmic case (Figure 5, left side). The kink on the left side is associated with negative marginal costs and represents the counter-flow on line 1 which requires a low level of the FTR from 1 to 6, and a high level of the FTR from 5 to 6. The kink in the middle represents the counter-flows on lines 2, 5, and 6, and the right kink represents the flow on line 7. The lumpy investment case is

¹³ Linear and quadratic cases are presented in the Appendix.

¹⁴ For instance, keeping the FTR from 1 to 3 fixed to 0, if the FTR from 2 to 3 is extended from 3 to 3.1 the line capacities must all be extended by 1 MW (line 1 and 2 have 1 MW, line 3 has 2 MW). This allows the increased power-flow pattern and causes a step of 3 MW.

again highly fragmented and shows negative marginal costs (Figure 5, right side) due to the interaction of counter-flows and capacity steps.

Figure 4: Global cost function, three-node network, fixed reactances

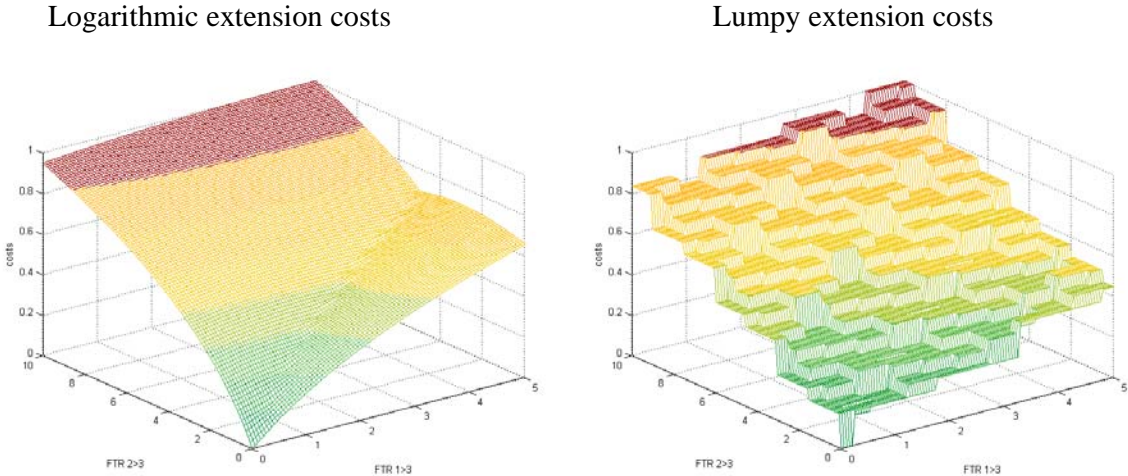

Source: Own calculation

Figure 5: Global cost function, six-node network, fixed reactances

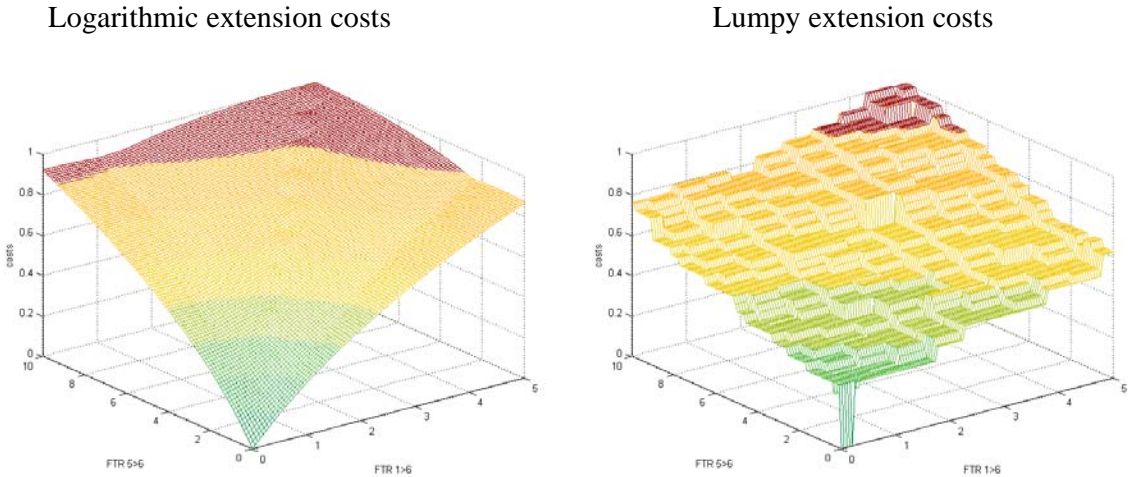

Source: Own calculation

4.2 Variable line reactances

In reality, there are limitations to extending a line capacity without altering its technical power-flow characteristics. Normally, a capacity extension is linked to a change in the reactance of the line.

Therefore, in our second scenario capacity extensions are coupled to line reactances via the law of parallel circuits. Thus a doubling of a line's capacity results in a bisection of the line reactance (and a change in the ptdf structure). The combined loop-flow nature of power-flows and the change in network characteristics due to capacity extensions makes a prediction of the possible outcomes more complicated.

4.2.1 Extending one FTR

Whereas in the fixed-reactance scenario it was clear beforehand that the power-flow on one line will fall to zero for a specific FTR combination, this may not be true in this scenario since the canceling-out point can change with the alteration of network characteristics. This can clearly be seen in the three- and six-node cases. Cost functions allow no general conclusions regarding the status of counter-flows and of potentially negative marginal costs within the system (Figure 6), because line 1 is not extended for the three-node case. Increasing the capacity of line 3 will lead to a larger power-flow on that line relative to the path over node 1 utilizing line 1 and 2. This allows the full utilization of the starting capacity values of those lines (2 MW). Therefore, the cost function only resembles the extension cost of increasing capacity on line 3 which consequently is a continuous function or an increasing stepwise function in the lumpy case (see Figure 6, left side).

The same holds true for the six-node case. By extending the most-utilized lines the power-flow share on these lines also increases, which avoids further extension. However, contrary to the 3-node case more than one line needs to be extended along the FTR range. Thus, kinks can occur when the extension includes more lines or when it switches the extended line. In addition we observe for the logarithmic case that more capacity is added on a line than is actually utilized, due to the decreasing marginal extension cost. The capacity extension has an impact on the power-flow distribution regardless of the actual flow over that line. By building more capacity on a line than needed, the power-flow pattern can be altered in such a way that less capacity is needed on other lines. Since the marginal extension cost in the logarithmic case is the highest for initial extension and decreases with capacity, it is less costly to extend a line that may not be fully utilized if other initial capacity extension can be avoided. This is the case in the first kink at 3.55 MW (Figure 6, right side). This situation may also switch back – making another line the less costly alternative to be extended – if the costs for excess capacity are no longer counteracted by a beneficial power-flow distribution.

This is the case for the second kink at 5.2 MW where the former extended line 8 is no longer extended, and the full additional capacity shifts to line 9, which alters the power-flow pattern.¹⁵

Figure 6: Cost function fixing one FTR, three-node and six-node network, variable reactances

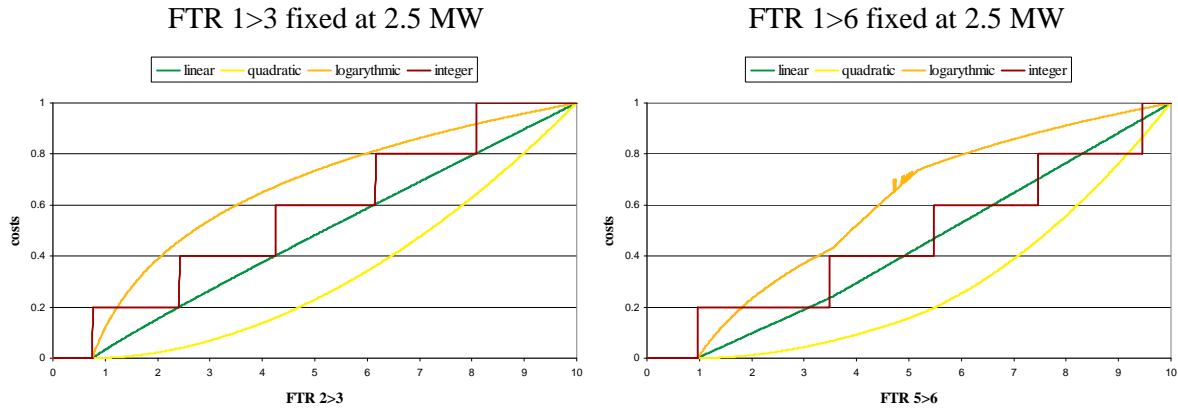

Source: Own calculation

4.2.2 Extending two FTRs (global cost function case)

If both FTRs are increased simultaneously, the resulting cost function in the three-node case shows a decrease at a specific FTR range (Figure 7). These results are obtained in all extension cases including the quadratic function (see Appendix). However, this range has no resemblance to the kink observed in the fixed reactance case which was solely attributable to the unavoidable counter-flow on line 1. In this case the decreasing cost range is attributed to the absence of a counter-flow in the very first case (FTR from 1 to 3 is “0”). The power-flow within the system therefore is only defined by the FTR from 2 to 3 and consequently the flow on line 1 is higher than in all other cases, making an extension of this line necessary (or a much larger extension of line 3). Increasing the FTR from 1 to 3 produces a counter-flow on line 1 and allows better utilization of the existing capacity. This effect makes the overall extension less costly (negative marginal costs both in the left and the right figure).

In the six-node case this dominant effect of a single line is canceled out by the increased number of loop-flowed lines. Within the observation range the non-lumpy cost function shows a continuous behavior with monotonically increasing global costs for increasing FTR values (Figure 8). The

¹⁵ The inconsistencies of the logarithmic cost function around 5 MW in the six-node case are due to the solve process utilizing Baron as GAMS solver. Using Conopt and Coinpot as solvers produces a higher cost function within that range, hinting at problems in obtaining the lowest local optimum.

lumpy case shows an increasing cost pattern without a large fragmentation. Whether this behavior also extends beyond the observation range is not so clear.

Figure 7: Global cost function, three-node network, variable reactances

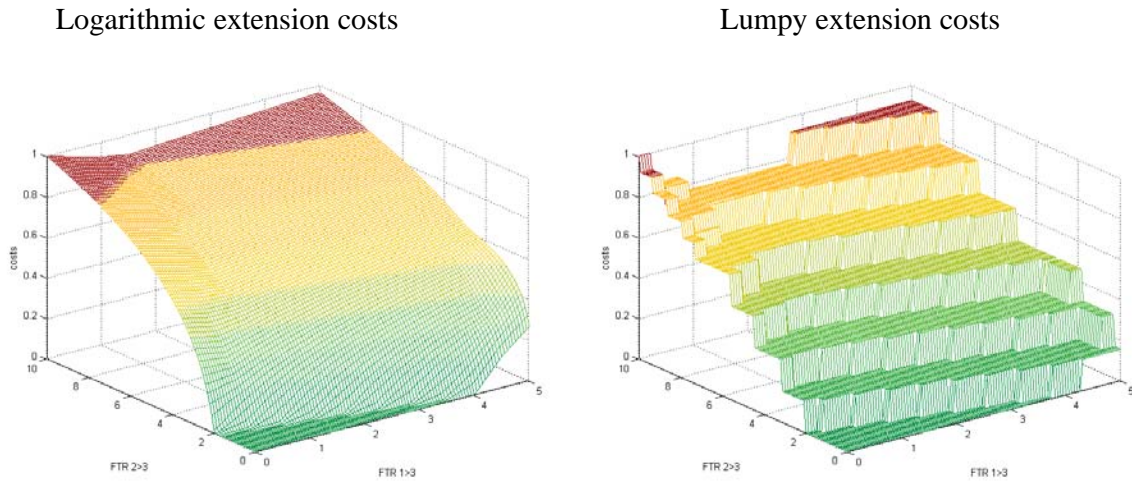

Source: Own calculation

Figure 8: Global cost function, six-node network, variable reactances

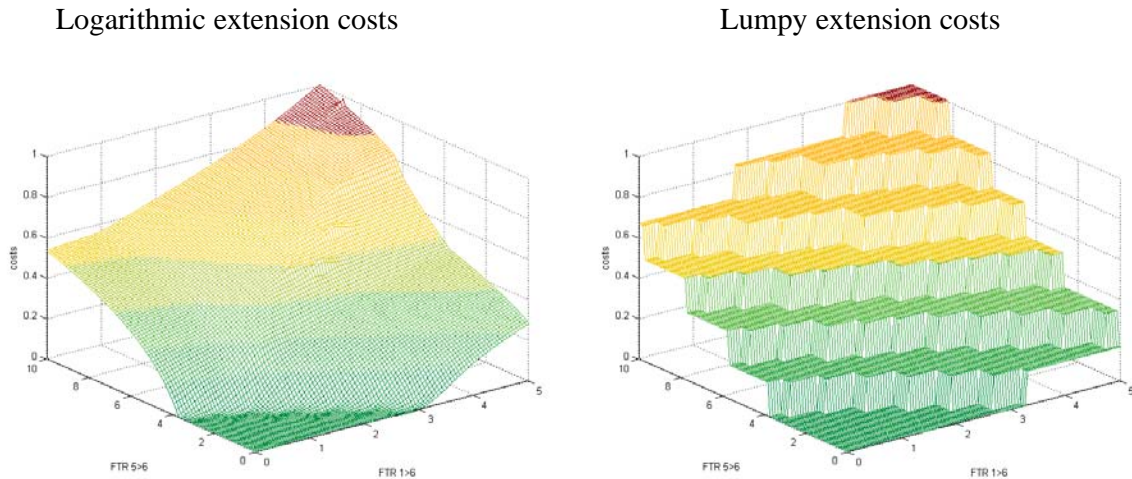

Source: Own calculation

4.3 Discussion

Table 2 presents a summary that compares the cases addressed in Sections 4.1 and 4.2. We can deduce some conclusions regarding the relationship of kinks, negative slopes and loop-flows for the non-lumpy cost functions. First, we observe that smoothness is gained with variable reactances in

the three-node case. Whereas in the fixed-reactance scenario it was clear that for specific FTR combinations the power-flow on one line will fall to zero and cause kinks in both the 1-FTR and global-cost function cases, this is not valid in the variable-reactance scenario because the canceling-out points can change with the alteration of network characteristics. Additionally, for the global-cost function case the counter-flow structure may imply decreasing ranges of the cost function.

The analysis for the six-node case is richer because of its complex network topology and loop-flow structure. However, in the global-cost function case the same conclusion prevails: the relationship among different loop-flows is such that continuity in the cost function is gained when reactances are allowed to vary. Non-lumpy cost functions then show a smooth behavior but with increasing global costs for increased FTR values. The above results apply to the lumpy extension case where by definition, network expansion is carried out within a discontinuous environment. The obvious difference is that the gains from considering variable reactances will imply an increasing stepwise function. The results indicate that taking into account the full characteristics of electricity networks provides a cost framework that is closer to the well-behaved continuous functionality postulated in regulatory theory.

Although not fully general, the above comparative analysis suggests that piece-wise continuity of cost functions is a concrete advantage of a transmission cost analysis based on FTRs instead of power-flows. This property is crucial for the application of price-cap incentive mechanisms to real-world expansion projects. Especially when we assume increasing returns to scale, the resulting capacity extension pattern includes sudden shifts in the extended lines which in turn cause a significant alteration in power-flows. When we define the transmission output as line power-flows, the shifts will cause jumps in the resulting cost functions. Whereas the redefinition via a FTR approach only takes into account the overall extension costs and thus avoids line specific discontinuities.

A further issue that would generalize this analysis considers a more realistic scenario of electricity networks. When cost minimization occurs over the optimal design of the network (i.e., the location and number of links and nodes denoted by the transfer-admittance matrix H), the network topology is affected accordingly. In this case, H becomes a variable, and a more complicated cost minimization problem results.¹⁶ The problem also leads to new goods (FTRs) for new nodes, and these new goods change the costs for all of the old goods. Hence, all FTRs are affected if free nodes are added or removed.

¹⁶ We conjecture, however, that in the cases with two generation nodes and one consumption node dealt with in the current paper the optimal network architecture may actually be too simple. Our results might become more complex when many generation nodes and many consumption nodes are considered. Results may also be different if one adds reliability constraints, such as an (n-1) constraint. We plan to address these issues in future work.

One way to first address this problem is to consider an incremental change in network architecture. The method would calculate the cost function for the changed network, and then compare it to the cost function of the original network. If the new cost function lies everywhere below (above) the original cost function, the new topology dominates (is dominated by) the original one. Most likely, as suggested by our previous simulations, one will dominate the other only over part of its range. Another solution is to evaluate ways to minimize costs for the network topology alternatives. If, for simplicity, we assume that the nodes are given by the location of power stations and load centers, one has to choose between different line configurations. The number of configurations will grow quickly with the number of nodes. But after identifying all cost functions for all topologies, the long-term cost function will be the minimum cost locus (the lower envelope convex hull).

Table 2: Overview of results

	Fixed Reactance		Variable Reactance	
	1 FTR Fixed	2 FTRs	1 FTR Fixed	2 FTRs
Three nodes	<ul style="list-style-type: none"> Resulting capacity cost for increasing an FTR value will show a “kink” at the level of the fixed FTR. In the lumpy extension case, the kink is represented by a jump in the step function. In the quadratic case the slope of the line extension close to the origin is almost horizontal, thus the loop-flow kink does not occur. 	<ul style="list-style-type: none"> The kink of lines moves gradually with increasing FTRs. The lumpy investment case is a combination of cost reductions based on counter-flows and capacity steps depending on net injections. The quadratic case shows no signs of kinks. 	<ul style="list-style-type: none"> No clear correlation between counter-flows and kinks as the canceling-out point of counter-flows changes with the alteration of network characteristics. The cost function will resemble the extension cost of increasing capacity on the most utilized line causing a continuous cost function. 	<ul style="list-style-type: none"> The resulting cost function can show a decreasing part at a specific FTR range attributed to the missing of a sufficient counter-flow.
Six nodes	<ul style="list-style-type: none"> Lines 2, 5, and 6 will cancel out their flows at the same FTR level due to the network symmetry, and thus three counter-flow kinks are obtained. The lumpy-cost curve shows the impact of several interacting loop flows: the cost function first increases and then decreases again. 	<ul style="list-style-type: none"> Resulting global cost function shows three kinks. The lumpy investment case is highly fragmented due to the interaction of counter-flows and capacity steps. 	<ul style="list-style-type: none"> By extending the most utilized lines the power-flow share on those lines also increases, and the need to extend other lines is reduced. Kinks can occur when the extension includes further lines or when it switches the extended line(s). In the logarithmic case more capacity is added on a line than is actually utilized (due to decreasing marginal extension costs), altering the power-flow pattern so that less capacity is needed on other lines. 	<ul style="list-style-type: none"> The dominant effect of a single line is canceled out by the increased number of loop-flowed lines in the system. Within the observation range the cost functions show a continuous behavior with increasing global costs for increased FTR values.

5 Application to a regulatory mechanism for transmission expansion

Under incentive mechanisms for Transcos proposed by Vogelsang (2001) and HRV (2007), investments will continue through time until they converge to an optimal (Ramsey-price) level. However, this only holds under the assumptions that transmission's demand functions are differentiable and downward-sloped and that the marginal cost curves cut demands only once. However, our observations above (in Figure 3 right, Figure 4 left and right, Figure 5 right and Figure 7 left and right) exhibit areas of negative marginal costs (where the total cost function either jumps down or has a negative slope). This is something that never happens with "normal" cost functions and could potentially violate the assumptions necessary for the working and convergence of such mechanisms. The local presence of such anomalies, however, does not necessarily mean that the mechanism would not converge or would not converge to the optimum. The firm may end up at a local, not global optimum, though.¹⁷ It appears that these concerns might not always be relevant, as the following simulation results by Rosellón and Weigt (2007) illustrate.

Applying a simple three-node setting as presented in Figure 2, Rosellón and Weigt show that the regulatory mechanism grants convergence towards the welfare optimal solution over time. The obtained results are robust to changes in the underlying network, demand, and generation assumptions. Extending the model approach to represent the North-West European electricity market with the Netherlands, Belgium, France, and Germany the obtained results show a convergence of price levels within the region due to the extensions carried out by a regulated Transco (Figure 9). The network representation with 15 nodes and 28 lines in Rosellon and Weigt (2007) exceeds the range of the networks analyzed in this paper and consists of several injection points, counter flow situations, and congestion problems. Although, the actual transmission cost function in this exercise has not been derived, the results suggest that the conclusions drawn from the cost function analysis could also hold for more complex network topologies.

¹⁷ The analysis of local or global optima could be further carried out considering cheap and dear nodes where there is a trade-off between "lumpy investment in transmission and no investment in generation" vis a vis "no investment in transmission and investments in generation".

Figure 9: Price development in the European model

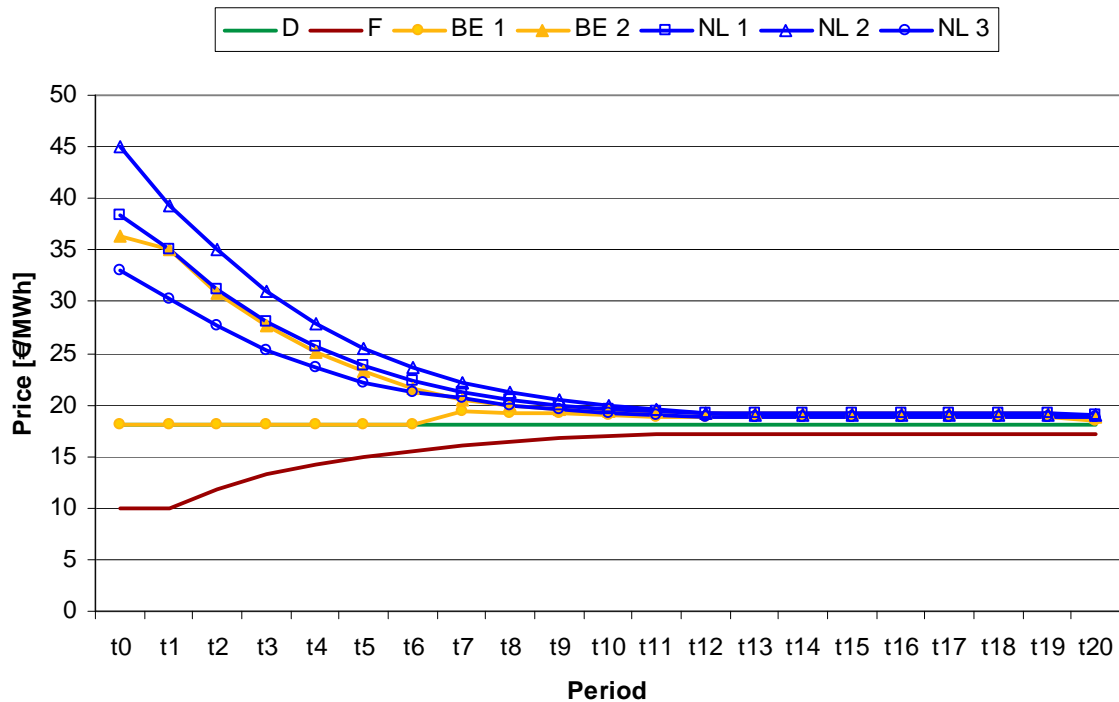

Source: based on Rosellon and Weigt (2007). “D” stands for Germany, “F” for France, “BE” for Belgium, and “NL” for the Netherlands.

6 Conclusion

We analyzed the cost functions of electricity transmission when the transmission output is redefined in terms of FTR point-to-point transactions. We were motivated to do so because smooth, well-behaved cost functions may not hold in meshed network with loop-flows. Likewise, a conventional definition of the electricity transmission is not possible since the physical flow through loop-flowed meshed transmission networks obey Kirchhoff’s laws. We explicitly tried to provide more evidence for the intuition suggested in the literature that ill-behaved non-continuous transmission cost functions are mainly due to capacity changes that modify network topology. We therefore focused on fixed topology networks with two cases, one where line capacities could change but not the lines reactances, and the other where changes in line reactances linking capacity extensions and power-flow distribution are allowed.

Our simulations in general suggest that FTR-based cost functions remain piecewise continuous – as well as piecewise differentiable – over the entire FTR range. Regions with negative marginal costs could cause concern. However, they seem to shrink, as one moves to more realistic (multi-node) networks and includes changes in reactances in the model. This then provides support for

applications of mechanisms that use FTRs to promote network expansion. More specifically, our results showed that compared with the fixed-network case the introduction of variable line reactances significantly changes the possible outcomes. In particular, the introduction of a link between capacity and reactance appears to reduce the impact of loop-flows in terms of significant kinks. Therefore, one general result is that smoothness of non-lumpy cost functions is gained with variable reactances. In a lumpy environment, this result translates to variable reactances, implying increasing stepwise functions.

Overall, our results reveal the difficulties that electricity networks present when applying standard approaches. Even for a simple extension, loop-flows can lead to a mathematically complex global cost function. This in turn makes the estimation of revenue and profits more complex in a general setting. Additionally, the link between capacity extension and line reactances (and thus flow patterns) produces results that are highly sensitive to the grid structure.

For modeling purposes, the logarithmic and lumpy behaviors produce high degrees of nonlinearities with non-smoothness, and require further calculations and solver capabilities, the quadratic functions show a generally continuous behavior, and the linear extension functions fall somewhere between. Most suitable for modeling, therefore, is combining the latter with the piecewise, linear nature of the resulting global costs function, making it possible to derive global optima.

Nevertheless, an analysis of investment incentives in electricity transmission relies on numerical analysis to capture the physical nature of the network, so that conclusions remain feasible within a range of systems and cases. One challenging subject for future research topic is the examination of the external influences (e.g., geographical conditions or different states of nature) which might cause dysfunctional behaviors with sudden slope changes. Further research steps would also include the derivation of cost functions under the elicitation of FTRs under a mechanism such as HRV (2007). In each period, the demand for FTRs (so as to increase transmission capacity) would determine marginal costs for transmission which would in turn affect demand for FTRs in the next period. This would intertemporally provide a cost function for each specific expansion project. Such analysis might be further expanded into more complex settings such as: market power in energy FTR markets, a cost function (3) unknown to the regulator, different states of nature, and a regulatory mechanism that combines low-power incentive schemes for the long term and high-power incentive schemes for the short term. Other issues would further include the impacts on the cost function behavior of lack of fiscal transfers (so that the fixed-fee allocation among consumers might have distortive effects) as well as capacity reserves.

The ultimate research challenge, however, is to identify the changes in network topology and the alternatives that minimize costs throughout the system. Recognizing that the number of configurations increases significantly with the number of nodes, nonetheless an exhaustive analysis of the properties of transmission cost functions should suggest future research to pursue.

Once these challenges have been resolved, the emphasis should be on empirical assessments of line costs in order to combine our analytical approach with actual (engineering) data so that actual cost functions can be estimated in ways pioneered for telecommunications networks (Gasmi et al., 2002).

References

- Bushnell, J. B., and S. E. Stoft (1996), "Electric Grid Investment under a Contract Network Regime," *Journal of Regulatory Economics* 10, pp. 61-79.
- Bushnell, J. B., and S. E. Stoft (1997), "Improving Private Incentives for Electric Grid Investment" *Resource and Energy Economics*, 19, 85-108.
- Chao, H.P., and S. Peck (1996), "A Market Mechanism for Electric Power Transmission," *Journal of Regulatory Economics* 10, pp. 25-59.
- Dismukes, D. E., R. F. Cope III and D. Mesyanzhinov (1999), "Capacity and Economies of Scale in Electric Power Transmission" *Utilities Policy*, 7, pp. 155-162.
- Gasmi, F., D.M. Kennet, J.-J. Laffont and W.W. Sharkey (2002), *Cost Proxy Models and Telecommunications Policy*, Cambridge, Mass., and London: MIT Press..
- Green, R. (2003), "Cost recovery and the efficient development of the grid," in F. Lévêque (ed.), *Transport Pricing of Electricity Networks*, Boston: Kluwer, pp. 137-154.
- Hogan, W. (2000), "Flowgate Rights and Wrongs" Mimeo, JFK School of Government, Harvard Electricity Policy Group, Harvard University, <http://www.ksg.harvard.edu/people/whogan>.
- Hogan, W. (1992) "Contract Networks for Electric Power Transmission," *Journal of Regulatory Economics*, 4, pp. 211-242.
- Hogan, W. (2002a), "Financial Transmission Right Incentives: Applications Beyond Hedging" Presentation to HEPG Twenty-Eighth Plenary Session, May 31, <http://www.ksg.harvard.edu/people/whogan>.

- Hogan, W. (2002b), "Financial Transmission Right Formulations" Mimeo, JFK School of Government, Harvard Electricity Policy Group, Harvard University, <http://www.ksg.harvard.edu/people/whogan>.
- Hogan, W., J. Rosellón and I. Vogelsang (2007), "Toward a Combined Merchant-Regulatory Mechanism for Electricity Transmission Expansion" Conference Proceedings, 9th IAEE European Energy Conference, Florence, Italy.
- Joskow, P. and J. Tirole (2000) "Transmission Rights and Market Power on Electric Power Networks," *RAND Journal of Economics* 31, pp. 450-487.
- Joskow, P. and J. Tirole (2005) "Merchant Transmission Investment," *The Journal of Industrial Economics* 53, pp. 233-264.
- Kristiansen, T., Rosellón, J., 2006. "A Merchant Mechanism for Electricity Transmission Expansion" *Journal of Regulatory Economics*, 29, pp. 167-193.
- Laffont, J.J., and J. Tirole (1996), "Creating Competition Through Interconnections: Theory and Practice" *Journal of Regulatory Economics*, 10, pp. 227-256.
- Léautier, T.-O. (2000) "Regulation of an Electric Power Transmission Company" *The Energy Journal*, 21, pp. 61-92.
- Oren, S., P. Spiller, P. Varaya, and F. Wu (1995), Nodal Prices and Transmission Rights: A Critical Appraisal, *Electricity Journal* 8, pp. 24-35.
- Pérez-Arriaga, J. I., F. J. Rubio and J. F. Puerta Gutiérrez, J. Arceluz, and J. Marin (1995) "Marginal Pricing of Transmission Services: An Analysis of Cost Recovery," *IEEE Transactions on Power Systems*, vol. 10, no. 1, pp. 546-553.
- Ramírez, J. C. and J. Rosellón (2002), "Pricing Natural Gas Distribution in Mexico" *Energy Economics*, 24, pp. 231-248.
- Rosellón, J. (2007), "A Regulatory Mechanism for Electricity Transmission in Mexico" *Energy Policy*, 35, pp. 3003-3014.
- Rosellón, J. and H. Weigt (2007), "A Combined Merchant-Regulatory Mechanism for Electricity Transmission in Europe" paper presented at the Trans-Atlantic INFRADAY Conference on Applied Infrastructure Modeling and Policy Analysis, University of Maryland, College Park, November 2, 2007.

- Rubio-Oldériz, J., and I. J. Pérez-Arriaga (2000) “Marginal Pricing of Transmission Services: A Comparative Analysis of Network Cost Allocation Methods,” *IEEE Transactions on Power Systems* 15, pp.448-454.
- Schweppe, Fred C., Caramanis, Michael C., Tabors, Richard D., and Roger E. Bohn (1988): *Spot Pricing Of Electricity*. Boston, Kluwer.
- Stigler, Heinz, and Christian Todem (2005): “Optimization of the Austrian Electricity Sector (Control Zone of VERBUND APG) under the Constraints of Network Capacities by Nodal Pricing” *Central European Journal of Operations Research*, 13, pp. 105-125.
- Tanaka, M. (2007), “Extended Price Cap Mechanism for Efficient Transmission Expansion under Nodal Pricing” *Network and Spatial Economics*, 7, pp. 257-275.
- Vogelsang, I. (2001), “Price Regulation for Independent Transmission Companies” *Journal of Regulatory Economics*, 20, pp. 141-65.
- Vogelsang, I. (2006), “Electricity Transmission Pricing and Performance-based Regulation” *Energy Journal*, 27, pp. 97-126.
- Wu, F., P. Varaya, P. Spiller, and S. Oren (1996), “Folk Theorems on Transmission Access: Proofs and Counterexamples,” *Journal of Regulatory Economics* 10, pp. 5-23.

Appendix

Figure 10: Global cost function, three-node network, fixed reactances

Linear extension costs

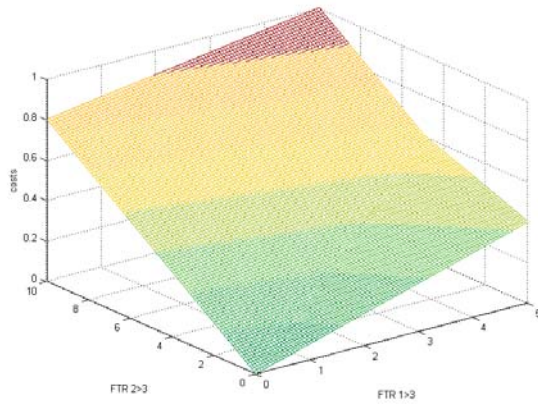

Quadratic extension costs

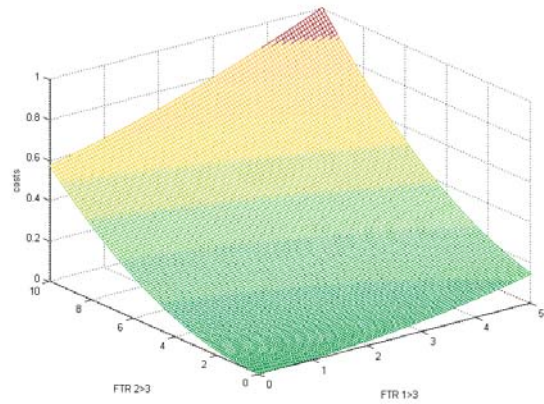

Source: Own calculation

Figure 11: Global cost function, six-node network, fixed reactances

Linear extension costs

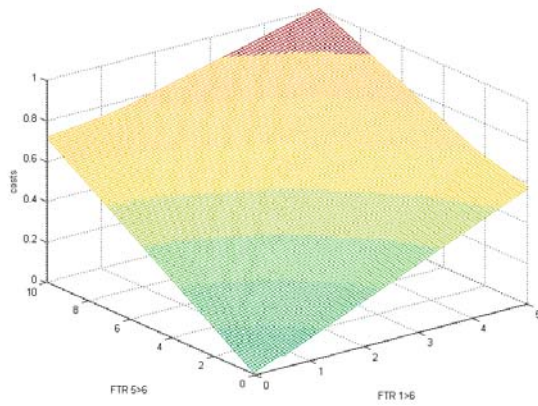

Quadratic extension costs

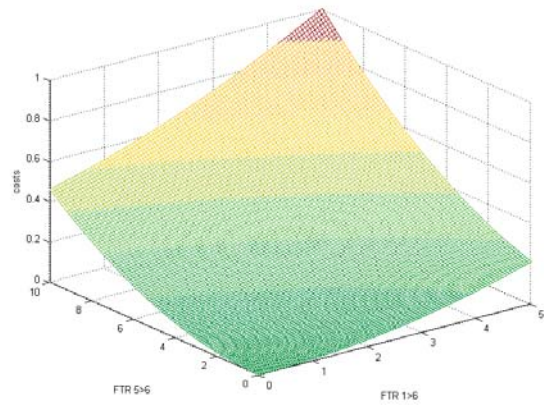

Source: Own calculation

Figure 12: Global cost function, three-node network, variable reactances

Linear extension costs

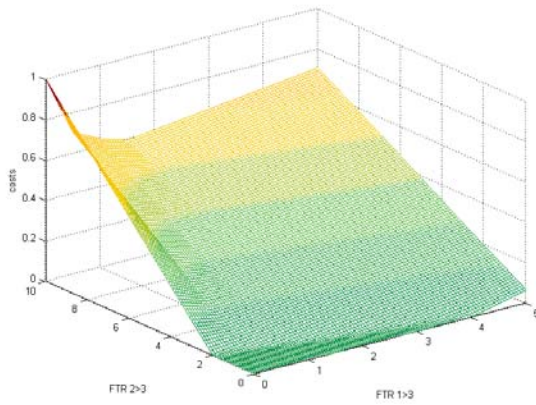

Quadratic extension costs

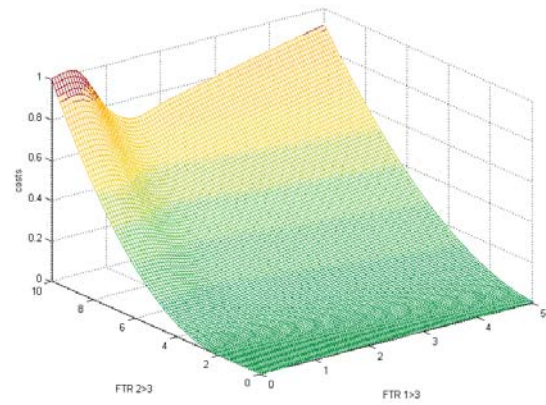

Source: Own calculation

Figure 13: Global cost function, six-node network, fixed reactances

Linear extension costs

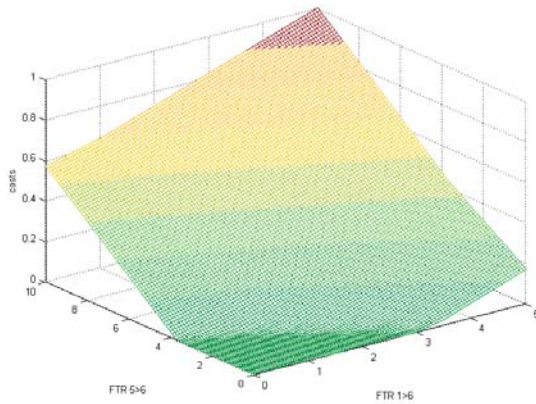

Quadratic extension costs

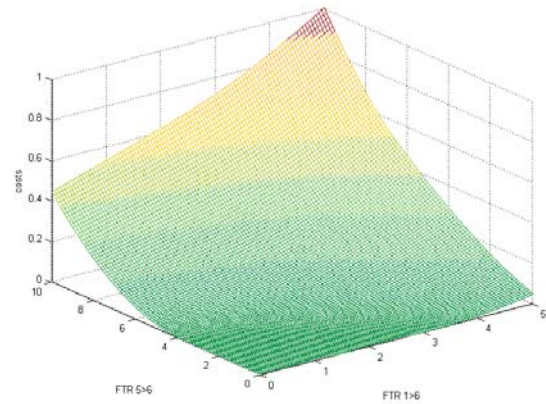

Source: Own calculation