

Snower, Dennis J.

Working Paper — Digitized Version

Imperfect competition, underemployment and crowding-out

Seminar paper, Institute for International Economic Studies, University of Stockholm, No. 263

Provided in Cooperation with:

Kiel Institute for the World Economy – Leibniz Center for Research on Global Economic Challenges

Suggested Citation: Snower, Dennis J. (1983) : Imperfect competition, underemployment and crowding-out, Seminar paper, Institute for International Economic Studies, University of Stockholm, No. 263, Institute for International Economic Studies, University of Stockholm, Stockholm

This Version is available at:

<https://hdl.handle.net/10419/434>

Standard-Nutzungsbedingungen:

Die Dokumente auf EconStor dürfen zu eigenen wissenschaftlichen Zwecken und zum Privatgebrauch gespeichert und kopiert werden.

Sie dürfen die Dokumente nicht für öffentliche oder kommerzielle Zwecke vervielfältigen, öffentlich ausstellen, öffentlich zugänglich machen, vertreiben oder anderweitig nutzen.

Sofern die Verfasser die Dokumente unter Open-Content-Lizenzen (insbesondere CC-Lizenzen) zur Verfügung gestellt haben sollten, gelten abweichend von diesen Nutzungsbedingungen die in der dort genannten Lizenz gewährten Nutzungsrechte.

Terms of use:

Documents in EconStor may be saved and copied for your personal and scholarly purposes.

You are not to copy documents for public or commercial purposes, to exhibit the documents publicly, to make them publicly available on the internet, or to distribute or otherwise use the documents in public.

If the documents have been made available under an Open Content Licence (especially Creative Commons Licences), you may exercise further usage rights as specified in the indicated licence.

ISSN 0347-8769

Seminar Paper No. 263

IMPERFECT COMPETITION, UNDEREMPLOYMENT AND CROWDING-OUT

by

Dennis J. Snower

Seminar Papers are preliminary material circulated to stimulate discussion and critical comment.

October, 1983

Institute for International Economic Studies
S-106 91 Stockholm
Sweden

Imperfect Competition, Underemployment and Crowding-Out

Dennis J. Snower

1. Introduction

The microfoundations of the conventional macroeconomic models characteristically assume that the economy is perfectly competitive. This assumption has been incorporated in both market-clearing and non-market-clearing models. By contrast, this paper develops a macroeconomic model which rests on imperfectly competitive microfoundations and explores the implications of imperfect competition for the effectiveness of government policy with regard to wages, prices, and employment.

There are a number of reasons why such an approach appears worthwhile. First, whereas the distinctiveness and practical significance of imperfectly competitive behavior has long been acknowledged in microeconomic analysis, the repercussions of this behavior in macroeconomic activity remains largely unexplored. Second, the division of market power among agents in the private sector has important implications for the effectiveness of government policy. Third, the assumption of imperfect competition provides a way out of logical difficulties generated by the conventional non-market-clearing macroeconomic models.

These non-clearing models (e.g. Benassy (1975), Barro-Grossman (1976), Malinvaud (1977), Muellbauer-Portes (1978)) presuppose

- (a) perfect competition, so that all agents are price takers, and
- (b) that prices are set at levels which do not clear their respective

markets. However, perfect competition requires that agents are able to buy and sell all that they wish to demand and supply at the going prices (given tastes, technologies, and endowments), while non-clearing markets imply that agents are not able to do so. As Arrow (1959) noted, the assumption of perfect competition breaks down when agents are rationed.

In general, by changing the prices, agents could manipulate the rations they face. For example, a firm which is rationed in the product market (i.e. which would be willing to sell more than it does at the going prices) may be able to manipulate the product demand it faces by varying the product price. Thus, in the absence of institutional restrictions on price change, when markets do not clear, agents have no incentive to remain price takers. To say that a firm faces a price-manipulable product demand ration simply means that it faces a non-vertical product demand curve. The rations which agents face under non-market-clearing conditions may be interpreted quite simply as the demand and supply curves which agents with market power take into account when making their decisions.

Of course, there are special circumstances in which markets do not clear and agents nevertheless remain price takers. For example, the government may institute wage-price controls and the prescribed wages and prices may not clear their respective markets. Here the government preempts the market power which the agents of the private sector would otherwise have made use of. Besides, there may be administrative costs of price change (see, for example, Barro (1972), Sheshinski and Weiss (1977)) - such as the cost of replacing price tags and printing new catalogues - which may induce agents to accept their existing rations. Yet it appears quite doubtful that these costs are of major practical significance in explaining

price stickiness in the face of large variations in production and employment.

So let us assume that there is imperfect competition and that prices are flexible. In other words, there are no legal or administrative restraints on price change and the price makers may set their prices freely in accordance with their objectives.

The macroeconomic model under consideration here is based on microfoundations in the spirit of Chamberlain's (1933) monopolistic competition. These microfoundations have three salient features. First, both products and labor services are assumed to be differentiated. There are a fixed number of product markets (one for each type of product) and a fixed number of labor markets (one for each type of labor).

Second, the price setters are assumed to have monopoly power in the markets in which they operate, but none in any of the other markets. Each price setter in a particular market recognizes that his activity has no significant influence on the activity of agents in all other markets. In particular, sellers are assumed to be price setters in their markets. Firms have monopoly power in their respective product markets and households (through the vehicle of their unions) have monopoly power in their respective labor markets. Firms set their product prices in accordance with their profit-maximizing objectives; households (through their unions) set their wages in accordance with their utility-maximizing objectives.

Third, there is free entry of firms into each product market and this drives the profits of all firms to zero. Thus, households earn wage income, but no profit income.

This paper is akin to Hart's (1982) macroeconomic model of imperfectly competitive activity. However, in Hart's analysis, (i) firms and unions behave as Cournot-Nash oligopolists in the product and labor markets, respectively (rather than as Chamberlainian monopolistic competitors), (ii) there is no free entry of firms which drives profits to zero (as is the case here), and (iii) certain agents are assigned to certain markets and this assignment is given no choice-theoretic rationale.

Within this analytical framework, it will be shown that:

- (A) Every imperfectly competitive equilibrium (ICE) generates under-employment, i.e. the ICE level of employment falls short of the socially optimal level. This result is explained by showing that the division of responsibility for price and quantity decisions among imperfectly competitive agents invariably give rise to allocatively inefficient trades.
- (B) An increase in government expenditure invariably crowds out private-sector expenditure.
- (C) An increase in government expenditure gives rise to a wage-price spiral. The magnitude of the wage-price spiral is related to the size of the crowding-out effect.

Result (A) is concerned with the nature of unemployment under ICE. The explanation of unemployment in terms of allocative inefficiency of imperfectly competitive trades provides an alternative to the quantity rationing of the conventional Keynesian models as well as the argument based on increasing returns (Weitzmann (1982)). Result (B) is rather surprising. It stands in contrast to the "Keynesian features" of Hart's (1982) analysis. Result (C) contributes to the well-known controversy about how government expenditure changes "split" between price effects and quantity effects.

The paper is organized as follows. Section 2 concerned with the interrelations among the various agents and discusses the salient assumptions underlying the imperfectly competitive structure of our model. Section 3 describes the behavior of the agents and portrays the imperfectly competitive general equilibrium. Section 4 shows how government expenditure changes generate wage-price spirals and crowd out private sector expenditures. Section 5 deals with the nature of under-employment and trading inefficiency under imperfect competition. Finally Section 6 summarizes the main conclusions of our analysis.

2. Structure of the Model

2a. The Interrelations among Agents

The economy under consideration contains three types of agents: firms, households, and government. There are two types of markets: product and labor markets. The households supply labor to the firms and the firms supply produced goods to the households and the government. In the hands of the households, the produced goods are non-durable consumption goods; in the hands of the government, they are nondurable public goods, which are imposed (without price) on the household.

The households pay for their consumption purchases by means of their wage income; the firms pay for their labor purchases from their sales revenue; and the government finances its expenditures by imposing an identical lump-sum tax on each household and (depending on the interpretation below of firms' fixed costs) possibly also on each firm (but the government budget constraint is not important for the analysis below).

As noted, we allow the products to be differentiated. There are a fixed number (I) of products, each produced by one "industry". Each industry contains F identical firms. (F is a variable, since the number of firms per industry is such as to ensure zero profits.) No industry produces more than one type of product.

Labor services are also differentiated. There are a fixed number (T) of labor types. Each household can provide labor of only one type. All households of a single type group together to form a trade union. There are a fixed number (H) of households per union. No union offers more than one type of labor service.

This configuration of labor and product markets is pictured in

Figure 1. L_{tf} is the amount of type- t labor demanded by firm f ; C_{ih} is the amount of type- i product demanded by household h ; and G_i is the amount of type- i product demanded by the government (and imposed on the households).

2b. The Division of Price and Quantity Decisions

The next step in setting up our model is to specify which agents are to be assigned control over which price and quantity variables. Each of the product and labor markets is assumed to consist of a "heavily populated" and a "lightly populated" side. On the former side, each agent is sufficiently small relative to the market so that his activity has no influence on the activity of the other market participants. On the latter side, each agent is sufficiently large relative to the market to have some monopoly power (see Hart (1978)). Let us adopt the usual convention that the lightly populated side of the market makes the price decisions, while the heavily populated side makes the quantity decisions.

In particular, each firm faces a large number of buyers (viz. the households and the government) in its product market. The firm has some monopoly power in this market, whereas the buyers do not. Consequently, the firm sets the price of its product and each of the buyers decides how much to purchase at that price.

Each union faces a large number of buyers (viz. the firms in its labor market). Once again, the union has some monopoly power in this market, but the buyers have none. Thus, the union sets the wage at which its members are willing to work and each of firms decides how much labor to hire at the offered wage.

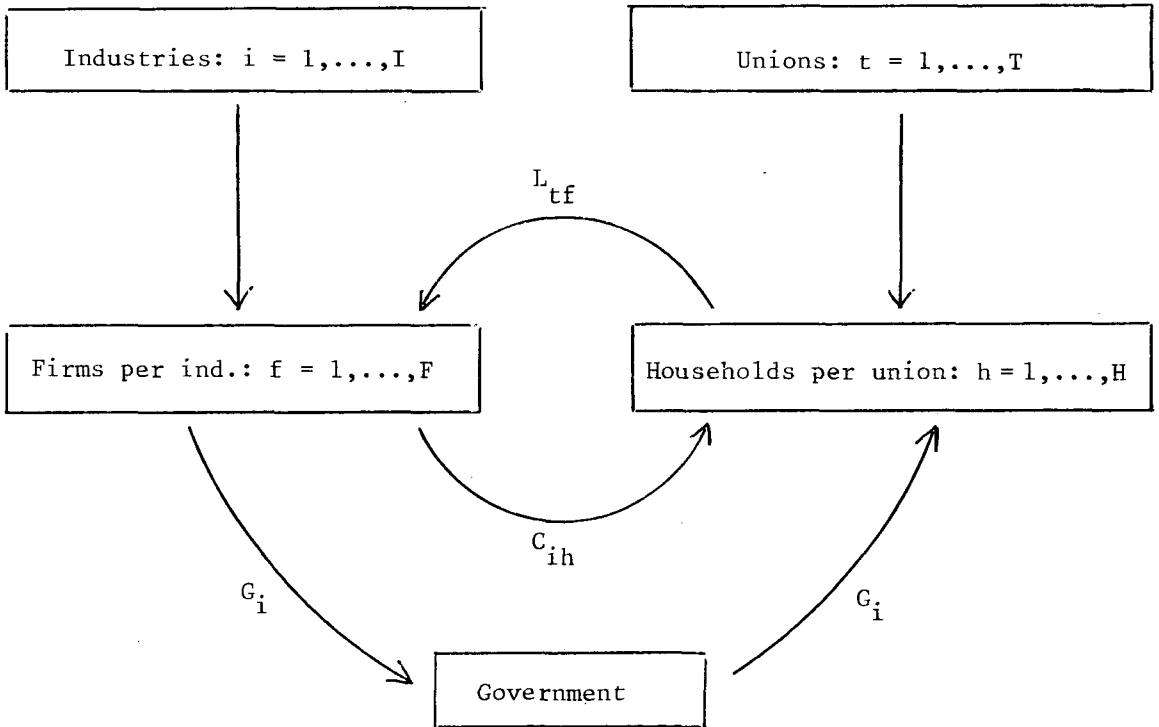

Figure 1: Grouping of Economic Agents

The usual justification for this division of price-quantity decisions among agents is that it economizes on transactions costs. The reason why department stores, airlines, supermarkets, etc. do not make price-quantity bargains with each of their customers is that the cost of negotiating these bargains is prohibitive. Letting a small number of sellers decide the price and a relatively large number of buyers decide individually what amounts to purchase at this price economizes on the informational prerequisites for satisfying the demands and supplies in a market.

To make the price decision, each seller needs to know the demand curve he faces, which means that he needs information on the supply behavior of his few competitors (if any) and the aggregate demand forthcoming in response. To make the quantity decision, each buyer only needs to know the announced price. The reverse set-up - numerous households making the price decision and few firms making their individual quantity decisions - would entail greater transactions costs. For now the numerous buyers would require information on each other's demand behavior and on the aggregate supply and the few sellers would require information on each other's supply behavior. Alternatively, bilateral price-quantity bargains between each buyer and seller would imply even greater information requirements.

These matters have not been spelled out rigorously in the literature on imperfect competition. Authors in this area have simply made the plausible assumption (supported by casual observation) that the above-mentioned division of decision-making obtains in markets with heavily and lightly populated sides. This practice is followed here.

2c. Microfoundations of the Macromodel

The set-up has a Keynesian flavor since the sellers in the product and labor markets are the ones who are being "rationed". This circumstance is due to the assumption that the sellers are on the lightly populated sides of their markets and thus they become price setters, facing demand curves for their commodities. (The buyers in all markets are perfect competitors.) The firm's product demand curve (which depends, among other things, on its product price) takes the place of its nonmanipulable product demand constraint in the conventional "reappraisal-of-Keynes" models, and the union's labor demand curve (which depends, among other things, on the wage) takes the place of the household's nonmanipulable labor demand constraint.

The standard Keynesian macro model which has emerged from the literature on the "reappraisal of Keynes" is constructed from microfoundations in which groups of identical agents face rigid wages and prices. All firms are commonly assumed to be alike, each producing a homogenous output by means of a homogenous labor input, and all households are also assumed to be alike, each consuming a homogenous product and supplying a homogenous labor service. Consequently, the aggregate supplies and demands in the labor and product markets are simply equal to an individual agent's supply and demand in these markets multiplied by the number of agents of that type in the economy.

By contrast, this paper constructs a macroeconomic model from microfoundations in which agents are imperfectly competitive on account of product and labor-service differentiation. These microfoundations must be erected on different principles from

those underlying the reappraisal-of-Keynes models, since products and labor services are not homogenous. Thus, the demands for and supplies of products of different types cannot be added to one another to yield economy-wide product demands and supplies. Similarly, the economy-wide labor demands and supplies cannot be derived by summing over different labor markets.

Instead of assuming that all firms and all households are alike - which they are not, since different firms may produce products of different types and different households may supply labor of different types - we assume that all firms' production functions and all households' utility functions are "identical" and "symmetric". All production functions are identical in the sense that they have the same functional forms (for example, in the case of two products, Q_1 and Q_2 , and two types of labor L_1 and L_2 , $Q_1 = f(L_1, L_2)$ and $Q_2 = f(L_1, L_2)$). They are symmetric in that the various types of labor needed to produce a particular output enter the production function in the same way (for example, $f(L_1, L_2) = f(L_2, L_1)$). Similarly, all utility functions are identical by virtue of their identical functional forms (for example, for two households with utility functions U_1 and U_2 , supplying labor of types L_1 and L_2 , $U_1 = U(Q_1, Q_2, L_1)$ and $U_2 = U(Q_1, Q_2, L_2)$); they are symmetric since the products consumed by each household enter the utility function in the same way (for example, $U(Q_1, Q_2, L_1) = U(Q_2, Q_1, L_2)$).

The upshot of these assumptions is to make the demand functions alike and the supply functions alike in all labor and all product markets. The identity and symmetry of all product functions implies that the aggregate demand for labor of type t -

the sum of the (identical) demands by all firms bidding for this labor - has the same functional form as the aggregate demand for any other labor type. Also, the identity and symmetry of all utility functions implies that the aggregate supply of type-t labor - the sum of the (identical) supplies by all households offering this labor - has the same functional form as any other aggregate labor supply. Consequently, the type-t labor market serves as a microcosm of the economy-wide labor market.

The same may be said of the type-i product market. The identity and symmetry of all utility functions and all production functions means that the aggregate demand for and supply of product i have the same functional forms as any other product demand and supply, respectively. Thus, the type-i product market is a small version of its economy-wide counterpart.

2d. Monopolistic Competition

As an imperfectly competitive general equilibrium model, the model presented here falls within the tradition established by Benassy (1976, 1978), Grandmont-Laroque (1976), Negishi (1978), Hahn (1978), Hart (1982), and others. We will assume that, in equilibrium, the price setters know the true demand curves facing them and, in this respect, our model has particular affinity to the last two references.

As noted, the imperfect competition of the model here is akin to Chamberlain's monopolistic competition in three respects: (i) products and labor services are differentiated; (ii) each price setter in a particular market recognizes that his actions, by themselves, have no effect on the behavior of agents in other

markets, and (iii) free entry of firms into each product market reduces all firms' profits to zero.

Whereas (i) specifies the "monopolistic" element in monopolistic competition, (ii) and (iii) describe the "competitive" elements. On account of (iii), we obviously must allow for the possibility of more than one firm in each product market. Yet whereas the number of firms in each product market is sufficiently large to eliminate all profits, it is not large enough (as stipulated below) to eliminate firms' monopoly power in their product markets (i.e. not large enough to make the product demand curves they face perfectly elastic.)

Characteristics (i) and (iii) are straightforward; characteristic (ii) needs further motivation. Each firm assumes that variations in its product price have no effect on the price-quantity decisions of agents in the labor markets and the other product markets, and each union assumes that variations in its wage have no repercussions on the product markets and the other labor markets.

This assumption is justified if each seller has some monopoly power in the particular market in which he sells, but none in any other market. Hart's (1978) analysis implies that this condition holds whenever each seller is of significant size relative to his market, but of negligible size relative to every other. Loosely speaking, a seller is of negligible size in his market whenever the expenditure on his product occupies a negligible proportion of each buyer's total budget; otherwise the seller is of significant size.

In order for each union t to have monopoly power in the type- t labor market and the buyers in that market to have none, we assume the following:

- (A1) Each industry uses a sufficiently small subset of all the labor types so that each union t is of significant size relative to the type- t labor market.
- (A2) Each labor type is demanded by a sufficiently large number of industries so that each industry demands a negligible proportion of each labor type.¹

Similarly, in order for each firm f in industry i to have monopoly power in the type- i product market and the buyers in that market to have none, we make the following assumptions:

- (A3) Each household consumes a sufficiently small subset of all firms' products so that each firm f is of significant size relative to its type- i product market.
- (A4) The product of each firm is demanded by a sufficiently large number of households so that all the households belonging to a particular union demand a negligible proportion of each firm's output.^{2,3}

Furthermore, the activity of each union t in its labor market has a negligible effect on all other markets whenever assumption (A4) holds and

- (A5) The distribution of labor types among firms is such that all the firms which demand labor of type t , taken together, demand a negligible proportion of the aggregate demand for any other labor type.

Similarly, the activity of each firm f in industry i has a negligible effect on all other markets whenever assumption (A2) holds and

- (A6) The distribution of firms' outputs among households is such that all the households which demand one firm's product, taken together, demand a negligible proportion of the aggregate demand for any other firm's product.

Finally, in order for each labor market and each product market to be a small version of economy-wide labor and product markets, respectively, we assume the following:

- (A7) Each firm uses the same number of labor types.
- (A8) Each labor type is demanded by the same number of firms.
- (A9) Each household consumes the same number of products.
- (A10) Each firm's output is demanded by the same number of households.
- (A11) Each firm faces the same, exogenously given, government demand for its product.

3. Behavior of the Imperfectly Competitive Agents

3a. The Firms

Each firm sets its product price and makes its employment decision so as to maximize its profit subject to its product demand functions and its production function. Since it has monopoly power in its product market but none in any other market, it takes the prices of all other products and the wages of all labor types as given.

All firms in an industry are identical in that (a) they produce identical outputs, (b) they hire identical sets of labor types, (c) they use identical technologies, (d) they face the same wages, and (e) they face the same demand functions for their products.⁴

When examining the effects of government employment policy on production-employment and wage-price decisions in Section 4, it will be convenient to rule out those effects which operate via induced changes in the number of firms per industry. To do so, we make two simplifying assumptions:

- (i) Each firm in an industry recognizes that it is the same as all other firms in that industry. Thus, its price setting and employment decisions are made under the presumption that all other firms in the industry make the same decisions.
- (ii) Each firm's production function exhibits constant returns to scale.

Recall that each firm in an industry uses a "small" subset of all the labor types.⁵ For expository implicity (but without substantial loss of generality), we assume that each firm requires just one type of labor. Thus, the firm's production function may be expressed as $L_{tf}^D = J(Q_{if}^S)$, where L_{tf}^D is the demand for type- t

labor by firm f and Q_{if}^S is the supply of type- i product by firm f . (Since all production functions are assumed to have the same functional form, J is not subscripted by firm or industry.) The production function satisfies $J' > 0$ and $J'' = 0$.

Let P_i and W_t be the price of product i and the wage of labor t , respectively. (Since each firm in an industry knows that it sets the same price as all other firms in that industry, P_i is not subscripted by firm. Since all firms face the same wages, W_t is not subscripted by firm either.) The firm's profit may be expressed as $\pi_{if} = P_i \cdot Q_{if}^S - W_t \cdot L_{tf}^D - A$. "A" may be interpreted either as a fixed cost of production (paid as a lump sum to the households) or as a lump-sum tax (levied by the government).

The aggregate demand for product i is the sum of the government and household demands for this product (G_i and C_i , respectively). C_i may be derived from the households' optimization programs, to be considered below. According to these programs, $C_i = C_i(P_i, G_i)$.⁶ Since each firm in industry i has an equal share of the demand for product i and since each firm perceives its product demand correctly, its perceived product demand function may be expressed as $Q_{if}^D = (1/F) \cdot [C_i(P_i, G_i) + G_i]$, where F is the number of firms per industry.

Thus, the behavior of firm f in industry i may be summarized by the following optimization program:

$$(1) \quad \text{Maximize } \pi_{if} = P_i \cdot Q_{if}^S - W_t \cdot L_{tf}^D - A$$

$$\text{subject to } Q_{if}^S = (1/F) \cdot [C_i(P_i, G_i) + G_i]$$

$$L_{tf}^D = J(Q_{if}^S),$$

where the endogenous variables are P_i , Q_{if}^S , and L_{tf}^D ; W_t , F , and G_i are exogenous to the firm's decision making.

Solving the firm's problem yields an equation for the profit-maximizing value of P_i :

$$(2) \quad \frac{d\pi_{if}}{dP_i} = [C_i(P_i, G_i) + G_i] + [P_i - W_t \cdot J'] \cdot C_i^P = 0,$$

where $C_i^P = (\partial C_i / \partial P_i) < 0$. (The second-order condition for profit maximization is assumed satisfied.)⁷

Equation (2) shows that, for a given production function and product demand function, the firm's product price depends on the wage W_t and the level of government expenditure G_i . Letting $(d\pi_{if}/dP_i) = \psi$, equation (2) may be rewritten in shorthand form:

$$(2') \quad \psi(P_i, W_t, G_i) = 0,$$

where

$$(2a) \quad \left. \frac{\partial P_i}{\partial W_t} \right|_{\psi=0} = \frac{1}{2} \cdot J' = a > 0$$

("a" is a constant) and

$$(2b) \quad \left. \frac{\partial P_i}{\partial G_i} \right|_{\psi=0} = - \frac{1 + C_i^G}{2 \cdot C_i^P} > 0,$$

where $C_i^G = (\partial C_i / \partial G_i) > 0$ and (for simplicity⁸) we have used the first-order approximation of the consumption function: $C_i^P < 0$ and $C_i^{PP}, C_i^{PG} = 0$. In other words, the firm reacts to an increase in the union t 's wage offer and to an increase in the government expenditure i by raising its product price.

The firm's product supply function and labor demand function may be derived from the reaction function above:

$$(3a) \quad Q_{if}^S = Q_{if}^S(W_t, G_i)$$

(-) (+)

where $\frac{\partial Q_{if}^S}{\partial W_t} = \left(\frac{1}{2 \cdot F}\right) \cdot C_i^P \cdot J' < 0$

and $\frac{\partial Q_{if}^S}{\partial G_i} = \left(\frac{1}{2 \cdot F}\right) \cdot [1 + C_i^G] > 0;$

$$(3b) \quad L_{tf}^D = L_{tf}^D(W_t, G_i)$$

(-) (+)

where $\frac{\partial L_{tf}^D}{\partial W_t} = \left(\frac{1}{2 \cdot F}\right) \cdot C_i^P \cdot (J')^2 = L_{tf}^W < 0$

$$\frac{\partial L_{tf}^D}{\partial G_i} = \left(\frac{J'}{2 \cdot F}\right) \cdot [1 + C_i^G] = L_{tf}^G > 0$$

Recall that each labor type is demanded by a "large" number of industries. Let I_t be the number of industries requiring labor of type t . Then the aggregate demand for this type of labor is

$$L_t = I_t \cdot F \cdot L_{tf}^D(W_t, G_i).$$

3b. The Unions

As mentioned above, the households which supply a particular type of labor (say, type t) join a single trade union (union t). All households in a particular union are alike in that (a) their utility functions have the same functional forms and (b) they receive the same wage incomes.

Each union is assumed to represent the interests of its member households, in the sense that its objective function and budget constraints are the sum of its members' utility functions and budget constraints, respectively.

Each union t sets the wage W_t , thereby determining the total amount of employment available to its members. It divides this employment equally among them. Each member household uses its labor income to buy consumption goods. (Recall that profits are driven to zero and thus households earn no profit income.)

Each union maximizes its utility function subject to its labor demand function and its budget constraint. Since it has monopoly power in its labor market but none in any other market, it takes the wages set by all other unions and the prices of all products as given.

As noted, each household consumes a "small" subset of all product types. For simplicity (but once again without any substantial loss of generality), we assume that it consumes only one type of product. However, all the households belonging to a single union consume several products (as implied by footnote 3). For simplicity, let us assume that no product is consumed by the members of more than one union.⁹ Then our microfoundations require that, since each type- t labor is demanded by I_t different industries, the members of each union consume I_t different products.

The behavior of union t may be summarized by the following optimization program:

$$(4) \quad \text{Maximize } U = U\left(\underbrace{C_i^D}_{i \in S_t}, L_t^S, \underline{G_i}\right)$$

subject to $L_t^S = I_t \cdot F \cdot L_{tf}(W_t, G_i)$

$$\sum_{i \in S_t} P_i \cdot C_i^D = W_t \cdot L_t^S - P_i \cdot R_t,$$

where S_t is the set of all product types consumed by the members of union t , the first argument of the utility function is a vector of all these product types, L_t^S is the aggregate type- t labor supply, the third argument of the utility function is a vector of all public goods, and $P_i \cdot R_t$ is the value of the lump-sum taxes paid by the member households.¹⁰ (Since the utility functions of all unions have the same functional form, U is not subscripted by union.) Note that each union correctly perceives its labor demand function. Let $U_C = (\partial U / \partial C_i^D) > 0$ for all $i \in S_t$ (by symmetry), $U_L = (\partial U / \partial L_t^S) < 0$, $U_G = (\partial U / \partial G_i) > 0$ or all i ; U_{CC} , $U_{LL} < 0$ and all cross partial derivatives are equal to zero. The endogenous variables are W_t , C_i^D , and L_t^S ; P_i , I_t , F , and G_i are exogenous.

Solving the union's problem yields an equation for the utility-maximizing value of W_t :

$$(5) \quad [U_L + U_C \cdot (\frac{W_t}{P_i})] \cdot L_{tf}^W + U_C \cdot (\frac{1}{P_i}) \cdot L_{tf} = 0.$$

(The second-order condition for utility maximization is assumed satisfied.)¹¹

Equation (5) indicates that, given the union's preferences and labor demand function, the union's wage offer depends on the product price P_i and the level of government expenditure G_i .

Equation (5) may be rewritten as

$$(5') \quad \phi(W_t, P_i, G_i) = 0,$$

where

$$(5a) \quad \left. \frac{\partial W_t}{\partial P_i} \right|_{\phi=0} = - \left(\frac{1}{2} \right) \cdot \left(\frac{U_L}{U_C} \right) = b > 0$$

("b" is a constant) and

$$(5b) \quad \left. \frac{\partial W_t}{\partial G_i} \right|_{\phi=0} = - \left(\frac{1}{2} \right) \cdot \left(\frac{L_{tf}^G}{L_{tf}^W} \right) > 0,$$

where (for simplicity¹²) we have used the first-order approximation of the labor demand function: $L_{tf}^W < 0$ and $L_{tf}^{WW}, L_{tf}^{WG} = 0$, and assumed that U_{CC} and U_{LL} are negligibly close to zero. In other words, the union reacts to an increase in the price of product i and to an increase in government expenditure i by raising its wage offer.

The union's labor supply function and consumption demand function may be derived from the reaction function above:

$$(6a) \quad L_t^S = L_t^S(P_i, G_i)$$

(-) (+)

where

$$\frac{\partial L_t^S}{\partial P_i} = I_t \cdot F \cdot L_{tf}^W \cdot b < 0,$$

and

$$\frac{\partial L_t^S}{\partial G_i} = \left(\frac{1}{2} \right) \cdot I_t \cdot F \cdot L_{tf}^G > 0;$$

$$(6b) \quad C_i^D = C_i(P_i, G_i)$$

$$\frac{\partial C_i^D}{\partial P_i} = - \frac{W_t}{(P_i)^2} \cdot L_t$$

$$+ \frac{b}{P_i} \cdot [L_t + W_t \cdot I_t \cdot F \cdot L_{tf}^W] = C_i^P < 0, \quad 13,14$$

$$\frac{\partial C_i^G}{\partial G_i} = \left(\frac{1}{2 \cdot P_i} \right) \cdot I_t \cdot F \cdot L_{tf}^G \cdot \left[w_t - \left(\frac{L_{tf}}{L_{tf}^W} \right) \right].$$

C_i^G may be interpreted as a Keynesian marginal propensity to consume. It is the rise in consumption demand due to a rise in wage income, generated by a rise in government expenditure.

3c The Imperfectly Competitive Equilibrium

Thus far, we have examined the price-setting behavior of the firms given the wages determined by the unions and the wage-setting behavior of the unions given the prices determined by the firms. For a given set of government expenditures, equation (2') represents each firm's reaction function and equation (5') represents each union's reaction function. In the imperfectly competitive equilibrium (ICE), these two stories are interrelated.

At the ICE, the following three conditions are satisfied:

(i) the wages faced by the firms are those which maximize the utilities of the unions, (ii) the prices faced by the unions are those which maximize the profits of the firms, and (iii) the number of firms per industry (F) is such that the profit of each firm is zero.

In Figure 2, the reaction functions of a representative firm and a representative union are labelled θ_F and θ_H , respectively. (Equations (2a) and (5a) indicate that both are straight lines.) The wage-price combination (W_t^*, P_i^*) which characterizes the ICE is given by the intersection of these two reaction functions.¹⁵ Thereby conditions (i) and (ii) above are satisfied. Note that neither

reaction function depends on F . Thus, the equilibrium wage-price combination does not depend on the number of firms per industry, which is set to satisfy condition (iii).

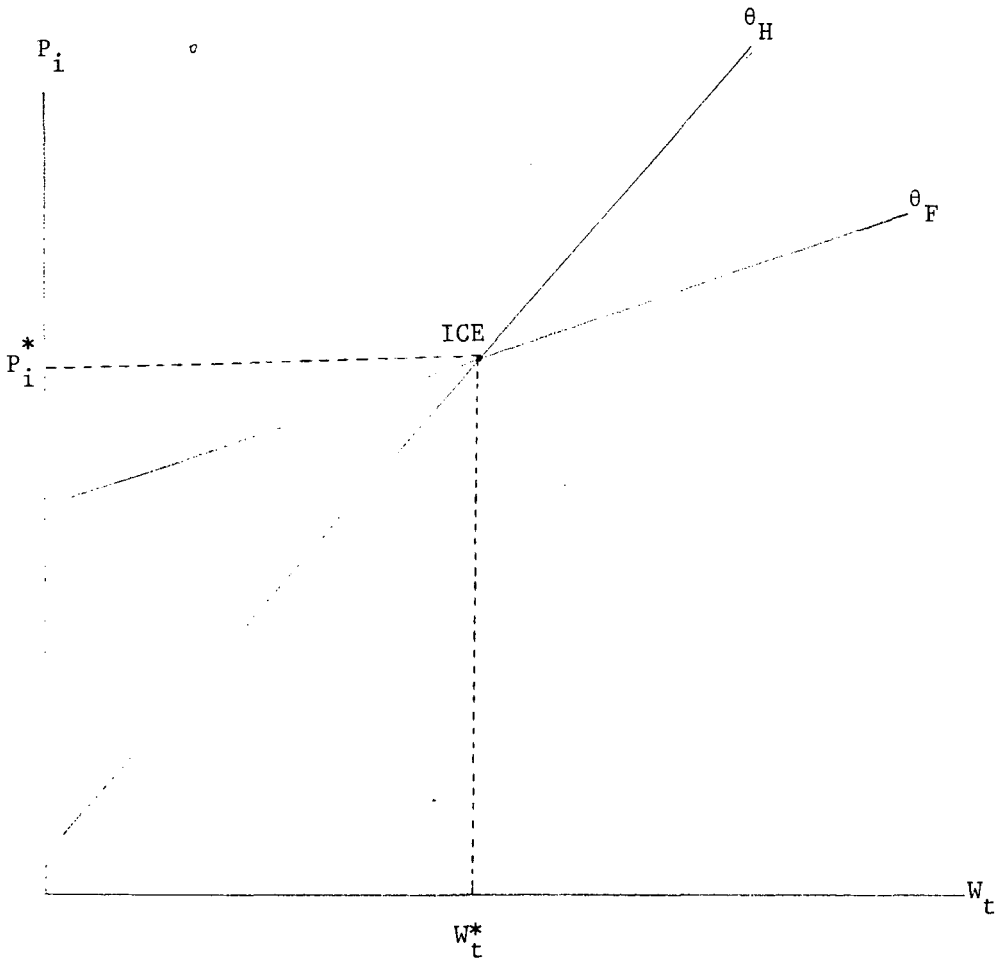

Figure 2: The Imperfectly Competitive Equilibrium

4. The Effectiveness of Government Policy

Suppose that the economy is initially at an imperfectly competitive equilibrium, associated with a given level of government expenditures (falling equally on all firms). Thereupon these government expenditures rise (by equal amounts for every firm). What are the implications of this policy for wages, prices, production, and employment?

In the model outlined above, government expenditures are financed through lump-sum taxation of the households and firms. Yet since the aim of this section is to explore how strong the case for crowding-out is under imperfectly competitive equilibrium conditions, let us break the government's balanced budget constraint in this policy exercise. Two things should be noted about the resulting "helicopter drop" of government expenditures. First, if it can be shown that a rise in government expenditures crowds out private-sector expenditures, then it is trivial to show that this government expenditure increase matched by a lump-sum tax increase crowds out private expenditure even more. Second, the proposed policy exercise could be performed without breaking the government's budget constraint if we were to include fiat money in our economy and let the government expenditure increase be financed through it. For example, we could assume (as is commonly done in the micro-foundations of monetary macroeconomic models) that households demand money as a store of value, whereas firms have no net demand for money since their revenues always cover their costs. In that case, real money balances would enter the households' utility functions and their budget constraints would set consumption plus money balance

accumulation equal to wage income net of household taxes. Then a government expenditure increase financed through money creation leads, via Walras' Law, to a rise in money-balance accumulation by the households.¹⁶ These complications have no effect on the qualitative conclusions of this section, and so, for simplicity, we let government expenditures rise by themselves.

The policy change gives rise to multipliers in wage-price levels and production-employment levels. Let us investigate the wage-price multiplier first. The relation between the levels of wages and prices (on the one hand) and the level of government expenditures (on the other) is given by equations (2') and (5') (the firm's and the union's reaction functions, respectively). Totally differentiating these equations,

$$\frac{dP_i}{dG_i} + \frac{\psi_W}{\psi_P} \cdot \frac{dW_t}{dG_i} + \frac{\psi_G}{\psi_P} = 0$$

$$\frac{dW_t}{dG_i} + \frac{\phi_P}{\phi_W} \cdot \frac{dP_i}{dG_i} + \frac{\phi_G}{\phi_W} = 0$$

Using the properties of the reaction functions (derived above),

$$(7a) \quad \frac{dP_i}{dG_i} - a \cdot \frac{dW_t}{dG_i} = - \left(\frac{1 + C_i^G}{2 \cdot C_i^P} \right)$$

$$(7b) \quad \frac{dW_t}{dG_i} - b \cdot \frac{dP_i}{dG_i} = - \left(\frac{1 + C_i^G}{2 \cdot C_i^P} \right) \cdot \frac{1}{J},$$

Solving the system (7a - b), we obtain the effect of a change in government expenditures on prices

$$(8a) \quad \frac{dP_i}{dG_i} = - \left(\frac{1}{1-a \cdot b} \right) \cdot \left(\frac{1+C_i^G}{2 \cdot C_i^P} \right) \cdot \left(1 + \frac{a}{J'} \right),$$

and on wages

$$(8b) \quad \frac{dW_t}{dG_i} = - \left(\frac{1}{1-a \cdot b} \right) \cdot \left(\frac{1+C_i^G}{2 \cdot C_i^P} \right) \cdot \left(\frac{1}{J'} + b \right).$$

Note that the effect on the real wage is ambiguous.¹⁷

Given these price and wage effects, the associated effect on the production of each output type may be derived. Recall that $Q_i = C_i(P_i, G_i) + G_i$. Thus, using equation (8a),

$$(9a) \quad \frac{dQ_i}{dG_i} = \left(1 + C_i^G \right) - \frac{1}{2} \cdot \left(\frac{1+C_i^G}{1-a \cdot b} \right) \cdot \left(1 + \frac{a}{J'} \right).$$

The effect on the employment of each labor type may be derived as well. Recall that $Q_i = F \cdot Q_{if}$, $L_t = I_t \cdot F \cdot L_{tf}$, and $L_{tf} = J(Q_{if})$. Thus, $L_t = I_t \cdot F \cdot J(Q_i/F)$. Given constant returns to labor, $L_t = I_t \cdot J(Q_i)$. Thus,

$$(9b) \quad \frac{dL_t}{dG_i} = I_t \cdot J' \cdot \left(1 + C_i^G \right) - \frac{1}{2} \cdot I_t \cdot J' \cdot \left(\frac{1+C_i^G}{1-a \cdot b} \right) \cdot \left(1 + \frac{a}{J'} \right).$$

These multipliers may be interpreted in the same way as the standard Keynesian multipliers. According to the Keynesian story, a rise in government expenditures on the output of firms leads these firms to hire more labor; the resulting rise in income leads households to purchase more output of the firms, which in turn leads to more employment, and so on. The Keynesian production and employment multipliers may be portrayed as the resultants of this sequence of events. Analogously, the effect of fiscal policy in our model may also be interpreted in terms of a sequence of reactions by myopic agents.

Suppose that when the government increases its expenditures, each firm believes that the expansion of product demand is specific to its own industry. It does not realize that the boom is an economy-wide phenomenon. Each industry is an "island"; information about product demand on other islands is not instantaneously available. In particular, each firm in industry i perceives the rise in government expenditure on product i (dG_i) and the concomitant rise in private-sector expenditure ($C_i^P \cdot dG_i$), but it assumes that the demand for all other products remains unchanged at its initial ICE level.

Consequently, the firm of each industry reacts by raising its product price as well as its production and employment. Yet since each industry is small relative to the labor market in which it participates, the firms in each industry expect their price-quantity decisions to have no effect on the wages they pay. Given this presumption, the profit-maximizing rise in the price of the i 'th product is

$$(10a) \quad d_1 P_i = \left(\frac{\partial P_i}{\partial G_i} \Big|_{\psi=0} \right) \cdot dG_i = - \left(\frac{1 + C_i^G}{2 \cdot C_i^P} \right) \cdot dG_i > 0,$$

where d_1, d_2, d_3, \dots are the changes taking place in the first, second, third, etc. rounds of the multiplier process.

The associated changes in production and employment are

$$(10b) \quad d_1 Q_i = C_i^P \cdot d_1 P_i + (1 + C_i^G) \cdot dG_i \\ = \frac{1}{2} \cdot (1 + C_i^G) \cdot dG_i > 0$$

$$(10c) \quad d_1 L_t = \frac{1}{2} \cdot I_t \cdot J' \cdot (1 + C_i^G) \cdot dG_i > 0$$

The wages set by the unions are initially at their original ICE level. Now each union finds that, at its initial wage, the prices of the products its members consume have each risen by an amount given in (10a) and the labor demand curve it faces (relating its labor demand to its wage) has shifted by an amount given in (10c). Each union believes that both the price and employment changes are specific to its members. Thus, it raises its wage offer. However, since each union is small relative to the product markets in which it participates, it expects its wage change, as well as the associated change in its members' consumption, to have no effect on the product prices its members pay. Thus, each union's optimal wage increase is

$$\begin{aligned}
 (10d) \quad d_1 W_t &= \left(\frac{\partial W_t}{\partial P_i} \bigg|_{\phi=0} \right) \cdot d_1 P_i + \left(\frac{\partial W_t}{\partial G_i} \bigg|_{\phi=0} \right) \cdot dG_i \\
 &= - \left(\frac{1 + C_i^G}{2 \cdot C_i^P} \right) \cdot \left(b + \frac{1}{J'} \right) \cdot dG_i > 0
 \end{aligned}$$

In the second round of the multiplier process, each firm faces a situation different from that in the first round: government expenditure on its product remains unchanged at its first-round level, but the cost of its labor has risen. Each firm believes that the wage rise is specific to its own industry. Thus, each firm's optimal price adjustment is

$$\begin{aligned}
 (11a) \quad d_2 P_i &= a \cdot d_1 W_t = \\
 &= - a \cdot \left(\frac{1 + C_i^G}{2 \cdot C_i^P} \right) \cdot \left(b + \frac{1}{J'} \right) \cdot dG_i > 0
 \end{aligned}$$

and the associated adjustments in production and employment are

$$(11b) \quad d_2 Q_i = C_i^P \cdot d_2 P = -a \cdot \left(\frac{1 + C_i^G}{2} \right) \cdot \left(b + \frac{1}{J'} \right) \cdot dG_i$$

$$(11c) \quad d_2 L_t = -I_t \cdot J' \cdot a \cdot \left(\frac{1 + C_i^G}{2} \right) \cdot \left(b + \frac{1}{J'} \right) \cdot dG_i.$$

Each union also faces a different situation from that in the first round of the multiplier process: its labor demand curve has not shifted (since government expenditures remain at their first-round level), but the product prices which its members face have risen. Thus, it adjusts its wage accordingly:

$$(11d) \quad d_2 W_t = b \cdot d_2 P_i =$$

$$= -b \cdot a \cdot \left(\frac{1 + C_i^G}{2 \cdot C_i^P} \right) \cdot \left(b + \frac{1}{J'} \right) \cdot dG_i > 0$$

The third round of the multiplier is analogous to the second. The price and wage changes are

$$d_3 P_i = a \cdot d_2 W_t$$

$$d_3 W_t = b \cdot d_3 P_i.$$

In order for the multiplier process to be stable, $a \cdot b < 1$. We assume this to be the case (making the standard use of the correspondence principle).

Summing the entire sequence of price effects (equations (10a), (11a), etc.) yields the price multiplier of equation (8a). Similarly, the sum of the wage effects (equations (10d), (11d), etc.) yields the wage multiplier of equation (8b) and the sum of the production and

employment effects yields the production and employment multipliers of equations (9a) and (9b), respectively.¹⁸

It is interesting to note that in this imperfectly competitive economy, government expenditure crowds out private-sector expenditure. The immediate impact of a rise in government expenditure on production (before firms and unions begin to change their prices and wages, respectively) is

$$\left(\frac{dQ_i}{dG_i} \right)_{\text{initial}} = (1 + C_1^G).$$

The production multiplier (9a) is the sum of this term plus another which is unambiguously negative. Thus,

$$\left(\frac{dQ_i}{dG_i} \right)_{\text{initial}} > \left(\frac{dQ_i}{dG_i} \right).$$

In other words, the initial fiscal policy impact is invariably greater than the final impact (after the private sector has reacted fully).

Proposition: In the imperfectly competitive economy above, government expenditure invariably crowds out private-sector expenditure.

If $(1 - a \cdot b) > \frac{1}{2} \cdot (1 + \frac{a}{J})$, then $\frac{dQ_i}{dG_i} > 0$ and thus there is partial, perfect, and multiple crowding-out, respectively.

In sum, a rise in government expenditure conjointly elicits a wage-price spiral and a crowding-out of production and employment. The mechanism whereby this happens is illustrated in Figure 3. The price and quantity effects are interrelated because the firms and the households each make a price decision together with a quantity

decision. As shown, in response to a government expenditure increase, firms raise the price level and the employment level; households react by raising the wage level and reducing consumption. In all subsequent rounds, firms respond to household activity by raising the price level and reducing employment, whereupon households raise the wage level and reduce consumption. In this manner, the crowding-out effect of government expenditures may be explained.

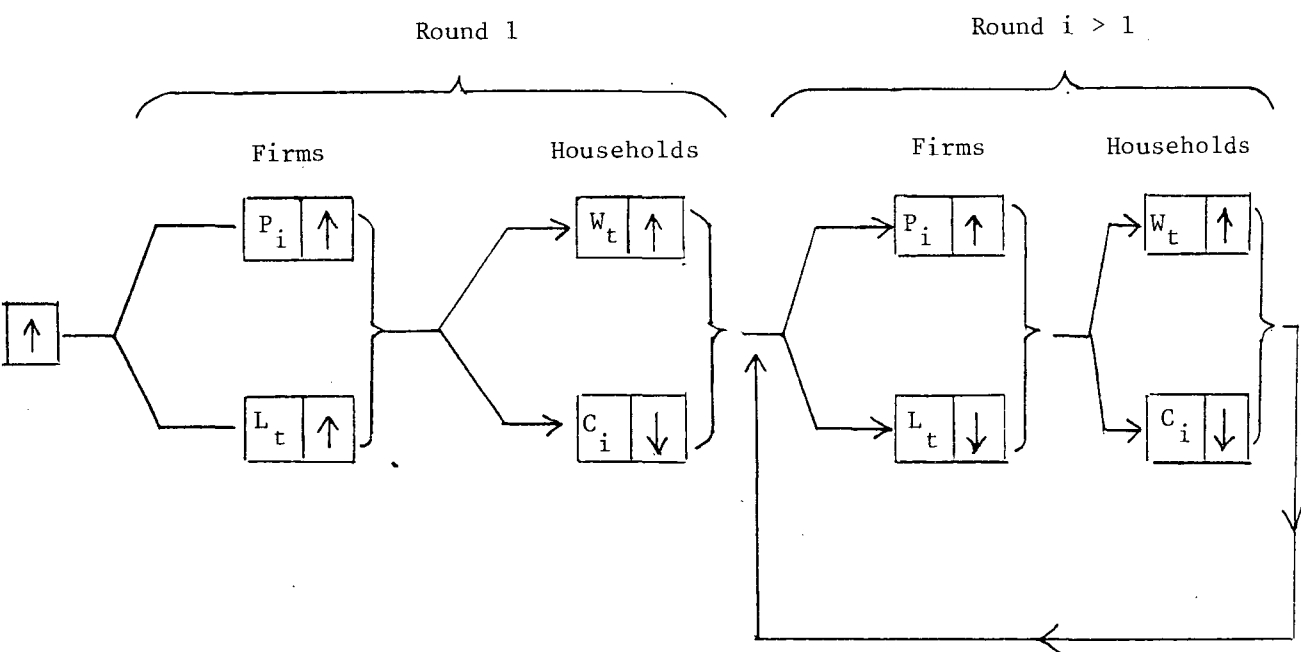

Figure 3: The Interaction of the Wage-Price Multiplier and the Employment Multiplier.

5. Under-Employment and Trading Efficiency

The imperfectly competitive equilibrium is invariably characterized by under-employment, in the sense that the ICE level of employment always falls short of the socially optimal level. To demonstrate this proposition, let us compare the first-order conditions for social optimality (on the one hand) with those for profit-maximization and utility-maximization under ICE (on the other).

The socially optimal levels of employment, consumption, and government expenditure may be determined by solving the following optimization problem:

$$(12) \text{ Maximize } \sum_{t=1}^T U(C_i, L_t, G_i)$$

$$\text{subject to } L_t = \sum_{j \in E_t} J(Q_j) \quad \text{for } t = 1, \dots, T$$

$$Q_i = C_i + G_i \quad \text{for } i = 1, \dots, I$$

where E_t is the set of all industries j requiring labor of type t .

The first-order conditions for social optimality may be reduced to

$$(13a) \quad U_C - U_G = 0 = \xi^{SO}$$

$$(13b) \quad U_C + U_L \cdot J' = 0 = \xi^{SO}$$

("SO" stands for "social optimum".) These two conditions are

pictured in Figure 4, where C_i^{SO} and G_i^{SO} denote the socially optimal levels of consumption and government expenditure on product i , respectively.

This social optimum cannot be attained through the ICE. The reaction function of the imperfectly competitive firm (2') implies that

$$(14a) \quad \frac{W_t}{P_i} < \frac{1}{J^r} .$$

Moreover, the reaction function of the imperfectly competitive union (5') implies that

$$(14b) \quad - \left(\frac{U_L}{U_C} \right) < \frac{W_t}{P_i}$$

Consequently, at the ICE,

$$(15) \quad - \left(\frac{U_L}{U_C} \right) < \frac{1}{J^r} .$$

However, the social optimality condition (13b) may be rewritten as

$$(13b') \quad - \left(\frac{U_L}{U_C} \right) = \frac{1}{J^r} .$$

Thus, in Figure 5, the imperfectly competitive relation between consumption and government expenditure ($\xi^{ICE} = 0$) lies everywhere beneath the socially optimal relation between these variables ($\xi^{SO} = 0$). Suppose that government expenditure is set at its

socially optimal level, G_i^{SO} . Then consumption under imperfect competition falls short of its socially optimal level by $(C_i^{SO} - C_i^{ICE})$ and employment under imperfect competition falls short of its socially optimal level by $u_t = (L_t^{SO} - L_t^{ICE})$.

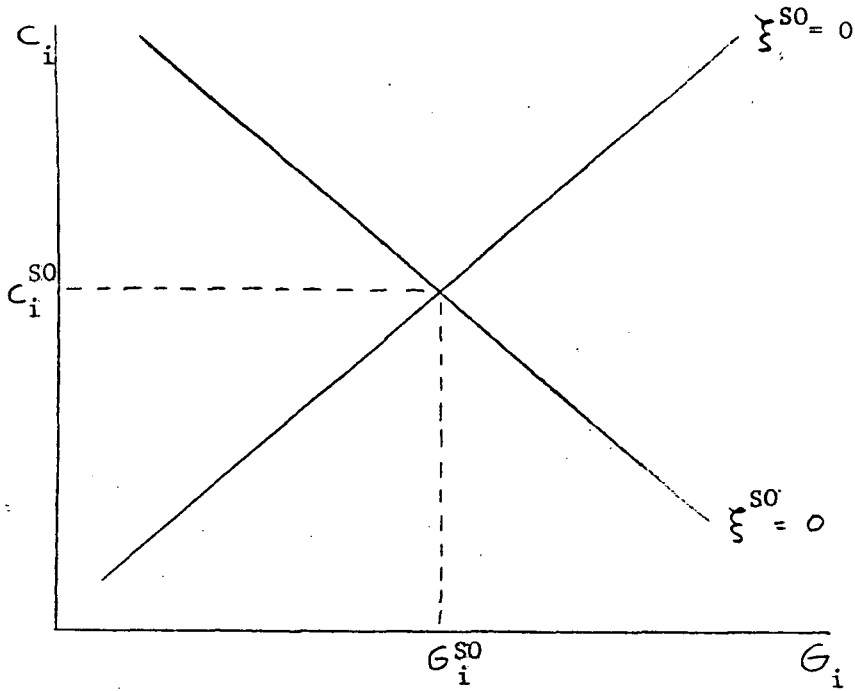

Figure 4: The Social Optimum.

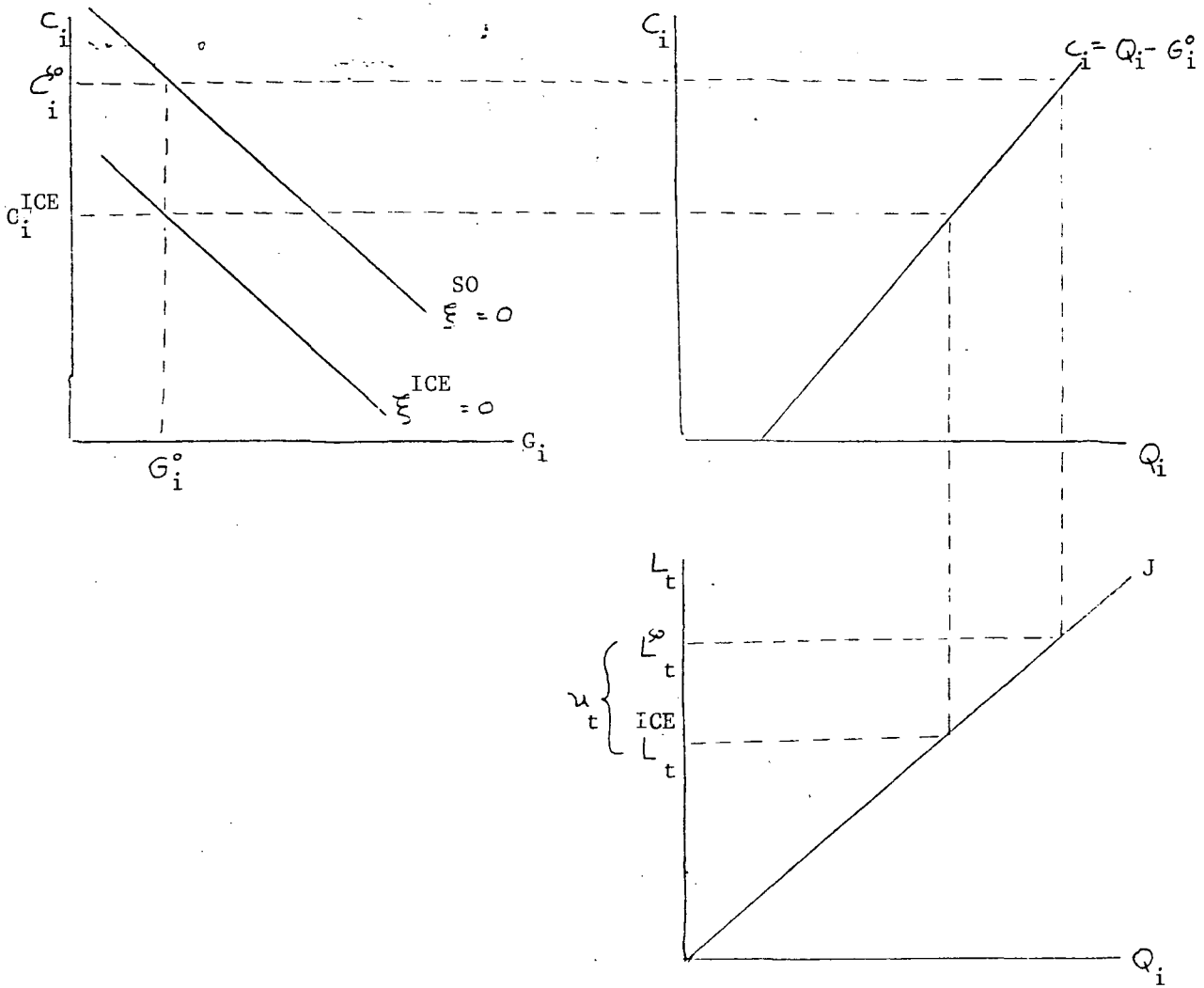

Figure 5: The Level of Under-Employment generated by the Imperfectly Competitive Equilibrium.

u_t is our measure of under-employment generated through the imperfectly competitive equilibrium.

An interesting rationale for the existence of under-employment under imperfect competition is that imperfectly competitive trades are always allocatively inefficient. This may be demonstrated quite simply by considering the firms' iso-profit loci and the unions' iso-utility loci. The former family of loci (for a representative firm)

$$\left. \frac{dw_t}{dP_i} \right|_{\pi_{if} = \text{constant}} = - \frac{\partial \pi_{if} / P_i}{\partial \pi_{if} / W_t}$$

is depicted in Figure 6. Clearly, the higher loci are associated with lower profits. Thus, for any given W_t , the firms choose that price which permits the lowest possible iso-profit locus to be attained. In other words, the wage-price combination which the firms select are given by the set of points at which the iso-profit loci are horizontal. In this manner we trace out the θ_F curve (of Figure 2).

The family of iso-utility loci (for a representative union) is pictured in Figure 7. The rightward loci are associated with lower utility. Thus, for any given P_i , the union chooses that wage which allows the leftmost possible iso-utility locus to be reached. Consequently, the wage-price combinations which the unions select are given by the set of points at which the iso-utility loci are vertical. This exercise yields the θ_H curve (of Figure 2).

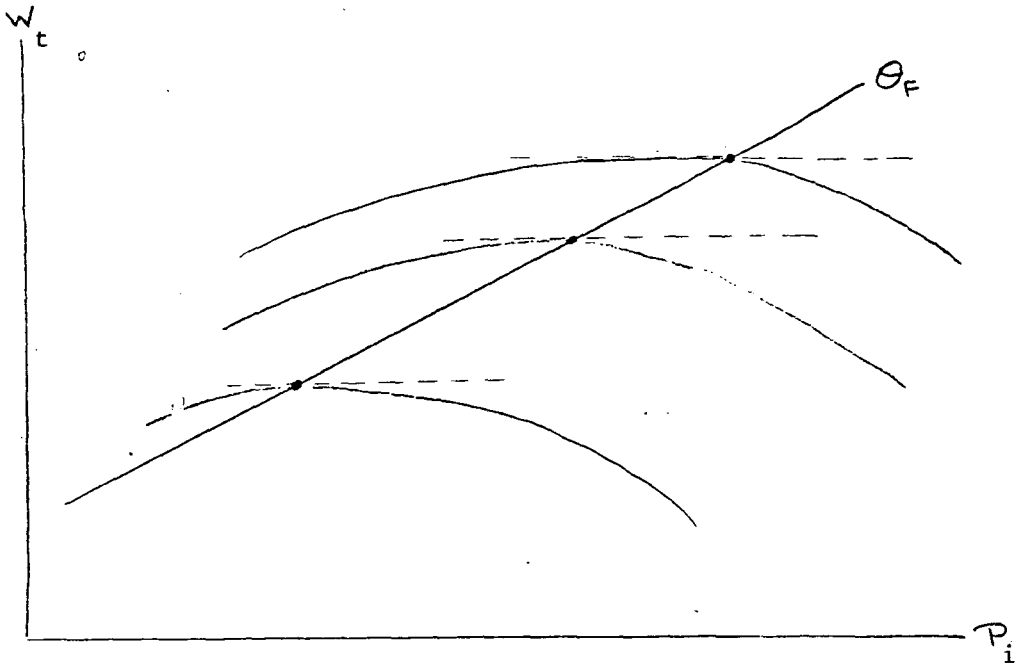

Figure 6: The Iso-Profit Loci and the Firm's Selected Wage-Price Combinations.

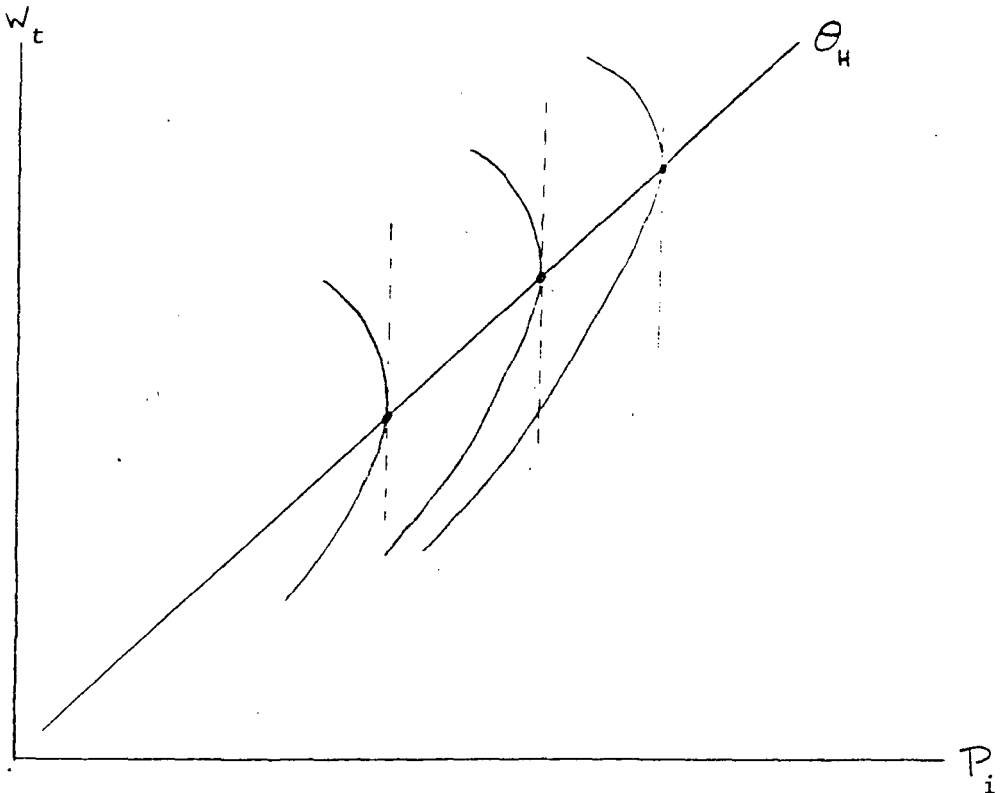

Figure 7: The Iso-Utility Loci and the Union's Selected Wage-Price Combinations.

As noted above, the imperfectly competitive equilibrium lies at the intersection of the θ_F and θ_H curves. Since the iso-profit locus is horizontal and the iso-utility locus is vertical at this intersection point, the two loci (which are everywhere continuously differentiable) must cross one another. Yet in that event, the trades of consumption and labor which takes place between the firms and the unions cannot be allocatively efficient. Efficient trades occur when, for any given iso-profit locus, the unions attain the leftmost possible iso-utility locus (or, equivalently, for any given iso-utility locus, the firms attain the lowest possible iso-profit locus). In other words, efficient trades occur at the points of tangency between the iso-profit and iso-utility loci. These trades are depicted by the ET curve in Figure 8. As shown the ET curve passes to the left of the imperfectly competitive equilibrium point (ICE in Figure 8).

In order to compare the employment implications of efficient versus imperfectly competitive trades, it is convenient to characterize these trades in terms of consumption and government expenditure. The set of all efficient trades may be generated by the following optimization problem:

$$(16) \quad \text{Maximize } V = \sum_{i=1}^I \sum_{f=1}^F \left(\frac{\pi_{if}}{P_i} \right) + \sum_{t=1}^T U(C_i, L_t, G_i) \\ \text{subject to } \sum_{f=1}^F \left(\frac{\pi_{if}}{P_i} \right) = k_i \cdot Q_i \text{ for } i=1, \dots, I$$

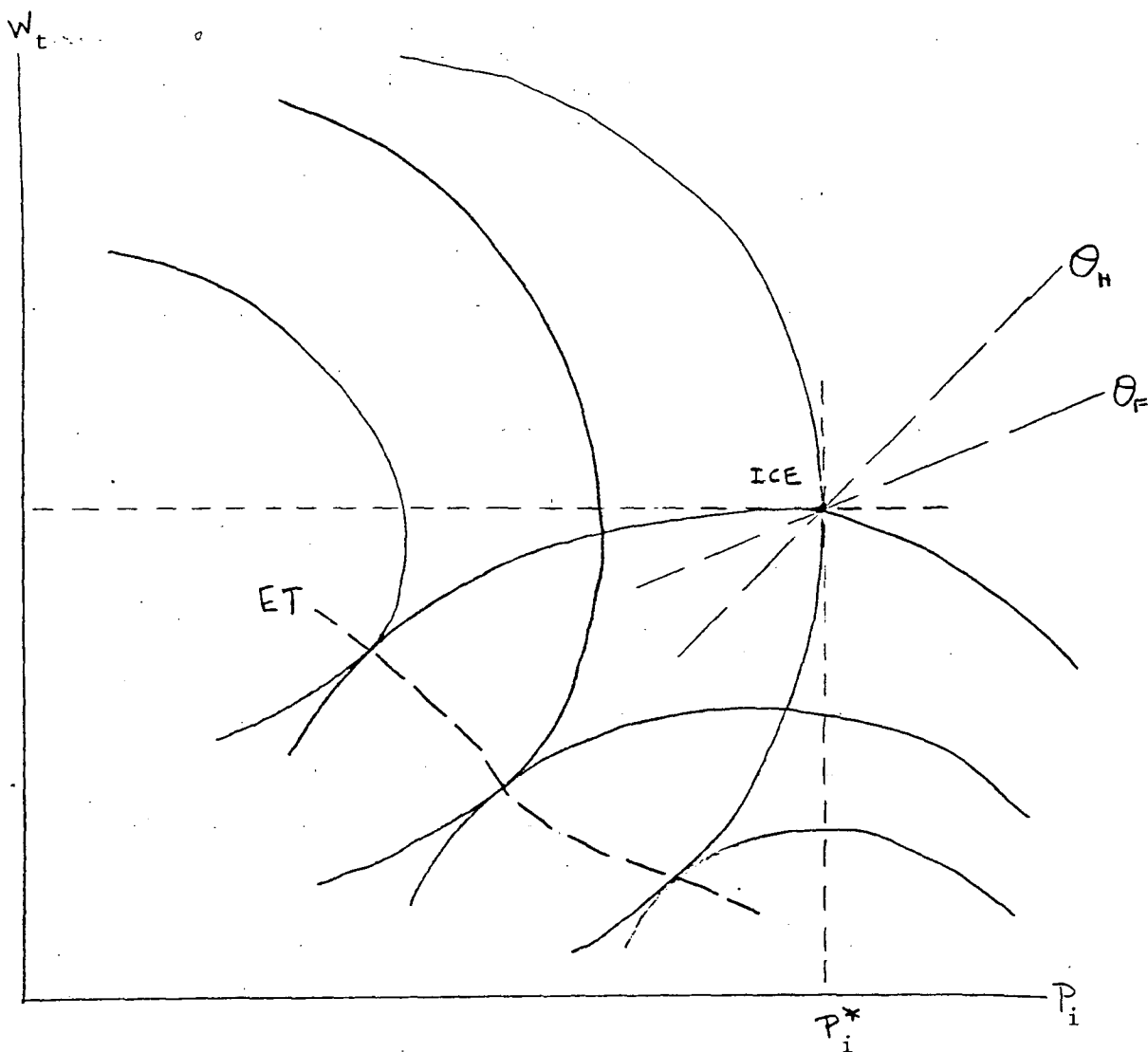

Figure 8: Efficient Trades and the Imperfectly Competitive Equilibrium

$$Q_i = C_i + G_i \quad \text{for } i = 1, \dots, I,$$

$$L_t = \sum_{j \in E_t} J(Q_j) \quad \text{for } t = 1, \dots, T$$

where G_i and k_i ($i=1, \dots, I$) are exogenous and $0 \leq k_i \leq 1$. Here the allocation of resources is not governed by imperfectly competitive agents, but rather by a hypothetical dictator who enforces allocative efficiency. Maximizing the sum of all real profits and utilities ensures that the iso-profit loci are tangent to the iso-utility loci (viz., that it is impossible to raise profit without reducing utility). The parameters k_i determine which point of tangency is to be selected. As the k_i 's span the real numbers between zero and unity, the entire set of efficient trades is covered.

The first-order conditions for efficient trades are

$$(17) \quad k_i + U_c + U_L \cdot J' = 0 = \xi^{ET}, \quad \text{for } i = 1, \dots, I.$$

This condition implies that $-(U_c/U_L) \leq J'$. Recall that social optimality requires that $-(U_c/U_L) = J'$, whereas under imperfect competition $-(U_c/U_L) > J'$. In Figure 9, $\xi^{SO} = 0$ and $\xi^{ICE} = 0$ depict the $C_i - G_i$ combinations under social optimality and imperfect competition, respectively, while $\xi^{ET} = 0$ depicts these combinations under efficient trades for $k_i > 0$. (When $k_i = 0$, the $\xi^{SO} = 0$ and $\xi^{ET} = 0$ curves coincide.) Set government expenditure at some exogenously given level, say G_i^{SO} . It is evident from the figure that consumption - and therefore also employment - is always greater under efficient trades than under imperfectly competitive trades. In this way, the under-employment generated through imperfect competition may be explained in terms of the allocative inefficiency of imperfectly competitive trades.

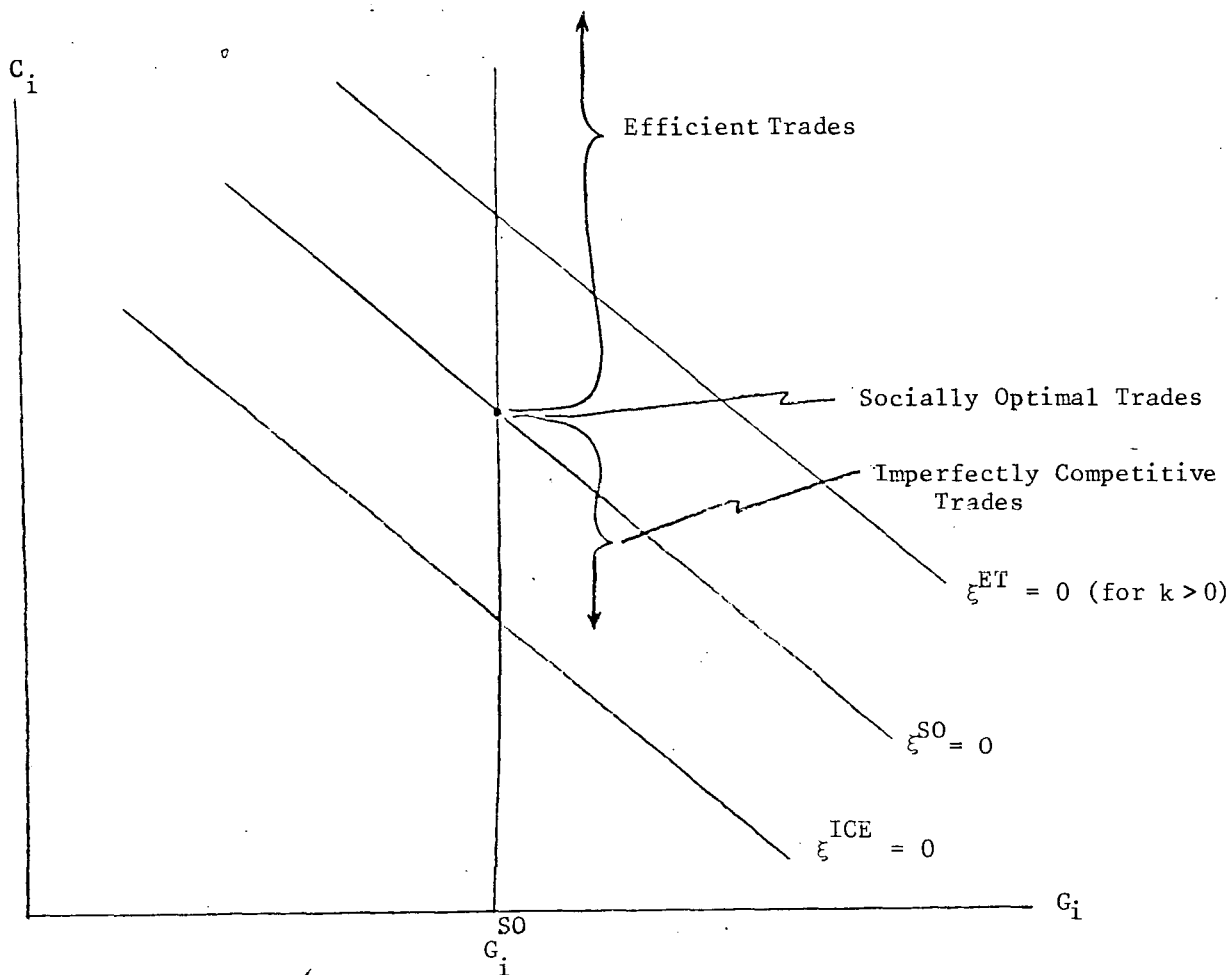

Figure 9: Consumption under Efficient and Imperfectly Competitive Trades.

The previous section showed how government expenditure crowds out private-sector expenditure under imperfect competition. It may now be asked whether the same is true for efficient trades. The answer is affirmative. Totally differentiating condition (17), we find that

$$\frac{dC_i}{dG_i} = - \frac{U_{LL} \cdot (J')^2}{U_{cc} + U_{LL} \cdot (J')^2},$$

which lies between -1 and 0 . Thus, there is partial crowding out when trades are allocatively efficient.

6. Conclusion

In conclusion, this paper shows that moving from a standard Keynesian model in which agents face non-manipulable demand constraints to an imperfectly competitive model in which their demand constraints are price-manipulable means taking a very big step indeed. The former model - which rests on weaker choice-theoretic foundations since it does not explain price-setting behavior - does not mimic the workings of the latter. The nature of unemployment is radically different in the two models: in the former, there is involuntary unemployment due to wage rigidity; in the latter, there is voluntary under-employment due to trading inefficiency. Correspondingly, the effectiveness of government policy is also different in these models: a rise in government expenditure stimulates private-sector expenditure (through inter-market spillovers emerging when wages and prices are fixed) in the Keynesian model, but it reduces private-sector expenditure (via induced changes in wages and prices) in the imperfectly competitive model.

Footnotes

1. If each firm acts independently of all other firms, then it is sufficient to make the less stringent assumptions that (a1) each firm uses a "small" subset of all labor types and (a2) each labor type is demanded by a "large" number of firms. However, given the behavioral assumptions of Section 3, the firms in each industry do not act in isolation, and consequently the assumptions (A1) and (A2) are required.
2. To ensure that the buyers in the type - i product market have no market power, it is sufficient to make the less stringent assumption that each household demands a negligible proportion of each firm's output. The assumption (A4) is required to ensure that the activity of each union t has a negligible effect on every product market (as noted below).
3. Assumptions (A1) and (A2) imply that there are more industries than trade unions in the economy. Assumptions (A3) and (A4) imply that there are more households than firms. In sum, $I > T$ and $T \cdot H > F \cdot I$. Assumption (A4) does not imply that $T > F \cdot I$ (which is impossible, since $T < I$) as long as we do not require that all households belonging to one union consume the same set of products.
4. This is ensured by the forces of competition on the buyers' side of each product market and by the assumption that each firm faces the same, exogenously fixed government demand for its product. Assume an initial state in which the demands for a particular

product i are not distributed equally among the firms in industry i . Each firm's product demand curve (with price and quantity on the vertical and horizontal axes, respectively) is the horizontal sum of the government demand and the downward-sloping demand curve of each of its household customers. The greater the share of aggregate product demand which a firm attracts, the higher its profit maximizing price (given non-decreasing marginal costs). The forces of competition tend to equalize the prices which different firms charge for a particular product and thereby also the demands which these firms face.

5. This is implied by assumption (A1) together with the assumption that all firms in an industry hire identical sets of labor types.

6. As noted below, this consumption function emerges under the simplifying assumption that each household consumes just one type of product. In the absence of this assumption, the consumption function must be expressed differently. Given our assumptions concerning the identity and symmetry of all production functions and all utility functions in the economy, all product prices must be equal in the imperfectly competitive equilibrium (which is assumed unique). Let all prices, except that of product i , be set at their equilibrium level, \tilde{P} . Then the aggregate private-sector demand for product i may be written as $C_i = C_i(P_i, \tilde{P}, G_i)$. This function enters the firm's optimization program, with \tilde{P} exogenous to the firm. In the ICE, $P_i = \tilde{P}$ for all i .

7. In equation (2), the first term of the middle expression is unambiguously positive. In order for the second term to be unambiguously negative, $P_i > W_t \cdot J'$, i.e. the real wage falls short of the marginal product of labor.
8. Provided that the uniqueness and stability of the ICE are preserved, this approximation does not affect the qualitative conclusions of our analysis.
9. Since products can be classified in countless ways (by physical characteristics, location, recipients, etc.) no matter of principle is at stake here.
10. P_i is the price of any product i . Since all product prices are equal in equilibrium and since our analysis is confined to equilibrium conditions, the choice of this product is immaterial.
11. The second term of the left-hand expression is unambiguously positive. In order for the first term to be unambiguously negative, $U_c \cdot (W_t/P_i) > -U_L$, i.e. the real wage must exceed the marginal rate of substitution of consumption for leisure.
12. Once again, our qualitative conclusions are not affected by this assumption, provided that the uniqueness and stability of the ICE are preserved.
13. Recall that all prices are equal in equilibrium and hence any P_i may be chosen for $i \in S_t$.

14. Rewriting the union's reaction function:

$$\phi = U_c \cdot [W_t \cdot L_{tf}^W + L_{tf}] + P_i \cdot U_L \cdot [L_{tf}^W] = 0$$

The second term of the middle expression is unambiguously positive.

In order for the first term to be unambiguously negative,

$$[L_t + W_t \cdot L_{tf}^W] < 0.$$

15. In Figure 2, it is clearly not necessary for the firms in the particular industry i to employ the households in the particular union t . Nor is it necessary for the households in union t to purchase product i . The reason is that in the ICE the prices of all product types and the wages of all labor types are equal.

16. The fiat money would also serve as a unit of account (numeraire) whereby the values of the produced goods and labor services are measured. Such a unit of account has been implicitly presupposed in the analysis above, although for simplicity it has not been explicitly included in our model as a tradable commodity.

$$\begin{aligned} 17. \quad \frac{d(W_t/P_i)}{dG_i} &= \left(\frac{1}{P_i}\right) \cdot \left[\frac{dW_t}{dG_i} - \frac{W_t}{P_i} \cdot \frac{dP_i}{dG_i}\right] \\ &= -\left(\frac{1}{P_i}\right) \cdot \left[\left(\frac{1}{1-a \cdot b}\right) \cdot \left(\frac{1+C_i^G}{2 \cdot C_i^P}\right)\right] \\ &\quad \cdot \left[\left(\frac{1}{J^r} + b\right) - \frac{W_t}{P_i} \cdot \left(1 + \frac{a}{J^r}\right)\right] \end{aligned}$$

given that $(a \cdot b) < 1$ (see below),

$$\frac{d(W_t/P_i)}{dG_i} \begin{matrix} > 0 \\ < 0 \end{matrix} \iff \frac{W_t}{P_i} \begin{matrix} < \frac{2}{3} \\ > \frac{2}{3} \end{matrix} - \frac{1}{3 \cdot J'} \cdot \frac{U_L}{U_c} .$$

18. In general, the number of firms per industry changes in the course of this multiplier process and affects the values of C_i^P and C_i^G . These second-order influences are ignored here. C_i^P and C_i^G may be interpreted as linear approximations of the consumption function in the neighborhood of the initial equilibrium.

References

- Arrow, K. (1959), "Towards a Theory of Price Adjustment" in The Allocation of Economic Resources, ed. M. Abramovitz, Stanford: Stanford University Press.
- Barro, R.J. (1972), "The Theory of Monopolistic Price Adjustment", Review of Economic Studies, 39, 17-26.
- and H. Grossman (1976), Money, Employment and Inflation, Cambridge, Cambridge University Press.
- Benassy, J.-P., (1975), "Neo-Keynesian Disequilibrium Theory in a Monetary Economy", Review of Economic Studies, 42, 503-24.
- (1976), "The Disequilibrium Approach to Monopolistic Price Setting and General Monopolistic Equilibrium", Review of Economic Studies, 43, 69-81.
- (1978), "A Neo-Keynesian Model of Price and Quantity Determination in Disequilibrium" in Equilibrium and Disequilibrium in Economic Theory, ed. by G. Schwodiauer, Reidel.
- Chamberlain (1933), The Theory of Monopolistic Competition, Massachusetts: Harvard University Press.
- Grandmont, J.M., and G. Laroque (1976), "On Keynesian Temporary Equilibria", Review of Economic Studies, 43, 53-67.
- Hahn, F. (1978), "On Non-Walrasian Equilibria", Review of Economic Studies, 45, 1-18.
- Hart, D. (1982), "A Model of Imperfect Competition with Keynesian Features", Quarterly Journal of Economics.
- (1978), "Monopolistic Competition in a Large Economy with Differentiated Commodities," Review of Economic Studies, 46 (1), 1-30.
- Malinvaud, E. (1977), The Theory of Unemployment Reconsidered, Oxford, Blackwell.
- Muellbauer, J. and R. Portes (1978), "Macroeconomic Models with Quantity Rationing", Economic Journal, 88, 788-821.
- Negishi, T. (1978), "Existence of an Underemployment Equilibrium", in Equilibrium and Disequilibrium in Economic Theory, ed. by J. Schwodiauer, Reidel.
- Sheskinski, E. and Y. Weiss (1977), "Inflation and Costs of Price Adjustment", Review of Economic Studies, 44, 287-303.
- Weitzman, M.L. (1982), "Increasing Returns and the Foundations of Unemployment Theory", Economic Journal, 92, 787-804.