

Fischer, Matthias J.

**Working Paper**

## Solving the Esscher puzzle: the NEF-GHS option pricing model

Diskussionspapier, No. 42a/2002

**Provided in Cooperation with:**

Friedrich-Alexander-University Erlangen-Nuremberg, Chair of Statistics and Econometrics

*Suggested Citation:* Fischer, Matthias J. (2002) : Solving the Esscher puzzle: the NEF-GHS option pricing model, Diskussionspapier, No. 42a/2002, Friedrich-Alexander-Universität Erlangen-Nürnberg, Lehrstuhl für Statistik und Ökonometrie, Nürnberg

This Version is available at:

<https://hdl.handle.net/10419/29624>

**Standard-Nutzungsbedingungen:**

Die Dokumente auf EconStor dürfen zu eigenen wissenschaftlichen Zwecken und zum Privatgebrauch gespeichert und kopiert werden.

Sie dürfen die Dokumente nicht für öffentliche oder kommerzielle Zwecke vervielfältigen, öffentlich ausstellen, öffentlich zugänglich machen, vertreiben oder anderweitig nutzen.

Sofern die Verfasser die Dokumente unter Open-Content-Lizenzen (insbesondere CC-Lizenzen) zur Verfügung gestellt haben sollten, gelten abweichend von diesen Nutzungsbedingungen die in der dort genannten Lizenz gewährten Nutzungsrechte.

**Terms of use:**

*Documents in EconStor may be saved and copied for your personal and scholarly purposes.*

*You are not to copy documents for public or commercial purposes, to exhibit the documents publicly, to make them publicly available on the internet, or to distribute or otherwise use the documents in public.*

*If the documents have been made available under an Open Content Licence (especially Creative Commons Licences), you may exercise further usage rights as specified in the indicated licence.*

# ”Solving the Esscher puzzle”: The NEF-GHS option pricing model

Matthias Fischer†

Institute of Statistics and Econometrics  
University of Erlangen-Nürnberg,  
Lange Gasse 20, D-90403 Nürnberg, Germany

†*Email:* Matthias.Fischer@wiso.uni-erlangen.de

---

## Abstract

With the celebrated model of Black and Scholes in 1973 the development of modern option pricing models started. One of the assumptions of the Black and Scholes model is that the risky asset evolves according to a geometric Brownian motion which implies normally distributed log-returns. As various empirical investigations show, log-returns do not follow a normal distribution, but are leptokurtic and to some extent skewed. To capture these distributional stylized facts, exponential Lévy motions have been proposed since 1994 which allow for a large class of underlying return distributions. In these models the Esscher transformation is used to obtain a risk-neutral valuation formula. This paper proposes the so-called Esscher NEF-GHS option pricing model, where the price process is modeled by an exponential NEF-GHS Lévy motion, implying that the returns follow an NEF-GHS distribution. The corresponding model seems to unify all advantages of other Esscher-based option pricing model, that is numerical tractability and a flexible underlying distribution which itself is self-conjugate.

*JEL classification:* C22; G13

*Keywords:* NEF-GHS distribution; Option pricing; Esscher transformation

---

## 1 Preface

There is no doubt that the starting point of the modern option pricing theory is given by the famous option pricing model of Black and Scholes in 1973. It is based on the so-called *geometric Brownian motion* as a model for the underlying price process. This process implies that the log returns — i.e. the differences of the logarithm of consecutive prices — follow a normal distribution. However, various

empirical studies show that financial data exhibit some specific distributional features, the so-called *distributional stylized facts*: On the one hand, there is evidence of heavier or fat tails, on the other hand, log returns are occasionally skewed. Both features cannot be captured by a normal distribution. Hence, Black and Scholes formula systematically leads to mispricing.

In order to remove this "distributional shortcoming", Gerber und Shiu (1994) introduced the concept of Esscher option pricing. In this framework, stock prices are modeled by *geometric Lévy motions*, i.e. processes which stationary and independent increments. The risk-neutral martingale measure is obtained by means of the *Esscher transformation*. Within this framework, log-returns can be modeled by infinitely divisible distributions with existing moment-generating function.

Eberlein and Keller (1994) applied the Esscher concept to the *hyperbolic distribution* family, whereas Barndorff-Nielsen (1995) suggested the *Normal-inverse Gaussian distribution* family. Both models are nested in the *generalized hyperbolic model* from Prause (1999), where the log-returns are assumed to follow a generalized hyperbolic distribution. This family includes several standard distributions as limiting or as special cases. However, except for the hyperbolic distribution, parameter estimation turns out to be very time-consuming and complicated because of the Bessel function being part of the density.

For that reason, Fischer (2000) proposed the *EGB2 distribution* — a four parameter generalization of the standard logistic distribution — in the context of Esscher pricing. However, only a restricted domain of skewness and leptokurtosis can be achieved by EGB2 if skewness and kurtosis are measured by the third and fourth standardized moments. To remove this shortcoming, Fischer (2001) introduced the convoluted EGB2 or CEGB2 distribution. Unfortunately, there is no closed form for the probability density function (up to now) which has to be approximated numerically, for example, by fast Fourier transformation.

The aim of this paper is to derive an Esscher option pricing model, where

- the underlying distribution is more flexible with respect to skewness and kurtosis than the EGB2 or the normal distribution,
- parameter estimation is easier to implement than in the case of CEGB2 or generalized hyperbolic distribution,
- a closed form is given for the risk-neutral density. Consequently, the latter

doesn't has to be numerically approximated as in the case of EGB2 or hyperbolic distribution.

For that reason, we propose an Esscher model based on the so-called NEF-GHS distribution, a flexible infinitely divisible, self-conjugate distribution with existing moment-generating function.

## 2 Esscher pricing: A review

Originally, the concept of the Esscher transformation was a time-honored tool in actuarial science suggested by Esscher [5] in 1932. Gerber and Shiu [8] applied this concept to value derivative securities if the log-prices or returns of the primary securities – take, for example, stocks – are governed by Lévy processes, i.e. stochastic processes with stationary and independent increments. In other words, non-dividend paying stock prices are assumed, driven by  $\{S_t\}_{t \geq 0}$  with

$$S_t = S_0 \exp(X_t), \quad t \geq 0, \quad (2.1)$$

where  $\{X_t\}_{t \geq 0}$  is a Lévy process with corresponding probability density function  $f_t(x)$  and moment-generating function  $\mathcal{M}_t(u)$ .<sup>1</sup> The *Esscher density* for the parameter  $h$  is then defined as

$$f_t(x; h) = \frac{e^{hx}}{\mathcal{M}_t(h)} \cdot f_t(x). \quad (2.2)$$

Note that the moment-generating function of the corresponding Lévy process  $\{X_t^h\}_{t \geq 0}$  is given by

$$\mathcal{M}_t(u; h) = \int_{-\infty}^{\infty} e^{ux} f_t(x; h) dx = \int_{-\infty}^{\infty} e^{ux} \frac{e^{hx} f_t(x)}{\mathcal{M}_t(h)} dx = \frac{\mathcal{M}_t(u + h)}{\mathcal{M}_t(h)}. \quad (2.3)$$

As the exponential function is positive, the corresponding Esscher measure is equivalent to the original measure, that means, both probability measures have the same null sets, i.e. sets with probability measure zero. In some statistical research, the term *exponential tilting* is used to describe this change of measure. From equation (2.2) it is straightforward to derive the corresponding characteristic function of the Esscher density.

### Example 2.1 (Esscher transformation of different distributions)

1. Gerber and Shiu (1995): The Esscher transformation of a Gaussian variable with mean  $\mu$  and variance  $\sigma^2$  is again a Gaussian variable with mean  $\mu + h\sigma^2$  and variance  $\sigma^2$ . This means that Esscher transformation of a Gaussian variable affects only location.

---

<sup>1</sup>Assume that  $h > 0$  is a real number for which  $\mathcal{M}_t(h)$  exists.

2. Prause (1999): The Esscher transformation of a generalized hyperbolic (GH) distribution with parameters  $(\mu, \delta, \alpha, \beta, \lambda)$  results in a GH distribution with parameters  $(\mu, \delta, \alpha, \beta + h, \lambda)$ . Consequently, skewness – measured by the third standardized moment – will be changed, too.
3. Fischer (2001): The Esscher transformation of an EGB2 distribution with parameters  $(\mu, \delta, \beta_1, \beta_2)$  is again an EGB2 variable with parameters  $(\mu, \delta, \beta_1 + \delta h, \beta_2 - \delta h)$ , if  $|h| < \frac{\beta_2}{\delta}$ .

In order to construct *risk-neutral stock prices*<sup>2</sup>, the process  $\{S_t\}_{t \geq 0}$  has to be transformed by the Esscher transformation to a process  $\{S_t^h\}_{t \geq 0}$  with  $S_t^h = S_0 \exp(X_t^h)$ . Here,  $h$  is chosen so that the discounted Esscher transformed stock price process  $\{e^{-rt} S_t^h\}_{t \geq 0}$  is a martingale with respect to the original measure  $\mathbf{P}$ . Equivalently, the discounted stock price process  $\{e^{-rt} S_t\}_{t \geq 0}$  is a martingale with respect to the Esscher measure  $\mathbf{P}^*$ . For these purposes, the so-called **martingale equation** can be derived with the help of equation (2.1) as

$$S_0 = \mathbf{E}^*(e^{-rt} S_t) \iff e^r = \mathcal{M}_1(1; h^*) \iff r = \ln(\mathcal{M}_1(1; h^*)). \quad (2.4)$$

Therefore, the discounted price process is a martingale if the Esscher parameter  $h^*$  satisfies the equation on the right side of (2.4). This is equivalent to  $h^*$  being a root of the **martingale function**

$$\mathbb{M}(h) \doteq r - \ln(\mathcal{M}_1(1; h)) = r - \ln\left(\frac{\mathcal{M}_1(h+1)}{\mathcal{M}_1(h)}\right). \quad (2.5)$$

Standard no-arbitrage arguments imply that the **fair value**  $c_0$  of a European call option with **exercise price**  $K$  and **maturity date**  $T$  at time  $t = 0$  is given by

$$c_0 = e^{-rT} \mathbf{E}^*(\max(S_T - K; 0)), \quad (2.6)$$

where  $\mathbf{E}^*$  denotes the expectation value with respect to the equivalent martingal measure  $\mathbf{P}^*$ , here the risk neutral Esscher measure. Defining  $\kappa = \ln(K/S_0)$  and using  $e^x f_T(x; h^*) = e^{rT} f_T(x; h^* + 1)$ , equation (2.6) can be rewritten as

$$\begin{aligned} c_0 &= e^{-rT} \int_{\kappa}^{\infty} (S_0 e^x - K) f_T(x; h^*) dx \\ &= S_0 \int_{\kappa}^{\infty} f_T(x; h^* + 1) dx - e^{-rT} K \int_{\kappa}^{\infty} f_T(x; h^*) dx \\ &= S_0 \int_{\kappa}^{\infty} \frac{e^{(h^*+1)x} f_T(x)}{\mathcal{M}_T(h^* + 1)} dx - e^{-rT} K \int_{\kappa}^{\infty} \frac{e^{h^*x} f_T(x)}{\mathcal{M}_T(h^*)} dx, \end{aligned} \quad (2.7)$$

or, by means of the Esscher transformed cumulative distribution function  $F_T(x; h^*)$ ,

$$c_0 = S_0(1 - F_T(\kappa; h^* + 1)) - e^{-rT} K(1 - F_T(\kappa; h^*)) = S_0 \Pi_1 - e^{-rT} K \Pi_2. \quad (2.8)$$

---

<sup>2</sup>Prices that are internally consistent.

### 3 Option pricing by means of Esscher transformation: Necessary and desirable properties of the underlying distribution

In order to perform a fast and realistic Esscher option pricing, the underlying distribution should satisfy the two necessary properties ID and EXMGF and, if possible, all of the desirable properties FLEX, NTRAC, SECON which are defined and discussed in the following.

1. ID (**Infinite divisibility**): This property is necessary to construct exponential Lévy processes which serve as models for the stock prices. Many of the standard distributions are infinitely divisible. A summary of infinitely divisible distribution is given, for example, by Fischer [7]. Among them are the generalized hyperbolic family, the generalized logistic family, the stable distributions and the Student-t distribution.
2. EXMGF (**Existence of the moment-generating function**) is necessary to define the risk-neutral Esscher density which is given by  $f(x; h^*) = f(x) \cdot \frac{\exp(h^*x)}{\mathcal{M}_1(h^*)}$ . This claim rules out the Student-t distribution and the stable distributions as possible candidates for the underlying distribution.
3. FLEX (**Flexibility**): It is well-known that the normal distribution is not capable to model skewness and, above all, positive excess kurtosis of financial return data. Consequently, alternatives have been proposed, as for example the generalized hyperbolic family or the EGB2 distribution. However, note that the range of skewness and kurtosis of EGB2 is restricted to  $[-2, 2]$  and  $[3, 9]$ , respectively.
4. NTRAC (**Numerical tractability**): The disadvantage of the EGB2 distribution of not being able to rebuild arbitrary kurtosis and skewness can be overcome by introducing an additional (convolution) parameter. However, the density function of the convoluted EGB2 is not known explicitly and has to be approximated with numerical methods. Although the probability density function of the generalized hyperbolic distribution family is known, the modified Bessel function is part of the density may lead to a time-consuming estimation procedure<sup>3</sup>.
5. SECON (**Self-conjugation**): In order to calculate the risk neutral probabilities  $\Pi_1$  and  $\Pi_2$  from (2.8), the risk neutral density or distribution function

---

<sup>3</sup>Note that the modified Bessel function is not implemented in many statistic packages.

has to be determined numerically from the risk neutral characteristic function  $\varphi_t(x; h^*) = (\varphi_1(x; h^*))^t$  which — in most of the cases — induces a different density for each  $t > 0$ . This problem can be circumvent or simplified if the underlying distribution is self-conjugate, that means is invariant with respect to convolution. In this case, the risk neutral probabilities  $\Pi_1$  and  $\Pi_2$  can be determined via simple numerical integration. Within the GH-family, the NIG distribution is the only distribution which is self-conjugate. Moreover, the EGB2 distribution isn't, whereas the CEGB2 distribution is, by construction.

Up to now all Esscher option pricing models lack in at least one of this five properties. The following table summarizes the Esscher models and their properties.

Distribution	ID	EXMGF	FLEX	NTRAC	SECON	Author
Normal	Yes	Yes	No	Yes	Yes	Black/Scholes [3]
GH	Yes	Yes	Yes	No*	No**	Prause [13]
NIG	Yes	Yes	Yes	No	Yes	Barndorff-Nielsen [1]
HYP	Yes	Yes	Yes	Yes	No	Eberlein/Keller [4]
EGB2	Yes	Yes	Yes	Yes***	No	Fischer [6]
CEGB2	Yes	Yes	Yes	No	Yes	Fischer [7]

\* only for HYP, \*\* only for NIG, \*\*\* range of skewness/kurtosis restricted

Figure 1: Esscher option pricing models.

The aim of this study is to propose an Esscher model which exhibits all of the previous five requirements.

## 4 The NEF-GHS distribution

The NEF-GHS distribution was originally introduced by Morris [12] in the context of *natural exponential families* (NEF) with specific quadratic variance functions. Densities of natural exponential families are of the form

$$f(x; \lambda, \theta) = \exp\{\lambda x - \psi(\lambda, \theta)\} \cdot \zeta(x, \lambda). \quad (4.9)$$

In the case of the NEF-GHS distribution,  $\psi(\lambda, \theta) = -\lambda \log(\cos(\theta))$  and  $\zeta(x, \lambda)$  equals the pdf of a generalized hyperbolic secant (GHS) distribution<sup>4</sup> which can be obtained as  $\lambda$ -th convolution of a hyperbolic secant (HS) variable. Hence, the probability density function of the NEF-GHS distribution is given by

$$f(x; \lambda, \theta) = \frac{2^{\lambda-2}}{\pi \Gamma(\lambda)} \cdot \left| \Gamma\left(\frac{\lambda + ix}{2}\right) \right|^2 \cdot \exp\{\theta x + \lambda \log(\cos(\theta))\} \quad (4.10)$$

for  $\lambda > 0$  and  $|\theta| < \pi/2$ . Introducing a scale parameter  $\delta > 0$  and a location parameter  $\mu \in \mathbb{R}$ , and setting  $\beta \equiv \tan(\theta) \in \mathbb{R}$ , equation (4.10) changes to

$$f(x; \mu, \delta, \lambda, \beta) = \frac{2^{\lambda-2}}{\delta \pi \Gamma(\lambda)} \cdot \left| \Gamma\left(\frac{\lambda + i\left(\frac{x-\mu}{\delta}\right)}{2}\right) \right|^2 \cdot e^{\arctan(\beta)\frac{x-\mu}{\delta} + \lambda \log(\cos(\arctan(\beta)))} \quad (4.11)$$

It can be shown that NEF-GHS distribution reduces to the GHS distribution for  $\theta = \beta = 0$ , to the skewed hyperbolic secant distribution for  $\lambda = 1$  and to the hyperbolic secant distribution for  $\lambda = 1$  and  $\theta = 0$ . Furthermore, it goes in limit to the normal distribution ( $\lambda \rightarrow \infty$ ).

**Proposition 4.1 (Properties of NEF-GHS)** Let  $X$  follow a NEF-GHS distribution with parameters  $(\lambda, \theta)$ . Then

1. The mgf of  $X$  exists for  $\{u \mid \cos(u) - \beta \sin(u) > 0\}$  and is given by

$$\mathcal{M}(u) = \exp\{-\lambda \log(\cos(u) - \beta \sin(u))\}. \quad (4.12)$$

2. All moments exist. In particular, the range of  $\mathbb{S}(X)$  and  $\mathbb{K}(X)$  is unrestricted.
3.  $X$  is infinitely divisible.
4.  $X$  is self-conjugate.

---

<sup>4</sup>A detailed discussion of the GHS distribution can be found in Baten [2], Harkness and Harkness [9] and Jørgensen [10].



**Proof:** 1. With  $c(x; \lambda) = \frac{2^{\lambda-2}}{\pi \Gamma(\lambda)} \cdot |\Gamma(\frac{\lambda+ix}{2})|^2$ , the calculation of the moment-generating function is straightforward:

$$\begin{aligned}
M(u) &= \int_{-\infty}^{\infty} \exp(ux) \cdot c(x; \lambda) \cdot \exp\{\theta x + \lambda \log(\cos(\theta))\} dx \\
&= \int_{-\infty}^{\infty} c(x; \lambda) \cdot \frac{\exp\{(u + \theta)x + \lambda \log(\cos(\theta + u))\}}{\exp\{\lambda \log(\cos(\theta + u)) - \lambda \log(\cos(\theta))\}} dx \\
&= \exp\{-\lambda \log(\cos(\theta + u)) + \lambda \log(\cos(\theta))\} \\
&= \exp\{-\lambda \log(\cos(u) - \tan(\theta) \sin(u))\} = \exp\{-\lambda \log(\cos(u) - \beta \sin(u))\}.
\end{aligned}$$

3. From (4.12), the characteristic function is given by

$$\varphi(u) = \mathcal{M}(iu) = \exp\{-\lambda \log(\cos(iu) - \beta \sin(iu))\}. \quad (4.13)$$

Infinite divisibility can be easily derived as  $\varphi(u)^{1/n}$  is a characteristic function of a NEF-GHS distribution with  $\lambda' = \lambda/n$  for all  $n \in \mathbb{N}$ .

4. For the same reason,  $\varphi(u; \lambda, \beta)^\tau = \varphi(u; \tau\lambda, \beta)$  for  $\tau > 0$ . Thus,  $X$  is also self-conjugated.  $\square$

**Corollary 4.1 (Moments of NEF-GHS)** *Let  $X$  denote a NEF-GHS distributed random variable with parameters  $(\mu, \delta, \lambda, \beta)$ . Then, the first four moments  $m'_i = E(X^i)$  are given by*

$$\begin{aligned}
m'_1 &= E(X) = \mu + \delta\lambda\beta, \\
m'_2 &= \delta^2 \lambda(\beta^2 + 1 + \lambda\beta^2), \\
m'_3 &= \delta^3 \lambda(\beta^3\lambda^2 + 3\lambda\beta + 2\beta + 3\lambda\beta^3 + 2\beta^3) \text{ and} \\
m'_4 &= \delta^4 \lambda(2 + 3\lambda + 6\beta^4 + 8\beta^2 + 11\lambda\beta^4 + 6\lambda^2\beta^2 + 14\lambda\beta^2 + \lambda^3\beta^4 + 6\lambda^2\beta^4).
\end{aligned}$$

Consequently, the corresponding central moments  $m_i = E(X - m)^i$  are

$$\begin{aligned}
m_2 &= \frac{\psi'''(\beta_1) + \psi'''(\beta_2) + 3(\psi'(\beta_1) + \psi'(\beta_2))^2}{[\psi'(\beta_1) + \psi'(\beta_2)]^2}, \\
m_3 &= 2\delta^3 \lambda\beta(\beta^2 + 1) \text{ and} \\
m_4 &= \delta^4 [3\lambda(\lambda + 2)(1 + \beta^2)^2 - 4\lambda(1 + \beta^2)].
\end{aligned}$$

**Corollary 4.2 (Skewness and kurtosis of NEF-GHS)** *Let  $X$  denote a NEF-GHS distributed random variable with parameters  $(\mu, \delta, \lambda, \beta)$ . The skewness and kurtosis coefficient — measured by the third and fourth standardized moments — are given by*

$$\mathbb{S}(X) = \frac{m_3}{\sqrt{(m_2)^3}} = \frac{2\beta}{\sqrt{\lambda(1 + \beta^2)}} \quad \text{and} \quad \mathbb{K}(X) = \frac{m_4}{(m_2)^2} = \frac{2 + 6\beta^2}{\lambda(1 + \beta^2)}. \quad (4.14)$$

The range of  $\mathbb{S}(X)$  and  $\mathbb{K}^*(X) = \mathbb{K}(X) - 3$  subject to the parameters  $\lambda$  and  $\beta$  can be seen in table 1 and 2, below. It is obvious that  $\mathbb{S}(X)$  increases with decreasing  $\lambda$  (keeping  $\beta$  fix) and increasing  $\beta$  (keeping  $\lambda$  fix).

$\lambda \downarrow \beta \rightarrow$	<b>100</b>	<b>10</b>	<b>5</b>	<b>2</b>	<b>1</b>	<b>0.1</b>
<b>0.1</b>	6.32	6.29	6.20	5.66	4.47	0.63
<b>0.5</b>	2.89	2.81	2.77	2.53	2.00	0.28
<b>1</b>	1.99	1.99	1.96	1.79	1.41	0.20
<b>2</b>	1.41	1.41	1.39	1.27	1.00	0.14
<b>5</b>	0.89	0.89	0.88	0.80	0.63	0.09
<b>10</b>	0.63	0.63	0.62	0.57	0.45	0.06
<b>100</b>	0.20	0.20	0.19	0.18	0.14	0.02

Table 1: Range of skewness measured by  $\mathbb{S}(X)$ .

Table 2 illustrates that  $\mathbb{K}(X)$  and  $\mathbb{K}^*(X)$  increase with decreasing  $\lambda$  (keeping  $\beta$  fix) and increasing  $\beta$  (keeping  $\lambda$  fix).

$\lambda \downarrow \beta \rightarrow$	<b>0.1</b>	<b>1</b>	<b>2</b>	<b>5</b>	<b>10</b>	<b>100</b>
<b>0.1</b>	20.40	40.00	52.00	58.46	59.60	60.00
<b>0.5</b>	4.08	8.00	10.40	11.69	11.92	12.00
<b>1</b>	2.04	4.00	5.20	5.85	5.96	6.00
<b>2</b>	1.02	2.00	2.60	2.92	2.98	3.00
<b>5</b>	0.41	0.80	1.04	1.17	1.19	1.20
<b>10</b>	0.20	0.40	0.52	0.59	0.60	0.60
<b>100</b>	0.02	0.04	0.05	0.06	0.06	0.06

Table 2: Range of kurtosis measured by  $\mathbb{K}(X)^* = \mathbb{K}(X) - 3$ .

## 5 Application: Modelling financial return data

In order to adopt and compare estimation results for stable distributions, priority is given to the weekly returns of the Nikkei from July 31, 1983 to April 28, 1995, with  $N = 608$  observations. This series was investigated by Mittnik et al. [11] and it shows typical stylized facts of financial return. Figure 2 illustrates the levels and returns of the Nikkei data.

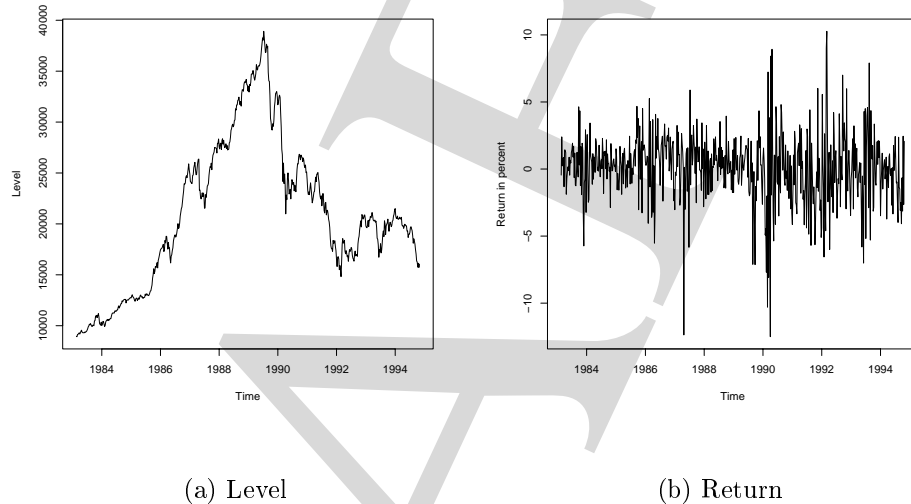

Figure 2: Levels and returns of Nikkei.

Similar to Mittnik et al. [11], four criteria are employed to compare the goodness-of-fit of the different candidate distributions: The first is the *log-Likelihood value* ( $\mathcal{LL}$ ) obtained from the Maximum-Likelihood estimation. The  $\mathcal{LL}$ -value can be considered as an "overall measure of goodness-of-fit and allows us to judge which candidate is more likely to have generated the data"<sup>5</sup>. As distributions with different numbers  $k$  of parameters are used, this is taken into account by calculating the *Akaike criterion* given by

$$AIC = -2 \cdot \mathcal{LL} + \frac{2N(k+1)}{N-k-2}.$$

The third criterion is the *Kolmogorov-Smirnov distance* which measures the distance between the estimated parametric cumulative distribution function (denoted by  $\hat{F}$ ) and the empirical sample distribution ( $F_{emp}$ ). It is usually defined by

$$\mathcal{K} = 100 \cdot \sup_{x \in \mathbb{R}} |F_{emp}(x) - \hat{F}(x)|. \quad (5.15)$$

---

<sup>5</sup>See Mittnik et al. [11], p. 11.

Finally, *Anderson-Darling statistic* is calculated which weights  $|F_{emp}(x) - \hat{F}(x)|$  by the reciprocal of the standard deviation of  $F_{emp}$ , namely  $\sqrt{\hat{F}(x)(1 - \hat{F}(x))}$ , that is

$$\mathcal{AD}_0 = \sup_{x \in \mathbb{R}} \frac{|F_{emp}(x) - \hat{F}(x)|}{\sqrt{\hat{F}(x)(1 - \hat{F}(x))}}. \quad (5.16)$$

Instead of just the maximum discrepancy, the second and third largest value, which are commonly termed as  $\mathcal{AD}_1$  and  $\mathcal{AD}_2$ , are also taken into consideration. Whereas  $\mathcal{K}$  emphasizes deviations around the median,  $\mathcal{AD}_0$ ,  $\mathcal{AD}_1$  and  $\mathcal{AD}_2$  allow discrepancies in the tails of the distribution to be appropriately weighted.

Distr.	k	$\mathcal{LL}$	AIC	$\mathcal{K}$	$\mathcal{AD}_0$	$\mathcal{AD}_1$	$\mathcal{AD}_2$
<b>Stable, normal and Student-t distribution</b>							
$S_{\alpha,\beta}$	4	-1393.2	2796.5	3.00	0.085	0.084	0.081
NORM	2	-1428.3	2862.6	6.89	4.920	2.810	1.070
t	3	-1392.2	2792.5	3.77	0.107	0.104	0.103
<b>Generalized logistic family</b>							
HYPG	2	-1393.4	2792.8	4.31	0.216	0.150	0.121
LOG	2	-1398.1	2802.1	4.56	0.362	0.236	0.186
EGB2	4	-1388.1	2786.3	2.45	0.103	0.100	0.095
CEGB2	5	-1388.0	2788.3	2.42	0.095	0.093	0.086
<b>Generalized hyperbolic family</b>							
GH	5	-1388.0	2788.2	2.43	0.095	0.093	0.086
HYP	4	-1388.2	2786.5	2.50	0.106	0.103	0.098
NIG	4	-1388.2	2786.6	2.48	0.085	0.085	0.075
<b>NEF-GHS family</b>							
NEF-GHS	4	-1388.1	2786.3	2.42	0.091	0.090	0.083

Table 3: Goodness-of-fit: Nikkei225.

It becomes obvious from table 3, that NEF-GHS is a competitive alternative with respect to all of the goodness-of-fit measures.

## 6 The NEF-GHS option pricing model

Before deriving the NEF-GHS Esscher price, it will be proved that the Esscher transformation of a NEF-GHS variable is again a NEF-GHS variable.

**Proposition 6.1 (Esscher transformation of NEF-GHS)** *The Esscher transformation (with respect to  $h$ ) of a NEF-GHS distribution with parameter  $(\lambda, \theta)$  is again a NEF-GHS distribution with parameter vector  $(\lambda, \theta + h)$ .*

**Proof:** Using equations (4.10) and (4.12) it follows that<sup>6</sup>

$$\begin{aligned}
 f_h(x; \lambda, \theta) &= \frac{\exp(hx)}{\mathcal{M}(h)} \cdot f(x; \lambda, \theta) \\
 &= \frac{2^{\lambda-2}}{\pi \Gamma(\lambda)} \cdot \left| \Gamma\left(\frac{\lambda + ix}{2}\right) \right|^2 \cdot \frac{\exp(hx) \exp\{\theta x + \lambda \log(\cos(\theta))\}}{\exp\{-\lambda \log(\cos(h) - \tan(\theta) \sin(h))\}} \\
 &= \frac{2^{\lambda-2}}{\pi \Gamma(\lambda)} \cdot \left| \Gamma\left(\frac{\lambda + ix}{2}\right) \right|^2 \cdot \frac{\exp((h + \theta)x)}{\exp\{-\lambda \log(\cos(\theta) \cos(h) - \sin(\theta) \sin(h))\}} \\
 &= \frac{2^{\lambda-2}}{\pi \Gamma(\lambda)} \cdot \left| \Gamma\left(\frac{\lambda + ix}{2}\right) \right|^2 \cdot \frac{\exp((h + \theta)x)}{\exp\{-\lambda \log(\cos(\theta + h))\}} \\
 &= \frac{2^{\lambda-2}}{\pi \Gamma(\lambda)} \cdot \left| \Gamma\left(\frac{\lambda + ix}{2}\right) \right|^2 \cdot \exp\{(\theta + h)x + \lambda \log(\cos(\theta + h))\} \\
 &= f(x; \lambda, \theta + h) \quad \square
 \end{aligned}$$

**Derivation of the option price:** For every infinitely divisible distribution a Lévy process  $\{X_t\}_{0 \leq t \leq T}$  can be constructed so that  $X_1 \sim \mathcal{L}$ . Since the NEF-GHS distribution is infinitely divisible, there exists a Lévy process  $\{X_t\}_{0 \leq t \leq T}$ , where  $X_1$  follows a NEF-GHS distribution with parameter vector  $(\mu, \delta, \lambda, \theta)$ . This stochastic process is termed as a **NEF-GHS Lévy motion** in the following. Consequently, all increments of length 1 of a NEF-GHS-Lévy motion follow a NEF-GHS distribution and — as a consequence of self-conjugation — every  $X_t$ ,  $t > 0$  is NEF-GHS distributed with parameter vector  $(\mu, \delta, \lambda t, \theta)$ .<sup>7</sup>

In analogy to the proceeding of Eberlein and Keller [4] and Prause [13], the underlying financial market consists of two securities defined on a stochastic basis  $(\Omega, \mathcal{F}, \{\mathcal{F}_t\}_{0 \leq t \leq T}, P)$  which satisfies the usual conditions. It is further supposed that there is a risk-free security  $\{B_t\}_{0 \leq t \leq T}$  that starts with  $B_0 = 1$  and bears (continuously)  $r$  percent interest. The second (risky) asset is assumed to be a stock whose price process is modeled by an exponential NEF-GHS Lévy process  $\{S_t\}_{0 \leq t \leq T}$  with

<sup>6</sup>Note, that  $\cos(x + y) = \cos(x) \cos(y) - \sin(x) \sin(y)$ .

<sup>7</sup>In absence of self-conjugation, the distribution of  $X_t$ ,  $t \neq 1$  has to be calculated numerically by inverting its characteristic function  $\varphi_t$  with the help of the Fourier inversion.

$S_t = S_0 \exp(X_t)$ , where  $\{X_t\}_{0 \leq t \leq T}$  is a NEF-GHS Lévy motion.

The derivation of the NEF-GHS Esscher option price is then straightforward<sup>8</sup>: First, transform the density  $f_t$  into a risk-neutral martingale density  $f_t^*$  which depends on the root,  $h^*$ , of the martingale function

$$\begin{aligned} \mathbb{M}(h) &= r - \mu + \log \left( \frac{\exp \{-\lambda \log(\cos(\delta(h+1)) - \beta \sin(\delta(h+1)))\}}{\exp \{-\lambda \log(\cos(\delta h) - \beta \sin(\delta h))\}} \right) \\ &= r - \mu + \lambda \cdot \log \left( \frac{\cos(\delta(h+1)) - \beta \sin(\delta(h+1))}{\cos(\delta h) - \beta \sin(\delta h)} \right) \end{aligned} \quad (6.17)$$

According to proposition 6.1, the Esscher transformed density of  $X_1$  is given by

$$f_1^*(x) = \frac{\exp(h^*x)}{\mathcal{M}(h^*)} \cdot f(x) = f(x; \mu, \delta, \lambda, \theta + h),$$

i.e.  $X_1$  obviously follows an NEF-GHS distribution with parameters  $(\mu, \delta, \lambda, \theta + h)$ .

**Rescaling of the NEF-GHS distribution:** When fitting a normal distribution only a scale parameter  $\sigma$  and a location parameter  $\mu$  has to be estimated. In the case of the NEF-GHS distribution, additional parameters  $\lambda$  and  $\beta$  which determine both skewness and kurtosis have to be chosen. Tail estimates are typically based on series observed over a longer time horizon, especially rare events like crashes should be taken into account. On the other hand, variance estimates should be adapted regularly with respect to short term developments. The variance of a NEF-GHS distributed random variable  $X$  has a linear structure

$$Var(X) = \delta^2 \cdot C_{\lambda, \beta},$$

where  $C_{\lambda, \beta}$  depends only on the shape, i.e. the scale- and location-invariant parameters  $\lambda$  and  $\beta$ <sup>9</sup>. Therefore,  $\delta$  can be treated as volatility parameter. According to this background, the following rescaling is executed if options are valued or implicit volatilities are calculated: Given the standard deviation  $\hat{\sigma}$ , the new  $\tilde{\delta}$  is obtained by

$$\tilde{\delta} = \frac{\hat{\sigma}}{\sqrt{\hat{\lambda}(\hat{\beta}^2 + 1)}}.$$

---

<sup>8</sup>As the moment-generating function of the NEF-GHS distribution does exist, the concept of Esscher transformation can be applied.

<sup>9</sup>Scale- and location-invariance of  $\lambda$  and  $\beta$  can be easily verified.

## 7 Esscher valuation in practice

Calculating option prices within an Esscher framework requires five steps that have to be implemented. In the following, this procedure is demonstrated by means of **Consors AG** which is part of the NEMAX50 index.

In a first step, it is necessary to estimate the parameters of the infinitely divisible distribution which is assumed as a model for the log-returns of **Consors**. The log-returns of **Consors** are shown in figure 3(a). Throughout this section the *normal* (NORM), the *normal-inverse Gaussian* (NIG) and the *NEF-GHS distribution* are centered and compared with each other. Estimation was done by Maximum-Likelihood using Matlab functions. The corresponding results are given in table 4, below.

<b>Distribution</b>	Location	Scale	<b>Shape</b>	
NIG	$\hat{\mu} = -0.0050$	$\hat{\delta} = 0.0622$	$\hat{\alpha} = 28.1426$	$\hat{\beta} = 1.9520$
NEF-GHS	$\hat{\mu} = -0.0050$	$\hat{\delta} = 0.0418$	$\hat{\lambda} = 1.26100$	$\hat{\theta} = 0.0831$
NORM	$\hat{\mu} = -0.0006$	$\hat{\sigma} = 0.0470$	—	—

Table 4: Parameter estimation results for **Consors AG**.

A graphical comparison of the goodness-of-fit for the normal, the NIG and the NEF-GHS distribution can be seen in figure 3 (b)–(d).

For reasons of brevity, the second step (that means rescaling of the variance) will be skipped. Next, the martingale parameters of the Esscher transformation have to be determined numerically from the data. In the case of NEF-GHS, the root of the martingale function — assuming a risk-free interest rate  $r = 0.01$  — is close to 4.14. The same is true for the NIG distribution, whereas the root of the "normal" martingale function lies near 4.32 (see table 5).

<b>Distribution</b>	<b><math>h^*</math></b>
NORM	4.315044
NIG	4.134667
NEF-GHS	4.143695

Table 5: Different martingale parameter for **Consors AG**.

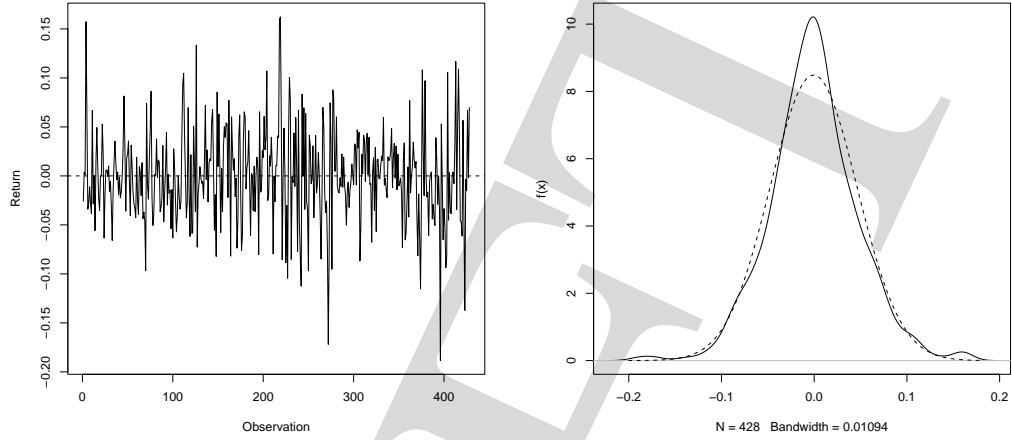

(a) Returns.

(b) Normal fit.

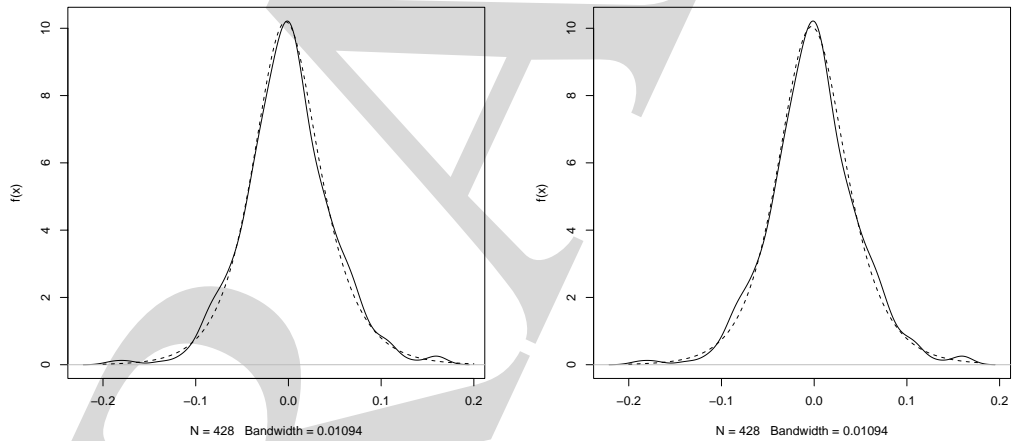

(c) NEF-GHS fit.

(d) NIG fit.

Figure 3: Returns and fit for **Consors AG**.

Figure 4(a) graphically illustrates the different martingale functions. The differences between the normal distribution on the one hand (represented by the red, pointed line) and the NEF-GHS and NIG distributions (which are represented by the two lines which are close together) on the other hand are evident .

In a fourth step, the risk-neutral Esscher-density of **Consors AG** has to be determined. In analogy to the convolution densities  $\{f_t(x) = f_1(x)^{t*}\}_{t \in \mathbb{R}_+, x \in \mathbb{R}}$ , similarities between the NEF-GHS and NIG distributions, and differences in  $x$  and  $t$  between NEF-GHS and the normal densities, and NIG and the normal densities become ob-



vious in figure 5 and 6. Consequently, these characteristics carries over to the option prices which are shown in figure 7. In particular, NIG and NEF-GHS options prices are very close together. For that reason, we will factor out the analysis of mispricing for the NEF-GHS model and refer the interested reader to the work of Prause [13].

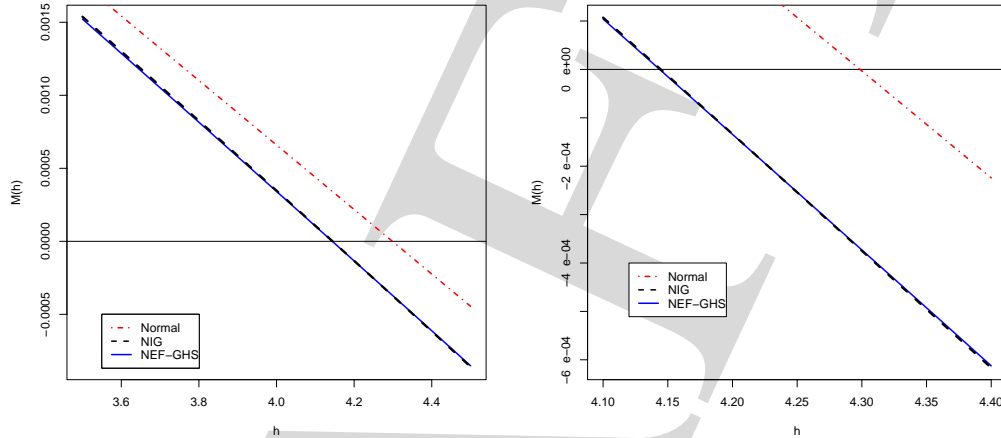

(a) Normal versus NIG/NEF-GHS.

(b) Zoom of subfigure (a).

Figure 4: Different martingale functions of Consors AG.

## 8 Conclusions

To sum up, the NEF-GHS distribution is able to capture all of the distributional stylized facts. Moreover it was demonstrated, that the NEF-GHS option pricing model unifies all of the advantages of the other Esscher option pricing models. However, it should be mentioned that there are also so-called *time-series stylized* facts which have not been considered within this analysis. Moreover, the use of the Esscher transformation has a major drawback as the market is now incomplete, i.e. there are several choices of equivalent martingale measures which can be used to determine option prices. In this case it is quite natural to specify the preferences of the agents in order to select one of the martingale measures. The specification of the investor's behaviour can be done, for example, in terms of utility functions. Applied to the concept of Esscher transformation an agent with power utility function is implicitly assumed.

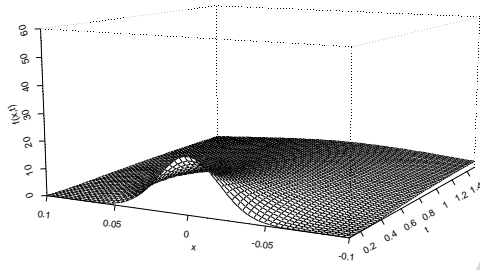

(a) Norm

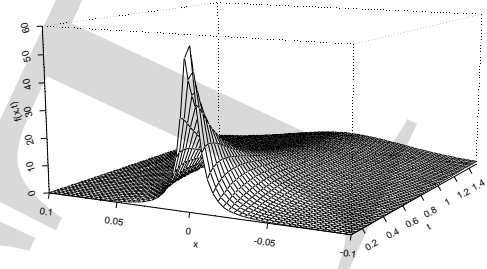

(b) NIG

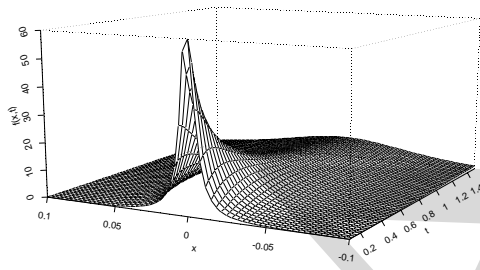

(c) NEF-GHS

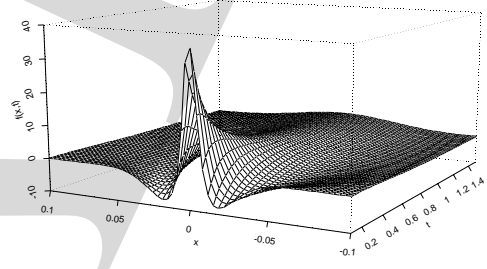

(d) NIG minus Norm

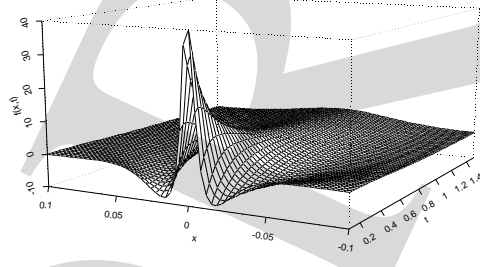

(e) NEF-GHS minus Norm

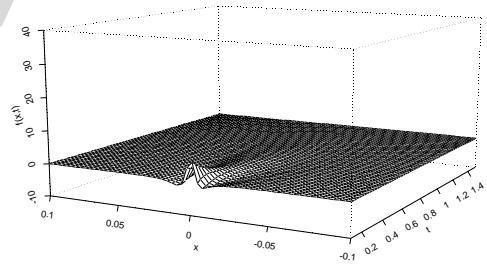

(f) NEF-GHS minus NIG

Figure 5: Convolution densities for Consors AG.

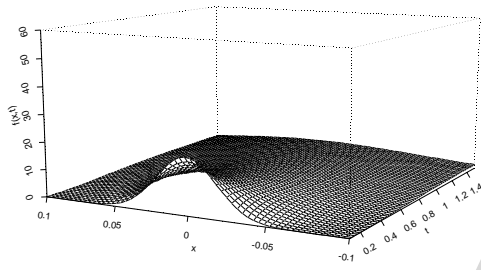

(a) Norm\*

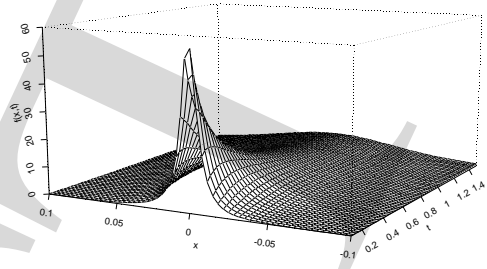

(b) NIG\*

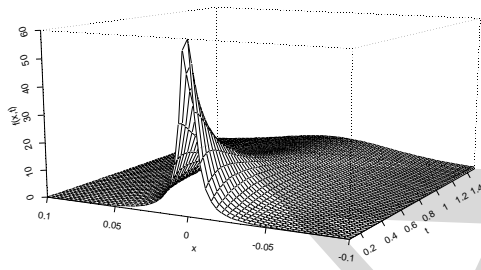

(c) NEF-GHS\*

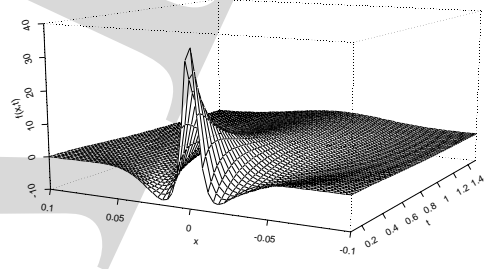

(d) NIG\* minus Norm\*

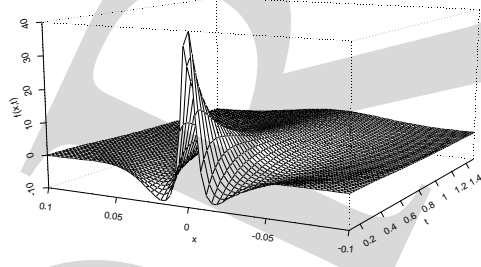

(e) NEF-GHS\* minus Norm\*

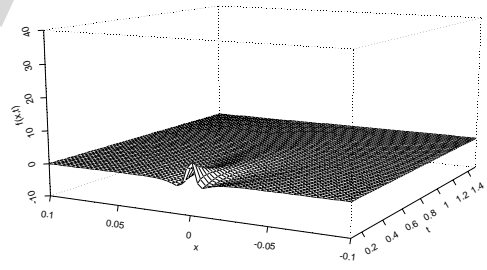

(f) NEF-GHS\* minus NIG\*

Figure 6: Risk-neutral convolution densities for Consors AG.

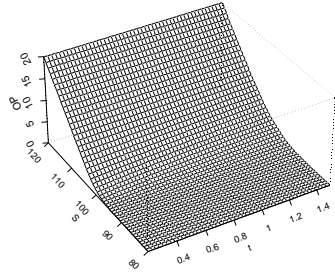

(a) Normal price

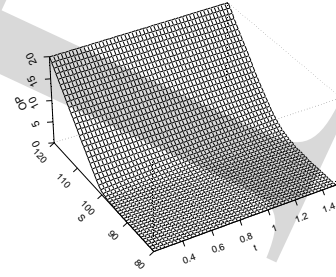

(b) NIG price

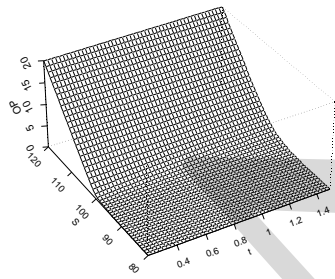

(c) NEF-GHS price

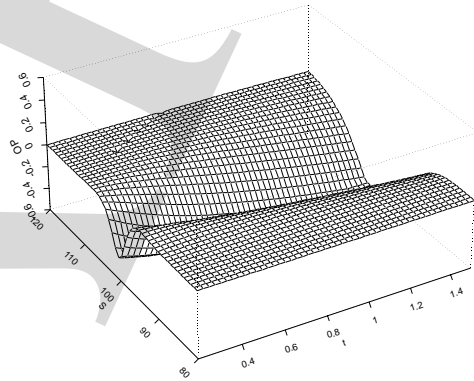

(d) NIG-Normal price

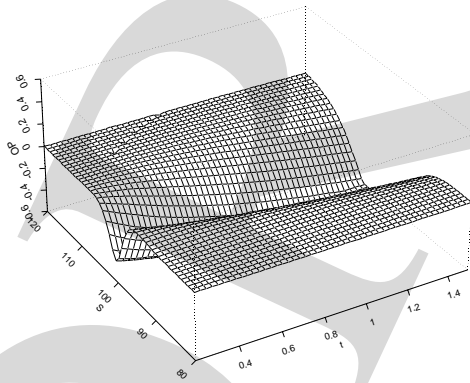

(e) NEF-GHS minus Normal price

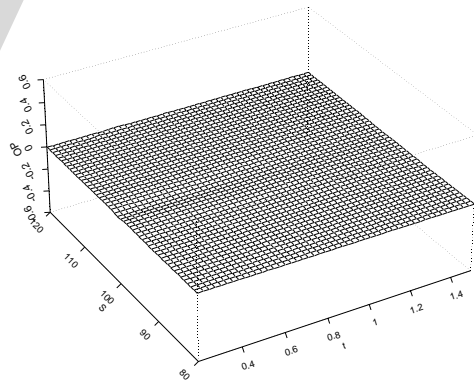

(f) NEF-GHS minus NIG price

Figure 7: Option prices for Consors AG.

## References

- [1] BARNDORFF-NIELSEN, O. E.: *Normal inverse Gaussian processes and the modelling of stock returns*. Research Report 300, Department of Theoretical Statistics, University of Aarhus, 1995.
- [2] BATEN, W. D.: *The probability law for the sum of  $n$  independent variables, each subject to the law  $(1/2h)\operatorname{sech}(\pi x/2h)$* . Bulletin of the American Mathematical Society, 40:284–290, 1934.
- [3] BLACK, F. and M. SCHOLES: *The pricing of options and corporate liabilities*. The Journal of Political Economy, 81:637–659, 1973.
- [4] EBERLEIN, E. and U. KELLER: *Hyperbolic distributions in finance*. Bernoulli, 1(3):281–299, 1995.
- [5] ESSCHER, F.: *On the probability function in the collective theory of risk*. Skandinavisk Aktuarietidskrift, 15:175–195, 1932.
- [6] FISCHER, M.: *The convoluted EGB2 distribution and its application to financial return data*. Discussion paper 32, Universität Erlangen-Nürnberg, Nürnberg, 2000.
- [7] FISCHER, M.: *Infinitely divisible distribution and its application towards financial return data: unconditional fit and option pricing*. PhD thesis, Universität Erlangen-Nürnberg, Nürnberg, October 2001.
- [8] GERBER, H. U. and S. W. SHIU: *Option Pricing by Esscher Transformations*. Trans. Soc. Actuaries, 46:99–191, 1995.
- [9] HARKNESS, W. L. and M. L. HARKNESS: *Generalized hyperbolic secant distributions*. Journal of the American Statistical Association, 63:329–337, 1968.
- [10] JØRGENSEN, B.: *The theory of dispersion models*. Monographs on statistics and applied probability. Chapman & Hall, London, 1997.
- [11] MITTNIK, S., M. S. PAOLELLA and S. T. RACHEV: *Unconditional and conditional distribution models for the Nikkei index*. Asia-Pacific Financial Markets, 5:99–128, 1998.
- [12] MORRIS, C. N.: *Natural exponential families with quadratic variance functions*. The Annals of Statistics, 10(1):65–80, 1982.
- [13] PRAUSE, K.: *The Generalized Hyperbolic Model: Estimation, Financial Derivatives and Risk Measures*. PhD thesis, Universität Freiburg, Freiburg, October 1999.