

Kruczek, Zygmunt (Ed.); Walas, Bartłomiej (Ed.)

**Book**

## Current Trends in Tourism under COVID-19 and Future Implications

**Provided in Cooperation with:**

MDPI – Multidisciplinary Digital Publishing Institute, Basel

*Suggested Citation:* Kruczek, Zygmunt (Ed.); Walas, Bartłomiej (Ed.) (2023) : Current Trends in Tourism under COVID-19 and Future Implications, ISBN 9783036594910, MDPI - Multidisciplinary Digital Publishing Institute, Basel, <https://doi.org/10.3390/books978-3-0365-9490-3>

This Version is available at:

<https://hdl.handle.net/10419/290580>

**Standard-Nutzungsbedingungen:**

Die Dokumente auf EconStor dürfen zu eigenen wissenschaftlichen Zwecken und zum Privatgebrauch gespeichert und kopiert werden.

Sie dürfen die Dokumente nicht für öffentliche oder kommerzielle Zwecke vervielfältigen, öffentlich ausstellen, öffentlich zugänglich machen, vertreiben oder anderweitig nutzen.

Sofern die Verfasser die Dokumente unter Open-Content-Lizenzen (insbesondere CC-Lizenzen) zur Verfügung gestellt haben sollten, gelten abweichend von diesen Nutzungsbedingungen die in der dort genannten Lizenz gewährten Nutzungsrechte.

**Terms of use:**

*Documents in EconStor may be saved and copied for your personal and scholarly purposes.*

*You are not to copy documents for public or commercial purposes, to exhibit the documents publicly, to make them publicly available on the internet, or to distribute or otherwise use the documents in public.*

*If the documents have been made available under an Open Content Licence (especially Creative Commons Licences), you may exercise further usage rights as specified in the indicated licence.*



<https://creativecommons.org/licenses/by/4.0/>



*sustainability*

Special Issue Reprint

---

# Current Trends in Tourism under COVID-19 and Future Implications

---

Edited by  
Zygmunt Kruczek and Bartłomiej Walas

[mdpi.com/journal/sustainability](https://mdpi.com/journal/sustainability)



# **Current Trends in Tourism under COVID-19 and Future Implications**





# Current Trends in Tourism under COVID-19 and Future Implications

Editors

**Zygmunt Kruczek**  
**Bartłomiej Walas**



Basel • Beijing • Wuhan • Barcelona • Belgrade • Novi Sad • Cluj • Manchester

*Editors*

Zygmunt Kruczek

Faculty of Tourism and Recreation

University School of

Physical Education

Kraków

Poland

Bartłomiej Walas

Faculty of Tourism and Recreation

University College of Tourism

and Ecology

Sucha Beskidzka

Poland

*Editorial Office*

MDPI

St. Alban-Anlage 66

4052 Basel, Switzerland

This is a reprint of articles from the Special Issue published online in the open access journal *Sustainability* (ISSN 2071-1050) (available at: [www.mdpi.com/journal/sustainability/special\\_issues/covid\\_tourism](http://www.mdpi.com/journal/sustainability/special_issues/covid_tourism)).

For citation purposes, cite each article independently as indicated on the article page online and as indicated below:

Lastname, A.A.; Lastname, B.B. Article Title. <i>Journal Name</i> <b>Year</b> , <i>Volume Number</i> , Page Range.
--

**ISBN 978-3-0365-9491-0 (Hbk)**

**ISBN 978-3-0365-9490-3 (PDF)**

**[doi.org/10.3390/books978-3-0365-9490-3](https://doi.org/10.3390/books978-3-0365-9490-3)**

© 2023 by the authors. Articles in this book are Open Access and distributed under the Creative Commons Attribution (CC BY) license. The book as a whole is distributed by MDPI under the terms and conditions of the Creative Commons Attribution-NonCommercial-NoDerivs (CC BY-NC-ND) license.

# Contents

<b>About the Editors</b> . . . . .	<b>ix</b>
<b>Preface</b> . . . . .	<b>xi</b>
<b>Paulo Rita, Nuno António and João Neves</b> The Impact of the COVID-19 Pandemic on the Tourism Sector in the Autonomous Region of Madeira Reprinted from: <i>Sustainability</i> <b>2023</b> , <i>15</i> , 12298, doi:10.3390/su151612298 . . . . .	<b>1</b>
<b>Łukasz Gawel</b> Museums without Visitors? Crisis of the Polish Museums during the COVID-19 Pandemic and Their Revival under the Digital Experience Offer Reprinted from: <i>Sustainability</i> <b>2023</b> , <i>15</i> , 11844, doi:10.3390/su151511844 . . . . .	<b>18</b>
<b>Marek Nocoń, Lucyna Jurzak, Paweł Kruszelnicki, Marcin Ziobro and Aleksandra Fabin-Jadczyk</b> Actual and Expected Competencies in the Meetings Industry Sector during the Post-COVID-19 Era: The Case Studies Poland, Ireland, and Hungary Reprinted from: <i>Sustainability</i> <b>2023</b> , <i>15</i> , 11686, doi:10.3390/su151511686 . . . . .	<b>32</b>
<b>Yanqing Xia</b> How Has Online Digital Technology Influenced the On-Site Visitation Behavior of Tourists during the COVID-19 Pandemic? A Case Study of Online Digital Art Exhibitions in China Reprinted from: <i>Sustainability</i> <b>2023</b> , <i>15</i> , 10889, doi:10.3390/su151410889 . . . . .	<b>58</b>
<b>Yajuan Dong, Yi Jin and Khan Anwar Kamal</b> The Impact of Perceived Quality of Government Subsidies on Residents' Travel Intention Post-COVID-19 in Wuhan, China Reprinted from: <i>Sustainability</i> <b>2023</b> , <i>15</i> , 10812, doi:10.3390/su151410812 . . . . .	<b>78</b>
<b>Oumaima Lamhour, Larbi Safaa and Dalia Perkumiėnė</b> What Does the Concept of Resilience in Tourism Mean in the Time of COVID-19? Results of a Bibliometric Analysis Reprinted from: <i>Sustainability</i> <b>2023</b> , <i>15</i> , 9797, doi:10.3390/su15129797 . . . . .	<b>96</b>
<b>David Chiawo, Collins Haggai, Veronica Muniu, Rose Njuguna and Peggy Ngila</b> Tourism Recovery and Sustainability Post Pandemic: An Integrated Approach for Kenya's Tourism Hotspots Reprinted from: <i>Sustainability</i> <b>2023</b> , <i>15</i> , 7291, doi:10.3390/su15097291 . . . . .	<b>119</b>
<b>Andrzej Dudek, Daria Elżbieta Jaremen and Izabela Michalska-Dudek</b> Factors Determining ROPO Behaviors of Travel Agencies Customers during the COVID-19 Pandemic Reprinted from: <i>Sustainability</i> <b>2023</b> , <i>15</i> , 6142, doi:10.3390/su15076142 . . . . .	<b>132</b>
<b>Youssef El Archi, Brahim Benbba, Zhulduz Nizamatinova, Yerlan Issakov, Gálicz Ivett Vargáné and Lóránt Dénes Dávid</b> Systematic Literature Review Analysing Smart Tourism Destinations in Context of Sustainable Development: Current Applications and Future Directions Reprinted from: <i>Sustainability</i> <b>2023</b> , <i>15</i> , 5086, doi:10.3390/su15065086 . . . . .	<b>150</b>

<b>Hadigheh Morabi Jouybari, Amir Ghorbani, Hossein Mousazadeh, Azadeh Golafshan, Farahnaz Akbarzadeh Almani and Dávid Lóránt Dénes et al.</b> Smartphones as a Platform for Tourism Management Dynamics during Pandemics: A Case Study of the Shiraz Metropolis, Iran Reprinted from: <i>Sustainability</i> <b>2023</b> , <i>15</i> , 4051, doi:10.3390/su15054051 . . . . .	<b>164</b>
<b>Dominik Borek and Daniel Puciato</b> Extraordinary and Unavoidable Circumstances in Tourism under COVID-19 and Post Pandemic Times—Casus Poland as Example of Sustainability Management Reprinted from: <i>Sustainability</i> <b>2023</b> , <i>15</i> , 2416, doi:10.3390/su15032416 . . . . .	<b>181</b>
<b>Shiqi Zhang, Tianwei Sun and Yuan Lu</b> The COVID-19 Pandemic and Tourists' Risk Perceptions: Tourism Policies' Mediating Role in Sustainable and Resilient Recovery in the New Normal Reprinted from: <i>Sustainability</i> <b>2023</b> , <i>15</i> , 1323, doi:10.3390/su15021323 . . . . .	<b>192</b>
<b>Tsung-Hung Lee and Fen-Hauh Jan</b> How Does Personality Affect COVID-19 Pandemic Travel Risk Perceptions and Behaviors? Evidence from Segment Analysis in Taiwan Reprinted from: <i>Sustainability</i> <b>2022</b> , <i>15</i> , 655, doi:10.3390/su15010655 . . . . .	<b>212</b>
<b>Dariusz Jacek Olszewski-Strzyżowski, Marcin Pasek and Mariusz Lipowski</b> Perspectives for Tourism Development in the Post-Pandemic Period in the Opinions of University Students Reprinted from: <i>Sustainability</i> <b>2022</b> , <i>14</i> , 16833, doi:10.3390/su142416833 . . . . .	<b>227</b>
<b>Tamara Gajić, Dragan Vukolić, Marko D. Petrović, Ivana Blešić, Miloš Zrnić and Drago Cvijanović et al.</b> Risks in the Role of Co-Creating the Future of Tourism in “Stigmatized” Destinations Reprinted from: <i>Sustainability</i> <b>2022</b> , <i>14</i> , 15530, doi:10.3390/su142315530 . . . . .	<b>248</b>
<b>Marek Nowacki and Marianna Nurkowska</b> Crisis Management in Restaurants: The Case of Polish Restaurants during the COVID-19 Pandemic Reprinted from: <i>Sustainability</i> <b>2022</b> , <i>14</i> , 14631, doi:10.3390/su142114631 . . . . .	<b>267</b>
<b>Elisabeth Nöhammer, Marco Haid, Philipp Corradini, Susanne Attenbrunner, Peter Heimerl and Robert Schorn</b> Contextual Factors of Resilient Tourism Destinations in a Pandemic Situation: Selected Cases from North and South Tyrol during the SARS-CoV-2 Pandemic Reprinted from: <i>Sustainability</i> <b>2022</b> , <i>14</i> , 13820, doi:10.3390/su142113820 . . . . .	<b>279</b>
<b>Gunawan Prayitno, Ainul Hayat, Achmad Efendi, Aidha Auliah and Dian Dinanti</b> Structural Model of Community Social Capital for Enhancing Rural Communities Adaptation against the COVID-19 Pandemic: Empirical Evidence from Pujon Kidul Tourism Village, Malang Regency, Indonesia Reprinted from: <i>Sustainability</i> <b>2022</b> , <i>14</i> , 12949, doi:10.3390/su141912949 . . . . .	<b>299</b>
<b>Wojciech Fedyk, Mariusz Sołtysik, Justyna Bagińska, Mateusz Ziemba, Małgorzata Kołodziej and Jacek Borzyszkowski</b> How Did the COVID-19 Pandemic Affect Functional Relationships in Activities between Members in a Tourism Organization? A Case Study of Regional Tourism Organizations in Poland Reprinted from: <i>Sustainability</i> <b>2022</b> , <i>14</i> , 12671, doi:10.3390/su141912671 . . . . .	<b>313</b>

<b>Monika Widz, Renata Krukowska, Bartłomiej Walas and Zygmunt Kruczek</b> Course of Values of Key Performance Indicators in City Hotels during the COVID-19 Pandemic: Poland Case Study Reprinted from: <i>Sustainability</i> <b>2022</b> , <i>14</i> , 12454, doi:10.3390/su141912454 . . . . .	<b>333</b>
<b>Wojciech Fedyk, Mariusz Sołtysik, Justyna Bagińska, Mateusz Ziemba, Małgorzata Kołodziej and Jacek Borzyszkowski</b> Changes in DMO's Orientation and Tools to Support Organizations in the Era of the COVID-19 Pandemic Reprinted from: <i>Sustainability</i> <b>2022</b> , <i>14</i> , 11611, doi:10.3390/su141811611 . . . . .	<b>349</b>
<b>Adam Pawlicz, Ema Petaković and Ana-Marija Vrtodušić Hrgović</b> Beyond Airbnb. Determinants of Customer Satisfaction in P2P Accommodation in Time of COVID-19 Reprinted from: <i>Sustainability</i> <b>2022</b> , <i>14</i> , 10734, doi:10.3390/su141710734 . . . . .	<b>368</b>
<b>Theodore Metaxas, Laura Juárez and Meletios Andrinou</b> Measuring the Impact of Greece as a Safe Branding Tourist Destination: Evidence from Spain and Greece Reprinted from: <i>Sustainability</i> <b>2022</b> , <i>14</i> , 4440, doi:10.3390/su14084440 . . . . .	<b>383</b>
<b>Umer Zaman, Stuart J. Barnes, Saba Abbasi, Mahwish Anjam, Murat Aktan and Muddasar Ghani Khwaja</b> The Bridge at the End of the World: Linking Expat's Pandemic Fatigue, Travel FOMO, Destination Crisis Marketing, and Vaxication for "Greatest of All Trips" Reprinted from: <i>Sustainability</i> <b>2022</b> , <i>14</i> , 2312, doi:10.3390/su14042312 . . . . .	<b>400</b>



# About the Editors

## **Zygmunt Kruczek**

Zygmunt Kruczek is a professor with a Ph.D. in physical culture and head of the Department of Geography of Tourism and Ecology at the Faculty of Tourism and Recreation at the University of Physical Education in Krakow. He specializes in research on tourist attractions, regional aspects of the geography of tourism, tourism promotion, and information. He is the president of the Polish Association of Tourism Experts.

## **Bartłomiej Walas**

Bartłomiej Walas, PhD, is an assistant professor at the University College of Tourism and Ecology in Sucha Beskidzka, Poland. He specializes in tourism policy and tourism marketing. He is the Dean of the Tourism and Recreation Faculty, the former vice president of the Polish National Tourist Organization, the author of regional tourism development and marketing strategies, and a member of the Council of the Chamber of Commerce of the Polish Hotel Industry. He has published articles in Polish and foreign scientific journals.





# Preface

In the literature, as well as in the media and the scientific community, the impact of the pandemic on tourism has been the most commonly discussed topic over the last two years. Nevertheless, with the development of the situation, our knowledge is being supplemented day by day. In particular, this Special Issue (24 papers) aspires to expand the discussion and scientific debate on a range of viewpoints, trends, approaches, cases, impacts, challenges, models, and/or frameworks relating to tourism in the time of COVID-19, as well as the possibility of implementing the principles of sustainable tourism development in the post-pandemic period.

At the time of the issue, the world has been freed from the pandemic (although new negative political and economic phenomena have arisen), and tourism is approaching sizes close to those of 2019. Problems that constituted a significant barrier to the construction of sustainable tourism are even beginning to be noted. From the point of view of the 2023 season, many destinations in the pandemic situation of “undertourism” are re-entering the familiar phenomenon of overtourism. There is no doubt that many of these cities, regions, and even countries are looking for a tool for “new tourism”, because it is not just about restarting tourism. The results of research conducted during the pandemic and the conclusions and implications for the further development of tourism drawn on this basis are valuable case studies from various regions, countries, and continents.

They allow for a scientific discussion, from a number of points of view, not only on the effects of the pandemic on tourism but also on the expected trends, effects, challenges, or models of solutions for the implementation of the principles of sustainable development of tourism in the post-pandemic period. One gets the impression that the pandemic has accelerated both the scientific and pragmatic discussion, seeking answers to questions about post-pandemic changes in tourism demand as well as legal, organizational, or marketing solutions for the commercialization of tourist services and destination management. There is a topic of building healthy relations between various groups of tourism stakeholders, including entrepreneurs and tourists, or priorities in the area of marketing and sales undertaken by entrepreneurs and the Destination Management Organization. An answer was also sought to the question of the impact of the pandemic on the tourism economy. The literature review analysis of smart tourism in the context of sustainable development is also valuable for researchers.

The articles published online are already very popular. They have been viewed by several thousand researchers and cited 55 times by other authors (as of August 2023).

We sincerely thank all the authors for their contributions to this Special Issue.

**Zygmunt Kruczek and Bartłomiej Walas**

*Editors*



## Article

# The Impact of the COVID-19 Pandemic on the Tourism Sector in the Autonomous Region of Madeira

Paulo Rita \*, Nuno António  and João Neves

NOVA Information Management School (NOVA IMS), Universidade NOVA de Lisboa, 1070-312 Lisbon, Portugal

\* Correspondence: prita@novaims.unl.pt

**Abstract:** The highly regarded and award-winning tourism destination that is the autonomous region of Madeira (ARM), in the Madeira and Porto Santo islands, has suffered the consequences that the COVID-19 pandemic has brought to tourism through the mobility limitations as well as the fear faced by travelers. From data collected on tourism, COVID-19, and demography in ARM from the years 2019 to 2020, this study makes use of data science techniques, including statistics, data mining, and data visualization, to analyze the direct and indirect effects of the coronavirus outbreak as well as the weight of population density in the propagation of the virus. The results validate a direct effect and show evidence of dense regions having aggravated virus propagation, but they do not corroborate the idea that an indirect effect was significant.

**Keywords:** COVID-19; Madeira; tourism; population density; correlation significance analysis; k-means clustering



**Citation:** Rita, P.; António, N.; Neves, J. The Impact of the COVID-19 Pandemic on the Tourism Sector in the Autonomous Region of Madeira. *Sustainability* **2023**, *15*, 12298. <https://doi.org/10.3390/su151612298>

Academic Editors: Zygmunt Kruczek and Bartłomiej Walas

Received: 12 June 2023

Revised: 2 August 2023

Accepted: 4 August 2023

Published: 11 August 2023



**Copyright:** © 2023 by the authors. Licensee MDPI, Basel, Switzerland. This article is an open access article distributed under the terms and conditions of the Creative Commons Attribution (CC BY) license (<https://creativecommons.org/licenses/by/4.0/>).

## 1. Introduction

The COVID-19 pandemic was a worldwide health emergency that tragically took the lives of over 2 million people globally [1]. To date, the transmission of this coronavirus is believed by scientists to be performed by direct transmission, from person to person, in close contact situations, or, on rare occasions, by touching contaminated surfaces or objects. In order to prevent the virus from spreading further, governments across the globe have followed the World Health Organization's (WHO) guidelines and implemented restrictive measures that range from schedule limitations and air traffic restrictions to complete lockdowns of entire regions.

Although these measures have shown effectiveness in stabilizing the spread of the virus, they dramatically offset the businesses forced to shut down their establishments and most businesses that relied on tourism for consumption. It has been previously determined that infectious disease outbreaks, including the coronavirus, greatly jeopardize the tourism industry, given its reliance on human mobility [2].

The tourism sector, being a highly vulnerable industry to various environmental, political, and socio-economic risks, is accustomed to and has become robust and resilient in recovering [3] from several distinct categories of crises, such as natural catastrophes, health emergencies, and terrorism attacks, among plenty others. Nevertheless, the nature and unprecedented events of the COVID-19 pandemic reveal signs that this health emergency is not only unique and unusual but has also produced profound and long-run transformations to the structure of tourism as an industry and its socio-economic activity [4,5].

Multiple authors have previously studied the impact of economic crises on tourism as well as the impact of pandemics on the economy. While not many have explored the impact of health-related crises on tourism, numerous new studies have emerged in recent times about the impact the COVID-19 pandemic has had on the tourism sector. Nevertheless, literature on the impact of pandemics on tourism has uncovered a number of gaps. There appears to be a controversy in the results regarding whether population density has a

negative impact on the propagation and severity of pandemics. Concerning COVID-19, some authors, namely [6–8], refer to population level indicators as highly and significantly correlated to the number of infections. Thus, this indicator is considered a determinant in the proliferation of viruses, and other authors have obtained results that do not corroborate the idea that population density is a determining factor of influence in the context of the pandemic. A study by [9] recalls the case of some extremely populationally dense cities, such as Singapore, Seoul, and Shanghai, that have outperformed other less dense cities in fighting the COVID-19 pandemic and uses an empirical approach to study the impact of the population density of Chinese cities on the proliferation of the coronavirus, and its results found no significant correlation between the two either. The opposing results among the authors do not allow for a clear answer to the given question, therefore originating a gap in the research where there is no objective conclusion.

Furthermore, the literature that studies the indirect impact of pandemics on tourism tends to use a theoretical approach. Of the few studies that followed an empirical approach, most used questionnaires to assess the population's opinion, demonstrating a lack of author contributions and real daily data. The use of real data are recognized to have higher reliability and accuracy than questionnaire data [10].

Considering the identified gaps, this study aims to assess the direct and indirect impact of the pandemic on the tourism sector in the autonomous region of Madeira. This study also aims to understand whether the impact of the pandemic varied by municipality. This type of study is necessary to reinforce the knowledge available for governmental decision-making for future pandemics or health-related crises based on cyclical patterns, which tend to recur with various types of viruses and bacteria, reappearing inevitably at some point in time.

As Portugal's third most visited region, following the Algarve and Lisbon, the autonomous region of Madeira (ARM) is an enticing archipelago renowned for its lush landscapes, unique flora and fauna, vibrant culture, and the world-famous Madeira wine [11]. Historically, the autonomous region of Madeira is notorious for having a local economy heavily reliant on tourism activity as its primary source of income, with 26% of its regional GDP associated with tourism products. The sector is responsible for 20 thousand workstations in the region, and therefore, it is no surprise that the archipelago was deeply affected by the pandemic. In 2020, the tourism sector was virtually disabled for several months and heavily restricted upon reopening, and as such, the major source of income for the local economy was cut down, and the whole sector was drastically impacted. Statistics published by DREM show that the sector was reduced to zero activity every month, and the region's GDP was reduced by 2.2%. According to the same source, this sector's indicators, such as the arrivals and sleepovers of tourists in the region, the income of accommodation services, and occupation rates of these services, among others, dropped dramatically to zero or extremely low values in the second trimester of 2020, leaving it clear that the damages caused by the pandemic were devastating not only for the industry and healthcare sectors but also to the tourism sector [12].

In particular, this study tries to answer four research questions. The first research question is whether or not there was a direct impact of the COVID-19 pandemic on tourism in the year 2020, in the autonomous region of Madeira, in light of what is suggested by the vast majority of the authors [13,14] as well as [15] and in domestic studies on the impacts of the COVID-19 crisis on the tourism expectations of the Azores Archipelago residents [16]. Although most studies support this direct impact and its expected results are similar to those obtained by the authors mentioned above, this is seen as a highly relevant subject of analysis in the context of the topic of this study.

Similarly, the second research question is whether or not there was an indirect impact of the COVID-19 pandemic on tourism, in light of studies such as the one made by [17] on the indirect effect of malaria outbreaks on tourism in African regions where there were no cases and also in a very recent study that focuses on how fear aggravated the damage caused to tourism in China by the COVID-19 pandemic, as suggested by [18].

The third research question is whether the population density of the municipalities significantly influenced the spreading of the virus in the autonomous region of Madeira, and it originates from several research papers that have focused their studies on the link between the population density of the territories and the current pandemic. As mentioned in the literature review, the results among studies have been somewhat contradictory, but the results seem to converge to a positive relationship [6–8,19–26]. However, other studies point to the fact that the density of the population is not significant and cannot be a determining factor in the spread of COVID-19 [9]. The study by [27] evaluates this effect as non-significant in earlier stages, with increasing significance in later stages of the pandemic.

The fourth research question is whether there are chunks of similar data that can be grouped to identify and classify affected municipalities, as suggested by the studies above [7], or if the region handled the virus homogeneously.

## 2. Literature Review

Epidemic and pandemic emergencies often provoke critical negative swings in demand for usually popular travel destinations, as tourists may, knowing of the risks, cancel their trips in case they opt not to expose themselves to such dangers, becoming contaminated or even restrained in a foreign location indeterminably [28]. Each person's perceived risk associated with traveling during outbreaks has been shown to affect their willingness to travel [29]. A study published by representatives of the University of Technology Republic of South Africa [17] focuses on the indirect impact of pandemics on tourism in Africa. The study addresses the example of the Ebola crisis, which affected various African tourism destinations, which experienced lower travel demand and, therefore, lower tourism consumption, some of which was due to direct consequences of the pandemic. However, it also refers to the fact that the travelers canceled their trips even to faraway lands such as South Africa, Kenya, and West Africa, with no reported virus cases.

Furthermore, hotel occupancy rates in Nigeria dropped by half due to media coverage of Ebola before cases were reported in the region. The authors additionally address the Zika outbreak in South America, which was declared a public health emergency by the World Health Organization (WHO), and the declaration itself showed a negative impact on sport tourism gatherings and religious gatherings. The study focuses on the indirect effect of these health emergencies on tourism without directly affecting a region. On a similar note, a recent study focuses on the COVID-19 pandemic and how it generated an unprecedented level of public fear, and it studies how such fear aggravated the damage caused to tourism in China during the pandemic [18]. Other studies analyzed the impact of the fear caused by the SARS virus outbreak in 2004 and how it reduced people's propensity to travel. The consensus amongst the authors is that multiple traveling fear-inducing factors emerge from health emergencies, and even in regions that have not suffered directly from them, tourism has indirect consequences that originate from the effects of the media, international tourism, and globalization [30].

In a chain of events, factors that promote the spread of diseases inevitably end up damaging the tourism sector by amplifying the dimension taken by the outbreaks. Multiple authors have highlighted that population density is a major source of concern for health and governmental authorities, especially in the case of highly contagious diseases such as the one caused by the novel SARS-CoV-2 virus, which is the reason why experts have claimed physical distancing to be one of the most effective measures to fight the spread of the virus [27]. Regarding the available literature on the relationship between population density and the spread of pandemics, there has been a lack of historical documentation. Highlighted in the context of this relationship are several studies [22–24,26], which, despite using different approaches and methodologies, have shown converging results regarding this relationship, which are that of a strong influence of population density on the rate of spread of pandemics and epidemics and indicate a positive relationship between this indicator and the speed at which diseases spread out. However, in recent times, several research

papers have been studying the link between the population density of the territories and the current COVID-19 pandemic, and the results among the studies have been somewhat contradictory, though the relation is positive the majority of the time. Ref. [21] studied how this relationship panned out in the United States, particularly in the state of Alabama, and found that, despite having less testing per population density, new infections were disproportionately more frequent in heavily populated regions, indicating that not only infections were more prominent in highly dense regions of the state but also that instances in these areas may even be underreported. Ref. [25] dove deeper into the United States case by studying the relationship between this indicator and the reproductive number of infections across the country's counties, verified with a sensitivity analysis of the results. Their findings were that this relationship is positive and significant across counties, regardless of multiple other factors, such as public transportation usage versus personal vehicle ownership and household income. The relationship is possibly justified due to higher contact rates due to higher population density. Conversely, in the geographical context of the United States, a bivariate and multivariate regression approach has been applied to indicate that population density has little significance when explaining the number of infections throughout the country. However, it became a good predictor of the results of cumulative infections as the virus spread across the United States, concluding that this indicator, while not being as good of a predictor in the early stages of a pandemic, has shown its weight as the infectious disease started spreading and reached later stages [27].

When looking at the case of India, one of the densest countries in the world, studies made on the influence of population density and the COVID-19 pandemic in Indian states have shown that, even in states with the most sophisticated healthcare infrastructure, the spatial analysis has shown that density strongly influenced the virus' transmission rate [19]. A similar study by [31] also analyzes how population density has impacted infection and mortality rates in Indian cities by using Pearson R and regression, and its results also indicate that the relationship is positive. Ref. [20] also uses a regression model to investigate how this relationship performs in Turkish cities by measuring the impact of population density on the elasticity of the curve that is drawn by infection cases and finds that density accentuates the rate at which the cases rise and that lower densities are linked to values of elasticity that are close to or even lower than 1, which means that the curve tends to flatten out for the lowest density cities. On the same note, the results show that the curve rises most of the time and becomes steeper as density increases. Ref. [32] adds to this topic by analyzing how the virus spread was influenced by wind and population density in 81 provinces in Turkey and also finding that dense provinces had a faster rate of infections. Equally, dense provinces were negatively affected by wind, assuming that higher wind speeds increase air circulation and promote transmission. The two parameters were found to explain 94% of the variance of virus spreading and thus were concluded to have had a significant influence on the proliferation of the virus, particularly when working together.

The French study by [6] suggested that the link between the density of French territories based on data from the 2016 Census and the epidemic was positive most of the time, assuming that a higher density would result in a higher propensity for one to become contaminated or by a higher death rate, despite Chinese studies stating otherwise, leveraging the distance to Wuhan, the epicenter of the epidemic, as a bigger factor than population density regarding this relationship in China. The study by [7] focuses on population density as a factor in the spread of COVID-19 in Algeria, where a clustering algorithm allowed to isolate the groups of cities with higher numbers of COVID-19 infections as well as the highest population densities and found strong correlations associated with high significance regarding that relationship. The data analysis findings verified that population density positively affected the spread of COVID-19 in Algeria. Additionally, a study of European countries and the USA determined that population density has a small but substantial effect on the rate of spread of the virus and claims that there is a significant correlation between these two variables with a correlation coefficient of  $R^2 = 0.23$  in Europe and  $R^2 = 0.39$  in the USA [8]. Conversely, other analyses believe that the density of the popu-

lation is not a topic of concern and cannot be a determining factor in the proliferation of pandemics such as COVID-19 and use cities such as Singapore, Seoul, Shanghai, and New York as counterexamples because of their underlying dense populations, whose number of infections caused by the COVID-19 pandemic was no different from the ones documented in cities with low urban density in per capita terms.

Similarly, in an empirical study from China on data collected from 284 Chinese cities, the results do not corroborate the idea that population density is a determining factor for the transmission of COVID-19. On the other hand, the most afflicted cities have a relatively low density between 5000 and 10,000 inhabitants per km<sup>2</sup> [9]. Other studies have also found other inconsistent results regarding this relationship, showing no significant relationship between COVID-19 spreading and population density, and explain it through the heavy, restrictive measures used by the Chinese government, which were one of the strictest across the globe, which effectively reduced the extent to which density could affect a country that was on an entire lockdown and heavily restricted human-to-human contact.

Several authors have also contributed to the topic of the negative direct impact of the pandemic on the tourism sector. The first of the studies is the one by [13], which focuses on the direct impact of COVID-19 on the tourism industry in Malaysia, particularly on the airlines and hotel businesses, having reached conclusive results on the dramatic damage caused to the sector due to, not only the increase in cases but also revealing a large number of tourists that canceled their trips due to the Malaysian government imposing travel restrictions and bans, most of which were recommended or even imposed by the World Health Organization. There is also the study by [14] that also focuses on how COVID-19 induced a global change and hindered tourism worldwide and how they compared with previous pandemics, concluding that the COVID-19 pandemic had a magnitude in tourism that was never seen before, which also revealed and raised questions about the vulnerability of work posts, particularly low-wage work posts in the tourism sector, which were disproportionately affected by the crisis, especially in lower-income countries, exposing this weakness in the sector that is conceivable to be affected similarly by future health crises. Furthermore, the study by [15] also emphasizes the quarantine's impact on the tourism industry in Lviv, Ukraine, due to COVID-19. Its results show that the pandemic had a massive negative effect on all of the indicators of the tourism sector in Lviv in 2020, with a loss of tourism flow, expense, and budget, among others, and a severe economic and market crisis associated with it. In the domestic panorama, we have studied [16] the impacts of the COVID-19 crisis on the tourism expectations of the Azores Archipelago residents, and the results have shown that most of the residents had their travel expectations significantly lowered directly due to the pandemic. However, the results might include a significant level of indirect influence from the pandemic on the survey answers from the study.

Lastly, the study by [33] analyzes the COVID-19 pandemic through cluster analysis as a data mining process, finding groups of states with similar reactions to the pandemic regarding cured and death cases. This study would be interesting to see a more in-depth look at the demographics and other data and evaluate whether other variables might have influenced some countries to behave differently from others and which variables make some countries behave alike.

### 3. Methodology

The methodology chosen is the cross-industry standard process for data mining (CRISP-DM), a data mining model that uses the best practices to explore and analyze data. This model has been traditionally broken down into six steps: Business Understanding, Data Understanding, Data Preparation, Modeling, Evaluation, and Deployment.

### 3.1. Business Understanding

In this phase, the key is to determine the objectives of the data mining project. This phase involves identifying the available assets and resources, their associated constraints, and the objectives to be achieved with the project.

For this study, the objectives of the data mining project rely on gathering data and information about the tourism sector and the COVID-19 pandemic and using descriptive data mining tools to transform this data into knowledge, draw valuable conclusions, and extract meaningful results from previously fragmented data.

The data was mainly retrieved from the Direção de Regional de Estatística da Madeira (DREM) Tourism Reports from 2019 to 2020, the DREM Demographic Report from 2020, the Yearly Reports from Madeira Ports Association (APRAM) from 2019 to 2020 with data from cruise and merchandise ship movement, and COVID-19 data from Direção Geral de Saúde (DGS). The data collected were scattered across 16 tables and involved the 33 variables in Table 1.

**Table 1.** Variables' Metadata.

Variable	Meaning
newguests_2019	New guests arriving in hotels in 2019
newguests_2020	New guests arriving in hotels in 2020
newguests_var	Variation of new guests arriving in hotels 2019–2020
guests_2019	Lodged guests in 2019
guests_2020	Lodged guests in 2020
guests_var	Variation of lodged guests 2019–2020
sleepovers_2019	Sleepovers in hotels in 2019
sleepovers_2020	Sleepovers in hotels in 2020
sleepovers_var	Variation of sleepovers in hotels 2019–2020
totalincome_2019	Total hotel income 2019
totalincome_2020	Total hotel income 2020
totalincome_var	Variation in hotel income 2019–2020
totalroomincome_2019	Total room income 2019
totalroomincome_2020	Total room income 2020
totalroomincome_var	Variation in total room income 2019–2020
personelcosts_2019	Hotel personnel cost in 2019
personelcosts_2020	Hotel personnel cost in 2020
personelcosts_var	Variation in hotel personnel costs 2019–2020
stopovers_2019	Ships stopping over at the shore 2019
embarked_2019	Total of ship embarkments in 2019
disembarked_2019	Total of ship disembarkments in 2019
intransit_2019	Total ships in transit in 2019
stopovers_2020	Ships stopping over at the shore 2020
embarked_2020	Ships stopping over at the shore 2020
disembarked_2020	Total of ship disembarkments in 2020
intransit_2020	Total ships in transit in 2020
covid19casesportugal_2020	Registered COVID-19 Cases in Portugal
covid19casesmadeira_2020/covidcases	Registered COVID-19 Cases in Madeira
averagestay	Average time spent lodged in the region (days)
populationaldensity	Number of inhabitants per km <sup>2</sup>
longevity	Measure of population life expectancy
avgpopulation	Average population
worldcases	Registered COVID-19 cases worldwide

The software used for the data pre-processing was Python, using the Anaconda Notebook. The variables already include some calculated variables, such as the yearly percent variation of the arrival of tourists.

The 33 variables are described using two different approaches, scrutinized by month or municipality. In order to analyze this data, the 16 original tables were merged into only 2, which group data of each type, the Monthly Report and the Municipality Report:

**Monthly Report:** The data are scrutinized by month. The records are from January to December, and the variables include most of the earlier mentioned tourism indicators, COVID-19 variables, and demographic indicators of the whole Archipelago.

**Municipality Report:** The data are scrutinized by municipality. The records are the 11 municipalities of the Archipelago—Funchal, Machico, Ribeira Brava, Santa Cruz, Câmara



de Lobos, Calheta, Ponta do Sol, São Vicente, Porto Moniz, Santana, and Porto Santo—again, the variables include most of the tourism indicators mentioned above, COVID-19 variables, and demographic indicators.

### 3.2. Data Understanding

The data is collected and explored during this phase to understand its content, shape, structure, and properties. This is also the phase where the appropriate statistical tools and algorithms are determined to be more appropriate during the modeling phase.

For this study, data was collected from the sources previously mentioned. An overview was made of what variables could be extracted directly from the data sources, what other variables were needed, and if they could be created from existing ones, as well as identifying purposeless or redundant variables for the study to be discarded and creating preliminary graphs and charts to visualize the raw, initial data that allowed a personal interpretation and understanding of the available resources. In this phase, the main tools used were JMP and Python. Within Python, packages and libraries such as Pandas, Numpy, and Matplotlib were used, among plenty of others, to perform preliminary adjustments, column filtering, and evaluating data coherence.

### 3.3. Data Preparation

This phase includes cleaning, validation, remapping, and transformations of data, and the tools used were a combination of Python 3.10, Excel 2016, and JMP 16 by SAS. For this study, due to the nature of the data obtained from official institutions or governmental establishments, data cleaning was conducted only as a methodology principle. The validation process detected scarce missing, null, or duplicate values and inconsistencies. However, several transformations, including merging and remapping of data, were required since the elements were scattered across several sources and tables, so the procedure began by reorganizing the resources into new tables. By the end of this phase, the final datasets were ready to be used in the following modeling phase.

### 3.4. Modeling

After the data were remapped and ready to be analyzed, the first step was an exploratory data analysis, which began with a univariate analysis to study the variables' variances and outliers and determine whether normalization is required. Secondly, a bivariate analysis was also conducted, with a Pearson correlation analysis, where multicollinearity among the variables was checked.

If the correlation coefficient ranges between  $r = 0.50$  and  $r = 1.00$ , it depicts a strong positive or high degree of relationship between the two variables. If the correlation coefficient ranges between  $r = -1.00$  and  $r = -0.50$ , it relates to a strong negative relationship. If the correlation coefficient approaches  $r = 0.00$ , it indicates no correlation between the two variables.

Specific models and algorithms are selected and run on the data during the modeling phase. First, it is crucial to dive deeper than correlation analysis when dealing with multivariate data since it is never appropriate to conclude that changes in one variable cause changes in another based only on correlation alone, especially when dealing with subsets of data. Therefore, following the correlation analysis, a significance testing analysis was also performed to determine whether the relationships between variables were causal or meaningful by computing their statistical significance, which is obtained by evaluating the linear relationship between them. For this study, the method used in this stage was the  $p$ -value method, whose  $p$ -value score was then put under scrutiny by performing statistical testing to determine whether the correlation coefficient was significant.

Therefore, after setting  $\alpha$ , the significance level, in the case where:

$p\text{-value} \leq \alpha$ : The correlation is considered statistically significant.

$p\text{-value} > \alpha$ : The correlation is not considered statistically significant.

Furthermore, a clustering analysis was made to group the municipalities according to their associated variables in the Municipality Report to create segments of the study of the

composition of each cluster and, in particular, with interest in studying how COVID-19 infections and population densities behave among clusters. The algorithm used was k-means, an unsupervised algorithm that, given a k number of nearest neighbors, partitions n observations into k clusters, in which each observation is assigned to the cluster with the nearest mean, or centroid, minimizing the Euclidean distance of the observations concerning the centroid, which begin at given points for every cluster, and then as the algorithm runs in an iterative process, calculations are made to optimize the positions of the centroids, resulting in the formation of k clusters.

### 3.5. Evaluation

In this phase of the project, a review of the models is made to determine their accuracy and ability to meet the goals and objectives of the project identified in previous phases. So, in this case, the goal is to answer the questions asked in the model, extract conclusions about the results, and study similarities and differences in the clustering models.

### 3.6. Deployment

Finally, the deployment phase includes disseminating the information, which includes the tables and dashboards created within the tools used. In this case, these include the correlation and significance tables of all the tables used and the results of the clustering algorithm, complemented by the necessary reports to support them.

## 4. Results and Discussion

Correlations were calculated for every pair of variables in both datasets. Data analysis was made to test the significance of these relationships. We wanted to study if there was a relationship between worldwide COVID-19 infections and the arrival of new guests at lodging services in 2020 and if that would be negative. However, the results do not corroborate this idea. In the first half of the pandemic, we can observe that this relationship was linear and positive, after which it became irregular, as shown in Figures 1 and 2.

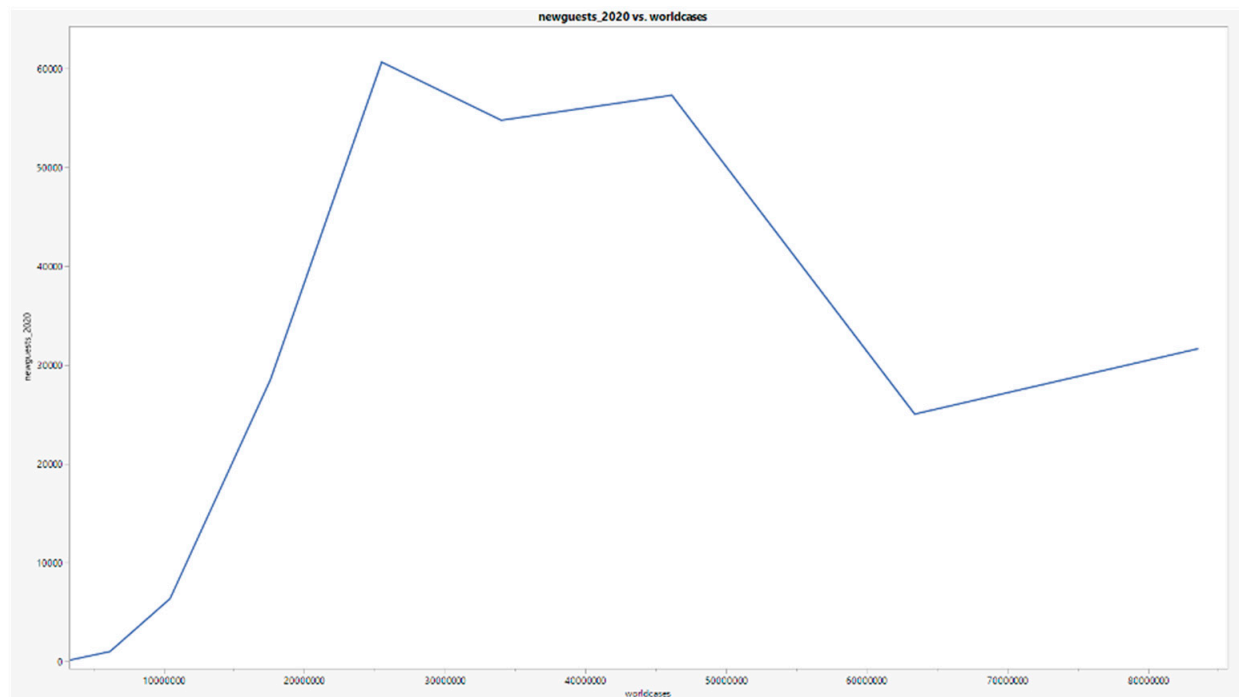

**Figure 1.** Evolution of new lodged guests per worldwide infection count.

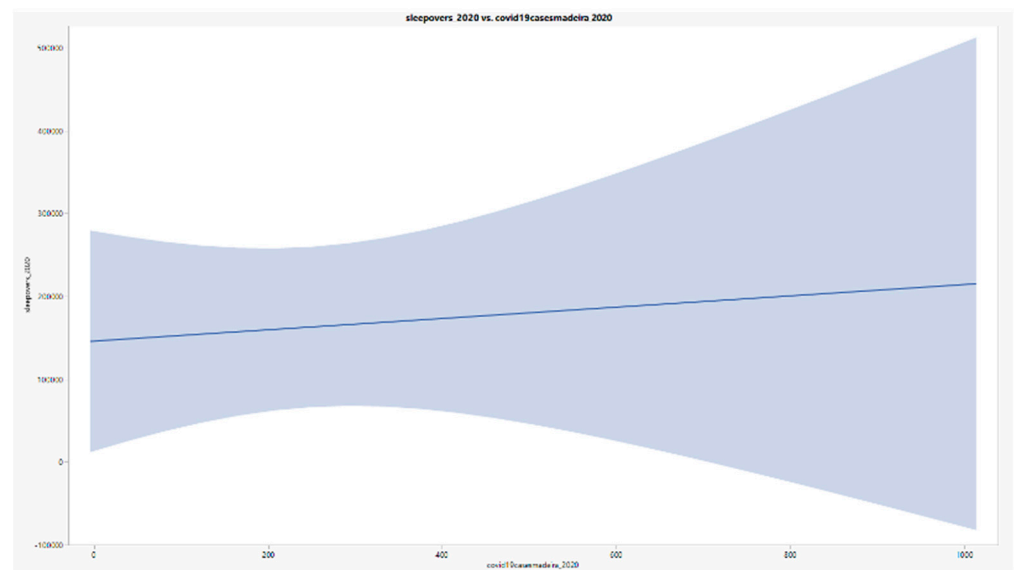

**Figure 2.** Line of Fit. Sleepover variation by regional infection count.

Firstly, a significance level of  $\alpha$  was set at  $\alpha = 0.05$  to evaluate the statistical significance of the correlation between registered COVID-19 cases in the region and the tourism variables. Highlighted in Figures 4 and 6 are the  $p$ -values of such correlations, referring to the Monthly Report and the Municipality Report, respectively. Also highlighted in red are the results whose  $p$ -value is smaller than the significance level  $\alpha$ . This means there is sufficient evidence to conclude that there is a significant linear relationship between those variables and the count of infections due to the correlation coefficient being significantly different from zero. If a slightly less usual significance level of  $\alpha = 0.1$  were to be assumed, variables “Longevity” and “COVID-19 cases in Madeira” would also become significantly correlated, which is an interesting result since older age groups, and in particular rural populations, tend to overlook and neglect these sorts of health crises, possibly explaining this result. However, keeping the current  $\alpha$ , this correlation remains statistically insignificant.

Analyzing the significance of the variables’ “New guests”, “Guests”, “Sleepovers” and “Average Stay” correlation with “COVID-19 cases in Madeira”, the results might appear counterintuitive at first since they are positively correlated. However, one can consider these values to reflect the region’s governmental policies. Such policies include testing the travelers arriving in ARM and the mandatory hotel quarantine until they receive their test results. Thus, these policies can explain why an increase in cases leads to more people being lodged in tourism accommodation services and consequently explain the correlation and significance level between the variables.

The correlation matrix for monthly data (Figure 3) shows that most of the correlations that made sense to investigate seem to have counterintuitive values and are not objectively what was expected. Additionally, by analyzing the values obtained in the  $p$ -value matrix (Figure 4), the results show that, when looking at the confirmed cases in the region, there is a pattern of negative correlations with most of the remaining variables. These results point towards the negative relationship that was expected. However, the  $p$ -value analysis of these correlations has revealed no statistical significance in the correlations between COVID-19 cases and the tourism indicators from 2020, so the results do not validate the significance of the negative relationship found and are thus not in line with the results obtained by [13–16], where this relationship was found to be positive.

	newguests_2020	newguests_var	guests_2020	guests_var	sleepovers_2020	sleepovers_var	totalincome_2020	totalincome_var	totalroomincome_2020
newguests_2020	1	0.9501	0.9928	0.943	0.9778	0.9201	0.9753	0.9122	0.9765
newguests_var	0.9501	1	0.9648	0.9974	0.9838	0.9919	0.9789	0.9888	0.9796
guests_2020	0.9928	0.9648	1	0.9648	0.9933	0.9461	0.9923	0.9401	0.9929
guests_var	0.943	0.9974	0.9648	1	0.9866	0.997	0.9827	0.9951	0.9829
sleepovers_2020	0.9778	0.9828	0.9933	0.9866	1	0.9755	0.9978	0.9714	0.9982
sleepovers_var	0.9201	0.9919	0.9461	0.997	0.9755	1	0.9717	0.9997	0.9715
total income_2020	0.9753	0.9789	0.9923	0.9837	0.9978	0.9717	1	0.9678	0.9999
total income_var	0.9122	0.9888	0.9401	0.9951	0.9714	0.9997	0.9678	1	0.9674
totalroomincome_2020	0.9765	0.9796	0.9929	0.9829	0.9982	0.9715	0.9999	0.9674	1
totalroomincome_var	0.9123	0.9888	0.9385	0.9944	0.9699	0.9994	0.9658	0.9998	0.9655
personelcosts_2020	0.8652	0.8529	0.8888	0.8652	0.8819	0.8525	0.8994	0.8506	0.8964
personelcosts_var	0.8962	0.8855	0.9242	0.9004	0.9207	0.8889	0.9353	0.8873	0.9325
stopovers_2020	0.6711	0.8394	0.7381	0.8584	0.8004	0.873	0.7908	0.8771	0.7923
embarked_2020	0.7281	0.8241	0.7757	0.8515	0.8266	0.8761	0.8128	0.882	0.8127
disembarked_2020	0.6979	0.7989	0.7605	0.8336	0.8218	0.8571	0.8043	0.8639	0.8038
intransit_2020	0.6969	0.8598	0.7573	0.8769	0.8202	0.8935	0.8076	0.8972	0.8092
covid19casesportugal_2020	-0.2007	-0.1799	-0.2039	-0.1793	-0.2156	-0.1778	-0.2066	-0.1718	-0.2121
covid19casesmadeira_2020	-0.1508	-0.153	-0.1876	-0.176	-0.2041	-0.1701	-0.1587	-0.1677	-0.163
	totalroomincome_var	personelcosts_2020	personelcosts_var	stopovers_2020	embarked_2020	disembarked_2020	intransit_2020	covid19casesportugal_2020	covid19casesmadeira_2020
newguests_2020	0.9123	0.8652	0.8962	0.6711	0.7281	0.6979	0.6969	-0.2007	-0.1508
newguests_var	0.9588	0.8529	0.8855	0.8394	0.8241	0.7989	0.8598	-0.1799	-0.153
guests_2020	0.9385	0.8888	0.9242	0.7381	0.7757	0.7605	0.7573	-0.2039	-0.1876
guests_var	0.9944	0.8652	0.9004	0.8584	0.8515	0.8336	0.8769	-0.1793	-0.176
sleepovers_2020	0.9698	0.8819	0.9207	0.0004	0.8266	0.8118	0.8202	-0.2156	-0.2041
sleepovers_var	0.9994	0.8525	0.8889	0.873	0.8761	0.8571	0.8335	-0.1778	-0.1701
total income_2020	0.9658	0.8994	0.9353	0.7908	0.8128	0.8043	0.8076	-0.2066	-0.1587
total income_var	0.9998	0.8506	0.8873	0.8771	0.882	0.8639	0.8972	-0.1718	-0.1677
totalroomincome_2020	0.9655	0.8964	0.9325	0.7923	0.8127	0.8038	0.8092	-0.2121	-0.163
totalroomincome_var	1	0.8482	0.854	0.8706	0.882	0.8607	0.8926	-0.1658	-0.1605
personelcosts_2020	0.8482	1	0.9918	0.6386	0.6728	0.6924	0.6385	0.0643	0.0666
personelcosts_var	0.884	0.9918	1	0.6952	0.7373	0.7582	0.6977	-0.0146	-0.0294
stopovers_2020	0.8708	0.6356	0.6952	1	0.8551	0.8837	0.9946	-0.3055	-0.3892
embarked_2020	0.882	0.6728	0.7373	0.8551	1	0.9851	0.8926	-0.3535	-0.4228
disembarked_2020	0.8607	0.6924	0.7582	0.8837	0.9851	1	0.9062	-0.3598	-0.4309
intransit_2020	0.8972	0.6385	0.6977	0.9946	0.8926	0.9062	1	-0.3372	-0.4038
covid19casesportugal_2020	-0.1658	0.0643	-0.0146	-0.3055	-0.3535	-0.3598	-0.3372	1	0.5069
covid19casesmadeira_2020	-0.1605	0.0666	-0.0294	-0.3892	-0.4228	-0.4309	-0.4025	0.5069	1

Figure 3. Correlation Matrix—Monthly Data.

	newguests_2020	newguests_var	guests_2020	guests_var	sleepovers_2020	sleepovers_var	totalincome_2020	totalincome_var	totalroomincome_2020
newguests_2020	<0.0001	<0.0001	<0.0001	<0.0001	<0.0001	<0.0001	<0.0001	<0.0001	<0.0001
newguests_var	<0.0001	<0.0001	<0.0001	<0.0001	<0.0001	<0.0001	<0.0001	<0.0001	<0.0001
guests_2020	<0.0001	<0.0001	<0.0001	<0.0001	<0.0001	<0.0001	<0.0001	<0.0001	<0.0001
guests_var	<0.0001	<0.0001	<0.0001	<0.0001	<0.0001	<0.0001	<0.0001	<0.0001	<0.0001
sleepovers_2020	<0.0001	<0.0001	<0.0001	<0.0001	<0.0001	<0.0001	<0.0001	<0.0001	<0.0001
sleepovers_var	<0.0001	<0.0001	<0.0001	<0.0001	<0.0001	<0.0001	<0.0001	<0.0001	<0.0001
total income_2020	<0.0001	<0.0001	<0.0001	<0.0001	<0.0001	<0.0001	<0.0001	<0.0001	<0.0001
total income_var	<0.0001	<0.0001	<0.0001	<0.0001	<0.0001	<0.0001	<0.0001	<0.0001	<0.0001
totalroomincome_2020	<0.0001	<0.0001	<0.0001	<0.0001	<0.0001	<0.0001	<0.0001	<0.0001	<0.0001
totalroomincome_var	<0.0001	<0.0001	<0.0001	<0.0001	<0.0001	<0.0001	<0.0001	<0.0001	<0.0001
personelcosts_2020	0.0003	0.0004	0.0001	0.0003	<0.0001	0.0004	<0.0001	0.0005	<0.0001
personelcosts_var	<0.0001	<0.0001	<0.0001	<0.0001	<0.0001	0.0001	<0.0001	0.0001	<0.0001
stopovers_2020	0.0169	0.0006	0.0061	0.0004	0.0018	0.0002	0.0022	0.0002	<0.0001
embarked_2020	0.0072	0.001	0.003	0.0004	0.0009	0.0002	0.0013	0.0001	0.0021
disembarked_2020	0.0116	0.0018	0.0041	0.0008	0.0013	0.0004	0.0016	0.0003	0.0016
intransit_2020	0.0118	0.0003	0.0043	0.0002	0.0011	<0.0001	0.0015	<0.0001	0.0014
covid19casesportugal_2020	0.5317	0.5758	0.5251	0.5772	0.501	0.5803	0.5194	0.5933	0.5082
covid19casesmadeira_2020	0.64	0.6351	0.5592	0.5843	0.5246	0.5972	0.6222	0.6024	0.6127
	totalroomincome_var	personelcosts_2020	personelcosts_var	stopovers_2020	embarked_2020	disembarked_2020	intransit_2020	covid19casesportugal_2020	covid19casesmadeira_2020
newguests_2020	<0.0001	0.0003	<0.0001	0.0169	0.0072	0.0116	0.0118	0.5317	0.64
newguests_var	<0.0001	0.0004	0.0001	0.0006	0.001	0.0018	0.0003	0.5758	0.6351
guests_2020	<0.0001	0.0001	<0.0001	0.0061	0.003	0.0041	0.0043	0.5251	0.5592
guests_var	<0.0001	0.0003	<0.0001	0.0004	0.0004	0.0008	0.0002	0.5772	0.5843
sleepovers_2020	<0.0001	0.0001	<0.0001	0.0018	0.0009	0.0013	0.0011	0.501	0.5246
sleepovers_var	<0.0001	0.0004	0.0001	0.0002	0.0002	0.0004	<0.0001	0.5803	0.5972
total income_2020	<0.0001	<0.0001	<0.0001	0.0022	0.0013	0.0016	0.0015	0.5194	0.6222
total income_var	<0.0001	0.0005	0.0001	0.0003	0.0001	0.0003	<0.0001	0.5933	0.6024
totalroomincome_2020	<0.0001	<0.0001	<0.0001	0.0021	0.0013	0.0016	0.0014	0.5082	0.6127
totalroomincome_var	<0.0001	0.0005	0.0001	0.0002	0.0001	0.0003	<0.0001	0.6065	0.6182
personelcosts_2020	0.0005	<0.0001	<0.0001	0.0254	0.0165	0.0126	0.0255	0.7945	0.8371
personelcosts_var	0.0001	<0.0001	<0.0001	0.0121	0.0062	0.0043	0.0116	0.9641	0.9277
stopovers_2020	0.0002	0.0254	0.0121	<0.0001	0.0004	0.0001	<0.0001	0.3342	0.2111
embarked_2020	0.0001	0.0165	0.0062	0.0004	<0.0001	<0.0001	<0.0001	0.2597	0.1709
disembarked_2020	0.0003	0.0126	0.0043	0.0001	<0.0001	<0.0001	<0.0001	0.2506	0.162
intransit_2020	<0.0001	0.0255	0.0116	<0.0001	<0.0001	<0.0001	<0.0001	0.2838	0.1946
covid19casesportugal_2020	0.5065	0.7945	0.9641	0.3342	0.2597	0.2506	0.2838	<0.0001	0.0926
covid19casesmadeira_2020	0.6182	0.8371	0.9277	0.2111	0.1709	0.162	0.1946	0.0926	<0.0001

Figure 4. Significance Matrix—Monthly Data.

Furthermore, to study the indirect effect of the pandemic, a correlation significance test was conducted using worldwide COVID-19 case data. In the event of worldwide cases having a negative and significant relationship with the tourism variables, one can assume that the cases from the region itself are considered negligible since they represent approximately 0% of the global cases and deem the effect to be indirect due to the origin of these cases being outside of the autonomous region of Madeira. The reviewed literature regarding this relationship supported the idea that it should be positive and significant. However, the results show a positive correlation of worldwide COVID-19 cases with personnel costs and a negative correlation with the remaining variables, as displayed in Table 2, and their *p*-values reveal that these correlations are not statistically significant. The sample data could not perform a statistical inference to confirm the phenomenon described by [17,18], and thus was not in line with the idea of the existence of an indirect effect of the pandemic by having induced the fear of traveling.

**Table 2.** Correlation and Significance—World Cases.

Variable	Correlation	p-Value
newguests_var	−0.1555	0.6293
guests_2020	−0.1564	0.6273
sleepovers_202	−0.1933	0.5473
totalincome_2020	−0.1571	0.6258
totalroomincome_2020	−0.1618	0.6155
personalcosts_2020	0.1243	0.7003
stopovers_2020	−0.453	0.1391
embarked_2020	−0.5089	0.0911
disembarked_2020	−0.5225	0.0813
intransit_2020	−0.4745	0.1191
worldcases	1	0.0001
newguests_var	−0.1555	0.6293

Focusing on municipal data, the correlation matrix of the municipalities represented in Figure 5 shows that the variable “COVID-19 cases in Madeira” has a combination of positive and negative relationships with the remaining variables related to tourism, represented in Figure 5, some of which have statistical significance, according to the results obtained in the p-value matrix in Figure 6.

	newguests_month	cumulative_newguests	newguests_month_var	cumulative_newguests_var	guests_month	cumulative_guests	guests_month_var	cumulative_guests_var	sleepovers_month
newguests_month	1	1	-0.0088	-0.0888	0.9999	0.9999	-0.0638	-0.0638	0.9922
cumulative_newguests	1	1	-0.0888	-0.0888	0.9999	0.9999	-0.0538	-0.0638	0.9922
newguests_month_var	-0.0888	-0.0888	1	1	-0.0961	-0.0961	0.999	0.999	-0.1152
cumulative_newguests_var	-0.0888	-0.0888	1	1	-0.0961	-0.0961	0.999	0.999	-0.1152
guests_month	0.9999	0.9999	-0.0961	-0.0961	1	1	-0.071	-0.071	0.9931
cumulative_guests	0.9999	0.9999	-0.0961	-0.0961	1	1	-0.071	-0.071	0.9931
guests_month_var	-0.0638	-0.0638	0.999	0.999	-0.071	-0.071	1	1	-0.0891
cumulative_guests_var	-0.0638	-0.0638	0.999	0.999	-0.071	-0.071	1	1	-0.0891
sleepovers_month	0.9922	0.9922	-0.1149	-0.1152	0.9931	0.9931	-0.0897	-0.0897	1
cumulative_sleepovers	0.999	0.999	-0.1149	-0.1149	0.9994	0.9994	-0.0897	-0.0897	0.9955
sleepovers_month_var	0.0094	0.0094	0.9654	0.9654	0.0025	0.0025	0.9708	0.9708	-0.0091
cumulative_sleepovers_var	0.0094	0.0094	0.9654	0.9654	0.0025	0.0025	0.9708	0.9708	-0.0091
averagestay	0.4854	0.4854	-0.1887	-0.1887	0.4884	0.4884	-0.1731	-0.1731	0.5128
cumulative_averagestay	0.4854	0.4854	-0.1887	-0.1887	0.4884	0.4884	-0.1731	-0.1731	0.5128
covidcases	0.802	0.802	-0.2397	-0.2397	0.806	0.806	-0.2064	-0.2064	0.8148
populationdensity	0.8579	0.8579	-0.3597	-0.3597	0.8627	0.8527	-0.3305	-0.3305	0.8836
avgppopulation	0.9089	0.9089	-0.3102	-0.3102	0.9127	0.9127	-0.2811	-0.2811	0.936
longevity	-0.3302	-0.3302	0.7144	0.7144	-0.335	-0.335	0.7035	0.7035	-0.3294
	cumulative_sleepovers	sleepovers_month_var	cumulative_sleepovers_var	averagestay	cumulative_averagestay	covidcases	populationdensity	avgppopulation	longevity
newguests_month	0.999	0.0094	0.0094	0.4854	0.4854	0.802	0.8579	0.9089	-0.3302
cumulative_newguests	0.999	0.0094	0.0094	0.4854	0.4854	0.802	0.8579	0.9089	-0.3302
newguests_month_var	-0.1149	0.9654	-0.9654	-0.1887	-0.1887	-0.2397	-0.3597	-0.3102	0.7144
cumulative_newguests_var	-0.1149	0.9654	-0.9654	-0.1887	-0.1887	-0.2397	-0.3597	-0.3102	0.7144
guests_month	0.9994	0.0025	0.0025	0.4884	0.4884	0.806	0.8627	0.9127	-0.335
cumulative_guests	0.9994	0.0025	0.0025	0.4884	0.4884	0.806	0.8627	0.9127	-0.335
guests_month_var	-0.0897	0.9708	0.9708	-0.1731	-0.1731	-0.2064	-0.3305	-0.2811	0.7035
cumulative_guests_var	-0.0897	0.9708	0.9708	-0.1731	-0.1731	-0.2064	-0.3305	-0.2811	0.7035
sleepovers_month	0.9955	-0.0091	-0.0091	0.5128	0.5128	0.8148	0.8836	0.936	-0.3294
cumulative_sleepovers	1	-0.0138	-0.0138	0.5036	0.5036	0.817	0.876	0.9234	-0.3458
sleepovers_month_var	-0.0138	1	1	-0.0768	-0.0768	-0.1029	-0.2395	-0.1919	0.6482
cumulative_sleepovers_var	-0.0138	1	1	-0.0768	-0.0768	-0.1029	-0.2395	-0.1919	0.6482
averagestay	0.5036	-0.0768	-0.0768	1	1	0.6937	0.7001	0.6563	-0.4867
cumulative_averagestay	0.5036	-0.0768	-0.0768	1	1	0.6937	0.7001	0.6563	-0.4867
covidcases	0.817	-0.1029	-0.1029	0.6937	0.6937	1	0.9541	0.9095	-0.5281
populationdensity	0.876	-0.2395	-0.2395	0.7001	0.7001	0.9541	1	0.985	-0.615
avgppopulation	0.9234	-0.1919	-0.1919	0.6563	0.6563	0.9005	0.985	1	-0.5675
longevity	-0.3458	0.6482	0.6482	-0.4867	-0.4867	-0.5281	-0.615	-0.5675	1

**Figure 5.** Correlation Matrix—Municipality.

	newguests_month	cumulative_newguests	newguests_month_var	cumulative_newguests_var	guests_month	cumulative_guests	guests_month_var	cumulative_guests_var	sleepovers_month
newguests_month	<0.0001	<0.0001	0.7951	0.7951	<0.0001	<0.0001	0.8523	0.8523	<0.0001
cumulative_newguests	<0.0001	<0.0001	0.7951	0.7951	<0.0001	<0.0001	0.8523	0.8523	<0.0001
newguests_month_var	0.7951	0.7951	<0.0001	<0.0001	0.7786	0.7786	<0.0001	<0.0001	0.7359
cumulative_newguests_var	0.7951	0.7951	<0.0001	<0.0001	0.7786	0.7786	<0.0001	<0.0001	0.7359
guests_month	<0.0001	<0.0001	0.7786	0.7786	<0.0001	<0.0001	0.8356	0.8356	<0.0001
cumulative_guests	<0.0001	<0.0001	0.7786	0.7786	<0.0001	<0.0001	0.8356	0.8356	<0.0001
guests_month_var	0.8523	0.8523	<0.0001	<0.0001	0.8356	0.8356	<0.0001	<0.0001	0.7944
cumulative_guests_var	0.8523	0.8523	<0.0001	<0.0001	0.8356	0.8356	<0.0001	<0.0001	0.7944
sleepovers_month	<0.0001	<0.0001	0.7359	0.7359	<0.0001	<0.0001	0.7944	0.7944	<0.0001
cumulative_sleepovers	<0.0001	<0.0001	0.7365	0.7365	<0.0001	<0.0001	0.7931	0.7931	<0.0001
sleepovers_month_var	0.9782	0.9782	<0.0001	<0.0001	0.9942	0.9942	<0.0001	<0.0001	0.9789
cumulative_sleepovers_var	0.9782	0.9782	<0.0001	<0.0001	0.9942	0.9942	<0.0001	<0.0001	0.9789
averagestay	0.1302	0.1302	0.5784	0.5784	0.1275	0.1275	0.6108	0.6108	0.1067
cumulative_averagestay	0.1302	0.1302	0.5784	0.5784	0.1275	0.1275	0.6108	0.6108	0.1067
covidcases	0.003	0.003	0.4778	0.4778	0.0027	0.0027	0.5426	0.5426	0.0023
populationdensity	0.0007	0.0007	0.2772	0.2772	0.0006	0.0006	0.3209	0.3209	0.0003
avgppopulation	0.0001	0.0001	0.3532	0.3532	<0.0001	<0.0001	0.4023	0.4023	<0.0001
longevity	0.3213	0.3213	0.0135	0.0135	0.3139	0.3139	0.0157	0.0157	0.3226

**Figure 6.** Significance Matrix—Municipality.

The results obtained allow us to draw important conclusions regarding what was proposed in the research questions. They showed that the correlation between the same variables was significant when compared among municipalities. However, that did not happen when analyzed by month. This is observable in Figure 7, which compares the two subsets of data from 2019 to 2020 (before and during the pandemic, respectively) as a portrait of the pandemic's impact on the arrival of new guests in the region (see Figure 7).

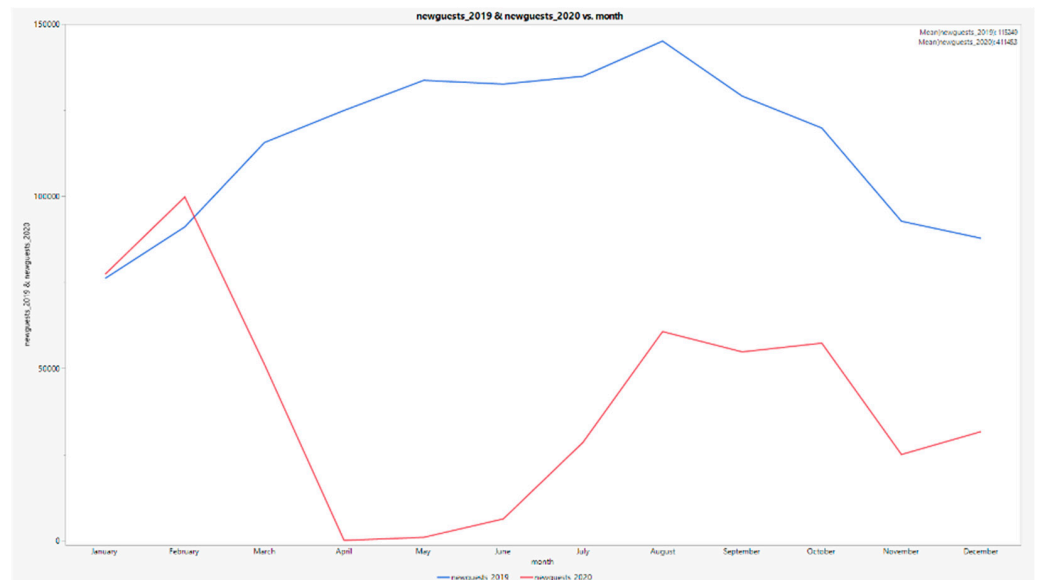

**Figure 7.** Evolution of new guests in lodging services in ARM in 2019 and 2020.

Furthermore, the data preparation phase provided a priori insight regarding population density. Some municipalities, such as Câmara de Lobos, one with a high population density, were highly impacted by the pandemic compared with most other municipalities. The results show that the variables “population density” and “average population” have shown a significant correlation with the variable “COVID cases”, as seen and highlighted in Figure 8, leaning towards the existence of a statistically significant linear relationship between each of the two variables and the variation in COVID cases.

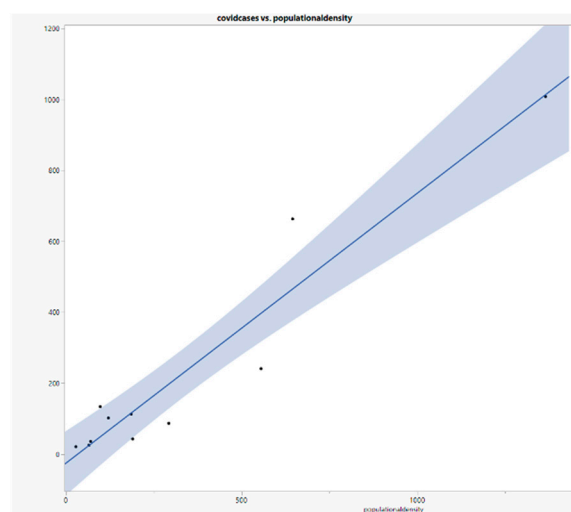

**Figure 8.** COVID-19 infection as a function of population density.

To complement the analysis of this relation, a clustering analysis was made using the relevant variables for this segment, which were “longevity”, “cumulative new guests cumulative”, “average stay”, “COVID cases”, “population density” and “average population”.

Using the cubic clustering criteria, the optimal number of clusters was found to be 3. Then, the clustering method used was k-means, with the following results obtained in Table 3.

**Table 3.** K-means clustering results.

Cluster	Longevity	Cumulative_Newguests	Averagestay	Covidcases	Populationaldensity	Avg Population
1	51.2375	18,397.25	3.5752829	70	131.35	8913.375
2	41.65	30,880.5	5.1020125	428	600.55	39,358
3	42.4	28,4804	5.2462178	1008	1365.9	104,076.5

As we can observe, the results show that, groups of municipalities where the average stay was longer are associated with a higher incidence of COVID cases, and the same also goes for municipalities where the population density or average population was higher.

The municipalities and the three clusters they are inserted in are visually described in Figure 9 as a function of the number of COVID-19 infections and population density.

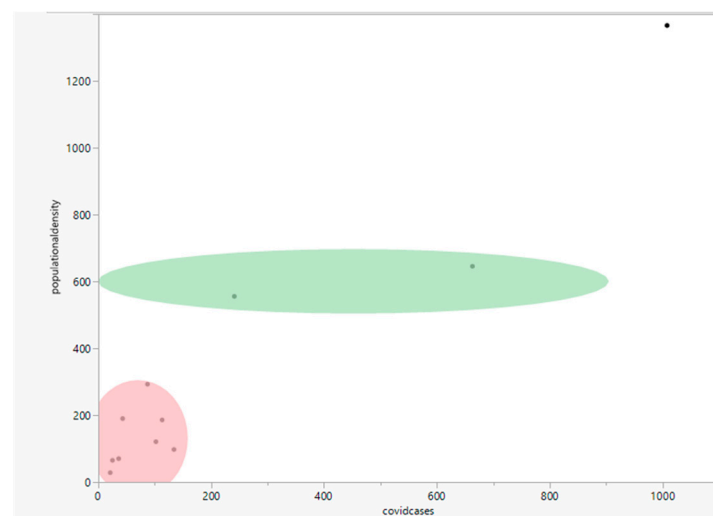

**Figure 9.** Cluster analysis representation, scrutinized by infection count and density.

**Cluster 1 (Red):** Calheta, Machico, Ponta do Sol, Porto Moniz, Ribeira Brava, Santana, São Vicente, and Porto Santo; the average number of COVID cases in this cluster was a low 70.13, associated with an average population density of 131.35 and an average population of 8913.

**Cluster 2 (Green):** Santa Cruz and Câmara de Lobos; as seen before, these are two of the most impacted regions, both of which have comparably high population densities. The cluster analysis shows that the average number of COVID cases in this cluster was 452, associated with an average population density of 600.55 and an average population of 8913.

**Cluster 3 (Blue):** Funchal; leading this cluster by itself, Funchal records a whopping 1008 cases, with a population density of 1366 and a population of 104,077.

The clustering results are a set of three clusters that are representative of three distinct tiers of population and population density levels. Cluster 1 is classified as having had a good performance in the context of the pandemic and represents the group of municipalities with a low population density mean and which have had fewer registered cases of infection by the virus. Cluster 2 is classified as having had an average performance in the context of the pandemic and represents the group of municipalities with an average population density that have registered an average number of infections. Lastly, Cluster 3 is classified as having had a bad performance in the context of the pandemic and represents the dense municipalities, which have registered the highest average number of infections. The results support the idea that we can predict how well an arbitrary municipality would do in a pandemic depending on its population density and that this variable is linearly related to COVID-19 cases.

The results obtained in this study concerning the impact of population density on the pandemic show a positive relationship between population density and the propagation of the coronavirus. This conclusion is aligned with previous studies [6–8,19–25,32]. These results show that municipalities with less dense clusters tend to perform well in controlling the propagation of the virus and its incidence. This finding corroborates what was found by [7] but contradicts what was obtained by [9]. This latter study found that low density cities had a higher impact on virus infections. However, it seems probable that this relationship is not as true to reality as the cities in the study—Singapore, Seoul, and Shanghai—classified as highly dense cities, have performed well in combating the coronavirus.

## 5. Conclusions

### 5.1. Research Contributions

In conclusion, the obtained results allowed us to reach conclusive findings and answer the four research questions. Most importantly, they provided insight into the impact of the COVID-19 Pandemic in the autonomous region of Madeira, the topic of this work.

Concerning the first research question, there is enough evidence to state that the COVID-19 Pandemic negatively impacted the tourism sector in the autonomous region of Madeira, corroborating the studies made by [13–16].

Regarding the second research question, the results were not conclusive enough to accept it. Interestingly, however, the highly ranked tourism destinations of Madeira and Porto Santo Islands still managed to have enough tourism activity to evade that indirect effect, which was significantly reflected in the results. However, due to the lack of statistical significance of the correlation of the variables that study the indirect impact on the region, such as “COVID-19 cases in Portugal”, as well as “COVID-19 cases worldwide” and variables of the indicators of the tourism sector, there is not enough evidence to indicate that the unwinding of the pandemic throughout the world caused enough traveling fear and tourism constraints that could lead to an indirect negative impact on tourism in the region. These results go against previous studies [9,17].

Regarding the third research question, results showed that population levels and population density did indeed contribute positively to the transmission of the virus, with statistical significance associated with the corresponding correlations. This finding was also confirmed by the results obtained in the clustering analysis. The clustering analysis showed that high population-density municipalities had higher infection numbers. In conclusion, there is sufficient and conclusive evidence to conclude that there is a statistically significant linear relationship between population levels and density and COVID-19 cases. These allowed us to conclude that the population density of the municipalities significantly influences the spreading of the virus in the region.

Consequently, this fact reinforces the idea that higher population density and population levels, in general, helped spread the COVID-19 coronavirus. In comparison, lower population density and population levels tended to contain it. Conversely, the results do not corroborate the conclusions of other analyses that presumed that the density of the population was not at issue and could not be a determining factor in the proliferation of COVID-19 in general terms [9]. These results are also not in line with the results obtained in the early stages by [26], where this relationship was concluded not to be significant.

Lastly, the clustering analysis confirmed that there are patterns between the municipalities. The clustering analysis showed that it is possible to find groups of data that behave similarly among the municipalities, therefore answering the research question and setting the stage for future health crises in the autonomous region of Madeira, where the focus on preventive and restrictive measures should be on the clusters of municipalities where population density and registered COVID-19 cases are more prominent. Our research and analysis shall serve as documentation for future crises in the health sector by identifying and grouping municipalities with high risk associated with pandemics due to their population densities and for whom the regional government should target supplementary



measures to mitigate or possibly offset the effect of population density on the proliferation of a new virus.

### 5.2. Managerial Implications

The results obtained in this study have revealed patterns in the response of the autonomous region of Madeira to the COVID-19 pandemic that must be considered when facing future health crises, one of which is based on the municipalities' population density. Denser regions have been shown to have performed worse than less dense regions, and the highly contagious nature of the virus, especially in close proximity, means that in populationally denser regions, the proliferation of the virus was faster and in greater mass. This reality means that it is crucial that population density be identified as an indicator of risk in future health crises such as the one caused by the COVID-19 pandemic and that denser municipalities be targeted with heavier restrictions and sanitary measures since they have been shown to be more prone to perform worse in a pandemic situation. The study's findings thus reinforce the idea that the government's strategy and planning against pandemics should be guided by the differences in population parameters among the municipalities of the autonomous region of Madeira. Undoubtedly, the major consequences of the pandemic were the loss of lives, which is the main aspect the government should attempt to mitigate with these measures. However, it is also clear that the tourism sector benefits greatly from the government's effort to contain the virus in such a pandemic situation, and, in general terms, in the context of such a health crisis, the safer the region is considered to be, the more inviting to the tourism inflow it becomes, and these measures contribute to keeping regular rates of arrivals and tourist expenses, a major source of the domestic product, especially in Madeira.

### 5.3. Limitations and Recommendations for Future Research

While working on a topic related to tourism might induce one to pick a geographical area that is associated with large flows of tourism activity. Nonetheless, even though the autonomous region of Madeira is a highly regarded tourism destination internationally, the choice of this region for this study meant it became harder to obtain data from the sector and the local health authorities regarding the pandemic. As a comparison, on a larger geographical scale, equivalent data are public and available for access. Despite this not having been a major limiting factor in the making of this dissertation, it is advised that a pilot study and research on the availability of data be performed in order to acknowledge the resources and consider the possibility of expanding the scale of the project to a larger geographical area, possibly improving the process of collecting the resources needed for the goals aimed to be obtained with the project. Furthermore, the study was based on an a posteriori approach, evaluating the damages caused by the pandemic in the region and how the sector's indicators related to the propagation of the virus. So, the value of training a prediction model to estimate the development of the pandemic became redundant, although this is an interesting and useful approach suggested for future health crises. Additionally, this study only focused on the data until 2020. Therefore, future studies could go beyond this period and study the full 2021 year. Lastly, despite the results showing a correlation between the population density, the number of cases, and the number of tourists, the studied data does not allow for clarification as to whether the high number of tourists caused the high number of cases in high population-dense clusters, the higher population density caused the cases, or a combination of both. Therefore, future studies could explore other data sources to try to capture the cause behind the higher number of cases.

**Author Contributions:** Conceptualization, J.N. and P.R.; methodology, J.N., P.R. and N.A.; software, J.N.; validation, P.R. and N.A.; investigation, J.N. and P.R.; resources, J.N.; data curation, J.N.; writing—original draft preparation, J.N.; writing—review and editing, J.N. and P.R.; visualization, J.N. All authors have read and agreed to the published version of the manuscript.

**Funding:** This work was supported by national funds through FCT (Fundação para a Ciência e a Tecnologia), under the project—UIDB/04152/2020—Centro de Investigação em Gestão de Informação (MagIC)/NOVA IMS.

**Institutional Review Board Statement:** Not applicable.

**Informed Consent Statement:** Not applicable.

**Data Availability Statement:** Not applicable.

**Conflicts of Interest:** The authors declare no conflict of interest.

## References

1. António, N.; Rita, P.; Saraiva, P. COVID-19: Worldwide Profiles during the First 250 Days. *Appl. Sci.* **2021**, *11*, 3400. [CrossRef]
2. Baker, S.R.; Bloom, N.; Davis, S.J.; Terry, S.J. *COVID-Induced Economic Uncertainty*; National Bureau of Economic Research: Cambridge, MA, USA, 2020.
3. Novelli, M.; Gussing Burgess, L.; Jones, A.; Ritchie, B.W. 'No Ebola... still Doomed'—The Ebola-Induced Tourism Crisis. *Ann. Tour. Res.* **2018**, *70*, 76–87. [CrossRef] [PubMed]
4. Antonio, N.; Rita, P. COVID-19: The Catalyst for Digital Transformation in the Hospitality Industry? *Tour. Manag. Stud.* **2021**, *17*, 41–46. [CrossRef]
5. Piccinelli, S.; Moro, S.; Rita, P. Air-Travelers' Concerns Emerging from Online Comments during the COVID-19 Outbreak. *Tour. Manag.* **2021**, *85*, 104313. [CrossRef]
6. Bouba-Olga, O. La Densité Favorise-t-elle L'épidémie ? (Épisode 26) | Olivier Bouba-Olga 2020. Available online: <https://blogs.univ-poitiers.fr/o-bouba-olga/2020/04/29/la-densite-favorise-t-elle-lepidemie-episode-26/web> (accessed on 8 June 2023).
7. Kadi, N.; Khelfaoui, M. Population Density, a Factor in the Spread of COVID-19 in Algeria: Statistic Study. *Bull. Natl. Res. Cent.* **2020**, *44*, 138. [CrossRef]
8. Garland, P.; Babbitt, D.; Bondarenko, M.; Sorichetta, A.; Tatem, A.J.; Johnson, O. The COVID-19 Pandemic as Experienced by the Individual. *arXiv* **2020**, arXiv:2005.01167.
9. Fang, W.; Wahba, S. Urban Density Is Not an Enemy in the Coronavirus Fight: Evidence from China. Available online: <https://blogs.worldbank.org/sustainablecities/urban-density-not-enemy-coronavirus-fight-evidence-china> (accessed on 8 June 2023).
10. Conrath, D.W.; Higgins, C.A.; McClean, R.J. A Comparison of the Reliability of Questionnaire versus Diary Data. *Soc. Netw.* **1983**, *5*, 315–322. [CrossRef]
11. Instituto Nacional de Estatística. *Estatísticas do Turismo 2022*; Instituto Nacional de Estatística: Lisbon, Portugal, 2023.
12. Direção Regional de Estatística da Madeira. *Anuário Estatístico da Região Autónoma da Madeira 2021*; Direção Regional de Estatística da Madeira: Madeira, Portugal, 2022.
13. Foo, L.-P.; Chin, M.-Y.; Tan, K.-L.; Phuah, K.-T. The Impact of COVID-19 on Tourism Industry in Malaysia. *Curr. Issues Tour.* **2021**, *24*, 2735–2739. [CrossRef]
14. Gössling, S.; Scott, D.; Hall, C.M. Pandemics, Tourism and Global Change: A Rapid Assessment of COVID-19. *J. Sustain. Tour.* **2020**, *29*, 1–20. [CrossRef]
15. Rutynskyi, M.; Kushniruk, H. The Impact of Quarantine Due to COVID-19 Pandemic on the Tourism Industry in Lviv (Ukraine). *Probl. Perspect. Manag.* **2020**, *18*, 194–205. [CrossRef]
16. Couto, G.; Castanho, R.A.; Pimentel, P.; Carvalho, C.; Sousa, Á.; Santos, C. The Impacts of COVID-19 Crisis over the Tourism Expectations of the Azores Archipelago Residents. *Sustainability* **2020**, *12*, 7612. [CrossRef]
17. Maphanga, P.M.; Henama, U.S. The Tourism Impact of Ebola in Africa: Lessons on Crisis Management. *Afr. J. Hosp. Tour. Leis.* **2019**, *8*, 1–13.
18. Zheng, D.; Luo, Q.; Ritchie, B.W. Afraid to Travel after COVID-19? Self-Protection, Coping and Resilience against Pandemic 'Travel Fear'. *Tour. Manag.* **2021**, *83*, 104261. [CrossRef]
19. Arif, M.; Sengupta, S. Nexus between Population Density and Novel Coronavirus (COVID-19) Pandemic in the South Indian States: A Geo-Statistical Approach. *Environ. Dev. Sustain.* **2021**, *23*, 10246–10274. [CrossRef]
20. Baser, O. Population Density Index and Its Use for Distribution of Covid-19: A Case Study Using Turkish Data. *Health Policy* **2021**, *125*, 148–154. [CrossRef]
21. Budhwani, K.I.; Budhwani, H.; Podbielski, B. Evaluating Population Density as a Parameter for Optimizing COVID-19 Testing: Statistical Analysis. *Jmirx Med* **2021**, *2*, e22195. [CrossRef] [PubMed]
22. Hu, H.; Nigmatulina, K.; Eckhoff, P. The Scaling of Contact Rates with Population Density for the Infectious Disease Models. *Math. Biosci.* **2013**, *244*, 125–134. [CrossRef] [PubMed]
23. Lienhardt, C. From Exposure to Disease: The Role of Environmental Factors in Susceptibility to and Development of Tuberculosis. *Epidemiol. Rev.* **2001**, *23*, 288–301. [CrossRef] [PubMed]
24. Miller, J.C. Spread of Infectious Disease through Clustered Populations. *J. R. Soc. Interface* **2009**, *6*, 1121–1134. [CrossRef] [PubMed]
25. Sy, K.T.L.; White, L.F.; Nichols, B.E. Population Density and Basic Reproductive Number of COVID-19 across United States Counties. *PLoS ONE* **2021**, *16*, e0249271. [CrossRef]

26. Wu, X.; Tian, H.; Zhou, S.; Chen, L.; Xu, B. Impact of Global Change on Transmission of Human Infectious Diseases. *Sci. China Earth Sci.* **2014**, *57*, 189–203. [CrossRef] [PubMed]
27. Wong, D.W.S.; Li, Y. Spreading of COVID-19: Density Matters. *PLoS ONE* **2020**, *15*, e0242398. [CrossRef]
28. Corriere della Sera Coronavirus, Primi Due Casi in Italia: Sono Due Turisti Cinesi. Available online: [https://www.corriere.it/cronache/20\\_gennaio\\_30/coronavirus-italia-corona-9d6dc436-4343-11ea-bdc8-faf1f56f19b7.shtml](https://www.corriere.it/cronache/20_gennaio_30/coronavirus-italia-corona-9d6dc436-4343-11ea-bdc8-faf1f56f19b7.shtml) (accessed on 21 July 2020).
29. Zhang, H.; Song, H.; Wen, L.; Liu, C. Forecasting Tourism Recovery amid COVID-19. *Ann. Tour. Res.* **2021**, *87*, 103149. [CrossRef] [PubMed]
30. Stezhko, N.; Oliinyk, Y.; Polishchuk, L.; Tyshchuk, I.; Parfinenko, A.; Markhonos, S. International Tourism in the System of Modern Globalization Processes. *Int. J. Manag.* **2020**, *11*, 97–106.
31. Bhadra, A.; Mukherjee, A.; Sarkar, K. Impact of Population Density on COVID-19 Infected and Mortality Rate in India. *Model. Earth Syst. Environ.* **2021**, *7*, 623–629. [CrossRef]
32. Coşkun, H.; Yıldırım, N.; Gündüz, S. The Spread of COVID-19 Virus through Population Density and Wind in Turkey Cities. *Sci. Total Environ.* **2021**, *751*, 141663. [CrossRef] [PubMed]
33. Antonio, N.; Rita, P.; Saraiva, P. Effectiveness of COVID-19 Vaccines: Evidence from the First-Year Rollout of Vaccination Programs. *Vaccines* **2022**, *10*, 409. [CrossRef] [PubMed]

**Disclaimer/Publisher’s Note:** The statements, opinions and data contained in all publications are solely those of the individual author(s) and contributor(s) and not of MDPI and/or the editor(s). MDPI and/or the editor(s) disclaim responsibility for any injury to people or property resulting from any ideas, methods, instructions or products referred to in the content.

Article

# Museums without Visitors? Crisis of the Polish Museums during the COVID-19 Pandemic and Their Revival under the Digital Experience Offer

Lukasz Gawel

Institute of Culture, Faculty of Management and Social Communication, Jagiellonian University,  
31-007 Krakow, Poland; lukasz.gawel@uj.edu.pl

**Abstract:** Museums, as many other organisations, froze during the lockdown. Museums offer insights into varying cultures and since no forms of culture can sustain without the engagement of audiences, participants, or visitors, the lockdown forced by the pandemic compelled museum authorities to look for new ways to reach audiences and establish relationships with them, thereby facilitating previously untapped forms of cultural participation. This worldwide experience of the pandemic undoubtedly accelerated the digital transformation of the entire cultural sector. To what extent these new opportunities have changed the forms of participation in the cultural realm remains an open question. This current research carried out in some of the largest Polish museums allowed us to conclude that the pandemic period saw a significant leap forward in terms of the involvement of digital technologies in popularising museum collections, as well as in seeking contact with audiences at various levels. At the same time, the reopening of museums resulted in increased attendances on an unprecedented scale. It could be said that the pandemic made us realise how global threats can, in a short span of time, take away the possibility of enjoying traditional forms of cultural participation, but at the same time enable the development of digital technologies that can significantly contribute to the popularisation of museum collections or exhibitions. This research was designed to find out whether museum audiences wanted a change in the way they experience the collections and exhibitions held in museums, and whether the digital experience created during the pandemic was attractive enough to compete with a personal visit to an art gallery. The results of the research clearly indicated that despite the rich digital experience offered in Polish museums, viewers still stated a desire to return to a “real museum”. The pandemic allowed the museum authorities to learn novel administration techniques and numerous technological solutions that were previously never used have now become a permanent feature of regular museum operations. However, the reaction of the audiences after the lockdown was clear: they still wanted to enjoy traditional forms of cultural participation, valuing above all the possibility of personal contact with an original work of art in a museum gallery.

**Keywords:** museums in a pandemic; new technologies in museums; traditional cultural participation



**Citation:** Gawel, L. Museums without Visitors? Crisis of the Polish Museums during the COVID-19 Pandemic and Their Revival under the Digital Experience Offer. *Sustainability* **2023**, *15*, 11844. <https://doi.org/10.3390/su151511844>

Academic Editors: Zygmunt Kruczek and Bartłomiej Walas

Received: 29 May 2023

Revised: 1 July 2023

Accepted: 2 July 2023

Published: 1 August 2023



**Copyright:** © 2023 by the author. Licensee MDPI, Basel, Switzerland. This article is an open access article distributed under the terms and conditions of the Creative Commons Attribution (CC BY) license (<https://creativecommons.org/licenses/by/4.0/>).

## 1. Introduction

When the first case of coronavirus was diagnosed in December 2019, no one could have suspected the impact that the rapidly developing epidemic would have on our lives. In an effort to halt the spread of the SARS-CoV-2 coronavirus, countries around the world introduced a series of restrictions on economic and social activities. This process was no different in Poland, where severe restrictions were increasingly imposed, which also affected the cultural sector, including museums, which were closed to visitors on 12 March 2020. Museums were allowed to start operating under a strict sanitary regime on 4 May 2020, but another wave of outbreaks brought their renewed closure on 7 November 2020. They were reopened to the public on 1 February 2021, whilst maintaining a strict sanitary regime.

The museums experienced several unusual difficult situations that affected their operations during this period, including several months of complete closure and a long period of operation under strict new hygiene protocols that had never previously been applied. In a relatively short period of time, therefore, they had to cope with a wide variety of problems in virtually every area of their organisation. In a report from a research project on Polish cultural institutions during the time of COVID-19, Magdalena Pasternak-Zabielska concluded that although 75% of museums in Poland were ill-prepared to operate during the pandemic in terms of organisation and technical infrastructure, there was a fourfold increase in the number of museums offering online activities (with 40% conducting online classes in real time). While various types of museum educational activities experienced a significant decline throughout the period while the restrictions were in place, the increase in the number of online classes offered by museums during the pandemic was more than 380% [1] (pp. 6, 12). It is important to remember, however, that educational activities during the pandemic was only one area that underwent a profound transformation. Along with that, the promotion and marketing departments (known by different names in different museums) of the museums also changed significantly. There was a massive expansion in communication through digital channels, with museums not only expanding their presence on previously used social media, but also reaching out to new platforms. The best example of this change was the opening up to TikTok. This is an interesting example in that it demonstrated how difficult it was to transform institutions that were embedded in traditional forms of functioning and were reluctant to undergo changes in terms of managing their marketing strategies. Proof of this could be seen in the fact that among the largest (also the most highly subsidised and with the richest human resources) national (state) museums and those co-managed by the Ministry of Culture and National Heritage (of which there were 50 in total as of January 2023), only a few decided to open up to this communication channel.

Finally, taking a general look at the museums during the pandemic, as every other institution, they also had to undergo organisational change, adapting to previously non-existent operating conditions, and introducing strict hygiene measures for their staff that ensured their safety not only in epidemiological terms but also in terms of personal experiences, which was particularly difficult at a time of uncertainty and widespread fear for the future [2,3]. All these processes were to take place in parallel; no area of the organisation could be considered dominant and yet one context remained the most important: the visitors. It was the visitors who provided meaning to the daily work of the museums and it was they who always had to be prioritised despite the multiplying problems and unknown threats. That is because audiences form the crux of a museum's existence, in a way legitimising them socially. Museums that are needed socially become an organisation of public trust, and by building social bridges and creating relations with their own social environment, they become a protection-free space for dialogue, the exchange of ideas, spontaneous discussions of values, and emotions (the most intimate impressions related to experiencing the world) [4–10].

Investigating the digital world of museums from a sustainability perspective is not only justified but also necessary. There are three areas in the theory of sustainability: the environment, the economic dimension, and the social dimension. During a time of climate crisis, the environmental dimension dominates, which is understandable. However, the question arises about the social dimension of sustainability, e.g., building cultural competences, tackling identity issues, and addressing the development of higher needs. All these issues are particularly relevant in the context of cultural heritage management, including museums.

## 2. The Literature Review

Despite changing social, economic, and financial conditions, the paradigm of the museum remains unchanged; the foundation of these institutions are their collections, the management and preservation of which have been extensively covered in the literature [11–13]. In

recent decades, an increasingly strong emphasis have been laid on the importance of viewer–consumer–user–co-creator, significantly changing the framework for the reception of artefacts collected in museums [14–16]. In recent years, practically no study on museum management has overlooked the use of new media in the context of communication strategies or building relationships with audiences [17–21]. The change in this respect has not only been brought about by the development of digital technologies, but has also been enforced by a generational change: museums have to discover media that provide attractive promotion of their collections among younger users [22] (p. 58). In addition, the nature of the new digital media is perfectly suited to modern societies showing much greater mobility than previous generations [23] (p. 3).

The presence of social media in museums, however, has a much deeper meaning than simply its use for communication processes or educational activities. It is about building a social network, a relationship between an organisation and its audiences [24], as well as interactions between audiences [25] (p. 141). This leads to a strengthening of ties in the organisation’s environment, resulting in a stronger identification with the organisation, and thus increasing the importance of the museum itself within a social environment. This leads museums towards new avenues of engagement with their audiences, facilitating the exchange of ideas and thoughts, and opening up the possibility of creating an organisation that learns from its audiences, uses their ideas, and, as a further consequence, actually implements the idea of active participation [26–29], involving audiences in the creation of new exhibitions and events [30] (p. 115).

This growing bond with museumgoers, the museum’s audiences, is crucial to an organisation’s values and leads to it becoming more humanised, with the development of human bonds on one hand, and the support for self-development on the other, including the encouragement to seek one’s own paths in order to satisfy one’s needs and aspirations, or to build one’s cultural identity.

During the pandemic, not only were museums cut off from their audiences, but people were also isolated from each other. This resulted in the breaking of the most natural ties that make us a community, and which give us a sense of family, work or a culture. It limited the traditional ways of communicating—talking at social gatherings, family gatherings or in the workplace. Meanwhile, “People like to share their experiences with others, especially positive experiences that make them feel better. Museums should do everything they can to make it easier for their audiences to share their positive experiences of visiting a museum with others. When friends and family share their positive experiences with someone, this can prove to be a motivation for the person gifted with this positive relationship to visit the museum themselves, often in the near future” [31] (p. 194).

It was precisely the awareness of this that led museums to devote so much energy and resources to building a “digital world” as quickly as possible to bridge the communication gap, not only through marketing, but also by creating tools for describing the museum’s reality, including a platform for disseminating knowledge and the collections themselves, and developing new opportunities for interacting with art [32]. The museums surveyed in this study undoubtedly succeeded in achieving this aim, and the commitment of the teams working there made it possible to create a universe that would have been unimaginable just a few years ago.

There are many texts in the literature on the issue of the digital world during the pandemic [33–35]. Many of them make a valuable contribution to increasing knowledge about this new type of communication, the flow of information in the digital world, and the virtual experience of participation in culture and arts. It should be emphasised, however, that the present article adopts a sceptical attitude towards the possibility of replacing a personal visit to a real museum with even the most perfect digital experience offer.

### 3. Materials and Methods

The present article is the result of research carried out between June 2022 and March 2023. The chosen timing of the study was not accidental. On one hand, enough time had

passed since the reopening of the museums and the lifting of the COVID-19 restrictions to allow the museums to crucially reflect on that period, enabling them to evaluate the measures taken at that time in a more “matter-of-fact” way. The passage of time also made it possible to verify the oft-repeated pandemic judgements that once the restrictions were lifted, museums would operate in a hybrid mode, retaining the activities in the digital world that had been developed during the physical separation of visitors from the museums. The beginning of 2023 marked the conclusion of a full year of museum operations after the lifting of the COVID restrictions.

The aim of this research was to find out how the pandemic affected the development of the digital experience offer of the museums: did the pandemic have an impact on the development of the digital infrastructure of the museums, and, therefore, on the improvement of staff competences? In addition, the reaction of the audience was seen as a key issue: Could the digital experience offered compete with the “real museum”, i.e., personal visits to the galleries? When seeking a balance between reality and the virtual world, would audiences side with the digital or real museums?

The following research questions were formulated to achieve the stated objectives:

1. How did museums build their digital experience offer? Did they look for new formats, or translate their existing offers into the digital language?
2. Were audiences keen to use the digital experience offer, and how did this translate into online attendances?
3. Did museums need to invest in digital equipment to adapt to the digital world?
4. Did the digital experience offer during the pandemic remain a part of the museum’s permanent offer?
5. Did audiences interact with museums through digital communication?
6. How was the attendance shaped after the end of the pandemic restrictions?

The following hypothesis was formulated for the research: “Despite the significant leap forward in the development of Polish museums in terms of their digital offer, with improved infrastructure and professionalisation, after the end of the pandemic audiences will reject the digital offer and choose the real museum, not the virtual one”. The author firmly believes that this conscious choice is an authentic representation of the principle of sustainable development—given the enormous role that the digital world play in our lives, we want to preserve the right to enjoy a unique experience in our dealings with art through a personal visit to a gallery.

The idea for this research was developed back in 2021, when the author had the opportunity to talk to the directors of several major museums in Poland. The result of those conversations was a number of unstructured interviews conducted from June 2022 with four facility directors and five employees working in other positions. On the basis of those interviews, a research questionnaire was developed and sent via e-mail directly to the museum directors, who then forwarded it to the individual departments concerned (museums use different internal nomenclature, but the departments contacted mostly were the marketing, communications, education, and sometimes HR departments). It was decided that only fully completed and returned survey questionnaires would be considered in the analysis. The criterion for recognising the responses from the museums as being complete was that an answer should be provided to each question, and it was not based on how extensive those answers were. Only five museums, out of the eight that received the questionnaire, sent back complete responses. Answers were provided to the following questions:

1. Please provide data on attendance before 2020 (for 2018 and 2019) and attendance in 2021 (attendance data for 2022 was compiled during telephone interviews conducted in February and March 2023).
2. What activities, or forms of activity, did the museum implement during the pandemic? How was contact built with the audiences that could not physically visit the institution (please also provide details on specific actions or events, with information on whether

- they can be used in the text with the name of the specific event/action and also the name of the museum)?
3. Did the actions taken involve investment (in equipment, improving competences, etc.)?
  4. Did you note any changes in social media outreach during the pandemic?
  5. Did you track the attendance in online events? What volumes were they? If you did, please specify how.
  6. Did viewers/audiences interact with you? Through what channels? Did you stimulate this communication? Do you have any typical examples of your audience's comments?
  7. Have any activities from the pandemic become a part of the museum's standard operations after the pandemic?
  8. Did the restrictions from the pandemic permanently affect the activities of your museum (e.g., abandoning audio guides, reducing the role of multimedia in the exhibition space, etc.)?
  9. Have you noticed a change in the structure of visitor traffic, e.g., fewer visitors from abroad in favour of domestic visitors?
  10. The tenth question did not directly relate to the topic under study as it covered the issue of accessibility of the museums for Ukrainian citizens fleeing to Poland, following Russia's armed attack on the country.

Their answers were supplemented with unstructured interviews, complementing the information that had been sent in, conducted in the period described above with six people working in different departments of the aforementioned museums (management, education, promotion, and marketing departments) and two in-depth interviews exclusively concerning the use of social media in museums.

In addition, an analysis of the content and intensity of social media use in nine national museums was conducted. The present article also makes use of publicly available reports and studies, as well as information materials primarily from the museums surveyed. The method of participant observation—involving the active use of the digital experience offer of museums during the pandemic that allied with systematic examination of its content—was also very important for the insights and conclusions contained herein. The primary objective of this approach was to achieve triangulation of the research conducted, minimising the risk of error, and achieving more reliable results.

It should be stressed that the results obtained from the interviews and questionnaires are interesting in that they not only provide quantitative data about the phenomenon (also obtained through the analysis of the content), but they also include comments from people working on the digital experience offer on a daily basis, showing their subjective feelings. They are therefore an authentic description of their relationship with their audience, allowing predictions to be carried out about the future of digital experiences in museums.

The decision to narrow down the survey to the largest Polish museums also has certain consequences. The group of organisations surveyed in this way makes it impossible to formulate conclusions that are representative of all Polish museums (which would also be very difficult to achieve since there are 939 museums in Poland, according to the Central Statistical Office). After initially identifying the topic of this study, it was decided to describe the activities of those museums that used the most diverse forms of activities during the pandemic, achieved the greatest reach through digital media, and, finally, enjoyed the greatest interest from audiences and visitors.

That was the first criterion for narrowing down the study on the analysis of social media use in the nine museums (presented in the Table 1 below). The second criterion was the separate set of questionnaire responses. Ostensibly, this article uses five case studies (in alphabetical order): National Museum in Gdansk, National Museum in Krakow, National Museum in Lublin, National Museum in Warsaw, and Wawel Royal Castle.



**Table 1.** Use of social media by the Polish national museums surveyed.

	Facebook Number of Followers/ Likes	Instagram Number of Followers/Number of Posts	YouTube Number of Subscribers/Number of Videos	TikTok Number of Followers/Total Number of Likes on Reels
National Museum in Gdansk	26,000/ 25,000	5457/ 601	499/ 125	Not used
National Museum in Kielce	8000/ 7400	2158/ 1168	407/ 192	Not used
National Museum in Krakow	103,000/ 101,000	30,300/ 1417	1890/ 249	Not used
National Museum in Lublin	23,000/ 22,000	4254/ 592	456/ 132	Not used
National Museum in Poznan	27,300/ 25,000	4336/ 200	1370/ 400	668/ 899
National Museum in Szczecin	10,000/ 10,000	2136/ 432	185/ 82	Not used
National Museum in Warsaw	110,200/ 103,800	73,400/ 1383	7620/ 857	27,300/ 402,500
Royal Castle in Warsaw	83,000/ 80,000	10,100/ 3575	5950/ 876	499/ 2593
Wawel Royal Castle	140,000/ 136,000	10,400/ 767	3180/ 192	Not used

The table reflects the status as of 30 April 2023.

#### 4. Results

Audiences who had gradually lost the opportunity to visit museum galleries and see their favourite works over time began to vent their frustration by writing e-mails to the museums or—more often—by posting relevant comments on social media. The response to these statements was a competition announced by the National Museum in Warsaw at the end of February 2021: “From tomorrow, we will only be able to cover our noses and mouths with masks—we recommend masks decorated with paintings from the NMW, of course. To win one, all you have to do is answer one simple question: Which work from our collection do you miss the most, and why? For the authors of the most original, funniest or best-reasoned answers, we have 50 masks that have been prepared together with the museum’s patron” [36]. The scale of the response came as a surprise to the museum staff, and the final result of the initiative was an outdoor campaign under the slogan “Art Soothes Longing”, featuring reproductions of selected works from the museum’s collection, accompanied by comments from visitors: “I’ve missed Olga Boznańska’s *Granny’s Nameday* because it’s been a long time since I saw my grandparents” [statement by Krzysztof Kowalczyk-Fijałkowski]—Figure 1a; “To stand in front of Zak’s *Pierrot*. . . and have nothing to do with everything going on around you, and smoking a pipe while doing fake poses. . . I miss that” [lena\_robas]; “I often think of this work when I talk to my friends; they say we’ll see more of it soon” [bartosz\_w\_panek]; “*Earth* by Ruszczyk. . . I miss the vast, mighty sky, like a view unobstructed by a mask” [Maria Muller]; “I’ve been sitting in an empty school for a few months now and I miss it. This picture is a dream of a school corridor at break time. We have only slightly fewer horses at our school” [filipinolippi]; “I’ve missed *Saint Anne of Faras*, both the one in the museum and the tiny copy that is in my family home, which I have not been able to visit for a year now due to the pandemic. . .” [Anna Filipek]—Figure 1b.



**Figure 1.** (a,b) Posters designed by the National Museum in Warsaw as part of the *Art Soothes Longing* campaign.

These statements not only speak of a longing for museums and their collections, but they also make us realise why we need art galleries, and why they are so important in the construction of our own identity and personality. They show that works of art not only build our aesthetic experience, but also help us to understand or more fully experience our relationship with the world and the people around us.

In view of the above, it is possible to conclude that the digital transformation of museums (or the cultural sector as a whole) was not merely a reaction to the restrictions introduced, or an efficient marketing exercise designed to sustain interest in those institutions, but it was actually much more significant: it was a socially relevant action aimed at sustaining the greatest possible impact of museums by building the well-being of the communities around museums. This context of the social relevance of museums is in line with the spirit of the narratives about these institutions that have been presented for some time, especially after the experience of the pandemic: “Another pivotal force defining a human-centred mindset for museum change is driven by new research and writing on empathy and human connection. These elements are integral to any vision of change for museums into places that feel alive with the spirit of connection” [37] (p. 5).

Polish museums have very quickly grown into this role, engaging in activities that build links among the museum community on one hand and, on the other, responding to the needs of audiences longing for direct contact with art departments. Of course, online formats became the basis for action. Their development necessitated investment in both the infrastructure and the team. In the case of the national museums, this was easy as the organiser offered support both in terms of investment in the necessary equipment and facilities, and also in developing new forms of communication. This made it possible, for example, to set up a recording studio at the National Museum in Warsaw, enabling the production and editing of audiovisual material at a level that meets the requirements of modern digital media, and to conduct streaming.

Investment in equipment, new technologies, and team training (increased activity in these areas was noted in all the museums surveyed, to a greater or lesser extent) was followed by a surge in social media users. This is best seen from the example of Facebook, which remains the channel with the largest reach for Polish museums. The Wawel Royal Castle’s fan page has more than 140,000 followers today (April 2023), compared to around 12,000 in 2019. In December 2019, the National Museum in Warsaw had 68,000 followers on Facebook, compared to more than 110,000 today (April 2023), while the National Museum in Krakow had 62,950 followers in 2019 versus 103,000 in April 2023. At the same time, it is important to note that museums approach the use of social media in different ways, with

an uneven distribution of engagement in each of them. Such an approach does not seem entirely well thought out since it is well known that individual social media platforms reach different age groups.

In the museums surveyed, the activities undertaken can be divided into several types, but two general remarks should be made first. Firstly, most of the activities were carried out in an earlier period, and during the pandemic itself there were only efforts to adapt them as best as possible to allow interaction through the electronic media. Secondly, the museum teams realised very quickly that, in the context of the exponential growth of the digital materials being produced, it was necessary to structure this communication, and to stream it. It was also necessary to make these materials coherent, both in terms of the internal coherence of the materials being produced by a given museum, as well as finding a banner under which those materials could be published in order to distinguish them from those produced by the competition. At the National Museum in Warsaw, a hashtag slogan was introduced (#soonatNMW), and all content was labelled with a unique logo. Only one campaign was marked separately—#debttofratitute—which aimed to draw attention to, and appreciate, the work of all those who were directly involved in helping those in need during the pandemic. A similar solution was adopted at the Wawel Royal Castle, where a unique hashtag was used to mark various types of action, e.g., #throughthekeyhole (the inner life of an apparently closed museum), #experttime, and #askacurator. Likewise, the National Museum in Lublin followed a similar path, introducing six permanent cycles with a daily post under the hashtag #discoveringchapel frescos, concerning the most valuable monument on the museum's grounds—the Gothic chapel. The National Museum in Krakow introduced a 'Museum at Home' tab on its website, which contained all the digital activities that were available to viewers.

- Seeking a digital equivalent to the traditional reception of artworks exhibited in the permanent galleries.

The permanent galleries bring together the most famous, and the most valuable, works of art in a museum's collection. For this reason, viewers of these exhibitions often return to them to see their favourite works. It seems natural in this situation that an attempt should be made to create a substitute for viewing these works. The National Museum in Krakow, for example, prepared two videos recording tours around the permanent galleries, which were made available on its YouTube channel as part of the prologue to the 30th Jewish Culture Festival in Krakow (the two videos received a total of 2172 views).

- Creation of virtual temporary exhibitions, possibly scanning and making available real exhibitions that are closed due to restrictions.

Temporary exhibitions provide a unique opportunity to view works of art that are not normally available in a particular museum; usually, a large part of the changing exhibitions are works that are on loan from other museums. Among the most successful undertakings of this type during the pandemic was the exhibition, *Poland: The Power of Images*, which was prepared at the National Museum in Warsaw. This was one of those cases where the prepared exhibition never had an opening, and it was left waiting for visitors in closed museum rooms. This became the inspiration to scan the gallery space in 2D and 3D, and prepare a virtual tour through the exhibition, combined with a curator's commentary. This activity proved to be a great success as the digital version of the exhibition was eventually viewed by more than 70,000 people online. A unique activity in this area was a real-time guided tour of the *State of Affairs* exhibition at the same museum, which was streamed live on TikTok. It was viewed by over 6000 people and lasted more than three hours, as the viewers were able to ask a number of questions that the curators answered in real time (it should be noted that a group of 100 people is considered large for a traditional curator's tour).

- Lectures, talks about the collection, meetings with curators and educators.

These types of activities are, in ‘normal’ times, a regular feature of the programme of every major museum (institutions with larger resources do not necessarily prepare such activities as part of their regular programme, but rather they stand out for their frequency and high level of technical preparation, such as presentations accompanying lectures. This technical prowess directly translates into the quality of their digital experience offer. Some types of activities continue to be implemented in a hybrid form after the pandemic, thus increasing the range of participation (e.g., lecture series related to the institution’s collection).

- Classes and various activities designed for specific audiences (children, senior citizens, people with disabilities).

An interesting observation arising from the experience of the museums surveyed was the fact that there was an increase in the participation of two audience groups: senior citizens and people with disabilities. Whilst the number of children and young people participating in museum events decreased when it was not possible to visit museums together with a school class, it turned out that senior citizens and people with disabilities saw digitalisation of the message as a new opportunity, and they became recipients of content they had not previously used due to difficulties in accessing the facilities. Paradoxically, it proved more difficult to build relations in the digital world with the very group that was most familiar with it—young people. Accustomed to attractive messages on social media, they expected the same from museums, both in terms of the technical quality as well as the form and content. Solutions were sought to this problem, e.g., the National Museum in Gdansk published educational workshops for children on a daily basis in the form of tasks designed to activate the creative competences of young audiences.

- Audience activation activities using the collection (competitions, quizzes, etc.).

In practically every statement made by museum staff about the changing nature of their contact with audiences during the pandemic, it was emphasised that the main objective had become the activation of audiences on various levels—encouraging comments or inviting people to co-create content, e.g., by uploading their own photos. In several museums, it was common practice to organise various types of competitions and quizzes, or publish riddles for the public. The National Museum in Krakow, for example, announced a competition for a meme, using the museum’s collection, that would best comment on the pandemic. The National Museum in Warsaw, in connection with the opening of its new platform CyfroweMnW [Digital NMW], announced a competition titled #CiętaSztuka [#SnippedArt], which involved the creation of collages, and alterations of works visible within the framework of free access. Meanwhile, by intentionally combining entertainment with learning, the Wawel Royal Castle published regular quizzes on Instagram stories, in addition to organising various competitions, including a photographic contest run jointly with Wikipedia called *Architectural Detail at Wawel*.

- Materials showing the hidden everyday life of a museum (e.g., conservation activities).

This type of content was very popular with audiences. The opportunity to get a sneak peek into the secret life of a museum (as with a theatre or other institution) always arouses curiosity. The National Museum in Krakow, for instance, had already been running the blog *Brzuch Muzeum [The Museum’s Belly]*, or *NMK from the inside*, since 2016. During the pandemic, a series of short films under the collective title *Invisible Wizards* was produced at the Wawel Royal Castle. Each one was devoted to a single object, covering both its history and the process by which it was restored to its former splendour by conservators who often had to solve crucial dilemmas and overcome various difficulties.

- Museum lessons (available offline as well as conducted in real time).

Museum lessons are one of the main activities of the formal education department in every museum. The pandemic completely ruled out the possibility of organising lessons as pupils could not physically attend the museums. Quite quickly, digital materials began to be created containing the content that had previously been covered in the lessons. The

real surprise, however, came with the lessons delivered online in real time. Not only did they once again make it possible to participate in live classes, but they also significantly increased the geographical reach of this type of activity. At the National Museum in Warsaw, the first surprise was the number of applications from schools in distant provinces, but an even bigger one was the growing interest in museum lessons from Polish schools virtually all over the world. It also turned out that this form of access to the native culture of communities living in the diaspora was attractive not only to children and young people, but to all members of the community. The scale of the online lessons conducted by museums is best shown by the figures for 2020 and 2021, where the number of participants was in the thousands. The Wawel Royal Castle organised 225 lessons for 4796 people, while the National Museum in Krakow held 317 lessons for 6460 people. The undisputed leader in this area, however, was the National Museum in Warsaw, which conducted 1908 online lessons that were attended by 47,700 people.

When analysing the data obtained from the museums surveyed, it is important to highlight two other aspects of the development of the digital experience offer—ones that were not related to the audiences, but rather to the teams of the individual museums.

The first was the gradual integration of the team through these activities, and the breaking down of the barriers separating the various departments. The need to record videos for YouTube or reels for use on Instagram or TikTok, or even the professional preparation of the streaming of an event, required the involvement and cooperation of a considerable number of people who previously may not have had the opportunity to work together so often.

The second aspect concerns the increased knowledge of the competitive environment. It is the norm that museums observe each other's activities, and relate them to their own reality. However, the pandemic shortened geographical distances, which meant, thanks to their digital content, that the activities of museums became even closer, including institutions from other continents. A good example of this was the campaign organised at the National Museum in Warsaw when viewers were encouraged to reproduce works of art, or motifs connected with them, at home. The picture combining Aleksander Gierymski's *Jewess with Oranges* with the motif of toilet paper, a commodity of particular interest to consumers in the first weeks of the pandemic, became famous nationwide. As the originators of this competition admit, they were inspired by a similar initiative at the Getty Museum in Los Angeles.

## 5. Discussion

In Polish museums, the pandemic resulted in a significant improvement in the digital competences of their teams, the technical equipment of the institutions, and the access to technologies necessary for the implementation of projects in the digital world. All this translated into substantial increases in both the number of users of the museum's social media and the recipients of their digital educational offer, and also the popularisation of the works of art and collections housed in the individual museums. An opinion has even been expressed that the pandemic actually contributed to a revolution in the field of museum education [38]. If we add to this the progressive digitalisation of museum collections (the current leaders in this area in Poland are principally the National Museum in Warsaw and the National Museum in Krakow), we must conclude that we are facing a radical change in terms of the ease of access to museum collections. This is significant not only with regard to the popularisation of cultural heritage, but also for its new interpretations. The continuing development of digital technologies is likely to bring about further transformations in this respect. Thus, it is not difficult to agree with Byungjin Choi and Junic Kim when they spoke of a new paradigm of the relationship between museums and users: "Today, with the application of digital technology advancements—virtual and augmented reality, robots, and artificial intelligence—and the increasing use of various Internet and smartphone-related services, museums are changing and becoming 'smart'. Digital technology, particularly, has enhanced, more than ever before, the existing potential value of museums' cultural heritage

and various contents beyond simple physical space and time constraints. Digitalisation improves the quality of the experience for visitors, makes museums accessible to more visitors, and promotes the use of the values and assets of museums in a wider variety of fields. In this respect, digitalisation is bringing about a new paradigm and an essential change in the relationship between museums and its users" [39].

Undoubtedly, changes in this area are taking place at various levels, and will continue to do so. During a study conducted at the National Museum in Warsaw, it was stated that there has been a re-evaluation of the digital channels used hitherto: "According to our observations, the pandemic caused a decline in the importance of websites in favour of social media. The representative business card and the first place to look for basic information, such as the museum's opening hours, have become profiles on various platforms, above all Facebook" [40].

With these statements in mind, it is worth observing and studying the audience's response to these changing conditions. It would seem, however, that while museum visitors are keen to use digital tools for information purposes, reaching out for promotional messages or ones that combine promotion with entertainment, they still prefer a real visit over virtual tours, digital images of works, or online encounters. During the pandemic, many people working in museums declared that digital communication channels would completely transform their institutions, and that after the pandemic, these new forms of cultural participation would remain on offer. However, it has turned out that, given a choice, audiences are no longer as keen to take advantage of the opportunities offered by the digital world, preferring the opportunity to visit galleries and exhibitions in person. The Education Department of the National Museum in Krakow conducted a survey of the museum's own audience in this regard, and the data obtained clearly showed that their audience strongly prefers direct contact with art. For this reason, in this museum (as in many others), online broadcasts of vernissages, lectures and workshops have been abandoned, while popular materials on the hidden life of the museum (e.g., the conservation of works of art) or videos devoted to temporary exhibitions have remained the standard. At the National Museum in Warsaw, a different solution was sought, and in the case of lectures, a hybrid model was applied whereby it is possible to actually attend a lecture which is also being simultaneously streamed online (the recording of the event remains later on Facebook, with one recent lecture having a total of over 1500 views). Online-only events have also been retained in its offer, such as the permanent series Matura SOS.

In discussing the changes that the pandemic brought about in museums, another point worth noting is the change in existing roles. Before the pandemic, the divide between external and internal stakeholders was sharp and indisputable. But there are now claims that the pandemic has changed this situation. The best-performing museums were those that saw their existing visitors as internal stakeholders, co-creators of digital content, who helped to model the flow of information online [41].

The question remains still open: how do we seek balance in the development of digital museums, and in the process of digitising museum collections? Making the collections available online undoubtedly minimises the carbon footprint as digital access to a museum tends to put less of a burden on the planet than an in-person visit to a gallery. There are also implications for access to cultural elements contained in the museums for vulnerable groups. However, the research presented in this article, and the conclusions drawn from it show that audiences primarily want real contact with works of art. This can hardly be considered a fad—after all, that is the essence of art as such. How can these different approaches be reconciled in the light of the concept of sustainability [42]? It could be said that, in the coming decade, museums will have to meet the challenge of "parallel development", creating a digital world alongside their traditional offerings. Here, however, further questions arise that are both substantive (what proportion should be maintained between these areas) and economic (where should the financial resources for these activities should be drawn from).

## 6. Conclusions

The evolution of cultural participation, including for museums, will continue to change. As of today, it can be said that no form of digital art reception can compete with a real visit to a gallery or an exhibition. This is proven by recent blockbuster museum exhibitions that have broken attendance records. An excellent example of this is the Vermeer exhibition at the Rijks Museum in Amsterdam (10 February–4 June 2023), which sold 500,000 tickets (according to the museum’s website, tickets for the exhibition were completely sold out). In Poland, a highly popular exhibition was *Witkacy: Seismograph of the Acceleration Age* (8 July–9 October 2022), which was visited by more than 111,000 people.

Strategic decisions about the progress of digitalisation in museums must be influenced by public response. It will not affect the priorities for the digitalisation of museum objects: documentation and recording, building a knowledge base for scientific studies, or popularising images of works of art in different contexts (e.g., the production of merchandise or personalised souvenirs) [43–46]. However, there is a need to rethink the extent to which museums are digitalising their offers. As the data cited shows, a digital experience offer cannot compete with a real visit to a gallery. At the same time, however, it can facilitate access for people from groups at risk of social exclusion, and it is also often an opportunity for people who cannot visit a museum due to geographical distance to see a particular exhibition [47].

There is a risk that museums will limit the digitalisation of their offers for budgetary reasons. Already, for example, many Polish museums are not translating their digital content into sign language, even though this is required by the law on accessibility. Should there be a gradual move away from digitalisation, the argument may be the same: “Since it is used by relatively few people, we may as well abandon it. We will be able to put more money into real exhibitions”.

Ultimately, the response of audiences has been unequivocal—a fact best shown by the attendance figures for Polish museums in the full post-pandemic year of 2022. The recorded numbers of total visits to exhibitions and galleries broke all records, in many cases far exceeding attendance levels before the outbreak of the pandemic: the Wawel Royal Castle recorded 1.791 million visits (2019: 1.588 million), the Royal Castle in Warsaw recorded 1.755 million (2019: 1.033 million), the National Museum in Warsaw recorded 1.62 million (2019: 1.172 million), and the National Museum in Krakow recorded 1.365 million (2019: 1.196 million).

In the museum world, these results were greeted with the simple comment: “They’re back. Our audiences are back”.

**Funding:** Institute Culture, Faculty of Management and Social Communication, Jagiellonian University.

**Informed Consent Statement:** Informed consent was obtained from all subjects involved in the study.

**Conflicts of Interest:** The author declares no conflict of interest.

## References

1. Pasternak-Zabielska, M. *Raport z Badania Instytucje Kultury w Okresie COVID-19. Muzealne Strategie Docierania do Widzów*; Narodowy Instytut Muzealnictwa i Ochrony Zbiorów: Warszawa, Poland, 2021.
2. UNESCO. Report: Museum Around the World. In the Face of COVID-19. 2021. Available online: [https://unesdoc.unesco.org/ark:/48223/pf0000376729\\_eng](https://unesdoc.unesco.org/ark:/48223/pf0000376729_eng) (accessed on 1 February 2022).
3. Moon, M. Retooling for the Revolution: Framing the Future of Museum Management after COVID-19. *J. Cult. Manag. Cult. Policy/Z. Für Kult. Kult.* **2020**, *6*, 193–220.
4. Watson, S. (Ed.) *Museums and Their Communities*; Routledge: London, UK, 2007.
5. Barańska, K. *Muzeum w Sieci Znaczeń. Zarządzanie z Perspektywy Nauk Humanistycznych*; Attyka: Kraków, Poland, 2013.
6. Aliakbar, J.; Taheri, B. Cultural Consumption, Interactive Sociality and the Museum. *J. Mark. Manag.* **2013**, *15–16*, 1729–1752.
7. Gustafsson, C.; Akram, I. Museums: An incubator for sustainable social development and environmental protection. *Int. J. Dev. Sustain.* **2016**, *5*, 446–462.
8. Ferilli, G.; Grossi, E.; Sacco, P.L.; Blessi, G.T. Museum environments, visitors’ behaviour, and well-being: Beyond the conventional wisdom. *Mus. Manag. Curatorship* **2017**, *32*, 80–102.

9. Cole, J.B.; Lott, L.L. (Eds.) *Diversity, Equity, Accessibility, and Inclusion in Museum*; Rowman & Littlefield: Lanham, MD, USA; Boulder, CO, USA; New York, NY, USA; London, UK, 2019.
10. Catlin-Legutko, C.; Taylor, C. (Eds.) *The Inclusive Museum Leader*; Rowman & Littlefield: Lanham, MD, USA; Boulder, CO, USA; New York, NY, USA; London, UK, 2021.
11. Vulpe, M. Collections management action support system—CMASS. *Int. J. Mus. Manag. Curatorship* **1986**, *5*, 349–356.
12. Keen, S. *Fragments of the World: Uses of Museum Collections*; Routledge: London, UK; New York, NY, USA, 2005.
13. Litchfield, R.; Gilson, L. Curating Collections of Ideas: Museum as Metaphor in the Management of Creativity. *Ind. Mark. Manag.* **2013**, *42*, 106–112. [CrossRef]
14. Silverman Lois, H. Visitor Meaning-Making in Museums for a New Age. *Curator Mus. J.* **1995**, *38*, 161–170. [CrossRef]
15. Hanquinet, L. Visitors to Modern and Contemporary Art Museums: Towards a New Sociology of “Cultural Profiles”. *Sociol. Rev.* **2013**, *61*, 790–813.
16. Rodney, S. *The Personalization of the Museum Visit. Art Museums, Discourse, and Visitors*; Routledge: London, UK, 2019.
17. Mason, D.; McCarthy, C. Museums and the Culture of New Media: An Empirical Model of New Zealand Museum Websites. *Mus. Manag. Curatorship* **2008**, *23*, 63–80. [CrossRef]
18. Parry, R. (Ed.) *Museums in a Digital Age*; Routledge: London, UK, 2010.
19. Proctor, N. Digital: Museum as Platform, Curator as Champion, in the Age of Social Media. *Curator Mus. J.* **2010**, *53*, 35–43.
20. Maracos, P. Museums and Social Media: Modern Methods of Reaching a Wider Audience. *Mediterr. Archaeol. Archaeom.* **2014**, *14*, 75–81.
21. Mihelj, S. Culture Is Digital: Cultural Participation, Diversity and the Digital Divide. *New Media Soc.* **2019**, *21*, 1465–1485.
22. Jung, Y. *Transforming Museum Management. Evidence-Based Change Through Open System Theory*; Routledge: London, UK, 2022.
23. Black, G. *Transforming Museums in the Twenty-First Century*; Routledge: London, UK, 2012.
24. Golding, V.; Modest, W. (Eds.) *Museums and Communities. Curators, Collections and Collaboration*; Bloomsbury: London, UK, 2013.
25. Lord Gail, D.; Lord, B. *The Manual of Museum Management*; AltaMira Press: Lanham, MD, USA, 2009.
26. Simon, N. *The Participatory Museum*; Santa Cruz Museum: Santa Cruz, CA, USA, 2010.
27. Piontek, A. *Museum und Partizipation. Theorie und Praxis Kooperativer Ausstellungsprojekte und Beteiligungsangebote*; Transcript Verlag: Bielefeld, Germany, 2017.
28. Kaitavuori, K. *From Accessibility to Participation—Museum as a Public Space, In Making Cultural Heritage Truly Common (Conference Publication)*; Finnish National Gallery: Helsinki, Finland, 2008.
29. Nowacki, M.; Kruczek, Z. Experience Marketing at Polish Museums and Visitor Attractions: The Co-Creation of Visitor Experiences, Emotions and Satisfaction. *Mus. Manag. Curatorship* **2021**, *36*, 62–81.
30. Ambrose, T.; Paine, C. *Museum Basics. The International Handbook*; Routledge: New York, NY, USA, 2018.
31. Falk John, H. *The Value of Museums. Enhancing Societal Well-Being*; Rowman & Littlefield: New York, NY, USA; London, UK, 2022.
32. Tula, G.; Bowen Jonathan, P. (Eds.) *Museums and Digital Culture. New Perspectives and Research*; Springer: Berlin/Heidelberg, Germany, 2019.
33. Klinowski, M.; Szafranowicz, K. Digitisation and Sharing of Collections: Museum Practices and Copyright During the COVID-19 Pandemic. *Int. J. Semiot. Law-Rev. int. Sémiot. jurid.* **2023**, *1*–29. [CrossRef]
34. Bokolo, A., Jr.; Petersen, A.S. Examining the digitalisation of virtual enterprises amidst the COVID-19 pandemic: A systematic and meta-analysis. *Enterp. Inf. Syst.* **2020**, *15*, 1–34.
35. Bokolo, A., Jr. Managing digital transformation of smart cities through enterprise architecture—A review and research agenda. *Enterp. Inf. Syst.* **2021**, *15*, 299–331.
36. Muzeum Narodowe w Warszawie. Available online: <https://www.facebook.com/MuzeumNarodowe/posts/pfbid0rw9mRXqkbVEprHZb9xe8H7SzfxfwsmERdDKTDH3mNxikLhu1YfEVBXWutB4i8Vl> (accessed on 3 October 2022).
37. Murawski, M. *Museum as Agents of Change. A Guide to Becoming a Changemaker*; Rowman & Littlefield: Lanham, MD, USA; Boulder, CO, USA; New York, NY, USA; London, UK, 2021.
38. Górajec, P. (R)evolution of Museum Education during the COVID-19 Pandemic. *Muzealnictwo* **2021**, *62*, 267–272.
39. Byungjin, C.; Junic, K. Changes and Challenges in Museum Management after the COVID-19 Pandemic. *J. Open Innov. Technol. Mark. Complex.* **2021**, *7*, 148. [CrossRef]
40. Statement by a Person Working at the National Museum in Warsaw. Interview conducted in April 2023 face-to-face interview, conducted at the National Museum in Warsaw.
41. Labadi, S. *Rethinking Heritage for Sustainable Development*; UCL Press: London, UK, 2022.
42. Schweibenz, W. *The Virtual Museum: New Perspectives for Museums to Present Objects and Information Using the Internet as a Knowledge Base and Communication System, Knowledge Management und Kommunikationssysteme, Workflow Management, Multimedia, Knowledge Transfer*; Zimmermann, H.H., Volker, S., Eds.; UVK Universitätsverlag Konstanz: Konstanz, Germany, 1998; pp. 185–200.
43. Styliaras, G.; Koukopoulos, D.; Lazarinis, F. *Handbook of Research on Technologies and Cultural Heritage: Applications and Environments, Information Science Reference*; IGI Global: Hershey, PA, USA, 2011.
44. Pruulmann Vengerfeldt, P.; Aljas, A. *Digital Cultural Heritage—Challenging Museums, Democratising the Museum: Reflections on Participatory Technologies*; Pille, P.-V., Agnes, A., Eds.; PI Academic Research: Frankfurt Am Main, Germany, 2014; pp. 163–184.
45. Laine-Zamojska, M. Digitalizacja w fińskim muzealnictwie. *Muzealnictwo* **2012**, *53*, 124–129.



46. Pawłowska, A.; Matoga, Ł. Wirtualne Muzea w Internecie—forma promocji i udostępniania dziedzictwa kulturowego czy nowy walor turystyczny? *Tur. Kult.* **2014**, *9*, 46–58.
47. Gonzalez-Herrera, A.I.; Diaz-Herrera, A.B.; Hernandez-Dionis, P.; Perez-Jorge, D. Educational and accessible museums and cultural spaces. *Humanit. Soc. Sci. Commun.* **2023**, *10*, 67. [CrossRef]

**Disclaimer/Publisher’s Note:** The statements, opinions and data contained in all publications are solely those of the individual author(s) and contributor(s) and not of MDPI and/or the editor(s). MDPI and/or the editor(s) disclaim responsibility for any injury to people or property resulting from any ideas, methods, instructions or products referred to in the content.

## Article

# Actual and Expected Competencies in the Meetings Industry Sector during the Post-COVID-19 Era: The Case Studies Poland, Ireland, and Hungary

Marek Nocoń \*, Lucyna Jurzak, Paweł Kruszelnicki, Marcin Ziobro and Aleksandra Fabin-Jadczyk

Faculty of Tourism and Recreation, Wyższa Szkoła Turystyki i Ekologii, 34-200 Sucha Beskidzka, Poland; pawel@kruszelnicki.eu (P.K.)

\* Correspondence: mareknocon@wste.edu.pl

**Abstract:** The main purpose of the article is to identify the key competencies of the management staff and employees of meetings industry enterprises during the COVID-19 pandemic, which made it possible to secure the functioning of these entities during the crisis. The results of this survey, conducted in 2020 and 2021 among employees of this industry in three countries—Poland, Ireland, and Hungary, are the basis for a discussion on the competency profiles and competency gaps of employees in the meetings industry. Further research in this area of MICE competencies and the preparation of recommendation packages are necessary in order to prepare the industries for future possible crises based on the knowledge gained during the COVID-19 pandemic.

**Keywords:** competence; meetings industry; management; COVID-19 pandemic; post-COVID



**Citation:** Nocoń, M.; Jurzak, L.; Kruszelnicki, P.; Ziobro, M.; Fabin-Jadczyk, A. Actual and Expected Competencies in the Meetings Industry Sector during the Post-COVID-19 Era: The Case Studies Poland, Ireland, and Hungary. *Sustainability* **2023**, *15*, 11686. <https://doi.org/10.3390/su151511686>

Academic Editors: Zygmunt Kruczek, Bartłomiej Walas and Jun (Justin) Li

Received: 30 April 2023

Revised: 16 June 2023

Accepted: 19 July 2023

Published: 28 July 2023



**Copyright:** © 2023 by the authors. Licensee MDPI, Basel, Switzerland. This article is an open access article distributed under the terms and conditions of the Creative Commons Attribution (CC BY) license (<https://creativecommons.org/licenses/by/4.0/>).

## 1. Introduction

The crisis caused by the COVID-19 pandemic has had an unprecedented negative impact on the operation of the entire tourism industry. The World Tourist Organization has published data showing the percentage decrease in the number of international tourist arrivals by region in January–April 2020 compared to the same period of 2019. Europe in this regard recorded a decline of 44% [1]. The recession also affected a special part of this market—the so-called business tourism, in the literature identified with the meetings industry [2]. Before the outbreak of the pandemic, this was a thriving sector, and its economic importance was steadily growing [3]. Between 2010 and 2019, there was a 26% increase in the number of international meetings [4]. Statistics for 2019 kept by the International Congress and Convention Association, the largest organization of the global meetings industry community—included 13,254 meetings, the highest annual number recorded in its statistics, with an increase of 317 compared to the previous, also record year [5].

In 2020, a pandemic will shake up the meetings industry, dramatically changing the industry's market situation. An international study indicated that of the 5000 sampled meetings scheduled for 2020, more than 1600 were postponed and nearly 650 were cancelled. The remainder were held in hybrid form or moved to the network entirely [6]. In Poland, companies in this industry saw an average 73% drop in revenue and a 63% drop in employment in 2020 [7]. The search for ways to rebuild this industry has become an urgent necessity, primarily because of the economic rationale. After all, many cities are building their economic and tourism potential based precisely on the meetings industry [8]. The number of international conferences is an important indicator of economic competitiveness, used in recognized global city rankings, such as the Global City Index, Global City Competitiveness Index, and Cities of Opportunity. Hence, for many urban agglomerations, the meetings industry is becoming an economic development industry, finding an important place in strategic documents [9].

The purpose of the analysis was to identify the professional competencies of meeting industry employees, considering the experience of the outbreak of the COVID-19 pandemic, and the expectations representative of the sector in this regard. To achieve this goal, an empirical survey was conducted among managers and employees of the meetings industry. The results can serve as a starting point for building competency profiles for specific positions and functions in meeting industry companies. This will make it possible to identify competency gaps, which is now an urgent need in the context of the effects of the pandemic. The problem of the lack of specific sets of competencies in the broader tourism sector was caused by the exodus of employees to other industries and their unwillingness to return after the pandemic stabilized. During the crisis, the industry seemed uncertain and did not give a sense of security and stability of employment, despite the efforts of employers to maintain employment during the pandemic using various adaptation strategies or public support [10,11].

Taking into account the situation arising during the pandemic and the analysis of current trends in the meetings industry, the aim of the study was to answer the following research questions:

1. Is the meetings industry aware of competency gaps?
2. Is it necessary to strengthen the key competences?
3. Is the expected evolution of competences in line with the development trends of the meetings industry?

Considering the situation created during the pandemic period and the analysis of current trends in the meetings industry, it was hypothesized that the core competencies of the industry's employees fit into these trends. The trends projected by the industry are primarily: the rise of new digital technologies and the associated online restructuring, flexible participation, personalization of offerings, security in the broadest sense, and a focus on the customer experience to meet their unique needs [12–14]. At the same time, these trends set the directions for developing employee competencies in companies' HR policies in the post-COVID period.

The term "meetings industry" has replaced such terms as: "business tourism" and "MICE" (an acronym for Meetings, Incentives, Conferences, Exhibitions, which used to be widely used but are now increasingly rare in the literature [15]. According to the World Tourism Organization (UNWTO), the term "meetings industry" refers to the organization, promotion, sale, and provision of services to associations, government and corporate meetings, incentive travel, seminars, conventions and conferences, business events, technical visits, exhibitions, and trade fairs [13]. Thus, the meetings industry is a multifaceted and fragmented industry with many stakeholders, and its management has an organizational structure—often of a public-private nature—called a Convention Bureau. In the meetings industry, there are most often four categories of institutions that play an important role in the preparation or organization of events. These are: Professional Convention Organizers (PCOs), Incentive Travel Organizers, Destination Management Companies (DMCs), and Trade Show and Exhibition Organizers [14]. Representatives of the above institutions were surveyed, the results of which are presented in this article.

## 2. Literature Review

In the literature, the term "competence" is ambiguous, which is related to the interdisciplinary nature of the issue [16] and results in the lack of a single, universal definition [17]. It takes on many different meanings depending on the context in which it is used. Competencies were first defined as a set of demonstrable qualities and skills that enhance job performance [18]. They were associated with specific characteristics of individuals' actions, such as motivation or self-perception [19]. They were also described as knowledge, skills, abilities, and other characteristics associated with a high level of job performance on a given job [20]. Dubois and Rothwell defined competence as a person's characteristics that he or she uses appropriately and consistently to achieve expected results [21]. Levy-Leboyer defined them somewhat more broadly: as the integrated use of abilities and personality

traits, as well as acquired knowledge and skills in order to bring about the successful execution of the established mission [22]. The broadest formulation was proposed by Ludwicyński, describing it as education and skills, attitudes, behaviours, psychophysical characteristics, decision-making powers, and a sense of responsibility objectively needed on the job in order to effectively solve tasks [23].

Among the definitions presented, three streams can be discerned: competence from the point of view of employee performance, competence as an expected standard of work, and competence as attributes of an individual [18]. The authors of this publication relied on the definition of Boyatzis, which combines all three currents and according to which competence is the potential that exists in a person, leading to such behaviour that contributes to meeting the requirements of the job within the parameters of the organization's environment, which in turn produces the desired results [24].

Similar problems arise in identifying the components of competence and their classification. The cited definitions do not agree on both. The most cited elements of competence include knowledge, skills, attitudes, motivation, personality traits, psycho-physical characteristics, and personal culture. However, some of these are controversial as to their validity [18]. Filipowicz and Garvolinskaya argue that competence should not include intelligence, personality, or temperament, as they are relatively fixed, while competence is a category that can be developed [25,26]. There are also doubts about motivation as an element of competence—according to some researchers, it is not a component of competence, but a factor that determines its manifestation in behaviour [18,27]. For the purposes of this study, a commonly used model was adopted, according to which the components of competence are knowledge (understood as: I know what), skills (I know how, I can), and attitudes (I am ready, I want to use my knowledge) [27].

Regarding the classification of competencies, there are many distinctions in the literature, depending on organizational perspectives. For example, there are distinctions between hard and soft competencies, individual and organizational competencies, general and specialized competencies, [28] or baseline (cognitive, social, personal) and executive (industry, company, managerial) competencies relating to the skills of people with managerial responsibility in a business organization [29]. Of particular note are social competencies, which have many components, but there is no consensus on which are the most important. There are various structures of social competencies in the literature—the most common are formed by communication skills, assertive skills, self-expression, and empowerment of others [30]. The subject of separate classifications are managerial competencies. The most cited is the classic model of Katz. He distinguishes three groups of managerial competencies: technical (professional, specialized), social (interpersonal) and conceptual (strategic), the role of which is closely related to the level of management. The former dominates at the lowest level, where front-line managers oversee processes from a technical aspect. Strategic competencies are the domain of senior managers, who are responsible for setting goals and building the organization's strategy. Social competences, understood as an individual's ability to interact effectively with others, are required at every level of management. In this model, the importance of individual competencies changes depending on the level of management [31]. In the literature, it is common to divide competencies into key competencies—common to all employees of an organization, functional competencies—related to work in a specific position, and hierarchical competencies—depending on the function an employee performs in the organization [32–35]. The research, the results of which are presented in this article, was mainly based on the above classification and the Katz model.

The discussion on the need to identify key competencies has been going on in Europe since the 1990s, linked to the process of globalization and the transition to a knowledge-based economy model. Various sets of common competencies that European high school graduates should possess in order to effectively undertake further education were created, as well as key competencies in adult continuing education in order to update and improve

them [33]. Finally, in 2006 the European Parliament recommended eight key competencies that should be developed in lifelong learning [34].

Various explanations of the term can be found in the literature on core competencies in organizations. According to Hamel and Prahalad, they are the sum of individual competencies of employees and organizational competencies, in close connection with the adopted corporate strategy, and at the same time difficult to duplicate, which in effect builds the competitive advantage of the company. According to them, they are formed in the process of organizational learning, and their consolidation is enabled by technological innovation [35]. An extension of this definition can be found in the view of Boguslauskas and Kvedaraviciene, for whom core competencies are those that represent an innovative combination of knowledge, special abilities, niche technologies, information, and unique operational methods, as a result of which a product that represents measurable value for the customer is delivered on conditions consistent with the customer's preferences and expectations [36].

Thus, key competencies are those competencies that distinguish a given company, influence the creation of new products expected by customers and better organization of the company's business activities, and consequently affect the value of the company [37]. Based on this understanding of key competencies, different lists of them are created, depending on the industry, job position, or management level, among others. According to such a perception of key competencies, a study was conducted, the results of which are presented in this study.

Competences in the MICE sector is an area which, although significant and important for the development of this industry, is insufficiently researched and scientifically represented. Research conducted in the field of competences applies to the entire tourism and hotel industry; there are none that would concern industry-relevant competences.

Friedman points out that there is a competency model for the entire hotel, tourism, and event industry, including competencies in relation to the position and organizational levels in a given industry. The described model includes five categories of competences: personal effectiveness, academic, workplace, industry-wide technical, and industrial sector technical competences. Depending on the level, these competencies include interpersonal skills, honesty, flexibility, creative thinking, problem-solving and decision-making skills, or marketing and sales [38]. In a broad range of competences in the tourism and hotel industry, two groups of competences can be distinguished—hard and soft skills. Hard skills are understood as technical skills, also requiring physical activity, and soft skills are related to human behaviour, and approach to people and work [39]. Weber emphasizes the importance of soft skills in the hotel industry, especially for managers, especially performance management (primarily work) and leadership [40]. Soft skills of managers determine their success in the organization, and technical skills can be developed during work [41].

Alejziak conducted a study on the qualifications and competences of tourism workers. Competences important from the point of view of a tourist enterprise are the use of foreign languages, knowledge of computer programs, the use of various means of information, communication via the Internet, industry knowledge (in the field of tourism, recreation), knowledge in the field of marketing/management, professional experience. Other competences useful in tourism, reported by the surveyed employers, were knowledge/skills in the field of customer service, knowledge of sales techniques, geographical knowledge, availability, physical fitness, knowledge of reservation systems, preparation for public speaking, logical and analytical thinking, culinary skills, knowledge of PR, knowledge of regulations, and ability to keep records [42].

In the hotel industry, research has indicated that the most important competencies from the perspective of professionals are interpersonal relations/communication competencies, followed by operational knowledge, leadership, human resource management, and financial analysis skills [43]. In the hotel industry, competence deficiencies of employees in this sector are also identified, which are defined as a lack of theoretical knowledge

and knowledge of the product structure, knowledge of tools used in the management and marketing of services, the ability to serve guests impeccably, knowledge of foreign languages, social competences, and managerial skills [44].

The Canadian Tourism Human Resource Council has created a set of standards that provide a comprehensive description of all the competencies required in the MICE industry. The standards are divided into twelve main categories, including administration, financial management, human resources, risk management, and strategic planning [45]. The study by Liu, Seevers, and Lin analysed the competencies that increase employability in the MICE sector. As a result of the conducted analysis, they state that among the five most important competencies, the following are distinguished: interpersonal communication skills, innovative skills, organizing and coordinating skills, market promotion skills, and planning skills [46].

The study conducted by Formádi and Raffai identified the skills, abilities, and competencies required in the daily activities of event managers, which were: the ability to solve problems and conflicts, team spirit and the ability to work with different people, good communication skills, self-management skills such as punctuality, time management and flexibility, creativity, networking, and human capital, decision-making skills, IT skills, and adaptability [47].

The literature review shows that further research is needed on the competencies of the MICE industry, which, although it is part of tourism, has other needs in terms of employee competencies.

### 3. Methods and Materials

The empirical research diagnosing the competences of the meetings industry has been carried out since 1 December 2020, to 28 February 2021. Four groups of meeting industry companies in Poland, Ireland, and Hungary were covered, i.e., Professional Congress Organizer (PCO), Incentives travel organizers (Incentives travel), and Destination Management Companies (DMC), including event agencies, and trade fair and exhibition organizers. Hotel venues were excluded from the research sample, considering them to be the location of the event.

The research was conducted using the Computer-Assisted Web Interview (CAWI) technique, in which the respondents were asked to complete the questionnaire in electronic form. The survey was addressed to the management staff and employees of the MICE sector. The research tool was self-developed questionnaires, competences, and qualifications in the MICE sector—for employees of the MICE industry and for employers, as a consequence of theoretical research and based on current knowledge in the field of scientific research methodology. The questionnaire consisted of single-choice questions, e.g., in the metric questions, questions with the answer on the 5-point Likert scale, e.g., What is, in your opinion, the actual level of the team's personality traits? and questions with an indication of the answer, e.g., In your opinion, what is useful or necessary knowledge in the field of MICE? Please mark the selected answers—not very useful, useful, very useful.

Among the management staff, i.e., directors, managers, and employees in managerial positions, hereinafter also referred to as the management staff, thirty-one surveys were conducted in Poland and Hungary, and thirty in Ireland. On the other hand, among employees, twenty-three surveys were carried out each in Poland and Ireland, and twenty-seven surveys were obtained in Hungary. The total number also included forty-one completed in-depth interview sheets. In total, 207 questionnaires were obtained in the course of the study. The group of potential respondents was limited due to the size of the assumed sample, i.e., MICE enterprises, in the three surveyed countries. The number of officially certified PCOs in the countries covered by the study is limited, and for example in Poland, there are only nineteen companies [17]; therefore, when obtaining the questionnaires, it was important to reach the widest possible group of respondents in order to guarantee the representativeness of the sample.

The survey questions were in the form of a closed cafeteria, and the structure of the questions was based on a 5-point Likert scale. The results were divided into two groups: management (PCO) opinions (Appendix A) and employee opinions (Appendix B). Statistical analysis was performed using the Chi2 test and the Mann–Whitney U. The results in all tables are significant for the whole ( $\alpha < 5\%$ ).

The structure of the surveyed entities in each country in terms of the type of business and the period of operation in the market is shown in Tables 1 and 2.

**Table 1.** Structure of companies represented by managers.

Country	Type of Company				In Total
	DMC—PCO	Organizer of Incentive Trips	Event Agency	Organizer of Fairs and Exhibitions	
Poland	14 (45%)	7 (23%)	8 (26%)	2 (6%)	31 (100%)
Hungary	10 (32%)	6 (19%)	8 (26%)	7 (23%)	31 (100%)
Ireland	14 (47%)	5 (17%)	7 (23%)	4 (13%)	30 (100%)
In total	38 (41%)	18 (20%)	23 (25%)	13 (14%)	92 (100%)

**Table 2.** Structure of companies represented by employees.

Country	Type of Company				In Total
	DMC—PCO	Organizer of Incentive Trips	Event Agency	Organizer of Fairs and Exhibitions	
Poland	11 (44%)	3 (13%)	7 (30%)	3 (13%)	23 (100%)
Hungary	5 (18%)	7 (26%)	5 (19%)	10 (37%)	27 (100%)
Ireland	8 (33%)	5 (21%)	6 (25%)	5 (21%)	24 (100%)
In total	23 (30%)	15 (20%)	18 (25%)	18 (25%)	74 (100%)

## 4. Results

### 4.1. Assessing the Usefulness of Knowledge in the Meetings Industry

Respondents from both research groups were asked to rank the areas of knowledge as the most useful in the operation of the meetings industry enterprise. The results presented here concern the areas indicated by the majority of respondents. Managers found knowledge in the field of management, negotiations, sociology, and psychology of business and social attitudes to be the most useful (Table 3). The indicated areas of knowledge useful during COVID-19 are closely related to the crisis of the sector caused by the pandemic.

According to employees, areas have also been identified that can be linked to the collapse of the sector. The most useful knowledge indicated by this group was technical knowledge, knowledge of the Office software, sociology, or volunteering (Table 4). This means that both groups are aware of the need to have and expand knowledge and competences in those areas that are important in a crisis situation and affect the ability to manage activities in a crisis situation. The areas of knowledge usefulness in both digital areas overlap, although the percentage distribution of indications within a given area is different. Employees indicated seven areas of knowledge most useful in the functioning of the company. All of them coincide with those indicated by the managers (Table 3). Divergent indications concern management, negotiations, business psychology, and social attitudes, which were indicated only by the management.

**Table 3.** Assessing the usefulness of knowledge as perceived by employers.

Useful or Necessary Knowledge in the MICE Sector	<i>z</i>	<i>p</i>
Management ↑	2.691	0.4%
Sociology ↓	4.331	0.0%
Negotiations ↑	2.691	0.4%
Psychology of business and social attitudes ↓	1.813	3.5%
Technical knowledge ↓	2.235	1.3%
Knowledge of Office software ↓	1.882	3.0%
Knowledge of remote work software ↓	3.583	0.0%
Volunteering and sponsorship ↓	4.760	0.0%
Audit of the conference facility ↓	2.222	1.3%
Sustainable development, corporate social responsibility ↓	2.814	0.2%

Source: Own study.

**Table 4.** Assessing the usefulness of knowledge as perceived by employees.

Useful or Necessary Knowledge in the MICE Sector	<i>z</i>	<i>p</i>
Sociology ↓	3.188	0.1%
Technical knowledge ↓	2.013	2.2%
Knowledge of Office software ↓	1.686	4.6%
Volunteering and sponsorship ↓	3.515	0.0%
Audit of the conference facility ↓	2.198	1.4%
Foreign languages ↑	2.036	2.1%
Sustainable development, corporate social responsibility ↓	1.938	2.6%

Source: Own study.

#### 4.2. Key Competencies

The survey concerned the indication of competencies that are essential for all personnel, regardless of their function and position in the professional hierarchy. For the purposes of the study, a base list of competences was created, also used in the question about social competences, and the respondents were asked to make an individual choice from the presented database. The results presented below include competencies given by the majority of respondents. Hard competencies related to technical skills of organizing, coordinating, and supervising events are missing from the list, as both groups believe they are appropriate only for operational staff. In contrast, competencies such as influencing and international familiarity were assigned exclusively to management.

In the group of company executives, ethics, and ethics in dealing with clients were rated the highest. In a situation of a pandemic, which re-evaluated the patterns previously developed in the industry, ethics became the overriding value and a tool for building trust in uncertain conditions. Other competencies highly rated by managers (Table 5) were interpersonal communication, emotional bond with the company, professional integration, and organization of own work. Among the employees, professional integration was rated the highest (Table 6) as a key competence shared by the entire staff. Due to the convergent indications, it can therefore be concluded that professional integration and interpersonal communication are particularly important for both groups, the lack of which was strongly felt during the pandemic when the processes of isolation and limiting interpersonal contacts took place.



**Table 5.** Key competencies as perceived by managers.

Key Competencies	<i>p</i>	chi
Work ethics	0.00%	24,239
Ethics in dealing with the client	0.88%	6853
Interpersonal communication	4.65%	3962
Emotional bond with the company	0.12%	10,535
Professional integration	2.78%	4838
Organization of own work	0.02%	13,431
Willingness to learn	0.02%	13,431
Building relationships with clients	0.06%	11,877
International sophistication	0.00%	23,771
Influence	0.06%	11,725
Building local partnerships	0.00%	21,793
Focus on event participants	2.94%	4744
Organizing parties/events	0.06%	11,725
Overseeing events	0.00%	37,425
Coordinating events	0.00%	25,834

Source: Own study.

**Table 6.** Key competencies as perceived by employees.

Key Competencies	<i>p</i>	chi
Professional integration	0.41%	8219
International sophistication	0.07%	11,424
Influence	0.35%	8519
Overseeing events	0.07%	11,424
Coordinating events	0.16%	9918

Source: Own study.

#### 4.3. Expected Social Competencies towards the Team of Employees

In the next part of the survey, respondents were asked to select from the base list of competencies those competencies that are the expected social competencies of a team of employees. Based on the opinions of both groups, two sets of competencies were distinguished. The distinction of social competences results from the theoretical basis, due to the indication that they are required at every level of management, e.g., in the area of customer relations or team management. Managers rated the highest: ethics in contacts with clients and at work, international sophistication, and exerting influence (Table 7). Employees indicated the usefulness in particular of emotional bond with the company, ability to adapt to changing conditions, and exerting influence (Table 8). In both groups of respondents, the convergent result is the social competence to exert influence.

#### 4.4. Planned Long-Term Activities

The survey targeted executives, who indicated the company's planned long-term activities to recover from the pandemic crisis, as shown in Table 9 (significant results for the whole  $\alpha < 5\%$ ). Emphasis was placed primarily on obtaining financing from external sources, including EU funds, which is justified due to the deep crisis caused by the pandemic. Other important areas were switching to a different activity, expanding the portfolio of services, and mergers and acquisitions.

**Table 7.** Expected social competencies according to the opinion of managers.

<b>Expected Social Competences of the Team of Employees</b>	<b>z</b>	<b>p</b>
work ethics↑	1.870	3.1%
ethics in dealing with customers↑	2.295	1.1%
international sophistication↓	2.912	0.2%
exerting influence↓	3.778	0.0%
work in information noise↓	2.676	0.4%
cross-skilling↓	2.250	1.2%
building local partnerships ↓	2.058	2.0%

Source: Own study.

**Table 8.** Expected social competencies according to employees' opinions.

<b>Own Social Competences at the Expected Level</b>	<b>z</b>	<b>p</b>
emotional bond with the company↓	2.371	0.9%
ability to adapt to changing conditions ↓	1.750	4.0%
exerting influence ↓	2.397	0.8%

Source: Own study.

**Table 9.** Long-term actions planned for the company's recovery from the pandemic crisis in the opinion of employers.

<b>The Company's Long-Term Activities</b>	<b>p</b>	<b>chi</b>
Searching for financial support, including EU funds	0.02%	16,677
Switching to another activity in whole or in part	0.00%	22,818
Expanding the portfolio of services	0.12%	13,510
Mergers, acquisitions	1.29%	8706

Source: Own study.

#### 4.5. Areas of Human Resources Improvement in the Meetings Industry

The summary below (Tables 10 and 11) covers the areas of further improvement of staff identified by employers and employees (significant results for the whole  $\alpha < 5\%$ ). Both groups indicated the efficiency in obtaining external sources of financing and the ability to use new technologies as important. In the case of employers, sanitary procedures were also highly indicated, which may be related to the experience of the pandemic. Both groups see the need to improve independence in the implementation of tasks and effectiveness in conditions of imbalance.

**Table 10.** Areas of staff improvement in the meetings industry in the opinion of employees.

<b>Areas of Improvement</b>	<b>p</b>	<b>chi</b>
Efficiency in obtaining external sources of financing	0.00%	22,924
Skills in handling new technologies	1.05%	9122
Flexibility of professional competences	3.34%	6801
Independence in carrying out tasks	0.05%	15,050
Efficiency in conditions of imbalance (financial, human resources, medical, market)	0.00%	23,085
Building relationships, image and "stay with us" ethics	1.17%	8893
Staff training is not required	0.00%	43,125

Source: Own study.

**Table 11.** Areas of staff improvement in the meetings industry in the opinion of employers.

Areas of Improvement	<i>p</i>	chi
Sanitation procedures	4.25%	6317
Efficiency in obtaining external sources of financing	0.00%	40,431
Increasing skills in the use of new technologies	0.00%	21,858
Independence in carrying out tasks	0.00%	23,465
Efficiency in conditions of imbalance (financial, human resources, medical, market)	0.00%	29,124
Building relationships, image and “stay with us” ethics	0.13%	13,228
Sustainable development, corporate social responsibility	0.10%	13,770
Staff training is not required	0.00%	80,285

Source: Own study.

#### 4.6. Individual Interviews

In-depth interviews were conducted in accordance with the questionnaire attached to this article (Appendix C). The implementation of in-depth interviews was aimed at:

- Obtaining precise information from enterprise managers;
- Broadening the perspective of the whole research;
- Creating a basis for discussion on the results of quantitative research.

Interviews were conducted among managers from Poland, Hungary, and Ireland. The period of conducting the research in the form of in-depth interviews was conducted during the period of restrictions resulting from the COVID-19 pandemic.

In-depth interviews were conducted by the authors of the article or a person properly prepared and familiar with the context of the conducted research. Interviews were conducted in a face-to-face, telephone, or online form (using communication platforms, including Google Teams) by the researcher or designated person with the respondent. The interview was structured and had a script (attached to the article), and the answers to the researcher’s questions were marked by him/her on the document with the script. The interviews had goals that the researcher wanted to achieve.

In individual interviews, in the form of free statements of managers, they unanimously stated that the competences of employees have an impact on the operation of the company, also in a crisis, and that improving the competences of the team is a chance to rebuild the company and its operations. At the same time, they pointed to the most important competence challenges of the meetings industry during the pandemic, which required an urgent solution.

Among the competencies listed, some concerned the strategic management of the company and competencies important in crisis management, i.e., strategic planning, crisis management, change management, the ability to adapt to changing conditions, an attitude of openness to change, searching for new solutions, and flexible operation. During the pandemic, the competencies scored were those related to remote activity and digital space, i.e., technical knowledge in the field of online and hybrid events, digital competencies, knowledge in the field of online marketing. Additional competencies listed included: ethics in working with clients, knowledge of the possibility of co-financing activities from EU funds, stress management, improving qualifications and readiness to learn, language skills, and broadly understood soft skills.

The responses indicated that professional development is always important, and the time of the pandemic should have been used to expand competences. There is also a need for continuous improvement of employees’ qualifications and a broad exchange of knowledge regarding the MICE sector. In this case, further research, and development of further studies for the MICE sector, as well as industry meetings, can play an important role.

## 5. Discussion

The obtained results indicate the competences of the management staff and employees of MICE enterprises during the COVID-19 pandemic and indicate the desired competences that should be developed in the context of preparing for crisis situations in the future.

In terms of knowledge, both managers and employees pointed to those areas that are essential for managing a company under unstable conditions related to the impact of an unpredictable external factor, such as the pandemic. These areas were, in particular, change management, risk management, and negotiation skills. Employees additionally stressed the importance of operational knowledge, including foreign language skills. This confirms the view that in an organization operating in a changing environment, a profound change in the way it manages and interacts with its environment is necessary [48].

A comparison of the results of the surveys of management and operational staff, concerning the indication of competencies necessary for all employees—regardless of the scope of the company's activities, position in the professional hierarchy, and tasks performed—made it possible to distinguish a set containing nineteen competencies common to both groups. These are (in order according to the averaged results, starting with the highest indications): work ethic, professional integration, organization of own work, ethics in dealing with customers, emotional bond with the company, interpersonal communication, willingness to learn, building relationships with co-workers, ability to cooperate with the environment, relations with superiors, ability to adapt to changing conditions, proper self-presentation, written communication, improving qualifications, building relationships with customers, dealing with conflict situations, availability, solving problems and conflicts, crossing skills.

The above competencies, as a rule, are expected to contribute to building a unified and orderly organizational culture of the company and influence its competitiveness, also in conditions of various turbulent environments. A key group of competencies for the industry, necessary for the smooth functioning of the organization, are social competencies. This proves that the most important capital of an organization in the meetings industry is human capital, and the development of human resources is one of the essential elements of the company's functioning and development strategy [49]. This is especially important during the pandemic economic downturn.

It is also worth noting a special competence outside the group of social competencies, which is cross-skilling. Many of the problems of the meetings industry are too complex to be solved by a single competency area. The multifaceted nature of the industry requires transdisciplinary solutions, so the ability to weld and leverage experience from multiple disciplines is especially needed, especially given the challenges of the post-pandemic era.

The forecast in terms of desired competencies in the post-COVID period was based on the results of surveys on expected social competencies, long-term activities planned by the company, areas of personnel improvement in the near future, and indications of areas in need of urgent solution.

In terms of expected social competencies, a comparison of the two perspectives—management and operations—highlighted two common competencies that ranked high: readiness to learn and professional integration. The former is closely related to the need to build competitive advantage by preparing staff to create innovations and design and implement company development plans. In turn, emphasizing the importance of professional integration is a natural consequence of home office work and the lack of typical professional interpersonal contacts. Both groups also appreciated the importance of interpersonal communication, which is an essential element of effective work and good teamwork, as well as building lasting relationships with the external environment [50]. It is worth adding that the right number of communication channels and organizational culture are important here, as well as the availability and knowledge of forms and tools for information exchange.

The period of the pandemic, putting the meetings industry in an extremely difficult situation, with a very late prospect of recovery [17], made it necessary to search for new forms of activity and plan comprehensive measures to recover from the crisis. The study on

the directions of future activities was carried out during the culmination of the COVID-19 pandemic and the deep crisis of the industry. Hence, such tasks as seeking funding from external sources, reducing employment, and reorganizing or restructuring the company were indicated. Re-examination may indicate to what extent these activities will continue in the post-COVID period. Nonetheless, expanding the scope of services topped the list, and key places were occupied by improving employee competence, remotely/virtually conducted operations, increasing digitization/automation, and new forms of business management. The above-mentioned areas of activity set the directions for competence development in the post-COVID period.

These directions were also confirmed by the indicated areas of future professional development. The statement on management improvement points to two main themes: efficiency in obtaining external funding sources and effectiveness under imbalanced conditions. In the case of staff improvement, these are: self-reliance in the execution of tasks and increased ability to handle new technologies. The above results are also confirmed by individual interviews with managers, who additionally indicate strategic planning, crisis management, change management, stress management, and flexible operation, as well as technical competence to use modern technologies in the implementation of virtual meetings.

In individual interviews, the respondents emphasized the importance of digital competences related to the company's operations and the organization of virtual events, but also knowledge in the field of online marketing during the pandemic. As can be seen, the pandemic has also become a catalyst for accelerating the transformation of the meetings industry. In particular, we can point to the focus on remotely/virtually conducted business and the associated increase in digitization/automation, including the use of artificial intelligence. This trend is closely linked to digital competencies, an area that combines social competencies with technical skills [51]. The literature identifies five areas of digital competence: information, communication, content-creation, security, and problem-solving [2].

Thus, the effect of the COVID-19 pandemic is both the formation of new competencies, such as advanced digital competencies and cross-skilling, and the growth in importance of competencies already defined but considered less important to date, such as crisis management, change management, and knowledge management. At the same time, it should be emphasized that all the groups of competencies identified in the survey results are part of the industry's projected trends [12–14], which can be broadly divided into three areas:

- The rise of new technologies and a flexible approach to organizing events—digital restructuring, hybrid and virtual events, a variety of participation options (physical—face to face, virtual, and hybrid);
- Individual approach to the customer—personalization of the offer, focus on creating an authentic experience for the participant, attention to their involvement, emphasis on emotions, innovation in building an offer of events;
- Security (sanitary, digital, related to geopolitical uncertainty), the importance of data in real-time decision making and event management, and green responsibility.

Identifying and developing key competencies in the meetings industry has a significant impact on the recovery of the sector and its effective functioning in the post-pandemic period. Of great importance in this regard is the building and updating of competency profiles for individual positions, or so-called competency mapping [52]. It brings measurable benefits to organizations, including in the recruitment and selection process, identifying strengths and weaknesses in employees' skills, identifying competency gaps to close them, creating employee development plans, developing training programs or, finally, identifying overlapping job roles. Competency management is therefore a key tool that can determine competitive advantage.

It is important to focus greater research interest on the competences of the MICE sector in the future. Further research is needed in this area because the competences of employees indirectly affect the development of this sector. An important aspect also seems to be

further analysis of the situation of the industry in the MICE pandemic, the conclusions of which may support the sector in responding to similar crisis situations in the future.

Among the limitations of the study, it is worth mentioning the limited research group due to the small number of companies operating in the given areas in three countries to which the authors had direct access. In the future, it is worth expanding the research group and reaching out to other companies operating in the MICE industry. It is also worth noting that MICE is still not a well-researched sector, especially in the context of the COVID-19 pandemic and its long-term effects on the industry. Our study is just the beginning of a discussion that has highlighted the basic implications for the industry, especially in the context of competencies. Due to the importance of the MICE industry in the tourism sector, not only competence studies such as ours are important, but all others that help to better understand this industry. All these issues should be addressed in subsequent studies.

**Author Contributions:** Conceptualization, M.N. and L.J.; methodology, M.N. and M.Z.; software, P.K.; validation, M.N., M.Z., L.J. and A.F.-J.; formal analysis, P.K.; investigation, A.F.-J. and L.J.; resources, P.K.; data curation, P.K.; writing—original draft preparation, M.N., M.Z., L.J., P.K. and A.F.-J.; writing—review and editing, M.N. and M.Z.; visualization, P.K.; supervision, M.N.; project administration, M.N.; funding acquisition, M.N. All authors have read and agreed to the published version of the manuscript.

**Funding:** This research was funded by the Project “Vocational competences in MICE sector” co-financed by the European Union program Erasmus+ 2017-1-PL01-KA202-038802 01/10/2020–30/09/2022.

**Institutional Review Board Statement:** Not applicable.

**Informed Consent Statement:** Not applicable.

**Data Availability Statement:** Not applicable.

**Conflicts of Interest:** The authors declare no conflict of interest.

#### Appendix A. Competences and Qualifications in the Field of MICE (Survey for Managers)

1 What activity do you run in the MICE sector? Tick the answer in the table.

DMC—PCO	
Organizer of incentive trips	
Event Agency	
Organizer of fairs and exhibitions	

2 Does the company you represent have a recommendation from, for example, Convention Bureau or another organization? YES/NO

3 How long has the company been operating on the market? Tick the answer in the table.

Up to 5 years	
6–10 years	
Over 10 years	

4 What is the useful or necessary knowledge in the field of MICE?

Scope of Knowledge	Not Useful	Useful	Very Useful
management			
change management			
risk management			
sociology			
negotiations			

Scope of Knowledge	Not Useful	Useful	Very Useful
marketing			
experience management (user experience)			
psychology of business and social attitudes			
calculation and budgeting			
making the message of the event more attractive			
technical knowledge			
knowledge of Office software			
knowledge of remote work software			
action on social media			
event registration and management systems			
organization of catering			
volunteering and sponsorship			
audit of the conference facility			
foreign languages			
knowledge of the industry			
sustainable development, corporate social responsibility			
knowledge of law regarding the organization of events			

5 Please indicate which types of competencies are necessary for the entire staff and which are dependent on the position in the company.

Specifications	Key Competences (Common to the Entire Staff) (Required from the Entire Staff)	Functional Competences—Occur in People Working in Specific Organizational Units (Required by People Working in Specific Organizational Units)	Hierarchical Competences (Required from Employees Depending on Their Role in the Company)
building relationships with customers			
ethics at work			
ethics in dealing with clients			
interpersonal communication			
availability			
coping with conflict situations			
troubleshooting and conflicts			
proper self-presentation			
motivating oneself and others			
emotional bond with the company			
professional integration			
ability to cooperate with the environment			
able to adapt to changing conditions			
raising qualifications			

Specifications	Key Competences (Common to the Entire Staff) (Required from the Entire Staff)	Functional Competences—Occur in People Working in Specific Organizational Units (Required by People Working in Specific Organizational Units)	Hierarchical Competences (Required from Employees Depending on Their Role in the Company)
international training			
relations with superiors			
influence			
relationships with colleagues			
written communication			
organization of own work			
willingness to learn			
work in information noise			
cross-linking skills			
building local partnerships			
concentration on event participants			
organizing events / events			
supervising events			
coordinating events			

6 Please rate the ACTUAL social competences of the enterprise team. 1—low level, 5—highest level.

Specifications	The Actual Level				
	1	2	3	4	5
building relationships with customers					
ethics at work					
ethics in dealing with clients					
interpersonal communication					
availability					
coping with conflict situations					
solving problems and conflicts					
proper self-presentation					
motivating oneself and others					
emotional bond with the company					
professional integration					
ability to cooperate with the environment					
able to adapt to changing conditions					
raising qualifications					
international training					
relations with superiors					
influence					
relationships with colleagues					
written communication					
organization of own work					
willingness to learn					
work in information noise					
cross-linking skills					
building local partnerships					
concentration on event participants					

7 Please rate the EXPECTED social competences of the company team. 1—low level, 5—highest level.



Specifications	The Expected Level				
	1	2	3	4	5
building relationships with customers					
ethics at work					
ethics in dealing with clients					
interpersonal communication					
availability					
coping with conflict situations					
solving problems and conflicts					
proper self-presentation					
motivating oneself and others					
emotional bond with the company					
professional integration					
ability to cooperate with the environment					
able to adapt to changing conditions					
raising qualifications					
international training					
relations with superiors (managers)					
influence					
relationships with colleagues					
written communication					
organization of own work					
willingness to learn					
work in information noise					
cross-linking skills					
building local partnerships					
concentration on event participants					

8 What is the actual level of the team’s personality traits?

Specifications	The Actual Level				
	1	2	3	4	5
assertiveness					
empathy					
loyalty to the employer					
creativity					
duty					
scrupulousness					
kindness					
control					
ability to conduct discussions					
setting priorities					

9 How do you assess the current, aggregated components of employees’ competences?

Specifications	1	2	3	4	5
	Hard competences. Measurable skills (education, diploma, professional knowledge)				
Analytical skills. They concern the ability to assess a situation, approach a task from different points of view, look for different perspectives, collect specific information					
Technical skills. Knowledge of the software					
Flexibility, ability to adapt to the prevailing conditions, the ability to set priorities. coping with many tasks that are entrusted, i.e., setting priorities, adapting to changing conditions or requirements, and division of work.					

Specifications	1	2	3	4	5
	Interpersonal skills. Ability to work in a group, with colleagues, inspire others to act, engage in joint projects, as well as mitigate emerging conflicts				
Leadership, management skills. There are personality types that are inherently leadership and those that acquire this leadership.					
Tolerance and diversity of diversity. Finally, in every position there is a great variety of personalities, people who have all kinds of belief systems.					
Planning and organizational skills. The ability to design, plan, organize, and implement projects and tasks within the allotted time. This also include goal setting. Setting work efficiency indicators					
The ability to solve simple and complex problems, creativity. A light approach to problems solved with a creative mind in order to find the best solution. Design thinking					

10 If you can do this, distance yourself from the actual management competencies.

Specifications	The Actual Level				
	1	2	3	4	5
creating a team					
taking care of subordinates					
task delegation					
motivating					
managerial courage					
leadership					
organization					
process management					
project management					
strategic thinking					
shift management					
resistance to stress					
finance management					

11 Personnel improvement in the MICE sector should soon focus on:

Type of Professional Development	Operational Staff	Management Staff	Does Not Matter
sanitary procedures			
efficiency in obtaining external sources of financing			
increasing skills in handling new technologies			
new competences			
flexibility of professional competences			
new communication techniques			
independence in carrying out tasks			
effectiveness in conditions of imbalance (financial, human resources, medical, market)			
building relationships, image, and ethics "Stay with us"			
broadening general knowledge			
sustainable development, corporate social responsibility			
increasing knowledge does not matter			

12 What long-term actions is the company planning to recover from the pandemic crisis?

	YES	NO	Does Not Apply to My Company/I Have No Opinion
seeking support, including from financial resources			
switching to another activity in part or in full			
company reorganization/restructuring			
new forms of enterprise management			
improving the qualifications and qualifications of employees			
digitization/automation			
remote/virtual activity			
broadening the portfolio of services			
mergers, acquisitions			
choice of employment			

Please provide some information about yourself:

1. Gender: Female, Male, Other
2. Age: up to 20 years; 21–35, 36–50, over 50 years
3. Work experience in the MICE sector (not necessarily in the current company): under 5 years, 5–10 years, 11–15 years, over 15 years

**Appendix B. Competencies and Qualifications in the MICE Class (Survey for Employees of the MICE Industry)**

1. What type of company in the MICE area do you represent? Tick the answer in the table.

DMC—PCO	
Organizer of incentive trips	
Event Agency	
Organizer of fairs and exhibitions	

2. Does the company you represent have a recommendation from, for example, Convention Bureau or another organization? YES/NO
3. According to your knowledge, how is your supervisor/manager? Tick the answer in the table.

	Never	Occasionally	Often	Always
They are up to date with changes and trends on the MICE market				
Clearly presents the long-term directions of the company’s development, including the vision and mission, to the subordinate employees				
They promote the legitimacy of action for a common goal among employees				
They are constantly looking for opportunities to increase the efficiency of the company’s operations in the long term				
Makes decisions for the sustainable growth of the entire company				
Ensures that their team has clarity of goals, roles, and responsibilities				
Skilfully delegates tasks while giving space for employees’ own initiative				
Creates positive energy and a sense of belonging of subordinate employees to the team				
Appreciates the successes and achievements of his team members				
Cares about the development of competences of subordinate employees				
Provides constructive feedback quickly				
Takes full responsibility for his decisions				
Motivates their team based on the strengths of its members				
With their energy and enthusiasm, they inspire others to achieve success				
He strictly accounts for work efficiency				
Introduces procedures of conduct				

4. In your opinion, what is useful or necessary knowledge in the field of MICE? Tick the answer in the table.

Scope of Knowledge	Not Useful	Useful	Very Useful
management			
shift management			
risk management			
sociology			
negotiations			
marketing			
experience management (user experience)			
psychology of business and social attitudes			
calculation and budgeting			
making the message of the event more attractive			
technical knowledge			
knowledge of Office software			
knowledge of remote work software			
action on social media			
event registration and management systems			
organization of catering			
volunteering and sponsorship			
audit of the conference facility			
Foreign Languages			
knowledge of the industry			
sustainable development, corporate social responsibility			
knowledge of law regarding the organization of events			

5. In your opinion, which competences are necessary for the entire staff of the MICE industry, and which are dependent on the position in the company? Tick the answer in the table.

Specifications	Key Competences (Common to the Entire Staff) Required by the Entire Staff	Functional Competences—Occur in People Working in Specific Organizational Units Required by the People Working in Specific Organizational Units	Hierarchical Competences (Required from Employees Depending on Their Role in the Company)
building relationships with customers			
ethics at work			
ethics in dealing with clients			
interpersonal communication			
availability			
coping with conflict situations			
problem and conflict resolution			
proper self-presentation			
motivating oneself and others			
emotional bond with the company			
professional integration			
ability to cooperate with the environment			
ability to adapt to changing conditions			
raising qualifications			

Specifications	Key Competences (Common to the Entire Staff) Required by the Entire Staff	Functional Competences—Occur in People Working in Specific Organizational Units Required by the People Working in Specific Organizational Units	Hierarchical Competences (Required from Employees Depending on Their Role in the Company)
international training			
Relationships with superiors			
Influence			
relationships with colleagues			
written communication			
organization of own work			
willingness to learn			
work in information noise			
cross-linking skills			
ability to work remotely			
ability to adapt to change			
flexible operation			
the ability to take on new challenges			
organizing events			
supervising events			
coordinating events			

6. Please evaluate your own social competences at the ACTUAL level. 1—low level, 5—highest level.

	The Actual Level				
	1	2	3	4	5
building relationships with customers					
ethics at work					
ethics in dealing with clients					
interpersonal communication					
availability					
coping with conflict situations					
problem and conflict resolution					
proper self-presentation					
motivating oneself and others					
emotional bond with the company					
professional integration					
ability to cooperate with the environment					
Able (ability) to adapt to changing conditions					
raising qualifications					
international training					
relations with superiors					
influence					
relationships with colleagues					

	The Actual Level				
	1	2	3	4	5
written communication					
organization of own work					
willingness to learn					
work in information noise					
cross-linking skills					
ability to work remotely					
ability to adapt to change					
flexible operation					
the ability to take on new challenges					

7. Please assess your own social competences at the EXPECTED level

	The Expected Level				
	1	2	3	4	5
building relationships with customers					
ethics at work					
ethics in dealing with clients					
interpersonal communication					
availability					
coping with conflict situations					
problem and conflict resolution					
proper self-presentation					
motivating oneself and others					
emotional bond with the company					
professional integration					
ability to cooperate with the environment					
able to adapt to changing conditions					
raising qualifications					
international training					
relations with superiors					
influence					
relationships with colleagues					
written communication					
organization of own work					
willingness to learn					
work in information noise					
cross-linking skills					
ability to work remotely					
ability to adapt to change					
flexible operation					
the ability to take on new challenges					

8. What is, in your opinion, the ACTUAL level of the team's personality traits?

Specifications	The Actual Level				
	1	2	3	4	5
assertiveness					
empathy					
loyalty to the employer					
creativity					
duty					
scrupulousness					
kindness					
control					
ability to conduct discussions					
setting priorities					

9. How do you assess your own aggregated components of competencies? On a scale of one meaning low and five meaning very good.

Specifications	1	2	3	4	5
	Hard competences. Measurable skills (education, diploma, professional knowledge)				
Analytical skills. They concern the ability to assess a situation, approach a task from different points of view, look for different perspectives, collect specific information					
Technical skills. Knowledge of the software					
Flexibility, ability to adapt to the prevailing conditions, the ability to set priorities. coping with many tasks that are entrusted, i.e., setting priorities, adapting to changing conditions or requirements, and division of work.					
Interpersonal skills. Ability to work in a group, with colleagues, inspire others to act, engage in joint projects, as well as mitigate emerging conflicts					
Leadership, management skills. There are personality types that are inherently leadership and those that acquire this leadership.					
Tolerance and diversity of diversity. Finally, in every position there is a great variety of personalities, people who have all kinds of belief systems					
Planning and organizational skills. The ability to design, plan, organize and implement projects and tasks within the allotted time. They also include goal setting. Setting work efficiency indicators					
The ability to solve simple and complex problems, creativity. A light approach to problems solved with a creative mind in order to find the best solution. Design thinking					

10. In your opinion, what should the staff development in the MICE sector should focus on? Please indicate the level of staff at which particular types of professional development should be introduced

Type of Professional Development	Operational Staff	Management Staff	Does Not Matter
sanitary procedures			
efficiency in obtaining external sources of financing			
increasing skills in handling new technologies			
new competences			
flexibility of professional competences			
new communication techniques			
independence in carrying out tasks			
effectiveness in conditions of imbalance (financial, human resources, medical, market)			
building relationships, image, and ethics „Stay with us”			
Expanding knowledge			
Sustainable development, corporate social responsibility			
increasing knowledge does not matter			

Please provide some information about yourself:

1. Gender: Female, Male, Other
2. Age: up to 20 years; 21–35, 36–50, over 50 years old
3. Work experience in the MICE sector (not necessarily only in the current company):  
under 5 years, 5–10 years, 11–15 years, over 15 years

**Appendix C. An In-Depth Interview Questionnaire for Managers of the MICE Sector Companies**

Interview conducted with:

Name of organization:

The type of business of the enterprise:

Date of the interview:

1. HOW DO YOU ASSESS THE PERSPECTIVES FOR RECOVERY FROM THE MICE SEGMENT PANDEMIC: How do you assess the perspectives of the MICE sector for recovery from the pandemic. MICE is the sector and all of the below are the sector segments.
  - a. congresses and conferences
  - b. incentive travel
  - c. events
  - d. fairs and exhibitions
2. What do you think of the MICE sector’s most burning problem, requiring solutions in the field of competences?
3. Improving the competence of the team could be a chance for the company? Could the improvement of competences be a new chance for the company?

Rating Scale				
I fully agree	I agree	No opinion	I disagree	I completely disagree

4. Is there a need to develop uniform qualification standards in the MICE sector?



Rating Scale					
Yes, they are necessary	Yes, they will be useful	No opinion	No, they are not useful	No, everyone manages the team in their own way	No, it is not possible

5. In which areas would you like to improve the competences of the team? How do you agree with the following points?

Specifications	Rating Scale				
	I Fully Agree	I Agree	No Opinion	I Disagree	I Completely Disagree
Soft competences					
Hard competencies					
Practical solutions—case studies					
General knowledge					
Practical knowledge					
<i>I am not interested</i>					

6. If handbooks and other tools for qualifications are prepared, which are the most interesting forms?

Specifications	Rating Scale				
	I Fully Agree	I Agree	No Opinion	I Disagree	I Completely Disagree
Themed quests					
Simulation games					
Methodical manuals					
Training videos					
Case study descriptions					
Thematic tests					
Personality tests					
Soft skills guide					
Activity manuals					
Spreadsheets (BID)					
Self-assessment tests					
Classic knowledge manuals adapted to the MICE market					

7. For which kind of competence development will you be able to pay part of the costs?

Specifications	Rating Scale				
	I Fully Agree	I Agree	No Opinion	I Disagree	I Completely Disagree
It is an employee's business. I do not see the need to pay for it					
I can bear the cost, but only for such forms of education as to the effects of which I am convinced					
Postgraduate studies					
Thematic training					
Internships in other branded companies					
Only forms with recognized certificates					

## References

1. World Tourism Organization. New Data Shows Impact of COVID-19 on Tourism as UNWTO Calls for Responsible Restart of the Sector. Available online: <https://www.unwto.org/news/new-data-shows-impact-of-covid-19-on-tourism> (accessed on 25 January 2023).
2. Borodko, K.; Berbeka, J.; Rudnicki, M. *Zarządzanie Innowacjami w Przemysle Spotkań, 1st ed.*; C.H. Beck: Warsaw, Polska, 2015; pp. 11–15.
3. Statista Research Department. Statistics and Facts on the Meetings Industry in Europe. Available online: <https://www.statista.com/topics/5118/meetings-industry-in-europe> (accessed on 25 January 2023).
4. International Congress and Convention Association. The International Association Meetings Market 2019. Available online: <https://www.iccaworld.org/knowledge/article.cfm?artid=701> (accessed on 25 January 2023).
5. International Congress and Convention Association. ICCA Announces Record Number of Association Meetings in 2019. Available online: <https://www.iccaworld.org/newsarchives/archivedetails.cfm?id=2894936> (accessed on 25 January 2023).
6. Statista Research Department. Statistics and Facts on the Meetings Industry in Europe. Available online: <https://www.statista.com/statistics/1259719/covid-19-impact-international-meetings-worldwide/#statisticContainer> (accessed on 25 January 2023).
7. Polska Organizacja Turystyczna. Badanie Rady Przemysłu Spotkań i Wydarzeń Rok z Pandemią. Available online: <https://www.pot.gov.pl/pl/pcb/news/badanie-rady-przemyslu-spotkan-i-wydarzen-rok-z-pandemia> (accessed on 25 January 2023).
8. Zmysłony, P.; Piechota, N. Znaczenie przemysłu spotkań w kształtowaniu potencjału turystycznego miast. In *Zarządzanie Organizacją Przemysłu spotkań w Polsce. Teoria i Praktyka*, 1st ed.; Celuch, K., Ed.; Szkoła Główna Turystyki i Rekreacji: Warsaw, Poland, 2014; Volume 1, pp. 103–117.
9. Walas, B. Polityka zrównoważonej turystyki Krakowa na lata 2021–2028. Wydział ds. Turystyki Urzędu Miasta Krakowa, Kraków, Poland. 2021. Available online: <https://www.krakow.pl/zalacznik/371623> (accessed on 25 January 2023).
10. Gruszka, I.; Manczak, I. Funkcjonowanie podmiotów turystycznych w dobie pandemii COVID-19—Studium przypadku Dolnego Śląska i Małopolski. *Stud. Perieget.* **2021**, *36*, 71–89. [CrossRef]
11. Lekkau, R.J.; Tichaawa, T.M. Adaptive strategies employed by the MICE sector in response to COVID-19. *Geo J. Tour. Geosites* **2021**, *38*, 1203–1210. [CrossRef]
12. Kaoshiung Protocol. Strategic Recovery Framework for the Global Events Industry. Available online: <https://www.iccaworld.org/cnt/docs/ICCA%20Kaoshiung%20Protocol.pdf> (accessed on 10 February 2023).
13. Celuch, K. *Przemysł Spotkań. Wiedza, Produkt, Motywacja*, 1st ed.; Akademia Finansów i Biznesu Vistula: Warsaw, Poland, 2014.
14. Walas, B.; Nocoń, M.; Nemethy, S.; Petrovič, F.; Oleksa-Kaźmierczak, A. Diagnosis of competencies in the meetings industry in Poland, Hungary and Ireland in post-COVID-19 period. *Probl. Perspect. Manag.* **2021**, *19*, 198–212. [CrossRef]
15. Berbeka, J.; Borodako, K.; Rudnicki, M. Postrzeganie innowacji w branży spotkań przez przedstawicieli krakowskich PCO. *Zesz. Nauk. Uczel. Vistula* **2015**, *40*, 5–17.
16. Springer, A. Problemy definiowania i klasyfikowania kompetencji pracowników. *Zesz. Nauk. Wyższej Szkoły Bank. Pozn.* **2011**, *34*, 249–259.
17. Shippmann, J.S.; Ash, R.A.; Batitsta, M.; Carr, L.; Eyde, L.D.; Hesketh, B.; Kehoe, J.; Pearlman, K.; Prien, E.P.; Sanchez, J.I. The Practice of Competency Modeling. *Pers. Psychol.* **2000**, *53*, 703–740. [CrossRef]
18. White, R.W. Motivation reconsidered: The concept of competence. *Psychol. Rev.* **1959**, *66*, 297–333. [CrossRef]
19. McClelland, D.C. Testing for competence rather than for ‘intelligence’. *Am. Psychol.* **1973**, *28*, 11–14. [CrossRef]
20. Mirabile, R.J. Everything you wanted to know about competency modelling. *Train. Dev.* **1997**, *51*, 73–77.
21. Dubois, D.; Rothwell, W. *Zarządzanie Zasobami Ludzkimi Oparte na Kompetencjach*, 1st ed.; Helion: Gliwice, Poland, 2008; p. 32.
22. Levy-Leboyer, C. *Kierowanie Kompetencjami*, 1st ed.; Poltext: Warsaw, Poland, 1997; p. 21.
23. Ludwiczynski, A. *Szkolenie i rozwój pracowników a sukces firmy*, 1st ed.; Polska Fundacja Promocji Kadr: Warsaw, Poland, 1999.
24. Boyatzis, R.E. *The Competent Manager: A Model for Effective Performance*, 1st ed.; John Wiley & Sons: New York, NY, USA, 1982.
25. Filipowicz, G. *Zarządzanie Kompetencjami. Perspektywa Firmowa i Osobista*, 2nd ed.; Wolters Kluwer: Warsaw, Poland, 2016; p. 46.
26. Garwolińska, A. Metodyka tworzenia oczekiwanego profilu kompetencyjnego. In *Współczesne Problemy Ekonomiczne w Badaniach Młodych Naukowców. Zarządzanie Organizacją, Finanse i Inwestycje*; Gruszevska, E., Matel, E., Kuzionko-Ochrymiuk, E., Eds.; Polskie Towarzystwo Ekonomiczne Oddział: Białystok, Poland, 2018; Volume 2, pp. 10–21.
27. Kossowska, M.; Sołtysińska, I. *Szkolenia Pracowników a Rozwój Organizacji*, 1st ed.; Oficyna Ekonomiczna: Kraków, Poland, 2002; p. 14.
28. Varkoly, L.; Jędrzejczyk, W.; Kuceba, R.; Kulej-Dudek, E. Kształtowanie kompetencji kluczowych w społeczeństwie wiedzy. *Zesz. Nauk. Politech. Poznańskiej Organ. I Zarządzanie* **2019**, *79*, 209–219.
29. Filipowicz, G. *Zarządzanie Kompetencjami Zawodowymi*, 1st ed.; PWE: Warsaw, Poland, 2004; p. 38.
30. Tomorowicz, A. The structure of social skills in interactive embrace. *Psychiatria* **2011**, *8*, 91–96.
31. Katz, R.L. Skill of an effective administrative. *Harv. Bus. Rev.* **1974**, *52*, 90–102.
32. Oleksyn, T. *Zarządzanie Kompetencjami. Teoria i Praktyka*, 3rd ed.; Wolters Kluwer: Warsaw, Poland, 2018; pp. 19–45.
33. Kompetencje Kluczowe w Uczniu Sie Przez Całe Życie. Europejskie Ramy Odniesienia. Available online: <https://op.europa.eu/pl/publication-detail/-/publication/5719a044-b659-46de-b58b-606bc5b084c1> (accessed on 25 January 2023).

34. Zalecenie Parlamentu Europejskiego i Rady z Dnia 18 Grudnia 2006 r. w Sprawie Kompetencji Kluczowych w Procesie Uczucia Się Przez Całe Życie. Available online: <https://eur-lex.europa.eu/legal-content/PL/TXT/?uri=celex%3A32006H0962> (accessed on 25 January 2023).
35. Rogozińska-Pawelczyk, A. Kompetencje w organizacji. *Acta Univ. Lodziensic. Folia Oeconomica* **2006**, *199*, 99–120.
36. Boguslauskas, V.; Kvedaraviciene, G. Difficulties in Identifying Company's Core Competencies and Core Processes. *Inz. Ekon. Eng. Econ.* **2009**, *2*, 75–81.
37. Rola Kluczowych Kompetencji Organizacji w Realizacji Strategii Biznesu. Available online: <https://www.e-mentor.edu.pl/arttykul/index/numer/62/id/1206> (accessed on 25 January 2023).
38. Friedman, B.A. Hospitality, tourism, and events industry competency model: Human resource management implications. In *Strategic Innovative Marketing and Tourism*; Springer International Publishing: Northern Aegean, Greece, 2019.
39. Kumar, P.; Mukesh, C. Assessment of Hospitality education in terms of Lacking Skill Development in Meeting the demand of Industry: An Integrative review. *Rev. Tur. Stud. Cercet. Tur.* **2021**, *31*.
40. Weber, M.; Melvin, R.; Crawford, A.; Dennison, D. An exploratory analysis of soft skill competencies needed for the hospitality industry. *J. Hum. Resour. Hosp. Tour.* **2013**, *12*, 313–332. [CrossRef]
41. Weber, M.; Jungsoon Lee, R.; Crawford, A. A suggested best practices for enhancing performance of soft skills with entry-level hospitality managers. *Anatolia* **2020**, *31*, 76–87. [CrossRef]
42. Alejziak, B. Kwalifikacje i kompetencje pracowników turystyki. Próba diagnozy turystycznego rynku pracy. *Folia Tur.* **2014**, *32*, 117–144.
43. Marneros, S.; Papageorgiou, G.; Efstathiades, A. Identifying key success competencies for the hospitality industry: The perspectives of professionals. *J. Teach. Travel Tour.* **2020**, *20*, 237–261. [CrossRef]
44. Kachniewska, M. Oczekiwania przedsiębiorców branży hotelarskiej względem systemu kształcenia na poziomie wyższym. In *Współczesne Uwarunkowan i aiProblemy Rozwoju Turystyki*, 1st ed.; Pawlusiński, R., Ed.; IGiGP UJ: Krakow, Poland, 2013; pp. 439–440.
45. *Meeting and Business Event Competency Standards*; Canadian Tourism Human Resource Council: Ottawa, ON, Canada, 2011; p. 10.
46. Liu, X.; Randy, S.; Hongyi, L. Employability skills for MICE management in the context of ICTs. *PLoS ONE* **2022**, *17*, e0271430. [CrossRef]
47. Formádi, K.; Raffai, C. New professionalism in the event sector and its impact in Hungary. In *People and Work in Events and Conventions: A Research Perspective*, 1st ed.; Baum, T., Deery, M., Hanlon, C., Lockstone, L., Smith, K., Eds.; Cabi: Wallingford, UK, 2009; pp. 82–83.
48. Cabaj, T. Kontekst i uwarunkowania zarządzania zmianą w przedsiębiorstwie. In *Zarządzanie Rozwojem Organizacji w Zmiennym Otoczeniu*, 1st ed.; Pujer, K., Danielak, W., Eds.; Wydawnictwo Exante: Wrocław, Poland, 2017; pp. 7–15.
49. Nowicka-Mieszala, J. Strategiczne zarządzanie kapitałem ludzkim metodą budowy wartości przedsiębiorstwa. *Zesz. Nauk. Wyższej Szkoły Humanitas. Zarządzanie* **2012**, *1*, 89–98.
50. Karczewska, A. Efektywna komunikacja w organizacji. *Zesz. Nauk. Politech. Częstochowskiej Zarządzanie* **2011**, *3*, 108–117.
51. Raport IBTM Trends Watch 2021. Available online: <https://www.ibtmworld.com/en-gb/forms/trends-watch-report.html> (accessed on 25 January 2023).
52. Mangala, A.; Ramachandra, K. Employee competency mapping as a mechanism to weed out competency gaps in information technology: A conceptual study. *Int. J. Appl. Res.* **2017**, *3*, 219–223.

**Disclaimer/Publisher's Note:** The statements, opinions and data contained in all publications are solely those of the individual author(s) and contributor(s) and not of MDPI and/or the editor(s). MDPI and/or the editor(s) disclaim responsibility for any injury to people or property resulting from any ideas, methods, instructions or products referred to in the content.

## Article

# How Has Online Digital Technology Influenced the On-Site Visitation Behavior of Tourists during the COVID-19 Pandemic? A Case Study of Online Digital Art Exhibitions in China

Yanqing Xia <sup>1,2</sup> 

<sup>1</sup> College of Art and Design, Zhejiang Guangsha Vocational and Technical University of Construction, Dongyang 322103, China; xyq520@pukyong.ac.kr

<sup>2</sup> Industrial Design Department, Pukyong University, Busan 48513, Republic of Korea

**Abstract:** The COVID-19 pandemic has had a significant impact on the global tourism industry, leading to a decrease in peoples' willingness to travel and a sense of insecurity regarding tourist destinations. Therefore, restoring people's willingness to travel is the greatest challenge faced by this industry in the post-pandemic era. The tourism industry requires innovative solutions to achieve sustainable recovery. While there is a considerable amount of research on its recovery during the pandemic, there are few studies exploring people's willingness to travel to encourage sustainable and resilient recovery in the post-pandemic era. This study employed a quality model to examine the satisfaction and intention of tourists towards the application of online digital art exhibitions under the influence of COVID-19. The aim was to investigate the promoting role of online digital art exhibitions in the sustainability and resilient recovery of the tourism industry. To achieve these objectives, this study focuses on the online digital art exhibition of Song Dynasty figure paintings launched by China Central Television (CCTV), with post-exhibition surveys conducted and 512 valid questionnaires collected. The research model and hypotheses are tested using structural equation modeling. The results of this study indicate that travelers' intentions to engage in on-site visits through online digital exhibitions are determined by three factors: perceived value, satisfaction, and art therapy. Furthermore, online digital art exhibitions not only represented the most important form of tourism during the pandemic, but they also provided significant psychological healing. They have become a driving force for the transformation of the current culture and tourism industry and the promotion of its sustainable development. This research provides a benchmark for future research on the tourism industry, and it offers new research directions in the field of sustainable tourism.

**Keywords:** sustainable tourism; tourism industry; COVID-19; behavioral intention; online digital exhibition



**Citation:** Xia, Y. How Has Online Digital Technology Influenced the On-Site Visitation Behavior of Tourists during the COVID-19 Pandemic? A Case Study of Online Digital Art Exhibitions in China. *Sustainability* **2023**, *15*, 10889. <https://doi.org/10.3390/su151410889>

Academic Editors: Zygmunt Kruczek and Bartłomiej Walas

Received: 26 May 2023

Revised: 6 July 2023

Accepted: 9 July 2023

Published: 11 July 2023



**Copyright:** © 2023 by the author. Licensee MDPI, Basel, Switzerland. This article is an open access article distributed under the terms and conditions of the Creative Commons Attribution (CC BY) license (<https://creativecommons.org/licenses/by/4.0/>).

## 1. Introduction

The tourism industry provides livelihoods to millions of people and enables billions to appreciate diverse cultures and the natural world. In some countries, tourism accounts for more than 20% of the gross domestic product (GDP), making it the third-largest export sector in the global economy [1]. However, the COVID-19 pandemic has severely impacted the tourism industry, affecting economies, livelihoods, and public services across continents and bringing the industry to a temporary halt [2]. According to forecasts by the World Travel and Tourism Council (WTTC), the COVID-19 pandemic was expected to cause a loss in global tourism to the value of USD 2.1 trillion in 2020 and jeopardize 75 million tourism jobs [3]. Rebuilding market confidence, revitalizing the tourism economy, and achieving high-quality development of the tourism industry have become focal points in academia and industry post-pandemic.

The outbreak of the pandemic has posed unprecedented challenges to the tourism industry, yet it has also presented an opportunity for transformation and change. The

emergence of online digital technologies has facilitated the digital transformation and innovation of the tourism sector [4]. Digital cultural tourism initiatives have emerged during the pandemic, leveraging new-generation technologies such as virtual reality (VR), augmented reality (AR), and artificial intelligence (AI) to create immersive experiences. These initiatives include virtual reality-based scenic spots, entertainment, and museums, and other new forms of culture and tourism experience, fostering new consumer behavior and reshaping people's travel preferences and tourism concepts [5]. Emphasizing safety in tourism and the ability to explore the world from home, and prioritizing user experience, have become paramount [5]. Under the circumstances of the pandemic, online digital technologies have gained more attention than ever from tourists and destination organizations. Online virtual tours of museums and exhibitions and other forms of "cloud tourism" have become the new norm since the pandemic, stimulating people's interest in tourism. Concurrently, online digital technologies are reshaping the manner in which customers plan their travel and search for destination information. By leveraging digitized environments, these technologies enable customers to experience products, services, or locations prior to their physical visit [6]. The increasing reliance on and desire for such online digital environments reflects a gradual shift in tourism perspectives, with individuals predominantly opting for online virtual tourism. Consequently, online digital technologies have opened up new avenues for the revitalization and recovery of the tourism industry, providing innovative approaches to travel and tourism experiences.

Previous studies have explored the use of on-site digital technologies [7] and VR technology for enhancing tourists' travel experiences [8], as well as the impact of VR technology on intentions to make repeat visits to tourist destinations [9,10]. However, the perspectives explored in these studies have been relatively narrow, focusing solely on the impact of digital technologies on tourism destinations. They predominantly concentrate on the "technology" itself, without delving into the influence of online digital technologies on "people" after the pandemic. In particular, the shift in individuals' tourism perspectives and their heightened concerns for personal well-being and health have significantly dampened their willingness to travel. Yet, the revival of tourist demand is considered a key factor in stimulating the recovery of the tourism industry [11]. Consequently, there is an urgent need to address how to effectively guide tourists in regaining their willingness to travel. In fact, tourists are highly interested in online digital technologies and seek to understand how these platforms can provide humanistic care [12,13]. However, there have been few attempts to evaluate user satisfaction with online digital technology applications and their subsequent impact on travel intentions. How do online digital technologies influence tourists' on-site visitation behavior during the COVID-19 pandemic? What are the underlying factors affecting this behavior? Do they contribute to stimulating tourists' travel intentions and promoting the recovery and sustainable development of the tourism industry in the post-pandemic era?

To address the aforementioned issues, this study introduces a comprehensive research model that incorporates factors derived from perceived quality (content, system, and personalized service) and expectation confirmation. From the perspective of tourists' expectation confirmation, the research model explores the effects of perceived quality of online digital art exhibitions, user expectation confirmation, perceived value, perceived enjoyment, and art therapy on satisfaction with online digital art exhibitions and on-site visitation. By examining how online digital technology influences the physical visit behavior of tourists during the COVID-19 pandemic, this research can assist museum curators and other cultural tourism institutions in leveraging digital technology to increase public engagement with art, promote the digital transformation of the culture and tourism industry, stimulate innovation in this sector, unleash the multiplicative effects of digitization on the industry, and facilitate its sustainable development.

## 2. Research Theory and Hypothesis

### 2.1. COVID-19 and Online Digital Art Exhibitions

In the spring of 2020, as the novel coronavirus began to spread globally, the true meaning of globalization seemed to resonate with people, as the impact of the virus extended beyond trade disruptions and stagnant tourism to endanger the art world [14]. As a result of the pandemic, planned art fairs and major exhibitions in various countries were hindered, while museums in many countries remained closed, presenting challenges in cross-border artistic collaboration [15]. To cater to audiences who were unable to attend in person, many museums swiftly transitioned their exhibitions to online platforms, offering “virtual exhibitions” for remote viewing. Suddenly, being “online” became the hottest topic of discussion. It is during this distinctive period that the rapid development of digital art took place.

Online digital art exhibitions refer to the integration of online digital technologies with humanistic art, combining rational thinking and artistic sensibility. These exhibitions are founded on the development of online digital technologies and encompass a fusion of artistic expression and human perception [16]. Online exhibitions, as a form of exhibition accessible anytime and from anywhere through the internet on computers and smartphones, represent one of the most effective ways to disseminate digital information in any field [17]. Online digital art exhibitions represent a new artistic language that blends the contemporary era of new media with traditional art. Leveraging technology for human–computer interaction as a medium, these exhibitions enhance visitors’ perceptual experiences and create a multidimensional and dynamic interactive environment.

### 2.2. Perceived Quality

The concept of perceived system quality was introduced by DeLone and McLean [17], and it is generally defined as “the extent to which users perceive the performance of a system”. Subsequently, this model was updated by Delone and McLean [18], who proposed three types of information system quality—system quality, information quality, and service quality, also known as perceived quality. Perceived quality can be defined as customers’ judgment of the overall excellence or superiority of a product. These three indicators, evaluated based on individual perceptions, are considered primary predictors of perceived quality [19]. Currently, the Information System Success Model has been successfully applied in the field of e-commerce. This model explains users’ adoption of various information systems, for instance, websites, online shopping, mobile applications, online learning, and online travel through VR augmented reality [20–24].

Content quality refers to indicators associated with the content of an e-commerce website, including the relevance, completeness, and comprehensibility of the provided information. Delone and McLean [17] emphasized the importance and relevance of content quality within the Information System Success Model, with various studies further emphasizing its significance. System quality refers to “a system in which the expected characteristics of mobile devices and web browsing services are considered available for user use” [25]. Delone and McLean [17] demonstrated that system quality strongly influences the success of information systems, with indicators relating to system quality and overall system performance measured based on factors such as usability, reliability, functionality, and performance. Service quality is defined as the overall judgment of or attitude towards the quality of a service, and it refers to consumers’ overall impression of its advantages and/or disadvantages. Zhao et al. [26] identified service quality as an important determinant of information system effectiveness.

In this study, content quality refers to the organization of information provided in terms of its accuracy, relevance, and personalization within the context of online digital exhibitions on cultural heritage; system quality pertains to the degree of security, speed, reliability, and convenience of the webpages and mobile interfaces; and good service quality is characterized by visually appealing graphics and immersive interactive experiences.

Online digital art exhibitions represent innovative information technology primarily based on new media. Although research on the perceived quality of online digital exhibitions is limited in terms of user expectations confirmation, studies have extensively explored perceived quality and expectation confirmation in various domains, such as online restaurant reviews, online shopping, and online library resources. Joo and Choi [27] confirmed that users' perceptions of the content quality of online library resources positively influence the confirmation of their expectations. Park [28] added that the confirmation of users' expectations is positively influenced by system and service quality in the context of smart wearable devices. Therefore, a similar trend is likely to apply to users of online digital art exhibitions. Based on this premise, we propose the following hypotheses:

**H1a:** There exists a positive correlation between the content quality of online digital art exhibitions and visitor expectation confirmation.

**H1b:** There exists a positive correlation between the service quality of online digital art exhibitions and visitor expectation confirmation.

**H1c:** There exists a positive correlation between the system quality of online digital art exhibitions and visitor expectation confirmation.

### 2.3. The Expectation Confirmation Model

The Expectation Confirmation Model (ECM), proposed by the renowned American scholar Bhattacharjee [29], is widely recognized as a prominent theory for explaining the post-adoption behavior of users [30]. Initially, it was developed to elucidate the relationships between factors influencing the repeat purchase behavior of consumers. It posits that there exists an inherent relationship between the "expectations" prior to product purchase, the "perceived performance" after purchase, the "degree of confirmation" between prior expectations and perceived performance, "satisfaction" after purchase, and consumers' "intention to repurchase." These factors were identified to be interconnected. In 2001, Bhattacharjee introduced the Expectation Confirmation Model, which comprises four variables: expectation confirmation, perceived usefulness, satisfaction, and continued usage intention.

Expectation confirmation as a key factor in the ECM that plays a significant role in determining users' perceived satisfaction with information systems and services, which, in turn, influences their system usage. Furthermore, as satisfaction is typically defined as a user's overall evaluation of their experience with a specific information system or service, Mason and Nassivera [31] identify satisfaction as one of the core determinants of behavioral intention. Therefore, this study incorporates expectation confirmation, satisfaction, and behavioral intention from the ECM into its research model.

Additionally, Hsu and Lin [32] demonstrate that perceived value replaces perceived usefulness. Users engage with online digital art exhibitions for various reasons, such as leisure, enjoyment, and learning, rather than to achieve specific goals or enhance performance. Previous research has shown that in the tourism domain, the primary factors influencing behavioral intention are perceived quality, perceived value, and satisfaction [33,34]. Thus, perceived value deserves greater attention.

#### 2.3.1. Confirmation

Bhattacharjee defines expectation confirmation as the degree to which information system users' pre-usage expectations are confirmed after system usage. In the context of this study, expectation confirmation refers to a user's evaluation of the degree to which their overall perception of the online digital art exhibition of cultural heritage aligns with their pre-visit expectations. In the Expectation Confirmation Model, expectation confirmation is a key factor that directly influences user satisfaction with system usage. The higher the confirmation of users' prior expectations, the greater their perceived satisfaction with the usage experience. For instance, Vena-Oya et al. [35] found that the confirmation of high expectations significantly influences people's satisfaction with tourist destinations.

Chen et al. [36] demonstrated that expectation confirmation plays a decisive role in determining satisfaction with online shopping. Based on these findings, the following hypothesis is proposed:

**H2:** There is a positive correlation between expectation confirmation and visitors' satisfaction with online digital art exhibitions.

Previous research has shown a strong and important relationship between expectation confirmation and perceived value. Lin et al. [37] revealed that higher expectation confirmation in IPTV leads to greater perceived value. Research found that confirmation of users' expectations of mobile services plays a decisive role in their perception of value and satisfaction [38]. Therefore, the following hypothesis is proposed:

**H3:** There is a positive correlation between expectation confirmation and visitors' perceptions of the value of online digital art exhibitions.

Furthermore, Halilovic and Cicic [39] introduced an extended Expectation Confirmation Model that integrates expectation confirmation with the affective structure of individual users, specifically, the perception of enjoyment. This integration further complements the continuity of perceived information technology quality. Research has shown that expectation confirmation has a positive impact on the perception of enjoyment. Based on this, we propose the following hypothesis:

**H4:** There is a positive correlation between user expectation confirmation and visitors' perceptions of enjoyment in online digital art exhibitions.

### 2.3.2. Satisfaction

Satisfaction, as defined by Oliver [40], represents the discrepancy between consumers' prior expectations and their perception of the product's performance after consumption. Both the ECM and subsequent studies have confirmed that satisfaction is a primary determinant of users' behavioral intentions. Visitors feel satisfied when their experience meets or exceeds their expectations. Numerous studies have established that user satisfaction is an important indicator of subsequent behavioral intentions [41,42], and that satisfaction with online travel experiences has a positive impact on users' behavioral intentions [42–44]. The more satisfied users are with online travel, the stronger their intention to engage in actual visits. Therefore, the following hypothesis is proposed:

**H5:** There is a positive correlation between satisfaction and visitors' intentions to engage in on-site visitation behavior.

### 2.3.3. Perceived Value

Perceived value refers to the overall evaluation of the utility of a product or service [45]. Woodruff [46] considers a product's performance, attributes, and usage effects to be customer value factors that influence the attainment of customer goals. Murphy et al. [47] point out that perceived value, in the context of tourism, refers to the comparison made by tourists between the quality of their tourism experiences and the resources (e.g., money, time) invested in their travel. In this study, perceived value refers to users' overall evaluation of the cultural value, aesthetic value, and service value experienced during the expectation confirmation phase of the digital online exhibition of cultural heritage. Perceived value is relative in nature, as it is comparative, personal, and contextual, and is inherently prioritized, affective, and cognitively emotional [48].

Numerous studies have demonstrated a causal relationship between perceived value and satisfaction, effectively explaining tourist satisfaction and destination choice [49]. Gallarza and Gil Saura [50] argue that perceived value is a prerequisite to experiencing satisfaction in a tourism context. Wei et al. [51] identify tourists' perception of value after engaging in cultural heritage tourism as one of the most significant factors influencing their



satisfaction with a destination and their intention to revisit. Chen and Chen [52] find that visitors' perception of value in heritage tourism has a positive impact on their satisfaction. Based on this, we can hypothesize the following:

**H6:** There is a positive correlation between the perceived value of online digital art exhibitions and visitor satisfaction.

A substantial body of empirical research suggests that perceived value may be a stronger predictor of user behavior compared to satisfaction or quality. For example, Cronin et al. [53] examine the relationships between perceived value, satisfaction, and behavioral intentions across six different service industries, and find that perceived value directly influences customer satisfaction and behavioral intentions in all industries except healthcare. Pura [54] analyzes the direct impact of perceived value on behavioral intentions in a service context. The results of their study indicate that there is a significant influence of perceived value on behavioral intentions, with higher perceived value leading to stronger behavioral intentions. Based on this, we can hypothesize the following:

**H7:** The perceived value of online digital art exhibitions has a positive impact on visitors' intentions to engage in on-site visitation behavior.

#### 2.3.4. Perceived Enjoyment

Perceived enjoyment refers to the extent to which users perceive the activity of using a specific information system as enjoyable [55]. Thong et al. [56] were the first to investigate the relationship between perceived enjoyment and the continued intention to use mobile internet services. By extending perceived enjoyment to the Extended Confirmation Model, a better understanding of the continued behavior in mobile internet services can be achieved. Perceived enjoyment represents the level of enjoyment experienced by users during the usage process, independent of the usage outcome. In the context of this research, perceived enjoyment primarily refers to the pleasant emotions experienced by users after engaging in online digital exhibitions on cultural heritage, with greater emphasis on fully immersive experiences through virtual interaction with art exhibitions.

The concept of perceived enjoyment has been widely studied across different domains. In healthcare environments, visual art has been found to alter patients' emotions, evoking a sense of pleasure in hospital rooms and providing patients with a sense of mental well-being [57]. Ulrich [58] emphasizes that natural environments elicit pleasant emotions and psychological responses, emphasizing therapeutic perception based on emotions. Day [59] suggests that the full appreciation or enjoyment of artwork can serve as a healing pathway for individuals. In their book, Malchioldi and Lippin [60] state that scientific evidence supports the positive impact of all forms of therapeutic art, because they combine sensibility, emotions, and cognition, allowing individuals to fully enjoy and experience life. Chen [61] discusses how audiences easily find presence after interacting with high-quality interactive art, which provides fundamental sensory enjoyment and awakens emotional resonance in individuals, thus serving as a form of therapy and restoration. Based on these observations, we can propose the following hypothesis:

**H8:** The perceived enjoyment of visitors towards online digital art exhibitions is positively correlated with their perception of art therapy.

#### 2.4. Artistic Healing

The origin of "art therapy" can be traced back to Hans Prinzhorn, who published "Artistry of the Mentally Ill" in 1922, where he suggests that the configuration impulse in the drawings of psychiatric patients can be traced back to the universal psychological history of humankind. This study also marked the beginning of the intersection between psychology and the field of art [62]. With the dissemination of art and the development of art therapy, in the 1940s, psychiatrist Margaret Naumburg solidified the concept of "art therapy". Si-

multaneously, artist Adrian Hill and art teacher Edith Kleinman recognized the therapeutic potential of art and the creative process as an intervention for psychological issues. Under the guidance of art therapists, patients enhance their self-awareness, and experience personal growth and therapeutic effects. Over time, art therapy has evolved into a diverse field, encompassing various modalities such as film, music, drama, games, performance, visual arts, and sandplay. Art therapy is no longer solely targeted toward psychiatric patients and has also become a means of healing for individuals seeking to overcome psychological challenges, engage in self-exploration, and express themselves artistically.

In this study, art therapy primarily refers to the “visual arts as therapy” approach, where users primarily view online digital art exhibitions to experience aesthetic pleasure, emotional release, and emotional resonance with the artworks and to attain a state of relaxation, thereby reducing mental anxiety and fostering a sense of social belonging.

Previous research has shown limited discussion on satisfaction and behavioral intentions regarding art therapy and online digital art exhibitions. However, scholars have recognized the positive effects of art therapy in settings such as museums and health-care [63]. A study by Harris et al. [64] indicated that art therapy in hospital environments is a key indicator of hospital satisfaction. This viewpoint has been supported by subsequent studies [65,66]. Zhang [67] demonstrated the significant impact of decorative art in creating emotionally therapeutic landscapes in public spaces and satisfying individuals’ spiritual pursuits. Additionally, Zhang et al. [68] argued that perceived therapeutic effects have a positive influence on the loyalty and behavioral intentions of visitors in urban parks. Kreitler and Kreitler [69] assessed the impact of the art therapy process on individuals’ behavioral intentions. Based on these findings, we can propose the following hypotheses:

**H9:** There is a positive correlation between art therapy and visitor satisfaction with online digital exhibitions.

**H10:** There is a positive correlation between art therapy and visitors’ on-site visitation behavior.

### 2.5. Research Model

Figure 1 presents a conceptual model developed based on the proposed hypotheses.

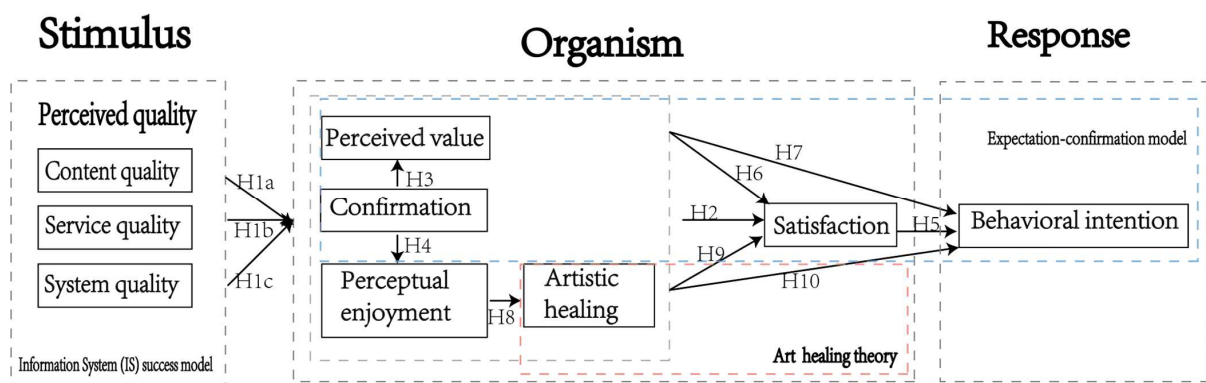

**Figure 1.** Research model.

The conceptual model presented in this study redefines the Stimulus–Organism–Response (S–O–R) theory by incorporating nine variables: system quality, information quality, service quality, expectation confirmation, perceived value, perceived enjoyment, art therapy, visitor satisfaction, and visitor intention to revisit. The S–O–R theory aims to explain users’ behavioral responses to external stimuli. In fact, online digital exhibitions inherently operate within the S–O–R framework, as they provide users with visual aesthetics and services, serving as a distinctive form of psychological stimulation. This service (or stimulus) leads to emotional changes and cognitive enhancement in exhibition visitors, which, in turn, influence their final behavioral decisions, specifically regarding their intention to seek offline exhibition experiences (R). Despite the aforementioned logical

relationships, there is a lack of research specifically focused on online digital exhibitions, and their application in this context remains largely unexplored. To address our research inquiries, we propose ten hypotheses (Figure 1).

### 3. Research Context and Study Methodology

#### 3.1. Song Dynasty Figures Online Digital Exhibition

This study focuses on an online digital art exhibition titled “Millennium Tone: Portraits of Song Dynasty Figures”, which was launched by CGTN, the China Global Television Network, in January 2023. As noted by the renowned scholar Chen Yinke, “The culture of the Chinese nation has evolved over thousands of years, reaching its pinnacle during the Song Dynasty” [70]. This highlights the significance of Song Dynasty culture in the development of Chinese culture. This special digital exhibition features a curated selection of over 200 precious artworks from more than 10 museums worldwide, showcasing the painted figures of the Song Dynasty to an audience of thousands. The exhibition can be accessed via both computers and mobile devices, and it employs the cutting-edge Unity engine, developed for the gaming industry, to create interactive 3D scenes of ancient art. This innovative approach brings the thousand-year-old characters and scenes depicted in Song Dynasty paintings to life, transcending the static nature of traditional artworks. The exhibition website consists of six main thematic digital halls, namely, “Companions”, “Elegant Demeanor”, “Officials”, “Performers”, “Commoners”, and “Immortals” (Figure 2). These halls present the various figures depicted in Song Dynasty paintings, ranging from children and maidservants to scholars, artists, merchants, and Daoist immortals. By offering a close-up experience in which visitors can view the depicted characters, the exhibition provides insights into everyday life in the Song Dynasty, including clothing, cosmetics, and entertainment. Each exhibition area provides vivid interpretations from different perspectives, ensuring a dynamic and interactive experience. Visitors can enjoy and explore 110 high-definition Song Dynasty paintings, whereby the ancient artworks to come alive and engage the audience in an immersive and enjoyable manner (Figure 3).



Figure 2. Six main thematic digital exhibition halls.



Figure 3. Exhibition content.

### 3.2. Questionnaire Design and Measurements

After designing the measurement indicators for each potential variable, this study used existing scales from previous research to create the initial survey questionnaire on factors influencing offline visits by users of the online digital art exhibition. The survey questionnaire consisted of two parts: (1) basic information on the survey participants (gender, age, occupation, etc.), and (2) 36 measurement items for 9 potential variables. To ensure the validity of the final survey data, the research team conducted a preliminary investigation of the initial questionnaire before the formal survey, collecting 126 test data for analysis; moreover, the research team optimized the questionnaire by deleting five items with insufficient reliability and low factor loading, and adding two items on whether users are interested in Song Dynasty culture and whether they would like to visit offline museums. The final questionnaire consisted of 31 measurement items, as shown in Table 1.

**Table 1.** Measurement of the variables.

Constructs	Items	Explanations	Source(s)
Perceived quality	QC1	Online art exhibition content provided aesthetic information of figure painting in Song Dynasty.	[6,19]
	QC2	Online art exhibition content was easy to understand.	
	QC3	Online art exhibition content was very rich.	
	QS1	In my opinion, the color scheme of this online art exhibition was very beautiful.	
	QS2	Online art exhibition incorporated animation effects.	
	QS3	Online art exhibition screen was high definition.	
	QS4	Online art exhibition had visually appealing visuals.	
	SQ1	Online art exhibition software was easy for me to operate.	
	SQ2	Online art exhibition software was very user-friendly for me.	
Confirmation	CF1	The experience of using this online art exhibition was better than I expected.	[29]
	CF2	Online art exhibition provided me with better services than I expected.	
	CF3	The overall visual effect of the online art exhibition was better than I expected.	
CF4	Overall, my expectations for using online art exhibitions had mostly been met.		
Perceptual value	PU1	Appreciating online art exhibitions made me feel very literary value.	[29]
	PU2	It was very convenient for me to enjoy such a beautiful digital art exhibition online.	
	PU3	Overall, enjoying online art exhibitions enhanced my aesthetics.	
Perceptual enjoyment	PE1	When I was immersed in the exhibition of cultural paintings from the Song Dynasty, I did not realize the passage of time.	[29]
	PI2	The introduction of children's toys in the Song Dynasty provided me with fun.	
	PI3	The use of online art exhibitions had sparked my interest in Song Dynasty culture.	
Satisfaction	SF1	I was very satisfied with the overall experience brought by online digital art exhibition.	[29]
	SF2	Online art exhibition had brought me physical and mental relaxation, and I feel very satisfied.	
	SF3	Overall, I was very satisfied with this online digital art exhibition.	
Artistic healing	AH1	Seeing such harmonious timbre and figure painting of Song Dynasty could help me forget my troubles for a while.	[71,72]
	AH2	Seeing the Song Dynasty's "Lotus Pavilion Baby Play" made me understand the love of parents for their children from ancient times to the present, bringing me a sense of happiness.	
	AH3	Appreciating the online art exhibition of the Song Dynasty inexplicably gave me a sense of confidence, which comes from Chinese culture.	
	AH4	Online art exhibition gave me a breathing space during a busy day, allowing me to relax both physically and mentally.	
Continuing to Access Behavior	CB1	I wanted to go to the museum to enjoy the authentic figure painting of the Song Dynasty.	[29]
	CB2	I was happy to recommend it to my friends for appreciation, and if there was a chance, I would also go to the museum with my friends or family to have a look.	
	CB3	Overall, I would try to visit more offline museums in the future to experience firsthand experiences.	
	CB4	Currently, offline museums also hold such exhibitions, and I really want to go and experience them on-site.	

### 3.3. Data Collection

This study was conducted following the launch of the Chinese digital exhibition “Online Guochao Digital Special Exhibition” on CGTN in January 2023. The researchers recruited 542 participants from across China who had not previously visited the exhibition. Participants ranged in age from 18 to 60 years old and were asked to view the entire exhibition before completing the questionnaire. Informed consent was obtained from all participants, and a random sampling technique was used. A seven-point Likert scale (ranging from 1 (strongly disagree) to 7 (strongly agree)) was utilized. The study data were analyzed using SPSS 27.0 and AMOS 27.0, including Confirmatory Factor Analysis (CFA) and Structural Equation Modeling (SEM). A total of 532 responses were collected from the on-site survey and subjected to encoding analysis. Responses with missing or consistently identical answers were excluded, resulting in 512 valid questionnaires with an effective response rate of 96.24%. Table 2 presents the demographic information of the survey respondents.

**Table 2.** Respondents’ demographic information.

Measure	Items	Frequency ( <i>n</i> = 512)	Percentage
Gender	Male	241	47.1%
	Female	271	52.9%
Age	Under 20 years old	41	8%
	20~29	197	38.5%
	30~39	162	31.6%
	40~49	84	16.4%
	Above 50 years old	28	5.5%
Education	Junior college	123	24%
	Bachelor’s degree	249	48.6%
	Master’s degree or above	140	27.3%
Occupation	Student (high school, college, graduate, etc.)	142	27.7%
	Clerk	165	32.2%
	Personnel (teacher, lawyer, doctor, civil servant, etc.)	139	27.1%
	Professional	52	10.2%
	Other	14	2.7%
	Very uninterested	9	1.8%
	Uninterested	61	11.9%
Have you ever been interested in Song Dynasty culture before?	Commonly	228	44.5%
	Interested	139	27.1%
	Very interested	75	14.6%
	Very dislike	19	3.7%
Did you enjoy going to museums and exhibitions before?	Dislike	162	31.6%
	Commonly	261	51%
	Like	40	7.8%
	Very like	30	5.9%

## 4. Results

### 4.1. Common Method Deviation

The data for this study were collected from a single source (participants or respondents), and the survey method involved self-perception and self-reporting. This data collection method is susceptible to common method bias, which may arise from the shared measurement environment, contextual factors, and the characteristics of the items themselves. To mitigate the artificial covariance between the predictor and criterion variables caused by the same measurement environment, contextual factors, and item characteristics, the study adopted the approach proposed by Cham et al. [73]. During the data collection phase, the research team intentionally designed the questionnaire items for different variables on separate pages, allowing respondents to have sufficient rest between pages and reducing the common method variance resulting from using the same scale. Additionally, the research team conducted Harman’s single-factor test and exploratory factor analysis

(EFA) to examine the presence of common method bias. A total of 31 items were loaded together for the EFA, and the results showed a Kaiser–Meyer–Olkin value of 0.910, with a significance level of  $p < 0.05$ , indicating the suitability of the questionnaire data for factor analysis. The EFA revealed the presence of nine factors with eigenvalues greater than 1. Although the first unrotated principal component accounted for 34.25% of the variance, which is less than the recommended threshold of 40%, it suggests that common method bias did not have a significant impact on this study.

#### 4.2. Descriptive Analysis

The descriptive statistics of the constructs employed in the research model are summarized in Table 3.

**Table 3.** Descriptive information of the constructs used in the research model.

Construct	Mean (Standard Deviation)	Construct	Mean (Standard Deviation)
Content quality	5.739 (1.084)	Perceptual enjoyment	5.275 (1.408)
Service quality	5.644 (1.096)	Satisfaction	5.378 (1.314)
System quality	5.308 (1.358)	Artistic healing	5.298 (1.182)
Confirmation	5.444 (1.083)	Behavioral intention	5.636 (1.026)
Perceptual value	5.753 (1.140)		

#### 4.3. Measurement Model

To assess the measurement reliability and validity of our sample data, we conducted a confirmatory factor analysis (CFA) on all the item variables in our model. Convergent validity measures whether an item can effectively reflect its corresponding variable, while discriminant validity measures whether two variables have statistically significant differences [74]. Table 4 presents the values of the scale, items, standardized loadings, average variance extracted (AVE), composite reliability (CR), and Cronbach's alpha.

**Table 4.** Descriptive information of the constructs used in the research model.

Factors	Items	Cronbach's Alpha	Factor Loading	AVE	CR
Content quality	QC1	0.871	0.813	0.696	0.873
	QC2		0.880		
	QC3		0.807		
Service quality	QS1	0.912	0.863	0.721	0.912
	QS2		0.857		
	QS3		0.845		
	QS4		0.832		
System quality	SQ1	0.900	0.863	0.752	0.901
	SQ2		0.893		
	SQ3		0.844		
Confirmation	CF1	0.902	0.863	0.699	0.903
	CF2		0.847		
	CF3		0.849		
	CF4		0.784		
Artistic healing	AH1	0.913	0.823	0.725	0.913
	AH2		0.855		
	AH3		0.876		
	AH4		0.850		
Perceptual value	PU1	0.898	0.860	0.746	0.898
	PU2		0.884		
	PU3		0.847		
Perceptual enjoyment	PE1	0.914	0.861	0.780	0.914
	PE2		0.906		
	PE3		0.882		
Satisfaction	SF1	0.930	0.900	0.816	0.930
	SF2		0.903		
	SF3		0.907		
Behavioral intention	CB1	0.895	0.805	0.680	0.895
	CB2		0.837		
	CB3		0.851		
	CB4		0.804		

As shown in Table 4, all the standardized factor loadings exceed 0.7, and the t-values indicate that these factor loadings are significant at the 0.001 level. The composite reliabilities (CR) of all the variables are greater than 0.7, and the average variance extracted (AVE) is greater than 0.5 for all variables. Therefore, all the indicators in this study are higher than the standard values, indicating good convergent validity of the measurement scale [75]. Moreover, the Cronbach's alpha coefficients for each item exceed the value of 0.70 recommended by Hundleby, indicating that the scale also has good reliability [76].

Based on the analysis results presented in Table 5, it is evident that in this study's discriminant validity test, the standardized correlation coefficients between all dimensions are smaller than the square roots of the corresponding AVE values. This observation indicates that there is good discriminant validity among all the dimensions in this study.

**Table 5.** Correlation matrices and discriminant validity.

	1	2	3	4	5	6	7	8	9
Behavioral intention	<b>0.824</b>								
Satisfaction	0.420	<b>0.903</b>							
Perceptual enjoyment	0.486	0.400	<b>0.883</b>						
Perceptual value	0.483	0.361	0.348	<b>0.864</b>					
Artistic healing	0.639	0.412	0.452	0.431	<b>0.851</b>				
Confirmation	0.429	0.393	0.477	0.337	0.374	<b>0.836</b>			
System quality	0.421	0.255	0.371	0.286	0.365	0.45	<b>0.867</b>		
Service quality	0.392	0.327	0.296	0.438	0.367	0.374	0.329	<b>0.849</b>	
Content quality	0.359	0.246	0.296	0.289	0.238	0.39	0.364	0.300	<b>0.834</b>

Note: The items on the diagonal on bold represent the square roots of the AVE.

The analysis results in Table 5 clearly demonstrate that in the context of discriminant validity testing in this study, the standardized correlation coefficients between each pair of dimensions are all smaller than the square root of the average variance extracted (AVE) values corresponding to those dimensions. This finding indicates that there is good discriminant validity among the dimensions in this study.

#### 4.4. Structural Model

##### 4.4.1. Fit Indices

The fit indices for both the research model and the measurement model were computed. As presented in Table 6, these indices were considered generally acceptable based on the recommendations from previous studies.

**Table 6.** Fit indices.

Fit Indices	chi2/df	GFI	AGFI	CFI	TLI	RMSEA
Recommended values	<300	>0.900	>0.800	>0.900	>0.900	<0.080
Measurement model	1.330	0.936	0.920	0.988	0.986	0.025
Research model	1.783	0.913	0.896	0.971	0.968	0.039

As demonstrated in Table 6, all the fit indices obtained in this study surpass the recommended values, indicating that the research model employed exhibits a satisfactory fit.

##### 4.4.2. Hypothesis Tests

The path coefficients and their significance are summarized in Figure 4 and Table 7. As depicted in the figure, all 10 hypotheses were tested and supported at a significance level of 0.05. The results of this study demonstrate that users' intentions to engage in offline visits are primarily predicted by three variables: art therapy (H10,  $\beta = 0.314$ ,  $p < 0.001$ ), perceived value (H7,  $\beta = 0.508$ ,  $p < 0.001$ ), and satisfaction with enjoyment (H5,  $\beta = 0.141$ ,  $p < 0.001$ ). These variables collectively explain 48% of the variance in users' intentions to engage in offline visits.



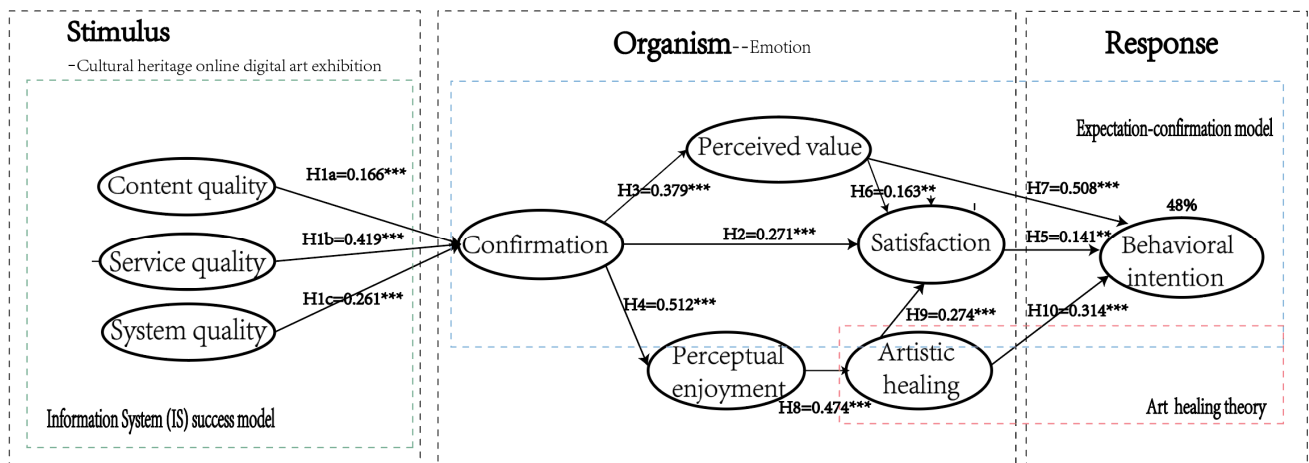

Figure 4. The research model. (Note: \*\*  $p < 0.01$ ; \*\*\*  $p < 0.001$ ).

Table 7. Fit indices and results of hypotheses test.

Hypothesis	Estimate	S.E.	C.R.	Results
H1a: Content quality → Confirmation	0.166	0.049	4.615 ***	Supported
H1b: Service quality → Confirmation	0.419	0.044	4.894 ***	Supported
H1c: System quality → Confirmation	0.261	0.038	6.441 ***	Supported
H2: Confirmation → Satisfaction	0.271	0.069	3.827 ***	Supported
H3: Confirmation → Perceptual value	0.379	0.051	7.813 ***	Supported
H4: Confirmation → Perceptual enjoyment	0.512	0.060	10.956 ***	Supported
H5: Satisfaction → Behavioral intention	0.141	0.033	3.264 **	Supported
H6: Perceptual value → Satisfaction	0.163	0.052	2.901 **	Supported
H7: Perceptual value → Behavioral intention	0.508	0.038	11.165 ***	Supported
H8: Perceptual enjoyment → Artistic healing	0.474	0.038	10.027 ***	Supported
H9: Artistic healing → Satisfaction	0.274	0.050	5.391 ***	Supported
H10: Artistic healing → Behavioral intention	0.314	0.036	7.267 ***	Supported

(Note: \*\*  $p < 0.01$ ; \*\*\*  $p < 0.001$ ).

In the Emotional Organism, perceived value (H6,  $\beta = 0.250$ ,  $p < 0.001$ ), art therapy (H9,  $\beta = 0.515$ ,  $p < 0.001$ ), and expectation confirmation (H2,  $\beta = 0.271$ ,  $p < 0.001$ ) positively influence satisfaction.

Perceived quality (H1a,  $\beta = 0.166$ ,  $p < 0.001$ ), service quality (H1b,  $\beta = 0.419$ ,  $p < 0.001$ ), and system quality (H1c,  $\beta = 0.261$ ,  $p < 0.001$ ) all have positive effects on expectation confirmation. Additionally, expectation confirmation has a positive impact on perceived value (H3,  $\beta = 0.250$ ,  $p < 0.001$ ) and satisfaction with enjoyment (H4,  $\beta = 0.474$ ,  $p < 0.001$ ).

The results of the mediation analysis are presented in Table 8. In addition to the three variables with direct effects on behavioral intention, user expectation confirmation and satisfaction have two indirect effects on users' intentions to engage in offline visits. (1) Indirect effect 1 (0.072, 95% confidence interval does not include 0): Expectation confirmation → Perceived value → Satisfaction (significant mediation effect). (2) Indirect effect 2 (0.071, 95% confidence interval does not include 0): Expectation confirmation → Perceived value → Art therapy → Satisfaction (significant mediation effect), accounting for 16.6% and 16.5% of the total effect, respectively, and acting as partial mediators.



**Table 8.** Indirect effects on intention to engage in offline visits.

Intermediate Path	Point Estimation	Product of Coef		Bootstrapping				Proportion
		SE	z	Bias-Corrected 95%CI		Percentile 95%CI		
				Lower	Upper	Lower	Upper	
Total effects	0.393	0.069	5.696	0.330	0.589	0.325	0.585	
CF → PV → SF	0.072	0.030	2.400	0.024	0.146	0.018	0.135	16.6%
CF → PE → AH → SF	0.071	0.021	3.381	0.038	0.124	0.034	0.119	16.5%
CF → SF	0.316	0.075	4.213	0.185	0.474	0.177	0.458	68.9%

## 5. Results and Discussion

The global tourism industry has been severely impacted by the COVID-19 pandemic, which is ongoing and becoming the new norm. As the world gradually recovers, stakeholders in the tourism industry are seeking policies that can facilitate its revival in this new context. Therefore, one of the primary objectives of this study is to assess the impact of online digital art exhibitions on the recovery and revitalization of the tourism industry. This study analyzes the decisive factors in visitors' on-site visitation behavior as influenced by the widespread adoption of online digital technologies during the COVID-19 pandemic. The findings, presented in Table 5, provide support for all ten of our proposed hypotheses.

This study demonstrates that the three dimensions of perceived quality in online digital art exhibitions (content quality, system quality, and service quality) are crucial in confirming visitors' expectations, with service quality having the highest impact coefficient. These findings are consistent with those of previous studies [77–79]. Specifically, the more stimuli visitors experience from online digital art exhibitions on cultural heritage, the more positive their confirmation becomes. The iconic representation of Song Dynasty figure paintings in Chinese aesthetics serves as an attraction for visitors, as the perceived visual aesthetic appeal and diverse interactive experiences stimulate higher levels of expectation confirmation. Therefore, as people's travel demands evolve, future online curators should consider leveraging the increased cognitive recognition of this type of exhibition tourism, focusing on broader sharing, more effective interactions, richer sensory experiences, and convenient information dissemination.

Secondly, the empirical results of this study reveal the existence of two mediating effects between expectation confirmation and satisfaction, which indirectly influence visitors' intentions to visit offline museums. These effects include the mediation of perceived value and enjoyment, as well as enjoyment and art therapy. This implies that perceived value, enjoyment, and art therapy are important pathways through which expectation confirmation influences satisfaction. Expectation confirmation serves as a significant motivating factor for satisfaction, and while previous studies have confirmed the impact of expectation confirmation on satisfaction [80,81], the internal process mechanism underlying the influence of expectation confirmation on satisfaction remains unclear. This study discovers that perceived value, enjoyment, and art therapy can further elucidate the relationship between expectation confirmation and satisfaction. Perceived value plays a partially mediating role in confirmation and satisfaction, which is consistent with previous research demonstrating the important link between perceived value and expectation confirmation and satisfaction [82]. Additionally, for the first time, this study reveals that expectation confirmation influences satisfaction through the mediation of enjoyment and art therapy, with remote mediation effects being significant. In other words, the higher the expectation confirmation of visitors to online cultural heritage art exhibitions, the higher their perceived enjoyment, and the greater their perception of art therapy, leading to physical relaxation and mental comfort; this, in turn, affects visitors' satisfaction with online cultural heritage digital art exhibitions. These findings indicate that the importance of expectation confirmation in ensuring satisfaction can also be understood through the mediating roles of enjoyment and art therapy.

Thirdly, this study reveals that perceived value, satisfaction, and art therapy, as latent variables, exert a positive and significant influence on visitors' offline visitation behavior.

These findings align with those of previous research [83,84], confirming the consistent impact of perceived value and satisfaction on visitors' offline visitation behavior. Moreover, this study provides support for the notion that there is a greater influence of perceived value on behavioral intention compared to satisfaction [85]. Specifically, visitors perceive online digital art exhibitions as possessing high literary and historical value, making them worth visiting. Visitors' behavioral intentions are more strongly driven by perceived value than satisfaction. Additionally, the inclusion of art therapy as a predictor of visitors' on-site visitation behavior represents a novel discovery in this study. Previous research suggests that experiencing a healing sensation from a favorable environmental stimulus strongly affects visitors' attachment to a place and behavioral intentions [86]. This indicates that the confirmation of visitors' emotions arising from the art therapy effect of online cultural heritage digital art exhibitions can effectively predict their intention to engage in on-site visitation and their attachment to the art exhibition. Although COVID-19 is gradually receding, the psychological trauma caused by the pandemic lingers and cannot be easily alleviated. However, through immersive online experiences that allow visitors to immerse themselves in Song and Yuan aesthetics, appreciate the daily culture of the Song Dynasty spanning thousands of years, interact with the exhibits, and learn new information, individuals can effectively address emotions such as anxiety, depression, and anger, thereby promoting psychological healing. Consequently, visitors are more inclined to visit offline museums and personally experience the spiritual healing that art offers.

## 6. Conclusions and Suggestions

Firstly, this study establishes a new S-O-R model based on the Expectation Confirmation Model, perceived quality, and art therapy theory. The model explains 48% of the variance in visitors' behavioral intentions to engage in on-site visitation, providing a cognitive framework to analyze the logic underlying the interaction between the perceived quality of online digital art exhibitions and on-site visitation behavior. It delves into the stimuli of perceived quality experienced by visitors through online digital art exhibitions, leading to perceptions of increased value, enjoyment, and art therapy, thereby influencing visitors' decisions to engage in physical visits. Therefore, the model developed in this study serves as empirical evidence of the benefits of using digital technology in tourism experiences and the communication of cultural heritage tourism.

Secondly, we offer an effective method to assess whether online digital art exhibitions meet visitors' expectations regarding enjoyment, value, and art therapy, thereby enhancing their likelihood of engaging in on-site visitation behavior. These research findings will enable cultural heritage tourism managers to understand visitors' motivations, allowing them to design online digital art exhibitions that cater to visitors' psychological needs and encourage them to visit on-site. This is particularly significant in the aftermath of the COVID-19 pandemic. In fact, online digital art exhibitions provide an alternative for individuals who may be interested in art exhibition content but are unable to physically attend. Furthermore, our research results may encourage web designers of online digital art exhibitions to improve the usability and aesthetics of their online interfaces. By effectively utilizing the Internet, multimedia, emotional content, and aesthetic interfaces, online digital art exhibitions can attract a larger audience and generate interest in visiting art exhibitions and environments within the cultural domain. In the digital information age, online cultural heritage art exhibitions bear the social mission of informing the public about historical civilizations and preserving cultural heritage.

Firstly, this study could provide practical insights for tourism managers, as online digital cultural tourism is a key driver in the transformation of the culture and tourism industry. With the accelerated process of digitization, blockchain-based digital art has become a new trend in the wave of digital economic development [87]. The "digital + culture" development model presents infinite possibilities for the revitalization of China's remarkable culture and the development of cultural tourism. Digital transformation has promoted the transformation and upgrading of the tourism industry. Online digital art ex-

hibitions, representing a transition from traditional offline exhibition formats to intelligent online travel experiences, are propelling the tourism industry towards greater efficiency and intelligence.

Secondly, this study provides guidance for tourism managers on the bidirectional integration of online and offline exhibition technologies. Online exhibitions focus on personalized services, offering visitors the opportunity to access and enjoy cultural and artistic activities anytime, while reducing the use of travel resources and associated environmental pressures such as carbon emissions from air travel. It significantly reduces the energy costs associated with maintaining buildings, hosting exhibitions, and travel. This is particularly beneficial for those who have limited mobility or lack economic resources for travel, thereby promoting the sustainability of the tourism industry. On the other hand, offline exhibitions emphasize quality and provide unique tourism value through interactive settings and real-time experiences. Visitor engagement in cultural and artistic activities can stimulate the local community's economic and cultural life. The integration of online and offline experiences mutually reinforces the sustainability of the tourism industry.

Thirdly, this study contributes to the understanding of how online digital technologies can revitalize historical and cultural heritage in the field of culture and tourism management. Online digital exhibitions allow developers to vividly present information on historical and cultural heritage and folk culture, urban stories, and brand concepts to visitors. This not only promotes the vitality of traditional culture and tourism industry values and commercial values, but it also satisfies the public's curiosity and thirst for knowledge through interactive experiences using digital technology. Thus, cultural heritage is effectively protected while being showcased and utilized, providing more inspiration and forms of expression for cultural heritage inheritance and development.

Furthermore, this research contributes to enhancing citizens' well-being. In the context of the post-pandemic era, online digital art exhibitions can serve as healing spaces, alleviating the pressures of temporary living, working, and studying, and nurturing psychological well-being. In this sense, online digital art exhibitions deserve attention from curators and designers. Unrestricted by space and distance, online digital art exhibitions have a large audience and wide dissemination, making them the fastest and most effective platforms for art therapy. Today's online digital art exhibitions extend beyond simply replicating offline museum and art gallery experiences. Through the integration of technology and art, they emphasize individual spiritual pleasure and freedom. Cognitive psychology also demonstrates that high-quality interactive art is more likely to enable viewers to contemplate their own existence, experience basic sensory and behavioral responses, and awaken deep emotional resonance [88]. By guiding audiences from the real world to the virtual world, a dialogue between individuals and artworks is accomplished, incorporating art exhibitions into users' lifestyles and elevating the overall spiritual and cultural development of society.

This study has several limitations that should be acknowledged. Firstly, digital technology tourism is developing rapidly worldwide, but research on this topic in China is still in its early stages. Additionally, the sample used in this study may lack diversity across ethnic and cultural backgrounds, as visitor behavior may be influenced by their ethnic culture. Therefore, the generalizability of our research findings needs to be extended to other countries with well-developed online digital exhibitions and different ethnic cultures. Secondly, due to time constraints, we relied on cross-sectional experiential data to measure customer perceptions and behavior. The internal changes that occurred among visitors remain unknown. Considering the ongoing evolution of online digital exhibition content, features, and services, as well as the advancements in technology, measurement biases resulting from time gaps may be increased. Hence, we recommend that future researchers, given sufficient funding and time, collect longitudinal empirical data to examine the interactions among different temporal variables, thereby obtaining more effective and robust validation results.

**Funding:** This research received no external funding.

**Institutional Review Board Statement:** Not applicable.

**Informed Consent Statement:** Not applicable.

**Data Availability Statement:** Not applicable.

**Acknowledgments:** The authors would like to express their sincere gratitude to the reviewers and Editor for their valuable suggestions, and the College of Art and Design of Zhejiang Guangsha Vocational and Technical University of construction and Pukyong National University for their strong support of this research.

**Conflicts of Interest:** The authors declare no conflict of interest.

## References

1. Gössling, S.; Scott, D.; Hall, C.M. Challenges of Tourism in a Low-Carbon Economy. *Wiley Interdiscip. Rev. Clim. Change* **2013**, *4*, 525–538. [CrossRef]
2. Binggeli, C.M.; Pollack, C. *COVID-19 Tourism Spend Recovery in Numbers*; McKinsey & Company: New York, NY, USA, 2020. Available online: <https://www.mckinsey.com/industries/travel-logistics-and-infrastructure/our-insights/covid-19-tourism-spend-recovery-in-numbers> (accessed on 10 June 2022).
3. Candia, S.; Pirlone, F. Tourism Environmental Impacts Assessment to Guide Public Authorities towards Sustainable Choices for the Post-COVID Era. *Sustainability* **2021**, *14*, 18. [CrossRef]
4. Toubes, D.R.; Araújo Vila, N.; Fraiz Brea, J.A. Changes in Consumption Patterns and Tourist Promotion after the COVID-19 Pandemic. *J. Theor. Appl. Electron. Commer. Res.* **2021**, *16*, 1332–1352. [CrossRef]
5. Jin, P.; Liu, Y. Fluid Space: Digitisation of Cultural Heritage and Its Media Dissemination. *Telemat. Inform. Rep.* **2022**, *8*, 100022. [CrossRef]
6. Lee, M.; Lee, S.A.; Jeong, M.; Oh, H. Quality of Virtual Reality and Its Impacts on Behavioral Intention. *Int. J. Hosp. Manag.* **2020**, *90*, 102595. [CrossRef]
7. Zhang, Y.; Han, M.; Chen, W. The Strategy of Digital Scenic Area Planning from the Perspective of Intangible Cultural Heritage Protection. *EURASIP J. Image Video Process.* **2018**, *2018*, 130. [CrossRef]
8. Huang, Y.C.; Backman, K.F.; Backman, S.J.; Chang, L.L. Exploring the Implications of Virtual Reality Technology in Tourism Marketing: An Integrated Research Framework. *Int. J. Tour. Res.* **2015**, *18*, 116–128. [CrossRef]
9. Suhartanto, D.; Dean, D.; Semiawan, T.; Kusdibyo, L.; Sobarna, A. Cognizing Tourist Loyalty during COVID-19 Pandemic through Virtual Reality Lens. *Tour. Recreat. Res.* **2021**, 1–13. [CrossRef]
10. Oncioiu, I.; Priescu, I. The Use of Virtual Reality in Tourism Destinations as a Tool to Develop Tourist Behavior Perspective. *Sustainability* **2022**, *14*, 4191. [CrossRef]
11. Li, Z.; Wang, D.; Abbas, J.; Hassan, S.; Mubeen, R. Tourists' Health Risk Threats amid COVID-19 Era: Role of Technology Innovation, Transformation, and Recovery Implications for Sustainable Tourism. *Front. Psychol.* **2022**, *12*, 769175. [CrossRef]
12. Elkhwesky, Z.; El Manzani, Y.; Elbayoumi Salem, I. Driving Hospitality and Tourism to Foster Sustainable Innovation: A Systematic Review of COVID-19-Related Studies and Practical Implications in the Digital Era. *Tour. Hosp. Res.* **2022**, 146735842211267. [CrossRef]
13. Chhabra, D. Transformational Wellness Tourism System Model in The Pandemic Era. *Int. J. Health Manag. Tour.* **2020**, *5*, 76–101. [CrossRef]
14. Bruinen de Bruin, Y.; Lequarre, A.-S.; McCourt, J.; Clevestig, P.; Pigazzani, F.; Zare Jeddi, M.; Colosio, C.; Goulart, M. Initial Impacts of Global Risk Mitigation Measures Taken during the Combatting of the COVID-19 Pandemic. *Saf. Sci.* **2020**, *128*, 104773. [CrossRef]
15. UNESCO Museums around the World in the Face of COVID-19. Available online: <https://unesdoc.unesco.org/ark:/48223/pf0000373530> (accessed on 5 March 2023).
16. Wilson, S.D. *Information Arts: Intersections of Art, Science, and Technology*; MIT Press: Cambridge, MA, USA, 2001.
17. DeLone, W.H.; McLean, E.R. The DeLone and McLean Model of Information Systems Success: A Ten-Year Update. *J. Manag. Inf. Syst.* **2003**, *19*, 9–30.
18. Zeithaml, V.A. Consumer Perceptions of Price, Quality, and Value: A Means-End Model and Synthesis of Evidence. *J. Mark.* **1988**, *52*, 2–22. [CrossRef]
19. Jung, T.; Chung, N.; Leue, M.C. The Determinants of Recommendations to Use Augmented Reality Technologies: The Case of a Korean Theme Park. *Tour. Manag.* **2015**, *49*, 75–86. [CrossRef]
20. Rizal, H.; Yussof, S.; Amin, H.; Ku, C.-J. EWOM towards Homestays Lodging: Extending the Information System Success Model. *J. Hosp. Tour. Technol.* **2018**, *9*, 94–108. [CrossRef]
21. Wang, Y.-S.; Lin, S.; Li, C.-R.; Tseng, T.H.; Li, H.-T.; Lee, J.-Y. Developing and Validating a Physical Product E-Tailing Systems Success Model. *Inf. Technol. Manag.* **2017**, *19*, 245–257. [CrossRef]
22. Wang, Y.-S.; Tseng, T.H.; Wang, W.-T.; Shih, Y.-W.; Chan, P.-Y. Developing and Validating a Mobile Catering App Success Model. *Int. J. Hosp. Manag.* **2019**, *77*, 19–30. [CrossRef]

23. Aldholay, A.H.; Isaac, O.; Abdullah, Z.; Ramayah, T. The Role of Transformational Leadership as a Mediating Variable in DeLone and McLean Information System Success Model: The Context of Online Learning Usage in Yemen. *Telemat. Inform.* **2018**, *35*, 1421–1437. [CrossRef]
24. Do, H.-N.; Shih, W.; Ha, Q.-A. Effects of Mobile Augmented Reality Apps on Impulse Buying Behavior: An Investigation in the Tourism Field. *Heliyon* **2020**, *6*, e04667. [CrossRef]
25. Chen, L. The Quality of Mobile Shopping System and Its Impact on Purchase Intention and Performance. *Int. J. Manag. Inf. Technol.* **2013**, *5*, 23–32. [CrossRef]
26. Zhao, L.; Lu, Y.; Zhang, L.; Chau, P.Y.K. Assessing the Effects of Service Quality and Justice on Customer Satisfaction and the Continuance Intention of Mobile Value-Added Services: An Empirical Test of a Multidimensional Model. *Decis. Support Syst.* **2012**, *52*, 645–656. [CrossRef]
27. Joo, S.; Choi, N. Understanding Users' Continuance Intention to Use Online Library Resources Based on an Extended Expectation-Confirmation Model. *Electron. Libr.* **2016**, *34*, 554–571. [CrossRef]
28. Park, E. User Acceptance of Smart Wearable Devices: An Expectation-Confirmation Model Approach. *Telemat. Inform.* **2020**, *47*, 101318. [CrossRef]
29. Bhattacharjee, A. Understanding Information Systems Continuance: An Expectation Confirmation Model. *MIS Q.* **2001**, *25*, 351–370. [CrossRef]
30. Hong, S.; Thong, J.Y.L.; Tam, K.Y. Understanding Continued Information Technology Usage Behavior: A Comparison of Three Models in the Context of Mobile Internet. *Decis. Support Syst.* **2006**, *42*, 1819–1834. [CrossRef]
31. Mason, M.C.; Nassivera, F. A Conceptualization of the Relationships between Quality, Satisfaction, Behavioral Intention, and Awareness of a Festival. *J. Hosp. Mark. Manag.* **2013**, *22*, 162–182. [CrossRef]
32. Hsu, C.-L.; Lin, J.C.-C. What Drives Purchase Intention for Paid Mobile Apps?—An Expectation Confirmation Model with Perceived Value. *Electron. Commer. Res. Appl.* **2015**, *14*, 46–57. [CrossRef]
33. Baker, D.A.; Crompton, J.L. Quality, Satisfaction and Behavioral Intentions. *Ann. Tour. Res.* **2000**, *27*, 785–804. [CrossRef]
34. Chen, C.-F.; Chen, F.-S. Experience Quality, Perceived Value, Satisfaction and Behavioral Intentions for Heritage Tourists. *Tour. Manag.* **2010**, *31*, 29–35. [CrossRef]
35. Vena-Oya, J.; Castañeda-García, J.A.; Rodríguez-Molina, M.Á.; Frías-Jamilena, D.M. How Do Monetary and Time Spend Explain Cultural Tourist Satisfaction? *Tour. Manag. Perspect.* **2021**, *37*, 100788. [CrossRef]
36. Chen, Y.-Y.; Huang, H.-L.; Hsu, Y.-C.; Tseng, H.-C.; Lee, Y.-C. Confirmation of Expectations and Satisfaction with the Internet Shopping: The Role of Internet Self-Efficacy. *Comput. Inf. Sci.* **2010**, *3*, p14. [CrossRef]
37. Lin, T.-C.; Wu, S.; Hsu, J.S.-C.; Chou, Y.-C. The Integration of Value-Based Adoption and Expectation-Confirmation Models: An Example of IPTV Continuance Intention. *Decis. Support Syst.* **2012**, *54*, 63–75. [CrossRef]
38. Lee, H.S. Major Moderators Influencing the Relationships of Service Quality, Customer Satisfaction and Customer Loyalty. *Asian Soc. Sci.* **2013**, *9*, 1. [CrossRef]
39. Halilovic, S.; Cicic, M. Antecedents of Information Systems User Behaviour—Extended Expectation-Confirmation Model. *Behav. Inf. Technol.* **2013**, *32*, 359–370. [CrossRef]
40. Oliver, R.L. A Cognitive Model of the Antecedents and Consequences of Satisfaction Decisions. *J. Mark. Res.* **1980**, *17*, 460–469. [CrossRef]
41. Nowacki, M.M. Quality of Visitor Attractions, Satisfaction, Benefits and Behavioural Intentions of Visitors: Verification of a Model. *Int. J. Tour. Res.* **2009**, *11*, 297–309. [CrossRef]
42. Piancatelli, C.; Massi, M.; Vocino, A. The Role of Atmosphere in Italian Museums: Effects on Brand Perceptions and Visitor Behavioral Intentions. *J. Strateg. Mark.* **2020**, *29*, 546–566. [CrossRef]
43. Chen, C.-F.; Kao, Y.-L. Relationships between Process Quality, Outcome Quality, Satisfaction, and Behavioural Intentions for Online Travel Agencies—Evidence from Taiwan. *Serv. Ind. J.* **2010**, *30*, 2081–2092. [CrossRef]
44. Bello, D.C.; Etzel, M.J. The Role of Novelty in the Pleasure Travel Experience. *J. Travel Res.* **1985**, *24*, 20–26. [CrossRef]
45. Boksberger, P.E.; Melsen, L. Perceived Value: A Critical Examination of Definitions, Concepts and Measures for the Service Industry. *J. Serv. Mark.* **2011**, *25*, 229–240. [CrossRef]
46. Woodruff, R.B. Customer Value: The next Source for Competitive Advantage. *J. Acad. Mark. Sci.* **1997**, *25*, 139–153. [CrossRef]
47. Murphy, P.; Pritchard, M.P.; Smith, B. The Destination Product and Its Impact on Traveller Perceptions. *Tour. Manag.* **2000**, *21*, 43–52. [CrossRef]
48. Sánchez-Fernández, R.; Iniesta-Bonillo, M.Á. The Concept of Perceived Value: A Systematic Review of the Research. *Mark. Theory* **2007**, *7*, 427–451. [CrossRef]
49. Khuong, M.N.; Phuong, N.T. The Effects of Destination Image, Perceived Value, and Service Quality on Tourist Satisfaction and Word-of-Mouth — a Study in Ho Chi Minh City, Vietnam. *Int. J. Trade Econ. Financ.* **2017**, *8*, 217–224. [CrossRef]
50. Gallarza, M.G.; Gil Saura, I. Value Dimensions, Perceived Value, Satisfaction and Loyalty: An Investigation of University Students' Travel Behaviour. *Tour. Manag.* **2006**, *27*, 437–452. [CrossRef]
51. Wei, B.; Yang, T.; Liu, C.-H. "Can Intelligence Make You Happy?" the Influence of Tourists' Cultural Sustainability and Intelligence on Their Flow Experience. *Sustainability* **2021**, *13*, 12457. [CrossRef]
52. Chen, C.-F. Investigating Structural Relationships between Service Quality, Perceived Value, Satisfaction, and Behavioral Intentions for Air Passengers: Evidence from Taiwan. *Transp. Res. Part A Policy Pract.* **2008**, *42*, 709–717. [CrossRef]

53. Cronin, J.J.; Brady, M.K.; Hult, G.T.M. Assessing the Effects of Quality, Value, and Customer Satisfaction on Consumer Behavioral Intentions in Service Environments. *J. Retail.* **2000**, *76*, 193–218. [CrossRef]
54. Pura, M. Linking Perceived Value and Loyalty in Location-Based Mobile Services. *Manag. Serv. Qual. Int. J.* **2005**, *15*, 509–538. [CrossRef]
55. IGBARIA, M.; SCHIFFMAN, S.J.; WIECKOWSKI, T.J. The Respective Roles of Perceived Usefulness and Perceived Fun in the Acceptance of Microcomputer Technology. *Behav. Inf. Technol.* **1994**, *13*, 349–361. [CrossRef]
56. Thong, J.Y.L.; Hong, S.-J.; Tam, K.Y. The Effects of Post-Adoption Beliefs on the Expectation-Confirmation Model for Information Technology Continuance. *Int. J. Hum. Comput. Stud.* **2006**, *64*, 799–810. [CrossRef]
57. Gashoot, M.M. Holistic Healing Framework: Impact of the Physical Surrounding Design on Patient Healing and Wellbeing. *Art Des. Rev.* **2022**, *10*, 18–28. [CrossRef]
58. Ulrich, R.S. Aesthetic and Affective Response to Natural Environment. *Behav. Nat. Environ.* **1983**, *6*, 85–125. [CrossRef]
59. Day, C. *Places of the Soul: Architecture and Environmental Design as a Healing Art*; Aquarian/Thorsons: London, UK, 1993; ISBN 9781855383050.
60. Malchioldi, C.A.; Lippin, R.A. *Medical Art Therapy with Adults*; Jessica Kingsley Publishers: London, UK, 2000; ISBN 9781853026799.
61. Chen, B. Research on the Experience of Interactive Art from the Perspective of Reception Aesthetics. In Proceedings of the 6th International Conference on Arts, Design and Contemporary Education (ICADCE 2020), Moscow, Russia, 29–30 December 2020. [CrossRef]
62. Prinzhorn, H. *Artistry of the Mentally Ill*; Springer Science & Business Media: Berlin/Heidelberg, Germany, 2013; ISBN 9783662009161.
63. Wei, Z.; Zhong, C.; Gao, Y. Art Therapy Practices in Museum Education: A Mini Review. *Front. Psychol.* **2023**, *13*, 1075427. [CrossRef] [PubMed]
64. Harris, P.B.; McBride, G.; Ross, C.; Curtis, L. A Place to Heal: Environmental Sources of Satisfaction among Hospital Patients. *J. Appl. Soc. Psychol.* **2002**, *32*, 1276–1299. [CrossRef]
65. Amorim, J.P.; Teixeira, L. Art in the Digital during and after COVID: Aura and Apparatus of Online Exhibitions. *Rupkatha J. Interdiscip. Stud. Humanit.* **2020**, *12*, 1–8. [CrossRef]
66. Whitehouse, S.; Varni, J.W.; Seid, M.; Cooper-Marcus, C.; Ensberg, M.J.; Jacobs, J.R.; Mehlenbeck, R.S. Evaluating A Children’s Hospital Garden Environment: Utilization and Consumer Satisfaction. *J. Environ. Psychol.* **2001**, *21*, 301–314. [CrossRef]
67. Zhang, Y. The Application of Earth Art in the Landscape Design of Public Space. *Highlights Art Des.* **2023**, *2*, 49–53. [CrossRef]
68. Zhang, H.; Nguyen-Dinh, N.; Hussein, H.; Ho, H.-W. The Effect of Healing Perception on the Visitors’ Place Attachment and Their Loyalty toward a Metropolitan Park—Under the Aspect of Environmental Design. *Int. J. Environ. Res. Public Health* **2022**, *19*, 7060. [CrossRef]
69. Kreitler, H.; Kreitler, S. Art Therapy: Quo Vadis? *Art Psychother.* **1978**, *5*, 199–209. [CrossRef]
70. He, J. *The Construction of Confucianism in the Southern Song Dynasty*; Shanghai People’s Publishing House: Shanghai, China, 2004.
71. Haeyen, S.; Noorthoorn, E. Validity of the Self-Expression and Emotion Regulation in Art Therapy Scale (SERATS). *PLoS ONE* **2021**, *16*, e0248315. [CrossRef] [PubMed]
72. Gantt, L.M. The Formal Elements Art Therapy Scale: A Measurement System for Global Variables in Art. *Art Ther.* **2001**, *18*, 50–55. [CrossRef]
73. Cham, T.H.; Cheng, B.L.; Low, M.P.; Cheok, J.B.C. Brand Image as the Competitive Edge for Hospitals in Medical Tourism. *Eur. Bus. Rev.* **2020**; ahead of print. [CrossRef]
74. Anderson, J.C.; Gerbing, D.W. Structural Equation Modeling in Practice: A Review and Recommended Two-Step Approach. *Psychol. Bull.* **1988**, *103*, 411–423. [CrossRef]
75. Bagozzi, R.P.; Yi, Y. On the Evaluation of Structural Equation Models. *J. Acad. Mark. Sci.* **1988**, *16*, 74–94. [CrossRef]
76. Nunnally, J.C.; Bernstein, I.H. *Psychometric Theory*, 3rd ed.; Tata Mcgraw-Hill Ed: New Delhi, India, 1994; ISBN 9780071070881.
77. Roca, J.C.; Chiu, C.-M.; Martínez, F.J. Understanding E-Learning Continuance Intention: An Extension of the Technology Acceptance Model. *Int. J. Hum. Comput. Stud.* **2006**, *64*, 683–696. [CrossRef]
78. Poister, T.H.; Thomas, J.C. The Effect of Expectations and Expectancy Confirmation/Disconfirmation on Motorists’ Satisfaction with State Highways. *J. Public Adm. Res. Theory* **2011**, *21*, 601–617. [CrossRef]
79. Biswas, K.M.; Nusari, M.; Ghosh, A. The Influence of Website Service Quality on Customer Satisfaction towards Online Shopping: The Mediating Role of Confirmation of Expectation. *Int. J. Manag. Sci. Bus. Adm.* **2019**, *5*, 7–14. [CrossRef]
80. Kim, D.J. An Investigation of the Effect of Online Consumer Trust on Expectation, Satisfaction, and Post-Expectation. *Inf. Syst. e-Bus. Manag.* **2010**, *10*, 219–240. [CrossRef]
81. Lee, M.-C. Explaining and Predicting Users’ Continuance Intention toward E-Learning: An Extension of the Expectation–Confirmation Model. *Comput. Educ.* **2010**, *54*, 506–516. [CrossRef]
82. Chung, N.; Lee, H.; Kim, J.-Y.; Koo, C. The Role of Augmented Reality for Experience-Influenced Environments: The Case of Cultural Heritage Tourism in Korea. *J. Travel Res.* **2017**, *57*, 627–643. [CrossRef]
83. Jin, N.P.; Lee, S.; Lee, H. The Effect of Experience Quality on Perceived Value, Satisfaction, Image and Behavioral Intention of Water Park Patrons: New versus Repeat Visitors. *Int. J. Tour. Res.* **2013**, *17*, 82–95. [CrossRef]
84. Cheng, T.-M.; Lu, C.-C. Destination Image, Novelty, Hedonics, Perceived Value, and Revisiting Behavioral Intention for Island Tourism. *Asia Pac. J. Tour. Res.* **2013**, *18*, 766–783. [CrossRef]

85. Patwardhan, V.; Ribeiro, M.A.; Payini, V.; Woosnam, K.M.; Mallya, J.; Gopalakrishnan, P. Visitors' Place Attachment and Destination Loyalty: Examining the Roles of Emotional Solidarity and Perceived Safety. *J. Travel Res.* **2019**, *59*, 3–21. [CrossRef]
86. Majeed, S.; Ramkissoon, H. Health, Wellness, and Place Attachment during and Post Health Pandemics. *Front. Psychol.* **2020**, *11*, 573220. [CrossRef]
87. Dung, N.T.; Tri, N.M.; Minh, L.N. Digital Transformation Meets National Development Requirements. *Linguist. Cult. Rev.* **2021**, *5*, 892–905. [CrossRef]
88. Seeley, W.P. Naturalizing Aesthetics: Art and the Cognitive Neuroscience of Vision. *J. Vis. Art Pract.* **2006**, *5*, 195–213. [CrossRef]

**Disclaimer/Publisher's Note:** The statements, opinions and data contained in all publications are solely those of the individual author(s) and contributor(s) and not of MDPI and/or the editor(s). MDPI and/or the editor(s) disclaim responsibility for any injury to people or property resulting from any ideas, methods, instructions or products referred to in the content.

## Article

# The Impact of Perceived Quality of Government Subsidies on Residents' Travel Intention Post-COVID-19 in Wuhan, China

Yajuan Dong \*, Yi Jin and Khan Anwar Kamal

School of Economics and Management, Chang'an University, Xi'an 710064, China

\* Correspondence: yajuand@chd.edu.cn

**Abstract:** To stimulate tourism demand and promote internal circulation, government subsidy policies have been introduced in many places in recent years due to public health concerns. In this paper, we propose a mechanistic model of the impact of the perceived quality of government subsidies on the travel intentions of residents based on consumer perception. Data were collected from Wuhan, China for empirical analysis. The results of this study showed that the perceived quality of government subsidies influenced travel intentions through the perceived behavioral control of travel consumers. Government subsidies were more likely to promote perceived behavioral control among residents with higher public health concerns, and their willingness to travel was stronger. Predicted risks undermine the positive effect of the perceived quality of government subsidies on travel intentions. The analysis suggested that a precise implementation of subsidy policies can enhance the efficiency of effects. We are keen to help China's tourism market sustain growth in the post-COVID-19 period.

**Keywords:** government subsidies; perceived quality; perceived behavioral control; predicted risks; travel intention



**Citation:** Dong, Y.; Jin, Y.; Anwar Kamal, K. The Impact of Perceived Quality of Government Subsidies on Residents' Travel Intention Post-COVID-19 in Wuhan, China. *Sustainability* **2023**, *15*, 10812. <https://doi.org/10.3390/su151410812>

Academic Editors: Zygmunt Kruczek and Bartłomiej Walas

Received: 10 May 2023

Revised: 6 July 2023

Accepted: 7 July 2023

Published: 10 July 2023



**Copyright:** © 2023 by the authors. Licensee MDPI, Basel, Switzerland. This article is an open access article distributed under the terms and conditions of the Creative Commons Attribution (CC BY) license (<https://creativecommons.org/licenses/by/4.0/>).

## 1. Introduction

Tourism is a highly volatile industry, and any occurrence involving public safety may have a noticeable effect on demand for travel. Following the COVID-19 pandemic, China's tourism industry has witnessed an economic re-growth. The government can play a top-level design, policy guidance and macro-control role in tourism recovery [1]. The country has proposed an abundance of rules and regulations on both the supply and demand sides of the industry to help the industry recover due to the epidemic's long-lasting and significant effects on the travel and tourism industry. Tourism is a cross-industry activity that involves "food, accommodation, public transportation, travel, shopping, and entertainment". The State Ministry of Culture and Tourism originally unveiled a tax subsidy program for the four primary sectors of transportation, hospitality, lodging, and tourism in February 2020. This policy is focused on ensuring the survival of supply-side businesses. The "14th Five-Year Plan" for tourism development, which the State Council issued in 2021, provided more encouragement for local governments to create policies that would benefit the general population and boost domestic demand in order to strengthen economic circulation. When the pandemic was under control and steady, China began to allocate external stimulants on the supply side to increase tourist spending. The state's macro-policy acts as the basis for the subsidy policy, which is carried out by the provinces and municipalities. As of now, governments in China frequently adopt steps, such as offering coupons for discounts on tickets and cultural tourism consumption. The "government-business cooperation" strategy, or the government-led organization's collaborative distribution, is typically used to fund subsidy programs. Both consumers and businesses are benefited by the policy. Various subsidy policies are developed by each region in accordance with its distinctive economic, social, and other considerations.



It has been shown that public health issues negatively affected the national economy, and the decline of the population's income has led to a relative reduction in the spending budget and a lower willingness to travel [2]. For the purpose of assisting the tourism industry's recovery, numerous research have been carried out both domestically and abroad. Numerous international academics have researched traveler behavior intentions in the context of the outbreak in addition to the impact on tourism in multiple countries and recovery strategies. For example, tourists with different personality traits have different levels of risk perception [3–5]. The perception of risk [6] and anxiety [7,8] leads to a change in typical travel behavior. The contribution of the policy to the revival of the tourism industry has received increased attention from domestic practitioners.

Sheng et al. [9] believed that the severity of the shock depends on the strength of the policy hedge. He proposed that measures such as boosting travelers' purchasing potential and issuing electronic consumption vouchers can help stimulate market dynamics. Peng [10] used network text analysis to classify policies and found that the top three policy types were security, a combination of security and feasibility, and a combination of security and economy. Safety and feasibility measures adopted by the government are preconditions for travel, and economic measures play a facilitating role. All of the above studies consider subsidy policies as an effective way for market economy recovery. The coordination of supply and demand in the market contributes to the functional adjustment of the tourism system and restores the resilience of tourism [11]. Empirical evidence on the effects of government subsidies and the mechanisms of their effects focus on the supply side of the enterprise. For example, Wang et al. [12] analyzed data on listed companies and found that organizational resilience capacity strengthens the role of government subsidies in promoting firm survival. Shan et al. [13] found that the best method of cooperation between enterprises and the government is in jointly issuing consumption vouchers. The majority of recent research on government subsidies has concentrated on how they affect the supply-side economy's output efficiency, although there are distinctions between the ways that enterprises and travelers are impacted and the mechanisms by which they are acted upon. The effects of consumption vouchers for cultural tourism have not been extensively examined in studies on the demand side because they have mostly focused on the field of consumption vouchers. These studies have not taken into account the analysis of consumer-focused subsidy schemes or other forms of subsidies like ticket discounts. Furthermore, few scholars examined tourists' true perceptions based on primary data, preferring to use secondary data to determine the economic impact of subsidies. While confirming that attitudes toward tourism policies can influence travel intentions, Zhang et al. [14] focused on describing tourists' willingness to accept various policies during their travels, resulting in a lack of an evaluation of the various aspects of subsidized policies and making it difficult to improve policy quality based on research. The impact of consumer-oriented government subsidies on travel intentions warrants additional investigation. In conclusion, this paper combined the effect of shocks brought on by public health issues and the psychological risk faced by travelers, and introduced perceived behavior control, predicted risk, and public health concern to explore the impact of the perceived quality of government subsidies on travel intention. The objective of this paper is to explain the micro-penetration mechanism of government subsidies and travel intention in the context of the pandemic. From a theoretical standpoint, it enhances the understanding of the role of government travel grants under the umbrella of public health worries; from an economic perspective, it provides a direction for the enhancement of the growth of domestic demand in the tourism market under the new situation and helps the tourism economy recover sustainably.

The organizational structure of this article is as follows. Following the introduction, the next section discusses the pertinent theoretical underpinnings and the literature evidence for the study variables and models. The third section initially provides a brief overview of the questionnaire by investigating its reliability, validity, and the responses received for each question. To determine whether the mediating moderating effect is still present, the

fourth portion analyzes the empirical model. The “Discussion” and “Conclusions” are covered in the Sections 5 and 6.

## 2. Literature Review and Hypothesis Research

### 2.1. Perceived Quality of Government Subsidies

Government subsidies act on consumers and producers to produce various consumer and producer surpluses, and the macro-policy is an “invisible hand” that controls the equilibrium of the markets. As a result, it is important to investigate the policy’s target, impact mechanism, and effect. According to Liu et al. [15], based on an analysis of the central and local governments’ tourism policy documents from 2008 to 2019, the current tourist policies are mostly focused on the innovation and reform of the tourism industry. These regulations primarily standardize the operation of the travel industry and the prevention and control of travel security from the supply side, but they lack regulations that encourage demand-side trip spending. Wang et al. [16] concluded that although some preferential policies, such as distributing consumption vouchers, appear crucial for encouraging tourism, policies that are specifically targeted toward tourists’ needs are the most successful. The majority of the research that has been conducted on state strategies involving taxes, levies, and loan subsidies for tourism businesses focused on the results of their deployment. It is reasonable to assume that the effect of the subsidy policy on consumers is also related to its acceptance, but Liu [17] argued that the effectiveness of the government’s tax incentives and financial subsidies depends on the acceptance of the policy by enterprises and the intensity of its implementation. It is vital to determine the objective of government subsidies from a subjective standpoint by using the definition of “perceived quality” because there are discrepancies between how the policy is actually being implemented and what tourists actually perceive. Consumers’ subjective evaluations of the product were used to determine perceived quality by both Steenkamp [18] and Wang Peng [19]. The perceived quality of government subsidies in the study was defined as follows, with reference to Fan et al.’s [20] definition of the term “quality of public policy”: “From the subjective perception of consumers, whether the various government subsidies for tourism are meeting their need, they will make an assessment.” Garvin [21] measured the perceived quality in terms of three dimensions: usability, safety, and reliability. Wang et al. [22], in their investigation of the PV subsidy policy, identified three criteria: advocacy, benefit, and stability. As a result, the perceived benefit and perceived stability of government subsidies have been split into two aspects in this study.

### 2.2. Perceived Quality of Government Subsidies and Travel Intention

Since the COVID-19 pandemic, national and local governments have implemented a number of subsidy schemes to assist tourism businesses in overcoming challenges and have also conducted a number of actions to increase traveler demand. However, less research has examined how government subsidies affect consumers. Qiu [23,24] argued that in the supply chain, consumers prefer subsidies to act directly on them and believe such subsidies benefit from them. Tourism subsidy policy is also a supply chain, with government and business working together to achieve the policy implemented. And the effect is different whether the policy is implemented by consumers or companies. There were even less studies of consumer-oriented subsidy policies in the tourism industry, as existing studies have focused on the segmentation of consumption vouchers. Most domestic scholars conducted empirical studies on the effect of consumption vouchers based on macro-data, and have confirmed that the government providing subsidies to residents by issuing consumption vouchers is significant in stimulating tourism consumption. Lin et al. [25] projected that the issuing of consumption vouchers could increase the number of industry transactions by 26.26% compared to areas where no vouchers were issued. Li [26] believed that consumption vouchers have boosted the boom in tourism and its related industries. Sun et al. [27] believed that even if the government issued consumer vouchers several times over a long period of time, it will still be effective in stimulating consumption. Wang [28]

argued that consumption vouchers are effective in boosting consumers' confidence and promoting consumption through an analysis of Weibo data. These studies discussed the consumption vouchers of various industries as a whole, but there were no studies that analyzed the effects of the implementation of domestic cultural tourism consumption vouchers. Foreign scholars' studies on consumer-oriented subsidy policies have focused on Japan's "go-to-travel" policy, such as Tagashira Takumi [29], who found that individuals who did not qualify for the subsidy traveled more after the subsidy was implemented. Matsuura T et al. [30] confirmed the effectiveness of the price-discounting strategy in mitigating the economic losses caused by the pandemic to the Japanese accommodation industry. Therefore, it is conceivable that a variety of government subsidies, such as consumption vouchers, may be useful in promoting travel and the rebirth of the tourism industry. The following assumptions were made based on the consumer's perspective that the perceived quality of government subsidies can affect their desire to travel:

**H1.** *A perceived quality of government subsidies positively influences travel intention.*

**H1a.** *A perceived benefit of government subsidies positively influences travel intention.*

**H1b.** *A perceived stability of government subsidies positively influences travel intention.*

### 2.3. The Mediating Role of Perceived Behavioral Control

According to the S-O-R theory, psychological reactions to environmental stimuli could affect how people behave. Government subsidies are external impulses for the general population. Potential travelers' assessments of their capacity to learn about policies and take advantage of their benefits when given policy knowledge as a stimulant affect their motivation to proceed further.

Huang Chunhui [31], based on MGB theory in major public health events, researched that perceived behavioral control can have a positive effect on the travel intention. In corporate investment behavior, the strength of a firm's financing constraints can influence the role between unstable economic policies and investment behavior [32]. Individuals' compliance with the policy aim may be influenced by how consistently the policy is being implemented. The firm's financial limitations are comparable to personal behavior controls in terms of its transitory nature. Hye-Kyung Bae [33] revealed that the relationship between cosmetic quality and buying intent can be mediated by perceived behavioral control. The following idea was then put forth by extending the aforementioned mechanism to the perception of the quality of government subsidies:

**H2.** *Perceived behavioral control mediates between a perceived quality of government subsidies and travel intention.*

**H2a.** *Perceived behavioral control mediates between a perceived benefit of government subsidies and travel intention.*

**H2b.** *Perceived behavioral control mediates between a perceived stability of government subsidies and travel intention.*

### 2.4. The Moderating Role of Public Health Concerns

Potential visitors must travel across regions because of the property of the tourism supply, and the movement and gathering of people can easily result in the spread of infectious diseases. The potential for tourism consumption in China at present is enormous, and the country's citizens are eager to travel. However, people's perceptions of the importance of public health vary, which affects how difficult it is to plan trips. Before engaging in tourism activities, hesitant or weak potential travelers are less sensitive to external cues. In the instance of COVID-19, the disease has given rise to a phenomena known as "anti-globalization", in which travel destinations have not only failed to work together but have also become further dispersed from one another [34]. From initial ignorance and psychological panic to an effective management of the outbreak, the public's overall concern about

the outbreak has decreased from the initial level. They became more positive overall and more optimistic in future expectations, but there were differences in the level of concern among different groups, resulting in different levels of desired effects [35]. Different sources of information regarding the pandemic and varying degrees of public knowledge of the outbreak's risks would also influence how the public copes [36]. Bai Lan [37] suggested that stock markets are unpredictable because investors' anxieties about the pandemic change over time, affecting their investing decisions. At the onset of a public health outbreak, investor attention had a significant "early warning" effect on the performance of the stock market in our sector. This means that the level of attention only at the outbreak's onset will cause investors to behave with greater caution. This indicated that various levels of public health concern can play a role in the event and its psychological impact on the population, but this effect is only negative in the early stages.

When the epidemic was under control, residents were generally optimistic about the government's subsidy policy and the likelihood of receiving subsidies in the context of current public health concerns. Concerned groups vary in their degree of optimism regarding the "government subsidies access to government subsidies" approach. In other words, public health concern moderates the relationship between the perceived quality of government subsidies and perceived behavioral control. Hence, the hypothesis is stated:

**H3.** *Public health concerns play a moderating role in the perceived quality of government subsidies and perceived behavioral control.*

#### 2.5. The Moderating Effect of Predicted Risk

Risk has been a hot topic of discussion in tourism research. In Flynn's [38] study, it was noted that individuals' behavior intentions are influenced by subjective perceptions of risk. Riittichainuwat [39], on the other hand, found that tourists do not cancel their plans in the face of sudden illness or terrorist events, but change their original plans to travel to areas with low risk. In the process of foreign investment, Wang et al. [40] confirmed the moderating effect of aggregate risk on trade effects, the higher the comprehensive risk level of the host country, the stronger the trade creation effect of China's OFDI in countries along the "Belt and Road". In the act of travel, the risk is always to weaken the intention to travel. In tourism activities, Zhang et al. [41] verified that tourists' perceived risk is an important antecedent of tourists' behavior intentions and suggested that incentives should be taken to attract a portion of tourists first. Gou et al. [42] further considered the impact of perceived risk on travel under different periods and argued that the stage of risk leads to variability in behavior outcomes. Caber et al. [43] verified that risk perception has a negative moderating effect on the relationship between travel motivation, destination image, and travel intention. Through focusing on the potential risks of visitors' prediction, such as disapproval and differential treatment by businesses, and referring to this mental process as "predicted risks", subsidy policy as an external stimulus influences the propensity to travel via perceived behavioral control, and anticipating risk moderates this effect. The following hypotheses were therefore proposed:

**H4.** *Predicted risks moderate between perceived behavioral control and travel intention.*

**H5.** *Predicted risks moderate the relationship between the perceived quality of government subsidies and travel intention.*

#### 2.6. Model Construction

**In a sense, the act of traveling is also a consumer act, and travelers' purchases of tour route products and tickets from travel agencies are comparable to purchases made in shopping malls. In consumer behavior, the S-O-R theory and the theory of planned behavior are frequently utilized to model purchase decisions, and the two theories share similarities. S-O-R, or stimulus–organism–behavior response, is a theory that describes a succession of psychological motivations that cause individuals to make behavioral decisions in response to external stimuli. In the theory of planned behavior, there is also a path**

of “Facilitator–Perceived–Behavior Control–Behavioral Intention”, and the combination of the two can be thought of as the individual perceiving the facilitator (stimulus), the perceived behavioral control (organism), and the behavioral intention to produce changes (behavioral response).

Guan Rongwei [44] mentioned that the stimuli recognized by domestic and foreign scholars include perceived quality and value. The notion of perceived quality of subsidy policy is developed in this study through the concept of product quality and measuring government subsidies, as was already described in Section 2.1. Combining these two theories results in a model where the perceived behavioral control serves as the mediating variable, the willingness to travel serves as the dependent variable, and the perceived quality of the subsidy program serves as the independent variable. Additionally, as stated in the background and discussion in Section 2.4, one of the goals of the government’s subsidy policy is to lessen the pandemic’s negative effects on the tourism industry. Accordingly, external stimuli have varying psychological effects on the populace, depending on their level of concern. As a result, the concern for public health was added as a moderating factor. Furthermore, it is well-known that studies on epidemics have focused on risk, and Section 2.5 elaborates on the idea that different degrees of predicted risk can eventually have varied effects on the intensity of travel intentions.

The analysis presented above leads to the model that is suggested: Figure 1.

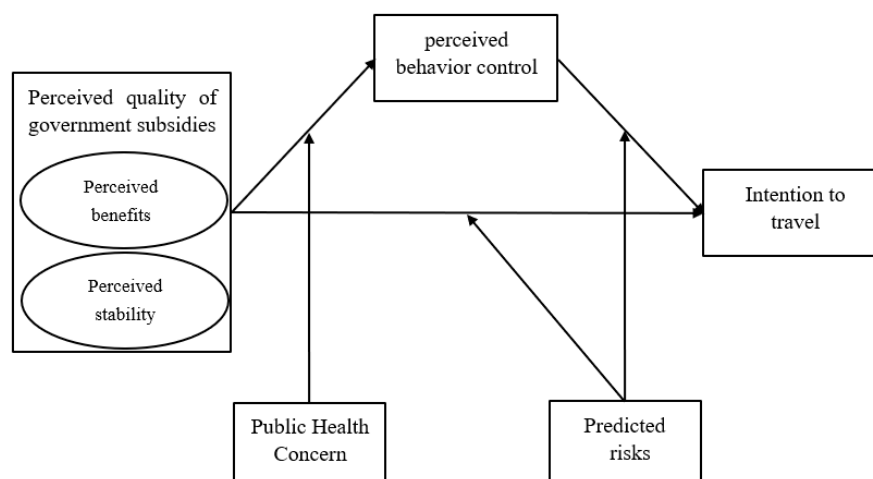

**Figure 1.** Hypothetical model diagram.

### 3. Materials and Methods

#### 3.1. Data Collection and Questionnaire Design

Data were collected through a well-designed data collection instrument from 1 September to 30 October 2022. A mixed approach via on-site and online questionnaire surveys was employed for Wuhan residents. The link to the online survey was shared on different tourism-related pages on Weibo and WeChat. On-site survey was distributed in the Wuhan community.

We employed a no-touch strategy to erratically drop questionnaires on paper with gifts of sanitizers at homeowners’ doorsteps because China was still strictly in a pandemic prevention and control zone when the surveys were given out. We gathered the questionnaires the following day. The offline survey was conducted in Wuhan since it was the first place of the new crown pandemic outbreak in China. Residents of Wuhan also experienced the earliest public health event in the most intuitive manner, as well as the most intense levels of psychological panic and frustration. It is more realistic to choose the locals as the research popup group because the subsidy program is intended to rebound from the new crown pandemic’s negative effects on the region’s tourism industry. A total of 219 full responses were received, of which 182 were from legitimate surveys.

The data-gathering tool is divided into several sections. Questions about the visitors' backgrounds were asked in the first part of the information collection. The second section related to the tourists' perceptions of government subsidies, with reference to the studies of Wang et al. [22] and Zheng [45]. The third section related to the tourists' perceptions of predicted risks referring to Xu Hui [46] and Ai et al. [47] in their study of perceived risk. The fourth section related to public health concerns, whose questions were developed with expert opinion. The fifth section related to travel intention, referencing Zheng [45]. All of the questions, with the exception of those in Section 1, were graded on a 5-point Likert scale. Additionally, numerous illustrations of subsidy policies were provided.

The demographic information about the respondents is shown in Table 1. More than half of the respondents were between the ages of 26 and 40. There were roughly equal numbers of men and women, with women making up 51.6% of the total. By profession, 45.2% of respondents were workers for a corporation. Over half of the respondents received salaries of more than CNY 3000. The average monthly income of the respondents is calculated according to monthly living expenses; campus prices are low; and this amount is more than enough to cover the living costs of college students' children who are still in school. More than 88% of the respondents have salaries that are higher than CNY 3000; the minimum wage in Wuhan is CNY 2600; and about 12% of the respondents have average monthly incomes that are below CNY 3000 because they are primarily students.

**Table 1.** Basic characteristics statistics.

Features	Category	Percentage Share/%	Features	Category	Percentage Share/%
Age	18–25 years	12.8	Gender	Man	48.4
	26–30 years	29.1		Woman	51.6
	31–40 years	22.4		Student	11.2
	41–50 years	26.5	Occupation	Company staff	45.2
	51–60 years	5.2		Individual household	22.3
	Over 60 years	4.0		Employee of the government and public institutions	5.0
Monthly income	Under CNY 3000	11.2	Retiree	8.3	
	CNY 3000–5000	34.8	Other	8.0	
	CNY 5000–7000	28.1			
	CNY 7000–9000	18.3			
	Over CNY 9000	7.6			

### 3.2. Credibility Analysis and Description of Current Situation

#### 3.2.1. Exploratory Factor Analysis

We used an exploratory factor analysis (EFA) by PASW statistics 27.0 to ensure that the survey responses and dimensions were satisfactory. The factors were rotated using the maximum variance approach, and the principal components were chosen using the eigenvalues larger than 1 rule. Under each primary component, the items with factor loading larger than 0.5 and comparable values were chosen. The initially developed questionnaire's EI4, EI5, FI1, FI4, HI2, OI2, and OI3 items were eliminated after many filtering iterations.

The remaining questions are then examined. We started by running a reliability analysis. The scale's overall Cronbach's value was 0.850, and the individual values for each dimension were 0.869, 0.867, 0.828, 0.759, 0.784, and 0.773 (Table 2), all of which were greater than 0.7, indicating that the scale was reliable.

We then conducted a validity analysis. In Bartlett's spherical test, the findings revealed KMO values was 0.825, greater than 0.8 and  $p < 0.01$  (Table 3), demonstrating the scale's high validity. Using an exploratory factor analysis (EFA), the remaining question items can be extracted as six common factors, named travel intention (OI1, OI4, OI5, OI6, OI7), predicted risk (KI1, KI2, KI3, KI4), perceived stability of government subsidies (FI2, FI3, FI5), perceived behavioral control (HI1, HI3, HI4), perceived benefits of government subsidies (EI1, EI2, EI3), and public health concern (HI5, HI6, HI7). The overall contribution from variance was 71.563%, as shown in Table 2.

**Table 2.** Confidence validity and exploratory factor loading tables.

Variables	Title	Factor Loading	Cronbach's $\alpha$	Sum of Squared Rotating Loads
Travel intention	OI4	0.818	0.869	16.198
	OI5	0.781		
	OI7	0.775		
	OI6	0.733		
	OI1	0.71		
Predicted risks	KI4	0.862	0.867	30.027
	KI3	0.861		
	KI1	0.827		
	KI2	0.822		
Perceived stability of government subsidies	FI2	0.855	0.828	40.977
	FI3	0.852		
	FI5	0.758		
Perceived behavioral control	HI4	0.853	0.759	51.309
	HI1	0.723		
	HI3	0.714		
Perceived benefits of government subsidies	EI1	0.802	0.784	61.445
	EI2	0.765		
	EI3	0.741		
Public health concerns	HI6	0.877	0.773	71.563
	HI5	0.765		
	HI7	0.758		

**Table 3.** KMO and Bartlett's test.

Variables	Value	
Kaiser–Meyer–Olkin Measure of Sampling Adequacy	0.825	
Bartlett's Test of Sphericity	Approx. Chi-Square	1780.030
	df	210
	Sig.	0.000

### 3.2.2. Validation Factor Analysis

Validation factor analysis of the scale was conducted by AMOS 24.0 and yielded CMIN/DF values greater than 1 and less than 3, RMSEA values less than 0.08 and IFI, TLI and CFI values greater than 0.9, indicating that the model values all met the standard and the model fit well. In addition, the inclusion of univariate and covariate factor models on top of the six variables in this study was checked to prevent potential issues of homology bias.

As can be seen in Table 4, the single-factor model did not fulfill the standards and considerably differed from the six-factor model, but the addition of the common variance component did not result in a significant rise in TLI or CFI, and the change in RMSEA value was also not greater than 0.05. Therefore, the six-factor model does not suffer from the homology bias problem.

**Table 4.** Table of overall fit coefficients.

	CMIN/DF	RMSEA	IFI	TLI	CFI
One-factor model	5.623	0.6	0.477	0.412	0.471
Six-factor model	1.557	0.055	0.943	0.929	0.921
Inclusion of a common methodology factor model	1.330	0.043	0.970	0.985	0.969

The convergent validity (AVE) and combined reliability (CR) of each dimension were further examined under the assumption that the model's overall fit was good, and the standardized factor loading for each dimension was calculated to obtain AVE values greater than 0.5 and CR values greater than 0.7 for each dimension (see Table 5). These values showed that the scale had good convergent validity and a combined reliability. A discriminant validity study was performed to see if each dimension could be distinguished from the others. Table 6 shows that there was a good discriminant validity between the dimensions because the correlation coefficients for the dimensions of perceived benefit, perceived stability, perceived behavioral control, public health concern, predicted risk, and travel intention were all smaller than the square root of the convergent validity value of each dimension.

**Table 5.** Convergent validity and combined reliability tests for each dimension of the scale.

Variables	Title	Estimate	AVE	CR
Perceived Benefits of Government Subsidies	EI1: I feel that the travel subsidy policy has made my trips more affordable	0.795	0.5628	0.7937
	EI2: I feel that the travel subsidy policy has reduced the cost of my trips	0.769		
	EI3: I feel that the subsidy policy is beneficial to me	0.682		
Perceived Stability of Government Subsidies	FI2: I think the amount of government subsidies will not change randomly	0.821	0.6218	0.831
	FI3: I think the duration of government subsidies will not change randomly	0.815		
	FI5: In general, I feel that the government's subsidy policy is stable	0.726		
Perceived behavioral control	HI1: I think I understand travel policy subsidies	0.787	0.5343	0.7742
	HI3: I think I can get a travel-related government subsidy	0.719		
	HI4: I have used government subsidies for trips before	0.683		
Public Health Concerns	HI5: I think I know about public health in the places I travel	0.781	0.5431	0.7788
	HI6: I consider myself to be aware of the seriousness of the risks to public health	0.8		
	HI7: Before I go on a trip, I will find out about the public health situation in the destination	0.616		
Predicted Risks	KI1: I am concerned about the poor awareness of epidemic prevention and poor service in local hotels that can use government subsidies	0.774	0.6216	0.8678
	KI2: I am concerned that the arrangements for food, accommodation and entertainment will not meet my expectations when I use the government subsidy	0.754		
	KI3: I am concerned that the tourist destination using government subsidies may be temporarily changed or substituted for the tour	0.822		
	KI4: I am concerned that the services provided by the tourist attraction will not be satisfactory after using the government subsidy	0.802		
Travel Intention	OI1: I am interested in tourism-related government subsidies	0.761	0.5739	0.8706
	OI4: I am willing to travel with government subsidies	0.779		
	OI5: I recommend others to travel with government subsidies	0.762		
	OI6: I would share my experience of using it with others	0.712		
	OI7: The government subsidy makes me feel better about going on a trip	0.772		



**Table 6.** Differential validity scale.

	Perceived Benefits	Perceived Stability	Perceived Behavioral Control	Public Health Concerns	Predicted Risks	Travel Intention
Perceived benefits	0.5628					
Perceived stability	0.378	0.6218				
Perceived behavior control	0.422	0.511	0.5343			
Public health concerns	0.433	0.196	0.349	0.5431		
Predicted risks	0.074	0.008	−0.001	0.074	0.6216	
Travel intention	0.628	0.438	0.543	0.273	0.135	0.5739
Square root of AVE value	0.750	0.789	0.731	0.737	0.788	0.758

### 3.2.3. Current Situation Analysis

Descriptive analyses of travel intention, predicted risk, the perceived stability of government subsidies, the perceived benefit of government subsidies, public health concerns, and perceived behavioral control are shown in Table 7. The general public, according to the average value, thinks that the advantages of government subsidy schemes outweigh their stability. Additionally, the public's perception of their ability to influence whether they can receive government subsidies is at a medium level, meaning that they are unsure if they can. The public perceives a high risk while using a subsidy, even if they do receive one, in terms of the quality of the services. In addition, there was a high degree of public anxiety regarding public health and safety, which may be connected to incidents involving contagious diseases.

**Table 7.** Statistics for the key variable description.

	N	Minimum Value	Maximum Value	Average	Standard Deviation
Travel intention	182	1.4	5	4.0264	0.63713
Perceived benefits	182	2	5	4.1282	0.62439
Perceived stability	182	1.33	5	3.8608	0.71649
Perceived behavioral control	182	1	5	3.2198	0.96051
Public health concerns	182	2.33	5	4.152	0.61451
Predicted risks	182	1	5	3.8008	0.79785
Number of active cases	182				

To investigate the differences between each variable and age, gender, mean monthly income, and occupation, we continued to conduct Pearson's chi-squared tests for each of the variables. The findings revealed that there were significant differences in predetermined risk among age groups ( $p = 0.06$ ), perceived behavioral control among visitors of different genders ( $p = 0.06$ ), and public health concerns among occupational groups ( $p = 0.001$ ).

## 4. Result

### 4.1. Main Effects Test

The study's independent variable was the perceived quality of government subsidies, which took into account both their perceived value and their perceived stability. To ascertain whether the independent variables significantly influenced the dependent variable, travel intention, a regression analysis was performed. Table 8 presents the outcomes. Model 1 was a regression study with travel intention (Y) as the dependent variable, and the two independent variables being the perceived stability of government subsidies (X2) and perceived benefit of government subsidies (X1). The standardized coefficient value was positive, the  $p$ -values were all less than 0.01, and there was a significant positive effect of the independent variable on the dependent variable. A single-factor regression analysis was conducted to avoid the interaction effect between the two variables of perceived benefit and stability of government subsidies. Model 2

was a regression study that focused on the relationship between the willingness to travel (Y) and the perceived value of government subsidies (X1). It revealed that the perceived value of government subsidies contributes by 28.1% to travel intention. Regression analysis in Model 3 of the relationship between the perceived stability of government subsidies (X2) and the intention to travel (Y) revealed that the perceived stability of government subsidies accounts for 14.8% of the intention to travel. When compared to Model 3, where the standardized coefficient value for the perceived stability of government subsidies was 0.384, Model 2's standardized coefficient value for the perceived affordability of government subsidies was 0.53, which is higher. This suggests that the former has a larger impact on travel intention than the latter. The H1, H1a, and H1b hypotheses are thus true.

**Table 8.** Table of regression equations.

M Model		Unstandardized Coefficient		Standardized Coefficient	t	Significance
		B	Standard Errors	Beta		
Model 1 R <sup>2</sup> = 0.328	constants	1.335	0.292		4.578	0
	X1	0.461	0.067	0.452	6.928	0
	X2	0.204	0.058	0.23	3.52	0.001
Model 2 R <sup>2</sup> = 0.281	constants	1.792	0.269		6.658	0
	X1	0.541	0.064	0.53	8.392	0
Model 3 R <sup>2</sup> = 0.148	constants	2.708	0.24		11.269	0
	X2	0.342	0.061	0.384	5.581	0

a. Dependent variable: Y

#### 4.2. Testing for Mediating Effects of Perceived Behavioral Control

To fit the variable perceived quality of government subsidies (X), the perceived benefit of government subsidies (X1) and perceived stability of government subsidies (X2) were averaged. The bootstrap approach process was used to examine the mediation effect of perceived behavioral control (M) between the three independent variables and travel intention (Y). Table 9 displays the results. In path X-M-Y, the upper and lower limits of CI values for the total, direct and indirect effects did not include 0 and  $p < 0.01$ . This suggests that perceived behavioral control has a role in mediating the path. And, since all the effect values are positive, it follows that the higher the quality of the public's perception of government subsidies, the more they are able to control their conduct to believe that they can obtain government subsidies, thereby increasing travel intentions. H2 is thus appropriate. The upper and lower ranges of the CI values of the total, direct, and indirect effects in pathways X1-M-Y and X2-M-Y do not contain 0 and  $p < 0.01$ , and the effect values are all positive. This suggests that perceived behavioral control has a partial mediation influence on the perceived affordability of government subsidies and travel path intention, as well as the perceived stability of government subsidies and travel path intention. H2a and H2b are thus correct.

#### 4.3. A Test of the Moderating Effect of Predicted Risks and Concern

Table 10 shows a significant moderating effect between public health concerns (W1), the perceived quality of government subsidies (X), and perceived behavioral control (M); the coefficient values for all variables were greater than 0. The 95% CI interval for the interaction term X\* W1 does not contain 0,  $p = 0.0098$ , in the moderating path between these variables, demonstrating that the favorable relationship between the perceived quality of government subsidies and perceived behavioral control was positively attenuated by worries about public health. The correlation between H3 and H2 was positive. The 95% CI interval of the interaction term M\* W2 on perceived behavioral control (M) and travel

intention (Y) in the moderating path of predicted risk (W2) contained zero, and the *p*-value of 0.2011 was greater than 0.05. The moderating impact of predicted risks did not hold along this route, and hypothesis H4 was disproved. The 95% CI interval in this path did not contain zero, the regression coefficient of the interaction term X\*W2 was negative, and the *p*-value was less than 0.05. Prejudgment risk had a negative moderating effect on this path, hence H5 was true.

**Table 9.** Table of tests for mediating effects of Perceived Behavioral Control.

Behavior Control		Effect	Se	t	p	LLCI	ULCI
X–M–Y	Total Effect	0.6266	0.0736	8.5133	0	0.4814	0.7719
	Direct effects	0.5234	0.0798	6.5611	0	0.3659	0.6808
	Indirect effects	0.1033	0.0464	/	/	0.0275	0.2119
X1–M–Y	Total effect	0.4702	0.0678	6.9381	0	0.3364	0.6039
	Direct effects	0.4214	0.0679	6.2029	0	0.2873	0.5554
	Indirect effects	0.0488	0.0263	/	/	0.0086	0.1129
X2–M–Y	Total effect	0.1849	0.0592	3.1208	0.0021	0.068	0.3018
	Direct effects	0.129	0.0605	2.1313	0.0345	0.0095	0.2484
	Indirect effects	0.0559	0.0269	/	/	0.0139	0.1188

**Table 10.** Test of the moderating influence on risk and pandemic concern.

	Dependent Variable: Perceived Behavior Control			Dependent Variable: Willingness to Travel		
	Coeff	p	95%CI	Coeff	p	95%CI
Gender	−0.4282	0.0009	[−0.6792, −0.1773]	−0.0615	0.4639	[−0.2269, 0.1039]
Age	−0.1519	0.2091	[−0.3898, 0.0859]	−0.0461	0.5474	[−0.1971, 0.1049]
Occupation	0.0039	0.9533	[−0.1261, 0.1338]	−0.0245	0.5553	[−0.1065, 0.0574]
Monthly income	0.1731	0.0396	[0.0083, 0.3380]	0.0188	0.7255	[−0.0865, 0.1240]
X	0.6036	0	[0.3688, 0.8384]	0.4978	0	[0.3416, 0.6540]
W	0.2227	0.0359	[0.0149, 0.4305]			[0.0445, 0.2329]
M				0.1387	0.0041	
X*W1	0.4849	0.0098	[0.1183, 0.8514]			
W2				0.1054	0.0411	[0.0043, 0.2065]
X*W2				−0.2791	0.0142	[−0.5014, −0.0567]
M*W2				0.0783	0.2011	[−0.0421, 0.1987]

With a regression coefficient of 0.3057 and a 95% confidence interval (CI) of [−0.0480, 0.6593], further analysis of the moderating effects of the aforementioned moderating variables at high and low levels revealed that for those with low levels of public health concern, the beneficial influence of the perceived quality of government subsidies on perceived behavioral modification was not crucial. For those with higher levels of public health concerns, the perceived quality of government subsidies had a substantial beneficial impact on perceived behavioral control, with a regression coefficient of 0.9016 and a 95% confidence interval (CI) of [0.6071, 1.1960]. Figure 2 demonstrates that the positive association between the perceived quality of government subsidies and perceived behavioral control is more strongly moderated by high levels of public health concerns. For the public with a low level of perceived predicted risk, the regression coefficient was 0.7204 with 95% CI of [0.4938, 0.9470]. With a 95% confidence interval of [0.0285, 0.5209], the regression coefficient for the public with a modest level of predicted risk perception was 0.2751. The strong connection between the perceived quality of government subsidies and willingness to travel is moderated positively by high levels of predicted risk perception, as shown in Figure 3.

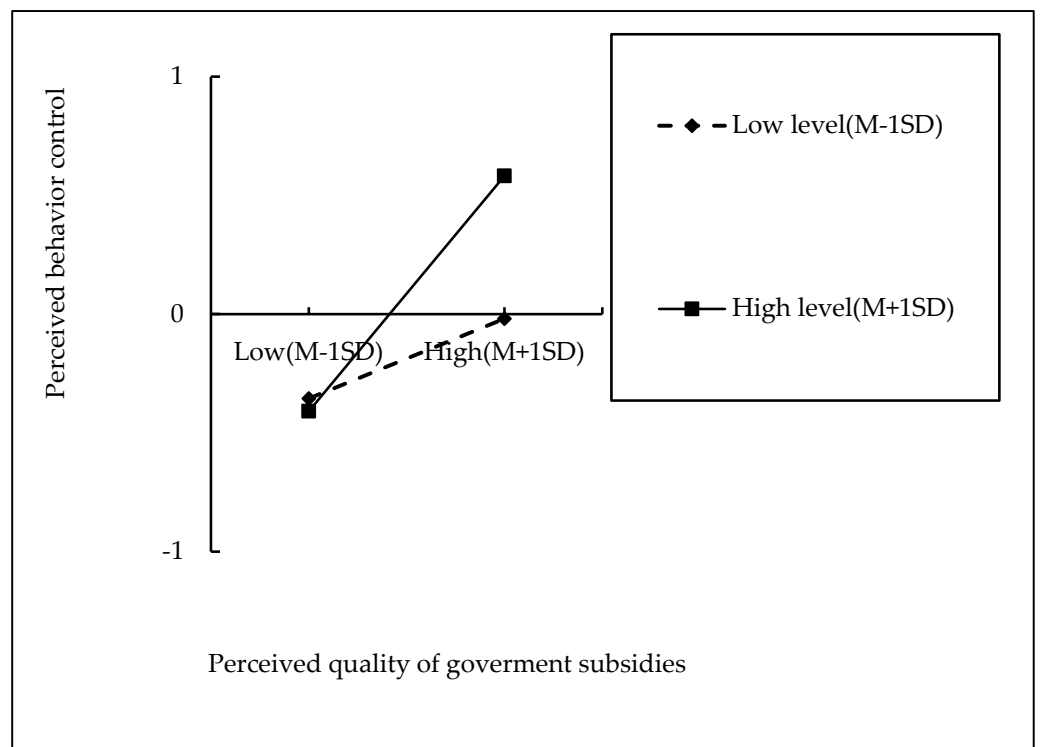

Figure 2. Map of the moderating effect of public health concerns.

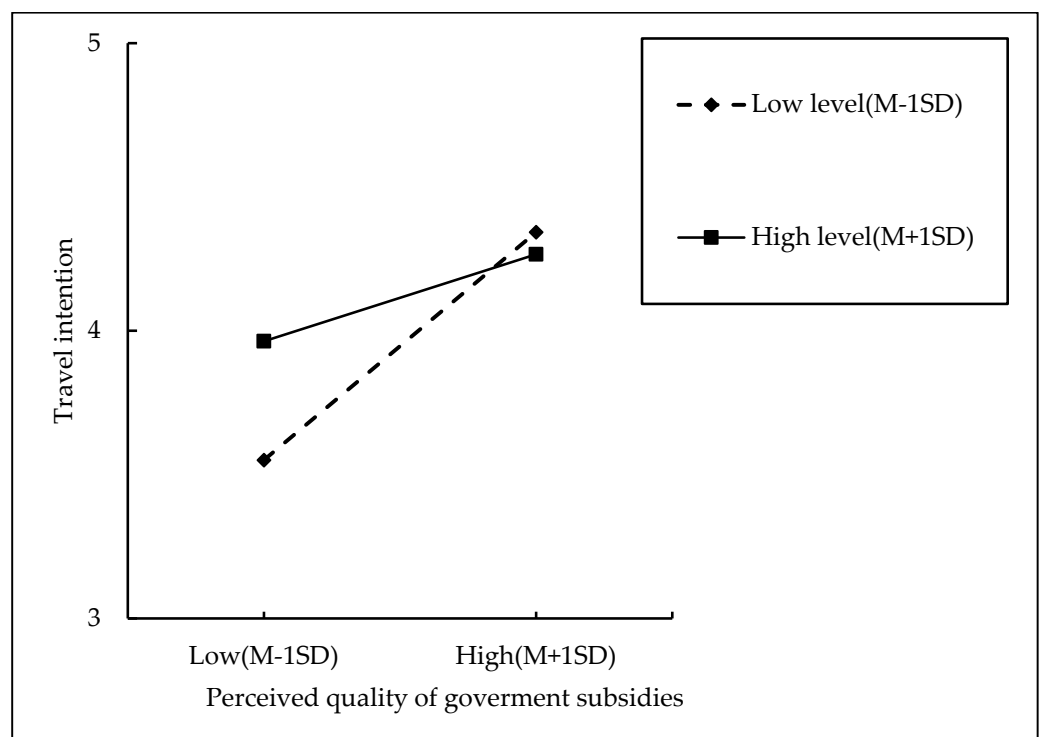

Figure 3. Diagram of the moderating effect of predicted risks.

### 5. Discussion

Residents of Wuhan were used as the research subject in this study, and it covered how they felt about government assistance and how it affected their desire to travel. This served as a resource on how regulations might enhance the development of the tourism industry during the post-pandemic period. The empirical study of subsidies can help the

current system of policy study to some extent and confirm the sustainability of subsidies in China's public health events. The results showed that subsidy programs can positively affect travelers' intentions to travel, with perceived behavioral control acting as a mediating factor, and public health worries and risk aversion as moderating factors.

In comparison with previous studies, there are similarities and differences between the findings of this study. Scholars confirmed that duty-free policies have a strong positive impact on travel intentions and that the severity of the epidemic moderates the effect [48]. Adventurous people found the subsidy policy to be a better incentive to travel than the policy to curb the pandemic [49]. This paper expanded the scope of the subsidy policy to take into account the actual situation in China and arrived at a view similar to that of the abovementioned scholars. In food waste reduction policies, the mediating role that perceived control could play in the policy and household intentions to reduce waste has been demonstrated [50]. This paper confirmed that China's subsidy policy can influence travel intentions through perceived behavioral control. The difference lies in the fact that the abovementioned scholars' studies were about perceived external governmental control, whereas this paper was about the perceived control of the internal self-behavior. Perceived control at both the individual and policy levels was positively associated with preventive behavior during the COVID-19 pandemic [51]. It is therefore reasonable to assume that after the implementation of the policy, residents will judge whether they are likely to receive the relevant subsidies through their own knowledge of the policy, which will have an impact on their travel intention. Zhou et al. [52] introduced the moderating role of haze concerns and risks in congestion charging policies, and proposed that the public perception of policy effectiveness can enhance policy acceptance. The findings of this paper are similar, exploring whether residents are traveling in line with policy intentions by measuring the affordability and effectiveness of government subsidies. People with different levels of concerns about public health events and different perceptions of risk will respond differently to these policy intentions.

The purpose of this research philosophical contribution is to review the literature on government subsidies, create the variable of perceived quality of subsidy policy, blend planned behavior theory and S-O-R theory, create a structural equation model in accordance with empirical analysis, and examine and reveal the mediating role of perceived behavioral control (organism) in the perceived quality of subsidy policy (stimulus) and travel intention (behavioral response). In order to enrich the research findings of S-O-R theory and planned behavior theory and to some extent provide a relatively integrated analytical framework for tourism government subsidies research, this investigation uses the intermediary effect created by the combination of S-O-R theory and planned behavior theory as its main framework, expanding the moderating role of public health concern and predicted risk.

## 6. Conclusions and Recommendations

### 6.1. Conclusions

A guarantee for the steady growth of tourism is public health and safety. The increase in domestic demand is seen as a key task for the growth of tourism in the new environment.

The government has implemented a number of steps to subsidize tourists in an effort to support the recovery of the tourism industry. According to theory, the study enhanced the stimulant effect of government subsidies based on the viewpoint of public health issues from the perspective of tourists. Providing guidance for promoting the tourism economy from the perspective of domestic demand is a practical consideration. We combined public assistance with perceived quality to assess how they rank with consumers by developing a theoretical model and examining the micro-action course of the Chinese government's subsidy policy in light of tourists' opinions.

The findings led to the following conclusions:

- (1) Tourists find that the current government subsidy policies are effective, which indicates that their perception of government subsidies is of a high caliber. Visitors' intentions to travel are significantly favorably influenced by both the perceived benefit

and stability of government subsidies, with the positive effect of perceived benefit being larger.

- (2) The perceived quality of government subsidies affects both the travel intention directly and also through perceived behavioral control, which plays a mediating role. In other words, based on their assessment of the perceived value of government subsidies, tourists' travel intentions are influenced by the perceived ease of access to government subsidies.
- (3) Public health concerns reinforce the positive effect between the perceived quality of government subsidies and perceived behavioral control. The more concerned the public is about public health safety, the more knowledgeable they are about the disease, and hence, they are less likely to exaggerate the consequences of infection. When the government subsidies are published, visitors feel that they can access and use them successfully and are not prevented from using them due to illness.
- (4) Predicted risks prevent the perceived quality of government subsidies from having a favorable impact on travel intention. Visitors will be aware of the hazards associated with using travel subsidies from the government, such as receiving unfavorable treatment from merchants. Government subsidies are less successful in encouraging willingness to travel when the risks that travelers anticipate before traveling are higher.
- (5) Additionally, there are significant differences in predicted risks among age groups ( $p = 0.001$ ), perceived behavioral control among visitors of various genders ( $p = 0.06$ ), and public health concerns among professional categories ( $p = 0.001$ ).

### 6.2. Study Limitations

Additionally, there are some further problems with the article.

This survey does not differentiate between urban and rural inhabitants because it is based solely on Wuhan locals, lacking a study comparing the two groups.

The sample size was also controlled due to the fact that the questionnaire was distributed while China was still employing stringent controls against the pandemic. In the future, additional factors like policy trust can be included to examine how government travel subsidies affect willingness to travel by combining facts from both first- and second-hand data sources to offer suggestions for improving the effectiveness of our policy execution and our policy formulation.

### 6.3. Recommendation

On the basis of the findings of the research, the following recommendations are made. First, prolonging the policy's use length to improve stability, a high frequency, and a brief duration are features of the current subsidy regimes. When the general public utilizes them, unexpected events or negligence can trigger conflicts with the anticipated trip time or cause them to miss the expiration date. To guarantee that the policy is implemented well, the government can make it clear how long the policy will last in order to increase its credibility in the public's eyes. In addition, it can address unforeseen occurrences by offering more explanations or extending the deadline. Second, the government should minimize the chances of negative public opinion and increase publicity. As government subsidies may be used differently by businesses, it is important to improve the regulatory framework governing their use. This will ensure that residents can utilize the subsidies without difficulty and that those who do so will receive the same high-quality goods and services as those who do not. In addition, more information must be made widely available on the usage of government subsidies so that individuals of all ages can access it so as to help the public feel less uncertain and concerned about government subsidies by providing an increased awareness of the techniques and scope of use.

Third, the government should develop an environment for sharing knowledge about public health. Tourism activities facilitate the spread of both domestic and international infectious diseases, and the public's concern for public health and safety has grown to be a significant determinant of their travel choices. A platform such as this might describe

recent epidemics, common illnesses that affect travelers, and treatments and preventative methods. Increasing public knowledge of illnesses and lowering fear levels consequently lowers the chances of health risks when traveling, assuring traveler happiness.

**Author Contributions:** Conceptualization, Y.D. and Y.J.; methodology, Y.D. and J.Y.; software, Y.J.; validation, Y.D. and Y.J.; formal analysis, Y.J.; investigation, Y.D. and Y.J.; resources, Y.D.; data curation, Y.D. and Y.J.; writing—original draft preparation, Y.D. and Y.J.; writing—review and editing, Y.D., K.A.K. and Y.J.; visualization, Y.D. and Y.J.; supervision, Y.D.; project administration, Y.D.; funding acquisition, Y.D. All authors have read and agreed to the published version of the manuscript.

**Funding:** This paper was funded by the National Social Science Foundation of China, “Research on the economic growth of China’s inbound tourism under the new situation”. The funding number is 18BJY195. The funder is Yajuan Dong. Yajuan Dong is an associate professor and doctoral supervisor in Chang’an University, China. She has been selected as one of the “Young Experts in Tourism” by the Ministry of Culture and Tourism of China in 2014. Her research interests include tourist behavior, tourism economy and tourism marketing. In recent years, she has participated in 4 National Natural Science Foundation and National Social Science Fund of China, hosted 1 National Social Science Fund, 1 Scientific Research Fund of the Ministry of Culture and Tourism and 1 Chinese Postdoctoral Science Fund. She has also hosted or participated in more than 20 provincial or municipal funds. She has published more than 30 papers in journals on leisure, recreation and tourism studies.

**Institutional Review Board Statement:** The study was approved by the Institutional Review Board of Chang’an University, China.

**Informed Consent Statement:** Informed consent was obtained from all subjects involved in the study.

**Data Availability Statement:** The data can be obtained from the corresponding author on reasonable request.

**Conflicts of Interest:** The authors declare no conflict of interest.

## References

- Shen, J.B.; Xu, T.; Lu, M.M.; Zhai, Y.X. Coping strategies of tourism industry under the impact of the epidemic and development trend in the post-epidemic period. *Macrocon. Manag.* **2020**, *08*, 55–60. [CrossRef]
- Xia, J.C.; Mao, L.J.; Chen, L.L. The evolution and change of tourism under external shocks: The case of the new crown pneumonia epidemic. *J. Xinjiang Norm. Univ. (Philos. Soc. Sci. Ed.)* **2020**, *41*, 43–54+2. [CrossRef]
- Kovačić, S.; Cimbalević, M.; Tretyakova, T.N.; Syromiatnikova, Y.A.; García Henche, B.; Petrović, M.D.; Blešić, I.; Pivac, T.; Demirović Bajrami, D.; Gajić, T. How Has COVID-19 Changed the Way We Travel? Exploring Tourist Personality, Reactions to the Perceived Risk and Change in Travel Behavior. *Sustainability* **2023**, *15*, 1951. [CrossRef]
- Morar, C.; Tiba, A.; Basarin, B.; Vujičić, M.; Valjarević, A.; Niemets, L.; Gessert, A.; Jovanovic, T.; Drugas, M.; Grama, V.; et al. Predictors of Changes in Travel Behavior during the COVID-19 Pandemic: The Role of Tourists’ Personalities. *Int. J. Environ. Res. Public Health* **2021**, *18*, 11169. [CrossRef]
- Tepavčević, J.; Blešić, I.; Petrović, M.D.; Vukosav, S.; Bradić, M.; Garača, V.; Gajić, T.; Lukić, D. Personality Traits That Affect Travel Intentions during Pandemic COVID-19: The Case Study of Serbia. *Sustainability* **2021**, *13*, 12845. [CrossRef]
- Neuburger, L.; Egger, R. Travel risk perception and travel behaviour during the COVID-19 pandemic 2020: A case study of the DACH region. *Curr. Issues Tour.* **2020**, *24*, 1003–1016. [CrossRef]
- Bratić, M.; Radivojević, A.; Stojiljković, N.; Simović, O.; Juvan, E.; Lesjak, M.; Podovšovnik, E. Should I Stay or Should I Go? Tourists’ COVID-19 Risk Perception and Vacation Behavior Shift. *Sustainability* **2021**, *13*, 3573. [CrossRef]
- Lee, K.P. A Study on Risk Perception, Overseas Travel Attitude, Overseas Travel Intention and Domestic Travel Switching Intention due to COVID-19 Pandemic. *Korea Int. Trade Res. Inst.* **2020**, *16*, 737–751. [CrossRef]
- Sheng, F.F.; Li, Z.M. The impact, transmission and response of major public health emergencies on the economy: An example of the New Crown Pneumonia outbreak. *Bus. Econ.* **2020**, *3*, 12–20. [CrossRef]
- Peng, L.J. Research on the Effectiveness of Socio-Economic Policy Implementation under COVID-19 Pandemic. Master’s Thesis, Zhejiang University of Business and Economics, Hangzhou, China, 2021. [CrossRef]
- Xie, C.W.; Lai, F.F.; Huang, R. Tourism resilience system construction and high quality tourism development under the epidemic crisis. *J. Tour.* **2022**, *37*, 3–5. [CrossRef]
- Wang, J.X.; Li, X.C.; Han, B. A study on government subsidies and enterprise survival based on the context of the post-epidemic era. *Econ. Issues* **2022**, *519*, 58–66. [CrossRef]
- Shan, H.Y.; Pi, W.J.; Xu, J.L. Evolutionary game analysis of coping strategies between local governments and small and medium-sized service enterprises under the epidemic shock. *J. Nanjing Univ. Inf. Eng. (Nat. Sci. Ed.)* **2022**, *14*, 516–526. [CrossRef]

14. Zhang, S.; Sun, T.; Lu, Y. The COVID-19 Pandemic and Tourists' Risk Perceptions: Tourism Policies' Mediating Role in Sustainable and Resilient Recovery in the New Normal. *Sustainability* **2023**, *15*, 1323. [CrossRef]
15. Liu, B.J.; Zeng, J.Y.; Zhao, Y.Y. Policy quantification of tourism industry and its impact analysis. *Explor. Econ. Issues* **2021**, *12*, 71–82.
16. Wang, Y.; Yang, J. Research on policy influencing factors of tourism consumption and its implications—A survey based on consumers in Hangzhou. *Econ. Geogr.* **2012**, *32*, 163–167.
17. Liu, G.Q. Analysis of the incentive effect of tax incentives and financial subsidies policy—An empirical study based on the perspective of information asymmetry theory. *Manag. World* **2016**, *10*, 62–71. [CrossRef]
18. Steenkamp, J.-B.E. Conceptual model of the quality perception process. *J. Bus. Res.* **1990**, *21*, 309–333. [CrossRef]
19. Wang, P.; Huang, Q.; Chen, M.J. Brand origin, purchase experience and perceived brand quality: An empirical study of Chinese sporting goods. *J. Xi'an Sports Coll.* **2019**, *36*, 38–44. [CrossRef]
20. Fan, B.N.; Zhang, X.R. The conceptual conception, measurement indicators and actual measurement of public policy quality. *J. Beijing Adm. Coll.* **2014**, *6*, 1–7. [CrossRef]
21. Garvin, D. Competing on the eight dimensions of quality. *Harv. Bus. Rev.* **1987**, 101–109. [CrossRef]
22. Wang, X.Z.; Zheng, Y.; Jiang, Z.H.; Pan, G.H. The impact of subsidy policy on household photovoltaic purchase intention—an empirical analysis based on psychological distance and risk preference. *Soft Sci.* **2019**, *33*, 130–135. [CrossRef]
23. Qiu, G.B. The impact of different government subsidy models on manufacturers' and retailers' decisions. *Sci. Decis. Mak.* **2013**, *7*, 12–24.
24. Qiu, G.B. The impact of government subsidies on supply chain with different weights. *Technol. Econ.* **2013**, *32*, 124–129. [CrossRef]
25. Lin, Y.F.; Shen, Y.; Sun, A. The economic effects of China's government consumption voucher policy. *Econ. Res.* **2020**, *55*, 4–20.
26. Li, B.S. The internal logic and potential risks of consumption voucher issuance under the new crown epidemic. *Price Theory Pract.* **2020**, *04*, 47–50. [CrossRef]
27. Sun, K.J.; Tang, T.Y. Evaluation and characteristics of the effect of consumption voucher policy under the epidemic shock. *Fisc. Sci.* **2022**, 28–41. [CrossRef]
28. Wang, X.F. Research on measuring the effect of consumption voucher policy under the new crown epidemic: An analysis based on Python software to obtain data on the number of blogs posted and attention of Sina Weibo. *Price Theory Pract.* **2020**, *11*, 61–63. [CrossRef]
29. Tagashira, T. Signal effect of a targeted travel subsidy on consumer behavior during the coronavirus disease 2019 pandemic. In *Marketing Letters*; Springer: Berlin/Heidelberg, Germany, 2022; pp. 1–14.
30. Matsuura, T.; Hisamitsu, S. The COVID-19 pandemic and domestic travel subsidies. *Ann. Tour. Res.* **2022**, *92*, 103326. [CrossRef]
31. Huang, C.H.; Li, J.Z.; Zhou, X.J. Research on the factors influencing tourists' willingness to travel—Empirical evidence based on public health emergencies. *Hum. Geogr.* **2015**, *30*, 145–150. [CrossRef]
32. Liu, X.H.; Hong, P. Economic policy uncertainty and corporate investment: A heterogeneous perspective on financing constraints. *J. Nanchang Univ. (Humanit. Soc. Sci. Ed.)* **2022**, *53*, 36–45. [CrossRef]
33. Bae, H.-K. The relationship between cosmetic quality, consumer preference, advice, and solicitation on purchase behavior—Focusing on the mediating effect of perceived behavioral control. *J. Converg. Inf.* **2019**, *11*, 250–257. [CrossRef]
34. Lu, L.; Li, L.; Hou, Y. Resilience and quality development of tourism places under the epidemic crisis. *J. Tour.* **2022**, *37*, 1–3. [CrossRef]
35. Wang, J.X.; Zhang, Y. Risk perceptions, social emotions and future expectations: Changes in social mindsets at different stages of the epidemic. *Soc. Sci. Front.* **2022**, *10*, 220–237.
36. Shi, K.; Zhou, H.M.; Jiao, S.M.; Guo, H.D.; Yan, D. A study on the mechanism of the influence of information about the new crown pneumonia epidemic on people's risk perception and coping behavior. *Manag. Rev.* **2022**, *34*, 217–228. [CrossRef]
37. Bai, L.; Wei, Y. A study on investors' attention to public health events and information spillover effects in China's industry stock market—empirical evidence from TVP-VAR model. *China Manag. Sci.* **2023**, 1–21. [CrossRef]
38. Flynn, L.R.; Goldsmith, R.E. A short, reliable measure of subjective knowledge. *J. Bus. Res.* **1999**, *46*, 57–66. [CrossRef]
39. Rittichainuwat, B.N.; Chakraborty, G. Perceived travel risks regarding terrorism and disease: The case of Thailand. *Tour. Manag.* **2009**, *30*, 410–418. [CrossRef]
40. Wang, H.Y.; Yang, J.; Chen, X.Y. A study on the trade effects of Chinese investment in countries along the "Belt and Road"—The host country risk adjustment effect. *Henan Soc. Sci.* **2021**, *29*, 79–92. [CrossRef]
41. Zhang, Y.R.; Pi, P.F. A study of tourism destination image, perceived risk and behavioral intention in the post-New Crown epidemic period—Wuhan as an example. *Bus. Econ.* **2022**, *2*, 140–145. [CrossRef]
42. Gou, T.; Tang, Y.; He, L. Measuring the impact of post-earthquake destination risk perception on travel behavior intention in Jiuzhaigou scenic area. *Yunnan Geogr. Environ. Res.* **2020**, *32*, 26–31. [CrossRef]
43. Caber, M.; González-Rodríguez, M.R.; Albayrak, T.; Simonetti, B. Does perceived risk really matter in travel behaviour? *J. Vacat. Mark.* **2020**, *26*, 334–353. [CrossRef]
44. Guan, R. Research on the perceived value enhancement path of online apparel based on S-O-R model. *Text. Her.* **2013**, 835, 116–118. [CrossRef]
45. Zheng, Y. Research on the Mechanism of the Perceived Quality of Subsidy Policy on Consumers' Willingness to Purchase Household Photovoltaic. Master's Thesis, China University of Mining and Technology, Beijing, China, 2020. [CrossRef]



46. Xu, H.; Xu, S.R.; Wang, R.J. Identifying and analyzing differences in consumer perceived risk dimensions in tourism. *J. Tour.* **2013**, *28*, 71–80.
47. Ai, Z.Q.; Shen, Y.J. Research on the relationship between technology risk and public perception. *J. Renmin Univ. China* **2012**, *26*, 107–114.
48. Xu, Y.; Ma, W.; Xu, X.; Xie, Y. How Duty-Free Policy Influences Travel Intention: Mediating Role of Perceived Value and Moderating Roles of COVID-19 Severity and Counterfactual Thinking. *Front. Psychol.* **2022**, *13*, 271–285. [CrossRef]
49. Toshihiro, O. Traveling and eating out during the COVID-19 pandemic: The Go To campaign policies in Japan. *Jpn. World Econ.* **2022**, *64*, 101157. [CrossRef]
50. Lin, B.; Guan, C. Determinants of household food waste reduction intention in China: The role of perceived government control. *J. Environ. Manag.* **2021**, *299*, 113577. [CrossRef]
51. Abuliezi, R.; Kondo, A.; Niitsu, K.; Ota, E. Health care graduate students' perceived control and preventive behavior for COVID-19 in Japan and the United States: A cross-sectional study. *Front. Public Health* **2022**, *10*, 965897. [CrossRef]
52. Zhou, L.; Dai, Y. How Smog Awareness Influences Public Acceptance of Congestion Charge Policies. *Sustainability* **2017**, *9*, 1579. [CrossRef]

**Disclaimer/Publisher's Note:** The statements, opinions and data contained in all publications are solely those of the individual author(s) and contributor(s) and not of MDPI and/or the editor(s). MDPI and/or the editor(s) disclaim responsibility for any injury to people or property resulting from any ideas, methods, instructions or products referred to in the content.

## Article

# What Does the Concept of Resilience in Tourism Mean in the Time of COVID-19? Results of a Bibliometric Analysis

Oumaima Lamhour<sup>1</sup>, Larbi Safaa<sup>1</sup> and Dalia Perkumienė<sup>2,\*</sup>

<sup>1</sup> Laboratory of Applied Sciences for the Environment and Sustainable Development, Higher School of Technology Essaouira, Cadi Ayyad University, Km 9, Route d'Agadir, BP. 383, Essaouira 40000, Morocco; o.lamhour.ced@uca.ac.ma (O.L.); safaa.larbi@uca.ma (L.S.)

<sup>2</sup> Business and Rural Development Research Institute, Faculty of Bioeconomic Development, Vytautas Magnus University, 53361 Kaunas, Lithuania

\* Correspondence: dalia.perkumiene@vdu.lt

**Abstract:** The spread of the COVID-19 pandemic has had a major impact on tourism, giving significant importance to resilience strategies for this sector. Indeed, over the past three years, an increasing amount of research has been conducted on tourism resilience without any overall analysis of these publications. This study aims to conduct a bibliometric analysis in order to identify research trends in the field as well as explore the various gaps in the literature on the subject studied during and after the pandemic. A selection of 114 Scopus-indexed articles published between 2020 and early 2023 on tourism resilience was analyzed by two bibliometric tools, VOS viewer and R bibliometrix. The results show that China, the United States, and Spain are the leading countries in this field of research. The articles' authors, the affiliations, and the countries involved in research in this field were not able to compose a close, extensive, and collaborative network. The journal Sustainability (Switzerland), published by MDPI, is at the top of the list. This work identifies three dominant study themes: (1) tourism and sustainable resilience; (2) livelihood resilience; and (3) community resilience. This study provides a benchmark for future researchers with new study directions in the field of tourism resilience.

**Keywords:** resilience; tourism; COVID-19; bibliometric study; VOS viewer; R bibliometrix



**Citation:** Lamhour, O.; Safaa, L.; Perkumienė, D. What Does the Concept of Resilience in Tourism Mean in the Time of COVID-19? Results of a Bibliometric Analysis. *Sustainability* **2023**, *15*, 9797.

<https://doi.org/10.3390/su15129797>

Academic Editors: Zygmunt Kruczek and Bartłomiej Walas

Received: 19 May 2023

Revised: 6 June 2023

Accepted: 7 June 2023

Published: 19 June 2023



**Copyright:** © 2023 by the authors. Licensee MDPI, Basel, Switzerland. This article is an open access article distributed under the terms and conditions of the Creative Commons Attribution (CC BY) license (<https://creativecommons.org/licenses/by/4.0/>).

## 1. Introduction

COVID-19, a global pandemic of unprecedented impact, has caused great concern in recent years. This crisis had a devastating effect on the tourism industry, including travel limitations and cancellations, border closures, and widespread business downturns [1–6].

The tourism sector was the first to suffer the flagrant consequences of the COVID-19 crisis. According to data from the World Travel and Tourism Council (WTTC), the contribution of the travel and tourism sector to global output has fallen precipitously, from around 10.5% in 2019 to 5.5% in 2020, which will result in the loss of 62 million jobs worldwide [2]. Tourism companies found themselves obliged to face different risk situations, which pushed them to develop their resilience and adapt quickly to the different underlying disruptions, whether they were economic, political, or social [7–10].

The concept of resilience, which initially originated in the physical sciences and was transposed into the social sciences [11,12], has attracted increasing interest from researchers in the tourism sector [8,13–18]. Understanding the notion of resilience is conceptually complex, as it is part of a transdisciplinary approach [19]. It can be defined as a capacity to counteract a risk or to return to a state of stability after having experienced it, or as a process of interaction between prevention elements and the different risks [3]. In other words, a resilient system is the result of a structure capable of distinguishing itself by its ability to absorb, recover from, and adapt to different known and unknown risks [20]. In the context of tourism, resilience is defined as the industry's ability to diligently deal with

disasters and self-inflicted crises in order to maintain stability while ensuring the flexibility and diversity necessary for innovation and further development [21,22].

Prior to COVID-19, Wut et al. (2021) conducted a systematic review of relevant research areas in the context of the tourism and hospitality industries regarding crisis management and the conceptualization of resilience [23]. Following this line and in order to complete the elucidation of the concept, this study explored a review of the literature on the concept of resilience in the tourism sector after the spread of the COVID-19 pandemic, which began on 1 January 2020 and has spread around the world [24], especially since a significant amount of research has been conducted recently.

From this perspective, it is essential and significant to study how the concept of resilience in tourism was conceptualized after the emergence of the COVID-19 crisis. This study aims to review and investigate the literature dealing with the resilience of the tourism industry to external risks and shocks. Therefore, a descriptive and bibliometric analysis of the publications is conducted to characterize research trends.

Some researchers have already conducted and published bibliometric studies in various scientific fields, including tourism management sciences [25–30]. For example, Menons et al. have published a useful bibliometric study to help PhD students and tourism researchers identify emerging themes in tourism and hospitality after the COVID-19 pandemic and decide which journals to publish in and which issues to address in order to obtain a high-quality publication [31]. However, to our knowledge, no study has yet been published on the resilience of tourism after the spread of COVID-19. This study can also contribute to the decisions taken by practitioners to define a direction for the future of the tourism industry.

Bibliometric analysis uses mathematical methods to perform a quantitative analysis of research articles on a specific topic [9]. It can be used to assess the quality of studies, identify the most important areas of research, and anticipate future directions for studies [10]. By conducting a bibliometric analysis, it is possible to identify the characteristics and patterns of published articles in any scientific discipline. In addition, this popular approach can help identify schools of thought in a particular field of study [32], and it allows the researcher to summarize scientific production in terms of quantity and quality [33].

The objective of this work was not only to discover the different aspects of research and application of resilience in tourism in the face of different risks, but also to provide an opportunity to discuss what the authors have highlighted. Specifically, this review aimed to reveal the current state of research and identify emerging trends in this field in order to answer the following questions:

How was the growth of publications on the resilience of the tourism industry after the spread of the COVID-19 pandemic indexed in the Scopus database between 2020 and 25 April 2023?

What are the main journals, authors, and publications to consider for future studies on tourism resilience after the spread of COVID-19?

What are the main emerging topics in tourism research?

What research directions can be recommended?

To address this issue, a selection of 114 articles published between 2020 and 2023 was obtained from the Scopus database and analyzed using Bibliometrix R Studio and VOS viewer tools. The remainder of the article will be organized as follows: Section 2 describes the materials and methods that were applied to address the research topic. Section 3 illustrates the results of the bibliometric analysis, while Section 4 discusses the results. The most relevant research topics are detailed in Section 5. Section 6 presents a conclusion as well as proposals for future research.

## 2. Materials and Methods

The Scopus database was chosen to extract our selection of papers for bibliometric analysis. The papers in the study were collected from the Scopus database, a widely recognized and inclusive research database that is one of the largest bibliographic, abstract,

and citation databases available today [31,34]. This database was also selected for its extensive coverage of tourism journals, which is superior to that of Web of Science [35–37]. To carry out this study, the guidelines of PRISMA 2020 (Preferred Reporting Items for Systematic Reviews and Meta-Analyses) were followed in order to filter the data with a guarantee of objectivity and clarity [38].

Hossain et al. [39] defined this method as a systematic implementation following a predefined process or path, as shown in the Prism diagram [40], with four overarching steps: identification, selection, eligibility, and inclusion. We conducted a literature search in the Scopus database with the following search formula: ‘resilience’ and ‘tourism’.

Only papers that are closely related to our topic were considered; in other words, only papers that had both concepts in the title, abstract, and keywords were considered.

As inclusion criteria, the type of papers (article, journal, and conference paper), the English language, the time frame (2020–2023), and the publication stage (final) were defined.

The specific choice of the period from January 2020 to 25 April 2023 (the period covered by the data extraction) is argued by our main objective of examining the literature addressing the topic of the resilience of the tourism sector after the emergence of COVID-19. The criterion of English as the language of publication is justified by our choice of keyword language standardization. English-language documents account for over 96% of online publications between 2020 and the date of data extraction. To refine our selection of articles, a manual filtration of the articles is required; in this framework, the articles that do not have a relationship with our subject have been removed from the sample. Finally, 114 publications that met the different inclusion criteria were retained (Figure 1).

To generate results, two bibliometric tools were adopted: the R bibliometrix tool and the VOS viewer program. Bibliometrix is a free scientific analysis and mapping tool that allows researchers to statistically measure productivity in a specific research area [41]. We used it to graphically present the number of publications per year, the most revealing journals and publications, the most cited authors with their affiliated institutions and countries, and the thematic map using an Excel file.

The VOS viewer program developed by van Eck and Waltman was used to analyze and visualize the relationships between the most significant co-words [42]. The program is freely available to the bibliometric research community. The VOS viewer can be used, for example, to make author or journal maps based on co-occurrence data or to build keyword maps based on co-occurrence data. Microsoft Office was also used to present the data in graph form (temporal distribution of articles and authors’ affiliations). In our study, we used the VOS view to extract a network of the most relevant themes.

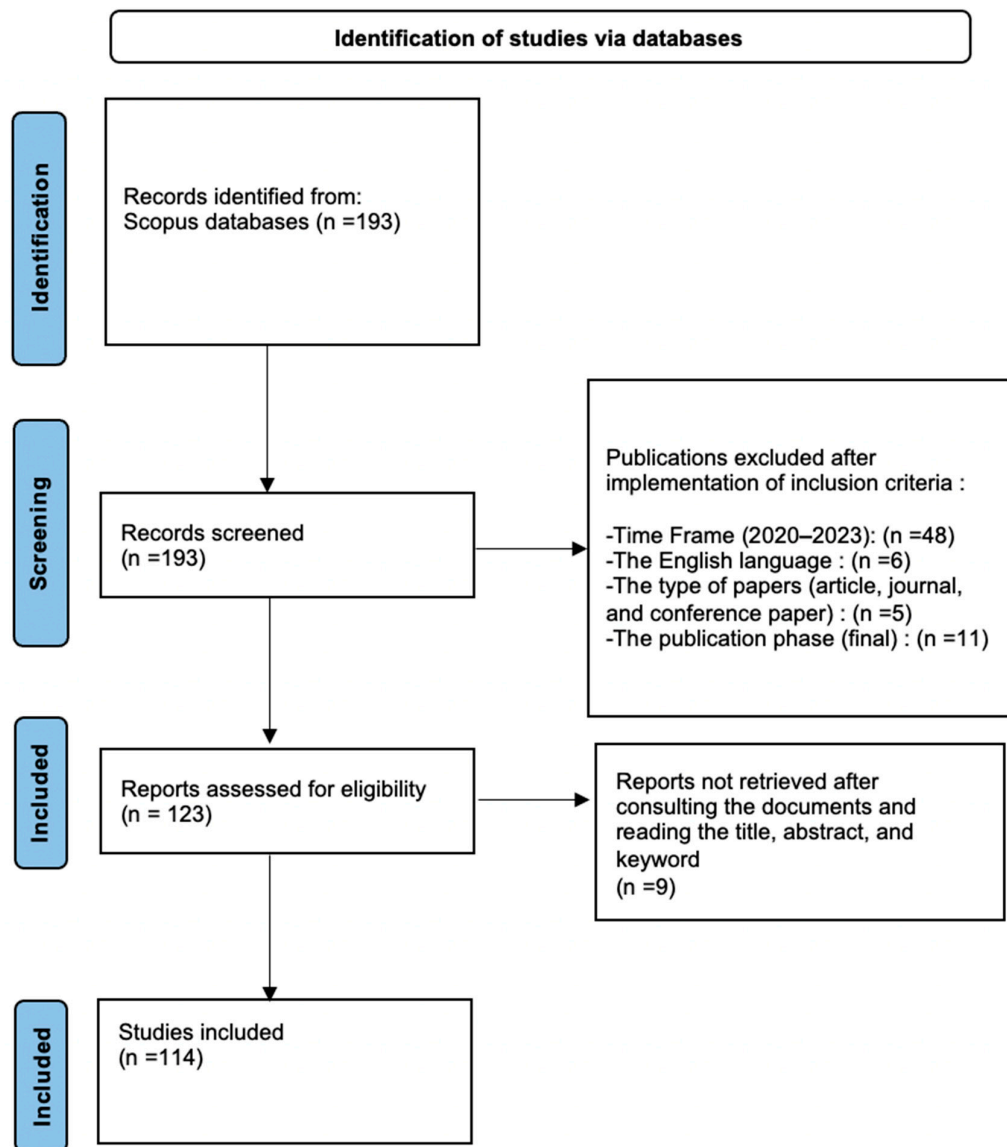

Figure 1. Filtering flowchart using the PRISMA method.

### 3. Results

#### 3.1. Summary Information

The number of publication results including the words ‘resilience’ and ‘tourism’ in the title, abstract, and keywords is 114 papers, published between 2020 and 2023 in 62 sources. The results also indicate that 319 authors contributed to research on the topic of resilience in the tourism sector after the spread of the COVID-19 pandemic (Table 1). Research in this area grew exponentially between 2020 and 2022. Indeed, there were 19 new online publications in 2020 and 16 new online publications in the first four months of 2023. Single-author papers contributed 14 publications (Figure 2).

Such a positive trend of continued growth is a dramatic indication that tourism resilience research between 2020 and April 2023 has great potential for the future.

Articles make up 93% of the published documents, while conference papers and reviews represent only 4% and 3%, respectively.

**Table 1.** Summary information generated with the R bibliometrix tool.

Description	Results
Period	From 2020 to 2023 (Until 25 April 2023)
Number of publications	114
Sources (Journals)	62
Authors	319
Average number of citations per document	12.29
References	7428
Keywords plus	378
Author keywords	432
Authors of single-author documents	13
Single-author documents	14
Co-authors per document	3.01
Index of international cooperation	30.7

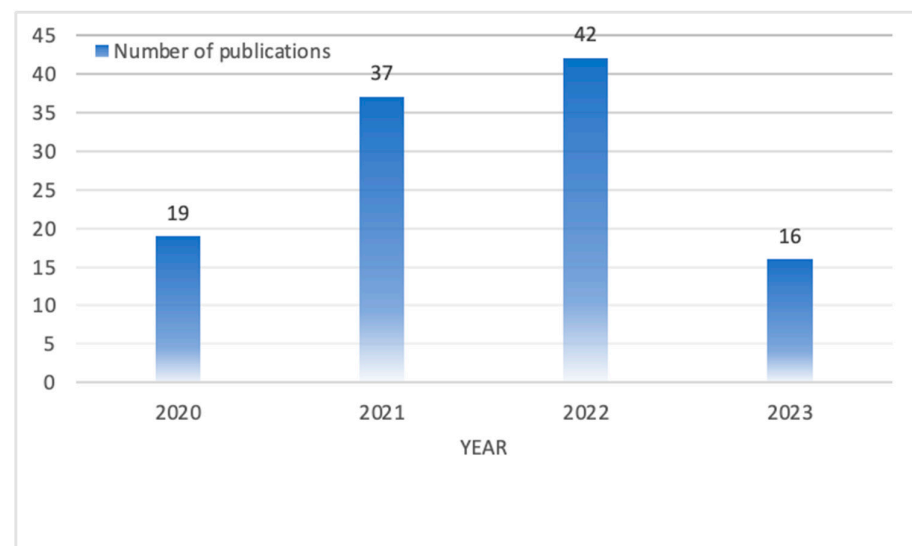
**Figure 2.** The temporal evolution of the number of publications since the spread of the COVID-19 pandemic.

### 3.2. Analysis of Keyword Occurrences

The main objective of a bibliometric study is to explore the themes and research trends in a predefined field, thus determining the most popular terms and the relationships between them [43], and this cannot be achieved without conducting an analysis of the keyword occurrences. Co-word analysis is a content analysis method based on the co-occurrence patterns of keywords in a manuscript collection. Its aim is to recognize the links between the ideas present in the themes addressed in the textual corpus. This approach has enabled the creation of a strategic diagram highlighting the relative relevance of topics related to the resilience of the tourism sector after the spread of the COVID-19 epidemic. The VOS viewer allows us to map the network of the most frequent keywords in our article selection [44]. A total of 23 keywords with a frequency of  $\geq 5$  co-occurrences were selected from 724 keywords (Table 2). As shown in Figure 3, a network representation of these keywords is generated by the program. The most common keywords are represented by circles, as the size of the circle increases the more frequently the term appears, while the links indicate the associations with the words, and the nodes of the same color group form a cluster of keywords. The thickness of the links shows the strength of the links; the greater the thickness, the greater the strength of association between the words and the frequency of their existence in the same publication. The distance between the two nodes is a negative function of the number of occurrences between the keywords.

Table 2. Grouping of keywords (personal elaboration).

Clusters	Theme	Articles Included	Keywords	Occurrence	The Strength of Links			
Cluster 1: red	Sustainable resilience	[45–49], [9,50–54], [55–60], [14,15,61–65], [16,18,66–70], [10,71–76], [17,77–82], [83–87]	COVID-19	35	99			
			tourism management	18	71			
			sustainability	13	37			
			sustainable development	9	24			
			ecotourism	8	29			
			disaster management	8	21			
			tourism resilience	7	14			
			organizational resilience	7	9			
			destination resilience	7	8			
			crisis management	7	23			
Cluster 2 green	livelihood resilience	[20,21,88,89] [90–94], [95–99], [2,100–103], [28,104–106], [107–110], [111–114], [43,115,116], [117–120], [121–124]	tourism economics	5	19			
			sustainable tourism	5	14			
			tourism	53	128			
			resilience	48	154			
			China	13	38			
			pandemic	9	37			
			epidemic	5	23			
			livelihood	6	23			
			Cluster 3 blue	Community resilience	[125–129], [130–133], [134–137], [138–142], [143,144].	tourism development	20	64
						tourist destination	14	51
community resilience	10	20						
community-based tourism	9	21						
tourism market	6	27						
community resilience	6	27						

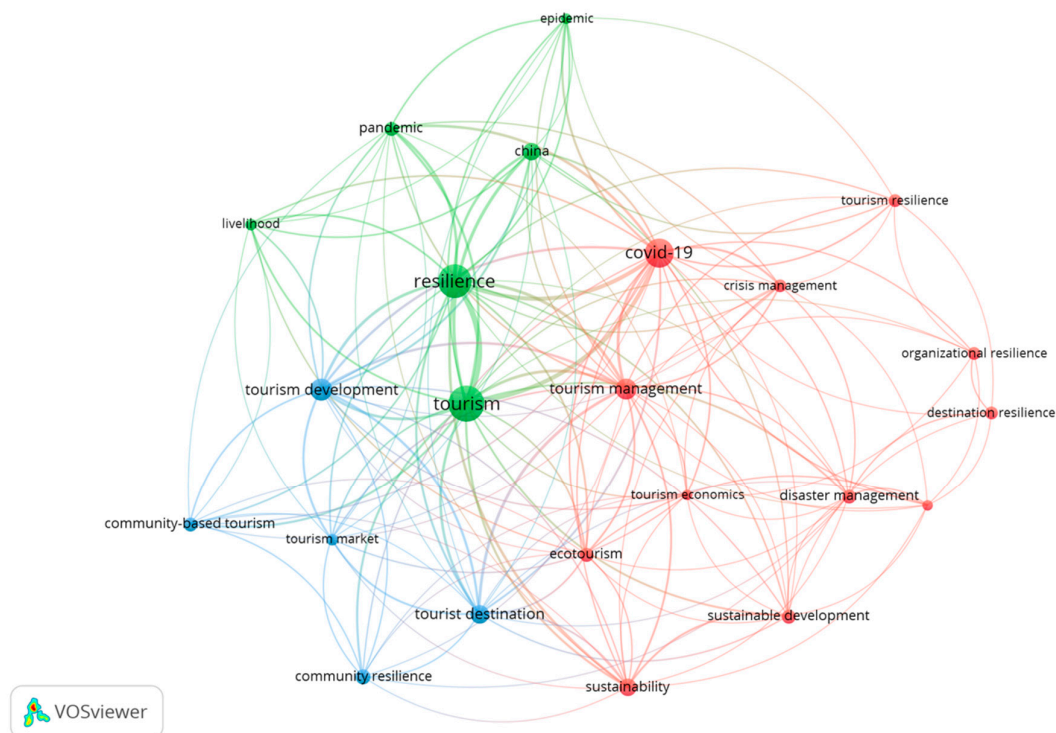

Figure 3. A map of the keyword network generated by the VOS viewer software.

Our network consists of three clusters with 154 links and 458 in link strength, namely cluster 1 (12 key terms), cluster 2 (6 keywords), and cluster 3 (5 keywords).

In previous studies, a visualization of the network through the VOS viewer allowed for the generation of 11 groups by Wang et al. [35], 6 groups by Paeffgen [36], and 4 groups by Della Corte et al. [37].

Cluster 1, in red, has the term “COVID-19” as a central node and includes other keywords such as “sustainability”, “sustainable development”, “ecotourism”, and “disaster management”. Therefore, this cluster concerns the impact of the COVID-19 pandemic on sustainable tourism development as well as the strengthening of sustainable resilience to different shocks and risks. It should be noted that this cluster consists of the first four publications in ranking by the number of citations (“Reviving the tourism industry post-COVID-19: to a resilience-based framework”, “Responses to COVID-19: the role of performance in the relationship between small hospitality enterprises’ resilience and sustainable tourism development”, “Psychological resilience, organizational resilience, and life satisfaction in tourism firms: insights from the Canterbury earthquakes”, and “Time for a reset? COVID-19 and tourism resilience”). This indicates the growing interest and importance of this research topic. Prayag is the dominant author in this cluster, with three publications. This author proposes a conceptual reflection based on the “new normal” of tourism resilience (engineering, ecology, and socio-ecology), which can be argued by the increased trend of topics dealing with the integration of sustainable practices in tourism resilience. This group is composed of more than half of the number of publications (52 articles).

The terms “resilience” and “tourism” are the largest nodes in Cluster 2 in green, followed by “China”, “pandemic” and “livelihood”. As a result, this cluster focuses on the perception of livelihood resilience, with most of the publications related to this cluster adopting China as the research terrain. In this framework, we can mention the publications of Chen, who works on the sustainability of livelihoods in the face of changes in China’s rural areas. He proposes that collaborative agency can be a pillar of successful transformation.

Cluster 3 in blue is the smallest group in the network, and the word “tourism development” with the highest number of occurrences is related to other keywords such as “community resilience”, “community-based tourism”, “tourist destination” and “tourism market”. This group of words represents the theme of the impact of the pandemic on community-based tourism and the building of community resilience as an effective remedy to unpredictable events. Kim is the leading author of this cluster, with five publications focusing on the importance of tourism in community resilience and its critical role in dealing with various risks.

To obtain themes, the thematic analysis uses groups of authors’ keywords and their interconnections. These themes are characterized by their properties (density and centrality). Density is represented by the vertical axis, while centrality is represented by the horizontal axis (Figure 4).

Motor themes (upper-right quadrant): sustainability, sustainable development, ecotourism, China, COVID-19, tourism management, tourist destination, ecotourism; although these are developed and relevant themes, they are almost too general. Because of their high centrality and density, they are the main topics for structuring a research field. Niche themes (upper-left quadrant): rural population, rural development, psychology, and New Zealand; these have well-developed internal links but few external links. These themes therefore have a high centrality but a low density, and their contribution to the development of the tourism resilience field remains marginal. Emerging or declining themes (lower-left quadrant): governance and indigenous knowledge; these themes are still at an embryonic stage within the theme of tourism resilience in the wake of the COVID-19 pandemic. The themes of community resource and ecosystem resilience seem to be emerging but cross-cutting with the basic themes, indicating that some of the topics within these themes are necessary to develop the field of tourism resilience. Basic themes (lower-right quadrant):



rural area, economic activity, and culture; these are low-density, high-centrality themes that cut across this area of research.

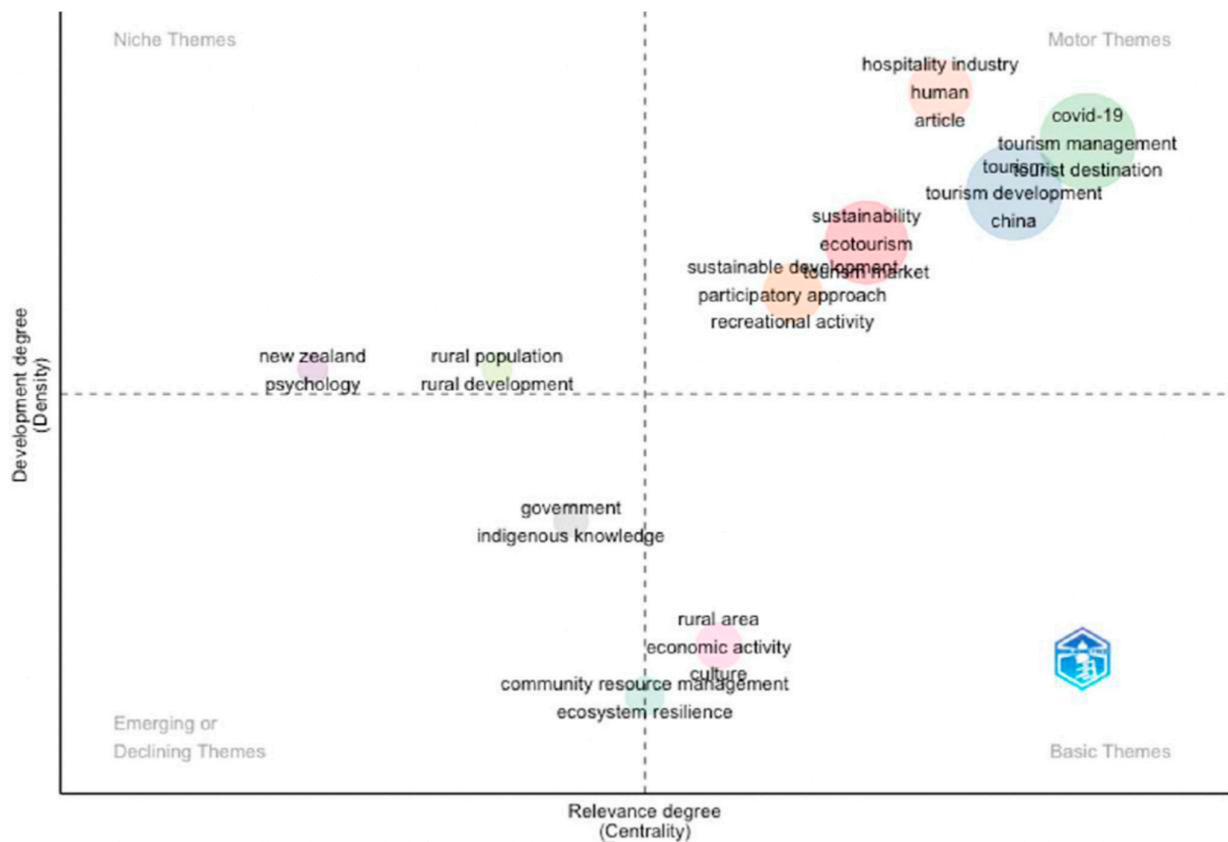

Figure 4. Thematic map generated by R bibliometrix.

### 3.3. Analysis of Contributing Journals

The 114 papers on tourism resilience whose year of publication is between 2020 and 2023 are published in a wide range of journals (62 journals). Topping the list is the journal Sustainability (Switzerland), with the largest number of publications (n = 20) edited by MDPI, while Tourism Geographies (n = 6) came in second, published by Taylor & Francis Group, and Current Issues in Tourism came in third (n = 5). Tourism Management Perspectives, Current Issues in Tourism, and Sustainability (Switzerland) are the most relevant journals in terms of total citations, with 351, 252, and 106 citations, respectively. Table 3 shows the top 10 journals with the percentage of contributions, h\_index, m\_index, citations, quartile, and publisher of each journal.

Table 3. The most active journals between 2020 and 2023, according to data provided by Bibliometric and Scimago Journal & Country Rank (SJR).

Title of the Journal	Percentage of Contribution	h_Index	m_Index	Citations	Quartile	Publisher
SUSTAINABILITY (SWITZERLAND)	16%	7	1.75	106	Q1	MDPI
TOURISM GEOGRAPHIES	5%	4	1.33	52	Q2	Taylor & Francis Group
CURRENT ISSUES IN TOURISM	4%	4	1.25	252	Q1	Current Issues in Tourism
TOURISM MANAGEMENT	3%	3	1.00	42	Q1	Elsevier

Table 3. Cont.

Title of the Journal	Percentage of Contribution	h_Index	m_Index	Citations	Quartile	Publisher
TOURISM MANAGEMENT PERSPECTIVES	3%	3	0.75	351	Q2	Elsevier
ANNALS OF TOURISM RESEARCH EMPIRICAL INSIGHTS	2%	3	1.50	16	Q1	Elsevier
JOURNAL OF HOSPITALITY AND TOURISM MANAGEMENT	2%	2	1.00	54	Q1	Elsevier
JOURNAL OF SUSTAINABLE TOURISM	2%	3	0.75	57	Q1	Taylor & Francis Group
LAND	2%	1	3.90	15	Q3	MDPI
WORLDWIDE HOSPITALITY AND TOURISM THEMES	2%	2	0.66	17	Q3	Emerald Group Publishing Ltd.

### 3.4. Analysis of the Most Cited Publications

Table 4 presents the most impactful articles in the field of tourism resilience based on the number of citations received by the authors. The results reveal that two articles were cited more than 100 times: “Reviving tourism industry post-COVID-19: A resilience-based framework” (n = 314) and “Responses to COVID-19: The role of performance in the relationship between small hospitality enterprises’ resilience and sustainable tourism development” (n = 122). These two contributions were written by Sharma et al. [45] and Sobaih et al. [46], respectively. The first publication is a study that proposes government response, technological innovation, local ownership, and consumer and employee confidence as key factors in tourism resilience and announces that it is time to transform the tourism industry with a new framework based on sustainable tourism. The second publication validates the direct and significant impact of resilience on sustainable tourism development through performance mediations.

Table 4. Top 10 scientific papers in the field of tourism resilience.

Publication (Type of Publication)	Title of the Journal	Year of Publication	Citations	Citations per Year:	Total Normalized Citations	Reference
Reviving tourism industry post-COVID-19: A resilience-based framework (article)	Tourism Management Perspectives	2021	314	104.67	15.70	[45]
Responses to COVID-19: The role of performance in the relationship between small hospitality enterprises’ resilience and sustainable tourism development (article)	International Journal of Hospitality Management	2021	122	40.67	6.10	[46]
Psychological resilience, organizational resilience and life satisfaction in tourism firms: insights from the Canterbury earthquakes (article)	Current Issues in Tourism	2020	89	22.25	4.43	[47]

Table 4. Cont.

Publication (Type of Publication)	Title of the Journal	Year of Publication	Citations	Citations per Year:	Total Normalized Citations	Reference
Time for Reset? COVID-19 and Tourism Resilience (article)	Tourism Review International	2020	83	20.75	4.13	[145]
Tourism and Hospitality industry resilience during the COVID-19 pandemic: Evidence from England (article)	Current Issues in Tourism	2022	67	33.50	11.97	[21]
Social capital: An investment towards community resilience in the collaborative natural resources management of community-based tourism schemes (article)	Tourism Management Perspectives	2020	36	9.00	1.79	[125]
The adaptive resilience of living cultural heritage in a tourism destination (article)	Journal of Sustainable Tourism	2020	33	8.25	1.64	[126]
Reimagining resilience: COVID-19 and marine tourism in Indonesia (article)	Current Issues in Tourism	2020	31	10.33	1.55	[48]
Community eco-tourism in rural Peru: Resilience and adaptive capacities to the COVID-19 pandemic and climate change (article)	Journal of Hospitality and Tourism Management	2021	29	9.67	1.45	[127]
Tourism Potentials in Post-COVID19: The Concept of Destination Resilience for Advanced Sustainable Management in Tourism (article)	Tourism Planning & Development	2023	25	25.00	9.09	[49]

“Psychological resilience, organizational resilience, and life satisfaction in tourism firms: insights from the Canterbury earthquakes”, written by Prayag et al. [47], comes in third place (n = 89). This study explores the relationship between psychological and organizational resilience. Traskevich and Fontanari [49] had the lowest number of total citations (n = 25) in this top ten selection with the publication “Tourism Potentials in Post-COVID19: The Concept of Destination Resilience for Advanced Sustainable Management in Tourism”.

### 3.5. The Most Prolific Authors and Countries

Based on the bibliometric analysis, Table 5 describes the most active authors in the research area of tourism resilience during and after the pandemic, along with the rate of co-authored papers. At the beginning of the list, we find Kim, who is the most present author in this field with five publications [129,130,139,140,142]. Two of these articles were written in collaboration with Yang, who shares second place as the most active author. These authors propose community resilience as a primary tool to cope with environmental uncertainty and adverse events, especially COVID-19, and the role of tourism destination intelligence and tourism industry specialization in this resilience. Among the most important authors in terms of the number of publications, also in second place, we find Prayag with three publications. In this work, the author examines three types of resilience: psychological, employee, and organizational. This work [47] gives future researchers a clear understanding of current perspectives on the resilience of destinations, organizations, and tourists [145] and of emerging research directions for the resilience of tourism with its new normality in engineering, ecology, and socio-ecology. In the same rank, we find Zhang with three

publications covering different research themes in tourism resilience: community tourism, sustainable resilience, and economic resilience.

**Table 5.** The most active authors on the theme of resilience in tourism.

Authors	Articles	Co-Written Articles
Kim	5	1.92
Prayag	3	2.25
Yang	3	1.08
Zhang	3	1.45
Chan	2	0.67
Chen	2	0.75
De Lacy	2	0.34
Gamage	2	0.34
Jang	2	0.83
Khalid	2	0.67

It is revealed that China is the most contributing country (21 papers) to research on the resilience of the tourism industry after the spread of COVID-19, followed by the United States (17 papers) and Spain (13 papers). The UK shares fourth place with Australia with a contribution of nine papers (Table 6). To shed light on the social structure of the scientific community dealing with our topic, a map of the geographical collaboration of authors on the topic of resilience in the tourism sector has been presented. It can be noted that the United States (14 in total link strength), the United Kingdom, Australia, and China are the four most collaborative countries. The strongest collaborative links are between the United States and the United Kingdom, China and Australia, and China and Japan. Spain has not achieved a single collaboration with the United Kingdom despite its third-place ranking in terms of the number of publications. Despite these collaborative links between these countries, the network of co-country researchers in the field of tourism resilience remains rather distant and less cooperative internationally.

**Table 6.** The most contributing countries on the theme of resilience in tourism.

Countries	Articles
CHINA	21
UNITED STATES	17
SPAIN	13
UNITED KINGDOM	9
AUSTRALIA	9
INDONESIA	8
NEW ZEALAND	8
MALAYSIA	5
INDONESIA	5
INDIA	5

The Bibliometrix or Biblioshiny Program allows researchers to export from the Scopus database a three-field plot of their choice; we preferred to examine the relationship between authors, countries, and keywords to get a clear idea about the scientific community on this topic [44]. As shown in Figure 5, there is an interaction between authors (left), countries (middle), and keywords (right) in the field of tourism industry resilience. In summary, U.S. researchers are interested in issues related to the resilience of community-based tourism to the SARS-CoV-2 pandemic; Chinese researchers are interested in the resilience of the livelihoods of households residing in tourism villages; and the Australian community is focusing on the resilience of tourism to the COVID-19 pandemic. This explains the increased interest of researchers in the topic under study (Figure 6).

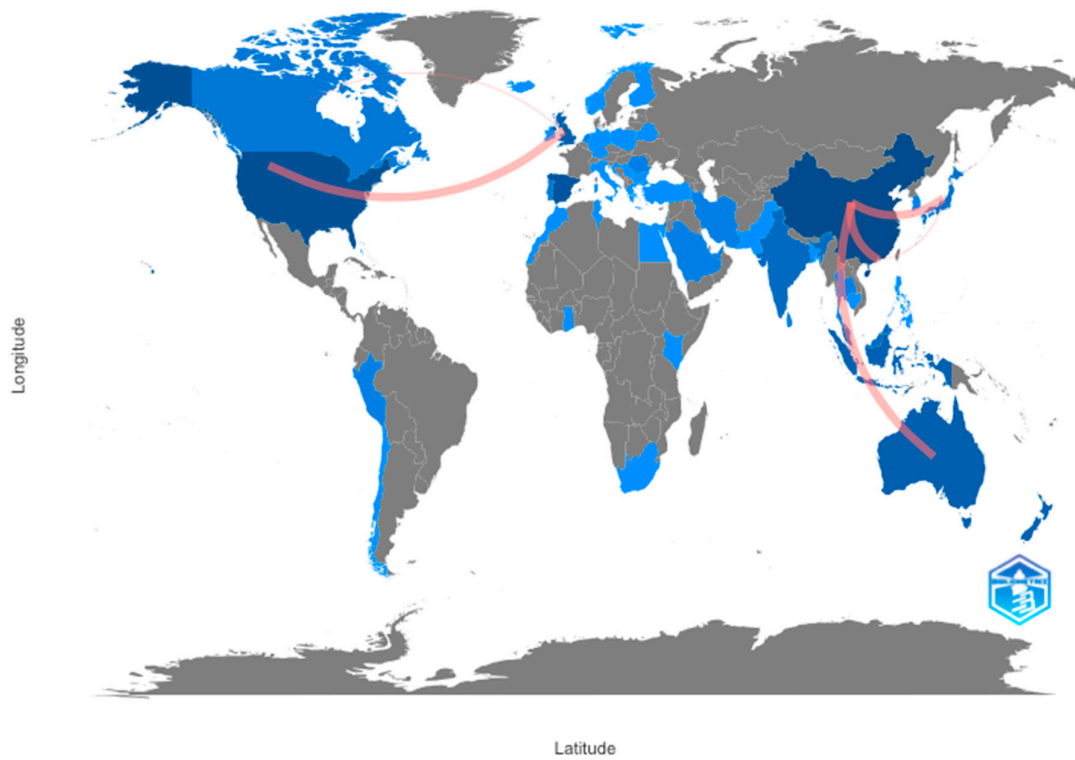

Figure 5. Geographic map of international cooperation generated by Bibliometrix.

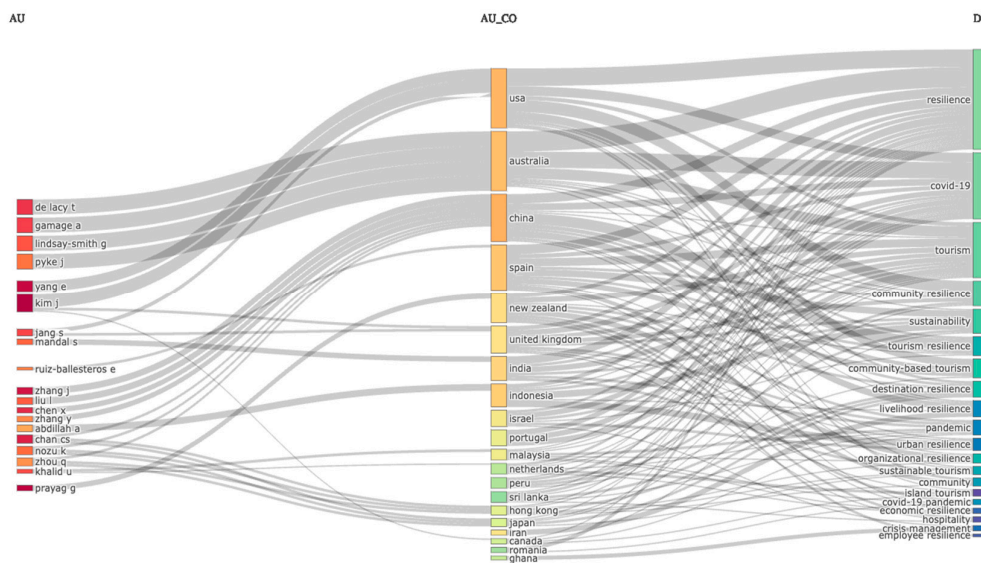

Figure 6. A three-field plot or Sankey diagram generated by R bibliometrix.

#### 4. Discussion

The last pandemic revealed the sensitivity of the tourism sector to various external shocks, such as natural disasters, armed wars, pandemics, political events, economic situations, and security problems [146]. Hence, stakeholders are obliged to strengthen the resilience of this industry [147]. This study was based on a descriptive and bibliometric analysis of Scopus-indexed publication data to identify up-to-date research on the resilience of the tourism industry at the time of the crisis and particularly after the spread of the COVID-19 pandemic, thus contributing to the debate on the resilience of the tourism sector in the face of various risks and disruptions and the prospects for a successful recovery [148]. Our objective is to map in terms of quantity and content. To do so, different types of

analysis were performed on 114 selected publications based on the guidelines of the PRISMA diagram, namely: co-author analysis, contributing journal analysis, the spatial distribution of publications, collaboration analysis between countries, and co-word analysis through the VOS program visualization.

The significant and accelerated increase in the number of publications between 2020 and early 2023 indicates that research on tourism industry resilience remains rich in future potential. Additionally, the large share (60%) of articles that are open access may show that the scientific community is increasingly interested in the issue of tourism resilience, especially post-COVID-19, and is also seeking to encourage the reading of articles in this area. This may also be a sign of increased funding for this research. The networks of co-authors and co-countries remain rather distant and less collaborative since the nodes of authors and countries were created individually. This may indicate that most researchers completed their research independently, with little or no cooperation from other researchers. However, some researchers did cooperate and collaborate with two to eight other researchers to produce results in the area of tourism sector resilience. Notable collaborations are only between the United States and the United Kingdom, China and Australia, and China and Japan. The percentage of conference papers related to the topic does not exceed 4%, which effectively confirms the reduced level of international collaboration in our sample, hence the need to establish more collaboration between authors and countries in the field. According to Umar et al. [43], research cooperation plays a crucial role in enhancing the quality and relevance of research work and responding to different global issues and problems, especially in the field of tourism.

This study also revealed that Sustainability (Switzerland) is the highest-ranked journal by far in terms of the number of publications (20 articles) and the third highest in terms of the number of citations (106 citations), after the journal Tourism Management with 351 citations and Current Issues in Tourism with 252 citations. The number of citations is a primary parameter in the bibliometric analysis, giving a guideline to future researchers on which journals to choose to publish their results [149]. According to our results, the seven journals that top the list of ranking journals by citations are listed in the Q1 and Q2 quartiles. Kim J., affiliated with the University of Florida, Gainesville, USA, is the most active author with five publications. This affiliation holds the number one position with seven publications. In terms of citations, the institutions of the University School of Management Studies, Guru Gobind Singh Indraprastha University in India, the Japan Institute of Management Studies in India, and the University of Puerto Rico in the United States collectively top the list with 314 citations.

## 5. Research Topics with the Highest Acuity

Research on the risks and external shocks that can affect the development of the tourism industry has largely confirmed the need for resilience in this context [39].

Resilience derives from the Latin word “resilio”, which means “to bounce back”. In the physical sciences, it can be evaluated as the ability of an object to return to its previous state following a shock or continuous pressure [20,57,60,74,127]. Recently, this concept has been applied in several domains, such as ecological and social systems and ecosystems. The concept of resilience in tourism is defined as the ability of the industry to recover from disruptions while minimizing potential negative consequences [150]. However, several studies have endorsed a multidimensional approach to this concept [103] based on learning, diversity, and the ability to adapt in various situations.

The two concepts of vulnerability and resilience are closely related in studies; in fact, Delaplace et al. [19], Ho et al. [72], and Prayag [10] confirmed that the two concepts are antipodes. What makes the vulnerability of tourism increase and its resilience decrease? Other researchers [28] have proposed that vulnerability and resilience are distinct but highly compatible concepts that can be used to analyze the resistance of the tourism sector in the face of different changes.

Our main objective is to identify popular research topics related to the conceptualization of the resilience of the tourism industry in the period after the spread of the COVID-19 pandemic. Additionally, since the keywords featured in the articles are linked to topics in these publications, an occurrence analysis of the keywords that appear in our article selection was conducted. By linking to previous reviews on either organizational resilience during the COVID-19 era [151] or destination resilience [152], as well as post-pandemic tourism recovery based on resilience [28], similar information on the increase in publications over time can be revealed, indicating a growing demand for academic research related to the conceptualization of tourism resilience.

The results outline three popular research themes, with future sections explaining these themes in detail (Figure 7).

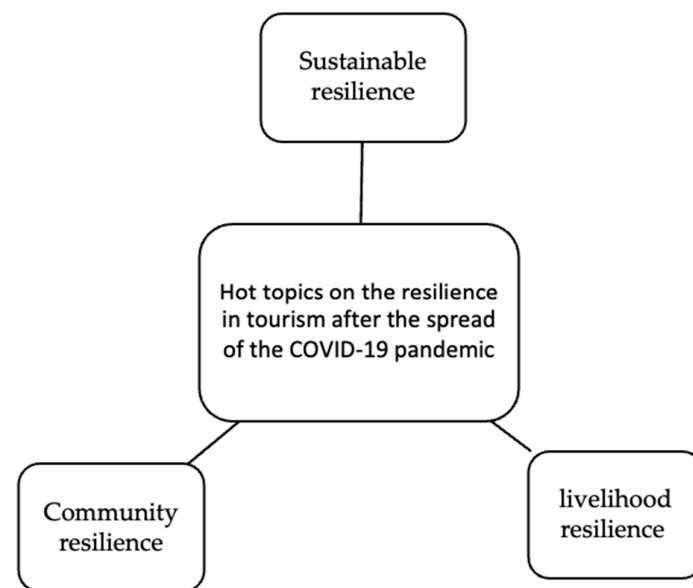

**Figure 7.** Thematic framework.

### 5.1. Integrating Sustainable Management into Tourism Resilience

Studies of tourism resilience are closely related to the concept of sustainability. For Sharma et al. [45], resilience to various risks, disasters, and pandemics directly and indirectly impacts the development of sustainable tourism. Now that Sobaih et al. [46] have confirmed that tourism in the pre-disaster stage must be transformed into sustainable tourism to build resilience, especially after the COVID-19 pandemic, planning for sustainable tourism becomes a crucial act [53]. Yiu and Cheung [59] proposed that the development of sustainability is based on the dynamic capabilities of resilience. The results of this study reveal that these dynamic capabilities mediate and moderate the long-term relationship between resilience and sustainable tourism. However, the identified conceptual framework of mediation is related to only three resilience factors: the resilience network, organizational resilience factors, and individual resilience factors. When tourism destinations are faced with undesirable risks, resilience is presented as a mode of adaptation, which translates into innovative planning techniques that lead to more sustainable lifestyles for their inhabitants [15], such as creating alternative products, enriching local knowledge, and improving the destination's image [65].

Conceptualizing the relationship between resilience and sustainability can open up new avenues of research, indicating how to create more sustainable and livable local environments around the world while examining other national and international contexts with the involvement of different stakeholders.

### 5.2. Livelihood Resilience

The concept of livelihoods consists of the abilities, knowledge, and actions of people to succeed in life, as well as their values, goals, and choices [62]. It includes the skills, assets, and activities that people need to succeed in life [90,124,153,154]. After the changes and mutations that the world has experienced in recent years, livelihood resilience is becoming a serious concern for researchers and even managers, especially in the tourism sector [90]. Livelihood resilience can be defined as the adaptability of actors and their abilities to take advantage of disturbances to improve their situation and preserve their way of life [9,48,58,90,92,101,124]. Requirements such as human agency, empowerment, independence, and access to resources are necessary for this resilience.

Shekari et al. [101] suggest that individual and collective agencies have a primary role in livelihood resilience. Chen et al. highlighted the role of vulnerable communities in enhancing resilience by using their existing potential to diversify their livelihood strategies [90].

One study revealed that the resilience of rural households' livelihoods strengthens their willingness to participate. Based on survey data in 22 tourism poverty alleviation villages located in the poor regions of western China, among the livelihood coping strategy groups, namely agriculture-oriented households, migratory households, and tourism-participating households, this study also revealed that buffering capacity was a significant driver of this willingness [101].

Through the analysis, it can be seen that Chinese researchers are experts on this topic; indeed, Dang et al. [120] revealed that among the first trends in Southeast Asia after the COVID-19 pandemic was the development and diversification of livelihoods. The majority of this research identifies the impact of this crisis on livelihoods. This can serve to provide several starting points for researchers to validate these implications and propose livelihood resilience strategies in other contexts.

### 5.3. Community Resilience

The COVID-19 pandemic has been destructive to international tourism, negatively impacting destinations, organizations, and local communities [92]. Communal tourism, based on community involvement and participation, community control and empowerment, and conservation and its contribution to community welfare and development, has also been severely affected [127]. This has prompted local community stakeholders to reflect on strategies for building community resilience.

Because there is no single definition for the concept of resilience, there is only agreement among most authors that resilience is the ability to bend, rebound, and survive. The definition of the term "community resilience" is linked to events and contexts. Noorashid and Chin [128] defined community resilience as the mobilization of community resources to thrive in an environment marked by uncertainty, change, risk, and surprise. Social capital has an important role in building community resilience (governance, finance, and competence); indeed, it allows for the ability to promote resilience in the collaborative management of community natural resources necessary for community tourism development [125]. Musavengane and Kloppers [125] stated that a cohesive social structure with a strong cultural identity consisting of customs and traditions allows for adaptation to the consequences of the COVID-19 pandemic.

### 5.4. Model Framework that Connects the Themes that Can Be Tested in Further Research

From a research perspective, it is hypothesized that open avenues could be relevant for other local communities seeking to improve their resilience to COVID-19 and climate change based on social capital and the definition of community resilience.

According to the abstracts of the articles, the resilience of tourism following the emergence of the COVID-19 pandemic was extensively investigated in case studies, particularly in China. China was one of the most investigated countries in this study, and it also had the highest number of articles published. However, it should be highlighted that this could be



read differently due to the fact that the pandemic began in this country and that China has taken a different political approach to COVID-19 measures. Indeed, it is conceivable that most COVID-19 studies in China began earlier than in other parts of the world; therefore, this area of research necessitates academics focusing on conceptualizing tourism business resilience.

Based on the study of keyword occurrences, a conceptual framework is suggested that brings together the three themes of resilience in sustainable tourism, communities, and livelihoods that can be tested in further research (Figure 8).

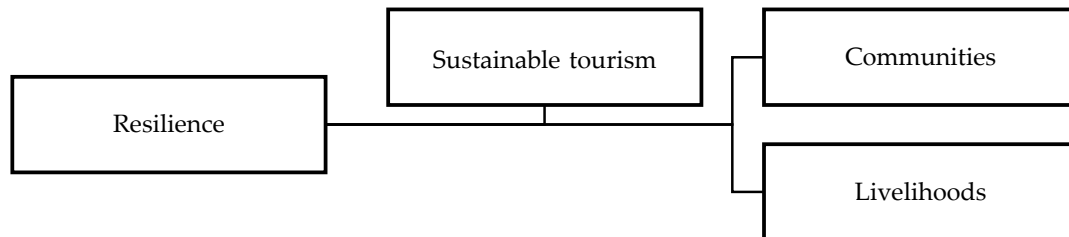

**Figure 8.** A model framework that connects the themes that can be tested in further research.

The conceptual framework highlights the links and interactions between resilience, sustainable tourism, communities, and livelihoods. Resilience refers to the ability of a system to resist, adapt, and recover from disturbances and shocks. In the context of tourism, this implies the ability of a tourism sector to cope with crises, such as natural disasters, health crises, or climate change, while maintaining its activities and preserving its long-term environmental, social, and economic impacts. Sustainable tourism aims to promote tourism practices that minimize negative impacts on the environment, preserve local culture and resources, and contribute to the well-being of local communities. The aim is to develop tourism that is environmentally friendly, socially inclusive, and economically viable. Communities are key players in sustainable tourism and the sector's resilience because they are directly impacted by tourism and can play an active role in planning, managing, and promoting sustainable tourism. Local communities can benefit economically from tourism, but it is also essential to ensure that they retain their cultural identity, heritage, and traditional livelihoods.

Livelihoods refer to the economic activities that enable individuals and communities to meet their basic needs. In the context of tourism, it is important to ensure that the livelihoods of local communities are not compromised but rather strengthened by sustainable tourism. This can involve the creation of local employment opportunities, the development of local entrepreneurship, and the promotion of traditional know-how. This conceptual framework highlights the importance of promoting a holistic approach to tourism that integrates resilience, sustainable tourism, local communities, and livelihoods. It underlines the need to develop strategies and policies that take these different aspects into account to ensure the long-term sustainability and resilience of the tourism sector.

In our paper, we have addressed emerging research themes and provided suggestions to help researchers and the stockholders of the tourism industry develop and improve their research programs and practices. We have also proposed a conceptual framework of tourism resilience based on the themes found in the keyword occurrence analysis, which presents a solid basis for future research to test, develop, and discuss.

The aim is to conduct original and transformative studies that will contribute to positive reconstruction, making tourism a more sustainable, responsible, and meaningful activity. Identifying authors in our study, their affiliations, and countries, as well as the journals that have made the greatest contribution in this field of research, helps future researchers identify the relevant literature and publish their work in high-quality journals with a direct correlation to their research topic.

## 6. Conclusions, Limitations, and Perspectives for Further Research

We have a favorable trend of continuous growth in this topic area, which is a strong indicator that tourism resilience research between 2020 and April 2023 has significant future potential.

This network of keywords is characterized by the dominance of the keywords tourism, resilience, and COVID-19 and the emergence of three popular topics: sustainable resilience, livelihood resilience, and community resilience. China, the United States, Spain, and Australia are the countries most involved in tourism resilience research. The collaborative network between these countries remains distant and less collaborative, which makes it necessary for the research community in this area to develop more collaborations to gain an international perspective on the research issues. The highest-ranked journal is Sustainability (Switzerland), with 20 publications, which is an open-access journal with a rapid review process and a peer review committee. This study shows the large number of publications edited by this journal. Kim, the most recent contributor to this topic with five articles, advocates for community resilience as a fundamental strategy for dealing with environmental uncertainty and catastrophic occurrences, particularly COVID-19, as well as the importance of tourism destination information and tourism industry specialization in this resilience. This means that he has carried out in-depth research and produced significant results that enrich the overall understanding of community resilience.

Our study will be a basis for researchers to choose the most relevant journals and to have a clear view of new research tracks, as well as to encourage the cooperation of authors and countries in untapped research fields.

In this field of study, which is rarely conducted on this scale, several articles on the resilience of the tourism industry have been published on a global scale.

Staying current and writing on issues with future potential can help researchers accomplish successful publications. The purpose of this bibliometric study is to provide an overview of the current literature on the resilience of the tourism sector following the spread of COVID-19, which is one of the most relevant subjects for future research, and to recommend a conceptual framework that brings together three themes of resilience in sustainable tourism, communities, and livelihoods that can be tested in future research.

Our study is limited by the choice of a single database, as only articles published between 2020 and 2023 in the Scopus database were selected as an infrastructure for the bibliometric study. It is recommended to combine future searches between several databases, namely Scopus, Web of Science, Google Scholar, and PubMed, to ensure deeper results.

In conclusion, this work presents a comprehensive review of research on tourism resilience after the emergence of COVID-19 that may be a relevant source for future research.

**Author Contributions:** Conceptualization, L.S., O.L. and D.P.; methodology, O.L., L.S. and D.P.; data curation, O.L., L.S. and D.P.; writing—original draft preparation, O.L., D.P. and L.S.; writing—review and editing, D.P. and L.S. All authors have read and agreed to the published version of the manuscript.

**Funding:** This research received no external funding.

**Institutional Review Board Statement:** Not applicable.

**Informed Consent Statement:** Not applicable.

**Data Availability Statement:** Not applicable.

**Conflicts of Interest:** The authors declare no conflict of interest.

## References

1. Pham, T.; Nugroho, A. Tourism-Induced Poverty Impacts of COVID-19 in Indonesia. *Ann. Tour. Res. Empir. Insights* **2022**, *3*, 100069. [CrossRef]
2. Okafor, L.; Khalid, U.; Gopalan, S. COVID-19 Economic Policy Response, Resilience and Tourism Recovery. *Ann. Tour. Res. Empir. Insights* **2022**, *3*, 100073. [CrossRef]

3. Osorio, P.; Cadarso, M.Á.; Tobarra, M.Á.; García-Alaminos, Á. Carbon Footprint of Tourism in Spain: COVID-19 Impact and a Look Forward to Recovery. *Struct. Change Econ. Dyn.* **2023**, *65*, 303–318. [CrossRef] [PubMed]
4. Liu, Y.; Cheng, X.; Liao, S.S.; Yang, F. The Impact of COVID-19 on the Tourism and Hospitality Industry: Evidence from International Stock Markets. *N. Am. J. Econ. Financ.* **2023**, *64*, 101875. [CrossRef]
5. Wickramasinghe, K.; Naranpanawa, A. Tourism and COVID-19: An Economy-Wide Assessment. *J. Hosp. Tour. Manag.* **2023**, *55*, 131–138. [CrossRef]
6. Aguiar-Quintana, T.; Román, C.; Gubisch, P.M.M. The Post-COVID-19 Tourism Recovery Led by Crisis-Resistant Tourists: Surf Tourism Preferences in the Canary Islands. *Tour. Manag. Perspect.* **2022**, *44*, 101041. [CrossRef]
7. Dias, Á.L.; Cunha, I.; Pereira, L.; Costa, R.L.; Gonçalves, R. Revisiting Small- and Medium-Sized Enterprises' Innovation and Resilience during COVID-19: The Tourism Sector. *J. Open Innov. Technol. Mark. Complex.* **2022**, *8*, 11. [CrossRef]
8. Tomej, K.; Bilynets, I.; Koval, O. Tourism Business Resilience in the Time of War. *Ann. Tour. Res.* **2023**, *99*, 103547. [CrossRef]
9. Soliku, O.; Kyiire, B.; Mahama, A.; Kubio, C. Tourism amid COVID-19 Pandemic: Impacts and Implications for Building Resilience in the Eco-Tourism Sector in Ghana's Savannah Region. *Heliyon* **2021**, *7*, e07892. [CrossRef]
10. Prayag, G. Tourism Resilience in the 'New Normal': Beyond Jingle and Jangle Fallacies? *J. Hosp. Tour. Manag.* **2023**, *54*, 513–520. [CrossRef]
11. Proag, V. The Concept of Vulnerability and Resilience. *Procedia Econ. Financ.* **2014**, *18*, 369–376. [CrossRef]
12. Doorn, N.; Gardoni, P.; Murphy, C. A Multidisciplinary Definition and Evaluation of Resilience: The Role of Social Justice in Defining Resilience. *Sustain. Resilient Infrastruct.* **2019**, *4*, 112–123. [CrossRef]
13. Ntounis, N.; Parker, C.; Skinner, H.; Steadman, C.; Warnaby, G. Tourism and Hospitality Industry Resilience during the COVID-19 Pandemic: Evidence from England. *Curr. Issues Tour.* **2022**, *25*, 46–59. [CrossRef]
14. Tasnim, Z.; Shareef, M.A.; Dwivedi, Y.K.; Kumar, U.; Kumar, V.; Malik, F.T.; Raman, R. Tourism Sustainability during COVID-19: Developing Value Chain Resilience. *Oper. Manag. Res.* **2023**, *16*, 391–407. [CrossRef]
15. Wided, R. Achieving Sustainable Tourism with Dynamic Capabilities and Resilience Factors: A Post Disaster Perspective Case of the Tourism Industry in Saudi Arabia. *Cogent Soc. Sci.* **2022**, *8*, 2060539. [CrossRef]
16. Pyke, J.; Lindsay-Smith, G.; Gamage, A.; Shaikh, S.; Nguyen, V.K.; de Lacy, T.; Porter, C. Building Destination Resilience to Multiple Crises to Secure Tourism's Future. *Asia Pac. J. Tour. Res.* **2021**, *26*, 1225–1243. [CrossRef]
17. Gaki, E.; Koufodontis, N.I. Regional tourism resilience and recovery in times of crises. *Geoj. Tour. Geosites* **2022**, *40*, 259–266. [CrossRef]
18. Setthachotsombut, N.; Sua-iam, G. The Resilience Development for the Entrepreneurs Tourism Sector (RDETS) from the 2019 Coronavirus Crisis in Thailand. *Afr. J. Hosp. Tour. Leis.* **2020**, *9*, 1–14.
19. Delaplace, M.; Kadri, B.; Levet-Labry, E.; Safaa, L. Risques, Résilience et Pérennité Des Destinations Touristiques: Une Introduction. *Études Caribéennes* **2018**, *2*. [CrossRef]
20. Wiczorek-Kosmala, M. A Study of the Tourism Industry's Cash-Driven Resilience Capabilities for Responding to the COVID-19 Shock. *Tour. Manag.* **2022**, *88*, 104396. [CrossRef]
21. Kaushal, V.; Srivastava, S. Hospitality and tourism industry amid COVID-19 pandemic: Perspectives on challenges and learnings from India. *Int. J. Hosp. Manag.* **2021**, *92*, 102707. [CrossRef] [PubMed]
22. Buultjens, J.; Ratnayake, I.; Gnanapala, A.C. Sri Lankan Tourism Development and Implications for Resilience. In *Tourism and Resilience*; CABI: Wallingford, UK, 2017; pp. 83–95. [CrossRef]
23. Wut, T.M.; Xu, J.; Wong, S.-m. Crisis Management Research (1985–2020) in the Hospitality and Tourism Industry: A Review and Research Agenda. *Tour. Manag.* **2021**, *85*, 104307. [CrossRef] [PubMed]
24. Li, L.; Yang, Z.; Dang, Z.; Meng, C.; Huang, J.; Meng, H.; Wang, D.; Chen, G.; Zhang, J.; Peng, H.; et al. Propagation Analysis and Prediction of the COVID-19. *Infect. Dis. Model.* **2020**, *5*, 282–292. [CrossRef] [PubMed]
25. Utkarsh; Sigala, M. A Bibliometric Review of Research on COVID-19 and Tourism: Reflections for Moving Forward. *Tour. Manag. Perspect.* **2021**, *40*, 100912. [CrossRef]
26. Binh Nguyen, P.M.; Pham, X.L.; To Truong, G.N. A Bibliometric Analysis of Research on Tourism Content Marketing: Background Knowledge and Thematic Evolution. *Heliyon* **2023**, *9*, e13487. [CrossRef]
27. Palácios, H.; de Almeida, M.H.; Sousa, M.J. A Bibliometric Analysis of Trust in the Field of Hospitality and Tourism. *Int. J. Hosp. Manag.* **2021**, *95*, 102944. [CrossRef]
28. Wang, T.; Yang, Z.; Chen, X.; Han, F. Bibliometric Analysis and Literature Review of Tourism Destination Resilience Research. *Int. J. Environ. Res. Public Health* **2022**, *19*, 5562. [CrossRef]
29. Sharma, G.D.; Thomas, A.; Paul, J. Reviving Tourism Industry Post-COVID-19: A Resilience-Based Framework. *Tour. Manag. Perspect.* **2021**, *37*, 100786. [CrossRef]
30. Casado-Aranda, L.A.; Sánchez-Fernández, J.; Bastidas-Manzano, A.B. Tourism Research after the COVID-19 Outbreak: Insights for More Sustainable, Local and Smart Cities. *Sustain. Cities Soc.* **2021**, *73*, 103126. [CrossRef]
31. Menon, D.; Gunasekar, S.; Dixit, S.K.; Das, P.; Mandal, S. Present and Prospective Research Themes for Tourism and Hospitality Education Post-COVID19: A Bibliometric Analysis. *J. Hosp. Leis. Sport Tour. Educ.* **2022**, *30*, 100360. [CrossRef]
32. Faruk, M.; Rahman, M.; Hasan, S. How Digital Marketing Evolved over Time: A Bibliometric Analysis on Scopus Database. *Heliyon* **2021**, *7*, e08603. [CrossRef]

33. Ying, H.; Zhang, X.; He, T.; Feng, Q.; Wang, R.; Yang, L.; Duan, J. A Bibliometric Analysis of Research on Heart Failure Comorbid with Depression from 2002 to 2021. *Heliyon* **2023**, *9*, e13054. [CrossRef]
34. Booth, P.; Chaperon, S.A.; Kennell, J.S.; Morrison, A.M. Entrepreneurship in Island Contexts: A Systematic Review of the Tourism and Hospitality Literature. *Int. J. Hosp. Manag.* **2020**, *85*, 102438. [CrossRef]
35. Benckendorff, P.; Zehrer, A. A network analysis of tourism research. *Ann. Tour. Res.* **2013**, *43*, 121–149. [CrossRef]
36. Wijesinghe, S.N.R.; Mura, P.; Bouchon, F. Tourism Knowledge and Neocolonialism—A Systematic Critical Review of the Literature. *Curr. Issues Tour.* **2017**, *22*, 1263–1279. [CrossRef]
37. Agapito, D. The Senses in Tourism Design: A Bibliometric Review. *Ann. Tour. Res.* **2020**, *83*, 102934. [CrossRef]
38. Page, M.J.; McKenzie, J.E.; Bossuyt, P.M.; Boutron, I.; Hoffmann, T.C.; Mulrow, C.D.; Shamseer, L.; Tetzlaff, J.M.; Akl, E.A.; Brennan, S.E.; et al. The PRISMA 2020 Statement: An Updated Guideline for Reporting Systematic Reviews. *Int. J. Surg.* **2021**, *88*, 105906. [CrossRef]
39. Hossain, S.; Batcha, M.S.; Atoum, I.; Ahmad, N.; Al-Shehri, A. Bibliometric Analysis of the Scientific Research on Sustainability in the Impact of Social Media on Higher Education during the COVID-19 Pandemic. *Sustainability* **2022**, *14*, 16388. [CrossRef]
40. Setiawan, D. Sopia system literature review occupational stress: An overview analysis bibliometrics. *J. Manag. Account. Gen. Financ. Int. Econ. Issues* **2022**, *2*, 343–356.
41. Omotehinwa, T.O. Examining the Developments in Scheduling Algorithms Research: A Bibliometric Approach. *Heliyon* **2022**, *8*, e09510. [CrossRef]
42. van Eck, N.J.; Waltman, L. Software Survey: VOSviewer, a Computer Program for Bibliometric Mapping. *Scientometrics* **2009**, *84*, 523–538. [CrossRef] [PubMed]
43. Umar, M.; Ahmad, R.; Radics, R. Tourism Supply Chains: Issues and Resilience Strategies during the Global Pandemic. *Australas. J. Disaster Trauma Stud.* **2022**, *26*, 167–178.
44. Papademetriou, C.; Ragazou, K.; Garefalakis, A.; Passas, I. Green Human Resource Management: Mapping the Research Trends for Sustainable and Agile Human Resources in SMEs. *Sustainability* **2023**, *15*, 5636. [CrossRef]
45. Koh, E. The end of over-tourism? Opportunities in a post-Covid-19 world. *Int. J. Tour. Cities* **2020**, *6*, 1015–1023. [CrossRef]
46. Sobaih, A.E.E.; Elshaer, I.; Hasanein, A.M.; Abdelaziz, A.S. Responses to COVID-19: The Role of Performance in the Relationship between Small Hospitality Enterprises' Resilience and Sustainable Tourism Development. *Int. J. Hosp. Manag.* **2021**, *94*, 102824. [CrossRef]
47. Prayag, G.; Spector, S.; Orchiston, C.; Chowdhury, M. Psychological Resilience, Organizational Resilience and Life Satisfaction in Tourism Firms: Insights from the Canterbury Earthquakes. *Curr. Issues Tour.* **2020**, *23*, 1216–1233. [CrossRef]
48. King, C.; Iba, W.; Clifton, J. Reimagining Resilience: COVID-19 and Marine Tourism in Indonesia. *Curr. Issues Tour.* **2021**, *24*, 2784–2800. [CrossRef]
49. Traskevich, A.; Fontanari, M. Tourism Potentials in Post-COVID19: The Concept of Destination Resilience for Advanced Sustainable Management in Tourism. *Tour. Plan. Dev.* **2023**, *20*, 12–36. [CrossRef]
50. Pham, L.D.Q.; Coles, T.; Ritchie, B.W.; Wang, J. Building Business Resilience to External Shocks: Conceptualising the Role of Social Networks to Small Tourism & Hospitality Businesses. *J. Hosp. Tour. Manag.* **2021**, *48*, 210–219. [CrossRef]
51. Okafor, L.E.; Khalid, U.; Burzynska, K. Does the Level of a Country's Resilience Moderate the Link between the Tourism Industry and the Economic Policy Response to the COVID-19 Pandemic? *Curr. Issues Tour.* **2022**, *25*, 303–318. [CrossRef]
52. Ngin, C.; Chhom, C.; Neef, A. Climate Change Impacts and Disaster Resilience among Micro Businesses in the Tourism and Hospitality Sector: The Case of Kratie, Cambodia. *Environ. Res.* **2020**, *186*, 109557. [CrossRef]
53. Chan, C.-S.; Nozu, K.; Zhou, Q. Tourism Stakeholder Perspective for Disaster-Management Process and Resilience: The Case of the 2018 Hokkaido Eastern Iburi Earthquake in Japan. *Sustainability* **2020**, *12*, 7882. [CrossRef]
54. Karunarathne, A.C.I.D.; Ranasinghe, J.P.R.C.; Sammani, U.G.O.; Perera, K.J.T. Impact of the COVID-19 Pandemic on Tourism Operations and Resilience: Stakeholders' Perspective in Sri Lanka. *Worldw. Hosp. Tour.* **2021**, *13*, 369–382. [CrossRef]
55. Estiri, M.; Heidary Dahooie, J.; Skare, M. COVID-19 Crisis and Resilience of Tourism SME's: A Focus on Policy Responses. *Econ. Res.-Ekon. Istraz.* **2022**, *35*, 5556–5580. [CrossRef]
56. Jalil, M.F.; Ali, A.; Ahmed, Z.; Kamarulzaman, R. The Mediating Effect of Coping Strategies Between Psychological Capital and Small Tourism Organization Resilience: Insights From the COVID-19 Pandemic, Malaysia. *Front. Psychol.* **2021**, *12*, 766528. [CrossRef]
57. Duro, J.; Perez-Laborda, A.; Fernandez, M. Territorial Tourism Resilience in the COVID-19 Summer. *Ann. Tour. Res. Empir. Insights* **2022**, *3*, 100039. [CrossRef]
58. Holland, K.K.; Larson, L.R.; Powell, R.B.; Holland, W.H.; Allen, L.; Nabaala, M.; Tome, S.; Seno, S.; Nampushi, J. Impacts of Tourism on Support for Conservation, Local Livelihoods, and Community Resilience around Maasai Mara National Reserve, Kenya. *J. Sustain. Tour.* **2022**, *30*, 2526–2548. [CrossRef]
59. Yiu, C.-Y.; Cheung, K.-S. Urban Zoning for Sustainable Tourism: A Continuum of Accommodation to Enhance City Resilience. *Sustainability* **2021**, *13*, 7317. [CrossRef]
60. Boto-García, D.; Mayor, M. Domestic Tourism and the Resilience of Hotel Demand. *Ann. Tour. Res.* **2022**, *93*, 103352. [CrossRef]
61. McLeod, M.; Dodds, R.; Butler, R. Introduction to Special Issue on Island Tourism Resilience. *Tour. Geogr.* **2021**, *23*, 361–370. [CrossRef]

62. Bai, H.; Ran, W. Analysis of the Vulnerability and Resilience of the Tourism Supply Chain under the Uncertain Environment of COVID-19: Case Study Based on Lijiang. *Sustainability* **2022**, *14*, 2571. [CrossRef]
63. Altshuler, A.; Schmidt, J. Why Does Resilience Matter? Global Implications for the Tourism Industry in the Context of COVID-19. *Worldw. Hosp. Tour.* **2021**, *13*, 431–436. [CrossRef]
64. Cahyanto, I.P.; Liu-Lastres, B.; Edwards, C. Developing a Resilience-Based Adaptive Co-Management Framework: Public Sectors' Insights on the Role of Tourism. *J. Policy Res. Tour. Leis. Events* **2021**, *13*, 204–221. [CrossRef]
65. Jiménez-Medina, P.; Artal-Tur, A.; Sánchez-Casado, N. Tourism Business, Place Identity, Sustainable Development, and Urban Resilience: A Focus on the Sociocultural Dimension. *Int. Reg. Sci. Rev.* **2021**, *44*, 170–199. [CrossRef]
66. Della Corte, V.; Del Gaudio, G.; Sepe, F.; Luongo, S. Destination Resilience and Innovation for Advanced Sustainable Tourism Management: A Bibliometric Analysis. *Sustainability* **2021**, *13*, 12632. [CrossRef]
67. Lin, Q.; Wen, J.J. Family Business, Resilience, and Ethnic Tourism in Yunnan, China. *Sustainability* **2021**, *13*, 11799. [CrossRef]
68. Bertella, G. Discussing Tourism during a Crisis: Resilient Reactions and Learning Paths towards Sustainable Futures. *Scand. J. Hosp. Tour.* **2022**, *22*, 144–160. [CrossRef]
69. Lee, G.; Anat, T.; Shahar, S. Urban Resilience as a Mitigating Factor against Economically Driven Out-Migration during COVID-19: The Case of Eilat, a Tourism-Based City. *Cities* **2022**, *125*, 103636. [CrossRef]
70. Chan, C.-S.; Nozu, K.; Zhou, Q. Building Destination Resilience in the Tourism Disaster Management Process from the Past Experiences: The Case of the 2018 Hokkaido Eastern Iburi Earthquake in Japan. *Tour. Recreat. Res.* **2022**, *47*, 527–543. [CrossRef]
71. Martínez-Carazo, E.-M.; Santamarina-Campos, V.; De-Miguel-Molina, M. Creative Mural Landscapes, Building Communities and Resilience in Uruguayan Tourism. *Sustainability* **2021**, *13*, 5953. [CrossRef]
72. Ho, G.K.S.; Lam, C.; Law, R. Conceptual Framework of Strategic Leadership and Organizational Resilience for the Hospitality and Tourism Industry for Coping with Environmental Uncertainty. *J. Hosp. Tour. Insights* **2023**, *6*, 835–852. [CrossRef]
73. Ketter, E. Bouncing Back or Bouncing Forward? Tourism Destinations' Crisis Resilience and Crisis Management Tactics. *Eur. J. Tour. Res.* **2022**, *31*, 3103. [CrossRef]
74. Lindsay-Smith, G.; Pyke, J.; Gamage, A.; Nguyen, V.; de Lacy, T. Tourism Operator Mental Health and Its Relationship with SME Organisational Resilience during Disasters. *Tour. Manag. Perspect.* **2022**, *42*, 100961. [CrossRef]
75. Koo, I.; Anjam, M.; Zaman, U. Hell Is Empty, and All the Devils Are Here: Nexus between Toxic Leadership, Crisis Communication, and Resilience in COVID-19 Tourism. *Sustainability* **2022**, *14*, 10825. [CrossRef]
76. Álvarez, B.M.; Cortes-Vazquez, J.A. "May the Smoke Keep Coming out the Fireplace": Moral Connections between Rural Tourism and Socio-Ecological Resilience in the EUME Region, Galicia. *Sustainability* **2020**, *12*, 4602. [CrossRef]
77. Partanen, M. Social Innovations for Resilience—Local Tourism Actor Perspectives in Kemi, Finland. *Tour. Plan. Dev.* **2022**, *19*, 143–163. [CrossRef]
78. Shi, W.; Gong, Y.; Wang, L.; Nikolova, N. Heterogeneity of Inbound Tourism Driven by Exchange Rate Fluctuations: Implications for Tourism Business Recovery and Resilience in Australia. *Curr. Issues Tour.* **2023**, *26*, 450–467. [CrossRef]
79. Zhang, J. Spatial Effects of Tourism Development on Economic Resilience: An Empirical Study of Wenchuan Earthquake Based on Dynamic Spatial Durbin Model. *Nat. Hazards* **2023**, *115*, 309–329. [CrossRef]
80. Añasco, C.P.; Monteclaro, H.M.; Catedrilla, L.C.; Lizada, J.C.; Baylon, C.C. Measuring Small Island Disaster Resilience Towards Sustainable Coastal and Fisheries Tourism: The Case of Guimaras, Philippines. *Hum. Ecol.* **2021**, *49*, 467–479. [CrossRef]
81. Taylor, P.; Frost, W.; Frost, J. Building Resilient Local Tourism Systems: Insights from New Zealand's Premier Cycling Attractions. *Asia Pac. J. Tour. Res.* **2022**, *27*, 457–472. [CrossRef]
82. Cengiz, C.; Cengiz, B.; Smardon, R.C. A Bridge between Coastal Resilience and Tourism-Recreation: Multifunctional Benefit of Boardwalk Design for Sustainable Development in the Western Black Sea Region, Turkey. *Water* **2022**, *14*, 1434. [CrossRef]
83. Giang, T.H.T.; Caldicott, R.W. Developing Resilience for Small Island Tourism Planning: A Qualitative Design Infusing the Sustainability Trilogy with Three Streams of Resilience Thinking. *J. Mar. Isl. Cult.* **2022**, *11*, 128–157. [CrossRef]
84. Mazilu, M.; Niță, A.; Drăguleasa, I.-A. Resilience of Romanian Tourism to Economic Crises and COVID-19 Pandemic. *WSEAS Trans. Bus. Econ.* **2023**, *20*, 328–341. [CrossRef]
85. Sholeha, A.W.; Sumarmi; Utaya, S.; Bachri, S. Making Cities Resilient 2030 Assessment for Tourism Cities: An Analytical Study of Local Government Capacity at Batu City, Indonesia. *Environ. Res. Eng. Manag.* **2022**, *78*, 77–96. [CrossRef]
86. Wibowo, M. Modeling the Potential of Tsunami Hazard in Labuan Bajo Towards A Disaster-Resilient Tourism Area. *Indones. J. Geogr.* **2022**, *54*, 83–91. [CrossRef]
87. Widianingsih, I.; Abdillah, A.; Herawati, E.; Dewi, A.U.; Miftah, A.Z.; Adikancana, Q.M.; Pratama, M.N.; Sasmono, S. Sport Tourism, Regional Development, and Urban Resilience: A Focus on Regional Economic Development in Lake Toba District, North Sumatra, Indonesia. *Sustainability* **2023**, *15*, 5960. [CrossRef]
88. Zakaria, R.; Zineb, T. Predicting the resilience of the tourism industry after the COVID-19 health epidemic. *J. Theor. Appl. Inf. Technol.* **2023**, *101*, 2271–2292.
89. Bangwayo-Skeete, P.F.; Skeete, R.W. Modelling Tourism Resilience in Small Island States: A Tale of Two Countries. *Tour. Geogr.* **2021**, *23*, 436–457. [CrossRef]
90. Chen, F.; Xu, H.; Lew, A.A. Livelihood Resilience in Tourism Communities: The Role of Human Agency. *J. Sustain. Tour.* **2020**, *28*, 606–624. [CrossRef]

91. Heslinga, J.; Groote, P.; Vanclay, F. Towards Resilient Regions: Policy Recommendations for Stimulating Synergy between Tourism and Landscape. *Land* **2020**, *9*, 44. [CrossRef]
92. Adams, K.M.; Choe, J.; Mostafanezhad, M.; Phi, G.T. (Post-) Pandemic Tourism Resiliency: Southeast Asian Lives and Livelihoods in Limbo. *Tour. Geogr.* **2021**, *23*, 915–936. [CrossRef]
93. Torres, P.; Augusto, M. Attention to Social Issues and CEO Duality as Enablers of Resilience to Exogenous Shocks in the Tourism Industry. *Tour. Manag.* **2021**, *87*, 104400. [CrossRef]
94. Watson, P.; Deller, S. Tourism and Economic Resilience. *Tour. Econ.* **2022**, *28*, 1193–1215. [CrossRef]
95. Ibanescu, B.-C.; Eva, M.; Gheorghiu, A. Questioning the Role of Tourism as an Engine for Resilience: The Role of Accessibility and Economic Performance. *Sustainability* **2020**, *12*, 5527. [CrossRef]
96. Pocinho, M.; Garcês, S.; de Jesus, S.N. Wellbeing and Resilience in Tourism: A Systematic Literature Review During COVID-19. *Front. Psychol.* **2022**, *12*, 748947. [CrossRef]
97. Burnett, M.; Johnston, T. Brexit Anticipated Economic Shock on Ireland’s Planning for Hospitality and Tourism: Resilience, Volatility and Exposure. *Tour. Rev.* **2020**, *75*, 595–606. [CrossRef]
98. Bui, P.L.; Tzu-Ling Chen, C.; Wickens, E. Tourism Industry Resilience Issues in Urban Areas during COVID-19. *Int. J. Tour. Cities* **2021**, *7*, 861–879. [CrossRef]
99. Usher, L.E.; Yusuf, J.-E.; Covi, M. Assessing Tourism Business Resilience in Virginia Beach. *Int. J. Tour. Cities* **2020**, *6*, 397–414. [CrossRef]
100. Božović, T.; Blešić, I.; Knežević, M.N.; Đeri, L.; Pivac, T. Resilience of Tourism Employees to Changes Caused by COVID-19 Pandemic. *J. Geogr. Inst. Jovan Cvijic SASA* **2021**, *71*, 181–194. [CrossRef]
101. Shekari, F.; Ziaee, M.; Faghihi, A.; Jomehpour, M. Nomadic Livelihood Resilience through Tourism. *Ann. Tour. Res. Empir. Insights* **2022**, *3*, 100034. [CrossRef]
102. Yang, X.; Zhang, D.; Liu, L.; Niu, J.; Zhang, X.; Wang, X. Development Trajectory for the Temporal and Spatial Evolution of the Resilience of Regional Tourism Environmental Systems in 14 Cities of Gansu Province, China. *Environ. Sci. Pollut. Res.* **2021**, *28*, 65094–65115. [CrossRef] [PubMed]
103. Yang, E.; Smith, J.W. The Spatial and Temporal Resilience of the Tourism and Outdoor Recreation Industries in the United States throughout the COVID-19 Pandemic. *Tour. Manag.* **2023**, *95*, 104661. [CrossRef]
104. Cui, W.; Chen, J.; Xue, T.; Shen, H. The Economic Resilience Cycle Evolution and Spatial-Temporal Difference of Tourism Industry in Guangdong-Hong Kong-Macao Greater Bay Area from 2000 to 2019. *Sustainability* **2021**, *13*, 12092. [CrossRef]
105. Amoamo, M. Brexit–Threat or Opportunity? Resilience and Tourism in Britain’s Island Territories. *Tour. Geogr.* **2021**, *23*, 501–526. [CrossRef]
106. Blanco-Romero, A.; Blázquez-Salom, M. Inland Territorial and Tourism Resilience in a Polarized World. In *Smart Innovation, Systems and Technologies*; Springer: Berlin/Heidelberg, Germany, 2021; Volume 178, pp. 1886–1896. [CrossRef]
107. Feng, L.; Guo, J.; Liu, Y. Research Methodology for Tourism Destination Resilience and Analysis of Its Spatiotemporal Dynamics in the Post-Epidemic Period. *J. Resour. Ecol.* **2021**, *12*, 682–692. [CrossRef]
108. Mondal, S.; Samaddar, K. Future of Sharing Economy and Its Resilience Post Pandemic: A Study on Indian Travel and Tourism Industry. *Manag. Environ. Qual. Int. J.* **2022**, *33*, 1591–1610. [CrossRef]
109. Chen, X.; Li, B. Rethinking Cultural Creativity and Tourism Resilience in the Post-Pandemic Era in Chinese Traditional Villages. *Sustainability* **2022**, *14*, 12371. [CrossRef]
110. Huda, M. Digital Marketplace for Tourism Resilience in the Pandemic Age: Voices from Budget Hotel Customers. *Int. J. Organ. Anal.* **2023**, *31*, 149–167. [CrossRef]
111. Mandal, S.; Vishnu, S.; Roshini, M. Do Alliance Capabilities Matter in Tourism Dynamic Capabilities Development? An Examination through Agility and Resilience Lens. *Int. J. Bus. Excell.* **2021**, *25*, 370–390. [CrossRef]
112. Utami, W. Resilience of Cultural Landscape Heritage Study in Spatial Tourism Context. In Proceedings of the IOP Conference Series: Earth and Environmental Science, Changchun, China, 21–23 August 2020; Institute of Physics Publishing: Bristol, UK, 2020; Volume 402.
113. Munasinghe, S.; Powell, L.; Herath, H.M.; Frey, R.A. Lessons for Resilience Building in Tourism and Hospitality: The Case of New Zealand. *Worldw. Hosp. Tour.* **2022**, *14*, 604–609. [CrossRef]
114. Setiadi, A.; Rudwianti, L.A.; Priscilia, F.; Wardhani, M.K. City Tourism Branding Resilience during the COVID-19 Pandemic in Yogyakarta, Indonesia. *Spatium* **2021**, 1–8. [CrossRef]
115. Silva, F.; Lopes, T.; Silva, M. The Resilience of Tourism Recreation Companies in a Pandemic Context: The Case of Canyoning in the Azores. *Soc. Sci.* **2022**, *11*, 558. [CrossRef]
116. Yang, S.; Guo, W. Research on China’s Tourism Public Services Development from the Perspective of Spatial–Temporal Interactions and Based on Resilience Theory. *Sustainability* **2023**, *15*, 4. [CrossRef]
117. Yu, J.; Zhang, Y.; Zhang, Y.; Jiang, Y. Spatial and Temporal Changes and Influencing Factors of Tourism Resilience in China’s Provinces under the Impact of COVID-19. *J. Resour. Ecol.* **2023**, *14*, 217–229. [CrossRef]
118. Damanik, F.K.; Ulinnuha, H.; Sonia, C.R. Nurhalisa Digitalization for Tourism Resiliency (Case Study: Labuan Bajo). In *Lecture Notes in Networks and Systems*; Springer: Berlin/Heidelberg, Germany, 2023; Volume 621, pp. 756–765. [CrossRef]
119. Zhang, P.; Huang, Y.; Pan, S.; Chen, W.; Zhong, H.; Xu, N.; Zhong, M. Does Resilience Exist in China’s Tourism Economy? From the Perspectives of Resistance and Recoverability. *Sustainability* **2022**, *14*, 10641. [CrossRef]

120. Dang, P.; Ren, L.; Li, J. Livelihood Resilience or Policy Attraction? Factors Determining Households' Willingness to Participate in Rural Tourism in Western China. *Int. J. Environ. Res. Public Health* **2022**, *19*, 7224. [CrossRef]
121. Hu, H.; Xu, K. Visualizing the Development of Research on Tourism Resilience with Mixed Methods. *SAGE Open* **2022**, *12*. [CrossRef]
122. Rauzi, E.N.; Aulia, F. Designing resilient coastal tourism facilities based on landscape characteristics and local wisdom. *Plan. Malays.* **2022**, *20*, 1–13. [CrossRef]
123. Shi, Y.; Zhang, J.; Cui, X.; Zhang, G. Evaluating Sustainability of Tourism Projects in Rural Land Development Base on a Resilience Model. *Land* **2022**, *11*, 2245. [CrossRef]
124. Xiao, Y.; Liu, S.; Zuo, J.; Yin, N.; Wu, J.; Xie, W. Farmer Households' Livelihood Resilience in Ethnic Tourism Villages: A Case Study of the Wuling Mountain Area, China. *Sustainability* **2023**, *15*, 662. [CrossRef]
125. Musavengane, R.; Kloppers, R. Social Capital: An Investment towards Community Resilience in the Collaborative Natural Resources Management of Community-Based Tourism Schemes. *Tour. Manag. Perspect.* **2020**, *34*, 100654. [CrossRef]
126. Bui, H.T.; Jones, T.E.; Weaver, D.B.; Le, A. The Adaptive Resilience of Living Cultural Heritage in a Tourism Destination. *J. Sustain. Tour.* **2020**, *28*, 1022–1040. [CrossRef]
127. Gabriel-Campos, E.; Werner-Masters, K.; Cordova-Buiza, F.; Paucar-Caceres, A. Community Eco-Tourism in Rural Peru: Resilience and Adaptive Capacities to the COVID-19 Pandemic and Climate Change. *J. Hosp. Tour. Manag.* **2021**, *48*, 416–427. [CrossRef]
128. Noorashid, N.; Chin, W.L. Coping with COVID-19: The Resilience and Transformation of Community-Based Tourism in Brunei Darussalam. *Sustainability* **2021**, *13*, 8618. [CrossRef]
129. Jang, S.; Kim, J. Remediating Airbnb COVID-19 Disruption through Tourism Clusters and Community Resilience. *J. Bus. Res.* **2022**, *139*, 529–542. [CrossRef] [PubMed]
130. Yang, E.; Kim, J.; Pennington-Gray, L.; Ash, K. Does Tourism Matter in Measuring Community Resilience? *Ann. Tour. Res.* **2021**, *89*, 103222. [CrossRef]
131. Pilquimán-Vera, M.; Cabrera-Campos, G.; Tenorio-Pangui, P. Experiences of Resilience and Mapuche Community Based Tourism in the Pre-Cordilleran Territories of Panguipulli, Southern Chile. *Sustainability* **2020**, *12*, 817. [CrossRef]
132. Espeso-Moliner, P.; Pastor-Alfonso, M.J. Governance, Community Resilience, and Indigenous Tourism in Nahá, Mexico. *Sustainability* **2020**, *12*, 5973. [CrossRef]
133. Ruiz-Ballesteros, E.; del Campo Tejedor, A. Community-Based Tourism as a Factor in Socio-Ecological Resilience. Economic Diversification and Community Participation in Floreana (Galapagos). *Sustainability* **2020**, *12*, 4724. [CrossRef]
134. Cirer-Costa, J.C. Economic and Social Resilience Accounts for the Recovery of Ibiza's Tourism Sector. *Tour. Geogr.* **2021**, *23*, 479–500. [CrossRef]
135. Cáceres-Feria, R.; Hernández-Ramírez, M.; Ruiz-Ballesteros, E. Depopulation, Community-Based Tourism, and Community Resilience in Southwest Spain. *J. Rural Stud.* **2021**, *88*, 108–116. [CrossRef]
136. Wakil, M.A.; Sun, Y.; Chan, E.H.W. Co-Flourishing: Intertwining Community Resilience and Tourism Development in Destination Communities. *Tour. Manag. Perspect.* **2021**, *38*, 100803. [CrossRef]
137. Gascón, J.; Mamani, K.S. Community-Based Tourism, Peasant Agriculture and Resilience in the Face of COVID-19 in Peru. *J. Agrar. Change* **2022**, *22*, 362–377. [CrossRef]
138. Weis, K.; Chambers, C.; Holladay, P.J. Social-Ecological Resilience and Community-Based Tourism in the Commonwealth of Dominica. *Tour. Geogr.* **2021**, *23*, 458–478. [CrossRef]
139. Jang, S.; Kim, J.; Lee, Y.-J.A. Intertemporal Tourism Clusters and Community Resilience. *Prof. Geogr.* **2021**, *73*, 567–572. [CrossRef]
140. Yang, E.; Kim, J.; Hwang, C.S. The Spatial Moderating Effect of Environmental Pollution on the Relationship between Tourism and Community Resilience. *Tour. Manag.* **2022**, *93*, 104554. [CrossRef]
141. Díaz-Aguilar, A.L.; Escalera-Reyes, J. Family Relations and Socio-Ecological Resilience within Locally-Based Tourism: The Case of El Castillo (Nicaragua). *Sustainability* **2020**, *12*, 5886. [CrossRef]
142. Kim, C.; Kim, J. Spatial Spillovers of Sport Industry Clusters and Community Resilience: Bridging a Spatial Lens to Building a Smart Tourism City. *Inf. Process. Manag.* **2023**, *60*, 103266. [CrossRef]
143. Martínez Yáñez, C. The ICOMOS Draft International Charter for Cultural Heritage Tourism (2021): Reinforcing Cultural Heritage Protection and Community Resilience Through Responsible and Sustainable Tourism Management. *New Approaches to Global Policies, Challenges and Issues*. In *Lecture Notes in Networks and Systems*; Springer: Berlin/Heidelberg, Germany, 2022; Volume 482, pp. 2361–2370. [CrossRef]
144. Zhang, J.; Shen, L.; Liu, L.; Qi, X.; Liang, C. Tackling Comprehensive Evaluation of Tourism Community Resilience: A Probabilistic Hesitant Linguistic Group Decision Making Approach. *Land* **2022**, *11*, 1652. [CrossRef]
145. Prayag, G. Time for Reset? COVID-19 and Tourism Resilience. *Tour. Rev. Int.* **2020**, *24*, 179–184. [CrossRef]
146. Navarro-Drazich, D.; Lorenzo, C. Sensitivity and Vulnerability of International Tourism by Covid Crisis: South America in Context. *Res. Glob.* **2021**, *3*, 100042. [CrossRef]
147. Barbhuiya, M.R.; Chatterjee, D. Vulnerability and Resilience of the Tourism Sector in India: Effects of Natural Disasters and Internal Conflict. *Tour. Manag. Perspect.* **2020**, *33*, 100616. [CrossRef]
148. Xu, Z.; Wang, X.; Wang, X.; Skare, M. A Comprehensive Bibliometric Analysis of Entrepreneurship and Crisis Literature Published from 1984 to 2020. *J. Bus. Res.* **2021**, *135*, 304–318. [CrossRef]
149. Fox, M.F.; Faver, C.A. Independence and Cooperation in Research. *J. High. Educ.* **2016**, *55*, 347–359. [CrossRef]

150. Dauphiné, A.; Provitolo, D. Resilience: A Concept for Risk Management. *Ann. Geogr.* **2007**, *116*, 115–125. [CrossRef]
151. Qamar, A.H. Conceptualizing Social Resilience in the Context of Migrants' Lived Experiences. *Geoforum* **2023**, *139*, 103680. [CrossRef]
152. Paeffgen, T. Organisational Resilience during COVID-19 Times: A Bibliometric Literature Review. *Sustainability* **2023**, *15*, 367. [CrossRef]
153. Chambers, R.; Conway, G.R. *Sustainable Rural Livelihoods: Practical Concepts for the 21st Century*; IDS Discussion Paper; Institute of Development Studies: Falmer, UK, 1992; p. 296.
154. Wu, M.Y.; Pearce, P.L. Host Tourism Aspirations as a Point of Departure for the Sustainable Livelihoods Approach. *J. Sustain. Tour.* **2014**, *22*, 440–460. [CrossRef]

**Disclaimer/Publisher's Note:** The statements, opinions and data contained in all publications are solely those of the individual author(s) and contributor(s) and not of MDPI and/or the editor(s). MDPI and/or the editor(s) disclaim responsibility for any injury to people or property resulting from any ideas, methods, instructions or products referred to in the content.



## Article

# Tourism Recovery and Sustainability Post Pandemic: An Integrated Approach for Kenya's Tourism Hotspots

David Chiawo <sup>1,\*</sup> , Collins Haggai <sup>1</sup>, Veronica Muniu <sup>1</sup>, Rose Njuguna <sup>1</sup> and Peggy Ngila <sup>2</sup>

<sup>1</sup> School of Tourism and Hospitality, Strathmore University, P.O. Box 59857, Nairobi 00200, Kenya; chaggai@strathmore.edu (C.H.); vmuniu@strathmore.edu (V.M.); rnjuguna@strathmore.edu (R.N.)

<sup>2</sup> Department of Agricultural Sciences, South Eastern Kenya University, P.O. Box 170, Kitui 90200, Kenya; pngila@seku.ac.ke

\* Correspondence: dchiawo@strathmore.edu

**Abstract:** The COVID-19 pandemic has had a significant impact on the tourism industry, leading to global economic and societal disruptions, and a growing risk of a global recession. This project aimed to investigate the impact of the pandemic on conservation, communities, and businesses in Masai Mara, and identify critical factors for sustainable tourism recovery. Four objectives were explored: (1) awareness of critical factors for tourism recovery and sustainability during and after the pandemic period; (2) socio-economic vulnerabilities of indigenous communities to COVID-19; (3) lessons learned to enhance adaptation and resilience; and (4) the impact of COVID-19 on conservation management of the destination. We used mixed methods, including field observations, key informant interviews, and focus group discussions, to collect data from tourism industry businesses and policymakers in the Masai Mara conservation area. The findings indicated a negative large-scale effect on conservation, tourism business, and communities in the area. The study recommends integrated interventions by both county and national governments, targeting small, medium, and micro enterprises. The persistence of the economic damage to the tourism sector will depend on how both county and national governments handle policy interventions towards the funding of tourism SMMEs, the community livelihood programme, and conservation partnerships to incentivize tourism recovery.

**Keywords:** COVID-19 pandemic; tourism sustainability; Masai Mara; policy interventions; Kenya



**Citation:** Chiawo, D.; Haggai, C.; Muniu, V.; Njuguna, R.; Ngila, P. Tourism Recovery and Sustainability Post Pandemic: An Integrated Approach for Kenya's Tourism Hotspots. *Sustainability* **2023**, *15*, 7291. <https://doi.org/10.3390/su15097291>

Academic Editors: Zygmunt Kruczek and Bartłomiej Walas

Received: 29 March 2023

Revised: 21 April 2023

Accepted: 23 April 2023

Published: 27 April 2023



**Copyright:** © 2023 by the authors. Licensee MDPI, Basel, Switzerland. This article is an open access article distributed under the terms and conditions of the Creative Commons Attribution (CC BY) license (<https://creativecommons.org/licenses/by/4.0/>).

## 1. Introduction

The COVID-19 pandemic has brought the tourism world to a standstill, with severe impacts on communities, tourism businesses, and conservation [1]. The full collapse of international tourism has led to the direct loss of jobs and growing risks of a global recession associated with massive direct loss of jobs in the tourism industry [1,2]. The World Tourism Organization (UNWTO) estimated international tourist arrivals to decline by 20 to 30% in 2020, translating to a loss of 300 to 450 US\$ billion in international tourism receipts [3]. COVID-19 has caused combined demand and supply shock to the tourism industry, producing large-scale, global, and possibly persistent economic disruption [2,4]. It is already clear that its economic impact will be more severe and more devastating than in the case of the Severe Acute Respiratory Syndrome (SARS) in the period 2002–2003 [5]. Overall, the potential impacts of this crisis are greater than any previously seen in history [5]. Infectious diseases have a great impact on tourism and hotel room occupancies, owing to the industry's reliance on human mobility [6]; e.g., during the outbreak of Ebola, a shock of 53 US\$ billion losses was experienced in West Africa and a 20% drop in Sierra Leone's GDP in 2015 [5,7].

Previous post-war pandemics were far smaller, but reported a significant impact on the tourism sector; e.g., the impact of the SARS outbreak in 2003 on Toronto's tourism economy (especially hoteliers) was a 20% reduction in room occupancy and \$111 million

losses in room revenues for the second quarter of 2003, and a year-to-year comparison saw reductions of 47% to 72% (2002 to 2003), causing an overall revenue loss of \$342.5 million for 4 months in 2003 [8]. The reported impact and number of COVID-19 cases are already eight or nine times larger (worldwide) than the 2003 SARS epidemic, pointing to an upcoming economic recession [5]. Data from SARS, as well as the Spanish Flu from 1918, provide some idea of the economic shocks posed by the COVID-19 outbreak [5]. The economic slowdown from both domestic and international tourists has been evidenced [9]. Many of the nation's hit hardest by COVID-19 are among the ten largest economies in the world in G7 economies; e.g., the U.S., China, Japan, Germany, Britain, France, and Italy, which account for 60% of world supply and demand (GDP) [2]. Chinese tourism is considered one of the world's most viewed, with 10% of global tourists impacted by the coronavirus in one of its busiest seasons when millions were traveling [9]. The decreased tourist numbers have led to declining demand for travel, hotel rooms, gifts, and food consumption, etc. [4,5]. While service-oriented economies will take the larger hits, demand for transportation, restaurants, traveling, tourism, and cinemas has sharply declined [4].

Tourist destinations have been deserted, airlines ground fleets and fired staff, trade fairs and cruises have been cancelled, hotels and casinos have closed all operations [5]. International tourism has been disrupted due to travel restrictions and the reduction of airline flights [5,10]. Suspended domestic and overseas group tours and suspended sales of certain travel products, such as flight tickets and hotel bundle packages, have largely affected the industry [10]. Ref. [10] estimated that, in the tourism sector, demand will contract by 75% and there will be a 10% rise in the unemployment rate. People staying away from work to tend to sick relatives or imposing of quarantine are also causing indirect temporary employment reduction [11]. The global travel industry from airlines to cruise companies, from casinos to hotels is facing reductions in activity of more than 90% [5]. COVID-19 will have ramifications for the global economy and trade, as cross-border travel and tourism accounted for 52.7% of services imports and 14.8% of services exports in 2018 [10]. Preliminary estimates have stated that global airlines might lose around \$113 billion in sales [12]. The air transportation sector has seen a dramatic drop of 85% in demand, an unemployment rate of 20%, and a contraction of 45% in the stock market index [13]. Norwegian Air cancelled 85% of flights and laid off 90% of staff. German tourism giant TUI requested state aid [5]. Many cruise lines have suspended sailing [9], while Airbnb and Uber are already reporting a decline in their activities [11]. Kenya is among the biggest tourism economies in Africa and the tourism sector is among the major contributors to the gross domestic product (GDP), accounting for approximately 10%. It is a major source of employment for the locals, with approximately 10–12% of the labor [14].

Kenya has experienced a steady increase in both local and international tourism from 2015 to 2017, and international visitor arrivals increased to 2,035,400 in 2019 [15], an increase of 1.167% from the previous year [16]. Kenya's travel and tourism revenue in 2019 was a healthy USD 1.61 billion, with 4.956 million bed nights sold compared to 4.489 million in 2018 [14]. The tourism industry has suffered several setbacks in the past from the 1990s tourists' killings, the 1998 embassy bombing, to the 2007 post-election violence, terrors attacks, travel advisories that affected international arrivals, and the current COVID-19 pandemic. Pre-COVID-19, international arrivals were projected to reach 2,100,000 in 2020 to attain the Third Medium Term Plan M2018-2022 [17]. None of the prior mentioned challenges have affected the tourism sector in Kenya and elsewhere more than the COVID-19 pandemic, halting the demand for international travel, significantly affecting the tourism sector in Kenya. This paper examines the impacts of COVID-19 on tourism businesses, communities, and conservation, and explores lessons learned for sustainable adaptation in Kenya's leading conservation area, Masai Mara. The study identifies a shortage in the literature regarding tourism policies necessary for sustainable and resilient recovery post COVID 19 [18]. The study proposes measures at the policy level to enable recovery from the effects of COVID 19. Understanding these impacts is essential

in informing the designing of recovery plans and policy initiatives to support recovery both in the short and long term.

The study was informed by Stakeholder Theory in Sustainable Tourism. Tourism development needs to be sustainably planned and managed if it is to succeed [19–22]. The backing of stakeholders, such as residents, business owners, and community leaders, is one of the most important factors in the success and execution of sustainable tourist development in a community [23]. Stakeholders are defined as “any group or individual who can affect or is affected by” the development of tourism in a particular location [24]. The emphasis on increased stakeholder involvement highlights its capacity to address several identified challenges. The first problem is that decisions regarding tourist development are made by “experts” at the top. The local community frequently feels that decisions made in this way do not represent their interests and perspectives. The second problem is that the system for making choices is seen to have competing interests within it, which leads to judgments that are once more not in line with the interests of the general public [25]. Participation may also result in the avoidance of significant disputes amongst stakeholder groups [26]. Given the relevance of stakeholders in tourism and conservation in the Mara region, we propose a recovery framework that accounts for their specific interests.

## 2. Materials and Methods

### 2.1. Tourism Context of Kenya and Maasai Mara

Kenya is one of the East African countries with tourism as the second-largest source of foreign exchange revenue after agriculture [14,27]. Kenya has a total population of 47,564,296 [15]. The top 10 international tourist arrivals for Kenya in the year 2019 included the U.S., Uganda, Tanzania, the UK, India, China, Germany, France, Italy, and South Africa, in that order [16]. The tourism sector in Kenya largely depends on international arrivals [16]. Kenya has diverse tourism products, including pristine beaches, world-renowned wildlife, indigenous culture, and a hospitable population.

Masai Mara covers an area of 1672 sq. km and is one of the world’s top tourist attractions and a premier conservation area in Kenya. It is home to the big five and hundreds of animal and bird species. It is a top attraction within the migration path of over 1 million wildebeests, an annual spectacular scene that attracts hundreds of thousands of domestic, regional, and international tourists. Masai Mara is a prime viewing spot of wildebeest migration, resulting in its status as the seventh wonder of the world according to Union for the Conservation of Nature (IUCN). According to the Kenyan Institute of Economic Affairs, in 2011, the reserve received 138,200 international visitors, and the number increased to 146,900 in 2015, marking a 6% increase over 5 years. In recent years, before the COVID-19 pandemic, it was estimated that approximately 300,000 domestic and international tourists visited the reserve each year. A peak number of 316,500 visitors was recorded in 2006 when the Reserve’s entrance fees alone generated 5.5 million US dollars. The indigenous community living around the reserve is predominantly the Masai Mara people, whose livelihood is largely dependent on tourism. In 2019, an estimated 1.2 million community members and 13,236 landowners were dependent on tourism [15]. These communities are actively involved in community-based tourism and wildlife protection, safeguarding wildlife habitats while deriving livelihoods from tourism.

Ecosystem health was established through field survey (habitat observation, ecosystem analysis based on observation of vegetation status, land cover, the status of water systems, relative wildlife distribution, the general outlook of numbers without counts, species observed (diversity)). Also, wildlife details were surveyed; e.g., the presence of young animals, patterns of movement, and indications of breeding and relative numbers of females to deduce the ecosystem health. The status of businesses was established based on arrivals, flight landings, and take-offs, tour vehicle traffic, level of operation of lodges. Status at the cultural tourism at the BOMAs involved data on the level of tourism activity, the volume of business, observable vulnerabilities, and adaptation mechanisms.

1. Key informant interviews; interviewing key players, including lodge managers, lodge staff, county government officials, tourism operators, conservancy managers, and protected area managers and community representatives. The same set of questions (Supplementary Materials) were directed to the different categories of respondents.
2. Desktop review on past pandemics and adaptation strategies mechanisms on a global scale to give reference of analysis to the case of Masai Mara. Review of the county integrated development plan (CIDP) to establish linkage, gaps, and options for policy direction on tourism recovery and sustainability.
3. Focus Group Discussion. Involving key stakeholders in the Masai Mara Conservancy. Summary table for the distribution of the FGDs.

## 2.2. Data Collection and Analysis

The target groups for this study were: community conservancies in the Mara region; tourism operators; the National Government (Kenya Wildlife Service); the Narok County Government; the Masai Mara National Reserve; lodges in the Masai Mara; operators; and the community managed BOMAs (Table 1).

**Table 1.** Summary of stakeholders that formed the sample size in the Masai Mara for both the FGDs and interviews.

Stakeholder Group	Number	Position in the Organization	Interests of the Stakeholder Group
Conservancy managers	9	Manager	Recovery of the ecosystem, adaptation, and new conservation strategies for conservation management.
Narok County Government	4	Manager	Impacts on conservancies, the reserve, the community, and businesses and possible policy interventions for tourism recovery and the sustainability of conservation management
Lodge managers	6	General manager	Tourism recovery and sustainable tourism business management
Reserve Revenue collector	1	Manager	Revenue optimization
Conservancy Management Association	2	Manager	Tourism recovery, sustainable conservation land management, community interest.
Community	3	BOMA owner	Tourism recovery, community livelihoods.
<b>Total</b>		<b>25</b>	

The study adopted a mixed method approach [28] due to the robustness of the study involving both quantitative data and qualitative data through field observations for conservation data, interviews with key stakeholders, and FGDs from small sample populations due to COVID-19 restrictions. Due to the robustness of data from the different data sources due to the mixed methods used, we were able to strengthen and apply the findings even if the sample size was relatively small.

The categories of respondents included in the study were chosen based on their influence on conservation and tourism businesses in the Mara region. The interviewed

respondents were based on convenience; e.g., we interviewed the managers of lodges that were open because most lodges were closed during the 2021 pandemic period. Community numbers were based on the ‘bomas’ that were opened. The participant numbers in the FGDs on 16 July 2021 were smaller due COVID-19 restrictions.

There was also a plenary session involving all the respondents, where recovery data was collected. The recovery data included: the tourism recovery data—what worked, what did not work, the required support framework, and strategies to enhance tourism resilience. The details of the questions used to obtain qualitative data during the interviews and the FGDs are listed in Supplementary Materials.

Analysis of the content from the FGDs and interviews were organized into themes and ranked by the level of importance depending on the number of mentions across the groups, and were then used to develop the results table. The level of importance of the factors to the tourism recovery process was established by ranking as High, Medium, or Low, depending on the number of stakeholder groups that mentioned them (Table 2). All the factors mentioned across multiple groups were considered critical for recovery and were used to develop the schematic diagram of the COVID-19 Tourism Recovery Wheel (Figure 1). We categorized the qualitative data from the FGDs into different themes and they were used for the triangulation of the information from the interviews. Factors mentioned across all the groups with key strategic outcomes for conservation communities and businesses were prioritized in terms of policy recommendations. The outputs were organized into impact, lessons learned, adaptations, and policy recommendations.

**Table 2.** Summary of issues assessed, critical factors, and the level of importance of the issues assessed in the planning for tourism recovery in the Maasai Mara National Reserve in the short term.

Issue Assessed	Summary of Critical Factors	Level of Importance in Planning for Recovery in the Short Term
Impacts of the pandemic	Reduced tourism activity, conservation threats, loss of employment, loss of property and idle assets, extra investment in compliance with COVID-19 protocols, and vulnerability of the local community.	High
Lessons learned	Need for a regeneration period, sustained community livelihoods, efficient resource use, diversification of products, multi-level relationships, exploring new markets and maintaining stable ones, partnerships and collaborations.	High
Adapting to new trends	Strategic price variation, exploring domestic and regional tourism markets, diversifying products, continuing COVID-19 support framework, implementing sustainable initiatives, stakeholder collaboration and partnership.	Medium
Policy and strategy related factors for recovery	Policy guideline on tourism in the ecosystem, review of park fees and vehicle passes to operators, strategic marketing of Masai Mara, strategy on holistic Narok County tourism development and marketing.	Medium
Emerging issues for policy consideration	Proper legislation on tourism development, joint patrols between conservancies and national reserve, policy on research-based conservation, contingency budgeting for lodges, tour operators and the BOMAS, strategy for long-term collaboration with local media, diversifying the community’s economic activities.	Low



**Figure 1.** The tourism recovery wheel: critical factors and policy considerations for the recovery of conservation, tourism businesses, and community resilience.

### 3. Results

#### 3.1. Impact of COVID-19 on Conservation

The indications of improved ecosystem health with stable ecosystem status demonstrated quality habitat for wildlife. Abundant grass and vegetation cover for grazers and browsers, a large number of wildlife populations observed in the field, especially elephants, buffalos, giraffes, zebras. Large herds of buffalos with calves were observed. Lions were observed mating and one was observed with a cub. Wildebeest migration was within the expected time. High diversity (different species observed at close intervals during the drive) and abundance of animal populations. However, there were fears from the conservation managers and the rangers that the shortage of finances towards conservation, the delayed payment of leases for conservation, and the vulnerability of the local community could compromise wildlife security; e.g., the continued vulnerability of the community due to delayed payment of land rates could subject them to sell land under conservation to meet their basic needs, including food and school fees for the education of their children. Another fear emanated from reduced finances leading to poaching activities, as witnessed from an interview with one of the conservation managers:

“Reduced finances from tourism compromised wildlife security due to increased poaching activities.”

### 3.2. Impact of COVID-19 on Communities

COVID-19 motivated multi-level relationships, partnerships, and collaborations to support communities with food resources during the pandemic. Multi-level relationships, partnerships, and collaborations supported communities during the pandemic. Community projects, e.g., schools, dispensaries, and education programs, were halted. Communities lacked basic resources, such as food, due to a lack of funding from the lease for the conservation programme, which was delayed. Furthermore, funding for conservation projects was delayed or stopped, negatively affecting community conservation initiatives; e.g., the payment of land rates. The socio-economic vulnerabilities of the community increased, as indicated by one of BOMAs owners interviewed:

“Teenage pregnancy, early marriages, and school dropouts increased as a result of closure of tourism businesses and loss of property.”

Market day closures stopped the sale of beads. The Moran dance and entertainment were stopped. There were unpaid or reduced land leases. The loss of a market for selling beadwork largely affected the livelihoods of the community. People lost jobs; workers in the lodges went without pay or took pay cuts. Some facilities immediately released staff after the COVID-19 hit. There was food insecurity among the locals and they became dependent on food donations. Beadwork has huge potential for communities and to empower women, with an estimated return of USD-20 in the low season to USD 400 per day. There were also fears of lost gains in terms of sustainable approaches to local livelihoods; e.g., a return to charcoal burning and poaching that could likely compromise the conservation attitude of the local community.

### 3.3. Impact of COVID-19 on Tourism Businesses

Lodges and tour operators were not able to meet their financial obligations to employees, suppliers, and finance regulatory agencies. There was a reduced number of tourism businesses, with full closures between April to November 2020. Some lodges were open, including Ololonana, Kichwa Tembo, and Mara Serena, which received guests. There was low-scale maintenance due to reduced funding for infrastructure development from tourism returns. A gradual return to the lodges and to tour operations was recognized. Vessels were observed in the reserve, giving indications of building up tourism activities; e.g., tour vans, air balloons, flight landings, guest arrivals at the lodges visited, and reported room occupancies that were projected to reach 75% in the third quarter of 2021. A mix of readiness and anxiety due to the trend of COVID-19 with possible impromptu lockdowns that could change the trend of bookings based on experience was evidenced. Lodge businesses projected an increase in lodge occupancies to an average of 75%. There was extra investment in compliance to the COVID-19 protocols and safety preparedness at lodges, airstrip landings, and at community cultural tourism sites, which was attributed to the safety of the guests to enhance safety and tourist confidence; e.g., luggage UV sterilization and sanitization procedures at the lodges. This was in addition to safety handling procedures during dining; e.g., the use of polythene paper gloves at food handling points. Adherence and observation of COVID-19 protocols and safety preparedness at the lodges, airstrip landings, and at the community cultural tourism sites were emphasized. The study established a growing interest in domestic and regional tourists among the lodge owners and tour operators. Domestic and regional tourism markets, diversifying tourism products, and the formation of partnerships had a medium level of importance in tourism recovery, according to the stakeholders. Considering the impacts of the pandemic and lessons learned in the implementation plan for recovery were considered to be of high importance (Table 2).

### 3.4. Lessons Learned

Designated conservation regeneration times could promote habitat regeneration after an active tourism period. A need to accelerate vaccinations at the destination to enhance

the confidence of tourists was recognized. Any uncertainty was due to the overdependence on tourism by communities in Masai Mara, and the need for alternative economic models for communities there. Key community projects, e.g., schools, dispensaries, and education programs, could be supported through multi-level partnerships other than CSR and conservation philanthropy. Tourism-dependent conservation is a threat to the sustainability of community conservancy models. The potential of domestic and regional tourism markets to sustain destinations and businesses, in 2020 and the first half of 2021 budgets of lodges and tour businesses, was possessed by domestic and regional tourists. Emerging international and stable markets, e.g., Mexico, have emerged as a new market, while the U.S. has remained a stable market. Tourists from America have shown confidence in the destination and there remains a stable international market. It is expected that many other international markets will continue to emerge. The importance of loyalty programs; loyal travelers were the first to return and those who kept their bookings, prompting the need to enhance loyalty programs to enhance the rate of travel uptake. Cost management and efficient resource use have drawn interest from the managers of lodges. The role of innovation and technology in tourism practice, e.g., social media marketing and the use of digital platforms in marketing, has risen. Insurance, contingency, and emergency funds are needed to support staff salaries in case of future pandemics. Insurance of community BOMAS, which are key facilities for cultural tourism to secure the livelihoods of the tourism-dependent communities. Training for staff versatility in the tourism sector to be able to cope with fast pandemic/calamity-induced changes at the workplace. Diversification of community economic activities beyond tourism to support the community in case tourism is affected at the community level to avoid overdependence on tourism. There is a need for accelerated vaccinations to boost traveler confidence (Table 1).

### *3.5. Critical Factors for Recovery*

Enhanced vaccination rates, by promoting vaccine availability and access to COVID-19 testing, was identified as critical for recovery. A strong land tenure system to protect land under conservation; e.g., policy on land use ownership to limit sub-division was considered critical to protect community land under conservation. Collaboration between reserve and community conservancies to establish synergies for conservation, while maintaining the partnership with local media for marketing the conservation area to the domestic market. Maintaining lease payments was established to be critical to sustaining community livelihoods. The need to expand infrastructure (airports and road access) was also determined to be critical. Work with local media to market domestic tourism. Re-building a strong customer base through marketing, attractive rate strategies, service excellence, and loyalty programs. Re-inventing the community economic model from the overdependence on tourism and rethinking funding sources for community projects; e.g., health care and education. It was suggested that these basic projects be prioritized in the county development agenda. Continuing the COVID-19 support framework for park fees, vehicle passes, and license fee waivers was proposed to ensure businesses thrive, having paid for the whole year 2020 without the business in more than half of the year. Sustainable initiatives to fund tourism, Small, Micro, and Medium Enterprises (SMMEs) to incentivize the locally owned business to recovery. Motivating and re-building strong customer confidence for return travelers through loyalty programs was observed to be critical. Stakeholder collaboration and partnerships to promote capacity building of industry players in terms of emerging skills and an awareness of emerging issues could largely motivate recovery. The need to review product offers and pricing to respond to local and changing market needs. Operators are considering a long-term plan to fix the debate on developing favorable products and pricing for the domestic market (Figure 1).



## 4. Discussion

### 4.1. Sustainable Approaches to Recovery

Economic consequences of pandemics can be devastating and long-lasting; e.g., Liberia's GDP declined by 8% from 2013 to 2014 [5]. The COVID-19 pandemic is the first global pandemic on such an unprecedented scale broadcasted in real time [11]. A range of policy responses will be required both in the short term [29] to enhance tourist arrivals and for expenditures to grow at a rate that is faster than the historical growth trend, a "catch-up" period to achieve full recovery. During the 9/11 crisis, many countries lowered their regulatory barriers to international visitors; e.g., Singapore, which has visa waiver agreements with well over 150 countries worldwide, saw its international travel quickly recover from the external impact and then surpass its pre-9/11 peak [29]. Approaches could include developing a recovery framework with standards for business continuity, pandemic adaptation plans [30] and laying out a strategy for the mitigation of the underlying drivers of disease emergence for conservation consideration [31].

There is a growing interest in domestic and regional tourist markets that sustained tourism businesses when the international tourists were not able to travel in the larger part of 2020; e.g., [32,33]. The majority of the 2020 travelers were local guests, pointing to the need to grow tourism from within, largely informed by the needs of the local-regional market before considering the international market [32]. Effective product and service pricing for the local and regional markets are seen to be critical. Lodges lowered the rates for local markets and are considering defining the market rate for the segment. The importance of partnerships for recovery has been highlighted in engaging the travel trade to take quick action [34]. Partnering in terms of promotional fares and short-term low prices were used to encourage travel following the outbreak of SARS in South East Asia [35] and after the Bali bombings [36]. Discounts and promotional fares were also successful in tourism recovery in Canada after a devastating forest fire [37]. Loyal visitors are most likely to respond to post-disaster marketing messages and are likely to be among the first visitors to return [38,39]. This informs the need to promote loyalty programs at the destination. Ref. [35] proposed that businesses should consider displaying 'Welcome Back' messages, to thank their customers for returning and to maintain the goodwill of repeat visitors. This highlights the importance of relationship marketing to aid in the recovery process. The industry is encouraged to focus on market research [34] and communications, which are needed to restore confidence in a destination before the commencement of recovery marketing. The extra investment by lodges in hygiene and safety protocols is intended to build the confidence of tourists to the destination. These policies will help destinations remain resilient by changing pricing tactics and diversifying tourism offerings. They will also work to lessen social inequality that exists in the existing global political economy of tourism [33]. Similarly, these approaches may aid in mitigating the spread of neo- or post-colonial tourism experiences [40].

Although the effects of COVID-19 are anticipated to last for some time [9], countries must make more of an effort to globally loosen travel restrictions and take away obstacles that visa applicants experience [41]. Easing travel restrictions to virus-free travelers would help breathe new life into the tourism and service industries [11]. Government fiscal policy on the support of Small, Medium, and Micro Enterprises (SMMEs) in tourism will be necessary. Engaging with governments and regulators as part of a recovery strategy for fiscal and financial support; e.g., in the aftermath of the 2004 Boxing Day Tsunami, the Thai government offered businesses loans, grants, and equity sharing deals to speed up recovery and reconstruction [7]. The governmental plan to enhance the vaccination rate will build the confidence of travelers; e.g., American tourist numbers were mentioned by lodge managers as the highest number of travelers in Masai Mara, attributed to the high vaccination rate in the U.S. Therefore, it is advised that the government promote vaccine availability and access to COVID-19 testing. The current COVID-19 testing initiatives and compliance supplies have been observed to not be working. Targeted vaccination drives

at key tourist destinations for staff working at lodges and in tour operations, as well as country-wide vaccination uptake, could largely promote tourist confidence.

#### 4.2. Policy Initiatives to Support Recovery

As a lesson from history, many of the economic problems from the 1970s oil shock came from the inflation sparked by inappropriate macroeconomics policy responses, not just the actual oil shortage; this can be linked to COVID-19. The size and persistence of the economic damage will depend on how governments handle policy interventions. Monetary policy action should be intended to support small- and medium-sized businesses, which are most exposed to liquidity [13]. There is a need for a coordinated policy response to the impacts of COVID-19 [5]. Managing economic recession due to COVID-19 will be dependent on the success of government policies to alleviate liquidity problems of the SMMEs and to secure jobs for the citizens [5]. In the face of real and financial stress in the pandemic period, the role of governments is critical both at the county and national government levels. The shock is not only felt in terms of demand management, but it is multi-faceted and will require monetary, fiscal, and health policy responses [29]. The government fiscal policy should be comprehensive to care for SMMEs [42,43]. An emerging conservation issue is to assess the role of wildlife diversity not only in terms of the number of species (or their abundance), but also in terms of the capacity to mitigate and reduce emerging infectious diseases (EID) and zoonosis [31]. Proper legislation to integrate community livelihoods and tourism development while diversifying the economic venture of the communities will be in order. A policy guideline to promote partnerships for ecosystem-wide management between protected areas and outside protected areas to create synergies between conservancies and the reserve. A strategy on holistic Narok County Tourism development and marketing would be appropriate.

#### 4.3. Practical Applications of the Study and Its Results

The findings of the study may be used to build a sustainable tourism management strategy for the Mara, which might be expanded to other tourist hotspots in Kenya and throughout East Africa. The findings can influence community, tourism, and conservation practitioners, as well as best practices in terms of stakeholder engagement techniques. The findings can help the county and the national government develop policies to promote the resurgence of the tourism sector. The findings on the tourism recovery wheel (Figure 1) may be used by the county government of Narok and the national government of Kenya to determine the important areas in which to encourage tourism recovery, creating a framework for tourism management processes in the post-pandemic era.

#### 4.4. Limitations of the Study

Due to COVID-19 constraints during the pandemic era, the study was constrained by a small sample size. Given the unpredictable transition between tourism's closure and opening caused by COVID-19 incidents, data collection took place over a brief period of time. By combining data from several sources, utilizing a mixed-method approach, and dispersing the sample size among various stakeholder groups, we were able to overcome these constraints. Stakeholders were also selected from a larger geographic area inside the Mara region.

### 5. Conclusions

The pandemic has had a negative impact on tourism businesses, community livelihoods, and conservation in Masai Mara. The loss of employment due to the closure of tourism businesses increased the socio-economic vulnerabilities of the local community. To support conservation, stakeholders must collaborate in terms of sustainable financing through community-based conservation programs. Domestic and regional tourism markets should be explored to diversify the tourism market for Masai Mara. Recovery initiatives and sustainable funding for SMMEs are essential for tourism recovery. Critical factors for

recovery in the short term include: addressing the impact of the pandemic, including loss of property, conservation threats, loss of employment, sustaining community livelihood programs, diversification of tourism products, exploring new tourism markets, multi-level partnerships and collaborations, domestic and regional tourism markets, a strong policy guideline to harmonize tourism, conservation, and community livelihoods. In the future, we recommend that policies that support long-term growth emphasize the tourism business-community livelihood nexus.

## 6. Recommendations

We recommend the implementation of sustainable initiatives to fund SMMEs, and explore the potential of domestic and regional tourism markets. This will help stabilize the local economy and support the foundation for tourism growth. We also propose diversifying tourism products and creating all-year-round products by exploring new markets while maintaining stable ones. Additionally, a strategic price variation plan could be considered to control tourism traffic to support ecosystem regeneration in the Mara. Lastly, we suggest implementing policies and strategies to support conservation efforts, reviewing park fees and vehicle passes, and engaging in strategic marketing of Masai Mara as a destination. Furthermore, it is important to consider diversifying the community's economic activities beyond tourism to reduce vulnerability.

**Supplementary Materials:** The following supporting information can be downloaded at: <https://www.mdpi.com/article/10.3390/su15097291/s1>.

**Author Contributions:** Conceptualization, Methodology, Validation, Investigation and Supervision, D.C. and C.H. Formal analysis, D.C. Resources, D.C., C.H. and R.N. Funding acquisition, D.C. Writing, Review and Editing, and Visualization, D.C., C.H., R.N. and P.N. Project administration, D.C. and V.M. Writing original draft and reviewing and editing, D.C., C.H., R.N. and P.N. All authors have read and agreed to the published version of the manuscript.

**Funding:** This research was funded by the County Government of Narok. The APC was funded by Strathmore University, School of Tourism and Hospitality.

**Informed Consent Statement:** Informed consent was obtained from all subjects involved in the study.

**Acknowledgments:** We acknowledge Strathmore University for supporting the research process and Narok County for logistical support. We also like to acknowledge the conservancies and lodges that participated in the research.

**Conflicts of Interest:** There was no conflict of interest. The funders had no role in the study's design, data collection, analysis, or interpretation, manuscript writing, or decision to publish the results.

## References

1. Breisinger, C.; Raouf, M.; Wiebelt, M.; Kamaly, A.; Karara, M. *Impact of COVID-19 on the Egyptian Economy: Economic Sectors, Jobs, and Households*; International Food Policy Research Institute (IFPRI): Washington, DC, USA, 2020.
2. Wyplosz, C. Chapter 14: The good thing about coronavirus. In *Economics in the Time of COVID-19*; CEPR Press: London, UK, 2020.
3. UNWTO. International Tourist Arrivals Could Fall by 20–30% in 2020. 26 March 2020. Available online: <https://www.unwto.org/news/international-tourism-arrivals-could-fall-in-2020> (accessed on 28 March 2023).
4. Dinarto, B.D.; Wanto, A.; Sebastian, L.C. *COVID-19: Impact on Bintan's Tourism Sector*; RSIS Commentary, No. 033; Nanyang Technological University: Singapore, 2020.
5. Fernandes, N. *Economic Effects of Coronavirus Outbreak (COVID-19) on the World Economy*; IESE Business School Working Paper No. WP-1240-E; IESE Business School: Barcelona, Spain, 2020; 33p.
6. Yang, Y.; Zhang, H.; Chen, X. Coronavirus pandemic and tourism: Dynamic stochastic general equilibrium modeling of infectious disease outbreak. *Ann. Tour. Res.* **2020**, *83*, 102913. [CrossRef] [PubMed]
7. Segal, H.; Oaten, S.; Le Quesne, K. Adapting to Uncertainty—The Global Hotel Industry. In *The Travel & Tourism Competitiveness Report 2015*; World Economic Forum: Geneva, Switzerland, 2015; pp. 47–51.
8. Tew, P.J.; Lu, Z.; Tolomiczenko, G.; Gellatly, J. SARS: Lessons in strategic planning for hoteliers and destination marketers. *Int. J. Contemp. Hosp. Manag.* **2008**, *20*, 332–346.
9. Hoque, A.; Shikha, F.A.; Hasanat, M.W.; Arif, I.; Hamid, A.B.A. The Effect of Coronavirus (COVID-19) in the Tourism Industry in China. *Asian J. Multidiscip. Stud.* **2020**, *3*, 52–58.

10. Ruiz Estrada, M.A.; Park, D.; Lee, M. The Evaluation of the Final Impact of Wuhan COVID-19 on Trade, Tourism, Transport, and Electricity Consumption of China. *SSRN Electron. J.* **2020**, 1–13. [CrossRef]
11. Strielkowski, W. International Tourism and COVID-19: Recovery Strategies for Tourism Organisations. *Preprints* **2020**, 2020030445. [CrossRef]
12. Riley, T.; Sully, E.; Ahmed, Z.; Biddlecom, A. Estimates of the Potential Impact of the COVID-19 Pandemic on Sexual and Reproductive Health in Low- and Middle-Income Countries. *Int. Perspect. Sex. Reprod. Health* **2020**, *46*, 73–76. [CrossRef] [PubMed]
13. Wyplosz, C. So far, so good: And now don't be afraid of moral hazard. In *Mitigating the COVID Economic Crisis: Act Fast and Do Whatever It Takes*; Baldwin, R., di Mauro, B.W., Eds.; CEPR Press: London, UK, 2020; pp. 25–30.
14. The Government of the Republic of Kenya (GoK). Kenya Tourism Sector Performance Report—2019. 2019. Available online: <https://www.globaltourismforum.org/blog/2020/01/16/kenya-tourism-sector-performance-in-2019> (accessed on 28 March 2023).
15. Kenya National Bureau of Statistics (KNBS). *Economic Survey 2020*; KNBS: Nairobi, Kenya, 2020.
16. Tourism Research Institute (TRI). *Kenya Tourism Sector Performance Report*; TRI: Nairobi, Kenya, 2019.
17. The Government of the Republic of Kenya (GoK). Tourism Sector Performance Report—2018. 2018. Available online: <http://ktb.go.ke/wp-content/uploads/2019/01/Tourism-Performance-2018-Presentation-Final2.pdf> (accessed on 28 March 2023).
18. Zhang, S.; Sun, T.; Lu, Y. The COVID-19 Pandemic and Tourists' Risk Perceptions: Tourism Policies' Mediating Role in Sustainable and Resilient Recovery in the New Normal. *Sustainability* **2023**, *15*, 1323. [CrossRef]
19. Inskip, E. *Tourism Planning: An Integrated and Sustainable Development Approach*; Van Nostrand Reinhold: New York, NY, USA, 1991.
20. McCool, S.F. Linking tourism, the environment and concepts of sustainability: Setting the stage. In *Linking Tourism, the Environment and Sustainability*; McCool, S.F., Watson, A.E., Eds.; General Technical Report No. INT-GTR-323; Intermountain Research Station, USDA Forest Service: Ogden, UT, USA, 1995; pp. 3–7.
21. Southgate, C.; Sharpley, R. Tourism, development and the environment. In *Tourism and Development: Concepts and Issues*; Sharpley, R., Telfer, D.J., Eds.; Channel View Publications: Cleveland, OH, USA, 2002; pp. 231–262.
22. Yuksel, F.; Bramwell, B.; Yuksel, A. Stakeholder interviews and tourism planning at Pamukkale, Turkey. *Tour. Manag.* **1999**, *20*, 351–360. [CrossRef]
23. Gunn, C.A. *Tourism Planning: Basics, Concepts, Cases*, 3rd ed.; Taylor and Francis: Washington, DC, USA, 1994.
24. Freeman, R.E. *Strategic Management: A Stakeholder Approach*; Pitman: Boston, MA, USA, 1984.
25. Beierle, T.C.; Konisky, D.M. Values, conflict, and trust in participatory environmental planning. *J. Policy Anal. Manag.* **2000**, *19*, 587–602. [CrossRef]
26. Healey, P. Collaborative planning in a stakeholder society. *Town Plan. Rev.* **1998**, *69*, 1–21. [CrossRef]
27. De-Blij, H.J.; Muller, P.O.; Nijman, J.; Antoinette MG, A. *The World Today: Concepts and Regions in Geography*; Wiley: Hoboken, NJ, USA, 2011.
28. Maxwell, J.A.; Loomis, D.M. Mixed methods design: An alternative approach. In *Handbook of Mixed Methods in Social and Behavioral Research*; SAGE Publications: Thousand Oaks, CA, USA, 2003; pp. 241–272.
29. McKibbin, W.J.; Fernando, R. *The Global Macroeconomic Impacts of COVID-19: Seven Scenarios*; CAMA Working Paper 19/2020; The Australian National University: Canberra, Australia, 2020. [CrossRef]
30. Dalton, C.B. Business continuity management and pandemic influenza. *N. S. W. Public Health Bull.* **2006**, *17*, 138–141. [CrossRef] [PubMed]
31. Di Marco, M.; Baker, M.L.; Daszak, P.; de Barro, P.; Eskew, E.A.; Godde, C.M.; Harwood, T.D.; Herrero, M.; Hoskins, A.J.; Johnson, E.; et al. Sustainable development must account for pandemic risk. *Proc. Natl. Acad. Sci. USA* **2020**, *117*, 3888–3892. [CrossRef] [PubMed]
32. Woyo, E. The Sustainability of Using Domestic Tourism as a Post-COVID-19 Recovery Strategy in a Distressed Destination. In *Information and Communication Technologies in Tourism 2021: Proceedings of the ENTER 2021 eTourism Conference, January 19–22, 2021*; Wörndl, W., Koo, C., Stienmetz, J.L., Eds.; Springer: Cham, Switzerland, 2021. [CrossRef]
33. Adams, K.M.; Choe, J.; Mostafanezhad, M.; Phi, G.T. (Post-) pandemic tourism resiliency: Southeast Asian lives and livelihoods in limbo. *Tour. Geogr.* **2021**, *23*, 915–936. [CrossRef]
34. Mair, J.; Ritchie, B.W.; Walters, G. Towards a research agenda for post-disaster and post-crisis recovery strategies for tourist destinations: A narrative review. *Curr. Issues Tour.* **2016**, *19*, 1–26. [CrossRef]
35. Mckercher, B.; Pine, R. Privation as a Stimulus to Travel Demand? *J. Travel Tour. Mark.* **2005**, *19*, 107–116. [CrossRef]
36. Henderson, J.C. Representations of Islam in Official Tourism Promotion. *Tour. Cult. Commun.* **2008**, *8*, 135–145. [CrossRef]
37. Hystad, P.W.; Keller, P.C. Towards a destination tourism disaster management framework: Long-term lessons from a forest fire disaster. *Tour. Manag.* **2008**, *29*, 151–162. [CrossRef]
38. Walters, G.; Clulow, V. The tourism market's response to the 2009 black Saturday bushfires: The case of Gippsland. *J. Travel Tour. Mark.* **2010**, *27*, 844–857. [CrossRef]
39. Walters, G.; Mair, J. The effectiveness of post-disaster recovery marketing messages—The case of the 2009 Australian bushfires. *J. Travel Tour. Mark.* **2012**, *29*, 87–103. [CrossRef]
40. Hitchcock, M.; King, V.T.; Parnwell, M. (Eds.) *Tourism in Southeast Asia: Challenges and New Directions*; NIAS Press: Copenhagen, Denmark, 2009.

41. Bonham, C.; Edmonds, C.; Mak, J. The impact of 9/11 and other terrible global events on tourism in the United States and Hawaii. *J. Travel Res.* **2006**, *45*, 99–110. [CrossRef]
42. Buseh, A.G.; Stevens, P.E.; Bromberg, M.; Kelber, S.T. The Ebola epidemic in West Africa: Challenges, opportunities, and policy priority areas. *Nurs. Outlook* **2015**, *63*, 30–40. [CrossRef] [PubMed]
43. Kumar, S.; Nafi, S.M. Impact of COVID-19 pandemic on tourism: Recovery proposal for future tourism. *Geof. Tour. Geosites* **2020**, *33*, 1486–1492.

**Disclaimer/Publisher’s Note:** The statements, opinions and data contained in all publications are solely those of the individual author(s) and contributor(s) and not of MDPI and/or the editor(s). MDPI and/or the editor(s) disclaim responsibility for any injury to people or property resulting from any ideas, methods, instructions or products referred to in the content.

## Article

# Factors Determining ROPO Behaviors of Travel Agencies Customers during the COVID-19 Pandemic

Andrzej Dudek , Daria Elżbieta Jaremen \*  and Izabela Michalska-Dudek

Faculty of Management, Wrocław University of Economics and Business, 53-345 Wrocław, Poland

\* Correspondence: [daria.jaremen@ue.wroc.pl](mailto:daria.jaremen@ue.wroc.pl)

**Abstract:** Tourist decision-making has been heavily affected by the pandemic crisis, which increases the complexity of the tourism business operations and shakes the foundations of tourism sustainable development. Thus, studying and comprehension of tourists' behaviors, including the purchasing decisions, and incorporating this knowledge into the strategies of tourism companies, has a key importance to the organizations' survival during hard times. The article contains the characteristics of tourist behavior schemes related to decision-making in buying package holidays during COVID-19 crisis. The study was based on analysis of the results of a computer assisted web interview using the CAWI method, conducted among 1502 Poles using the classification tree method (the R statistical package and the RPART library). Research allowed us to identify the four purchase decision-making patterns and to describe four segments of holidaymakers' buying according to these patterns. In the profiling process, nine demographic and social variables were used, including gender, age, education, residence, marital status, number of all household members, minor children in a household, assessment of own financial standing, and professional situation. The results of the analysis confirm the existence of a relationship between (1) the research online purchase offline behavior and the age, the number of children under 18 in the household, and the marital status of the package holidays buyers, (2) the research offline purchase online behavior and the age and the number of children up to 18 in the households of the buyers of tourist packages, (3) the research offline purchase offline behavior and the age, the number of children under 18 in the household, the assessment of the financial situation, and sex of the buyers of tourist packages, and (4) the research offline purchase online behavior and the age and assessment of financial situation of package holidays purchasers.

**Keywords:** package holiday; tourist decision-making; COVID-19 pandemic; tourist behavior



check for updates

Citation: Dudek, A.; Jaremen, D.E.;

Michalska-Dudek, I. Factors

Determining ROPO Behaviors of

Travel Agencies Customers during

the COVID-19 Pandemic.

*Sustainability* **2023**, *15*, 6142.<https://doi.org/10.3390/su15076142>

Academic Editors: Zygmunt Kruczek

and Bartłomiej Walas

Received: 27 February 2023

Revised: 29 March 2023

Accepted: 31 March 2023

Published: 3 April 2023



Copyright: © 2023 by the authors.

Licensee MDPI, Basel, Switzerland.

This article is an open access article

distributed under the terms and

conditions of the Creative Commons

Attribution (CC BY) license ([https://creativecommons.org/licenses/by/](https://creativecommons.org/licenses/by/4.0/)[https://creativecommons.org/licenses/by/](https://creativecommons.org/licenses/by/4.0/)

4.0/).

## 1. Introduction

Since 1855, when Thomas Cook organized his first foreign excursion to Europe, package tourism and all-inclusive holidays have been prevalent. Despite many changes, innovations, and new solutions (e.g., low-cost airlines and coaches, shared accommodation and carpooling, online and mobile booking) facilitating individual travel arrangements, the package tour is likely to remain popular among many tourists around the world. In the United Kingdom, the cradle of organized tourism, about 18–20% of travelers take a package holiday each year. Among Europeans this formula of travel is often chosen by Germans (36.4%, in 2019); Austrians (32.3%), Danes (35.5%), and Swedes (30.7%) [1]. Before the COVID-19 pandemic (in the period 2017–2019) on average about 21.5% of Polish tourists organized their trips through travel agents [1]. In 2019, package travel appealed to 528.1 million tourists globally and generated 30% total tourism revenue, making it the second largest segment of the travel and tourism market [1].

The COVID-19 pandemic has hit the tourism industry with unprecedented force and on a global scale. The association of travel with spatial mobility and social interaction means that tourism plays a significant role in spreading the virus [2] and amplifies public

health crises [3–5]. For this reason, in 2020, travel was heavily restricted by law. As a consequence of the mobility limitations and the closure of state borders, this was the deepest crisis that affected tourism since World War II. In the first few months of the pandemic (March–June 2020), compared to the same period of the previous year (2019), the decrease in the total number of international trips reached 90% [6]. The number of package holidays users decreased by nearly 59% (2020) in the first year of the pandemic, and by 40.4% in the second year (2021) compared to 2019 [1].

Travelling limitations caused by legal restrictions and/or tourists' concerns, on the one hand, significantly threatened the sustainability of tour operators' functioning and, on the other, prevented many tourists from satisfying their needs which, in turn, may interfere with the effectiveness of resting and result in anxiety and frustration. The decline in the volume of trips, confirmed by official statistics, was also accompanied by changes in tourist behavior. Results of research conducted by Lium et al. [7] indicate the greater value than in the past of such determinants of tourists' choice as accommodation facilities and hygiene protocols and standards, as well as possibilities of keeping a social distance from other customers and minimizing the challenges of longer trips and stays in large, multi-services holiday centers. These changes, in turn, create new challenges for the tourism industry, including tour operators. In the context of the above comments, a study addressing the response of tourism supply and demand entities to the state of the pandemic should be considered a necessary condition in preparing effective strategies for tourism returning to the path of sustainable development.

The reaction of tourists to COVID-19 includes various aspects of tourist behavior, which becomes an absorbing research problem for an increasing number of researchers and studies, e.g., [8–16]. The pandemic most likely also influenced the purchasing behavior of buyers of tourist packages. Before the COVID-19 crisis, researchers noticed a growing share of Internet channels being used when making decisions about the purchase of tourist packages [17–19]. They also observed the ROPO (research online purchase offline) phenomenon, which means a certain part of buyers mixed online and offline channels during decision-making [20–26]. Buyers looked for information about tourist packages on the Internet, whereas they bought them in traditional (brick-and-mortar) travel agencies. The interesting research problem is the identification of the COVID-19 pandemic's impact on tourists' decision-making processes in the case of holiday package purchasing. What did the pandemic situation change in the decision-making process of buying tourist packages? In the article, the authors put forward three research questions:

- (1) What channels, online or offline, are used by buyers of tourist packages during the decision-making process?
- (2) What changes occurred in the usage of online and offline channels in the decision-making process by tourist packages buyers during COVID-19 as compared to the situation before the pandemic?
- (3) How are the socio-demographic characteristics of the segments of buyers of tourist packages distinguished based on the use of online and offline channels in the purchase process?

## 2. COVID-19 and the Decision of Package Holidays Purchase—Literature Review

The literature review conducted for the purposes of the presented research was divided into two parts. In the first part, based on the so-called traditional review, taking into account the most important scientific studies, two categories appearing in the research problem were briefly explained, namely the concept of a tourist package and the concept of the decision-making process of its purchase. Recognizing the essence of these two categories allowed for a better understanding of the studied problem and the subject of the analysis. In the second part, using a more rigorous approach, the existing research on the tourist decision-making process in the conditions of the COVID-19 pandemic was reviewed. As a result, a research gap was identified, which allowed us to justify the need for conducting the presented research.

According to Medlik [27] (p. 127) a holiday package (also called a packaged holiday, vacation package, package tour) is a combination of two or more elements sold as a single product for an inclusive price, in which the costs of the individual product components are not separately identifiable. This integrated set of complementary tourist services (usually transport and accommodation) is perceived as a holistic offer. The package comprehensively meets the various needs revealed by tourists during their travels. Tourists choose package tours because of their numerous advantages. Perceived higher quality and value for money, lower risk, and higher convenience compared to tourist services purchased separately [28–31] are the most attractive merits of inclusive tours for buyers.

Package holidays belong to the complex products family and require higher engagement of the customers in decision-making processes [32] (p. 155). For this reason, package buyers report a high demand for information. In general, during the decision-making in the buying of package holidays, motivated by needs, tourists search for information about the available products, assess them in the perspective of their preferences and possibilities, and finalize the purchase [33,34]. In the literature, five compulsory sequential stages of the decision-making process are often listed: (1) need recognition, (2) search for information (which is assumed to be very important), (3) evaluation of alternatives (the consumer evaluates attributes and products), (4) purchase, and (5) outcomes (post-purchase evaluation) [35] (p. 23).

At all the stages mentioned above, package travel buyers can use online and offline channels. They obtain information and buy travel packages via the Internet or a traditional travel agency. Almost all shoppers look for travel information online [19,20,36]. From year to year, more and more tourists also finalize their purchases via the Internet. In 2019, 59% of global travel packages (58% in Poland) were purchased online [1]. Statista [1] predicts that in 2027 this number will reach 73% in the world and 90% in the case of Poland. Researchers [20–24] have also identified the phenomenon of the so-called switching channels for booking packages, which means that package buyers can adopt the following four behavior patterns: (1) buyers search for information and buy travel packages online, (2) buyers search for information and buy travel packages in traditional travel agencies (offline), (3) buyers look for information about packages on the Internet and buy in traditional travel agencies (ROPO), and (4) buyers seek for information about packages in traditional travel agencies and buy on the Internet (reversed-ROPO, r-ROPO).

The coronavirus, which affected tourism more than other large sectors of the economy, has generated enormous interest in the scientific community. As a result, hundreds of articles are published presenting research results on various aspects of the impact of COVID-19 on tourism, as confirmed by the literature review carried out for this study. As already mentioned, the task of this review is to identify previous studies dedicated to the issue of the impact of the pandemic on the decision-making processes of buyers of tourist packages.

Two of the most recognizable scientific data bases, namely Scopus and Web of Science (WoS), have been used in the research. Data were gathered on 1 February 2023. Research concerned the period 2020–2023. Searches of the articles were carried out systematically, according to the established categorization key, which embraced two categories (items), namely (1) “COVID and tourist decision making” and (2) “COVID and tourism decision making”. The search was narrowed to the articles written in English and Polish only. There were 411 manuscripts chosen in the end (WoS—386, Scopus—25). After limiting the choice of categories to “Hospitality, Leisure, Sport, Tourism”, and careful elimination of the duplicates, this number was reduced to 116 articles, which were finally read. Following steps in the search included analysis of the text, their abstracts, and keywords to search for articles referring to decision-making in regard to the tourist services with the emphasis especially on the purchases of holiday packages.

Analysis of the content of the articles has shown that earlier studies concerned different relationships between the pandemic and tourists’ behavior. Among many other issues, academics considered the impact of COVID-19 on purchase intention and probability continuation of tourist trips during the pandemic (e.g., [10,37]), factors determining the undertaking of tourist



trips [14] and tourists' preference (regarding, for example, the length of stay and daily spending) [38], and food services [39] or accommodation services [40]. Researchers were interested in the impact of COVID-19 on the psyche of the tourist (e.g., [8]), their identity (e.g., [9]), needs, and expectations during and after the pandemic (e.g., [41–43]). Diversity of research issues is very important. The studies concern the behavior of the buyers in the stage before undertaking of the trip, i.e., “the pre-travel stage” (e.g., [11,44]) and during the trip, i.e., “the travel stage” (e.g., [12]), as well as the consequences of the pandemic in tourists' behavior in specific locations (e.g., Andalusia, Spain [45]; Zhangjiajie National Forest Park, China [46]; Guangzhou Hanfu Festival, China [47]) or specific nationalities (e.g., Italians [48], Koreans [49], Algerians [41], and Poles [40]). Most studies (94% analyzed publications) address the issue of perception of the risk of disease and its impact on anxiety, as well as the intentions of tourist to travel, the choice of specific tourism products (holiday cruises, air travel), or the choice of tourist destinations (e.g., [11,12]).

The brief literature review presented above confirms the wide spectrum of problems raised in the previous studies related to the pandemic's impact on the behavior of tourists, their intentions, preferences, and perception of travelling in the conditions of COVID-19.

The literature review simultaneously identified a research gap in the study of the decision-making behavior of holiday package buyers. To the best of our knowledge, merely a few of the analyzed studies addressed the issue of the impact of COVID-19 on the perception of the packages by tourists. Pan et al.'s [50] and Xu, Youn and Lee's [11] studies were devoted to the impact of the pandemic on the intention to use the sea travel packages (cruises), and Ren's [51] research concerned tourists' changing behavior in package tourism, but only from tour operators' perspective.

In the case of the presented study, the authors concentrate their particular attention on two stages of the decision-making process regarding tourist package purchases, i.e., seeking the information as well as the purchase completion. Firstly, the study identifies, which of the information and shopping channels, online or offline, played a dominant role in the mentioned stages of the decision process during the pandemic situation. A hypothesis is put forward in the research that the COVID-19 pandemic, as a life-threatening factor, did indeed modify buyer's patterns in the decision-making process and the decision-making process for the purchase of tourist packages, and it intensified the importance of stationary channels both at the stage of obtaining information about the holiday package and finalizing its purchase. Secondly, the research indicates what social-demographic characteristics of package holiday buyers were of key importance for the use of package purchase patterns during the COVID-19 crisis.

### 3. Materials and Methods

The research covering purchasers of package holidays and focusing on the problems of travelling during the COVID-19 pandemic was carried out to answer the research question. A questionnaire was the primary survey tool, and the conducted research was a sample-based study performed using an online survey on a nationwide online panel of respondents (CAWI technique; CAWI is an acronym for computer assisted web interview, which means a computer-assisted interview using a website. In other words, it is a method of collecting data and information in which the respondent completes electronic surveys). The study was characterized by a representative distribution of features for the general population of Poles aged 18–64 in terms of gender, age, education, and size of the place of residence.

Among the surveyed 1502 Poles there were representatives of both sexes, and the most numerous age groups were the following age categories: 26–35, 36–45, and 46–60 (25.03%, 21.84%, and 30.84% of respondents, respectively). Among the respondents, married people prevailed (53.06% of responses), as did the respondents with a secondary education (42.21% of respondents). The respondents' households usually consisted of 2 to 4 people (a total of 78.3% of the responses), and every second respondent had minor children in their household. Furthermore, 64.51% of the respondents were working people. The largest group of respondents (59.79%) were the respondents living in cities. More than half of the

respondents assessed their financial situation as average, and less than 3% of them believed that it was very bad.

The study sought to identify the directions of changes in purchasing behaviors regarding package holidays caused by the COVID-19 pandemic threat and the factors determining purchasing behaviors during the pandemic.

To analyze the factors determining the occurrence of four patterns of behavior of package holidays buyers, in addition to the statistical description, the study also used the methods of multidimensional statistical analysis. According to Hair et al. based on the division of multidimensional data analysis methods [52] (p. 13) when examining the dependence of phenomena, if the analysis concerns one explanatory variable, measured on a non-metric scale, one can use, for example, a classification tree method. Classification trees are used to determine the affiliation of cases or objects to classes of a categorical explanatory variable measured on weak scales based on measurements of one or more explanatory variables. Classification tree analysis is currently one of the most commonly used data analysis techniques.

#### 4. Results

The respondents were asked about their procedure regarding both searching for information on package holidays and purchasing them. They indicated the most common way of proceeding, choosing among four patterns, when buying a tourist package before the COVID-19 pandemic (797 respondents) and during it (254 respondents) out of the total of 1502 respondents who declared such a purchase. The table below shows the structure of individual segments of package buyers before and during the COVID-19 pandemic (Table 1).

**Table 1.** Behavior of package holidays buyers (before and during the COVID-19 pandemic).

Behavior of Package Holidays Buyers	Total	
	Number	%
Before COVID-19 pandemic	797	100.0%
I was looking for information about trips on the Internet, but I bought it in a traditional/brick-and-mortar travel agency (research online, purchase offline behavior)	132	16.56%
I was looking for information about trips in a traditional/brick-and-mortar travel agency, but I bought it on the Internet (research offline, purchase online behavior, ROPO)	95	11.92%
I was looking for information about trips and I purchased them in a traditional travel agency (research offline, purchase offline behavior)	41	5.15%
I searched for information about trips and I purchased them on the Internet (research online, purchase online behavior)	529	66.37%
During COVID-19 pandemic	254	100.0%
I was looking for information about trips on the Internet, but I bought it in a traditional/brick-and-mortar travel agency (research online, purchase offline behavior)	78	30.71%
I was looking for information about trips in a traditional/brick-and-mortar travel agency, but I bought it on the Internet (research offline, purchase online behavior, ROPO)	81	31.89%
I was looking for information about trips and I purchased them in a traditional travel agency (research offline, purchase offline behavior)	20	7.87%
I searched for information about trips and I purchased them on the Internet (research online, purchase online behavior)	75	29.53%

Source: authors' compilation based on survey studies.

It turned out that the structure of responses regarding behavioral patterns before and during the pandemic significantly differed. Before the pandemic, i.e., until March 2020, the following could be observed:

- A total of 66.37% of the respondents admitted that they most often followed the research online purchase online scheme;
- A total of 16.56% of respondents most often indicated the research online purchase offline purchase scheme;
- A total of 11.92% of the surveyed people followed the research Offline Purchase Online scheme;
- A total of 5.15% of all respondents were the buyers attached to stationary sellers of tourist events and the research offline purchase offline scheme.

During the COVID-19 pandemic, in the case of package travel purchases, there was a significant decrease in the percentage of research online purchase online behavior by 36.84 percentage points (to 29.53%), with a significant increase in the percentage of research offline, purchase online behavior by nearly 20 percentage points (up to 31.89%) and research online, purchase offline behavior by 14.15 percentage points (up to 30.71%), with a slight increase in research offline, purchase offline behavior by 2.72 percentage points (up to 7.87%). Therefore, much less often than before the COVID-19 pandemic, the buyers of organized packages transfer the entire purchasing process online, i.e., they both look for information on the offers of travel agencies and make purchases online.

The presented results allow us to conclude that in the face of the threat of the COVID-19 pandemic, the behavior of holiday package buyers has changed significantly in the case of research online, purchase online behavior, research offline, purchase online behavior, and research online, purchase offline behavior. The research offline, purchase offline behavior group, on the other hand, was the smallest group both before and during the pandemic and did not show any significant changes in shopping behavior regarding tourist packages.

In order to identify factors determining the choice of one of the purchase patterns, classification trees were estimated using the RPART function in stats package (R Core Team 2022). Based on the data, the sets of classification tree models were built for all four explanatory variables. Among the 254 respondents who answered yes, declaring that they had purchased a package since the start of the studied period, incomplete data were omitted, and 206 observations were included in the final analyses.

In the statistical study of dependence, the following four patterns of purchasing tourist packages during the COVID-19 pandemic, declared by buyers, were adopted as the dependent variable:

1. Research online purchase offline behavior [Q\_28\_A];
2. Research offline purchase online behavior [Q\_28\_B];
3. Research online purchase online behavior [Q\_28\_C];
4. Research offline purchase offline behavior [Q\_28\_D].

All the above dependent variables were measured on a nominal scale: [1] yes, [2] no.

The following socio-demographic factors describing holiday packages purchasers were selected as explanatory variables: variable Q\_S1—gender (measured on a nominal scale), variable Q\_S2—age (measured on an ordinal scale), variable Q\_S3—education (measured on an ordinal scale), variable Q\_S4—place of residence (measured on a nominal scale), variable Q\_M1—marital status (measured on an ordinal scale), variable Q\_M2—the number of all household members (measured on an quotient scale), variable Q\_M3—number of minor children in the household (measured on quotient scale), variable Q\_M4—assessment of own financial situation (measured on an ordinal scale), and variable Q\_M5—professional situation (measured on a nominal scale).

The representation of classification trees 1–4 obtained as a result of the procedure is shown in the figure below (Figure 1).

1. Classification tree for the set „Research Online Purchase Offline Behavior”

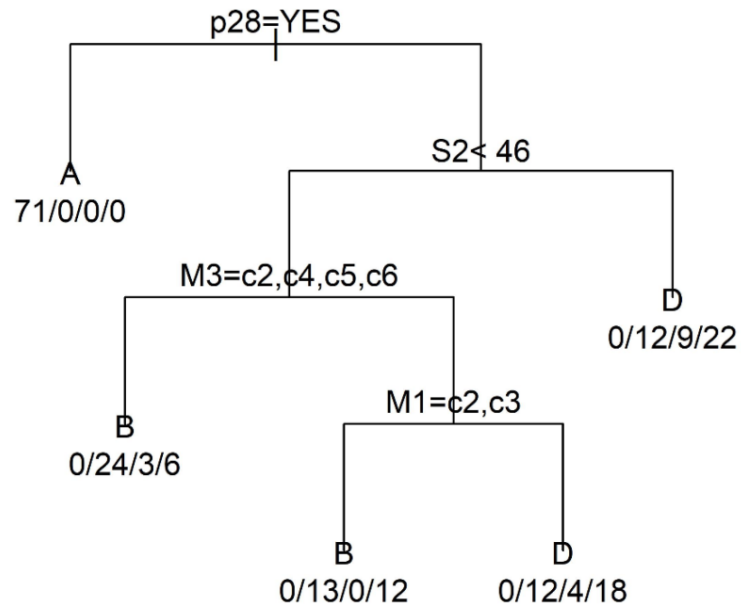

2. Classification tree for the set „Research Offline Purchase Online Behavior”

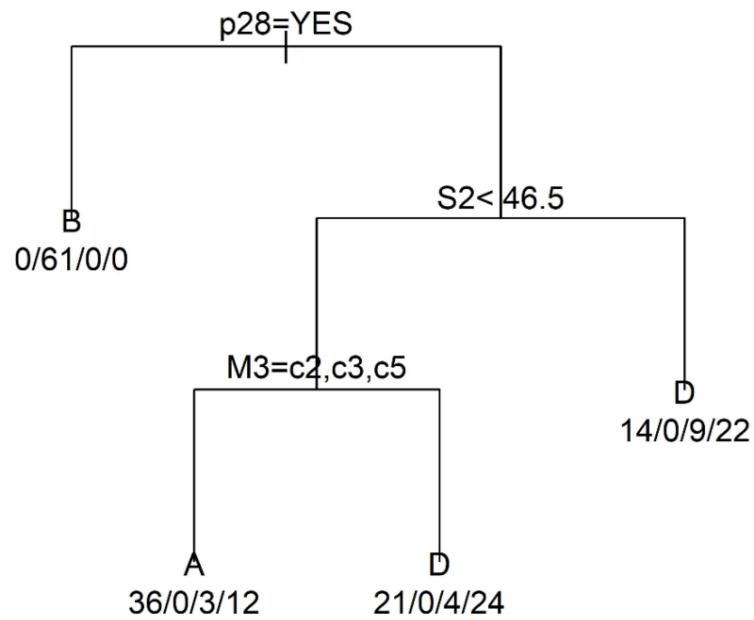
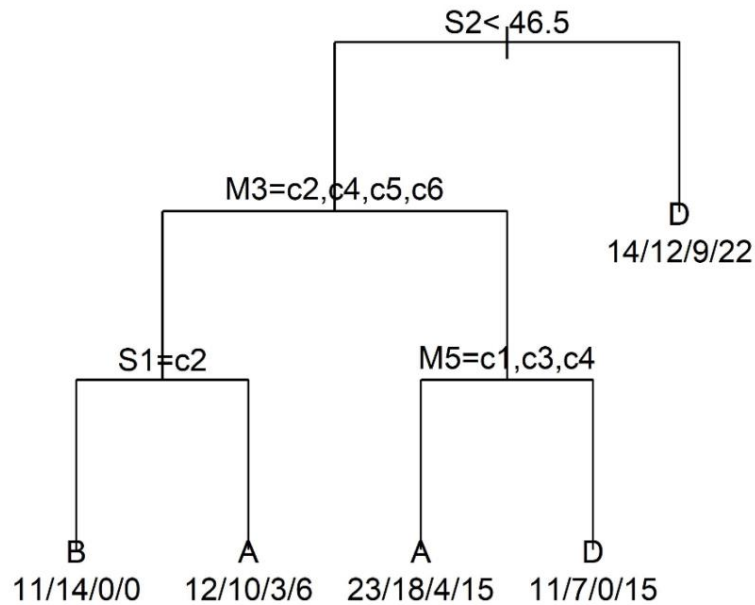
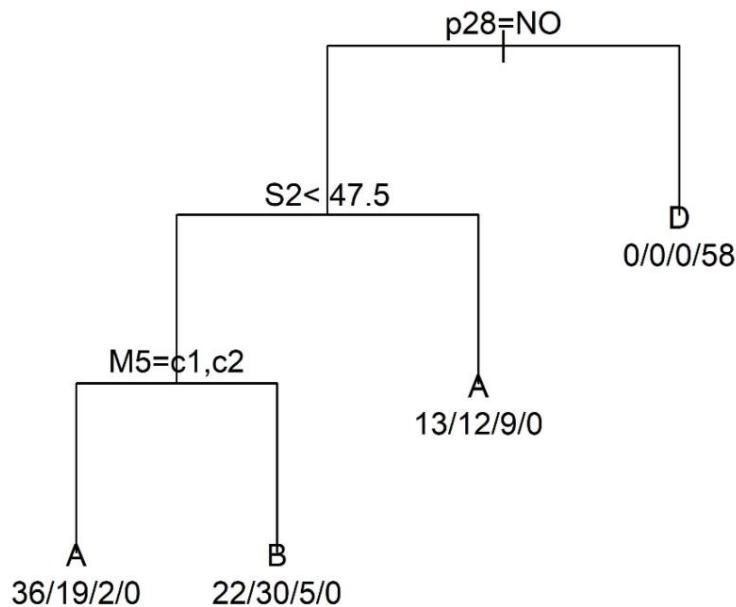

Figure 1. Cont.

3. Classification tree for the set „Research Offline Purchase Offline Behavior”



4. Classification tree for the set „Research Online Purchase Online Behavior”



**Figure 1.** Classification trees for the sets (1) “Research Online Purchase Offline Behavior”, (2) “Research Offline Purchase Online Behavior”, (3) “Research Offline Purchase Offline Behavior”, and (4) “Research Online Purchase Online Behavior”. Source: own elaboration using the R statistical package and the RPART library.

The following lines presented in Figure 2 describe the rules that create the classification tree for the four analyzed sets—individual nodes of the tree (node), the way of dividing the

space (split), the number of observations (n), the size of the measure evaluating diversity (deviance), and the distributions of the dependent variable ROPO in all classes (yval).

**1. Classification tree for the set „Research Online Purchase Offline Behavior”**  
(node), split, n, loss, yval, (yprob) \* denotes terminal node

```

1) root 206 135 A (0.34466019 0.29611650 0.07766990 0.28155340)
2) p28=YES 71 0 A (1.00000000 0.00000000 0.00000000 0.00000000) *
3) p28=NO 135 74 B (0.00000000 0.45185185 0.11851852 0.42962963)
6) S2< 46 92 43 B (0.00000000 0.53260870 0.07608696 0.39130435)
12) M3=c2,c4,c5,c6 33 9 B (0.00000000 0.72727273 0.09090909 0.18181818) *
13) M3=c1,c3 59 29 D (0.00000000 0.42372881 0.06779661 0.50847458)
26) M1=c2,c3 25 12 B (0.00000000 0.52000000 0.00000000 0.48000000) *
27) M1=c1 34 16 D (0.00000000 0.35294118 0.11764706 0.52941176) *
7) S2>=46 43 21 D (0.00000000 0.27906977 0.20930233 0.51162791) *

```

**2. Classification tree for the set „Research Offline Purchase Online Behavior”**

(node), split, n, loss, yval, (yprob) \* denotes terminal node

```

1) root 206 135 A (0.34466019 0.29611650 0.07766990 0.28155340)
2) p28=YES 61 0 B (0.00000000 1.00000000 0.00000000 0.00000000) *
3) p28=NO 145 74 A (0.48965517 0.00000000 0.11034483 0.40000000)
6) S2< 46.5 100 43 A (0.57000000 0.00000000 0.07000000 0.36000000)
12) M3=c2,c3,c5 51 15 A (0.70588235 0.00000000 0.05882353 0.23529412) *
13) M3=c1,c4 49 25 D (0.42857143 0.00000000 0.08163265 0.48979592) *
7) S2>=46.5 45 23 D (0.31111111 0.00000000 0.20000000 0.48888889) *

```

**3. Classification tree for the set „Research Offline Purchase Offline Behavior”**  
(node), split, n, loss, yval, (yprob) \* denotes terminal node

```

1) root 206 135 A (0.34466019 0.29611650 0.07766990 0.28155340)
2) S2< 46.5 149 92 A (0.38255034 0.32885906 0.04697987 0.24161074)
4) M3=c2,c4,c5,c6 56 32 B (0.41071429 0.42857143 0.05357143 0.10714286)
8) S1=c2 25 11 B (0.44000000 0.56000000 0.00000000 0.00000000) *
9) S1=c1 31 19 A (0.38709677 0.32258065 0.09677419 0.19354839) *
5) M3=c1,c3 93 59 A (0.36559140 0.26881720 0.04301075 0.32258065)
10) M5=c1,c3,c4 60 37 A (0.38333333 0.30000000 0.06666667 0.25000000) *
11) M5=c2,c5 33 18 D (0.33333333 0.21212121 0.00000000 0.45454545) *
3) S2>=46.5 57 35 D (0.24561404 0.21052632 0.15789474 0.38596491) *

```

**4. Classification tree for the set „Research Online Purchase Online Behavior”**  
(node), split, n, loss, yval, (yprob) \* denotes terminal node

```

1) root 206 135 A (0.34466019 0.29611650 0.07766990 0.28155340)
2) p28=NO 148 77 A (0.47972973 0.41216216 0.10810811 0.00000000)
4) S2< 47.5 114 56 A (0.50877193 0.42982456 0.06140351 0.00000000)
8) M5=c1,c2 57 21 A (0.63157895 0.33333333 0.03508772 0.00000000) *
9) M5=c3,c4,c5 57 27 B (0.38596491 0.52631579 0.08771930 0.00000000) *
5) S2>=47.5 34 21 A (0.38235294 0.35294118 0.26470588 0.00000000) *
3) p28=YES 58 0 D (0.00000000 0.00000000 0.00000000 1.00000000) *

```

**Figure 2.** Rules creating classification trees for sets (1) “Research Online Purchase Offline Behavior”, (2) “Research Offline Purchase Online Behavior”, (3) “Research Offline Purchase Offline Behavior”, and (4) “Research Online Purchase Online Behavior”. Source: own elaboration using the R statistical package and the RPART library.

Figure 3 presents synthetic results of the package holidays purchasers’ classification according to the four types of behavior class.

**“Research Offline Purchase Online Behavior” class**

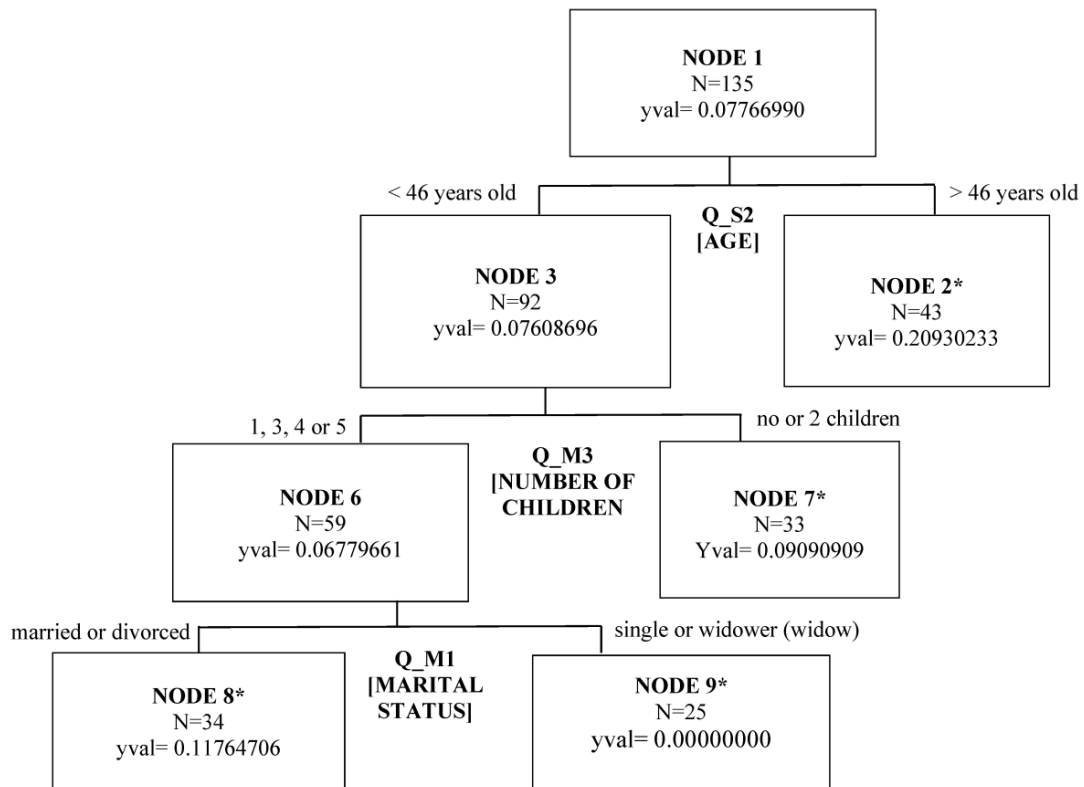

**“Research Online Purchase Offline Behavior” class**

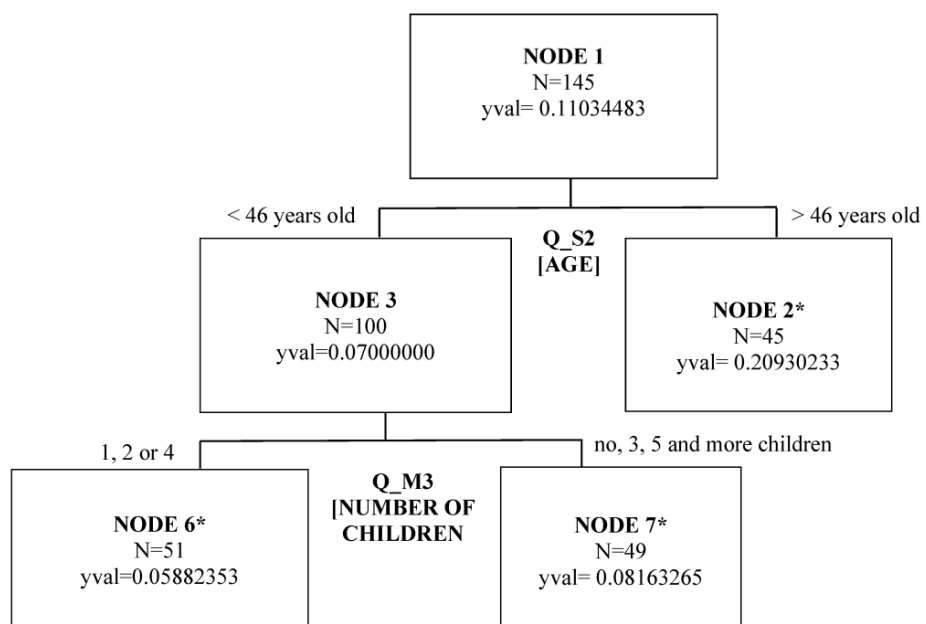
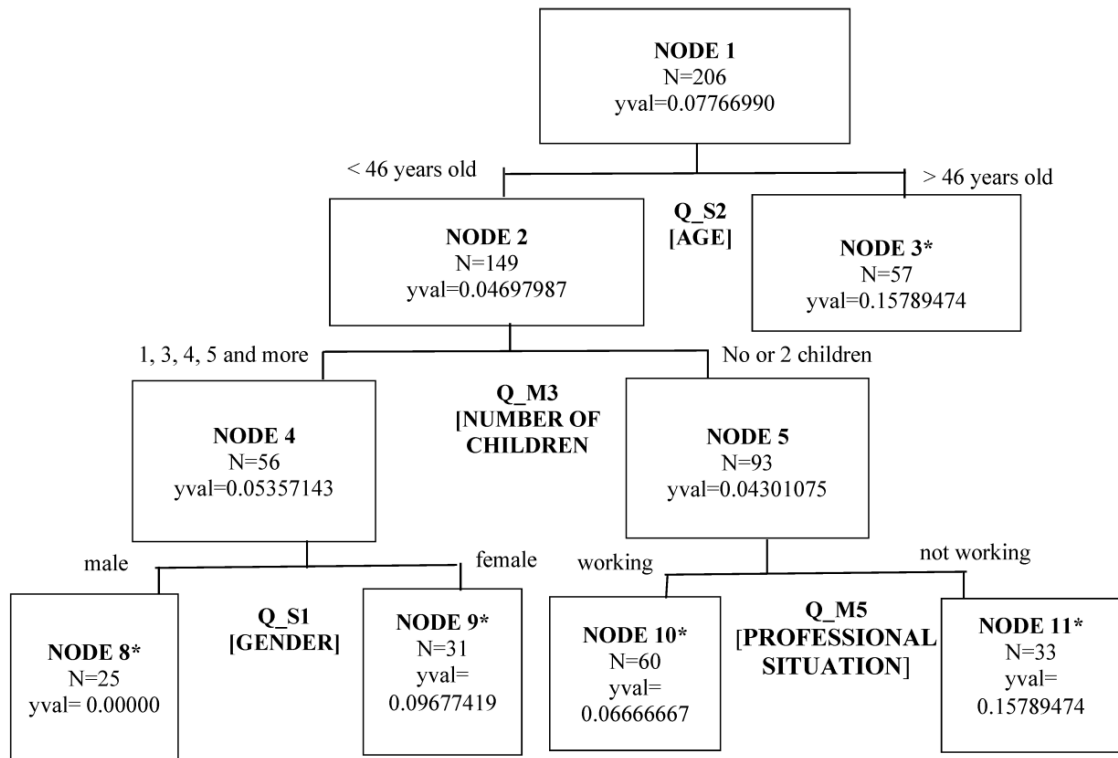
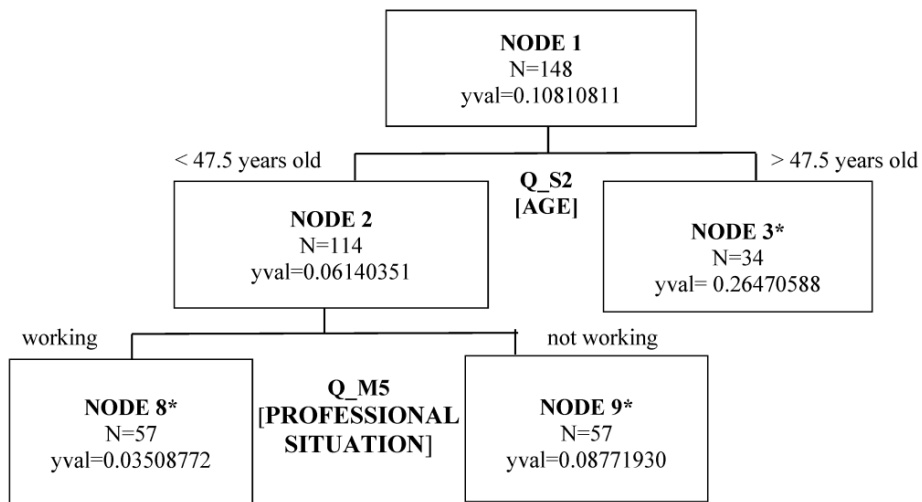

Figure 3. Cont.

**“Research Offline Purchase Offline Behavior” class**



**“Research Online Purchase Online Behavior” class**



**Figure 3.** Classification results of holiday packages buyers according to four types of behavior. \*—terminal node; N—the number of respondents in a given class; yval—fitted value of the ROPO variable in all classes; MSE—mean square error. Source: authors’ compilation based on survey studies using R package and RPART library.



As presented in Figure 3, the obtained calculations show that the variables located in the upper nodes of individual classification trees have the greatest discriminant value and a key share in defining the division of the examined space into segments (Table 2), i.e.:

- For the “Research Online Purchase Offline Behavior” class, the age of the buyer of tourist services (Q\_S2), the number of children under 18 in the household of the buyer of tourist services (Q\_M3), and the marital status of the buyer of tourist services (Q\_M1) are factors. However, studies have not shown a relationship between this behavior and other socioeconomic factors.
- For “Research Offline Purchase Online Behavior” class, the age of the buyer of tourist services (Q\_S2) and the number of children under 18 in the household of the buyer of tourist services (Q\_M3) are factors. However, studies have not shown a relationship between this behavior and other socioeconomic factors.
- For “Research Offline Purchase Offline Behavior” class, the age of the buyer of tourist services (Q\_S2), the number of children under 18 in the household of the purchaser of travel services (Q\_M3), occupational situation (Q\_M5), and the gender of purchaser of travel services (Q\_S1) are factors. However, studies have not shown a relationship between this behavior and other socioeconomic factors.
- For Research Online Purchase Online Behavior” class, the age of the buyer of tourist services (Q\_S2) and professional situation (Q\_M5) are factors. However, studies have not shown a relationship between this behavior and other socioeconomic factor.

**Table 2.** Profiles of four package holidays buyers’ shopping strategies.

Key Explanatory Variables Describing a Package Holiday Buyer	Purchasing Strategies of Travel Agencies Customers during the COVID-19 Pandemic			
	Research Online, Purchase Offline Behavior	Research Offline, Purchase Online Behavior	Research Offline, Purchase Offline Behavior	Research Online, Purchase Online Behavior
Age	Under 46	Under 46	Under 46	Under 47,5
Number of minor children in the household	One, three, four, or five	One, two, or four	One, three, four, five and more	-
Marital status	Married or divorced	-	-	-
Gender	-	-	Women	-
Professional situation	-	-	Working	Working

Source: authors’ compilation based on survey studies using R package and *RPART* library.

Based on Figure 3, it is possible—using the key explanatory variables describing a package holiday buyer of the most important explanatory variables shown in the study—to characterize the profiles of four package holidays buyers’ shopping strategies and present their specificity, which is provided in Table 2 (titled Profiles of four package holidays buyers’ shopping strategies) and Table 3 (titled Characteristics of package holidays buyers for the four shopping strategies).

A detailed description of the distribution of explanatory variables for the individual decision-making schemes on the purchase of tourist packages during the COVID-19 pandemic is presented in Table 3.

**Table 3.** Characteristics of package holidays buyers for the four shopping strategies.

Purchasing Strategies of Travel Agencies Customers during the COVID-19 Pandemic	Key Explanatory Variables	Characteristics of the Respondents
Research Online, Purchase Offline Behavior	Age of the package holiday buyer (Q_S2)	68.15% of respondents who looked for information about trips on the Internet but bought them in a brick-and-mortar travel agency are people under 46 years of age.
	Number of minor children in the household of the package holiday buyer (Q_M3)	64.13% of respondents among people under 46 who looked for information about trips on the Internet but bought them in a brick-and-mortar travel agency are people with minor children (one, three, four, or five) in their household.
	Marital status of the package holiday buyer (Q_M1);	57.63% of respondents among people under 46 with minor children (one, three, four, or five) who searched for information about trips on the Internet but bought them in a brick-and-mortar travel agency are married or divorced.
Research Offline, Purchase Online Behavior	Age of the package holiday buyer (q_s2)	68.97% of respondents who looked for information about trips in a brick-and-mortar travel agency but bought them online were people under 46 years of age.
	Number of minor children in the household of the package holiday buyer (Q_M3)	51% of the respondents under 46 who looked for information about trips in a brick-and-mortar travel agency but bought them online were people with minor children (one, two, or four).
Research Offline, Purchase Offline Behavior	Age of the package holiday buyer (Q_S2)	72.33% of the respondents who both look for information about trips and purchase them in a traditional travel agency are people under 46 years of age.
	Number of minor children in the household of the package holiday buyer (Q_M3)	62.42% of the respondents under 46 who both look for information about trips and purchase them in a traditional travel agency are people without children or who have two.
	Professional situation of the package holiday buyer (Q_M5)	64.52% of respondents under 46 without children or with two children, who both look for information about trips and purchase them in a traditional travel agency, are women.
	Gender of the package holiday buyer (Q_S1)	55.36% of respondents under 46, without children or with two children, who both look for information about trips and purchase them in a traditional travel agency, are working people.
Research Online, Purchase Online Behavior	Age of the package holiday buyer (Q_S2)	77.03% of the respondents who both looked for information about trips and purchased them on the Internet were people under 47.5 years of age.
	Professional situation of the package holiday buyer (Q_M5)	50% of the respondents under 47 who both sought information about trips and purchased them online were working people.

Source: authors' compilation based on survey studies using R package and *RPART* library.

## 5. Conclusions and Discussion

The presented study analyzed the purchasing patterns of tourist package buyers in two periods: before the COVID-19 pandemic and during the pandemic. Significant differences were identified in buyers' use of information and purchasing channels in the decision-making process. Previous studies of other researchers, although not on package purchase decisions, but on tourist behavior in general, also noted a radical change caused by the pandemic [53–55] and an increase in the complexity of tourist behavior [13].

The results of this research indicate the presence of four patterns of decision-making when buying tourist packages during the pandemic, depending on the used combination of the online and offline channels in the following stages: research and the finalization/completion of the purchase. These are (1) research online, purchase online behavior, (2) research offline, purchase offline behavior, (3) research online, purchase offline behavior (ROPO), and (4) research offline, purchase online behavior (reversed-ROPO, r-ROPO). These four buying strategies were used during and before the pandemic [23–26]. The difference, however, lies in the proportion of individual combinations of information and purchasing channels. In the case of the COVID-19 pandemic period (data from 2020), the first scheme (online/online) concerned 29.5% of respondents, the second (offline/offline) concerned 7.9%, the third (ROPO) concerned 30.7%, and the fourth (r-ROPO) applied to 31.9%. Concerning the period before the pandemic, (i.e., 2019) the share of behaviors was as follows: (1) 63.4%, (2) 4.3%, ROPO 10.7%, and r-ROPO 21.4%. The figures provided here prove that COVID-19 has significantly changed the purchasing strategies used by tourist package buyers. In the conditions of the pandemic, a much smaller number of tourist package buyers based their decisions on online channels (only 29.5% of the respondents compared to 63.4% of the respondents who in 2019 completed the entire decision-making process online). During the pandemic, however, the percentage of people who visited a brick-and-mortar travel agency at least at one stage of making purchasing decisions (i.e., searching for information and/or finalizing the purchase) increased significantly. More than a third of the respondents in uncertain times sought personal contact with a travel agent.

The abovementioned shifts between information and purchase channels concern the more intensive use of their stationary counterparts in the purchase decision-making process. The systematically increasing dominance of the “search and buy on the Internet” strategy before the pandemic has, therefore, been stopped. The crisis prompts tourists who make decisions to look for the most up-to-date and reliable sources of information, which in their opinion are more controlled [56], verified, and “tangible”. They consider brick-and-mortar travel agencies as such because the Internet is full of data and, in crisis conditions, often provides sensational information; as this data may not be necessarily true, it does not facilitate the selection of information and does not ensure high accuracy of decisions. Thus, tourists remembered the basic competitive advantage of brick-and-mortar travel agencies, i.e., the “human ability to collate, organize and interpret large amounts of data in a way that delivers the best value for the customers” [57] (p. 114). Knowledge and experience, the ability to think logically and distinguish valuable news from fake news means that, in crisis situations characterized by high volatility, the travel agent is perceived by the client as a source of reliable and up-to-date information. The Internet is a “cloud” with a lot of data, and a travel agent is an expert, an advisor with data processed into important information to make the right decision.

The obtained results confirm the development of an omnichannel distribution of products on the tourist market. The ROPO behavior segment, which was the most numerous group of package holidays buyers during the COVID-19 pandemic (31.89%), can be described as tourists who, on the one hand, are willing to take advantage of new solutions in online distribution but, on the other hand, they have to check everything personally to ensure that they make the right and correct decision. This was particularly important when the decision to purchase an organized trip was made during the pandemic, and any doubts regarding the applicable rules, restrictions, or procedures at the destination of travel required consultation with a travel agency.

In the case of the “ROPO behavior” segment, out of the examined socio-demographic factors, only three should be considered significant in profiling buyer segments, namely age, number of children under 18 in the household, and marital status, all of which play an important role in this case. However, such factors as education, number of people in the household, place of residence, or assessment of one’s own financial situation were not significant.

Buyers who looked for information about trips on the Internet but bought packages in a stationary travel agency are people under 46 years of age, with minor children (one, three, four, or five) in their household, and who are married or divorced. A family client understood in this way, in times of a pandemic threat and many months of remote learning or working, had to provide his family members, including underage children, with a safe and secure rest during an organized trip.

## 6. Theoretical and Practical Implications

The results of our research have important implications both for travel service providers and for researchers. From the economic practice perspective, our findings can support travel agents who are striving to meet their customers' expectations and needs. The situation of uncertainty created by the pandemic is a period in which brick-and-mortar travel agencies can at least partially regain the demand lost due to the development of e-commerce and the growth of online tourist booking. This will require designing appropriate marketing strategies to consolidate customer relationships.

In the theoretical perspective, this study contributes to both marketing theory and consumer behavior theory. It provides knowledge about the response of package holiday buyers to the pandemic—a state previously known only hypothetically. It emphasizes the importance of the health risk perception factor in the purchasing decision process. It draws attention to the role of information provided verbally. It refutes the existing stereotype of online tourist agencies pushing brick-and-mortar travel agencies out of the market. In addition, it directs the attention of researchers towards the somewhat forgotten subject of research, i.e., offline travel agencies.

The presented study is both original and innovative for several reasons:

1. Firstly, it examines the real situation, which means that the respondents described their actual experiences (completed processes) related to making decisions when purchasing tourist packages before and during the pandemic, and not, as in the case of many other studies, only in terms of purchasing intentions in the future.
2. Secondly, the data for both periods (before and during COVID-19) were obtained from the same panel of respondents. Such a research solution has not been identified while reviewing the previous research addressing the pandemic's impact on buyers' behaviors.
3. Thirdly, the research findings based on the data collected from the same panel of respondents allowed for comparing the purchasing patterns in the period before and during the pandemic, while strengthening the reliability and credibility of the comparisons.
4. Fourthly, the ROPO phenomenon in purchasing tourist packages is generally neither a problem noticed nor covered by researchers, despite the fact that it occurs relatively frequently in practice and its analysis can turn out to be highly useful for travel agents.

The research presented in this article is one of the few studies analyzing the decision-making process of purchasers of tourist packages from the perspective of their use of online and offline information channels. The research contributed to a better understanding of tourists' behavior in uncertain times, specifically during the COVID-19 pandemic crisis. The study has high utility because previous research assumptions and insights on tourism may need to be revised during the COVID-19 era [8]. Moreover, studies should be continued because the situation is dynamic. Future tourism recovery will depend on travelers' behavior and their preferences during the decision-making process.

The results of this study contribute to the sustainability issue particularly in the social and economic areas. Knowledge of tourists' behavior supports the recovery of travel companies (here travel agencies) from the pandemic crisis. The research findings also help to better understand the tourist decision-making process in the conditions of uncertainty and higher risk. This allows for a better adjustment of the travel agencies' services to the customers' requirements. Adjusting the service to the expectations of customers contributes to the sustainability of tourism enterprises.

## 7. Limitations and Further Research

The generalization of research results must be performed with care, as there were several limitations. Firstly, this study included only Polish residents who bought a package holidays before and during the pandemic crisis. Further research replicating our analysis among residents of other countries would be valuable in terms of comparing results. Secondly, the same questionnaire was used to survey travelers' decision behavior in buying package holidays during two periods before and during the pandemic. In this regard, a common method bias can appear. Thirdly, this research was carried on at the end of 2020, and it is highly probable that the results obtained do not correspond to the situation in 2021 or 2022. Fourthly, the research was limited to socio-demographic factors influencing decision-making. Therefore, it is recommended to focus further research on other decision-making factors, and above all on the psychographic characteristics of package holiday buyers, and the impact of these factors on the choice of information source as well as purchasing channels during the decision-making process. Future studies should also take into account variables influencing technology acceptance in the decision-making process of package holiday buyers (i.e., perceived ease of ICT use, perceived risk of ICT use, perceived usefulness of ICT). A comprehensive approach to variables is of key importance in explaining the purchasing behavior of tourists.

**Author Contributions:** Conceptualization, A.D., D.E.J. and I.M.-D.; methodology, A.D., D.E.J. and I.M.-D.; software, A.D.; validation, A.D., D.E.J. and I.M.-D.; formal analysis, A.D.; investigation, A.D.; D.E.J. and I.M.-D.; resources, A.D., D.E.J. and I.M.-D.; data curation, A.D., D.E.J. and I.M.-D.; writing—original draft preparation, A.D., D.E.J. and I.M.-D.; writing—review and editing, D.E.J.; visualization, I.M.-D.; supervision, I.M.-D.; project administration, I.M.-D.; funding acquisition, I.M.-D. All authors have read and agreed to the published version of the manuscript.

**Funding:** The research was funded by the Ministry of Science and Higher Education in Poland under the programme “Regional Initiative of Excellence” 2019–2022, project number 015/RID/2018/19, total funding amount 10 721 040.00 PLN.

**Institutional Review Board Statement:** Ethical review and approval were waived for this study due to the anonymous research.

**Informed Consent Statement:** Informed consent was obtained from all subjects involved in the study.

**Data Availability Statement:** Data availability on request.

**Conflicts of Interest:** The authors declare no conflict of interest.

## References

1. Mobility Market Insights. Travel & Tourism. *Package Holidays*. Statista 2023. Available online: <https://www.statista.com/outlook/mmo/travel-tourism/package-holidays/europe?currency=usd#users> (accessed on 12 February 2023).
2. Iaquinto, B.L. Tourist as vector: Viral mobilities of COVID-19. *Dialogues Hum. Geogr.* **2020**, *10*, 174–177. [CrossRef]
3. Abbas, J.; Mubeen, R.; Iorember, P.T.; Raza, S.; Mamirkulova, G. Exploring the impact of COVID-19 on tourism: Transformational potential and implications for a sustainable recovery of the travel and leisure industry. *Curr. Res. Behav. Sci.* **2021**, *2*, 100033. [CrossRef]
4. Wut, T.M.; Xu, J.B.; Wong, S.M. Crisis management research (1985–2020) in the hospitality and tourism industry: A review and research agenda. *Tour. Manag.* **2021**, *85*, 104307. [CrossRef] [PubMed]
5. Zenker, S.; Kock, F. The coronavirus pandemic—A critical discussion of a tourism research agenda. *Tour. Manag.* **2020**, *81*, 104164. [CrossRef]
6. UNWTO. Impact Assessment of the COVID-19 Outbreak on International Tourism. 2022. Available online: <https://www.unwto.org/impact-assessment-of-the-covid-19-outbreak-on-international-tourism> (accessed on 12 January 2023).
7. Li Muli, C.M.; de Cantis, S.; Parroco, A.M. The effects of the pandemic crisis on tourism. A qualitative survey on the opinions of tour operators in Sicily. *DIEM* **2022**, *1*, 153–161. [CrossRef]
8. Kock, F.; Nørfelt, A.; Josiassen, A.; Assaf, A.G.; Tsionas, M.G. Understanding the COVID-19 tourist psyche: The evolutionary tourism paradigm. *Ann. Tour. Res.* **2020**, *85*, 103053. [CrossRef] [PubMed]
9. Zhang, C.X.; Wang, L.; Rickly, J.M. Non-interaction and identity change in COVID-19 tourism. *Ann. Tour. Res.* **2021**, *89*, 103211. [CrossRef] [PubMed]



10. Kourgiantakis, M.; Apostolakis, A.; Dimou, I. COVID-19 and holiday intentions: The case of Crete, Greece. *Anatolia* **2020**, *32*, 148–151. [CrossRef]
11. Xu, W.; Youn, H.-J.; Lee, C.-K. Role of non-pharmaceutical interventions for COVID-19 in cruise tourists' decision-making process: An extended model of goal-directed behavior. *Sustainability* **2021**, *13*, 5552. [CrossRef]
12. Donaire, J.A.; Galí, N.; Camprubi, R. Empty summer: International tourist behavior in Spain during COVID-19. *Sustainability* **2021**, *13*, 4356. [CrossRef]
13. Pappas, N. COVID-19: Holiday intentions during a pandemic. *Tour. Manag.* **2021**, *84*, 104287. [CrossRef] [PubMed]
14. Shin, H.; Nicolau, J.L.; Kang, J.; Sharma, A.; Lee, H. Travel decision determinants during and after COVID-19: The role of tourist trust, travel constraints, and attitudinal factors. *Tour. Manag.* **2021**, *88*, 104428. [CrossRef] [PubMed]
15. Tapsall, S.; Soutar, G.N.; Elliott, W.A.; Mazzarol, T.; Holland, J. COVID-19's impact on the perceived risk of ocean cruising: A best-worst scaling study of Australian consumers. *Tour. Econ.* **2022**, *28*, 248–271. [CrossRef]
16. Zorlu, K.; Tuncer, M.; Taşkın, G.A. The effect of COVID-19 on tourists' attitudes and travel intentions: An empirical study on camping/glamping tourism in Turkey during COVID-19. *J. Hosp. Tour. Insights* **2022**. ahead-of-print. [CrossRef]
17. Amaro, S.; Duarte, P. Online travel purchasing: A literature review. *J. Travel Tour. Mark.* **2013**, *30*, 755–785. [CrossRef]
18. Standing, C.; Tang-Taye, J.-P.; Boyer, M. The Impact of the Internet in Travel and Tourism: A Research Review 2001–2010. *J. Travel Tour. Mark.* **2014**, *31*, 82–113. [CrossRef]
19. Xiang, Z.; Wang, D.; O'Leary, J.T.; Fesenmaier, D.R. Adapting to the Internet: Trends in Travelers' Use of the Web for Trip Planning. *J. Travel Res.* **2015**, *54*, 511–527. [CrossRef]
20. Badanie Panelowe ROPO 2016. *Preferencje i Zachowania Konsumentów w Środowisku Omni-Channel*. pp. 92–95. *Opiniac.com*. 2016. Available online: <http://go.opiniac.com/ropo2016> (accessed on 23 November 2016).
21. Efekt ROPO w Segmencie Travel. Prezentacja Wyników Badania. *Google/TNS OBOP 2009*. Available online: [http://static.googleusercontent.com/media/www.google.pl/pl/pl/googleblogs/pdfs/ropo\\_travel\\_tns\\_obop\\_210110.pdf](http://static.googleusercontent.com/media/www.google.pl/pl/pl/googleblogs/pdfs/ropo_travel_tns_obop_210110.pdf) (accessed on 15 November 2016).
22. ROPO Czy SOPO? Wpływ Internetu na Zachowania Zakupowe Polaków 2011–2016. *Report OEX DIVANTE & IMAS*. p. 32. Available online: <https://divante.pl/aktualnosc/divante-we-wspolpracy-z-imas-zbadalo-wplyw-internetu-na-zachowania-zakupowe-polakow-w-latach-2011-2016#.WktMN7gldFE> (accessed on 21 November 2016).
23. Szopiński, T. The influence of the assessment of Internet websites offering tourist services on the manner of purchase of holiday packages. *Econ. Res. Ekon. Istraz.* **2017**, *30*, 1655–1668. [CrossRef]
24. Dudek, A.; Jaremen, D.E.; Michalska-Dudek, I. Socio-economic factors determining the ROPO trend in the travel industry. *Tour. Econ.* **2020**, *26*, 873–907. [CrossRef]
25. Urlaubsrecherche Immer öfter per Smartphone. *Touristik Aktuell*, Die Wochenzeitung Für Touristike, Mo 20.06.16. Available online: <http://www.touristik-aktuell.de/nachrichten/reiseveranstalter/news/datum/2016/06/20/urlaubs-recherche-immer-oefter-per-smartphone/> (accessed on 18 April 2020).
26. Dudek, A.; Jaremen, D.E.; Michalska-Dudek, I.; Walesiak, M. Analysis of Changes in Shopping Behavior of Package Holidays Purchasers Caused by the COVID-19 Pandemic. *Eur. Res. Stud. J.* **2021**, *XXIV*, 691–707. [CrossRef]
27. Medlik, S. *Dictionary of Travel, Tourism & Hospitality*, 3rd ed.; Butterworth-Heinemann: Oxford, UK, 2003; p. 127. ISBN 0 7506 5650 6.
28. Chiam, M.; Soutar, G.; Yeo, A. Online and Off-line Travel Packages Preferences: A Conjoint Analysis. *Int. J. Tour. Res.* **2009**, *11*, 31–40. [CrossRef]
29. Laing, A.N. The Package Holiday: Participant, Choice and Behavior. Ph.D. Thesis, Philosophy in The Department of Geography, The Hull University, Hull, UK, 1987; p. 19.
30. Money, R.B.; Crofts, J.C. The Effect of Uncertainty Avoidance on Information Search, Planning and Purchases of International Travel Vacations. *Tour. Manag.* **2003**, *24*, 191–202. [CrossRef]
31. Sheldon, P.J.; Mak, J. The Demand for Package Tours: A Mode Choice Model. *J. Travel Res.* **1987**, *25*, 13–17. [CrossRef]
32. Engel, J.F.; Blackwell, R.D.; Miniard, P.W. *Consumer Behavior*, 6th ed.; Dryden Press: Chicago, NY, USA, 1995; p. 155.
33. Crompton, J.L. Structure of Vacation Destination Choice Sets. *Ann. Tour. Res.* **1992**, *19*, 420–434. [CrossRef]
34. Mansfeld, Y. From Motivation to Actual Travel. *Ann. Tour. Res.* **1992**, *19*, 399–419. [CrossRef]
35. Decrop, A. *Vacation Decision Making*; CABI Publishing: Wallingford, UK, 2006; pp. 5–23. ISBN 978-1-84593-040-0.
36. Gondorf, L. Urlaubswelt: Surfst du Noch Oder Reist du Schon? Available online: <http://www.absatzwirtschaft.de/digitale-urlaubswelt-surfst-du-noch-oder-reist-du-schon-57695/> (accessed on 23 November 2016).
37. Boto-García, D.; Leoni, V. Exposure to COVID-19 and travel intentions: Evidence from Spain. *Tour. Econ.* **2022**, *28*, 1499–1519. [CrossRef]
38. Baños-Pino, J.F.; Boto-García, D.; Del Valle, E.; Sustacha, I. The impact of COVID-19 on tourists' length of stay and daily expenditures. *Tour. Econ.* **2021**, *29*, 437–459. [CrossRef]
39. Kim, J.; Lee, J.C. Effects of COVID-19 on preferences for private dining facilities in restaurants. *J. Hosp. Tour. Manag.* **2020**, *45*, 67–70. [CrossRef]
40. Ugliś, J.; Jęczmyk, A.; Zawadka, J.; Wojcieszak-Zbierska, M.M.; Pszczoła, M. Impact of the COVID-19 pandemic on tourist plans: A case study from Poland. *Curr. Issues Tour.* **2022**, *25*, 405–420. [CrossRef]
41. Madani, A.; Boutebal, S.E.; Benhamida, H.; Bryant, C.R. The impact of COVID-19 outbreak on the tourism needs of the Algerian population. *Sustainability* **2020**, *12*, 8856. [CrossRef]

42. Li, J.; Nguyen, T.H.H.; Coca-Stefaniak, J.A. Coronavirus impacts on post-pandemic planned travel behaviors. *Ann. Tour. Res.* **2021**, *86*, 102964. [CrossRef]
43. Orden-Mejia, M.; Carvache-Franco, M.; Huertas, A.; Carvache-Franco, W.; Landeta-Bejarano, N.; Carvache-Franco, O. Post-COVID-19 Tourists' Preferences, Attitudes and Travel Expectations: A Study in Guayaquil, Ecuador. *Int. J. Environ. Res. Public Health* **2022**, *19*, 4822. [CrossRef]
44. Lemy, D.M.; Pramezwary, A.; Juliana, P.R.; Qurotadini, L.N. Explorative Study of Tourist Behavior in Seeking Information to Travel Planning. *Int. J. Sustain. Dev. Plan.* **2021**, *16*, 1583–1589. [CrossRef]
45. Flores-Ruiz, D.; Elizondo-Salto, A.; Barroso-González, M.O. Using social media in tourist sentiment analysis: A case study of Andalusia during the COVID-19 pandemic. *Sustainability* **2021**, *13*, 3836. [CrossRef]
46. Cheng, Y.; Hu, F.; Wang, J.; Wang, G.; Innes, J.L.; Xie, Y.; Wang, G. Visitor satisfaction and behavioral intentions in nature-based tourism during the COVID-19 pandemic: A case study from Zhangjiajie National Forest Park, China. *Int. J. Geoheritage Park.* **2022**, *10*, 143–159. [CrossRef]
47. Yang, J.; Luo, J.M.; Yao, R. How Fear of COVID-19 Affects the Behavioral Intention of Festival Participants-A Case of the HANFU Festival. *Int. J. Environ. Res. Public Health* **2022**, *19*, 2133. [CrossRef]
48. Corbisiero, F.; Monaco, S. Post-pandemic tourism resilience: Changes in Italians' travel behavior and the possible responses of tourist cities. *Worldw. Hosp. Tour. Themes* **2021**, *13*, 401–417. [CrossRef]
49. Wang, J.; Choe, Y.; Song, H. Korean domestic tourists' decision-making process under threat of COVID-19. *Int. J. Environ. Res. Public Health* **2021**, *18*, 10835. [CrossRef]
50. Pan, T.; Shu, F.; Kitterlin-Lynch, M.; Beckman, E. Perceptions of cruise travel during the COVID-19 pandemic: Market recovery strategies for cruise businesses in North America. *Tour. Manag.* **2021**, *85*, 104275. [CrossRef]
51. Ren, L. Chinese tourists' changing behavior in package tours: The suppliers' account. *Tour. Stud.* **2022**, *22*, 328–347. [CrossRef]
52. Hair, J.F.; Black, W.C., Jr.; Babin, B.J.; Anderson, R.E. *Multivariate Data Analysis*, 7th ed.; Pearson Prentice Hall: New York, NY, USA, 2010; p. 13.
53. Truong, D.; Truong, M.D. How do customers change their purchasing behaviors during the COVID-19 pandemic? *J. Retail. Consum. Serv.* **2022**, *67*, 102963. [CrossRef]
54. Larios-Gómez, E.; Fischer, L.; Peñalosa, M.; Ortega-Vivanco, M. Purchase behavior in COVID-19: A cross study in Mexico, Colombia, and Ecuador. *Heliyon* **2021**, *7*, e06468. [CrossRef]
55. Torres, E.N.; Ridderstaat, J.; Wei, W. Negative affectivity and people's return intentions to hospitality and tourism activities: The early stages of COVID-19. *J. Hosp. Tour. Manag.* **2021**, *49*, 89–100. [CrossRef]
56. Cambra-Fierro, J.; Fuentes-Blasco, M.; Gao, L.X.; Melero-Polo, I.; Trifu, A. The influence of communication in destination imagery during COVID-19. *J. Retail. Consum. Serv.* **2022**, *64*, 102817. [CrossRef]
57. O'Connor, P. *Electronic Information Distribution in Tourism and Hospitality*; CAB International: New York, NY, USA, 1999; p. 114. ISBN 978-0-85199-283-9.

**Disclaimer/Publisher's Note:** The statements, opinions and data contained in all publications are solely those of the individual author(s) and contributor(s) and not of MDPI and/or the editor(s). MDPI and/or the editor(s) disclaim responsibility for any injury to people or property resulting from any ideas, methods, instructions or products referred to in the content.

Review

# Systematic Literature Review Analysing Smart Tourism Destinations in Context of Sustainable Development: Current Applications and Future Directions

Youssef El Archi <sup>1,\*</sup>, Brahim Benbba <sup>1</sup>, Zhulduz Nizamatdinova <sup>2</sup>, Yerlan Issakov <sup>3</sup>, Gálicz Ivett Vargáné <sup>4</sup> and Lóránt Dénes Dávid <sup>5,6,\*</sup>

- <sup>1</sup> National School of Business and Management of Tangier, Abdelmalek Essaadi University, Tétouan 93000, Morocco
  - <sup>2</sup> Faculty of Tourism and Languages, Caspian University of Technology and Engineering Named After Sh. Yessenov, Aktau Index 130000, Kazakhstan
  - <sup>3</sup> Department of Geography and Ecology, Institute of Natural Sciences and Geography, Abai Kazakh National Pedagogical University, Almaty 050010, Kazakhstan
  - <sup>4</sup> Doctoral School of Economics and Regional Sciences, Hungarian University of Agriculture and Life Sciences, 2100 Gödöllő, Hungary
  - <sup>5</sup> Department of Sustainable Tourism, Institute of Rural Development and Sustainable Economy, Hungarian University of Agriculture and Life Sciences (MATE), 2100 Gödöllő, Hungary
  - <sup>6</sup> Faculty of Economics and Business, John von Neumann University, 6000 Kecskemét, Hungary
- \* Correspondence: elarchi.youssef@etu.uae.ac.ma (Y.E.A.); david.lorant.denes@uni-neumann.hu (L.D.D.)

**Abstract:** The growing popularity of smart tourism destinations (STDs) has increased the need to investigate their potential impact on sustainable development. This systematic literature review (SLR) aims to analyse the past achievements and future directions of smart tourism destinations in the context of sustainable development. The review was conducted through a systematic literature review that examined 20 papers using a rigorous framework of the research problem, the primary delimitation of the research, and the definition of the data collection and extraction tools. The review focuses on identifying and analysing the current state of the research on SLRs in smart tourism destinations and their implications for sustainable development. This includes the research questions, methods, journals, dates of publications, and key themes. The review also examines the implications and limitations of SLRs in this field, and it identifies gaps in the literature and areas for future directions. The review found that SLRs have been used to examine the impacts of smart tourism destinations on various aspects of sustainable development, such as economic, social, and environmental aspects. Additionally, the review found that there is a growing interest in smart cities, with a focus on reducing the environmental footprint of tourism and promoting sustainable tourism development. The review also identified the emerging research areas in the literature, such as the achievement of the sustainable development goals, the adoption of green IT, smart energy, and waste management.

**Keywords:** smart tourism destination; smart city; sustainable development; systematic literature review (SLR); research agenda



**Citation:** El Archi, Y.; Benbba, B.; Nizamatdinova, Z.; Issakov, Y.; Vargáné, G.I.; Dávid, L.D. Systematic Literature Review Analysing Smart Tourism Destinations in Context of Sustainable Development: Current Applications and Future Directions. *Sustainability* **2023**, *15*, 5086. <https://doi.org/10.3390/su15065086>

Academic Editors: Zygmunt Kruczek and Bartłomiej Walas

Received: 8 February 2023

Revised: 8 March 2023

Accepted: 9 March 2023

Published: 13 March 2023



**Copyright:** © 2023 by the authors. Licensee MDPI, Basel, Switzerland. This article is an open access article distributed under the terms and conditions of the Creative Commons Attribution (CC BY) license (<https://creativecommons.org/licenses/by/4.0/>).

## 1. Introduction

The development of digital technologies in general and artificial intelligence, in particular, encourages destination management organisations (DMOs) and stakeholders to use disruptive technologies to optimise their competitiveness and improve the visitor experience. Several literature reviews have been conducted on this topic, with varying scopes and findings depending on the specific research questions, methods, and databases used. Some studies may focus on specific technologies or sustainability practices, while others may take



a more holistic approach. A new systematic literature review is needed to gather the most up-to-date and comprehensive information on sustainable smart tourism destinations.

Digital technologies are rapidly becoming an important area of academic research in travel and tourism [1,2]. In recent years, researchers have focused on this field's dimensions, issues, and elements. According to Gretzel et al. (2016) [2], any location may be a smart tourism destination if it has two pillars: (1) "soft" intelligence (which includes organisational skills and modalities, including collaborations and partnerships, innovation, and leadership) and (2) "hard" intelligence (which refers to the whole technological infrastructure). A destination is not clever just because one of the two pillars is present. This is dependent on the availability of "hard" intelligence, which enables the improvement in human capital and intelligent decision making based on the use of infrastructure and technology. The following characteristics are therefore necessary for smart tourism: integrated technological environments, responsive micro- and macrolevel processes, end-user devices, and stakeholders that actively utilise smart digital platforms [3].

The travel and tourism industry is currently undergoing a radical transformation among consumers, which is primarily due to technological advancements [4]. Web 2.0 has placed the tourist between functionality and product distribution [5]. The customer experience is being revolutionised by the usage of mobile devices, megadata, artificial intelligence, and other advanced technology [6]. The link between intelligence and sustainability is expressed at two complementary levels: the destination strategy and the application of technologies for more effective environmental management [7]. These two levels, combined with a new governance framework, create a new approach to managing smart tourism destinations [8].

A wide range of subjects and methodologies have recently supplemented the current research on the interdependence between sustainable development and smart tourism destinations [9,10], but the research is still in its early stages. Future studies could take a look at a few particular directions, such as consumer behaviour and technological advancements, which are obviously related and interconnected, when considering the potential for future research [11].

Smart tourism destinations must adopt sustainable tourism growth, or even more radical alternatives, such as moving towards equilibrium or degrowth situations. The synergistic approach that combines monitoring systems, real-time management, public-private partnerships, and open innovation benefits several aspects of intelligence and sustainability [12]. Smart city initiatives today must address significant social, ecological, and technological concerns, including digitization, pollution, ambitions for democracy, increased security, etc. [13].

The principles of sustainable development can guide the development of smart tourism destinations towards more sustainable outcomes. By prioritizing environmental protection, economic sustainability, social equity, community participation, intergenerational equity, an integrated approach, and the precautionary principle, STDs can be developed in a way that benefits all stakeholders, including local communities, visitors, and the environment. Sustainable development is a long-term process that requires a holistic and integrated approach to decision making, and STDs can play a significant role in achieving the sustainable development goals by promoting sustainable tourism practices and contributing to the well-being of local communities and the environment [9].

As availability and real-time infrastructure are monitored, smart tourism destinations not only solve urban problems and provide residents with a better quality of life [14], but they also allow travellers to discover new attractions, local products, and services at the ideal moment [9].

The development of innovative technologies, especially information and communication technologies, makes it possible to significantly increase the functionalities of destinations. It is necessary to integrate modern technical solutions with the existing infrastructure. The main premise of smart tourism is to make the destination an efficient organism with its tourists by using new technologies and sustainable management [15]. A current assessment

of the existing systematic literature reviews is necessary due to the rapid growth of sustainable smart tourism destinations to provide a solid framework and direction for future study. By outlining the research trend, themes, journals, methodologies, as well as the main contexts of application, the current study seeks to provide an organised, systematic literature review that links smart tourism destinations and sustainable development.

In order to justify the choice of methodology, it is important to emphasise that this study is the first of its kind to analyse systematic literature reviews on smart tourism and its link with sustainable development through a systematic literature review. Therefore, this study is intended as a clear synthesis of completed achievements and avenues for future investigations in this area of research.

The interest of this review paper is to provide elements of answers to our main questions: (1) What are the years of publication of the selected papers? (2) What scientific journals have published papers on studying smart tourism in the context of sustainable development? (3) In which research areas have smart tourism and its link to sustainable development emerged in tourism and hospitality research? (4) Which types of systematic literature review approaches have attracted interest in smart tourism destinations and sustainable development?

This study aims to investigate smart tourism destinations as one of the most significant and cutting-edge strategies for achieving sustainable development. The objective of the current study was attained using the systematic literature review methodology.

To review the applicable literature, the study primarily used theoretical studies related to the subject for the first chapter, which, in turn, supported the results of the study. The second chapter of the study explains the methods that were chosen and used to obtain the results. The third chapter describes the results that the authors obtained through the systematic literature review that was carried out. The discussion chapter is the fourth part of the study, and within it, the authors summarise the results chapter to explore future research directions and implications.

## 2. Materials and Methods

To carry out our systematic literature review, we generally respected the basic protocol of systematic literature reviews [16] through a rigorous framework of the research problem, the primary delimitation of the research, and the definition of the data collection and extraction tools. Indeed, the interest of this review paper is to provide the elements of answers to our main questions: (1) What are the years of publication of the selected papers? (2) What scientific journals have published papers on studying smart tourism in the context of sustainable development? (3) In what research areas have smart tourism and its link to sustainable development emerged in tourism and hospitality research? (4) Which types of systematic literature review approaches have attracted interest in smart tourism destinations and sustainable development? In order to better operationalise this research, we delimited our preliminary field of investigation by setting the criteria for the inclusion and exclusion of references in terms of general information (context, year of publication, etc.), methodological information (theoretical framework, qualitative design, quantitative design, etc.), and documentary information (the nature of the document, languages, etc.). Scopus and Elsevier's databases of citations and abstracts served as the sources for the imported data set for this study. Scopus was used as a research engine in this article over Web of Science (WOS) for these reasons: Scopus is regarded as having the greatest collection of a variety of peer-reviewed literature documents, including books, articles, conference papers, and review papers [17], and many other academics have employed it to perform systematic analyses in their research [18,19]. The search was conducted in English only, using the following keywords: "smart tourism destination"; "sustainable smart tourism"; "sustainable development"; "smart tourism"; "smart city"; "sustainable smart city"; "sustainable destination"; "smart destination"; "sustainability"; "systematic literature review". At the end of this phase, 59 primary studies were sectioned, and finally only 20 were retained for the data extraction stage, after cleaning.

A systematic literature review is a type of research methodology that involves a comprehensive and rigorous examination of the existing literature on a specific topic [20]. The goal of a systematic literature review is to identify, evaluate, and synthesize all the relevant studies on a given topic in order to provide an in-depth understanding of the current state of knowledge [21]. The systematic literature review process typically begins with a clearly defined research question and a set of inclusion and exclusion criteria to examine the papers that meet the expectations [22].

A systematic literature review is the best approach for revealing the current state of tourism research with a focus on the integration of sustainable development in smart tourism destinations [23]. Therefore, it was determined that this would be the optimum methodology for this investigation. This study does not represent the analysis of systematic literature reviews on smart tourism; it only analyses papers on smart tourism destinations with a particular focus on sustainable development that used a systematic literature review research methodology.

To better understand how sustainable development has been included in smart tourism destinations, we conducted a thematic analysis of the data. Our approach to the theme analysis was based on the criteria presented by Thomas and Harden [24]. Our plan was divided into three key phases: (1) initial coding, which involves remaining open to all potential emergent themes suggested by the data readings; (2) focused coding, which involves categorising the data inductively based on the similarity to a specific theme at the level of description [25]; (3) theoretical coding, which involves incorporating thematic categories into fundamental theoretical constructs at a higher level of analysis [26].

### *2.1. Data Selection*

To check the quality of the articles and the relevancy of the information, two rounds of data selection were conducted. In the initial round of selection, we evaluated the articles' contents independently before discussing and removing those that did not relate to sustainable-development-focused smart tourist destinations. For the second phase of selection, only works using a systematic literature review method were considered. After 2 rounds of data gathering and selection, 20 articles on smart tourism destinations linked to sustainable development were finally verified.

### *2.2. Criteria for Exclusion and Inclusion of Manuscripts*

In a systematic literature review (SLR), criteria of inclusion are used to define the parameters for which studies will be included in the review [27]. These criteria are used to ensure that the studies included in the review are relevant to the research question and are of sufficient quality to be included.

The chosen database yielded 59 published papers. A total of 42 articles remained after the duplicate items were eliminated. Seven of these items were removed because of accessibility limitations. The evaluation of the 35 papers that were left was in depth. After being matched to the criteria for choosing literature, another five studies were excluded from the final synthesis. Ten publications were ignored because the research for the studies was focused on smart tourism destinations and sustainable development without truly examining or defining them. As a result, the PRISMA method synthesis contained a total of 20 papers.

In this section, we will discuss the criteria used for both the inclusion and exclusion of manuscripts in our systematic literature review on smart tourism destinations and sustainable development. Our aim was to ensure that we selected the most relevant and rigorous studies for our review while also ensuring that we did not include any studies that did not meet our criteria.

The criteria for the exclusion of manuscripts included the nature of the issues dealt with, the journal in which the paper appears, the scientific rigor, the originality, and the relevance of the subject [16], integrating sustainable development with smart destinations. The inclusion criteria, meanwhile, perfectly met our research objectives: a clearer and more

understandable research methodology, relevant analysis, and the number of citations of the 20 papers selected, as shown in Figure 1.

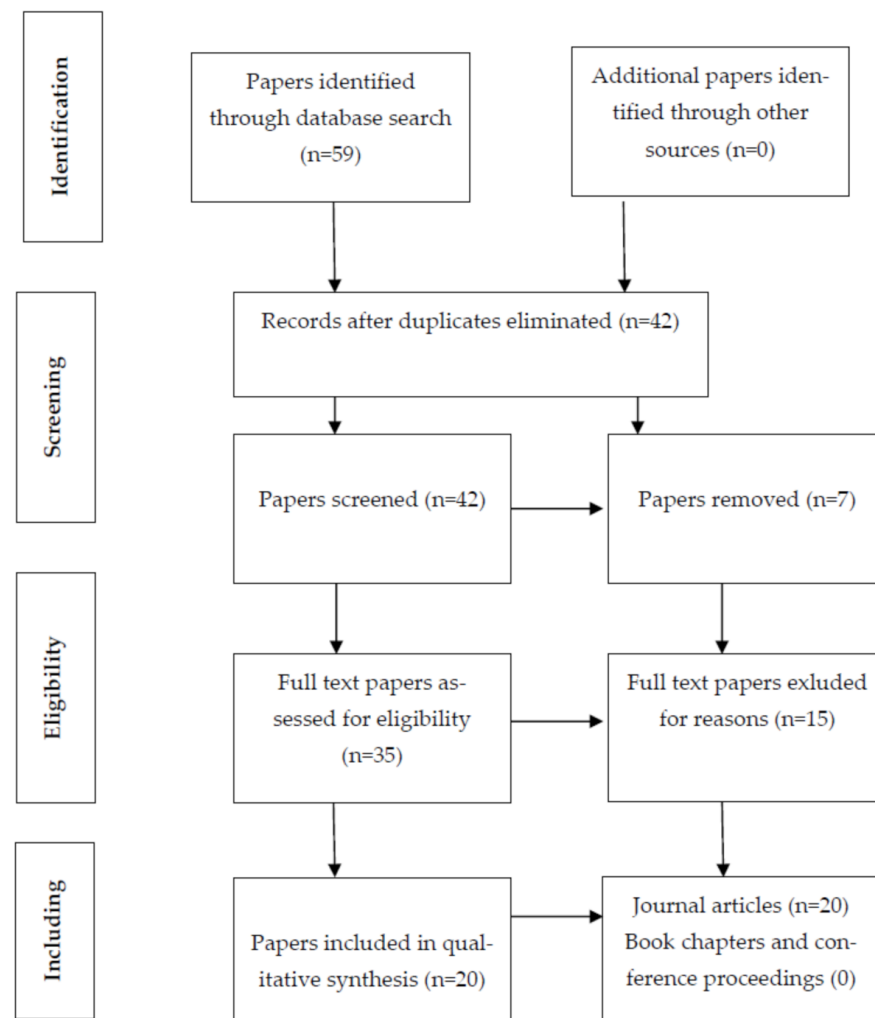

**Figure 1.** PRISMA flow diagram.

### 3. Results

We present the results of each research question's data analysis in this section. We start by listing the publishing dates that are part of the SLR, the journals in which the selected articles were published, the contexts of the sustainable development applications in the reviewed systematic literature on smart tourism destinations as shown in Table 1, and the research methodologies used as illustrated in Table 2.

**Table 1.** Distribution of 20 papers by research area.

Research Area	Number of Studies	Percentage
SDG achievement	5	25.00
The adoption of green IT	5	25.00
Smart energy and waste management	3	15.00
Smart governance	2	10.00
Business ecosystems in destinations	2	10.00
Modelling sustainable smart destinations	2	10.00
The sharing economy	1	5.00

Source: Authors.

**Table 2.** Distribution of 20 papers by methodology.

Methodology	Number of Studies	Percentage
Mixed methods	5	25.00
Qualitative data analysis	5	25.00
Metasynthesis approach	3	12.51
PRISMA method	3	16.68
Semantic network analysis	1	4.17
Scientometric analysis	1	4.17
Integrative review	1	4.17
Critical review	1	4.17

Source: Authors.

To ensure that our review is based on the most current and relevant research, we provide an overview of the publishing dates covered in our study. The studies we included in our review were published between 2017 and 2023 as shown in Table 3, which allowed us to focus on recent research.

**Table 3.** Distribution of 20 papers by theme.

Authors	Dates	Themes
Zheng et al. [28]	2020	From digital to sustainable: a smart city review
Shafiee et al. [10]	2019	Developing a model for sustainable smart tourist destinations
Yigitcanlar et al. [29]	2019	Without being sustainable, can cities become smart?
Kim et al. [30]	2021	Smart energy conservation system and sustainable smart cities
Rodrigues et al. [31]	2022	Improving sustainable development through the digitalization of tourism
Lee et al. [9]	2020	The smart tourism city: changes and developments
Bouzguenda et al. [32]	2019	The role of the digital citizen in social sustainability towards smart sustainable cities
Rahmadian et al. [33]	2022	The use of big data in sustainable tourist destinations
Otowicz et al. [34]	2022	The levels and dimensions of smart tourism
Buhalis et al. [35]	2023	From smart cities and smart tourism to agile business ecosystems in networked destinations
Lim et al. [36]	2019	The outcomes of smart city development
Himeur et al. [37]	2022	Transfer learning in sustainable smart cities
Tomor et al. [38]	2019	Smart governance for sustainable cities
Akande et al. [39]	2020	The sharing economy and its implications for sustainable smart cities
García Revilla et al. [40]	2022	A commitment to technology–sustainability for smart tourism destinations
Trindade et al. [41]	2017	The sustainable development of smart cities
Zhou [42]	2022	Smart cities and sustainable airport energy ecosystems
De Guimarães et al. [43]	2020	Governance and quality of life in smart cities
Esmailian et al. [44]	2018	Waste management in smart and sustainable cities
Branny et al. [45]	2022	Smart green cities

Source: Authors.

By including studies published over the past six years, we were able to capture the latest developments, trends, and perspectives in this field, which is important for making informed conclusions and recommendations.

The annual number of publications published on smart tourism destinations in the context of sustainable development, as illustrated in Figure 2, appeared to be a generally developing trend between 2017 and 2023, reflecting the increasingly extensive attention given to this emerging field of study.

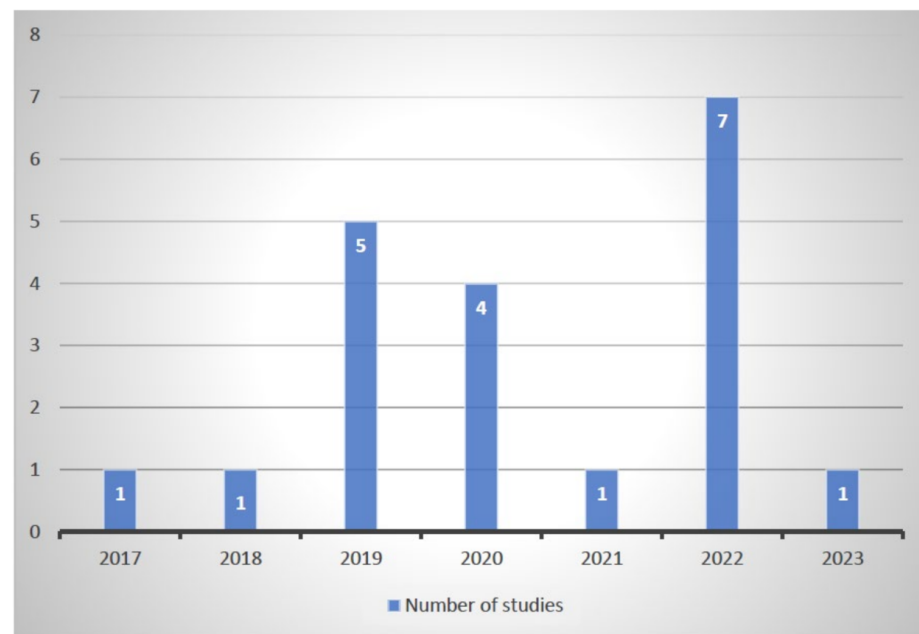

**Figure 2.** Distribution of papers by year.

The 20 papers on smart tourism destinations and smart cities in the context of sustainable development that were published in 15 indexed journals are shown in Table 4 as a summary. Almost all the studies selected were from journals with high-impact factors to meet our inclusion criteria, and *Journal of Cleaner Production* and *Sustainable Cities and Society* are the first journals in terms of the scientific production of systematic literature reviews on smart tourism/smart cities in the sustainable development context.

**Table 4.** Distribution of 20 papers by journal.

Journals	Number of Studies	Percentage
<i>Sustainable Cities and Society</i>	3	15.00
<i>Journal of Cleaner Production</i>	3	15.00
<i>Sustainability</i>	2	10.00
<i>Current Issues in Tourism</i>	1	5.00
<i>Journal of Smart Tourism</i>	1	5.00
<i>Tourism Management Perspectives</i>	1	5.00
<i>Information Technology &amp; Tourism</i>	1	5.00
<i>International Journal of Contemporary Hospitality Management</i>	1	5.00
<i>Cities</i>	1	5.00
<i>Waste Management</i>	1	5.00
<i>Journal of Urban Technology</i>	1	5.00
<i>Journal of Open Innovation: Technology, Market, and Complexity</i>	1	5.00
<i>Energy Reviews</i>	1	5.00
<i>Renewable and Sustainable Energy Reviews</i>	1	5.00
<i>Current Opinion in Environmental Sustainability</i>	1	5.00

Source: Authors.

A total of 3 papers out of 20 were published in the journal *Sustainable Cities and Society*, a Q1-indexed journal on Scopus. Three papers issued from the *Journal of Cleaner Production*, and two other manuscripts were published in *Sustainability*. The remaining papers were published in prestigious journals that deal with tourism- and hospitality-related topics.

The results indicate that the majority of the studies in this review were published in journals with a focus on sustainability and the environment, such as *Sustainable Cities and Society* and *Journal of Cleaner Production*. This suggests that the topic of smart tourism destinations is closely linked to sustainable development and environmental management.

The sustainable development goals and the adoption of green IT emerged as the most prevalent research areas on smart tourism destinations and smart cities in the sustainable development context (25%), followed by smart energy and waste management (15%). Several papers focused on smart governance, business ecosystems in destinations, and modelling sustainable smart destinations (10%).

The research methodologies followed in almost half of the treated manuscripts were based on qualitative data analysis and mixed methods (50%). Four papers opted for the PRISMA method, four were conducted using mixed methods, and three other studies were based on the metasyntesis approach.

The word cloud provided in Figure 3 shows that the most frequent terms appear as larger and more prominent, while the less frequent terms appear smaller. The word cloud is centred around the most frequently mentioned terms, which are “smart tourism”, “sustainability”, and “sustainable development”, each with a frequency of 11 or more.



**Figure 3.** Word cloud derived from R programming language (biblioshiny: web interface of the bibliometrix package).

Other terms that appear prominently in the word cloud include “smart city”, “sustainable tourism”, “smart destination”, and “smart tourism destination”, each with a frequency of six or more. Additionally, terms such as “COVID-19”, “big data analytics”, and “social network analysis” are smaller and less prominent in the word cloud, as they have lower frequencies (three or less).

The word cloud visually represents the most important and frequently mentioned terms related to tourism, with a focus on the concepts of smart and sustainable tourism and the intersection of technology and sustainability.

After conducting a systematic literature review of the 20 papers dealing with smart tourism destinations in the context of sustainable development, several key themes emerged. First, there is a consensus among the authors that smart tourism destination development has the potential to significantly contribute to the sustainable development goals [9,41,45]. Second, a sustainable approach is essential to the success of smart tourism destination development, and digitalization and the use of big data are crucial tools for achieving sustainable development [31–33]. Third, stakeholder involvement is crucial to ensure social and environmental sustainability, and waste management, energy conservation, and governance are important areas for sustainable development [3]. Fourth, a holistic approach is necessary that considers social, economic, and environmental sustainability, and the sharing economy and agile business ecosystems may also play significant roles [35,39]. Finally, there is a need for further research to fully understand the concept of sustainable smart tourism destination development and its practical implications. This systematic

literature review highlights the importance of considering sustainability as an integral part of smart tourism destination development.

#### 4. Discussion

Research on smart tourism destinations within the context of sustainable development has evolved over time to reflect changes in technology and the increasing importance of sustainability in the tourism industry.

Our findings indicate that there was a general growing trend in the annual numbers of papers published on smart tourism destinations in the context of sustainable development between 2017 and 2023, indicating the increased global attention to this emerging research. Recently, several systematic literature reviews have been completed, focusing only on smart tourism or sustainable tourism, but little research has focused on smart tourism destinations in a sustainability context.

*Journal of Cleaner Production*, *Sustainable Cities and Society*, and *Sustainability* were the first journals in terms of the scientific production of systematic literature reviews on smart tourism in the context of sustainable development, and almost all of the studies chosen were from journals with high-impact factors to meet our inclusion criteria. There are few publications in tourism and hospitality journals in this research area.

The review of the literature on smart tourism destinations in a sustainable development context has revealed that there is growing interest in this emerging research area, with a focus on achieving the sustainable development goals [9,41,45] and the adoption of green IT [31,33,40]. This has been achieved through the implementation of various smart city technologies and strategies, such as the use of big data and digital solutions to optimise resource use and enhance the overall sustainability of destinations.

The findings suggest that smart tourism destinations can play a significant role in promoting sustainable development and improving the quality of life [46] for both residents and visitors [32]. The implementation of smart city technologies and strategies can help to reduce waste and improve energy efficiency [30,42,44], thereby reducing the negative impacts of tourism on the environment and local communities [47].

Another important aspect that has evolved in the research on smart tourism is the focus on the governance of smart tourism destinations [8,43]. Research has been conducted to understand the role of governance in implementing smart solutions, as well as its role in ensuring that smart tourism is aligned with the principles of sustainable development.

The research conducted on smart cities is much more important than the studies on smart destinations [48]. The creation of smart cities has also been seen as a prerequisite for the establishment of smart tourism destinations [3,49]. The principles of smart cities are also accepted and debated in relation to smart tourism destinations [3]. Smart cities and sustainable development are two concepts that go hand in hand. The principles of smart cities related to sustainable development focus on promoting the efficient use of resources, protecting the environment, and enhancing the quality of life for citizens. Smart cities aim to create sustainable and resilient urban environments that support economic growth, social progress, and environmental protection [50]. A recent study has shown that many smart tourism efforts were created out of smart city projects [51]. When these smart city principles are examined through the prism of various definitions, it becomes clear that the use of the word “smart” in connection with the concepts of governance, the environment, mobility, the economy, people, and living is an example of vagueness (i.e., there is a lack of clarity regarding this concept in the tourism literature) [52].

Studies on smart tourism destinations in the context of sustainable development have yielded several key insights and results, including: (1) the importance of ICTs and an emphasis on the critical role of information and communication technologies (ICTs) in developing smart tourism destinations [53]; (2) the importance of stakeholder collaboration between various actors in the success of smart tourism destinations, including government, local communities, and tourism businesses [35,54]; (3) studies have shown that smart tourism destinations can increase the economic benefits for local communities [55] through



job creation and increased tourist spending [39,56]; (4) the use of technology can help reduce the negative environmental impacts of tourism through, for example, better waste management and energy efficiency [30,44,57]; (5) smart tourism destinations can contribute to the social sustainability of local communities by, for example, involving local residents in tourism planning and decision making [58].

Because our research solely focuses on systematic literature reviews, mixed-method studies and analyses of qualitative data predominated among the papers we examined. These have been the techniques used most frequently in research, using both comprehensive reviews and the meta-analysis methods. Semantic network analyses, scientometric analyses, integrative reviews, and critical reviews are all significantly present in the investigations. The most popular diagram approach is the Prisma flow. All of the evaluated studies employed systematic methods for conducting literature reviews as part of their study approaches. In this regard, our SLR demonstrates that theoretical techniques are still being used in research on smart tourism destinations in the context of sustainable development.

This review reveals that there is still much to be learned about the development of smart tourism destinations in a sustainable development context. Future research should focus on exploring the potentials of new and emerging technologies and strategies, such as artificial intelligence and the Internet of Things [59], to further optimise resource use and enhance the sustainability and resilience of smart tourism destinations [60]. In addition, more research is needed to better understand the social and cultural impacts of these technologies and strategies, as well as their potentials to create equitable and inclusive destinations for all [61].

A research agenda for smart tourism destinations in the context of sustainable development involves several key areas of investigation. These include the following: (1) the role of smart tourism in promoting sustainable tourism practices in order to examine how the use of digital technologies, such as mobile apps and social media, can be used to promote them, such as reducing carbon emissions, protecting natural resources, and supporting local communities; (2) the use of data analytics in monitoring and evaluating the environmental impacts of tourism to explore how data analytics can be used to do so, and how this information can be used to improve the sustainability of tourism operations; (3) the role of stakeholder collaboration in promoting sustainable smart tourism to examine the ways in which different stakeholders, such as tourism providers, local authorities, and environmental organizations, can work together to create and implement sustainable smart tourism initiatives, taking into account accessibility [62]; (4) the use of technology in promoting sustainable behaviours among tourists to focus on how smart tourism technologies, such as mobile apps, can be used to promote sustainable behaviours among tourists, such as reducing energy consumption and water usage [63]; (5) the relationship between smart tourism and biodiversity conservation to look into how smart tourism can be used to enhance biodiversity conservation and support the sustainable development goals; (6) research on smart tourism and the circular economy, which will investigate how smart technologies can support the implementation of circular economy principles in the tourism sector, including reducing waste, reusing resources, and promoting sustainable consumption; (7) smart tourism in the context of natural disasters and climate change in order to analyse how smart technologies can help destinations to better prepare for, respond to, and recover from their impacts; (8) the contribution of smart destinations to social inclusion through the leveraging of technology and innovation to create more accessible, equitable, and inclusive tourism experiences; (9) cultural heritage preservation and its implications for smart destinations, which can be achieved by digitizing and preserving local cultural heritages, such as ancient monuments, artifacts, and artworks.

The research agenda for smart tourism destinations in the context of sustainable development should focus on understanding how smart technologies can be leveraged to create more sustainable and responsible tourism experiences while minimizing the negative impacts of tourism on the environment and communities.

## 5. Conclusions and Implications

Since the development of digital technologies and their adoption in tourism and hospitality research, there has been an increase in the body of literature on smart tourism destinations. The purpose of this paper was to identify and analyse 20 related papers on smart tourism destinations in the context of sustainable development through a systematic literature review. These data sets were taken from the Scopus database for the years 2017–2023, and they were examined using a variety of systematic approaches: including and excluding criteria, database-selected methods, and qualitative data analysis. This work focused on identifying the overall concept of performing systematic reviews in order to precisely examine sets of various systematic literature reviews, including their years of publication, research topics, journals, and methodologies.

The results of the STD systematic literature study were highly comprehensive and included many essential themes in numerous fields. Additionally, the field has grown considerably in recent years, and this trend is anticipated to continue. This is in addition to the fact that several journals are engaged in publishing STD papers, which reflects the variety of topics covered in relation to STDs and demonstrates the significance of its different economic sectors.

The relevance of integrating technology and sustainability into tourist destinations is shown by the comprehensive literature studies on smart tourism destinations and sustainable development. The evaluation has demonstrated the need for more studies in this field, and notably in the creation of innovative and more efficient strategies for promoting sustainable tourism practices. The results of this review have significant repercussions for stakeholders, practitioners, and policymakers in the tourism sector and serve as a foundation for future research paths. It is intended that the knowledge gathered from this systematic literature review will advance this field of study and aid in the creation of more environmentally friendly tourist destinations.

Our results show that, between 2017 and 2023, there was a general increase in the number of papers published annually on smart tourism destinations in the context of sustainable development, showing greater worldwide interest in this developing research. There have been a number of systematic literature reviews recently that have concentrated exclusively on smart tourism or sustainable tourism [64], but there are few studies on smart tourism destinations in the context of sustainability.

*Journal of Cleaner Production*, *Sustainable Cities and Society*, and *Sustainability* are the pioneer journals in terms of the scientific production of systematic literature reviews on smart tourism in the context of sustainable development. Nearly all of the studies selected were from journals with high-impact factors to meet our inclusion criteria.

Mixed-method studies and qualitative data analyses prevailed among the publications we examined, while our study is restricted to systematic literature reviews.

With a focus on achieving the sustainable development goals [65] and the adoption of green IT [66], the assessment of the literature on smart tourist destinations in a sustainable development framework showed that there is significant interest in this new research subject. This was accomplished by putting into practise a number of smart city technologies and techniques, including the use of big data and digital tools, to optimise resource consumption and improve an area's general sustainability.

The emphasis on destination governance is another significant development in the field of smart tourism research. Research has been conducted to comprehend the function of governance in putting smart solutions into practice, as well as the function of governance in making sure that smart tourism adheres to the principles of sustainable development.

Overall, the literature suggests that smart tourism has the potential to improve the sustainability of tourism, but it is important to address the potential negative impacts and ensure that the technology is used in a responsible and equitable way.

This paper provides a research agenda for smart tourism destinations in the context of sustainable development that should focus on understanding how smart technologies

can be leveraged to create more sustainable and responsible tourism experiences while minimizing the negative impacts of tourism on the environment and communities.

As only one language from the chosen manuscripts was used in the current work, it is recommended that more languages be used in future studies to strengthen the findings. It is also suggested that this research be continued in order to confirm the development and appearance of new themes associated with the concerned keywords.

**Author Contributions:** Conceptualization, Y.E.A. and L.D.D.; methodology, Y.E.A.; software, B.B.; validation, L.D.D., Y.E.A. and B.B.; formal analysis, L.D.D.; investigation, Y.E.A.; resources, Z.N.; data curation, Y.I.; writing—original draft preparation, Y.E.A.; writing—review and editing, L.D.D.; visualization, G.I.V.; supervision, L.D.D.; funding acquisition, Y.E.A. All authors have read and agreed to the published version of the manuscript.

**Funding:** This research received no external funding.

**Institutional Review Board Statement:** Not applicable.

**Informed Consent Statement:** Not applicable.

**Data Availability Statement:** The data presented in this study are available on request from the corresponding author.

**Conflicts of Interest:** The authors declare no conflict of interest.

## References

- Ye, B.H.; Ye, H.; Law, R. Systematic Review of Smart Tourism Research. *Sustainability* **2020**, *12*, 3401. [CrossRef]
- Gretzel, U.; Zhong, L.; Koo, C. Application of smart tourism to cities. *Int. J. Tour. Cities* **2016**, *2*. [CrossRef]
- Buhalis, D.; Amaranggana, A. Smart Tourism Destinations. In *Information and Communication Technologies in Tourism 2014*; Springer: Cham, Switzerland, 2013; pp. 553–564. [CrossRef]
- Buhalis, D. Technology in tourism—from information communication technologies to eTourism and smart tourism towards ambient intelligence tourism: A perspective article. *Tour. Rev.* **2019**, *75*, 267–272. [CrossRef]
- Noti, E. Web 2.0 and its influence in the tourism sector. *Eur. Sci. J.* **2013**, *9*, 115–123.
- Morrison, A.M. *Marketing and Managing Tourism Destinations*; Routledge: London, UK, 2013. [CrossRef]
- Neirotti, P.; De Marco, A.; Cagliano, A.C.; Mangano, G.; Scorrano, F. Current trends in Smart City initiatives: Some stylised facts. *Cities* **2014**, *38*, 25–36. [CrossRef]
- Ivars-Baidal, J.A.; Celdrán-Bernabeu, M.A.; Mazón, J.-N.; Perles-Ivars, F. Smart destinations and the evolution of ICTs: A new scenario for destination management? *Curr. Issues Tour.* **2019**, *22*, 1581–1600. [CrossRef]
- Lee, P.; Hunter, W.C.; Chung, N. Smart Tourism City: Developments and Transformations. *Sustainability* **2020**, *12*, 3958. [CrossRef]
- Shafiee, S.; Ghatari, A.R.; Hasanzadeh, A.; Jahanyan, S. Developing a model for sustainable smart tourism destinations: A systematic review. *Tour. Manag. Perspect.* **2019**, *31*, 287–300. [CrossRef]
- Sotiriadis, M.D. Sharing tourism experiences in social media: A literature review and a set of suggested business strategies. *Int. J. Contemp. Hosp. Manag.* **2017**, *29*, 179–225. [CrossRef]
- Ribes, J.F.P.; Baidal, J.I. Smart sustainability: A new perspective in the sustainable tourism debate. *Investig. Reg. J. Reg. Res.* **2018**, *42*, 151–170.
- Hoang, G.T.T.; Dupont, L.; Camargo, M. Application of Decision-Making Methods in Smart City Projects: A Systematic Literature Review. *Smart Cities* **2019**, *2*, 27. [CrossRef]
- Wang, D.; Li, X.; Li, Y. China's "smart tourism destination" initiative: A taste of the service-dominant logic. *J. Destin. Mark. Manag.* **2013**, *2*, 59–61. [CrossRef]
- Gretzel, U.; Werthner, H.; Koo, C.; Lamsfus, C. Conceptual foundations for understanding smart tourism ecosystems. *Comput. Hum. Behav.* **2015**, *50*, 558–563. [CrossRef]
- Xiao, Y.; Watson, M. Guidance on Conducting a Systematic Literature Review. *J. Plan. Educ. Res.* **2019**, *39*, 93–112. [CrossRef]
- Salisbury, L. Web of Science and Scopus: A Comparative Review of Content and Searching Capabilities. *Charlest. Advis.* **2009**, *11*, 5–18.
- Schimperna, F.; Lombardi, R.; Belyaeva, Z. Technological transformation, culinary tourism and stakeholder engagement: Emerging trends from a systematic literature review. *J. Place Manag. Dev.* **2020**, *14*, 66–80. [CrossRef]
- Park, J.; Jeong, E. Service Quality in Tourism: A Systematic Literature Review and Keyword Network Analysis. *Sustainability* **2019**, *11*, 3665. [CrossRef]
- Popay, J.; Roberts, H.; Sowden, A.; Petticrew, M.; Arai, L.; Rodgers, M.; Duffy, S. *Guidance on the Conduct of Narrative Synthesis in Systematic Reviews*; Institute for Health Research: London, UK, 2006.
- Fisch, C.; Block, J. Six tips for your (systematic) literature review in business and management research. *Manag. Rev. Q.* **2018**, *68*, 103–106. [CrossRef]

22. Alexander, P.A. Methodological Guidance Paper: The Art and Science of Quality—Systematic Reviews. *Rev. Educ. Res.* **2020**, *90*, 6–23. [CrossRef]
23. Booth, A.; Sutton, A.; Clowes, M.; James, M.M.-S. *Systematic Approaches to a Successful Literature Review*; SAGE: Thousand Oaks, CA, USA, 2021.
24. Thomas, J.; Harden, A. Methods for the thematic synthesis of qualitative research in systematic reviews. *BMC Med. Res. Methodol.* **2008**, *8*, 45. [CrossRef]
25. Charmaz, K. *Constructing Grounded Theory: A Practical Guide through Qualitative Analysis*; SAGE: Thousand Oaks, CA, USA, 2006.
26. Saldana, J. The Coding Manual for Qualitative Researchers. In *The Coding Manual for Qualitative Researchers*; SAGE: Thousand Oaks, CA, USA, 2021; 440p.
27. Okoli, C.; Schabram, K. A Guide to Conducting a Systematic Literature Review of Information Systems Research. *Soc. Sci. Res. Netw.* **2010**, *10*. [CrossRef]
28. Zheng, C.; Yuan, J.; Zhu, L.; Zhang, Y.; Shao, Q. From digital to sustainable: A scientometric review of smart city literature between 1990 and 2019. *J. Clean. Prod.* **2020**, *258*, 120689. [CrossRef]
29. Yigitcanlar, T.; Kamruzzaman, M.; Foth, M.; Sabatini-Marques, J.; Da-Costa, E.; Ioppolo, G. Can cities become smart without being sustainable? A systematic review of the literature. *Sustain. Cities Soc.* **2019**, *45*, 348–365. [CrossRef]
30. Kim, H.; Choi, H.; Kang, H.; An, J.; Yeom, S.; Hong, T. A systematic review of the smart energy conservation system: From smart homes to sustainable smart cities. *Renew. Sustain. Energy Rev.* **2021**, *140*, 110755. [CrossRef]
31. Rodrigues, V.; Eusébio, C.; Breda, Z. Enhancing sustainable development through tourism digitalisation: A systematic literature review. *Inf. Technol. Tour.* **2022**, 1–33. [CrossRef]
32. Bouzguenda, I.; Alalouch, C.; Fava, N. Towards smart sustainable cities: A review of the role digital citizen participation could play in advancing social sustainability. *Sustain. Cities Soc.* **2019**, *50*, 101627. [CrossRef]
33. Rahmadian, E.; Feitosa, D.; Zwitter, A. A systematic literature review on the use of big data for sustainable tourism. *Curr. Issues Tour.* **2022**, *25*, 1711–1730. [CrossRef]
34. Otowicz, M.H.; Macedo, M.; Biz, A.A. Dimensions of Smart Tourism and Its Levels: An Integrative Literature Review. *J. Smart Tour.* **2022**, *2*, 5–19. [CrossRef]
35. Buhalis, D.; O'Connor, P.; Leung, R. Smart hospitality: From smart cities and smart tourism towards agile business ecosystems in networked destinations. *Int. J. Contemp. Hosp. Manag.* **2022**, *35*, 369–393. [CrossRef]
36. Lim, Y.; Edelenbos, J.; Gianoli, A. Identifying the results of smart city development: Findings from systematic literature review. *Cities* **2019**, *95*, 102397. [CrossRef]
37. Himeur, Y.; Elnour, M.; Fadli, F.; Meskin, N.; Petri, I.; Rezgui, Y.; Bensaali, F.; Amira, A. Next-generation energy systems for sustainable smart cities: Roles of transfer learning. *Sustain. Cities Soc.* **2022**, *85*, 104059. [CrossRef]
38. Tomor, Z.; Meijer, A.; Michels, A.; Geertman, S. Smart Governance for Sustainable Cities: Findings from a Systematic Literature Review. *J. Urban Technol.* **2019**, *26*, 3–27. [CrossRef]
39. Akande, A.; Cabral, P.; Casteleyn, S. Understanding the sharing economy and its implication on sustainability in smart cities. *J. Clean. Prod.* **2020**, *277*, 124077. [CrossRef]
40. Revilla, M.R.G.; Burgos, J.P.; Einsle, C.S.; Moure, O.M. Proposal of New Strategies for Smart Tourism Destinations in the Challenging New Reality: A Commitment to the Technology–Sustainability Binomial. *Sustainability* **2022**, *14*, 5867. [CrossRef]
41. Trindade, E.P.; Hinnig, M.P.F.; Da Costa, E.M.; Marques, J.S.; Bastos, R.C.; Yigitcanlar, T. Sustainable development of smart cities: A systematic review of the literature. *J. Open Innov. Technol. Mark. Complex.* **2017**, *3*, 1–14. [CrossRef]
42. Zhou, Y. Low-carbon transition in smart city with sustainable airport energy ecosystems and hydrogen-based renewable-grid-storage-flexibility. *Energy Rev.* **2022**, *1*, 100001. [CrossRef]
43. De Guimarães, J.C.F.; Severo, E.A.; Júnior, L.A.F.; Da Costa, W.P.L.B.; Salmoria, F.T. Governance and quality of life in smart cities: Towards sustainable development goals. *J. Clean. Prod.* **2020**, *253*, 119926. [CrossRef]
44. Esmaeilian, B.; Wang, B.; Lewis, K.; Duarte, F.; Ratti, C.; Behdad, S. The future of waste management in smart and sustainable cities: A review and concept paper. *Waste Manag.* **2018**, *81*, 177–195. [CrossRef]
45. Branny, A.; Møller, M.S.; Korpilo, S.; McPhearson, T.; Gulrud, N.; Olafsson, A.S.; Raymond, C.M.; Andersson, E. Smarter greener cities through a social-ecological-technological systems approach. *Curr. Opin. Environ. Sustain.* **2022**, *55*, 101168. [CrossRef]
46. Manhas, P.S.; Singh, R.; Fodor, G.; Berghauer, S.; Mir, M.A.; Dávid, L.D. Examination of Impact of Responsible Tourism Practices on Quality of Life of Destination Communities. *Geoj. Tour. Geosites* **2021**, *36*, 688–697. [CrossRef]
47. Priatmoko, S.; Kabil, M.; Purwoko, Y.; Dávid, L. Rethinking Sustainable Community-Based Tourism: A Villager's Point of View and Case Study in Pampang Village, Indonesia. *Sustainability* **2021**, *13*, 3245. [CrossRef]
48. Williams, A.M.; Rodriguez, I.; Makkonen, T. Innovation and smart destinations: Critical insights. *Ann. Tour. Res.* **2020**, *83*, 102930. [CrossRef]
49. Xiang, Z.; Tussyadiah, I.; Buhalis, D. Smart destinations: Foundations, analytics, and applications. *J. Destin. Mark. Manag.* **2015**, *3*, 143–144. [CrossRef]
50. De Jong, M.; Joss, S.; Schraven, D.; Zhan, C.; Weijnen, M. Sustainable–smart–resilient–low carbon–eco–knowledge cities; making sense of a multitude of concepts promoting sustainable urbanization. *J. Clean. Prod.* **2015**, *109*, 25–38. [CrossRef]
51. Gretzel, U.; Sigala, M.; Xiang, Z.; Koo, C. Smart tourism: Foundations and developments. *Electron. Mark.* **2015**, *25*, 179–188. [CrossRef]

52. Govier, T. *A Practical Study of Argument, Enhanced Edition*; Cengage Learning: Boston, MA, USA, 2013.
53. Rafael, C. Analysis of Scientific Production- Smart Tourism Destination, Technology and Sustainability. In *Advances in Tourism, Technology and Smart Systems*; Springer: Singapore, 2020; pp. 599–613. [CrossRef]
54. Gretzel, U.; Scarpino-Johns, M. Destination Resilience and Smart Tourism Destinations. *Tour. Rev. Int.* **2018**, *22*, 263–276. [CrossRef]
55. Kabil, M.; Alayan, R.; Lakner, Z.; Dávid, L.D. Enhancing Regional Tourism Development in the Protected Areas Using the Total Economic Value Approach. *Forests* **2022**, *13*, 727. [CrossRef]
56. Cavalheiro, M.B.; Joia, L.A.; Cavalheiro, G.M.D.C. Towards a Smart Tourism Destination Development Model: Promoting Environmental, Economic, Socio-cultural and Political Values. *Tour. Plan. Dev.* **2020**, *17*, 237–259. [CrossRef]
57. Nižetić, S.; Djilali, N.; Papadopoulos, A.; Rodrigues, J.J. Smart technologies for promotion of energy efficiency, utilization of sustainable resources and waste management. *J. Clean. Prod.* **2019**, *231*, 565–591. [CrossRef]
58. González-Reverté, F. Building Sustainable Smart Destinations: An Approach Based on the Development of Spanish Smart Tourism Plans. *Sustainability* **2019**, *11*, 6874. [CrossRef]
59. Tiwari, S.; Rosak-Szyrocka, J.; Żywiołek, J. Internet of Things as a Sustainable Energy Management Solution at Tourism Destinations in India. *Energies* **2022**, *15*, 2433. [CrossRef]
60. Coca-Stefaniak, J.A. Marketing smart tourism cities—A strategic dilemma. *Int. J. Tour. Cities* **2019**, *5*, 513–518. [CrossRef]
61. Allam, Z.; Sharifi, A.; Bibri, S.E.; Jones, D.S.; Krogstie, J. The Metaverse as a Virtual Form of Smart Cities: Opportunities and Challenges for Environmental, Economic, and Social Sustainability in Urban Futures. *Smart Cities* **2022**, *5*, 40. [CrossRef]
62. Farkas, J.; Raffay, Z.; Dávid, L.D. Fundamental Accessibility and Technical Accessibility in Travels—The Encounter of Two Worlds Which Leads to a Paradigm Shift. *Sustainability* **2022**, *14*, 3765. [CrossRef]
63. Wicaksono, T.; Illes, C.B. Investigating priority service attribute for online travel agencies (OTA) mobile app development using AHP framework. *J. Tour. Econ.* **2022**, *5*, 120–129. [CrossRef]
64. Mehraliyev, F.; Choi, Y.; Köseoglu, M.A. Progress on smart tourism research. *J. Hosp. Tour. Technol.* **2019**, *10*, 522–538. [CrossRef]
65. Gretzel, U.; Koo, C. Smart tourism cities: A duality of place where technology supports the convergence of touristic and residential experiences. *Asia Pac. J. Tour. Res.* **2021**, *26*, 352–364. [CrossRef]
66. Satta, G.; Spinelli, R.; Parola, F. Is Tourism Going Green? A Literature Review on Green Innovation for Sustainable Tourism. *Tour. Anal.* **2019**, *24*, 265–280. [CrossRef]

**Disclaimer/Publisher’s Note:** The statements, opinions and data contained in all publications are solely those of the individual author(s) and contributor(s) and not of MDPI and/or the editor(s). MDPI and/or the editor(s) disclaim responsibility for any injury to people or property resulting from any ideas, methods, instructions or products referred to in the content.

## Article

# Smartphones as a Platform for Tourism Management Dynamics during Pandemics: A Case Study of the Shiraz Metropolis, Iran

Hadigheh Morabi Jouybari <sup>1</sup>, Amir Ghorbani <sup>2</sup> , Hossein Mousazadeh <sup>3,\*</sup> , Azadeh Golafshan <sup>4</sup> ,  
Farahnaz Akbarzadeh Almani <sup>5</sup>, Dávid Lóránt Dénes <sup>6,7,\*</sup>  and Ritter Krisztián <sup>6</sup> 

- <sup>1</sup> Department of Regional Economics and Rural Development, Hungarian University of Agriculture and Life Sciences, 2100 Gödöllő, Hungary
- <sup>2</sup> Department of Tourism, Faculty of Geographical Sciences and Planning, University of Isfahan, Isfahan 81746-73441, Iran
- <sup>3</sup> Department of Regional Science, Faculty of Science, Eötvös Loránd University, 1053 Budapest, Hungary
- <sup>4</sup> Department of Communication and Journalism, College of Arts and Social Sciences, Osmania University, Hyderabad 500007, India
- <sup>5</sup> Department of Tourism Management, Budapest Business School, University of Applied Sciences, 1149 Budapest, Hungary
- <sup>6</sup> Institute for Rural Development and Sustainable Economy, Department for Rural and Regional Development, MATE Szent István Campus, Hungarian University of Agriculture and Life Sciences, 2100 Gödöllő, Hungary
- <sup>7</sup> Faculty of Economics and Business, John von Neumann University, 6000 Kecskemét, Hungary
- \* Correspondence: hmosazadeh5575@yahoo.com (H.M.); dr.david.lorant@gmail.com (D.L.D.); Tel.: +36-204359609 (H.M.); +36-0209722833 (D.L.D.)

**Abstract:** During the past three years and with the spread of the pandemic, smartphones were the most important communication bridge between tourists and organizations; now more than ever, they are intertwined with the lives of tourists and destination management organizations. Although much research has been conducted in this field, the investigation of the effects of the pandemic on the technology and functionality of smartphones is one of the topics that has been less discussed. Therefore, the current research was conducted to determine the role of smartphones in tourism management dynamics during the pandemic. The research method was qualitative (content analysis, theme analysis), and 32 people participated in the interview process as a statistical sample. Then, the oral interviews were transcribed, and a thematic analysis was performed. For the analysis of the interviews, MAXQDA 2020 software was used. The results of the research indicate that smartphones were one of the most important platforms for tourism management dynamics during the pandemic, and in the event of a pandemic in the future, they can help contain the destruction to a great extent in their current position.

**Keywords:** destination management organizations; tourism technology; content analysis; thematic analysis



**Citation:** Morabi Jouybari, H.; Ghorbani, A.; Mousazadeh, H.; Golafshan, A.; Akbarzadeh Almani, F.; Dénes, D.L.; Krisztián, R. Smartphones as a Platform for Tourism Management Dynamics during Pandemics: A Case Study of the Shiraz Metropolis, Iran. *Sustainability* **2023**, *15*, 4051. <https://doi.org/10.3390/su15054051>

Academic Editors: Zygmunt Kruczek and Bartłomiej Walas

Received: 27 December 2022

Revised: 17 February 2023

Accepted: 20 February 2023

Published: 23 February 2023



**Copyright:** © 2023 by the authors. Licensee MDPI, Basel, Switzerland. This article is an open access article distributed under the terms and conditions of the Creative Commons Attribution (CC BY) license (<https://creativecommons.org/licenses/by/4.0/>).

## 1. Introduction

The experience of the COVID-19 pandemic and its effects on the tourism industry have caused an indisputable shift in the structure of tourism management [1]. It could be argued that the most salient consequence of this pandemic over the past three years has been the lack of dynamism in the tourism management structure to face such unprecedented conditions [2]. However, the development of smart tourism may reduce the tourism sector's vulnerability to unexpected environmental threats [3]. During the pandemic, smartphones have become the focus of attention for tourists and destination organizations more than ever before [4]. While the use of smartphones in tourism management is not a novel concept, its changes brought by the pandemic era certainly warrant further exploration [5]. Due to the newly discovered and highly infectious COVID-19 variants, mainly unvaccinated groups and unequal tourism rises across locations can hamper vaccination prospects [6].

While tourism looks to be on the mend, the expansion of such new variants might stop it [7]. Currently, there are signs of a drop in the flow of tourism due to the reemergence of the COVID pandemic in Japan and the USA [8]. Now, smartphones are more integrated with the structure of tourism and the lives of tourists than before the pandemic, and it can almost be said that they have become a part of the lives of tourists and destination organizations [9]. As a consequence, communities and locations can be linked virtually with the help of new communication devices and applications [10]. As these phones are connected to social media throughout the world, they provide a chance for tourists and destination management organizations to disseminate their information to other users [11]. During the COVID-19 pandemic, with the tightening of restrictions, more tourists used smartphones and various applications and social channels. Smartphones even completely replaced physical travel, and the number of followers of travel bloggers increased greatly [12]. Tourists confined at home published the data of their past trips or used travel blogs as a tool for planning and choosing a destination. Therefore, smartphones have been utilized as a “psychological management tool”. Additionally, as a planning tool for the new tourism platform or postmodern tourism era, it can be referred to as a “behavioral management tool”. To do so, travel executives and specialists can apply new strategies to design new travel structures, such as single-tourist travel with long-distance privacy; hence, fewer travels with fewer travelers can protect nature and, as a result, develop sustainable tourism [13]. Therefore, the current research was conducted to focus on the functions of smartphones in tourism management during the pandemic. Although the use of smartphones in the tourism industry is not a new issue, the most important novel aspect of the current research is the investigation of the effect of the pandemic on the functioning of smartphones during the pandemic. Smartphones were not seriously used in tourism in countries such as Iran before the pandemic. Shiraz metropolis is one of the most important destinations for medical tourism, including cosmetic surgery and hair transplant tourism in the Middle East. Tourists who travel to Shiraz for laser cosmetic surgeries and hair transplants benefit from hotel and tour services. Many taxi drivers and tourism service personnel in Shiraz are fluent in English and communicate well with tourists at airports and passenger terminals [14]. In addition, due to the active cycle of tourism economics and the focus of medical tourism operators in the Shiraz metropolis on smartphones as a means of communication with tourists, this city was selected as the research area. On the other hand, Shiraz tourism officials intend to design tourism in the Shiraz metropolis based on smartphones soon.

Although the perpetual vital role of smartphones in tourism management is undeniable [12]; an overwhelming number of studies have been conducted to examine the impact of the pandemic on tourism [15], but few studies have studied the pandemic’s impact on tourism technological behaviors. In an attempt to bridge this gap, this study aims to investigate the alternations that COVID-19 has brought about in tourists’ purposes and tourism organizations concerning the use of their smartphones.

## 2. Literature Review

### 2.1. *Tourism Management Dynamics and Smartphones during COVID-19*

One of the most important challenges of tourism management during the pandemic in the past three years was that destination planners and tourists did not foresee an epidemic, and what strategy should be adopted in the case of such a situation was not foreseen [16]. One of the main tasks of destination managers and planners is to identify future trends and threats. Additionally, identifying potential opportunities caused by environmental factors can make the structure of tourism management more flexible in adapting to turbulent times. The dynamic structure of tourism management in this situation can reduce the severity of the damage by “controlling the destruction”. Additionally, focusing on modern technology and smart structure leads to the emergence of new businesses that adapt to turbulent conditions. On the other hand, smart platforms are in the spotlight in this situation with user change [17]. The ability to use technology to benefit from existing conditions is

one of the effects of tourism management dynamics [18]. With the spread of the pandemic, smartphones have become the focus of attention of consumers and service providers to reduce unnecessary calls and cut off human communication [19]. The relationship between the audience and smartphones increased to such an extent that the concept of smartphone addiction was raised [20]. Verma et al. (2022) argue that the interaction between tourists and smartphones has taken a new form [21]. In recent years, much research has been published regarding the role of smartphones in tourism. However, the functionality of smartphones during the pandemic is still a vague issue. Perhaps the functions and roles of smartphones in turbulent times such as pandemics are vague points in the literature of this field, and it is impossible to comment on them decisively.

On the other hand, smartphones greatly changed the classic and modern organizational structure during the pandemic era and created an organization based on intelligence and technology according to the current conditions. This new organization was not limited to a physical organizational space, was based solely on smartphones, and continued its communication with tourists. This form of organization had the necessary dynamics to operate during the pandemic and was built according to the ideas of the postmodern organizational school [22]. Therefore, smartphones have assumed a more vital role than in the past [23]. Additionally, the roles of human resources and their functions are widely affected by these new processes [24]. Many employees lost their jobs, and new jobs were created [25]. Now, three years after the outbreak of the pandemic, organizations are often two-dimensional. The first dimension is related to the physical organization, and the second dimension is related to the virtual personality of the organization, which is managed by a person with the title of virtual affairs manager. At this level, smartphones promoted POPAI in this field by establishing the virtual dimension of the organization and maintaining the relationship between the organization and the tourist. The most important function of smartphones during this period was that after doubt in the initial months, the communication between destination organizations and tourists remained connected.

## *2.2. Smartphone Trends in Tourism Management and Tourist Behavior*

Generally, internet usage in the tourism context is divided into two stages: first, from 1991 to 2002, when the internet was pursued by the whole tourism industry; second, from 2002 to the present, when tourism markets have concentrated on conviction and authorizing the consumer by using (more recently ubiquitous) mobile devices, specifically smartphones [26]. At this stage, where smartphone adoption has amplified the significance of consumers more than ever and has reshaped tourism and its business market, realizing consumer behavior toward using mobile technologies due to their competency in access to the internet, GPS, communication channels, and photography applications seems essential to succeeding in the current business industry [27]. Mobile technologies in tourism have been designed and produced to provide electronic information as guidance and help tourists in decision-making [28]. Indeed, traditional mobiles were only capable of calling and texting [29]. However, presently, the most up-to-date mobile apps available through smartphones have a great impact on both the demand side (customer) and the supply side (market) in tourism [26] since they equip travelers with wireless, instant, and prevalent internet access, thus enabling them to send and receive any helpful information globally. The growing impact of sustainable marketing operations in the tourist sector results from technological advances and the acceptance of smartphones [30]. Dickinson et al. [31] define the smartphone as a potent device for tourists because of its ubiquity in the interchange of social and on-site information, as well as connecting them to remote information databases. For instance, smartphones are currently applied for pretravel planning, decision-making, shaping expectations, and pretravel previsions; they are further used for navigation, connectivity, instant/short-time decisions, and location-based data exchanges during travel [32]. The estimated number of smartphone subscribers in 2021 was over 6 billion worldwide, and it will likely rise by several hundred million in forthcoming years [33]. The perpetual and endless variety of tourism apps and their ever-growing users transformed tourism



activity from a location-based network to a distinct network [31]. In the same way, in the tourism industry, smartphones and travel-related applications have become very powerful and noticeable for searching for the needed information, accordingly leading to tourists' decision-making [27]. Based on Petrescu and Bran [26], the online shopping frequency of tourism-related services ranks third among other groups. Tourists who look for travel information during their pretravel time usually continue searching during the trip [34]; thus, tourists' information search behavior is considered a continuous process [35]. However, there is still insufficient knowledge for understanding serious matters such as information classifications searched by tourists through smartphones and the differences between information searched before and during the traveling period [11]. It is confirmed that tourists may alter their behavior during the trip and modify their initial plans due to the information they acquire through their smartphones. Similarly, ref. [36] it is empirically indicated that tourists' behavior is influenced by using information technology during their journey. The increasing use of smartphones, together with other recent developments, has resulted in the birth of smart tourism, which aims to increase the acceptance of new ICT forms [26]. Smartphones have become popular in the tourist and hospitality business as a convenient method for travelers to find information and book accommodations [37]. To date, tourists' concern has been primarily on particular matters such as booking plane tickets, booking hotels, and time management during trips [38]. Likewise, studies on the travel usage of smartphones have mostly focused on specific subjects, such as the advancement of mobile applications [39], the admission of smartphones as a public ICT tool, and the effect of using smartphones on various facets of tourists' experience [40]. The outbreak of COVID-19 has been identified as one of the most destructive occurrences in global history, affecting the tourism industry due to the prevention of human contact and movement [41]. Therefore, as a result of ongoing travel limitations and reduced travelers' conviction, the number of tourists declined by 87% in January 2021 compared with 2020, showing an unusual plunge of 73% throughout tourism history [42]. However, the restrictions caused by this calamity can be observed as an opportunity for travel destinations to advance by presenting their attractions and offering their product and services through a diverse number of hi-tech travel tools [43]. Sañudo et al. [44] showed that following the recent coronavirus pandemic and its criteria related to global lockdown, the usage of smartphones in many countries, including Denmark, Italy, Spain, the Netherlands, and the UK, grew dramatically. In this respect, the use of travel-related applications existing on smartphones changed to a great extent. Thus, the hospitality and tourism industry needs to be prepared to proactively overcome unexpected circumstances by gaining comprehensive knowledge of how to meet travelers' demands in this critical period.

### 2.3. *Tourism Postmodern Organizations and Turbulent Times*

(To read more about the organization from a postmodern point of view, the authors recommend "Organization theory: Modern, symbolic, and postmodern perspectives", Oxford University.)

Organizational theorists examine the organization from three points of view: modernist, interpretive symbolic, and postmodern [22]. The "modernist view" considers the organization as an independent objective entity and takes a positivist approach to produce knowledge. The "interpretive symbolic view" sees the organization as a society that remains stable through human relations and scrutinizes how to create meaning to make facts understandable for those who participate in maintaining them. "Postmodernism" creates a kind of "healthy skepticism" of any "dominant theory" and permits one to try anything completely differently. It seems that the organization in its postmodern formulation is more compatible with the nature of tourism because it provides the necessary dynamism and flexibility for suppliers and applicants of tourism services [3]. Additionally, the organization in this formulation changes according to the technology of the current time and the conditions of the surrounding environment of the organization. In this view, the organization is not just a physical space in a certain place; rather, it can change its

nature according to the circumstances. This approach is compatible with the transition from physical to virtual organization and is based on smartphones in turbulent times such as pandemics [11].

### 3. Materials and Methods

#### 3.1. Study Site

Shiraz metropolis is located in southeastern Iran and is the capital of Fars province (see Figure 1). Its altitude ranges from 1480 to 1670 m above sea level in various districts of the city. Shiraz, known as the cultural capital city of Iran, has a history of more than 4000 years, is known as a city of culture, literature, and art, and has great potential for cultural and art tourism. Shiraz is a sensible destination for medical tourists in the Persian Gulf countries and internationally and has been active in attracting medical tourists from neighboring countries. According to Shiraz University of Medical Sciences, the low cost of health care and the acquisition of global rankings (for example, third place in organ transplantation globally) has made this city the center of medical tourism, including cosmetic surgery tourism, hair transplant tourism, and dental tourism [45]. In future planning, one of its goals is to become a medical tourism hub in the Middle East and Asia. Shiraz is renowned as a city with several world-class cultural heritages from a cultural and tourism standpoint and is the host of the tomb of Persian-speaking poets (such as Hafez and Saadi). Above all, Shiraz has various world heritage sites, such as the Takht-e-Jamshid and Persepolis complex palaces, attracting over a million tourists all over the world yearly [46]. Over the past years, the metropolis of Shiraz has developed its tourism based on smart tourism. For this reason, during the outbreak of the COVID-19 pandemic, smartphones have been used to reduce the severity of damage to tourist destinations.

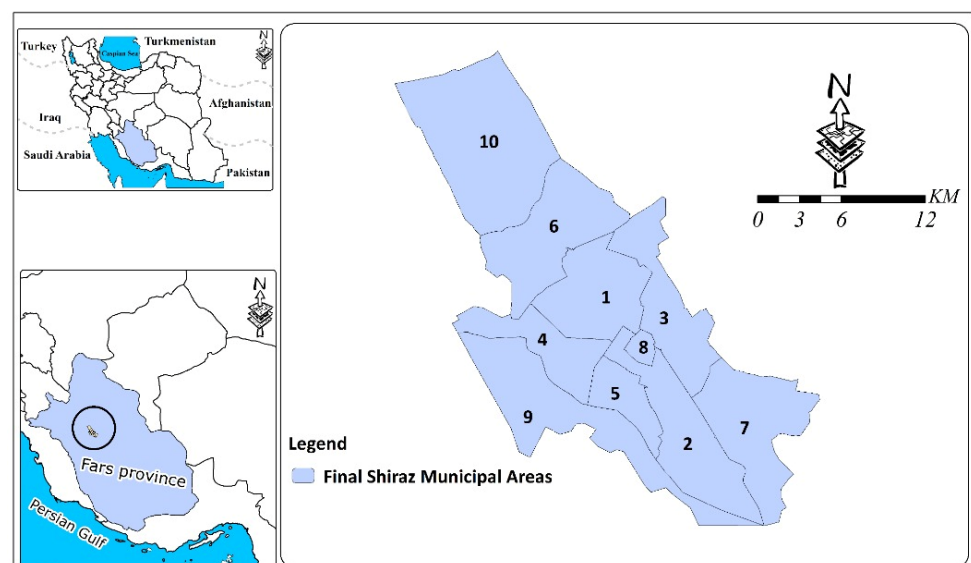

**Figure 1.** Location of Shiraz metropolis.

#### 3.2. Data Collection and Analysis

The statistical sample of the current research consists of two groups, A and B, each group consisting of 16 members as participants. Group A includes smartphone users of Shiraz tourism organizations who managed the virtual organization during the pandemic. Group B also consists of 16 Shiraz travel bloggers, whose content had the most views during the pandemic. In qualitative methods such as theme and content analysis, the sample size is usually small. In this research, due to the limited size of the sample, the participants were selected using the census method, and 32 people were interviewed. In the second stage, the process of interviews began, and the time of each face-to-face interview was approximately 30 min. The interview questions consisted of 5 questions

that are presented in the appendix of the research. The research data were collected cross-sectionally in 2021 and the early months of 2022. All conversations were first recorded and then transcribed. After completing the interviews, all of them were transcribed. In content analysis, transcribing the text of the interviews is one of the most important steps to obtain research codes. After extracting the main themes, subthemes were assigned to related subgroups. In the third step, themes and subthemes were extracted from the transcription text and analyzed using MAXQDA 2020 software. (Table 1).

**Table 1.** Research participants.

R	Group A	Number	Participant as Sample
1	Smartphone users in destination management organizations	P1	User in a five-star hotel
		P2	
		P3	
		P4	User in a travel agency
		P5	
		P6	
		P7	
		P8	
		P9	
		P10	
		P11	
		P12	
		P13	
		P14	
		P15	User in a four-star hotel
		P16	
R	Group B	Tourists	
2	Bloggers	16	Travel bloggers during the pandemic
	<b>Total</b>		32

#### 4. Data Analysis

After transcribing the interviews, the main themes and subthemes were extracted, the results of which are presented in Table 2.

**Table 2.** Results of content analysis.

Themes	Subthemes	Frequency
Tourism management dynamics during pandemics	Identify trends early, Design proactive strategies	24
	Identify potential opportunities from changes and threats	23
	Continuation of tourism businesses during the pandemic	22
	Adjusting human resources and the emergence of new tourism businesses	20
Psychological impacts	Expanding the network of tourist friends	21
	Increasing the resilience of tourists locked up at home	22
	Changing preferences of tourists during the pandemic	24

Table 2. Cont.

Themes	Subthemes	Frequency
Smartphone marketing	Perceived ease of use of smartphones in marketing tourist sites	21
	The tourist is more exposed to marketing activities	20
	Smartphones are available to tourists anytime and anywhere to promote marketing activities	19
	In smartphone marketing, the tourist can quickly connect with the source of the message (hotel, travel agency, fast food services, etc.)	22
Travel planning	Familiarity with different potentials of tourism in the destination and new entertainment	23
	Better choice of travel destination by watching high-quality videos and images, and acquiring more information through social media	21
	Communication with tourism service providers at the destinations	22
	Make payments, reservations, and other things before traveling	19
Postmodern organization		24
	Breaking the concept of organization as a physical space	23
	Virtual organization is the second dimension of physical organization	22
	Adjustment of human resources	24
	Creating new jobs based on technology and current conditions	22
	Increasing communication and two-way interaction between the tourist and the destination organization	18
Virtual organizations are open in all conditions	23	

#### *Final Model Design Based on the Findings*

From an organizational perspective, the organizational boundaries between the tourist and the top level of the organization (manager of a large hotel or manager of a travel agency) collapsed, which is one of the main signs of postmodern organizations [47]. Therefore, according to the MAXQDA analysis, the final model of research is presented.

#### **5. Results**

The research results indicate that smartphones played a vital role during the pandemic and caused positive changes in the structure of tourism management. Tourism has now, to some extent, achieved the necessary preparation for conditions such as a pandemic or other turbulent times; if the conditions repeat, the amount of damage will be less. After the initial shock due to the outbreak of the pandemic in 2019, tourists and destination organizations were able to communicate with each other again using smartphones. Organizations took a new form as a “virtual dimension”, and there were extensive changes in tourists’ preferences. In the final part of the research, the dimensions of the model will be examined separately.

### 5.1. Smartphones as Part of Postmodern Tourism Organization and Tourism Management Dynamics

Virtual tourism organizations designed according to current issues of tourism have different natures in terms of organizational and physical structures [3]. In the early months of the pandemic, many of the destination management organizations (DMOs) that were physically shut down were transferred to virtual organizations in smartphones, and smartphones increased in popularity among tourists and organizations [48], as tourists had continuous two-way communication with them. At the beginning of 2023, smartphones will become the most important part of the life of DMOs and tourists and have already broken the classic organizational structure. According to the research model, the most important advantage of this type of organization in the tourism management cycle is the survival of the organization in conditions of pandemics. Adopting adaptive and preventive strategies according to environmental conditions, equipping destination managers and planners with new management techniques according to technology to benefit from existing conditions, identifying potential opportunities due to changes, and finally using new technologies to obtain the maximum in business are the most important functions of smartphones in tourism management dynamics [18]. Additionally, postmodern organizations are more in tune with the latest technologies due to their open relations with their environment. From the perspective of organizational conflict, the attitude toward conflict in postmodern organizations is a constructive phenomenon. For exactly what smartphones bring to tourism organizations and tourists, see Figure 2. Smartphones have shattered the structure of the classic relationship between tourists and DMOs and have turned tourists and the organization into friends who are constantly in touch. From the perspective of organizational postmodernism, pandemics can be an opportunity for tourism organizations to make themselves a more flexible concept called “breaking the foundation” in the theory of organizational postmodernism. The organization is no longer an inflexible machine, but a painting screen run by an art director [49]. Comprehensive access to and large investment in the development of VR indicate its potential relationships in the development of tourist destinations [50]. Concepts such as digital tourism, virtual tourism, and smart tourism are the results of the information and technology era [51]. The technology acceptance model (TAM) and stimulus-organism-response (SOR) framework are mostly used in VR and AR tourism studies [52]. VR spurs tourists to daydream about tourism suggestions before experiencing them on destination premises [53]. Tourism can strengthen the sense of empathy among tourists in times of crisis and disasters [54]. Observing tourism videos and their impact on tourist empathy [55], the question “how to activate empathy and online platform operators” [56] has been studied. Three factors were raised by the participants as compatibility with the pandemic theme, the most important of which was “A virtual trip to Shiraz without physical contact with the host community,” a 35-year-old woman (a smartphone user in a four-star hotel) said:

“COVID-19 has prevented tourists from traveling to Shiraz. In turn, it has disrupted tourism-related businesses. Starting a virtual trip and sharing clips from Shiraz can relaunch the relevant businesses and ensure the health of tourists.”

Based on our results, it was suggested by all of the respondents that virtual travel during the COVID-19 pandemic could be a practical proposition. It also seems that sharing Shiraz’s videos and images on social media makes it possible to strengthen empathy and unity among tourists during the quarantine period. Similarly, a 29-year-old man (a smartphone user in a travel agency) said:

“As the mayor of Shiraz explicitly stated during the COVID-19 pandemic, “empathy and unity should be the priority of Shiraz tourism authorities,” and, on the other hand, during quarantine, the feelings of empathy, cooperation, and mental health of tourists decreased. In my opinion, by creating Shiraz websites and virtual tours, we can improve the damage.”

A 28-year-old man (international tourist) stated:

“I have traveled a lot to Iran; most of my trips have been to Shiraz. My trip to Shiraz was due to my best friends, whom I found through social media, especially Instagram. Before starting COVID-19, I traveled to Iran every summer. Now my friends who live in Shiraz always send me photos and videos of Hafez and Sa’adi. The last time I saw Shiraz on a virtual trip was through a video call. My smartphone gave me by my friends. Our relationship has become much more intimate due to quarantine conditions and travel rules. My smartphone played a key role in the formation of these friendships, and in this situation, I needed to communicate with them mentally. Thank you, my smart friend.”

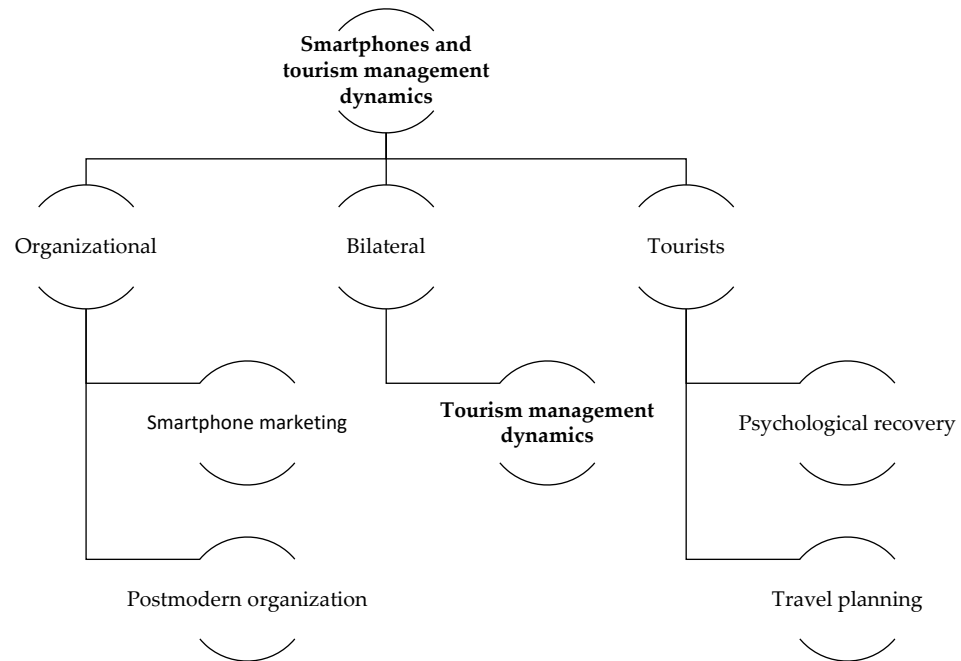
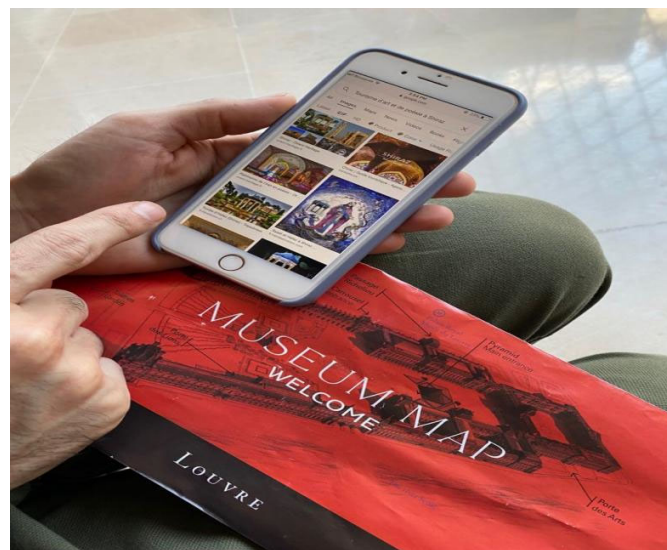

**Figure 2.** Final model design.

### 5.2. Psychological Recovery

It is fully acknowledged that smartphones have become an inextricable part of tourism activities due to their vital role in obtaining and disseminating information [57]. As an innovative and growing ICT tool, the smartphone has advanced the quality of travel basis and turned it into a ubiquitous, dynamic, and fluid context [58]. According to Rodríguez-Torrico et al. (2019), mobile phones have become superior technological tools for tourists in recent decades [59]. This has a great impact on travel patterns as well as the behavior of travelers [60]. After the prevalence of COVID-19, tourists ceased traveling for a long period due to the global lockdown and the perceived risk of becoming infected [61]. This leads to new tourists’ behavior, such as reducing activities with face-to-face contact and considerable care about sanitation and cleanliness [62]. In addition, on March 18th, 2020, an issue was released by the Department of Mental Health, WHO, regarding the psychological precautions for maintaining mental health during the pandemic [63]. In a tourism context, the association between tourism activities and mental health improvement has long been verified [9,10]; however, due to the disruption of tourism mobility during the COVID-19 outbreak, tourists were deprived of this privilege. Nonetheless, according to the results of the current study, people could take advantage of their smartphones to diminish the psychological effects of the crisis to some extent. This could assist tourists through the expansion of the virtual networks between their traveler friends and sharing their past travel diaries. Additionally, the resilience of locked-up tourists has greatly increased as a result of virtual communication relating to travel matters through mobile networks and applications. Moreover, this led to altering the preference of tourists during the pandemic era, which contributes to their health security at this time. Similarly, Lu et al. (2022) support

these research outcomes, asserting that utilizing virtual tourism through smartphones as an amusement tool in the time of the most recent pandemic can endow people with an immersed tourism experience inside their place and assist their tolerance during the lockdown. It is believed that such novel practices are being continued by tourists in post-pandemic times for various purposes [64]. As the world wrestles with the facts of COVID-19, there is an occasion to rethink precisely what tourism will look like in future decades [59], and there is ground to revise world economic value chains and the particular role of tourism as a vector in the outbreak of pandemics [65]. Post-COVID-19 situations may help reimagine “future-forward” worlds. Exactly what is helpful is a “future-back” strategy [65]. As we know, the absolute impact of tourism and tourists make the future of tourism [66]. The value and significance of virtual communities of practice in palliative care are becoming increasingly clear [67]. The COVID-19 period can have immediate or long-term mental health consequences [64]. The main mental health concern has inflated the amount of worry or anxiety reflected in public mental health terms as the COVID-19 epidemic has spread rapidly all over the world [68]. The situation can accelerate new mental ailments and intensify the earlier present disorders [69]. COVID-19 outbreaks have also been shown to damage the morale and mental health of those who already have mental problems [70]. Quarantined people feel apathy, violence, sadness, fear, rejection, despair, insomnia, harmful substance use, and loneliness [40,57]. (Figure 3). A 31-year-old man (an Iranian tourist who lives outside of Iran) stated:



**Figure 3.** A foreign tourist browsing the memories by watching online the tourist attractions of Shiraz.

“I am an Iranian, and I live with my family in Europe. I recently visited the Louvre Museum in Paris. I started my visit due to my dependence on Iran and the Iranian collections that are in Level 0 and section 308 of the museum. During the visit, I felt very homesick, and my trip to Fars was associated with me. I quickly searched for the cultural and historical places and the tomb of the Persian-speaking poets of Shiraz on my smartphone. It was like a virtual journey for me that made me feel good and lessened my nostalgia.”

### 5.3. Smartphone Marketing

Smartphones have been used as an integral means of marketing in recent years, with the power of changing the mind of prospective consumers from negative to positive toward purchasing goods or services [71]. Smartphone marketing can be regarded as a two-way interaction between DMOs and their customers [72]. Using smartphones, tourists have ubiquitous access to all kinds of travel-related information [73]. The lockdown period revealed the value and necessity of smart technologies in helping people cope with the

social and psychological chaos of the crisis [74]. While the main analysis stream on tourism technologies has examined the adoption of smartphones and web-based technologies, the potential of destination marketing through virtual technologies is still to be fully investigated [75]. Similarly, recent studies on COVID-19's effects on the tourism business emphasize the need to change the ways of practicing the tourism business and recommend that tourism locations will have to update their current business models in the future [70,71]. In the same way, the current results show four factors of smartphone marketing that helped tourists deal with isolation. First, smartphones offer tourists perceived ease of use to access travel-related websites, which is a significant marketing tool. Likewise, travel websites such as TripAdvisor offer a great amount of reliable information because customers believe their counterparts more than brands [75]. In addition, tourists are more exposed to marketing activities via smartphones, as they are accessible to tourists anytime and anywhere they need. This phenomenon acts as a mutual benefit for tourists and tourism organizations as a promotional marketing factor. Moreover, by smartphone marketing; tourists can instantly connect to the source of information such as travel agencies, hotels, food services, etc., and check their authenticity. As a consequence, in the post-pandemic era, tourists search for more information than ever before, and new development strategies based on cutting-edge technologies seem necessary specifically for tourism market research. Social media is an essential tool for tourism destination development. The sense distributed in these programs has a fundamental role in tourists' decision-making and tourism management [76]. A film can present a large display promotion of a tourist destination [77]. In response to the growth of social media programs, advanced tourist choice, and technological development, the value of consumer-generated content (CGC) stretches to develop organizations marketing their destinations, products, and services to tourists [78]. A 35-year-old man (a smartphone user in a travel agency) stated the following:

“Social media platforms in times of crisis are the best way to offer tourist attractions. In this case, a robust database is provided for tourists who can check it at any time using their phones. In this way, tourists can also publish their experiences and strengthen their empathy and mental health by reviewing memories.”

Furthermore, a 48-year-old woman (a smartphone user in a five-star hotel) said:

“By creating various tourism applications in Shiraz, the tourism capabilities of the city can be provided in detail in different languages. In recent years, the Tourism Organization has launched the virtual tourism portal of Shiraz with the use of panoramic images and virtual tours, videos, photos, maps, and descriptions (visit [www.fafarschto.ir](http://www.fafarschto.ir) (accessed on 25 June 2022)).”

Additionally, a 29-year-old woman (a student and tourist) stated:

“Recently, joint meetings of Iranian and European tour operators, especially Hungarian ones, have been held with the help of Shiraz Municipality. There are very close ethnic, cultural, and racial commonalities between the Iranian people and the tribes living in the Hungarian city of Jászberény. Many of them want to travel to Shiraz. As a tourist in Hungary, I have always tried to show them the potential of tourism through the websites available for virtual tourism in Fars and Shiraz provinces. In my opinion, smartphones can be very effective as a tool for marketing tourism compatible during a pandemic in Shiraz.” (Figure 4).

According to the findings of this section, the use of smartphones in the Shiraz metropolis can strengthen the marketing of the host community [79]. Consistent with these results, Prideaux et al. [75] also believe that insights learned during COVID-19 can help prepare global tourism for the economic revolution that is needed.





**Figure 4.** Smartphone marketing and virtual tourism of Shiraz.

#### 5.4. Travel Planning

Currently, tourism directors use smartphones to interact and familiarize their customers with tourism destination offerings. Tour executives use social media to obtain notified decision-making about tourists' destinations [80]. Social media is recognized as an essential information reference that affects tourists' travel choices [81]. Social media also plays a significant role in tourists' purchase decisions [82]. Modern travelers' intention to begin a trip is determined frequently by suggestions from friends and family, online references and observations, and, to some extent, knowledge given by a third party [83]. One of the most important elements that visitors consider while planning a trip to a certain location is the dependability of data references. Trust is vital in online tourist marketing since it encourages them to buy. Almost all travelers utilize ICT and cell phones to obtain information about tourist sites, hotels, and accessibility [84–87]. Smartphones, which have recently gained a foothold in tourism, have the potential to introduce the potential of tourism to tourists. For example, using the Internet and social media can show its capabilities to others. Due to their portability and access to the Internet, smartphones have emerged effectively to meet the needs of tourists. Smartphone systems are important tools that move tourists to the virtual world; in this regard, the role of information and communication technology, smartphones, and their tools for travel planning is very significant [80,88–90]. Based on the results of this study, using smartphones by tourists during the quarantine period has helped tourists to become more familiar with the diverse potential of tourist destinations and the new entertainment they offer. Tourists can also have a better choice of travel destination by watching high-quality videos and pictures and obtaining a great amount of information on social media channels.

In this regard, a 34-year-old man (a tourist) said:

“After essential travel items, such as passports, the smartphone ranks first in “what to take with you on the trip.” The last thing I had before going to bed was always a mobile phone so that I could make the next day's travel plans. During the trip, the most common use of smartphones was to take photos, post them on Instagram and WhatsApp, and then use the map. Many large digital companies, such as Google, Facebook, and National Geographic, have a section called travel. In my opinion, applications such as MyShiraz or Shiraz travel can be suggested for planning a trip to Shiraz.”

#### 6. Conclusions

The metropolis of Shiraz is known as the largest city in southern Iran, and tourism is one of the economic and entrepreneurial pillars of this city. Shiraz has good infrastructure in all dimensions of the field of tourism and is a well-equipped destination for international

tourists in various fields. On the other hand, a large number of citizens are employed in the private sector of tourism in this city. Shiraz was one of the tourist destinations that suffered the least damage in the tourism sector during the COVID-19 pandemic. Many of the important medical tourism centers of Shiraz metropolitan city, after passing through the initial shock period caused by the pandemic, provided the necessary training to the patients through smartphones to restart their actions. During 2021, many tourists traveled to Shiraz for hair transplants, cosmetic dentistry, slimming and prosthetic surgeries, and other medical procedures, while they had already received instructions on how to travel safely in pandemic conditions via smartphones. Smartphones contributed greatly to the development of medical tourism in Shiraz during the pandemic. Smartphone-based “virtual organizations”, as well as travel bloggers, played an important role in this regard. After passing through the initial shock and curbing the destruction of tourism, focusing on technology was identified as the priority. Two-way communication between managers and tourists was formed, and tourists were continuously instructed to safely travel during the pandemic through popular smartphone programs. Gaining opportunities from environmental threats and adapting to turbulent times is one of the characteristics of tourism management, dynamics, and destination management organizations in the Shiraz metropolis that were able to implement this concept by using smartphones. Shiraz is now a successful example of the dynamics of tourism management in the pandemic era and can improve its share of tourism income shortly. Therefore, from the point of view of organization theory, it can be concluded that destination organizations in the modern sense are no longer responsive to the needs of the tourism industry in turbulent times such as pandemics. On the other hand, bloggers and travel influencers produced suitable content for tourists beyond smartphones during the recession era. For many tourists with pandemic control, their first destination was Shiraz because many virtual friends were waiting for them at the destination. Creating a network of virtual tourist friends and shaping tourist preferences were the most essential functions of travel bloggers in the Shiraz metropolis, so it can be said that smartphones made the current tourists of Shiraz travel more informed and sustainable compared to tourists before the pandemic. A case study of Shiraz metropolis, although on a small scale, suggests that tourism is now more prepared to deal with turbulent times compared to the pre-pandemic period. The results of the present study have been carried out on a case-by-case basis in the metropolis of Shiraz, and the generalization of its effects, in general, requires large-scale research. Therefore, it is suggested that researchers study the functions and roles of smartphones in the tourism management literature from a newer perspective, such as the effect of smartphones on the adjustment of human resources of destination organizations, the role of smartphones in managing the emotions of tourists in turbulent times, and the role of smartphones in the development of sustainable tourism, which are considered suitable subjects in this field. Additionally, developing a crisis control model for tourism businesses in turbulent times such as epidemics is a suitable idea for future research that requires more extensive studies.

**Author Contributions:** Conceptualization, A.G. (Amir Ghorbani) and H.M.; Methodology, A.G. (Azadeh Golafshan) and F.A.A.; Software, A.G. (Azadeh Golafshan) and H.M.J.; Validation, R.K., A.G. (Amir Ghorbani), F.A.A., D.L.D. and H.M.; Formal analysis, A.G. (Azadeh Golafshan), H.M., R.K., A.G. (Amir Ghorbani), F.A.A. and H.M.J.; Investigation, H.M., D.L.D. and R.K.; Resources, H.M.J., H.M. and F.A.A.; Data curation, R.K., D.L.D. and A.G. (Amir Ghorbani); Writing—original draft preparation, H.M., A.G. (Azadeh Golafshan) and A.G. (Amir Ghorbani); Writing—review and editing, R.K., F.A.A., D.L.D., H.M. and H.M.J.; Visualization, H.M., A.G. (Amir Ghorbani) and A.G. (Azadeh Golafshan); Supervision, H.M., R.K. and D.L.D.; Project administration, R.K., D.L.D. and A.G. (Amir Ghorbani); Funding acquisition, R.K. and H.M.J. All authors have read and agreed to the published version of the manuscript.

**Funding:** This research was created and supported by the Hungarian University of Agricultural and Life Sciences (MATE), Doctoral School of Economic and Regional Sciences and Stipendium Hungaricum Scholarship.

**Informed Consent Statement:** Informed consent was obtained from all subjects involved in the study.

**Data Availability Statement:** Not applicable.

**Conflicts of Interest:** The authors declare no conflict of interest.

## References

1. Ntounis, N.; Parker, C.; Skinner, H.; Steadman, C.; Warnaby, G. Tourism and Hospitality industry resilience during the COVID-19 pandemic: Evidence from England. *Curr. Issues Tour.* **2022**, *25*, 46–59. [CrossRef]
2. Mosazadeh, H.; Razi, F.F.; Lajevardi, M.; Mousazadeh, H.; Ghorbani, A.; Almani, F.A.; Shiran, F. Restarting Medical Tourism in the COVID-19 Pandemic: A Strategic-based Approach. *J. Health Rep. Technol.* **2021**, *8*, e117932. [CrossRef]
3. Ghorbani, A.; Danaei, A.; Zargar, S.M.; Hematian, H. Designing of smart tourism organization (STO) for tourism management: A case study of tourism organizations of South Khorasan province, Iran. *Heliyon* **2019**, *5*, e01850. [CrossRef] [PubMed]
4. García-Milon, A.; Olarte-Pascual, C.; Juaneda-Ayensa, E. Assessing the moderating effect of COVID-19 on intention to use smartphones on the tourist shopping journey. *Tour. Manag.* **2021**, *87*, 104361. [CrossRef]
5. Skinner, H. Place Branding—The Challenges of Getting It Right: Coping with Success and Rebuilding from Crises. *Tour. Hosp.* **2021**, *2*, 173–189. [CrossRef]
6. Analytica, O. Costa Rica's economy looks set for a strong recovery. *Emerald Expert Brief.* **2021**. [CrossRef]
7. Nakagawara, K.; Kamata, H.; Chubachi, S.; Namkoong, H.; Tanaka, H.; Lee, H.; Otake, S.; Fukushima, T.; Kusumoto, T.; Morita, A.; et al. Diagnostic significance of secondary bacteremia in patients with COVID-19. *J. Infect. Chemother.* **2023**, *online ahead of print*. [CrossRef]
8. Sheth, J.N. Post-pandemic marketing: When the peripheral becomes the core. *J. Res. Interact. Mark.* **2022**, *16*, 37–44. [CrossRef]
9. Niewiadomski, P. COVID-19: From temporary de-globalisation to a re-discovery of tourism? *Tour. Geogr.* **2020**, *22*, 651–656. [CrossRef]
10. Ghorbani, A.; Danaei, A.; Barzegar, S.M.; Hemmatian, H. Post modernism and designing smart tourism organization (STO) for tourism management. *J. Tour. Plan. Dev.* **2019**, *8*, 50–69.
11. Jin, H.; Cai, W. Understanding the smartphone usage of Chinese outbound tourists in their shopping practices. *Curr. Issues Tour.* **2022**, *25*, 2955–2968. [CrossRef]
12. Ghorbani, A.; Mousazadeh, H.; Taheri, F.; Ehteshammajd, S.; Azadi, H.; Yazdanpanah, M.; Khajehshahkahi, A.; Tanaskovik, V.; Van Passel, S. An attempt to develop ecotourism in an unknown area: The case of Nehbandan County, South Khorasan Province, Iran. *Environ. Dev. Sustain.* **2021**, *23*, 11792–11817. [CrossRef]
13. Zarchi, M.K.R.; Jabbari, A.; Hatam, N.; Bastani, P.; Shafaghat, T.; Fazelzadeh, O. Strategic Analysis of Shiraz Medical Tourism Industry: A Mixed Method Study. *Galen Med. J.* **2018**, *7*, e1021. [CrossRef]
14. Zenker, S.; Kock, F. The coronavirus pandemic—A critical discussion of a tourism research agenda. *Tour. Manag.* **2020**, *81*, 104164. [CrossRef] [PubMed]
15. Giddy, J.K.; Rogerson, C.M.; Rogerson, J.M. Rural Tourism Firms in the COVID-19 Environment: South African Challenges. *Geoj. Tour. Geosites* **2022**, *41*, 343–353. [CrossRef]
16. Balsalobre-Lorente, D.; Driha, O.M.; Sinha, A. The dynamic effects of globalization process in analysing N-shaped tourism led growth hypothesis. *J. Hosp. Tour. Manag.* **2020**, *43*, 42–52. [CrossRef]
17. Buhalis, D.; Costa, C. (Eds.) *Tourism Management Dynamics: Trends, Management and Tools*; Routledge: London, UK, 2006.
18. Raheem, B.; Mahmood, M.D.; Abu Taher, G.; Shakeel, Z. A Study on The Use of Smartphone Applications in English Language Learning with Special Reference to COVID-19 Pandemic. *J. La Edusci* **2022**, *3*, 37–46. [CrossRef]
19. Chopdar, P.K.; Paul, J.; Prodanova, J. Mobile shoppers' response to COVID-19 phobia, pessimism and smartphone addiction: Does social influence matter? *Technol. Forecast. Soc. Chang.* **2022**, *174*, 121249. [CrossRef]
20. Verma, S.; Warrior, L.; Bolia, B.; Mehta, S. Past, present, and future of virtual tourism—a literature review. *Int. J. Inf. Manag. Data Insights* **2022**, *2*, 100085. [CrossRef]
21. Hatch, M.J. *Organization Theory: Modern, Symbolic, and Postmodern Perspectives*; Oxford University Press: New York, NY, USA, 2018.
22. Mengistu, N.; Habtamu, E.; Kassaw, C.; Madoro, D.; Molla, W.; Wudneh, A.; Abebe, L.; Duko, B. Problematic smartphone and social media use among undergraduate students during the COVID-19 pandemic: In the case of southern Ethiopia universities. *PLoS ONE* **2023**, *18*, e0280724. [CrossRef]
23. Nankervis, A.R.; Cameron, R. Capabilities and competencies for digitised human resource management: Perspectives from Australian HR professionals. *Asia Pac. J. Hum. Resour.* **2023**, *61*, 232–251. [CrossRef]
24. Al-Alawi, A.I.; Messaadia, M.; Mehrotra, A.; Sanosi, S.K.; Elias, H.; Althawadi, A.H. Digital transformation adoption in human resources management during COVID-19. *Arab. Gulf J. Sci. Res.* **2023**; *online ahead of print*. [CrossRef]
25. Petrescu, D.C.; Bran, F. The use of smartphone for the search of touristic information. An application of the theory of planned behavior. *Econ. Comput. Econ. Cybern. Stud. Res.* **2020**, *54*, 125–140.
26. Xiang, Z.; Magnini, V.P.; Fesenmaier, D.R. Information technology and consumer behavior in travel and tourism: Insights from travel planning using the internet. *J. Retail. Consum. Serv.* **2015**, *22*, 244–249. [CrossRef]
27. Wang, Y.-S.; Li, H.-T.; Li, C.-R.; Zhang, D.-Z. Factors affecting hotels' adoption of mobile reservation systems: A technology-organization-environment framework. *Tour. Manag.* **2016**, *53*, 163–172. [CrossRef]

28. Tan, G.W.-H.; Lee, V.H.; Lin, B.; Ooi, K.-B. Mobile applications in tourism: The future of the tourism industry? *Ind. Manag. Data Syst.* **2017**, *117*, 560–581. [CrossRef]
29. Sharmin, F.; Sultan, M.; Badulescu, D.; Badulescu, A.; Borma, A.; Li, B. Sustainable Destination Marketing Ecosystem through Smartphone-Based Social Media: The Consumers' Acceptance Perspective. *Sustainability* **2021**, *13*, 2308. [CrossRef]
30. Dickinson, J.E.; Ghali, K.; Cherrett, T.; Speed, C.; Davies, N.; Norgate, S. Tourism and the smartphone app: Capabilities, emerging practice and scope in the travel domain. *Curr. Issues Tour.* **2014**, *17*, 84–101. [CrossRef]
31. Kang, S.; Jodice, L.W.; Norman, W.C. How do tourists search for tourism information via smartphone before and during their trip? *Tour. Recreat. Res.* **2020**, *45*, 57–68. [CrossRef]
32. Statista. Number of Smartphone Subscriptions Worldwide from 2016 to 2027. Available online: <https://www.statista.com/statistics/330695/number-of-smartphone-users-worldwide/> (accessed on 23 February 2022).
33. Kah, J.A.; Lee, S.-H. A new approach to travel information sources and travel behaviour based on cognitive dissonance theory. *Curr. Issues Tour.* **2015**, *19*, 373–393. [CrossRef]
34. Choi, S.; Lehto, X.Y.; Morrison, A.M.; Jang, S. Structure of Travel Planning Processes and Information Use Patterns. *J. Travel Res.* **2011**, *51*, 26–40. [CrossRef]
35. Chung, N.; Koo, C.; Kim, J.K. Extrinsic and intrinsic motivation for using a booth recommender system service on exhibition attendees' unplanned visit behavior. *Comput. Hum. Behav.* **2014**, *30*, 59–68. [CrossRef]
36. Hwang, J.; Eves, A.; Stienmetz, J. The Impact of Social Media Use on Consumers' Restaurant Consumption Experiences: A Qualitative Study. *Sustainability* **2021**, *13*, 6581. [CrossRef]
37. Wang, D.; Xiang, Z.; Fesenmaier, D.R. Smartphone Use in Everyday Life and Travel. *J. Travel Res.* **2016**, *55*, 52–63. [CrossRef]
38. Ricci, F. Mobile recommender systems. *Inf. Technol. Tour.* **2010**, *12*, 205–231. [CrossRef]
39. Wang, C.; Pan, R.; Wan, X.; Tan, Y.; Xu, L.; Ho, C.S.; Ho, R.C. Immediate psychological responses and associated factors during the initial stage of the 2019 coronavirus disease (COVID-19) epidemic among the general population in China. *Int. J. Environ. Res. Public Health* **2020**, *17*, 1729. [CrossRef]
40. Fong, L.H.N.; Law, R.; Ye, B.H. Outlook of tourism recovery amid an epidemic: Importance of outbreak control by the government. *Ann. Tour. Res.* **2020**, *86*, 102951. [CrossRef]
41. United Nations World Tourism Organization (UNWTO). Tourist Arrivals down 87% in January 2021 as Unwto Calls for Stronger Coordination to Restart Tourism. Available online: <https://www.unwto.org/news/tourist-arrivals-down-87-in-january-2021-as-unwto-calls-for-stronger-coordination-to-restart-tourism> (accessed on 31 March 2021).
42. Kwok, A.O.J.; Koh, S.G.M. COVID-19 and Extended Reality (XR). *Curr. Issues Tour.* **2021**, *24*, 1935–1940. [CrossRef]
43. Sañudo, B.; Fennell, C.; Sánchez-Oliver, A.J. Objectively-assessed physical activity, sedentary behavior, smartphone use, and sleep patterns pre-and during-COVID-19 quarantine in young adults from Spain. *Sustainability* **2020**, *12*, 5890. [CrossRef]
44. Azimi, H. The Role of Emotional Factors in Developing Consumer and Brand Relations in the Medical Tourism Industry. Case Study: Hospitals of Shiraz City. *J. Environ. Manag. Tour.* **2020**, *11*, 1893–1901.
45. Molavi Vardanjani, H.; Salehi, Z.; Alembizar, F.; Cramer, H.; Pasalar, M. Prevalence and the Determinants of Traditional, Complementary, and Integrative Medicine Use Among Breastfeeding Mothers: A Cross-section Study. *J. Integr. Complement. Med.* **2022**, *28*, 67–76.
46. Kowalczyk-Anioł, J.; Grochowicz, M.; Pawlusiński, R. How a Tourism City Responds to COVID-19: A CEE Perspective (Kraków Case Study). *Sustainability* **2021**, *13*, 7914. [CrossRef]
47. Lapointe, D. Reconnecting tourism after COVID-19: The paradox of alterity in tourism areas. *Tour. Geogr.* **2020**, *22*, 633–638. [CrossRef]
48. Rejón-Guardia, F.; Polo-Peña, A.I.; Maraver-Tarifa, G. The acceptance of a personal learning environment based on Google apps: The role of subjective norms and social image. *J. Comput. High. Educ.* **2020**, *32*, 203–233. [CrossRef]
49. Loureiro, S.M.C.; Guerreiro, J.; Ali, F. 20 years of research on virtual reality and augmented reality in tourism context: A text-mining approach. *Tour. Manag.* **2020**, *77*, 104028. [CrossRef]
50. Bogicevic, V.; Seo, S.; Kandampully, J.A.; Liu, S.Q.; Rudd, N.A. Virtual reality presence as a preamble of tourism experience: The role of mental imagery. *Tour. Manag.* **2019**, *74*, 55–64. [CrossRef]
51. Bauman, M.; Velikova, N.; Dodd, T.; Blankenship, T. Generational differences in risk perception and situational uses of wine information sources. *Int. J. Wine Bus. Res.* **2019**, *32*, 247–265. [CrossRef]
52. Liu, X.; Wang, D.; Gretzel, U. On-site decision-making in smartphone-mediated contexts. *Tour. Manag.* **2022**, *88*, 104424. [CrossRef]
53. Lamsfus, C.; Wang, D.; Alzua-Sorzabal, A.; Xiang, Z. Going mobile: Defining context for on-the-go travelers. *J. Travel Res.* **2015**, *54*, 691–701. [CrossRef]
54. Rodríguez-Torrico, P.; Prodanova, J.; San-Martín, S.; Jimenez, N. The ideal companion: The role of mobile phone attachment in travel purchase intention. *Curr. Issues Tour.* **2020**, *23*, 1659–1672. [CrossRef]
55. Myers, G.; Scarinci, J. Consumers' Use of Smartphone Technology for Travel and Tourism in a COVID Era: A Scoping Review. *J. Resilient Econ.* **2022**, *2*, 169–180. [CrossRef]
56. Neuburger, L.; Egger, R. Travel risk perception and travel behaviour during the COVID-19 pandemic 2020: A case study of the DACH region. *Curr. Issues Tour.* **2021**, *24*, 1003–1016. [CrossRef]
57. Rokni, L. The Psychological Consequences of COVID-19 Pandemic in Tourism Sector: A Systematic Review. *Iran. J. Public Health* **2021**, *50*, 1743. [CrossRef] [PubMed]

58. Yi, J.; Yuan, G.; Yoo, C. The effect of the perceived risk on the adoption of the sharing economy in the tourism industry: The case of Airbnb. *Inf. Process. Manag.* **2020**, *57*, 102108. [CrossRef]
59. Rebecca, P.; Giampaolob, V.; Laurac, G.; Danieled, D. When empathy prevents negative reviewing behavior. *Ann. Tour. Res.* **2019**, *75*, 265–278.
60. Brouder, P. Reset redux: Possible evolutionary pathways towards the transformation of tourism in a COVID-19 world. *Tour. Geogr.* **2020**, *22*, 484–490. [CrossRef]
61. Gössling, S.; Scott, D.; Hall, C.M. Pandemics, tourism and global change: A rapid assessment of COVID-19. *J. Sustain. Tour.* **2020**, *29*, 1–20. [CrossRef]
62. Johnson, M.; Suskewicz, J. Does Your Company Have a Long-Term Plan for Remote Work. 2020. Available online: <https://hbr.org/2020/07/does-your-company-have-a-long-term-plan-for-remote-work> (accessed on 23 February 2022).
63. Hall, M.C.; Prayag, G.; Fieger, P.; Dyason, D. Beyond panic buying: Consumption displacement and COVID-19. *J. Serv. Manag.* **2020**, *32*, 113–128. [CrossRef]
64. Mills, K.G.; Dang, A. Creating “Smart” Policy to Promote Entrepreneurship and Innovation. In *The Role of Innovation and Entrepreneurship in Economic Growth*; University of Chicago Press: Chicago, IL, USA, 2020.
65. Kar, N.S.; Basu, A.; Kundu, M.; Giri, A. Urban heritage tourism in Chandernagore, India: Revival of shared Indo-French Legacy. *Geojournal* **2020**, *87*, 1575–1591. [CrossRef]
66. Dong, L.; Bouey, J. Public mental health crisis during COVID-19 pandemic, China. *Emerg. Infect. Dis.* **2020**, *26*, 1616. [CrossRef]
67. Goyal, P.; Choi, J.J.; Pinheiro, L.C.; Schenck, E.J.; Chen, R.; Jabri, A.; Satlin, M.J.; Campion, T.R., Jr.; Nahid, M.; Ringel, J.B. Clinical characteristics of COVID-19 in New York city. *N. Engl. J. Med.* **2020**, *382*, 2372–2374. [CrossRef] [PubMed]
68. Ho, C.S.; Chee, C.Y.; Ho, R.C. Mental health strategies to combat the psychological impact of COVID-19 beyond paranoia and panic. *Ann. Acad. Med. Singap.* **2020**, *49*, 155–160. [CrossRef]
69. Nunn, J. Restaurants Will Never Be the Same after Coronavirus—But That May Be a Good Thing. *The Guardian*. Available online: <https://www.theguardian.com/commentisfree/2020/apr/14/coronavirus-restaurants-pandemic-workers-communities-prices> (accessed on 28 July 2022).
70. Tourism from Zero. Tourism From Zero Initiative. Available online: <https://tourismfromzero.org> (accessed on 28 July 2022).
71. Nepal, S.K. Adventure travel and tourism after COVID-19—business as usual or opportunity to reset? *Tour. Geogr.* **2020**, *22*, 646–650. [CrossRef]
72. Lu, J.; Xiao, X.; Xu, Z.; Wang, C.; Zhang, M.; Zhou, Y. The potential of virtual tourism in the recovery of tourism industry during the COVID-19 pandemic. *Curr. Issues Tour.* **2022**, *25*, 441–457. [CrossRef]
73. Alam, R.; Mostofa, M.G.; Khondker, T.W. Mobile technology uses towards marketing of tourist destinations: An analysis from therapeutic point of view. *J. Mob. Comput. Appl.* **2019**, *6*, 17–21.
74. Kim, H.H.; Sun, S.; Law, R. Value proposition of smartphone destination marketing: The cases of Hong Kong and South Korea. *J. Econ. Manag.* **2022**, *44*, 187–209. [CrossRef]
75. Trunfio, M.; Pasquinelli, C. Smart technologies in the COVID-19 crisis: Managing tourism flows and shaping visitors’ behaviour. *Eur. J. Tour. Res.* **2021**, *29*, 2910. [CrossRef]
76. Vargas, A. COVID-19 crisis: A new model of tourism governance for a new time. *Worldw. Hosp. Tour. Themes* **2020**, *12*, 691–699. [CrossRef]
77. Chilembwe, J.M.; Gondwe, F.W. Role of Social Media in Travel Planning and Tourism Destination Decision Making. In *Handbook of Research on Social Media Applications for the Tourism and Hospitality Sector*; IGI Global: Hershey, PA, USA, 2020; pp. 36–51.
78. Liu, X.; Mehraliyev, F.; Liu, C.; Schuckert, M. The roles of social media in tourists’ choices of travel components. *Tour. Stud.* **2020**, *20*, 27–48. [CrossRef]
79. Song, S.; Yoo, M. The role of social media during the pre-purchasing stage. *J. Hosp. Tour. Technol.* **2016**, *7*, 84–99. [CrossRef]
80. Priatmoko, S.; Kabil, M.; Purwoko, Y.; Dávid, L. Rethinking Sustainable Community-Based Tourism: A Villager’s Point of View and Case Study in Pampang Village, Indonesia. *Sustainability* **2021**, *13*, 3245. [CrossRef]
81. Tham, A.; Croy, G.; Mair, J. Social Media in Destination Choice: Distinctive Electronic Word-of-Mouth Dimensions. *J. Travel Tour. Mark.* **2013**, *30*, 144–155. [CrossRef]
82. Di Pietro, L.; Di Virgilio, F.; Pantano, E. Social network for the choice of tourist destination: Attitude and behavioural intention. *J. Hosp. Tour. Technol.* **2012**, *1*, 60–76. [CrossRef]
83. Jeong, E.; Jang, S. Restaurant experiences triggering positive electronic word-of-mouth (eWOM) motivations. *Int. J. Hosp. Manag.* **2011**, *30*, 356–366. [CrossRef]
84. Mkono, M. A netnographic examination of constructive authenticity in Victoria Falls tourist (restaurant) experiences. *Int. J. Hosp. Manag.* **2012**, *31*, 387–394. [CrossRef]
85. Berhanu, K.; Raj, S. The trustworthiness of travel and tourism information sources of social media: Perspectives of international tourists visiting Ethiopia. *Heliyon* **2020**, *6*, e03439. [CrossRef]
86. Kabil, M.; Priatmoko, S.; Magda, R.; Dávid, L. Blue Economy and Coastal Tourism: A Comprehensive Visualization Bibliometric Analysis. *Sustainability* **2021**, *13*, 3650. [CrossRef]
87. Khan, M.A.; Popp, J.; Talib, M.N.A.; Lakner, Z.; Khan, M.A.; Oláh, J. Asymmetric Impact of Institutional Quality on Tourism Inflows Among Selected Asian Pacific Countries. *Sustainability* **2020**, *12*, 1223. [CrossRef]

88. Alreahi, M.; Bujdosó, Z.; Kabil, M.; Akaak, A.; Benkó, K.F.; Setioningtyas, W.P.; Dávid, L.D. Green Human Resources Management in the Hotel Industry: A Systematic Review. *Sustainability* **2023**, *15*, 99. [CrossRef]
89. Ramos, É.M.S.; Bergstad, C.J.; Nässén, J. Understanding daily car use: Driving habits, motives, attitudes, and norms across trip purposes. *Transp. Res. Part F Traffic Psychol. Behav.* **2020**, *68*, 306–315. [CrossRef]
90. Zhou, Q.; Zhu, K.; Kang, L.; Dávid, L.D. Tea Culture Tourism Perception: A Study on the Harmony of Importance and Performance. *Sustainability* **2023**, *15*, 2838. [CrossRef]

**Disclaimer/Publisher’s Note:** The statements, opinions and data contained in all publications are solely those of the individual author(s) and contributor(s) and not of MDPI and/or the editor(s). MDPI and/or the editor(s) disclaim responsibility for any injury to people or property resulting from any ideas, methods, instructions or products referred to in the content.

## Article

# Extraordinary and Unavoidable Circumstances in Tourism under COVID-19 and Post Pandemic Times—Casus Poland as Example of Sustainability Management

Dominik Borek <sup>1,\*</sup>  and Daniel Puciato <sup>2</sup><sup>1</sup> Ministry of Sport and Tourism, 00-082 Warszawa, Poland<sup>2</sup> Faculty of Finance and Management, WSB University in Wrocław, 53-609 Wrocław, Poland

\* Correspondence: dpborek@wp.pl; Tel.: +48-22-411-9797

**Abstract:** The views expressed in this paper are those of the authors and should not be taken as reflecting the position of any authority, entity or institution. This article presents the legal status as of 25 June 2022. In accordance with the Directive (EU) 2015/2302 of the European Parliament and of the Council of 25 November 2015 on package travel and linked travel arrangements, amending Regulation (EC) No 2006/2004 and Directive 2011/83/EU of the European Parliament and of the Council and repealing Council Directive 90/314/EEC, tour operators registered in Poland are required to refund payments to travelers in the case of cancellation of their travel package due to extraordinary and unavoidable circumstances within 14 days of its termination. The traveler has the right to terminate the package travel contract before the start of the trip without paying any termination fee in the event of unavoidable and extraordinary circumstances occurring at the destination or its immediate vicinity and which significantly affect the implementation of the package or the transport of passengers to their final destination. In the case of termination of the package travel contract due to unavoidable and extraordinary circumstances, the traveler is entitled to a full refund of any payments made for the package travel but is not entitled to any additional compensation. The tour operator makes the return within 14 days from the effective termination of the travel contract. In the article we will describe the situation during the COVID-19 pandemic and post-COVID times. The significance and implications of our findings and arguments show how important this is in designing a state's tourism policy. Targeted aid can be designed well in advance of extraordinary and unavoidable circumstances. In our opinion and the opinions of business practitioners, extraordinary and unavoidable circumstances in tourism occur on average every ten years, e.g., the 1992 Yugoslavia war, 2001 attack on the World Trade Center, 2010 Eyjafjallajökull volcanic eruption, and the 2020 COVID-19 pandemic. The results of the research show the effectiveness of legal instruments enacted by the Polish government during the COVID 19 crisis and the war in Ukraine. In the article we use two methods—empirical, related to the authors' own experience, and dogmatic–exegetical. The empirical research was based on the authors' experience as those responsible for the implementation of statutory regulations (director in the Ministry of Sport and Tourism and Ministry's advisor) and on the concept of law as one of the normative systems in society—the operation of law in the sphere of social and economic life, which is tourism. A dogmatic–exegetical method was also used, which allowed for the study of the literature on the subject and the review of legal regulations. In our research, we also used the method of the economic analysis of law (law and economics method). Graphical presentation of the research results and the impact of the introduced support mechanisms on supply and demand indicate the desirability of solutions in this area.



**Citation:** Borek, D.; Puciato, D. Extraordinary and Unavoidable Circumstances in Tourism under COVID-19 and Post Pandemic Times—Casus Poland as Example of Sustainability Management. *Sustainability* **2023**, *15*, 2416. <https://doi.org/10.3390/su15032416>

Academic Editors: Zygmunt Kruczek and Bartłomiej Walas

Received: 3 January 2023

Revised: 22 January 2023

Accepted: 25 January 2023

Published: 29 January 2023



**Copyright:** © 2023 by the authors. Licensee MDPI, Basel, Switzerland. This article is an open access article distributed under the terms and conditions of the Creative Commons Attribution (CC BY) license (<https://creativecommons.org/licenses/by/4.0/>).

**Keywords:** tour operator; travel package; linked travel arrangements; insolvency; COVID-19

## 1. Introduction

The COVID-19 pandemic and the post-COVID period have caused numerous turbulences in the world's tourism markets, which have included: closed airports; strikes;

the growing popularity of virtual tourism [1]; bans and restrictions on passenger traffic; restrictions on entering cultural, public utility, and commercial facilities; and the obligation to wear masks in public places.

Travel and business activity restrictions were common practices used by governments of many countries to prevent the spread of the negative effects of the pandemic [2–6]. As a consequence, global tourism traffic and expenditure dropped significantly, which adversely impacting the economic results of tourism enterprises and bringing about the risk of their insolvency and bankruptcy [7–9]. Therefore, governments of many countries introduced tools to support tour operators with the aim to mitigate these negative effects, which included employment reduction, bankruptcies and insolvency against travelers and customers of business entities [10,11]. These activities can be considered to be the practical implementations of the theorem of sustainable development—including corporate social responsibility—from the social perspective of such stakeholder groups as employees, customers, suppliers and local communities [12–15]. An important group of tools for implementing such activities has turned out to be direct tools, with particular focus on legal systems, both in the subjective sense (governments and their agencies) and in the substantive sense (legal acts). The above observations have been the main impulse for writing this article.

In this article, the points marked with the Arabic numerals 2–4 are quoted on the basis of the decision of the European Commission SA.58102 (2020/N) COVID-19 to support tour operators and other undertakings active in tourism and culture, referred in the present case. Often the facts are listed directly in the words of the European Commission, because, in this way and in relation to the relevant documents, the facts and the decision can be briefly presented to readers. In order to broaden possible knowledge in this regard, We refer directly to the decision on the basis of which the summary and clear information was compiled. The material is the result of our work and experience in the tourism sector and is therefore largely based on the empirical method. We would like to offer thanks for the opportunity to present these research results, as it is important for public administration to share the results of their work.

This article seeks to demonstrate the significance of the tourism support funds for the practical implementation of the theorem of sustainable development, including corporate social responsibility. In the paper, four main research methods have been used: a literature review, an economic analysis of law, a document analysis and a case study.

Tourism is an interdisciplinary field affected by unavoidable and extraordinary circumstances. Tourism was the first field to experience the crisis and the last to emerge from it [16]. Extraordinary and unavoidable circumstances in tourism occur, on average, every 10 years, e.g., the 1992 Yugoslavia war, the 2001 attack on the World Trade Center, the 2010 Eyjafjallajökull volcanic eruption, and the 2020 COVID-19 pandemic.

The European Commission has decided to initiate a dialogue about the provisions of Directive 2015/2302 in several member states. This was in regard to the provision of refunds to travelers within 14 days from the date of termination of the contract in the case of extraordinary and unavoidable circumstances. The dialogues were introduced in Croatia, the Czech Republic, Cyprus, France, Greece, Lithuania, Poland, Portugal and Slovakia. Poland was the only country to solve the case comprehensively, because travelers were reimbursed from a special fund. We decided to undertake this study because no research had been undertaken on this subject as of yet. We wish to show the conclusions that have been drawn from our research in an article based on our own observations.

## 2. Literature Review/Theoretical Background

In accordance with the Directive (EU) 2015/2302 of the European Parliament and of the Council of 25 November 2015 on package travel and linked travel arrangements, amending Regulation (EC) No 2006/2004 and Directive 2011/83/EU of the European Parliament and of the Council and repealing Council Directive 90/314/EEC, tour operators registered in Poland are required to refund payments to travelers in the case of cancellation of the



travel package due to extraordinary and unavoidable circumstances within 14 days of its termination [17]. Travelers have the opportunity to terminate the package travel contract at any time prior to its commencement, for an appropriate and justifiable termination fee, taking into account the expected cost savings and income from the alternative use of the travel services concerned. However, travelers also have the right to terminate the package travel contract without paying any termination fee, when unavoidable and extraordinary circumstances significantly affect the performance of the package travel. Unavoidable and extraordinary circumstances may relate, for example, to hostilities, other serious security problems such as terrorism, a significant threat to human health such as an outbreak of a major disease (such as a pandemic) at the destination, or natural disasters such as floods or earthquakes, or weather conditions preventing safe travel to the destination specified in the package travel contract. Extraordinary and unavoidable circumstances have their legal definition which describes a situation beyond the control of the invoking party, the consequences of which could not have been avoided even if all reasonable steps had been taken [5].

Extraordinary and unavoidable circumstances constitute a broader set of designations than the so-called force majeure (*vis maior*) which, although having no legal definition, has been defined by civil law jurisprudence. According to the judgment of the Court of Appeal in Lublin, Third Division: Labour Law and Social Insurance of 19 November 2019, case file no. III APa 15/19, force majeure (*vis maior*) is not defined by the provisions of the Civil Code [18–20]. Its definition has been shaped in the doctrine and judicature which prefer the so-called objective concept of force majeure. According to this concept, only an event that can be characterized as external, unforeseeable and with unavoidable effects, can be recognized as force majeure. An event is external if it occurs outside the enterprise structure, while the unforeseeability of an event should be understood as its extraordinary and sudden nature. Unavoidability of the consequences of the event is understood as its overwhelmingness, i.e., the impossibility to repel an imminent danger. Force majeure is therefore defined as an exclusive, external, extraordinary, sudden, unforeseeable and inevitable cause. Even a sudden natural phenomenon is not force majeure if acting with utmost diligence would have prevented its effects. Below, we present a scheme comparison of force majeure and extraordinary and unavoidable circumstances (Table 1).

**Table 1.** Comparison of force majeure and extraordinary and unavoidable circumstances.

Name	Characteristic	Action	Consequences
Extraordinary and unavoidable circumstances	out of control	any reasonable action	the inevitable consequences
Vis maior	extraordinary	utmost diligence	inability to prevent the effects

Source: own study.

Extraordinary and unavoidable circumstances comprise, therefore, in terms of their designates, a wider concept than force majeure as they may be a foreseeable phenomenon, as was the case, for example, with the COVID-19 pandemic. Its consequences seem to have been foreseeable and thus, in its case, The Act of 24 November 2017 on travel packages and link travel arrangements, (Journal of Laws of 2002, item 511) was applied [21–28].

In the previous act on tourism services—The Act of 29 August 1997 about tourist services (Journal of Laws of 2004, item 223)—the tour operator was responsible for the non-performance or improper performance of the contract for the provision of tourism services, unless the non-performance or improper performance was caused by force majeure. Likewise, the customer could claim damages for failure to perform the contract, unless the package travel was canceled due to force majeure. As one can see, the current regulations have improved the status of a traveler (so that it is wider than the status of customer) [17]

with a tour operator, as they have widened the range of situations that can be invoked by a traveler.

The traveler has the right to terminate the package travel contract before the start of the trip without paying any termination fee in the event of unavoidable and extraordinary circumstances occurring at the destination or its immediate vicinity which significantly affect the implementation of the package, or which significantly affect the transport of passengers to their final destination [29–31]. In the case of termination of the package travel contract due to unavoidable and extraordinary circumstances, the traveler is entitled to a full refund of any payments made for the package travel but is not entitled to any additional compensation. The tour operator makes the return within 14 days from the effective termination of the travel contract [30–32].

In an effort to save the tourism industry, a solution was enacted that came into effect on 13 March 2020. This consisted in the introduction of a specific 180-day “notice period” time for contracts terminated due to the COVID-19 pandemic (regarded as unavoidable and extraordinary circumstances). The solution aimed to give time for the industry to find possibilities in which to obtain credits and loans to refund advance payments from customers (which are required to be refunded within 14 days of the expiry of the notice period) [23]. Therefore, the tour operator can accept a customer’s contract termination notice and then, after 180 days, is able to refund any payments made by the client within 14 days. This way, the de facto effect of the refund of payments takes place within 194 days of the traveler having given a relevant statement to the tour operator [33]. Without the clear support to the sector, insurers might have been unwilling to provide indemnity, which is a necessary condition for the continuation of business in this area. This, in turn, might have resulted in business closures and the insolvency of such tour operators.

Why was this so important? Because it was in regard to the return of funds that the tour operators did not actually have, because they covered the obligatory advances with foreign contractors [23]. Advances were paid by the tour operators for the performance of services by subcontractors of travel packages. In many cases, these funds were difficult to collect, so the industry found it difficult to return them to travelers within the 14 days. In particular, this was a concern for countries of the middle east, where contractors delay the process of returning quotas to Polish tour operators and, ultimately, the cases may drag on for a long time due to the judiciaries being outside of the EU. In addition, there was difficulties associated with obtaining refunds by tour operators from subcontractors such as airlines, which were also in a difficult situation due to flight bans introduced in different EU countries by the legislation. In September 2020, there was to be an accumulation of payments to customers by tour operators, because most cancellations, which resulted in an obligation to make payments, expired within this period (tourists resigned mainly in March and April 2020) [33–35]. It was also not possible to extend the 180-day period, in September 2020, the validity of the bank and insurance guarantees of most Polish tour operators also expired [27].

### **3. Material and Methods**

This material was prepared on the basis of information prepared by the Department of Tourism of the Ministry of Sport and Tourism for the needs of parliamentary committee meetings, which will largely be the background for the solutions discussed. These enabled the Polish state to introduce unprecedented aid to the tourism industry in connection with the COVID-19 pandemic and unprecedented support for the tourism industry in the form of tourism support funds—the Travel Refund Fund and the Tourism Aid Fund. In our research, we used the method of an economic analysis of the law (i.e., the law and economics method). This is discussed in Chapter 4, where tables and graphs are presented. Graphical presentation of research results and the impact of the introduced support mechanisms on supply and demand, indicate the desirability of solutions in this area. The aid funds were presented as mechanisms for regulating and supporting the travel market. We will describe the research in this area in more detail in the next chapter, in

which we refer to our results. Other research methods that we used required the study of existing literature, of jurisprudence and of the views of the doctrine. All the methods show research investigation and a procedure scheme.

#### 4. Results

The situation presented in points 2 and 3 was postulated to be solved by measures modelled on European legal regulations. The tourism industry has postulated, e.g., the introduction of the following solutions:

- (a) direct aid to tour operators, e.g., by making it possible for them to take out preferential loans secured by the State Treasury;
- (b) state reinsurance for insurance companies issuing travel guarantees.

The achievement of both of these objectives was made possible thanks to an idea that was implemented only in Poland. This consisted in securing advance payments from customers and refunding them from public funds, allowing tour operators to repay them on preferential terms. This solution was called the Travel Refund Fund and was aimed at preventing insolvencies on the part of tour operators. Based on this solution, a tour operator would have the possibility to repay the refund made from public funds, with part of the repayment being made to an additional fund which, in the future, could be used to satisfy customer claims before declaring insolvency (as in the case of granting the repayment referred to in point a). Such a fund is cost-free for the state because, at present, tour operators are required to pay a mandatory contribution towards it. However, at the initial stage, the fund required provisioning (with a small amount from travel organizers repaying their “loans”) [24]. This solution is called the Tourism Aid Fund and is a specific type of insurer market reinsurance designed to easily calm the mood of the insurance market [25].

In March this year, the Minister of Sport and Tourism, in consultation with the Minister of Finance, for the first time launched payments from the Tourism Aid Fund to cover refunds made to travelers for their payments towards package travel that had not or would not take place due to the occurrence of unavoidable and extraordinary circumstances in the territory of Ukraine. The notification by a traveler of the cancellation of a package travel contract to be implemented in the territory of Ukraine, or the notification of a package travel contract termination by the tour operator, which justified the payment of funds from the Tourism Aid Fund, could be made between 24 February 2022 to 24 March 2022 inclusive. Requests for payments from the Tourism Aid Fund, made by a traveler or a tour operator, had to be submitted to the Insurance Guarantee Fund starting from 08 March 2022 and no later than 14 days after receiving the abovementioned notification [30,31].

The Tourist Aid Fund (TAF) is one of the solutions supporting tourism that is contained in the Act of 17 September 2020 amending the Act on special solutions related to the prevention, counteraction and combating of COVID-19, other infectious diseases and crisis situations caused by them, and some other acts (Journal of Laws of 2020, item 1639). From a technical point of view, TAF is a separate account in the Insurance Guarantee Fund. The funds accumulated therein come from, inter alia, the contributions of tour operators paid since 1 January 2021. It provides loans to tour operators in the case of cancellation of specific tourist packages in the future as a result of extraordinary and unavoidable circumstances [27].

The establishment of the Travel Refund Fund has prevented many insolvencies by stabilizing the financial situation of individual tour operators and has made it possible for them to maintain market competitiveness. It has met the aims of Directive (EU) 2015/2302 of the European Parliament and of the Council of 25 November 2015 on package travel and linked travel arrangements, amending Regulation (EC) No 2006/2004 and Directive 2011/83/EU of the European Parliament and of the Council and repealing Council Directive 90/314/EEC, which stipulated that refunds to travelers for cancelled package travel should be made by tour operators immediately. This aid measure was intended to strengthen the liquidity situation of tour operators. The Polish authorities considered it necessary to

oversee the refund obligations of tour operators and then to request their repayment at a reduced interest rate, because in many cases this would insure tour operators against insolvency [28]. It is worth pointing out that this was the only aid instrument of this type in Europe, under which the funds were reimbursed directly to the clients, not to the tour operator. In this way, the state was sure that the money was used in accordance with their intended purpose and that the aid was real. In the area of tour operators, the appropriate measure of the effectiveness of the assistance provided is the scale of declared insolvencies among entrepreneurs during the pandemic and its comparison to the number of insolvencies announced respectively in the years preceding the outbreak of the pandemic in 2020.

On 9 March 2022, this topic was considered by the Committee of Physical Culture, Sport and Tourism [30,31], chaired by Member of Parliament Jakub Rutnicki, Chairman of the Commission.

The statistics show that the overall number of insolvencies in the scale of the total number of entrepreneurs was small—fluctuating below 1% (approximately 0.2%). In addition, there were changes in the number of entrepreneurs (suspension or termination of activity, deletion from the register of tour operators and entrepreneurs who facilitating linked travel arrangements) [30,31]. The years 2020–21, despite the pandemic that significantly inhibited tourism around the world, did not cause numerous insolvencies of tour operators (Table 2). The establishment of the Tourist Refund Fund allowed for the maintenance of competitiveness within the tour operator market and prevented further socio-economic destabilization. TAF is a separate bank account managed by the Insurance Guarantee Fund. This means that the TAF cannot function as a separate unit but is formed within the organizational structure of the Insurance Guarantee Fund. TAF provides the possibility of a reimbursement of funds in connection with the occurrence of extraordinary and unavoidable circumstances, when tour operators have problems with payments to cover the reimbursement of travel expenses [30,31]. These payments apply to travel packages that were not or will not be carried out due to the announcement or the occurrence of unavoidable and extraordinary circumstances, not just related to COVID-19, on the territory of the Republic of Poland or in the place where the group trip takes place. TAF is financed by contributions from tour operators. It is worth emphasizing that the establishment of a pre-pillar i.e., the Travel Refund Fund (TRF) and of the Tourism Aid Fund (TAF) has contributed to the prevention of tour operator insolvencies and to achieving one of their lowest rates in Europe. Below are data on the number of insolvencies in 2020–2021 in a few selected countries that have implemented Directive 2015/2302.

**Table 2.** Number of insolvencies in 2020–2021 in selected European countries.

Year	Number of Insolvencies	Country
2020–2021	24 insolvencies	Czech Republic
2020–2021	18 insolvencies	Denmark
2020–2021	219 insolvencies	Romania
2020–2021	40 insolvencies	Hungary
2020–2021	24 insolvencies	Norway
2020–2021	12 insolvencies	Poland

Source: own study, based on data from the Ministry of Sport and Tourism.

Contributions to TAF are characterized by their one-sidedness and mandatory nature [29]. Using an economic analysis of the law, the distribution of the burden of paying TAF fees can be determined.

Figure 1 shows the fee's impact on demand and supply in the travel market. If we assume that curve D represents demand and curve S represents supply, and that at the starting point of the analysis the travel service is not burdened with the fee, then the balance between the travel service demand and supply is at the intersection of the curves D and S<sub>1</sub> [29]. At this point, the service price corresponds to the OP<sub>2</sub> section, and at this price the producer (seller) is willing to sell the travel service. The buyer is willing to buy the

travel service at the price corresponding to the  $O t_2$  section [29]. The equilibrium price for the producer (seller) is the net price without the fee. If the travel service is burdened with the fee corresponding to the  $P_2 P_3$  section, then the supply curve will move upwards in the chart as the fee will increase the price of this good [29]. As a result, the demand for the service will decrease by the amount corresponding to the  $t_1 t_2$  section [29]. Characteristically, however, as a consequence of the imposition of the tax, the demand and supply in the travel market decreases, which is reflected in the new equilibrium point  $t_1 P_3$ . The rectangle represents the size of the fee [29].

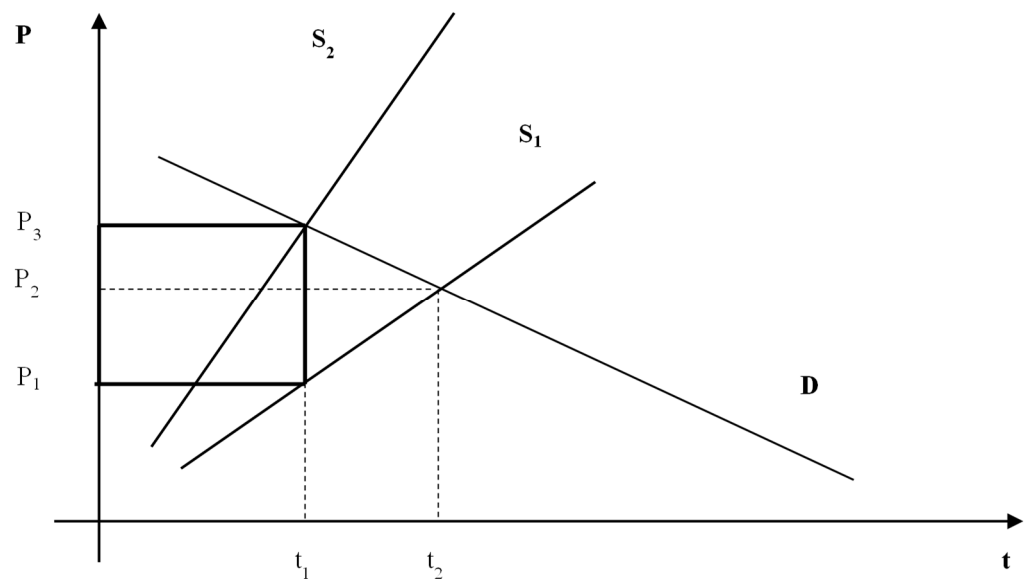

**Figure 1.** The impact of introducing TAF contribution on the travel market. Figure and description—own work, based on [29].

It seems that in the case of the analyzed insolvency protection system we also have the so-called Pareto effect [36]. According to this, 20% of travel organizers are responsible for 80% of collected TAF contributions and Travel Guarantee Fund (TGF) contributions. Thus, about 1/5 of the market can, by itself, protect 4/5 of the market against insolvency through these solidarity funds. This shows that the establishment of safeguards based largely on the industry's self-regulation is of great importance. In the case of Poland, the solutions worked well in times of the greatest recent crises. It is also worth pointing out that the number of travel organizers in Poland, which is impressive and amounts to over 4000, results in lower prices for package travels.

In the medium- and long-term perspectives, the fee will be shifted from tour operators to customers, which may result in an increase in supply [29]. The economic analysis of the law shows a regularity consisting in a decrease in the average price level along with an increase in the number of tour operators offering package travels in a given market. This is one of the key assumptions of a competitive market. According to this, an increase in the number of tour operators leads to an increase in the competition between them, this results in lower prices offered to customers [29]. This phenomenon is shown in Figure 2. An increase in the number of tour operators from  $N_1$  to  $N_2$  results in a price decrease from  $P_1$  to  $P_2$  [29]. However, the trend is not continuous as the price decrease cannot go beyond the minimum price, understood, in this case, as the minimum price that can cover the unit cost and give a minimum acceptable margin level [29]. Then the price stabilizes.

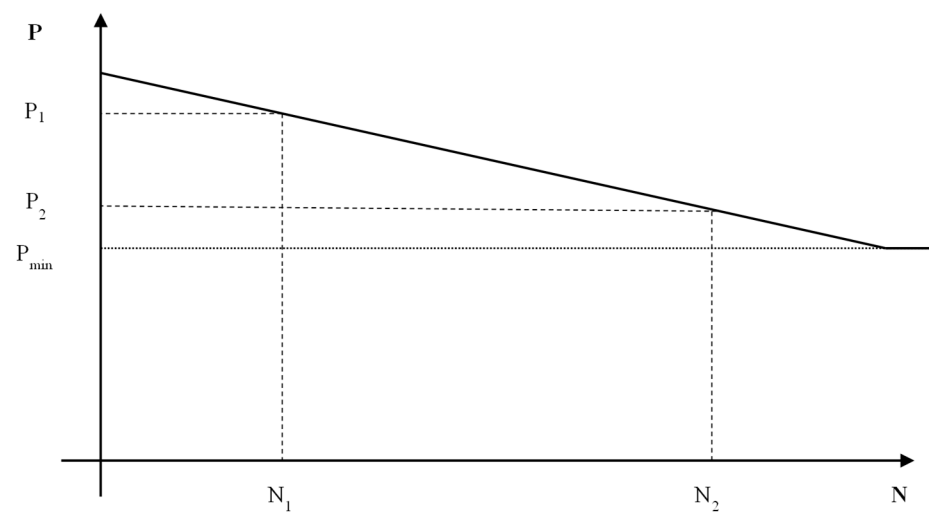

**Figure 2.** Relationship between the package travel price and the number of tour operators (travel organizers). Figure and description—own work, based on [29].

A package travel price is influenced by the number of offers in the market (the more tour operators in the market, the larger the number of offers). An increase in the number of offers leads to a decrease in prices [29]. On the other hand, a decrease in the number of offers leads to an increase in prices [29]. Thus, the fewer tour operators on the market, the less potential travel offers. Activities in the travel market, carried out by tour operators themselves, constitute a type of corporate social responsibility or a manifestation of compliance social responsibility i.e., businesses' responsibility for compliance procedures. The latter may be an element of social responsibility because the payment of fees towards the tourism support funds makes it possible to safeguard weaker entities in the market. Thus, by complying with the law, the grey market is eliminated, and healthy competition is supported. As Makowicz points out, transparent structures and positive company image building, as well as compliance with the regulations, generate trust and impact their rating, which also strengthens the position of the travel market itself [37,38]. The compliance with the adopted standards of conduct translates, in practice, into effective risk management [37,38]. This, as indicated in this article, is of particular importance in cases of extraordinary and unavoidable circumstances or so-called force majeure.

## 5. Discussion

According to regulatory theory, the public sector plays a complementary role to the market in the economy and its main task in this area is to improve the coordination function. Regulation can contribute to the formation of new markets by creating the necessary institutions, promoting competition and protecting consumers' interests, reducing the level of concentration of production and capital [39]. Balcerzak and Pietrzak [40] emphasize the role of the institutional system in the process of shaping the productivity of economies. The authors consider this particularly important in terms of the effectiveness of regulations aimed at supporting entrepreneurship, legal institutions that help keep transaction costs low and maintain a high efficiency of the market mechanism, competitiveness of the environment, and the efficiency of labor markets and financial market institutions. However, it should also be considered a leveling market failure.

However, in the current situation of the tourism market, the key task of the institutional system should be to reduce the failure of the market, primarily caused by random factors—the pandemic and the war—and, secondarily, by economic factors—a limiting of economic activity, interruption of supply chains, economic slowdown and recession [41].

The Polish government's efforts to address the negative effects of the pandemic on sectors particularly vulnerable to its effects, including tourism industries, have included

exemption from social security contributions, standstill benefits, and the Tourism Refund Fund Tourism Aid funds [42].

However, research by Wong and Lai [43] clearly shows that the effectiveness of governments' efforts to accelerate the post-COVID-19 tourism recovery is largely dependent on parallel actions related to corporate social responsibility (CSR). The support of local communities in the process of managing change has been considered crucial in this area. However, in order to achieve this, governments must take measures to increase public confidence and, in this case, the responsiveness of public authority actions and access to reliable information are particularly important.

Corbet and colleagues [44], point to the importance of support schemes aimed at reducing the risk of insolvency of tour operators. Fiscal instruments, in the form of special assistant programs of a loan nature and information instruments, were considered particularly important.

Rogerson and Baum [45] indicate the main directions of actions to mitigate the effects of the pandemic on the tourism sector in Africa. They propose actions aimed, among others, at increasing confidence in the market, supporting international tourism and increasing the resilience of domestic tourism entities, especially small- and medium-sized enterprises of a regional nature.

Joo and associates [46] also made an interesting observation in their work. In their research, they noted the high uncertainty of local communities related to the fear of being infected with the coronavirus by tourists. It was found that risk perceived by residents was negatively correlated with emotional solidarity and support for tourism, while emotional solidarity had a positive effect on support for tourism.

Additionally, the results of Kamat's research [47] indicate that residents usually understand the important role of tourism for their region and want to support it. However, respondents were faced with a dilemma between hosting tourists to help rebuild the economy and personal fears that contact with tourists would increase their chance of infection. Practical conclusions resulting from the conducted research indicate the great importance of government and local government activities that must understand and adequately respond to these concerns. In this case, the quality of information and communication was considered crucial for shaping a positive attitude of residents towards tourists.

## 6. Conclusions

The European Commission, while accepting both aid instruments, concluded that these measures are necessary, appropriate and proportionate to remedying a serious disturbance in the economy of a member state in accordance with Art. 107 paragraph. 3 lit. b) of the Treaty on the Functioning of the European Union (TFEU) [18], as they fulfill all the relevant conditions of the temporary aid framework (which expired 30 June 2022) [21,22].

The Travel Refund Fund, as a tool for the future and not directly related to the COVID-19 pandemic, was not subject to notification [19] but was described in the EC decision and is an instrument inextricably linked to instalment repayments by tour operators because the "interest" for using this source was paid precisely to that account, so that in the future these funds can be used to launch aid in situations similar to those of the global pandemic. Unfortunately, there was only a short wait before the fund was utilized as the situation in Ukraine in February 2022 led to the declaration of unavoidable and extraordinary circumstances, providing a basis for massive cancellations of package travel there. The use of tourism support funds is related to instruments which, due to their characteristics, constitute an element of corporate social responsibility. Such activity supports the market and enables solidarity of the legally operating tourism industry. Therefore, CSR tools should be recommended as potential measures to reduce the negative effects of crisis phenomena in tourism. It is difficult to compare our project and results with the results of similar research conducted on this subject in other parts of Europe and the world, because, as indicated, there is a lack of scientific dialogue in this area. Poland, as a pioneer, tries to

present these issues on the international forum. Thanks to the possibility of publication in the journal, we hope to expand the dialogue in this area.

**Author Contributions:** Conceptualization, D.B. and D.P.; methodology, D.B.; software, D.P.; validation, D.B. and D.P.; formal analysis, D.P.; investigation, D.B.; resources, D.B.; data curation, D.P.; writing—original draft preparation, D.B. and D.P.; writing—review and editing, D.B. and D.P.; visualization, D.P.; supervision, D.B. All authors have read and agreed to the published version of the manuscript.

**Funding:** This research received no external funding.

**Institutional Review Board Statement:** Not applicable.

**Informed Consent Statement:** Not applicable.

**Data Availability Statement:** Not applicable.

**Conflicts of Interest:** The authors declare no conflict of interest.

## References

- Lu, J.; Xiao, X.; Xu, Z.; Wang, C.; Zhang, M.; Zhou, Y. The potential of virtual tourism in the recovery of tourism industry during the COVID-19 pandemic. *Curr. Issues Tour.* **2022**, *25*, 441–457. [CrossRef]
- Škarea, M.; Soriano, D.; Porada-Rochoń, M. Impact of COVID-19 on the travel and tourism industry. *Technol. Forecast. Soc. Chang.* **2021**, *63*, 120469. [CrossRef] [PubMed]
- Lee-Peng, F.; Mui-Yin, C.; Kim-Leng, T.; Kit-Teng, P. The impact of COVID-19 on tourism industry in Malaysia. *Curr. Issues Tour.* **2021**, *24*, 2735–2739.
- Rogerson, C.; Rogerson, J. COVID-19 and changing tourism demand: Research review and policy implications for South Africa. *Afr. J. Hosp. Tour. Leis.* **2021**, *10*, 1–21. [CrossRef]
- Ntounis, N.; Parker, C.; Skinner, S.; Steadman, C.; Warnaby, G. Tourism and Hospitality industry resilience during the COVID-19 pandemic: Evidence from England. *Curr. Issues Tour.* **2022**, *25*, 46–59. [CrossRef]
- Balli, F.; Billah, M.; Chowdhury, I. Impact of the Russia–Ukraine war on hospitality equity markets. *Tour. Econ.* **2022**. online first. [CrossRef]
- Le, D.; Phi, G. Strategic responses of the hotel sector to COVID-19: Toward a refined pandemic crisis management framework. *Int. J. Hosp. Manag.* **2021**, *94*, 102808. [CrossRef]
- Fabiyani, N.; Sudiro, A.; Moko, W.; Soelton, M. Conceptualizing the Role of Work Engagement: A Case Study of the Hotel Sector in Surabaya during the COVID-19. *J. Asian Financ. Econ. Bus.* **2021**, *8*, 485–494.
- Garrido-Moreno, A.; García-Morales, V.; Martín-Rojas, R. Going beyond the curve: Strategic measures to recover hotel activity in times of COVID-19. *Int. J. Hosp. Manag.* **2021**, *96*, 102928. [CrossRef]
- Salem, I.; Elbaz, A.; Elkhwesky, Z.; Ghazi, K. The COVID-19 pandemic: The mitigating role of government and hotel support of hotel employees in Egypt. *Tour. Manag.* **2021**, *85*, 104305. [CrossRef]
- Anguera-Torrell, O.; Aznar-Alarcón, J.; Vives-Perez, J. COVID-19: Hotel industry response to the pandemic evolution and to the public sector economic measures. *Tour. Recreat. Res.* **2021**, *46*, 148–157. [CrossRef]
- Johann, M. CSR Strategy in Tourism during the COVID-19 Pandemic. *Sustainability* **2022**, *14*, 3773. [CrossRef]
- Lee, S. Corporate social responsibility and COVID-19: Research implications. *Tour. Econ.* **2022**, *28*, 863–869. [CrossRef]
- Yeon, J.; Song, H.; Yu, H.; Vaughan, Y.; Lee, S. Are socially responsible firms in the U.S. tourism and hospitality industry better off during COVID-19? *Tour. Manag.* **2021**, *85*, 104321. [CrossRef]
- Mao, Y.; He, J.; Morrison, A.; Coca-Stefaniak, J. Effects of tourism CSR on employee psychological capital in the COVID-19 crisis: From the perspective of conservation of resources theory. *Curr. Issues Tour.* **2021**, *24*, 2716–2734. [CrossRef]
- Sobhani, P.; Veisi, H.; Esmailzadeh, H.; Sadeghi, S.M.M.; Marcu, M.V.; Wolf, I.D. Tracing the Impact Pathways of COVID-19 on Tourism and Developing Strategies for Resilience and Adaptation in Iran. *Sustainability* **2022**, *14*, 5508. [CrossRef]
- Vieweg, K. The restrictions of European law. In *Professional Sport in EU: Regulation and Re-Regulation*; Caiger, A., Gardiner, S., Eds.; T.M.C. Asser Press: The Hague, The Netherlands, 2000.
- Wali, A. The theory of the sport law: Towards specific legislation for sports transaction. In *Sports Law: 15th IASL Congress Proceedings*; Foks, J., Ed.; International Association of Sports Law: Warsaw, Poland, 2010.
- Gandert, D. Puerta: Applying the Principles of Justice to the World Anti-Doping Code. In *Sports Law: 15th IASL Congress Proceedings*; Foks, J., Ed.; International Association of Sports Law: Warsaw, Poland, 2010.
- Góralski, W.M.; Kardaś, S. *The European Union. Origins-Structure-Acquis*; Wolters Kluwer Polska: Warsaw, Poland, 2008.
- Borek, D. The decision of the European Commission State Aid SA.101979 (2022/N)—A word of commentary, opinion and conclusions. *Zesz. Nauk. Wyższej Szkoły Gospod. W Bydgoszczu* **2022**, *37*, 11–19.
- Borek, D. Przedsiębiorca w ustawie o imprezach turystycznych i powiązanych usługach turystycznych—Koncepcja przedmiotowego charakteru regulacji. *Internetowy Kwart. Antymonopol. I Regul. UW* **2018**, *4*, 23–35.



23. Borek, D.; Zawistowska, H. (Eds.) *Komentarz do Ustawy o Imprezach Turystycznych i Powiązanych Usługach Turystycznych*; ODDK: Gdańsk, Poland, 2020.
24. Borek, D.; Świtaj, K.; Zawistowska, H. O zgodności z prawem UE regulacji art. 15k ustawy o szczególnych rozwiązaniach związanych z zapobieganiem, przeciwdziałaniem i zwalczaniem COVID-19, innych chorób zakaźnych oraz wywołanych nimi sytuacji kryzysowych oraz niektórych innych ustaw. In *Prawo-Narzędzie Sprawiedliwości Czy Władzy?* Barwicka-Tylek, I., Dziewałtowski-Gintowt, P., Zyzik, K., Łyżwa, Ł., Eds.; Uniwersytetu Jagiellońskiego: Kraków, Poland, 2020.
25. Borek, D.; Zawistowska, H. (Eds.) *Prawo Turystyki, Podręcznik*; ODDK: Gdańsk, Poland, 2021.
26. Borek, D. Turystyczny Fundusz Pomocowy uspokoi również rynek ubezpieczycieli. *Dz. Gaz. Prawna* **2020**, *10*. Available online: <https://serwis.gazetaprawna.pl/turystyka/artykuly/1492991,fundusz-katastrof-rynek-ubezpieczycieli.html> (accessed on 1 January 2022).
27. Borek, D.; Sztandera, A. Turystyka na rozdrożu. *Wiadomości Tur.* **2021**, *10*. Available online: [https://www.google.com.hk/url?sa=t&rct=j&q=&esrc=s&source=web&cd=&cad=rja&uact=8&ved=2ahUKEwjFrtPsh-z8AhWGPXAKHUiCrEQFnoECAkQAQ&url=https%3A%2F%2Fwstih.pl%2Fwp-content%2Fuploads%2F2021%2F10%2FWT\\_10\\_2021\\_lekki.pdf&usg=AOvVaw1b3OrXwJyRrP9DpWhr-si](https://www.google.com.hk/url?sa=t&rct=j&q=&esrc=s&source=web&cd=&cad=rja&uact=8&ved=2ahUKEwjFrtPsh-z8AhWGPXAKHUiCrEQFnoECAkQAQ&url=https%3A%2F%2Fwstih.pl%2Fwp-content%2Fuploads%2F2021%2F10%2FWT_10_2021_lekki.pdf&usg=AOvVaw1b3OrXwJyRrP9DpWhr-si) (accessed on 1 January 2022).
28. Borek, D. Konsekwencje niewypłacalności Thomasa Cooka dla angielskiej Premiership. In *Prawne i Praktyczne Aspekty Turystyki i Rekreacji*; Płonka-Bielenin, K., Wolski, D., Eds.; Arterior: Katowice, Poland, 2021.
29. Buława, P.; Szmit, K. *Ekonomiczna Analiza Prawa*; Wolters Kluwer Polska: Warsaw, Poland, 2012.
30. *Informacja Ministra Sportu i Turystyki na Temat: Ocena Funkcjonowania Ustawy z Dnia 24 Listopada 2017 r. o Imprezach Turystycznych i Powiązanych usługach Turystycznych*; Komisja Kultury Fizycznej, Sportu i Turystyki: Warsaw, Poland, 2022.
31. *Informacja Ministra Sportu i Turystyki na Temat: Pomoc Dla Przedsiębiorstw Turystycznych ze Strefy Przygranicznej, Objętej Zakazem Przebywania w Związku z Kryzysem na Granicy Polsko-Białoruskiej, w Szczególności w Zakresie Pomocy Poza Limitem de Minimis*; Podkomisja stała do spraw turystyki Komisji Kultury Fizycznej, Sportu i Turystyki: Warsaw, Poland, 2022.
32. Marak, K. Regulacje prawne wprowadzone w celu przeciwdziałania skutkom epidemii wirusa SARS-CoV-2 w zakresie wykonania umów o udział w imprezie turystycznej oraz skutki tych regulacji dla organizatorów turystyki i podróżnych. *Iustitia* **2020**, *4*, 201–210.
33. Maszewski, Ł. Charakter prawny formy reglamentacji dostępu do działalności w zakresie organizowania imprez turystycznych w prawie polskim. *Przegląd Ustawodawstwa Gospod.* **2021**, *8*, 48–55. [CrossRef]
34. Raciborski, J. Ochrona konsumenta w odniesieniu do umów o powiązane usługi turystyczne w rozumieniu dyrektywy Parlamentu Europejskiego i Rady (UE) 2015/2302. *Probl. Transp. Logistyki* **2017**, *4*, 111–119. [CrossRef]
35. Szmak, K.; Szmak, S. Odroczenie skuteczności odstąpienia od umowy o udział w imprezie turystycznej—Regulacja art. 15k ustawy COVID 19 w świetle dyrektywy 2015 2302. *Transform. Prawa Prywat.* **2021**, *3*, 85–99.
36. Zasada Pareto. Available online: [https://mfiles.pl/pl/index.php/Zasada\\_Pareto](https://mfiles.pl/pl/index.php/Zasada_Pareto) (accessed on 1 January 2022).
37. Kanclerz, K.; Tomanek, B.; Nicińska-Chudy, A.; Bodziony, M. *Przewodnik po HR Compliance*; Infor Biznes: Warsaw, Poland, 2021.
38. Makowicz, B. *Compliance w Przedsiębiorstwie*; Wolters Kluwer Polska: Warsaw, Poland, 2011.
39. Puciato, D. Zamówienie publiczne jako kontrakt w relacji pryncypał-agent. *Ruch Praw. Ekon. Socjol.* **2018**, *80*, 167–180. [CrossRef]
40. Balcerzak, A.; Pietrzak, M. Efektywność instytucjonalna krajów Unii Europejskiej. *Ekonomista* **2016**, *3*, 312–337.
41. Puciato, D. Niedoskonałości rynku w opinii menedżerów hoteli z województw dolnośląskiego i opolskiego. *Pr. Nauk. Uniw. Ekon. We Wrocławiu* **2022**, *66*, 117–129. [CrossRef]
42. Staszewska, A. Zarządzanie kryzysem w turystyce podczas pandemii COVID-19. *Zesz. Nauk. Wydziału Zarządzania GWSH* **2022**, *17*, 100–109.
43. Wong, J.; Lai, I. The mechanism influencing the residents' support of the government policy for accelerating tourism recovery under COVID-19. *J. Hosp. Tour. Manag.* **2022**, *52*, 219–227. [CrossRef]
44. Corbet, S.; Hou, Y.; Hub, Y.; Oxley, L. Did COVID-19 tourism sector supports alleviate investor fear? *Ann. Tour. Res.* **2022**, *95*, 103434. [CrossRef]
45. Rogerson, C.; Baum, T. COVID-19 and African tourism research agendas. *Dev. South. Afr.* **2020**, *37*, 727–741. [CrossRef]
46. Joo, D.; Xu, W.; Lee, W.; Lee, C.; Woosnam, K. Residents' perceived risk, emotional solidarity, and support for tourism amidst the COVID-19 pandemic. *J. Destin. Mark. Manag.* **2021**, *19*, 100553. [CrossRef]
47. Kamata, H. Tourist destination residents' attitudes towards tourism during and after the COVID-19 pandemic. *Curr. Issues Tour.* **2022**, *25*, 233882204. [CrossRef]

**Disclaimer/Publisher's Note:** The statements, opinions and data contained in all publications are solely those of the individual author(s) and contributor(s) and not of MDPI and/or the editor(s). MDPI and/or the editor(s) disclaim responsibility for any injury to people or property resulting from any ideas, methods, instructions or products referred to in the content.

## Article

# The COVID-19 Pandemic and Tourists' Risk Perceptions: Tourism Policies' Mediating Role in Sustainable and Resilient Recovery in the New Normal

Shiqi Zhang<sup>1</sup>, Tianwei Sun<sup>2</sup> and Yuan Lu<sup>2,\*</sup><sup>1</sup> HNU-ASU Joint International Tourism College, Hainan University, Haikou 570228, China<sup>2</sup> School of Economics, Hainan University, Haikou 570228, China

\* Correspondence: luyuan\_vip@outlook.com

**Abstract:** The COVID-19 health crisis has had unprecedented impacts on the global tourism industry, creating a sense of insecurity among tourists about destinations. Thus, rebuilding tourists' confidence in the tourism industry is the biggest challenge faced by policymakers in the new normal. The tourism industry needs innovative solutions for sustainable recovery, but limited literature is available on the tourism policies necessary for sustainable and resilient recovery in the new normal. This study investigated the impact of COVID-19 and risk perception on the recovery of tourism. Moreover, this study also explored the mediating role of attitudes toward tourism policies between COVID-19, risk perceptions, and tourism recovery. Data collected from 1437 tourists through an online survey were analyzed using PLS-SEM and descriptive statistics. The results showed that a large majority of the tourists still felt unsafe and insecure about tourism destinations. COVID-19 risk perceptions were found to be negatively associated with tourism recovery in the new normal. Risk perceptions had a significant positive impact on transportation selection behavior ( $\beta = 0.725, p < 0.01$ ), as did avoiding overcrowded places ( $\beta = 0.692, p < 0.01$ ). Transportation selection behaviors also had a statistically significant negative impact on the recovery of tourism ( $\beta = -0.220, p < 0.01$ ). The findings showed that attitudes toward tourism policies mediated the effect between COVID-19 and tourism intentions. This study has important policy implications for the sustainable recovery of the tourism industry and for making it resilient against future crises.

**Keywords:** sustainable tourism; tourism industry; sustainable recovery; COVID-19; health crisis

**Citation:** Zhang, S.; Sun, T.; Lu, Y. The COVID-19 Pandemic and Tourists' Risk Perceptions: Tourism Policies' Mediating Role in Sustainable and Resilient Recovery in the New Normal. *Sustainability* **2023**, *15*, 1323. <https://doi.org/10.3390/su15021323>

Academic Editors: Zygmunt Kruczek and Bartłomiej Walas

Received: 5 December 2022

Revised: 28 December 2022

Accepted: 5 January 2023

Published: 10 January 2023



**Copyright:** © 2023 by the authors. Licensee MDPI, Basel, Switzerland. This article is an open access article distributed under the terms and conditions of the Creative Commons Attribution (CC BY) license (<https://creativecommons.org/licenses/by/4.0/>).

## 1. Introduction

The COVID-19 pandemic has devastated the world economy and also caused unprecedented upheavals in the world tourism industry. Tourist mobility decreased by 80%, and millions of workers from around the world became unemployed during COVID-19 [1,2]. Moreover, the tourism sector might not recover fully until 2023, and the world economy may face a loss of USD 3–8 trillion due to the COVID-19 pandemic's effects on the tourism industry [3]. COVID-19 has changed the tourism sector through different public health measures (border closures, quarantines, COVID-19 testing, social distancing, and mandatory face masks). In the new normal, the sustainability of the tourism sector is dependent on health and safety perceptions of tourism destinations [4,5]. The risk perceptions of tourists are considered one of the primary determinants of decision making and tourism intentions [6]. Real risk and risk perceptions are different from each other: Real risks are usually characterized by uncertainty about the potential effects of an activity and the likelihood of the outcomes in question [7]. On the other hand, an individual's perceptions of risks are based on their own judgments, attitudes, experiences, and feelings. These perceptions are affected by different sociocultural and contextual factors [8]. Thus, despite the presence of minimal real risks, perceived risks can influence potential tourists' tourism-

related behaviors and intentions [9]. Kozak et al. [10] described risk as a primary concern for tourists.

Travel risk perceptions and tourist flows have been extensively discussed in tourism research for the survival and sustainability of the tourism sector in the new normal [11]. Tourists' risk perceptions are influenced by a number of factors, such as age, gender, cognitive traits, and previous learning [4]. Similarly, tourist flow is a multifaceted, dynamic system that is influenced by a number of elements related to tourists and tourism destinations [12]. Therefore, it is very important for tourism marketers to understand all of these factors in order to devise effective marketing policies for the sustainable recovery of the tourism industry in the new normal. A major part of the prior literature has explored the factors related to destinations, but the factors affecting potential tourists' intentions for tourism in the new normal have been insufficiently discussed [13,14]. COVID-19 has significantly affected human mobility as well as leisure activities, and, therefore, previous suppositions in regard to travel risks have limitations in the new normal [5,15,16]. This indicates that information about tourism from previous studies needs to be further looked into in light of COVID-19 and the new normal market conditions.

Undoubtedly, potential tourists may perceive different risks, limiting their travel and leisure activities in the new normal because the COVID-19 pandemic is not over yet. The future of the tourism sector looks uncertain amid an ongoing pandemic and recovery from it, and the sustainability of the industry is dependent on the recovery measures taken at tourism destinations [2]. The tourism industry is in a recovery phase, and it is very important that tourism marketers advertise and publicize these measures and efforts to inform and decrease the risks perceived by individuals for tourism recovery amid the COVID-19 pandemic. The role of social media in travel- and leisure-related decision making has been widely discussed in the prior literature and can be effectively used for advertising tourism recovery policies in addition to affecting tourism risk perceptions [13,17]. The tourism industry is ready to use social media because it has mostly depended on a place's reputation, consumer opinions, the spread of information, and good word-of-mouth advertising. The tourism industry is a good fit for social media platforms because it has always relied heavily on word-of-mouth marketing, customer feedback, the reputation of a destination, and the spread of information [18]. Therefore, the impact of risk perceptions and attitudes toward tourism policies should be discussed for the purpose of the recovery of tourism in the new normal.

A number of previous studies have discussed the interplay between travel risk perceptions and tourism intentions [19–21]; however, none of these studies explored the role of attitudes toward tourism policies in risk perceptions and travel intentions in the new normal. Additionally, how the behaviors and attitudes of individuals toward transportation, health and safety measures, and the overcrowding of tourists at destinations affect their tourism intentions in the new normal needs to be examined, especially in emerging markets. Matiza and Kruger [22] contend that it is vital to investigate COVID-19-linked perceived risk and travel behaviors in various locations and nations for the purposes of post-crisis communication and commercial promotion. Moreover, the outbreak has increased the importance of effective travel policies in affecting tourists' intentions in the new normal.

To fill in the gap in the literature, this study aims to investigate the interplay among perceived risks, attitudes toward tourism policies, and the tourism intentions of individuals in the new normal. How do perceived risks influence tourists' intentions? How do perceived risks affect individuals' behaviors toward transportation, hygiene, and safety in the new normal? Additionally, how do transportation, hygiene, and safety behaviors affect tourists' intentions? Another valid question was whether attitudes toward tourism policies mediate the relationship between COVID-19 or perceived risks and tourism intentions. This research will help tourism authorities, tourism promotion agencies, and related businesses better understand how tourists make travel decisions in the new normal in the world.

## 2. Literature Review and Hypotheses Development

Governments worldwide imposed different non-pharmaceutical measures to curb the spread of the pandemic according to their own visions [23]. Peoples' domestic and international mobility was restricted in order to reduce the risk of COVID-19 transmission from person to person in the absence of pharmaceutical interventions [24]. This had an impact on peoples' social lives as well as leisure activities all over the world [25]. Tourists prefer comprehensive tourism packages, security, and safety when they travel to popular destinations. The non-pharmaceutical measures imposed worldwide to control the pandemic also created panic, anxiety, and stress among individuals, creating concerns about their safety and security at tourist destinations [26]. As a result, tourists began to avoid risk and limited their travel to congested areas [27]. Therefore, the following hypothesis can be made:

**Hypothesis H1:** COVID-19 negatively influences the tourism intentions of individuals in the new normal.

The perception of risk is based on a subjective assessment associated with a threatening situation and its severity [28,29]. As a result, risk perceptions in tourism are strongly linked to evaluations of situations used to make travel decisions, as well as the purchasing and consumption of travel products [30]. Risk perception is the starting point for the evaluation of a crisis' impact on the tourism industry [31]. Natural disasters, health concerns, hygiene, and diseases affect perceptions of risk when traveling to popular destinations [32,33]. Thus, following hypotheses are given below:

**Hypothesis H2:** COVID-19 positively affects individuals' perceptions of risk in the new normal.

**Hypothesis H3:** Risk perceptions negatively impact the tourism intentions of individuals in the new normal.

Individuals' transportation behaviors are influenced by their COVID-19 risk perceptions. The majority of individuals avoid using public transportation and visiting crowded tourism destinations. COVID-19 decreased the use of public transport, lowered shared mobility [34], and increased the use of private transportation [35]. The perception of risk has a significant impact on tourists' decision-making processes regarding transportation patterns. This is one of the primary reasons for people changing their travel habits during COVID-19 [36]. Although changing transportation patterns is very difficult, especially in public and crowded areas of a country, the availability of different transportation options allows tourists to make efficient decisions regarding modes of travel toward their destinations [27]. Using public transportation increases the risk of contracting COVID-19 [37]. The following hypothesis is proposed regarding transportation patterns:

**Hypothesis H4:** In the new normal, risk perceptions have a significant impact on transportation behaviors.

COVID-19 risk perceptions also affect tourist behaviors towards crowded destinations, as do hygiene, safety, and security at tourism destinations. Individuals that perceive high levels of risk in crowded places are less likely to visit crowded destinations because COVID-19 is not over yet. One of the most important defenses against COVID-19 virus infection is consistent and appropriate hand cleanliness. Similarly, an individual who perceives a higher level of risk due to COVID-19 is more likely to adopt hygienic behaviors. Savadori and Lauriola [38] described risk perception as being one of the most important determinants of protective behaviors in individuals. They further explained that hygiene and cleaning were prompted by a negative attitude toward the pandemic. Nazneen et al. [39] also described

risk perception as an important factor in determining the hygiene and safety behaviors of individuals during the pandemic. Abdelrahman [40] also pronounced that COVID-19 risk perceptions affect hygienic behaviors and visits to crowded places. Moreover, people are more likely to become infected during the pandemic in densely populated megacities that are much more internationalized and have a lot of connections with other places around the world. This is because of the high infection rates in these places. The pandemic trend, policies put in place, lockdown time, and features of other cities are all different, which could lead to different and complicated effects on tourism behaviors around the world. Therefore, this study also hypothesizes the following:

**Hypothesis H5:** In the new normal, risk perceptions have a significant impact on the touristic behaviors of individuals toward crowded destinations.

**Hypothesis H6:** Individuals' hygiene and safety behaviors are significantly influenced by their risk perceptions.

Khadaroo and Seetanah [41] contend that the transportation infrastructure at touristic destinations is a factor in their attractiveness to tourists. Improved transportation infrastructure not only saves time but also reduces costs of transportation. COVID-19 has affected every sector of the economy worldwide, and transportation is no exception. In particular, COVID-19 badly impacted global public transport ridership and service provision [42]. Public transport vehicles are narrowly spaced and can be a source of COVID-19 transmission [43]. Tian et al. [44] also described people's decreased use of public transport during COVID-19. During a pandemic, it is important to know how tourists see risks in order to understand how they make decisions, predict future tourism needs, and come up with the best recovery plans. Therefore, this study hypothesizes the following:

**Hypothesis H7:** Avoidance behaviors on public transport negatively affects the tourism intentions of individuals in the new normal.

Eichelberger and Heigl [45], in addition to Sung et al. [46], have also pointed out the change in travelers' preferences towards tourism destinations in the new normal. Tourists avoid overcrowded tourist destinations due to the contagious nature of the COVID-19 pandemic [47]. This research hypothesizes the following:

**Hypothesis H8:** Avoidance of crowded destinations is expected to have a negative impact on tourism intentions in the new normal.

Jovanovi et al. [48] described that health and hygiene are ways to keep the public healthy, make tourists feel safer, and make tourism destinations more competitive. COVID-19 has revamped the tourism and hospitality industries. Konak [49] explained that perceptions of hygiene and safety increase travel anxiety in regard to the pandemic, which is likely to affect the tourism intentions of individuals. Health and hygiene are also important for keeping the public healthy and making tourists feel safer [50]. This study hypothesizes the following:

**Hypothesis H9:** Individuals' hygiene and safety behaviors have a significant impact on their tourism intentions.

Tourism marketers are also adopting different measures (discounts, insurance, free COVID-19 testing, free mask distribution, and the utilization of social media for publicizing marketing) to encourage individuals, revive the tourism industry, and minimize the impacts of COVID-19 on tourism. Thus, the profound effect of COVID-19 has revamped and transformed the tourism industry worldwide [51], in addition to forcing tourism stakeholders to change their marketing strategies. Therefore, we assume the following:

**Hypothesis H10:** COVID-19 significantly affects attitudes toward tourism policies in the new normal.

**Hypothesis H11:** Risk perceptions significantly influence attitudes toward tourism policies in the new normal.

COVID-19 has created significant perceptions of health risks among individuals at tourism destinations. The likelihood of contracting COVID-19 and its associated expenditures are the biggest concerns for travelers during the pandemic [52]; therefore, insurance, free mask distribution, and free quarantine in the case of COVID-19 infection can be effective strategies with which to revive the tourism industry in the new normal. A price discount is a very common way to induce people to buy something, giving them something extra that makes them want to make a purchase immediately [53]. Yusnita et al. [52] described the fact that discounts have a significant relationship with buying behaviors. Similarly, Alkatiri et al. [54] stated that advertising policies have positive effects on the buying attitudes of individuals. Tourist attitudes have received increased attention in tourism academia since the 1970s [55]. Prior research has examined what products or services people like, what makes them buy them, and how they act around others [56]. Tourists' positive attitudes increase the possibility of purchasing or visiting and also influence tourists' intentions. Huh [57] investigated the effects of attitude, including its mediating effect on behavioral intentions. Zhu and Deng [58] also examined the mediating effect of attitude toward tourism intentions and reported a positive relationship between attitude and tourism intentions. In light of the above discussion, this study assumes the following:

**Hypothesis H12:** Attitudes toward tourism policies significantly affect tourism intentions in the new normal.

**Hypothesis H13:** Attitudes toward tourism policies significantly affect transportation behaviors in the new normal.

**Hypothesis H14:** Attitudes toward tourism policies significantly affect behavior toward overcrowded places in the new normal.

**Hypothesis H15:** Attitudes toward tourism policies significantly affect hygiene and safety in the new normal.

**Hypothesis H16:** Attitudes toward tourism policies mediate a positive role between COVID-19 and tourism intentions in the new normal.

**Hypothesis H17:** Attitudes toward tourism policies mediate a positive relationship between risk perceptions and tourism intentions in the new normal.

Similarly, the other hypotheses (H16c–H16e) that were tested in this study were the mediating relationship of attitude toward tourism policies with the avoidance of public transport, the avoidance of crowded destinations, and hygiene as well as safety behaviors. The conceptual framework is shown in Figure 1.

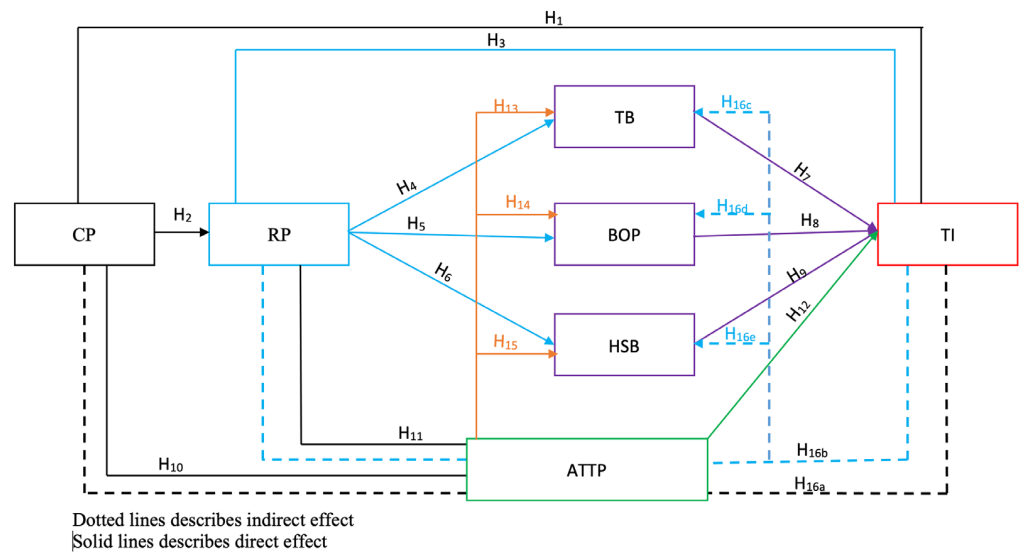

**Figure 1.** Conceptual framework.

### 3. Materials and Methods

#### 3.1. Data Collection and Questionnaire Design

Data were collected through a well-designed data collection instrument from 23 May to 30 June 2022, through an online survey. The link to the online survey was shared on different tourism-related pages on Facebook, Twitter, WeChat, and Instagram. Researchers also obtained email addresses from LinkedIn with which they could share the survey link with respondents. Moreover, the survey link was also shared with the researchers' contacts on WhatsApp. Respondents could complete the online survey on their phones, laptops, and computers. The respondents were informed about the purpose of the study, and after obtaining their consent to participate the link directed them towards the data collection instrument. Moreover, the respondents had the choice to leave the survey at any time. At the end of the survey, data were collected from 1858 respondents, but the data were used for an analysis of only those respondents who had previously traveled domestically or internationally. Moreover, the data of respondents who mentioned their intentions to tour in the "new normal" were also used for an analysis in this study. Respondents that did not intending to tour in the future were excluded from the data analysis. As a result, the data from 1437 respondents were used for further analyses.

A well-designed data collection instrument comprising different sections was used to collect data from the tourists. Using Churchill's [59] work as a guide, the measurement items in this study were taken from or changed from those in previous tourism research studies. The first section of the data collection contained questions related to the backgrounds of the tourists. The second section of the data collection instrument contained queries related to the tourists' perceptions of risk. The third section of the questionnaire consisted of questions aimed at measuring the behaviors of tourists toward public transport, crowded tourist destinations, hygiene, and safety. The fourth section of the questionnaire comprised statements aimed at measuring the tourists' responses toward tourism policies. The last part of the survey instrument consisted of questions aimed at measuring the intentions of tourists toward touring in the new normal. Except for those in Section 1, all of the questions were asked on a 5-point Likert scale. The questionnaire was pretested with 30 tourists before the final data collection survey to ensure the reliability of the survey instruments. The preliminary study assisted in adjusting some questionnaire statements for better understanding based on the responses of the preliminary study tourists.

### 3.2. Statistical Methods

The study used different descriptive statistics for the data analysis that resulted from a cross-sectional survey of the tourists. Moreover, the research also utilized partial least-squares structural equation modeling (PLS-SEM) to test the hypotheses developed in the above section. Prior literature on PLS-SEM describes 100 as the minimum sample size with which to apply this statistical method for unbiased results [60]. Furthermore, both the “ten times rule” and G\*Power, indicated by Hair et al. [61], reflected the adequacy of this study’s sample size for PLS-SEM. This paper mostly used the method of analysis suggested by Hair et al. [61]. There are two steps to the PLS method: a measurement model and a structural model [62]. This being the case, the measurement model and the structural measurement model need to be set up in order to test the hypothesis.

## 4. Results

### 4.1. Backgrounds of the Tourists

Table 1 presents the different socioeconomic characteristics of the sampled tourists. More than half of the tourists who took part were between the ages of 30 and 60, with nearly one-fourth being under the age of 30. The number of male tourists participating in this study was slightly larger than that of female tourists. More than two-fifths of the tourists had more than 12 years of education. The majority of the tourists participating in this research were Europeans. More married tourists participated in this survey than unmarried tourists. The percentage of tourists in the high-income group was higher compared to that of the low- and medium-income groups. The number of domestic tourists participating in this survey was greater than those who traveled abroad for tourism purposes.

**Table 1.** Backgrounds of the tourists.

Tourist Characteristics	Percentage
Age (Years)	
<30	23.41
30–60	52.25
>60	24.34
Gender	
Male	51.94
Female	48.06
Education (Years)	
<8	9.25
8–12	30.40
>12	60.65
Ethnicity	
Europeans	55.65
Asians	12.65
Africans	7.16
Americans	8.88
Others	15.66



**Table 1.** *Cont.*

Tourist Characteristics	Percentage
Marital Status	
Unmarried	23.30
Married	63.98
Divorced	9.47
Widow	3.25
Annual Income (\$)	
Low (<8000)	32.51
Medium (8000–16,000)	30.52
High (>16,000)	36.97
Tourist Type	
Domestic tourists	61.06
International tourists	38.94

#### 4.2. Descriptive Statistics

Table 2 shows the descriptive statistics of all of the constructs, as well as their items, considered in this study. The results show that COVID-19 has severely affected the lifestyles and primary income sources of tourists. Moreover, tourists perceived higher travel risks in the new normal. A large majority of the tourists also perceived a risk of infection at tourism destinations. Moreover, tourists were also concerned about the enforcement of precautionary measures at tourism destinations. The findings also suggested a shift in tourist transportation behavior in the new normal. Because of the ongoing COVID-19 crisis, the majority of the tourists avoid public transportation and shared rides. Similarly, the results revealed that tourists are afraid of visiting overcrowded places in the new normal and have restricted their outdoor mobility to only purchasing necessary items. A large majority of the tourists indicated a shift in their hygiene and safety behaviors after COVID-19. Similarly, a large majority of the tourists mentioned that tourism policies (discounts, free insurance, and quarantines in the case of COVID-19 contamination) at tourism destinations attract them to tourism in the new normal. The majority of the tourist participants intended to travel in the new normal.

**Table 2.** Descriptive statistics.

Construct/Item	Mode	Mean	SD
COVID-19 pandemic (CP)		3.99	1.21
I have low immunity against the COVID-19 pandemic (CP1).	2	2.39	1.03
COVID-19 badly affected my daily mobility (CP2).	4	3.89	1.23
COVID-19 had a significant impact on my primary source of income (CP3).	5	4.75	1.35
COVID-19 changed my lifestyle (CP4).	5	4.89	1.26
COVID-19 risk perception of tourism (RP)		3.57	1.98
I will become infected at the tourist destination (RP1).	4	4.15	1.96
I will become infected while traveling to a tourist destination (RP2).	3	3.26	1.88
I perceive that public health precautions will not be strictly enforced in tourist areas (RP3).	4	3.86	1.79

Table 2. Cont.

Construct/Item	Mode	Mean	SD
I perceive that I cannot live in isolation if I am contaminated by COVID-19 at a tourism destination (RP4).	3	2.98	1.87
Transportation behavior (TB)		3.10	2.27
I try not to use public transportation (TB1).	4	4.09	2.57
I avoid shared mobility (TB2).	2	2.67	1.90
I avoid using transport that is not regularly disinfected (TB3).	2	2.53	1.87
Behavior towards overcrowded places (BOP)		4.02	1.53
I try to avoid visits to overcrowded places (BOP1).	4	4.35	1.46
I try not to interact with the people at overcrowded places (BOP2).	3	3.31	1.66
I try to visit markets alone for necessary items purchasing (BOP3).	4	4.23	1.49
I try to visit crowded places only when its absolute necessary (BOP4)	4	4.17	1.55
Hygiene and safety behavior (HSB)		4.53	0.90
COVID-19 changed my hygiene and safety behaviours (HSB1).	5	4.87	0.98
I prefer to stay in hotels and restaurants that adhere to social distancing guidelines (HSB2).	4	4.5	0.67
I prefer tourist places with better public health measures (HSB3).	5	4.88	1.09
I like to stay alone after COVID-19.	3	3.53	0.89
Attitude toward tourism policies for reviving tourism industry in new normal (ATTP)		3.89	1.10
In the new normal, I like the idea of getting free health insurance at the destination during the trip (TP1).	5	4.67	1.66
The fact that there are testing and quarantine facilities at the destination makes me more likely to visit a tourism destination in the new normal (TP2).	4	3.97	1.13
Discount travel policies entice me to visit a tourist destination in the new normal (TP3).	4	4.16	1.09
Publicizing the tourist protection measures helps me make a decision about a tourism destination (TP4).	4	4.3	1.23
Publicizing the benefits associated with the destination visits encourages me to make a decision in the new normal (TP5).	3	3.14	0.78
Publicizing tourist assistance resources at the destination in the event of an emergency encourages me to visit the destination in the new normal (TP6).	4	3.87	1.04
I prefer that the tourism destination have immediate and effective communication sources' available to the tourist in the new normal (TP7).	3	2.91	0.74
Tourism intentions in the new normal (TI)		3.32	2.56
I have frequently travelled around the country or the world since the beginning of COVID-19 for tourism (TI1).	2	2.49	1.99
I am likely to travel around the country or the world in the new normal for tourism (TI2).	3	3.32	2.68
I intend to travel around the country or the world in the new normal for tourism (TI3).	4	4.13	2.89

#### 4.3. Measurement Model Analysis

Before testing the hypotheses of this research, model fit indices were checked to see the overall fit of the model. All of the index values for the final proposed model confirmed

an acceptable fit (GFI = 0.97; CFI = 0.96;  $\chi^2/df$  = 5.17; NFI = 0.95; AGFI = 0.91; and RMSEA = 0.042). All of the goodness-of-fit results support the justification for further analyses. Table 3 shows the results of statistical indices. This study took insights from prior literature (e.g., Sher et al. [63], Sher et al. [64], and Singh and Prasad [65]) to evaluate the measurement model.

**Table 3.** Goodness of fit indices.

Goodness of Fit Measures	Structural Model Results
$\chi^2/df$	5.17
GFI (goodness of fit index)	0.97
CFI (comparative fit index)	0.96
AGFI (adjusted goodness of fit index)	0.93
NFI (normed fit index)	0.95
RMSEA (root mean square error of approximation)	0.042

Note: All goodness of fit measures are within the threshold limit, as suggested by Putrevu and Lord [66].

Additionally, convergent and discriminant validity were examined to assess the goodness of fit of the measurement model. The composite reliability (CR) and average variance extracted (AVE) were measured to analyze the convergent validity of the measurement model. The CR coefficient should not be less than 0.60 for achieving an adequate convergent validity of latent variables [67,68]. Another study by Henseler et al. [69] showed that a CR coefficient value greater than 0.70 indicates an adequate model for confirmatory purposes. Similarly, Daskalakis and Mantas [70] stated that a CR value greater than or equal to 0.80 describes the adequacy of the model for confirmatory purposes. The CR coefficient value for all of the latent variables is greater than 0.85 in this study and fulfills all of the above-mentioned criteria for further analyses. The AVE was also assessed for confirming the convergent validity of all of the latent variables. The AVE value should be greater than 0.50 for achieving substantial convergent validity [62,71,72]. The AVE values of all of the constructs are greater than the threshold level, indicating the convergent validity of the measurement model in this study.

Moreover, the factor loading of any item should not be less than 0.70 for measuring construct validity, and items of each construct with a factor loading value of less than 0.40 should be considered for elimination. Most of the time, indicators with loadings between 0.40 and 0.70 should not be taken off the scale unless taking them off increases the overall reliability above the suggested threshold value [62,73]. The factor loadings in Table 4 have confirmed the threshold criteria for the inclusion of the items in the corresponding construct. The Cronbach's alpha value for a latent variable should be greater than the cut-off value of 0.70 [27,74]. The findings indicated that the Cronbach's alpha value for all of the constructs was greater than 0.80, which confirms the internal reliability of the included items in each construct.

**Table 4.** Constructs and their validity measurements.

Construct/Associated Items	Factor Loading	Cronbach's Alpha	CR	AVE	VIF
CP		0.878	0.959	0.853	2.12
CP1	0.902				
CP2	0.921				
CP3	0.876				
CP4	0.832				

Table 4. Cont.

Construct/Associated Items	Factor Loading	Cronbach's Alpha	CR	AVE	VIF
RP		0.88	0.917	0.736	1.78
RP1	0.874				
RP2	0.882				
RP3	0.854				
RP4	0.921				
TB		0.855	0.869	0.689	1.89
TB1	0.904				
TB2	0.896				
TB3	0.849				
BOP		0.897	0.923	0.752	2.43
BOP1	0.932				
BOP2	0.857				
BOP3	0.903				
BOP4	0.901				
HSB		0.904	0.861	0.607	2.76
HSB1	0.876				
HSB2	0.857				
HSB3	0.846				
HSB4	0.863				
ATTP		0.895	0.933	0.665	2.65
ATTP1	0.921				
ATTP2	0.897				
ATTP3	0.889				
ATTP4	0.900				
ATTP5	0.922				
ATTP6	0.911				
ATTP7	0.899				
TI		0.803	0.859	0.672	
TI1	0.853				
TI2	0.831				
TI3	0.875				

Furthermore, Kock [75] reported that a variance inflation factor (VIF) value of more than 3.3 is a sign of pathological collinearity, and it also shows that the model could be tainted by common method bias. As the VIF values shown in Table 4 are less than 3.3, this indicates that the model is free of lateral or pathological collinearity.

The latent variables are required to be distinct from each other [62]. The square root of AVE describes the discriminant validity of a latent variable by comparing its correlation values with all other latent variables. The square root of the AVE of a latent variable must be greater than its correlation scores with all other latent variables [76]. The results shown in Table 5's diagonal confirmed discriminant validity: the greater the value compared to the correlation values with other constructs, the greater the variance explained by the construct with its own measure compared to the other measures [73]. Moreover, the results

regarding the heterotrait–monotrait ratio (HMR) were also tested to check the discriminant validity [73]. The fact that HMR is less than 0.90 confirms its discriminant validity [70].

**Table 5.** Discriminant validity.

Fornell–Larcker Criterion							
	CP	RP	TB	BOP	HSB	ATTP	TI
CP	0.924						
RP	0.453	0.858					
TB	0.324	0.436	0.830				
BOP	0.548	0.534	0.231	0.867			
HSB	0.674	0.321	0.402	0.478	0.779		
ATTP	0.634	0.663	0.209	0.687	0.573	0.815	
TI	0.501	0.432	0.329	0.442	0.263	0.356	0.819
Heterotrait–Monotrait Ratio (HMR)							
	CP	RP	TB	BOP	HSB	ATTP	TI
CP							
RP	0.440						
TB	0.681	0.476					
BOP	0.655	0.320	0.439				
HSB	0.536	0.213	0.567	0.201			
ATTP	0.712	0.473	0.63	0.445	0.295		
TI	0.644	0.538	0.404	0.563	0.278	0.333	

#### 4.4. Structural Model Analysis

$R^2$ , which describes the explained variance portion, was measured to assess the predictive accuracy of the structural model. The  $R^2$  results of all of the hypotheses constructed in the model were greater than 0.50 (Table 6), except for H6, which has a  $R^2$  of less than 0.50. Following Wetzels et al. [77], the non-parametric bootstrapping method was applied to test the relationships of the latent variables hypothesized from H1 to H15. Among all 15 hypotheses, 2, H9 and H15, were not supported and rejected. The findings revealed that COVID-19 has a significant negative impact on tourism intentions and a significant positive impact on risk perceptions because its t-value is greater than the threshold value (2.32). The findings also suggested that risk perceptions have a significant influence on tourism intentions in the new normal ( $\beta = -0.772, p = 0.01$ ). There was a significant positive impact of risk perceptions on transportation behavior ( $\beta = 0.725, p < 0.01$ ), avoiding overcrowded places ( $\beta = 0.692, p < 0.01$ ), and hygiene as well as safety behaviors ( $\beta = 0.568, p < 0.01$ ). Furthermore, in the new normal, public transportation behaviors had a negative and significant impact on tourism ( $\beta = -0.220, p < 0.01$ ), and avoiding overcrowded places had a significant and negative impact on tourism ( $\beta = -0.402, p < 0.01$ ). The results also depicted that hygiene and safety behaviors positively impact tourism in the new normal, but this relationship was statistically insignificant. COVID-19 ( $\beta = 0.602, p < 0.01$ ) and risk perceptions ( $\beta = 0.592, p < 0.01$ ) were also positively associated with attitudes toward tourism policies. The direct impact of moderating variable attitudes toward tourism policies on transportation behaviors and overcrowded tourist places was also significant and negative.

**Table 6.** Path coefficients.

		Beta	SD	t-Value	f <sup>2</sup>	Q <sup>2</sup>	R <sup>2</sup>	Decision
H1	CP → TI	−0.768	0.039	−19.845 *	0.117	0.477	0.613	Accepted
H2	CP → RP	0.633	0.034	18.509 *	0.092	0.364	0.654	Accepted
H3	RP → TI	−0.772	0.040	−19.397 *	0.070	0.497	0.531	Accepted
H4	RP → TB	0.725	0.088	8.239 *	0.143	0.210	0.601	Accepted
H5	RP → BOP	0.692	0.054	12.839 *	0.208	0.309	0.587	Accepted
H6	RP → HSB	0.568	0.042	13.492 *	0.138	0.193	0.493	Accepted
H7	TB → TI	−0.220	0.078	−2.810 *	0.143	0.201	0.502	Accepted
H8	BOP → TI	−0.402	0.092	−4.355 *	0.384	0.342	0.677	Accepted
H9	HSB → TI	0.321	0.299	1.074	0.234	0.253	0.633	Rejected
H10	CP → ATTP	0.602	0.037	16.183 *	0.234	0.326	0.667	Accepted
H11	RP → ATTP	0.592	0.058	10.278 *	0.264	0.443	0.761	Accepted
H12	ATTP → TI	0.553	0.025	21.858 *	0.168	0.562	0.702	Accepted
H13	ATTP → TB	−0.423	0.034	−12.441 *	0.212	0.229	0.551	Accepted
H14	ATTP → BOP	−0.291	0.057	−5.105 *	0.203	0.303	0.611	Accepted
H15	ATTP → HSB	0.367	0.299	1.227	0.163	0.399	0.559	Rejected

Note: t-value  $\geq 2.32$  considered significant at \*  $p < 0.01$  at 5.

The effect size was measured by using the  $f^2$  value. A value of  $f^2 < 0.02$  describes a small effect, whereas 0.15 depicts a medium effect, and  $> 0.35$  a large effect size [78]. The findings show that tourism intentions ( $f^2 = 0.384$ ) in the case of hypothesis H8 have a large effect size, while in all remaining cases the effect size of variables was medium because the  $f^2$  was less than 0.15 but greater than 0.02. The predictive relevance of all of the hypotheses was also confirmed by estimating the  $Q^2$ ; a value greater than zero [79] ensured the predictive relevance of all of the constructs.

The findings regarding the mediating effect of attitudes toward tourism policies are presented in Table 7. The results show that attitudes toward tourism policies mediate the effect of COVID-19 on tourism intentions ( $\beta = 0.302$ ,  $p < 0.01$ ). Similarly, attitudes toward tourism policies mediated the effect of risk perceptions on tourism intentions ( $\beta = 0.434$ ,  $p < 0.01$ ), transportation behavior s( $\beta = -0.339$ ,  $p < 0.01$ ), behaviors toward overcrowded places ( $\beta = -0.216$ ,  $p < 0.01$ ), and hygiene as well as safety ( $\beta = 0.109$ ,  $p < 0.01$ ).

**Table 7.** Mediating effects.

		Beta	SD	t-Value	p-Value	Decision
H16a	CP → ATTP → TI	0.302	0.054	5.603	0.000	Accepted
H16b	RP → ATTP → TI	0.434	0.067	6.478	0.000	Accepted
H16c	RP → ATTP → TB	−0.339	0.022	−15.409	0.000	Accepted
H16d	RP → ATTP → BOP	−0.216	0.034	−6.353	0.000	Accepted
H16e	RP → ATTP → HSB	0.109	0.048	2.271	0.000	Accepted

## 5. Discussion

COVID-19 has severely impacted the tourism industry worldwide, and this pandemic is not over yet. The world tourism sector is starting to recover from the pandemic, and tourism stakeholders are in search of different policies that can assist in the recovery of this industry in the new normal. Thus, one of the primary goals of this study is to assess the mediating effect of attitudes toward tourism policies on tourist behaviors and

tourism intentions, which were severely impacted by COVID-19. The role of attitudes toward tourism policies in the new normal will greatly contribute to the rehabilitation of the tourism sector. A newly developed scale was used to measure the impact of the pandemic on tourism intentions as well as risk perceptions. The study also looked at the impact of tourists' perceptions of risk toward transportation, crowded places, and hygiene as well as safety behaviors. The structural equation model's findings established a link between COVID-19, risk perceptions, and tourism intentions. The pandemic created general fear [80] due to its easy and rapid spread. This rapid and easy transmission of COVID-19, alongside its long incubation period after infection, created fear among tourists and travelers [81,82], which increased the perceived risks in regard to the pandemic. Neuburger and Egger [16] also found high perceived risks among tourists during COVID-19. Due to perceived risks, tourists in the new normal prefer safe and secure leisure activities. Tourists are wary of disasters and health crises because they put their health and safety at risk [83,84]. Thus, health disasters and crises affect tourists' intentions toward tourist destinations. Kourgiantakis et al. [85] also reported that the pandemic has significantly increased perceived risks and affected the travel intentions of tourists worldwide.

The results of the current study indicated the significant impact of risk perceptions on tourist behaviors (transport behaviors and behaviors towards crowded places, hygiene, and safety) and tourism intentions in the new normal. Risk perceptions do not only affect tourists' decisions in selecting tourism destinations but also affect tourists' decisions as to whether they travel or not [30,86,87], which ultimately affects tourists' intentions [88]. Peri et al. [84] and Peco-Torres et al. [89] discussed the negative impact of various risk perceptions on tourist behaviors and tourism intentions. Chan et al. [90] also explained that the perceived risks of tourists modified the transportation behaviors of people during COVID-19. Thus, the travelers who perceived high levels of risk were less likely to use public transport and more likely to use private or owned transport [91].

According to Vickerman [92], behaviors toward transportation use have changed significantly during the pandemic due to the different levels of perceived risk associated with different modes of transportation. According to the same study, the pandemic has reduced the use of public transport while increasing the use of private transport. According to Pawar et al. [93], approximately 75% of Indian commuters believe public transport is dangerous, which has resulted in a shift from public to private modes. The study also reported that 5% of Indian commuters have shifted from public transport to private cars. A survey conducted in Australia revealed that private modes of transport are more comfortable than public modes, and 42% of respondents referred to the bus as the least comfortable mode during the pandemic [94]. According to De Haas et al. [95], people in the Netherlands prefer to drive rather than take public transport. In Budapest, Hungary, the modal share of public transport has decreased from 43% to 18%, while an unexpected growth from 43% to 65% in car use has been observed in the modal share [37]. Similarly, people perceive a very low risk of viral transmission in private transport modes, such as personal cars, motorcycles, etc., a moderate risk in shared modes, e.g., ridesharing, rikshaws, and autorickshaws, and a very high risk in public transport modes, such as buses [91]. The results of this study contradict those of Liu et al. [96], who contend that a free tourist public transport scheme does not encourage tourists to use public transport. The difference may be due to the fact that the present study was conducted purely in the context of COVID-19, which has changed the world altogether.

Leisure places and tourism destinations play a vital role in human life to maintain quality of life [97], but during the pandemic these places have become very risky and vulnerable to the spread of the virus. Therefore, tourists with high levels of perceived risks are less likely to tour during COVID-19. Bayrsaikhan et al. [98] also reported the negative impact of risk perceptions on selecting crowded destinations for tourism during COVID-19. High levels of perceived risks will require more hygiene and safe destinations in the new normal. The easy and rapid transmission of the virus caused sensitivity among tourists, who preferred highly hygienic and safe tourist destinations [39]. Aydin et al. [99] also

noted the increasing concern about hygiene and safety among tourists in Turkey. Therefore, changes in transportation behaviors have negatively impacted tourism intentions. This may imply that avoiding public transport for traveling toward a destination will cause more tourism expenditures (using private or shared transport), which may negatively affect tourism intentions in the new normal.

The fact that attitudes toward tourism policies act as a bridge between risk perceptions and travel plans has important policy implications for bringing the tourism industry back to life and making it more resilient to future crises. The literature on the role of attitudes toward tourism policies in the recovery of the tourism sector is very limited, and the new normal era requires effective tourism policies for attracting tourists and reviving the tourism industry [100]. The tourism policies considered in this study determined that their application and adoption have a significant mediating role between COVID-19 as well as risk perceptions and transportation behaviors, overcrowded destinations, and tourism intentions. For example, effective marketing of tourist destinations may assist in the recovery of tourism after disasters [101], and relevant marketing strategies play an important role in mitigating the perceived risks during COVID-19 [102]. Therefore, the current literature supports offering discounts to motivate tourists to travel toward a particular destination [103]. Promotional marketing strategies were employed to revive tourism by lodging businesses and tourism service providers after many disasters and crises around the globe, such as the 9/11 US terrorist attack, the Bali bombing in 2002, the SARS health crisis in Southeast Asia in 2002–04, a forest fire in Canada, and the Ebola outbreak in 2013–15 in Africa [104–109]. Similarly, the pandemic caused fundamental changes in tourism destination communications, and marketers started to use social media for communication during the pandemic [110,111]. Social media is a major source of the dissemination of information concerning the ongoing situation of the pandemic around the world [112], and can be used for marketing in the new normal to revive the tourism industry. Because the perception of a crisis and its magnitude is heavily shaped by media discourses [113,114], communication via social media plays an important role in restoring a destination's image [115]. Thus, in the new normal, publicizing the benefits associated with visiting a tourist attraction and taking protection measures can positively attract tourists toward visiting a particular destination.

To conclude, this research is not without limitations. Firstly, this study used cross-sectional data for its analyses, and future research is suggested to collect longitudinal data to compare whether travel risk perceptions and attitudes toward tourism policies significantly affect tourism intentions in the new normal. Secondly, the study used an online survey to collect data for this study, and so the respondents may not represent the whole population of world tourists. Future research using face-to-face surveys with other sampling methods is suggested to improve the representativeness of the population. Third, this study was conducted at a time when the world was preparing for the new normal, with some countries lifting or relaxing travel restrictions while others maintained strict travel restrictions. This study ignores cross-country travel restriction differences. It is suggested that cross-country studies take into account the travel restriction differences in the new normal. In addition, this research does not differentiate between domestic and international tourists in measuring risk perceptions and tourism intentions; however, Seyfi et al. [116] suggested that countries follow separate travel restriction policies for domestic and international tourists. This might influence the findings of the study, and future research should consider differences in travel policies when measuring the risk perceptions and tourism intentions of domestic and international tourists.

## 6. Conclusions and Policy Recommendations

The COVID-19 pandemic has severely harmed both domestic and international tourism. The literature noted the significant decline in the number of tourists due to strict mobility restrictions imposed to curb the pandemic's spread worldwide. The rapid and easy transmission of COVID-19 from person to person increased the perceived risks



among tourists. This caused a change in tourists' behaviors in terms of transportation selection, hygiene, and safety. This change in behaviors, coupled with high risk perceptions, negatively affected tourists' intentions of touring during COVID-19. COVID-19 is not over yet, and people will have to live with it in the new normal. This new normal requires effective tourism policies to direct tourists' intentions and behaviors toward the revival of the tourism sector.

COVID-19 has a significant impact on tourism intentions as well as on risk perceptions in the new normal. The findings also revealed that tourists' perceptions of risk influenced their behaviors regarding transportation use and hygiene as well as safety. Tourists' perceptions of risk and transportation use behaviors during the pandemic are also significantly mediated by their attitudes toward tourism policies. Moreover, attitudes toward tourism policies also mediate between COVID-19, risk perception, and sustainable recovery in the new normal. This implies that the provision of incentives such as insurance and discount packages, coupled with publicizing the benefits, services, and safety measures at a destination, will assist in reviving the tourism industry in the new normal.

Based on the aforementioned theoretical background and the findings of the current study, some practical implications are offered for the stakeholders in the tourism industry. To begin with, policymakers and relevant stakeholders should work to reduce external barriers to travel, such as cost and time, in order to revitalize the tourism industry in the new normal period. Countries with world-famous tourist destinations should relax their PCR requirements and mandatory quarantine for vaccinated tourists to accomplish this. Moreover, vaccinated tourists belonging to a country or region with a low number of COVID-19 cases may also be exempted from mandatory quarantine. Moreover, tourism stakeholders may offer discounted lodging packages and products to frequent travelers to a destination in order to attract tourists for sustainable recovery. As a result, tourists are more likely to travel again and share their experiences with their social circle. This will also have a public relations impact on a specific destination and encourage other tourists to visit this place. Second, tourism authorities, destination residents, and related businesses should ensure the hygiene and safety of tourists' health by wearing masks whenever they communicate with tourists. Furthermore, they should also publicize their hygienic and safe services on social media. They can make short videos that include compliments and positive reviews by tourists about their vacation destinations, which they can share on social media to inform other potential tourists. This publicity will help reduce tourists' perceived risks and encourage tourists to travel to tourism destinations. Thus, innovative tourism policies can help revive the industry by creating a sense of safety and security among tourists in the new normal.

**Author Contributions:** Conceptualization, T.S. and S.Z.; methodology, T.S. and S.Z.; software, T.S., and Y.L.; validation, S.Z. and Y.L.; formal analysis, S.Z.; investigation, T.S., S.Z., and Y.L.; resources, T.S.; data curation, T.S., and Y.L.; writing—original draft preparation, T.S., S.Z., and Y.L.; writing—review and editing, S.Z. and Y.L.; visualization, S.Z., and Y.L.; supervision, S.Z. and Y.L.; project administration, S.Z. and Y.L.; funding acquisition, S.Z. and Y.L. All authors have read and agreed to the published version of the manuscript.

**Funding:** This paper is one of the phased results of the general project of the National Social Science Foundation of China in 2020, "Research on Statistical Accounting and Dynamic Monitoring of Regional Tourism under Multi-source Data Fusion" (project no. 20BTJ031).

**Institutional Review Board Statement:** The study was approved by the Institutional Review Board of Hainan University, China.

**Informed Consent Statement:** Informed consent was obtained from all subjects involved in the study.

**Data Availability Statement:** The data can be obtained from corresponding author on reasonable request.

**Conflicts of Interest:** The authors declare no conflict of interest.

## References

1. OECD. *Mitigating the Impact of COVID-19 on Tourism and Supporting Recovery*; OECD Publishing: Paris, France, 2020. [CrossRef]
2. ILO. ILO Monitor: COVID-19 and the World of Work. Seventh Edition. Available online: [https://www.ilo.org/wcmsp5/groups/public/@dgreports/@dcomm/documents/briefingnote/wcms\\_767028.pdf](https://www.ilo.org/wcmsp5/groups/public/@dgreports/@dcomm/documents/briefingnote/wcms_767028.pdf) (accessed on 12 May 2022).
3. Binggeli, C.M.; Pollack, C. COVID-19 Tourism Spend Recovery in Numbers. McKinsey & Company. 2020. Available online: <https://www.mckinsey.com/industries/travel-logistics-and-infrastructure/our-insights/covid-19-tourism-spend-recovery-in-numbers> (accessed on 10 June 2022).
4. Dryhurst, S.; Schneider, C.R.; Kerr, J.; Freeman, A.L.; Recchia, G.; Van Der Bles, A.M.; Spiegelhalter, D.; Van der Linden, S. Risk perceptions of COVID-19 around the world. *J. Risk Res.* **2020**, 1–13. [CrossRef]
5. Wen, J.; Kozak, M.; Yang, S.; Liu, F. COVID-19: Potential effects on Chinese citizens' lifestyle and travel. *Tour. Rev.* **2020**, *76*, 74–87. [CrossRef]
6. Wolff, K.; Larsen, S.; Øgaard, T. How to define and measure risk perceptions. *Ann. Tour. Res.* **2019**, *79*, 1–9. [CrossRef]
7. Schmidli, H. *Risk Theory*; Springer: Cham, Germany, 2017.
8. Brown, C.B. Tourism, crime and risk perception: An examination of broadcast media's framing of negative Aruban sentiment in the Natalee Holloway case and its impact on tourism demand. *Tour. Manag. Perspect.* **2015**, *16*, 266–277. [CrossRef]
9. Cakar, K. Tourophobia: Fear of travel resulting from man-made or natural disasters. *Tour. Rev.* **2020**, *76*, 103–124. [CrossRef]
10. Kozak, M.; Crotts, J.C.; Law, R. The impact of the perception of risk on international travellers. *Int. J. Tour. Res.* **2007**, *9*, 233–242. [CrossRef]
11. Rasoolimanesh, S.M.; Seyfi, S.; Rastegar, R.; Hall, C.M. Destination image during the COVID-19 pandemic and future travel behavior: The moderating role of past experience. *J. Destin. Mark. Manag.* **2021**, *21*, 100620. [CrossRef]
12. Jin, X.; Qu, M.; Bao, J. Impact of crisis events on Chinese outbound tourist flow: A framework for post-events growth. *Tour. Manag.* **2019**, *74*, 334–344. [CrossRef] [PubMed]
13. Hassan, S.B.; Soliman, M. COVID-19 and repeat visitation: Assessing the role of destination social responsibility, destination reputation, holidaymakers' trust and fear arousal. *J. Destin. Mark. Manag.* **2020**, *19*, 100495. [CrossRef]
14. Shin, H.; Nicolau, J.L.; Kang, J.; Sharma, A.; Lee, H. Travel decision determinants during and after COVID-19: The role of tourist trust, travel constraints, and attitudinal factors. *Tour. Manag.* **2022**, *88*, 104428. [CrossRef]
15. Kock, F.; Nørdfelt, A.; Josiassen, A.; Assaf, A.G.; Tsionas, M.G. Understanding the COVID-19 tourist psyche: The evolutionary tourism paradigm. *Ann. Tour. Res.* **2020**, *85*, 103053. [CrossRef] [PubMed]
16. Neuburger, L.; Egger, R. Travel risk perception and travel behaviour during the COVID-19 pandemic 2020: A case study of the DACH region. *Curr. Issue Tour.* **2020**, *24*, 1003–1016. [CrossRef]
17. Bhati, A.S.; Mohammadi, Z.; Agarwal, M.; Kamble, Z.; Donough-Tan, G. Motivating or manipulating: The influence of health protective behaviour and media engagement on post-COVID-19 travel. *Curr. Issues Tour.* **2020**, *24*, 2088–2092. [CrossRef]
18. Gohil, N. Role and impact of social media in tourism: A case study on the initiatives of Madhya Pradesh State Tourism. *Int. J. Res. Econ. Soc. Sci.* **2015**, *5*, 8–15.
19. Godbey, G.; Crawford, D.W.; Shen, X.S. Assessing hierarchical leisure constraints theory after two decades. *J. Leis. Res.* **2010**, *42*, 111–134. [CrossRef]
20. Mei, X.Y.; Lantai, T. Understanding travel constraints: An exploratory study of mainland Chinese international students (MCIS) in Norway. *Tour. Manag. Perspect.* **2018**, *28*, 1–9. [CrossRef]
21. Park, J.Y.; Lee, Y.K.; Lee, D.S.; Yoo, J.E.; Shin, M.S.; Yamabe, N.; Kim, S.-N.; Lee, S.; Kim, K.H.; Lee, H.-J.; et al. Abietic acid isolated from pine resin (Resina Pini) enhances angiogenesis in HUVECs and accelerates cutaneous wound healing in mice. *J. Ethnopharmacol.* **2017**, *203*, 279–287. [CrossRef]
22. Matiza, T.; Kruger, M. Ceding to their fears: A taxonomic analysis of the heterogeneity in COVID-19 associated perceived risk and intended travel behaviour. *Tour. Recreat. Res.* **2021**, *46*, 158–174. [CrossRef]
23. Güner, H.R.; Hasanoglu, İ.; Aktas, F. COVID-19: Prevention and control measures in community. *Turk. J. Med. Sci.* **2020**, *50*, 571–577. [CrossRef]
24. Adekunle, A.; Meehan, M.; Rojas-Alvarez, D.; Trauer, J.; McBryde, E. Delaying the COVID-19 epidemic in Australia: Evaluating the effectiveness of international travel bans. *Aust. New Zealand J. Public Health* **2020**, *44*, 257–259.
25. Haq, S.; Shahbaz, P.; Boz, I. Knowledge, behavior and precautionary measures related to COVID-19 pandemic among the general public of Punjab province, Pakistan. *J. Infect. Dev. Ctries.* **2020**, *14*, 823–835. [PubMed]
26. Mertens, G.; Gerritsen, L.; Duijndam, S.; Salemink, E.; Engelhard, I.M. Fear of the coronavirus (COVID-19): Predictors in an online study conducted in March 2020. *J. Anxiety Disord.* **2020**, *74*, 102258. [PubMed]
27. Rahman, M.K.; Gazi, M.A.I.; Bhuiyan, M.A.; Rahaman, M.A. Effect of Covid-19 pandemic on tourist travel risk and management perceptions. *PLoS ONE* **2021**, *16*, e0256486. [CrossRef]
28. Moreira, P. Stealth risks and catastrophic risks: On risk perception and crisis recovery strategies. *J. Travel Tour. Mark.* **2008**, *23*, 15–27. [CrossRef]
29. Sjöberg, L.; Moen, B.E.; Rundmo, T. Explaining risk perception. An evaluation of the psychometric paradigm in risk perception research. *Rotunde* **2004**, *84*, 1–33.
30. Reisinger, Y.; Mavondo, F. Travel anxiety and intentions to travel internationally: Implications of travel risk perception. *J. Travel Res.* **2005**, *43*, 212–225. [CrossRef]

31. Li, F. A study on the factors about tourism risk sense based on logit model—A case study of earthquake in Sichuan on May 12. *Tour. Forum.* **2008**, *6*, 31–36.
32. Maser, B.; Weiermair, K. Travel decision-making: From the vintage point of perceived risk and information preferences. *J. Travel Tour. Mark.* **1998**, *7*, 107–121. [CrossRef]
33. Richter, L. International tourism and its global health consequences. *J. Travel Res.* **2003**, *41*, 340–347. [CrossRef]
34. De Vos, J. The effect of COVID-19 and subsequent social distancing on travel behavior. *Transp. Res. Interdiscip. Perspect.* **2020**, *5*, 100121. [CrossRef]
35. Meena, S. Impact of novel Coronavirus (COVID-19) pandemic on travel pattern: A case study of India. *Indian J. Sci. Technol.* **2020**, *13*, 2491–2501.
36. Parady, G.; Taniguchi, A.; Takami, K. Travel behavior changes during the COVID-19 pandemic in Japan: Analyzing the effects of risk perception and social influence on going-out self-restriction. *Transp. Res. Interdiscip. Perspect.* **2020**, *7*, 1–17. [CrossRef]
37. Bucsky, P. Modal share changes due to COVID-19: The case of Budapest. *Transp. Res. Interdiscip. Perspect.* **2020**, *8*, 1–5. [CrossRef]
38. Savadori, L.; Lauriola, M. Risk perception and protective behaviors during the rise of the COVID-19 outbreak in Italy. *Front. Psychol.* **2021**, *11*, 577331. [CrossRef] [PubMed]
39. Nazneen, S.; Hong, X.; Ud Din, N. COVID-19 crises and tourist travel risk perceptions. *SSRN Electron. J.* **2020**. [CrossRef]
40. Abdelrahman, M. Personality traits, risk perception, and protective behaviors of Arab residents of Qatar during the COVID-19 pandemic. *Int. J. Ment. Health Addict.* **2022**, *20*, 237–248. [CrossRef] [PubMed]
41. Khadaroo, J.; Seetanah, B. The role of transport infrastructure in international tourism development: A gravity model approach. *Tour. Manag.* **2008**, *29*, 831–840. [CrossRef]
42. Gkiotsalitis, K.; Cats, O. Public transport planning adaption under the COVID-19 pandemic crisis: Literature review of research needs and directions. *Transp. Rev.* **2021**, *41*, 374–392. [CrossRef]
43. Shen, J.; Duan, H.; Zhang, B.; Wang, J.; Ji, J.S.; Wang, J.; Pan, L.; Wang, X.; Zhao, K.; Ying, B.; et al. Prevention and control of COVID-19 in public transportation: Experience from China. *Environ. Pollut.* **2020**, *266*, 115291. [CrossRef]
44. Tian, H.; Liu, Y.; Li, Y.; Wu, C.-H.; Chen, B.; Kraemer, M.; Li, B.; Cai, J.; Xu, B.; Yang, Q.; et al. An investigation of transmission control measures during the first 50 days of the COVID-19 epidemic in China. *Science* **2020**, *368*, 6491. [CrossRef] [PubMed]
45. Eichelberger, S.; Heigl, M.; Peters, M.; Pikkemaat, B. Exploring the role of tourists: Responsible behavior triggered by the COVID-19 pandemic. *Sustainability* **2021**, *13*, 5774. [CrossRef]
46. Sung, Y.-A.; Kim, K.-W.; Kwon, H.-J. Big Data Analysis of Korean Travelers' Behavior in the Post-COVID-19 Era. *Sustainability* **2021**, *13*, 310. [CrossRef]
47. Wendt, M.; Sæþórðóttir, A.D.; Waage, E.R. A Break from Overtourism: Domestic Tourists Reclaiming Nature during the COVID-19 Pandemic. *Tour. Hosp.* **2022**, *3*, 788–802. [CrossRef]
48. Jovanović, S.; Janković-Milić, V.; Ilić, I. Health and hygiene importance for the improvement of tourism sector competitiveness in Serbia and the South-Eastern Europe countries. *Procedia Econ. Financ.* **2015**, *19*, 373–382. [CrossRef]
49. Konak, S. The impact of tourist's hygiene-safety perception on their intention to travel during the Covid-19 pandemic in Turkey. *J. Tour. Theory Res.* **2022**, *8*, 5–13. [CrossRef]
50. Al-Saad, S.; AlWohoush, O.; Kozak, M.; AlMasri, R. Health and Hygiene as a Factor of Destination Competitiveness: A Comparative Study Using Synchronic and Diachronic Data. *Tour. Plan. Dev.* **2022**, 1–9. [CrossRef]
51. Hall, C.M.; Scott, D.; Gössling, S. Pandemics, transformations, and tourism: Be careful what you wish for. *Tour. Geogr.* **2020**, *22*, 577–598. [CrossRef]
52. Yusnita, E.; Saufi, A.; Handayani, B. The Effect of Advertising and Price Discounts on the Interest of Tourists to Stay at Hotel (Staycation) During the Covid-19 Pandemic with Health Risk Perception as Moderating Variable. *Int. J. Multicult. Multireligious Underst.* **2021**, *8*, 80–90. [CrossRef]
53. Yin, X.; Huang, J. Effects of price discounts and bonus packs on online impulse buying. *Soc. Behav. Personal. Int. J.* **2014**, *42*, 1293–1302.
54. Alkatiri, S.; Tumbel, A.L.; Roring, F. Pengaruh Daya Tarik Iklan Dan Potongan Harga Terhadap Minat Beli Konsumen Pada Matahari Departement Store Manado Town Square. *J. EMBA* **2017**, *5*, 1781–1792.
55. Um, J.; Yoon, S. Evaluating the relationship between perceived value regarding tourism gentrification experience, attitude, and responsible tourism intention. *J. Tour. Cult. Change* **2021**, *19*, 345–361. [CrossRef]
56. Solomon, M.R.; Dahl, D.W.; White, K.; Zaichkowsky, J.L.; Polegato, R. *Consumer Behavior: Buying, Having, and Being*; Prentice Hall: Upper Saddle River, NJ, USA, 2014.
57. Huh, E.J. The determinants of consumer's attitude and purchase intention on ethical products. *J. Consum. Stud.* **2011**, *22*, 89–111.
58. Zhu, H.; Deng, F. How to Influence Rural Tourism Intention by Risk Knowledge during COVID-19 Containment in China: Mediating Role of Risk Perception and Attitude. *Int. J. Environ. Res. Public Health* **2020**, *17*, 3514. [CrossRef]
59. Churchill, G.A., Jr. A paradigm for developing better measures of marketing constructs. *J. Mark. Res.* **1979**, *16*, 64–73. [CrossRef]
60. Reinartz, W.; Haenlein, M.; Henseler, J. An empirical comparison of the efficacy of covariance-based and variance-based SEM. *Int. J. Res. Mark.* **2009**, *26*, 332–344. [CrossRef]
61. Hair, J.F.; Thomas, G.; Hult, M.; Ringle, C.M.; Sarstedt, M. *A Primer on Partial Least Squares Structural Equation Modeling*, 2nd ed.; Sage: Thousand Oaks, CA, USA, 2017.

62. Chin, W.W. How to write up and report PLS analyses. In *Handbook of Partial Least Squares. Springer Handbooks of Computational Statistics.*; Esposito Vinzi, V., Chin, W., Henseler, J., Wang, H., Eds.; Springer: Berlin/Heidelberg, Germany, 2010. [CrossRef]
63. Sher, A.; Mazhar, S.; Abbas, A.; Iqbal, M.A.; Li, X. Linking entrepreneurial skills and opportunity recognition with improved food distribution in the context of the CPEC: A case of Pakistan. *Sustain. Times* **2019**, *11*, 1838. [CrossRef]
64. Sher, A.; Abbas, A.; Mazhar, S.; Azadi, H.; Lin, G. Fostering sustainable ventures: Drivers of sustainable start-up intentions among aspiring entrepreneurs in Pakistan. *J. Clean. Prod.* **2020**, *262*, 121269. [CrossRef]
65. Singh, I.; Prasad, T. Application of PLS-SEM in modeling the significance of social valuation in the determination of entrepreneurial intention of business management students. *IUP J. Entrepreneursh. Dev.* **2018**, *15*, 7–25.
66. Putrevu, S.; Lord, K.R. Comparative and noncomparative advertising: Attitudinal effects under cognitive and affective involvement conditions. *J. Advert.* **1994**, *23*, 77–91. [CrossRef]
67. Chin, W.W. The partial least squares approach for structural equation modeling. In *Modern Methods for Business Research*; Lawrence: London, UK, 1998; pp. 295–336.
68. Hock, C.; Ringle, C.M.; Sarstedt, M. Management of multi-purpose stadiums: Importance and performance measurement of service interfaces”, *International Journal of Services Technology and Management. Int. J. Serv. Technol. Manag* **2010**, *14*, 188–207. [CrossRef]
69. Henseler, J.; Ringle, C.M.; Sarstedt, M. A new criterion for assessing discriminant validity in variance-based structural equation modeling. *J. Acad. Mark. Sci.* **2015**, *43*, 115–135. [CrossRef]
70. Daskalakis, S.; Mantas, J. Evaluating the impact of service-oriented framework for healthcare interoperability. *Ehealth Beyond Horiz.-Get IT* **2008**, *136*, 285–290.
71. Ringle, C.; Da Silva, D.D.; Bido, D. Structural Equation Modeling with the Smartpls. *Braz. J. Mark.* **2015**, *13*, 56–73. [CrossRef]
72. Rouf, M.A.; Akhtaruddin, M. Factors affecting the voluntary disclosure: A study by using smart PLS-SEM approach. *Int. J. Law Manag.* **2018**, *60*, 1498–1508. [CrossRef]
73. Hair, J.F.; Ringle, C.M.; Sarstedt, M. PLS-SEM: Indeed a silver bullet. *J. Mark. Theory Pract.* **2011**, *19*, 139–152. [CrossRef]
74. Hair, J.F., Jr.; Hult, G.T.M.; Ringle, C.; Sarstedt, M. *A Primer on Partial Least Squares Structural Equation Modeling (PLS-SEM)*; Sage Publications: Thousand Oaks, CA, USA, 2016.
75. MacKinnon, D.P. *Introduction to Statistical Mediation Analysis*; Erlbaum: Mahwah, NJ, USA, 2008.
76. Fornell, C.; Larcker, D.F. Evaluating structural equation models with unobservable variables and measurement error. *J. Marketing Res.* **1981**, *18*, 39–50. [CrossRef]
77. Wetzels, M.; Odekerken-Schroder, G.; Van Oppen, C. Using PLS path modeling for assessing hierarchical construct models: Guidelines and empirical illustration. *MIS Quarterly* **2009**, *33*, 177–195. [CrossRef]
78. Cohen, J. *Statistical Power Analysis for the Behavioral Sciences*; Academic Press: New York, NY, USA; Lawrence Erlbaum Associates, Inc.: Hillsdale, NJ, USA, 2013.
79. Fornell, C.; Cha, J. Partial least squares. In *Advanced Methods of Market-ing Research*; Bagozzi, R.P., Ed.; Blackwell: Cambridge, MA, USA, 1994; pp. 52–78.
80. Bäuerle, A.; Teufel, M.; Musche, V.; Weismüller, B.; Kohler, H.; Hetkamp, M.; Dörrie, N.; Schweda, A.; Skoda, E.-M. Increased generalized anxiety, depression and distress during the COVID-19 pandemic: A cross-sectional study in Germany. *J. Public Health* **2020**, *42*, 672–678. [CrossRef]
81. Flaherty, G.T.; Nasir, N. Reiseangst: Travel anxiety and psychological resilience during and beyond the COVID-19 pandemic. *J. Travel Med.* **2020**, *27*, taaa150. [CrossRef]
82. Hong, Y.; Cai, G.; Mo, Z.; Gao, W.; Xu, L.; Jiang, Y.; Jiang, J. The Impact of COVID-19 on Tourist Satisfaction with B&B in Zhejiang, China: An Importance–Performance Analysis. *Int. J. Environ. Res. Public Health* **2020**, *17*, 3747.
83. Estevão, C.; Costa, C. Natural disaster management in tourist destinations: A systematic literature review. *Eur. J. Tour. Res.* **2020**, *25*, 2502. [CrossRef]
84. Perić, G.; Dramićanin, S.; Conić, M. The impact of Serbian tourists’ risk perception on their travel intentions during the COVID-19 pandemic. *Eur. J. Tour. Res.* **2021**, *27*, 2705. [CrossRef]
85. Kourgiantakis, M.; Apostolakis, A.; Dimou, I. COVID-19 and holiday intentions: The case of Crete, Greece. *Anatolia* **2020**, *32*, 148–151. [CrossRef]
86. Lepp, A.; Gibson, H. Tourist roles, perceived risk and international tourism. *Ann. Tour. Res.* **2003**, *30*, 606–624. [CrossRef]
87. Rittichainuwat, B.N.; Chakraborty, G. Perceived travel risks regarding terrorism and disease: Case Thailand. *Tour. Manag.* **2009**, *30*, 410–418. [CrossRef]
88. Schusterschitz, C.; Schütz, H.; Wiedemann, P.M. Looking for a safe haven after fancy thrills: A psychometric analysis of risk perception in alpine tourist destinations. *J. Risk Res.* **2010**, *13*, 379–398. [CrossRef]
89. Peco-Torres, F.; Polo-Peña, A.I.; Frías-Jamilena, D.M. The effect of COVID-19 on tourists’ intention to resume hotel consumption: The role of resilience. *Int. J. Hosp. Manag.* **2021**, *99*, 103075. [CrossRef]
90. Chan, E.Y.Y.; Huang, Z.; Lo, E.S.K.; Hung, K.K.C.; Wong, E.L.Y.; Wong, S.Y.S. Sociodemographic predictors of health risk perception, attitude and behavior practices associated with health-emergency disaster risk management for biological hazards: The case of COVID-19 pandemic in Hong Kong, SAR China. *Int. J. Environ. Res. Public Health* **2020**, *17*, 3869. [CrossRef]
91. Zafri, N.M.; Khan, A.; Jamal, S.; Alam, B.M. Risk perceptions of COVID-19 transmission in different travel modes. *Transp. Res. Interdiscip. Perspect.* **2022**, *13*, 100548. [CrossRef]

92. Vickerman, R. Will Covid-19 put the public back in public transport? A UK perspective. *Transp. Policy* **2021**, *103*, 95–102. [CrossRef]
93. Pawar, D.S.; Yadav, A.K.; Akolekar, N.; Velaga, N.R. Impact of physical distancing due to novel coronavirus (SARS-CoV-2) on daily travel for work during transition to lockdown. *Transp. Res. Interdiscip. Perspect.* **2020**, *7*, 100203. [CrossRef]
94. Beck, M.J.; Hensher, D.A. Insights into the impact of COVID-19 on household travel and activities in Australia—The early days under restrictions. *Transp. Policy* **2020**, *96*, 76–93. [CrossRef]
95. De Haas, M.; Faber, R.; Hamersma, M. How COVID-19 and the Dutch ‘intelligent lockdown’ change activities, work and travel behaviour: Evidence from longitudinal data in the Netherlands. *Transp. Res. Interdiscip. Perspect.* **2020**, *6*, 100150.
96. Liu, Q.; Liu, Z.; An, Z.; Zhao, P.; Zhao, D. A modal shift due to a free within-destination tourist bus scheme: Multimodality and transport equity implications. *Res. Transp. Bus. Manag.* **2022**, 100863. [CrossRef]
97. Jiao, X.; Jin, Y.; Gunawan, O.; James, P. Modelling Spatial Distribution of Outdoor Recreation Trips of Urban Residents An in-depth study in Salford, UK. *Int. Rev. Spat. Plan. Sustain. Dev.* **2015**, *3*, 36–49.
98. Bayrsaikhhan, T.; Lee, J.; Kim, M.H.; Gim, T.H.T. A seemingly unrelated regression model of the impact of COVID-19 risk perception on urban leisure place choices. *Int. Rev. Spat. Plan. Sustain. Dev.* **2021**, *9*, 30–40. [CrossRef]
99. Aydin, B.; Arica, R.; Arslantürk, Y. The effect of novel coronavirus (COVID-19) on travel risk perception. *Yaşar Üniversitesi E-Derg.* **2021**, *16*, 378–392.
100. Robina-Ramírez, R.; Sánchez, M.S.O.; Jiménez-Naranjo, H.V.; Castro-Serrano, J. Tourism governance during the COVID-19 pandemic crisis: A proposal for a sustainable model to restore the tourism industry. *Environ. Dev. Sustain.* **2022**, *24*, 6391–6412. [CrossRef]
101. Mair, J.; Ritchie, B.; Walters, G. Towards a research agenda for post-disaster and post-crisis recovery strategies for tourist destinations: A narrative review. *Curr. Issues Tour.* **2016**, *19*, 1–26. [CrossRef]
102. Matiza, T. Post-COVID-19 crisis travel behaviour: Towards mitigating the effects of perceived risk. *J. Tour. Futures* **2020**, *8*, 99–108. [CrossRef]
103. Volgger, M.; Taplin, R.; Aebli, A. Recovery of domestic tourism during the COVID-19 pandemic: An experimental comparison of interventions. *J. Hosp. Tour. Manag.* **2021**, *48*, 428–440. [CrossRef]
104. Taylor, M.; Enz, C. GMs’ responses to the events of September 11, 2001. *Cornell Hotel. Restaur. Adm. Q.* **2002**, *43*, 7–20. [CrossRef]
105. Henderson, J. Terrorism and tourism. *J. Travel Tour. Mark.* **2008**, *15*, 41–58. [CrossRef]
106. Hystad, P.; Keller, P. Towards a destination tourism disaster management framework: Long-term lessons from a forest fire disaster. *Tour. Manag.* **2008**, *29*, 151–162. [CrossRef]
107. Ladkin, A.; Fyall, J.; Fletcher, R. Shipway. London tourism. A ‘post-disaster’ marketing response. *J. Travel Tour. Mark.* **2008**, *23*, 95–111. [CrossRef]
108. McKercher, B.; Pine, R. Privation as a stimulus to travel demand? *J. Travel Tour. Mark.* **2005**, *19*, 107–116. [CrossRef]
109. Novelli, M.; Burgess, L.; Jones, A.; Ritchie, B.W. ‘No Ebola . . . still doomed’—The Ebola-induced tourism crisis. *Ann. Tour. Res.* **2018**, *70*, 76–87. [CrossRef]
110. Čorak, S.; Živoder, S.B.; Marušić, Z. Opportunities for tourism recovery and development during and after COVID-19: Views of tourism scholars versus tourism practitioners. *Tourism* **2020**, *68*, 434–449. [CrossRef]
111. Moorman, C.; McCarthy, T. CMOs: Adapt your social media strategy for a post-pandemic world. Harvard Business Review. Available online: <https://www.hbscnyccommunitypartners.org/wp-content/uploads/HBR-2021-Social-Media-Strategy-Post-Pandemic-1.pdf> (accessed on 12 June 2022).
112. González-Padilla, D.A.; Tortolero-Blanco, L. Social media influence in the COVID-19 Pandemic. *Int. Braz. J. Urol.* **2020**, *46*, 120–124. [CrossRef]
113. Mitroff, I.; Anagnos, G. *Managing Crises before They Happen: What Every Executive and Manager Needs to Know about Crisis Management*; AMACOM: New York, NY, USA, 2001.
114. Zhai, X.; Luo, Q.; Wang, L. Why tourists engage in online collective actions in times of crisis: Exploring the role of group relative deprivation. *J. Destin. Mark. Manag.* **2020**, *16*, 11100414. [CrossRef]
115. Moya, M.; Jain, R. When tourists are your “friends”: Exploring the brand personality of Mexico and Brazil on Facebook. *Public Relat. Rev.* **2013**, *39*, 23–29. [CrossRef]
116. Seyfi, S.; Hall, C.M.; Saarinen, J. Rethinking sustainable substitution between domestic and international tourism: A policy thought experiment. *J. Policy Res. Tour. Leis. Events* **2022**, 1–15. [CrossRef]

**Disclaimer/Publisher’s Note:** The statements, opinions and data contained in all publications are solely those of the individual author(s) and contributor(s) and not of MDPI and/or the editor(s). MDPI and/or the editor(s) disclaim responsibility for any injury to people or property resulting from any ideas, methods, instructions or products referred to in the content.

## Article

# How Does Personality Affect COVID-19 Pandemic Travel Risk Perceptions and Behaviors? Evidence from Segment Analysis in Taiwan

Tsung-Hung Lee <sup>1,\*</sup>  and Fen-Hauh Jan <sup>2</sup> 

<sup>1</sup> Graduate School of Leisure and Exercise Studies, National Yunlin University of Science and Technology, Touliu 640, Taiwan

<sup>2</sup> Department of Tourism and Hospitality, TransWorld University, Touliu 640, Taiwan

\* Correspondence: thlee@yuntech.edu.tw

**Abstract:** This study aims to assess the risk perceptions and travel intentions of travelers who were segmented into groups based on their personality traits. In total, 684 useful questionnaires were obtained from Taiwan. A multivariate statistical analysis was performed for data analysis. Five clusters of travelers were identified via cluster analysis: sensitive travelers, cogitative travelers, temperate travelers, introverted travelers, and moderate travelers. These clusters exhibited significant differences in the personality traits, risk perceptions, and behavioral intentions of travelers. By introducing strategies for market segmentation that destination managers can use to develop better marketing strategies that target tourist personality traits during pandemic outbreaks, this study potentially contributes to the literature on travel risk, satisfaction, and behavioral intention, and applies marketing strategies from researchers in tourism studies.

**Keywords:** risk perceptions; travel intentions; personality traits; market segmentation; COVID-19 pandemic



**Citation:** Lee, T.-H.; Jan, F.-H. How Does Personality Affect COVID-19 Pandemic Travel Risk Perceptions and Behaviors? Evidence from Segment Analysis in Taiwan. *Sustainability* **2023**, *15*, 655. <https://doi.org/10.3390/su15010655>

Academic Editors: Zygmunt Kruczek and Bartłomiej Walas

Received: 20 November 2022

Revised: 26 December 2022

Accepted: 26 December 2022

Published: 30 December 2022



**Copyright:** © 2022 by the authors. Licensee MDPI, Basel, Switzerland. This article is an open access article distributed under the terms and conditions of the Creative Commons Attribution (CC BY) license (<https://creativecommons.org/licenses/by/4.0/>).

## 1. Introduction

Tourism is easily impacted by external environmental variables and internal psychological factors [1,2]. Since the end of 2019, the COVID-19 pandemic has become widespread around the world. With the spread of the COVID-19 pandemic, the tourism industry became concerningly sluggish in both international and domestic tourism markets [2,3]. However, even when facing risks, crises, and disasters, people have sufficient adaptability and resilience in the face of adversity [4,5] to eliminate uncertainties caused by risk, effectively manage risk perceptions, reduce psychological resistance, and take actions to face their difficulties [6]. Accordingly, while the pandemic is slowing down, travel is worthy of further study to determine how to coexist with pandemics and find opportunities for tourism development.

COVID-19 has had a serious impact on the global tourism industry, and most countries have successively adopted their own national tourism strategies [7,8]. The United Nations World Tourism Organization survey pointed out that recovery remains slow and uneven across regions of the world due to restrictions on movement in various countries, differences in vaccination rates and various levels of tourist confidence [9]. When a pandemic occurs, both residents and tourists naturally exhibit health protection perceptions and behaviors [10,11]. With the increase in health risk perceptions, tourism demand has gradually decreased because of the pandemic [1,8]. At this time, if tourists' concerns about health risks can be reduced, their intentions to book a room or travel abroad can be increased [9,11].

Human behavior is affected by personality traits and emotions [12]. Individual risk perception and behavior could be affected by personality traits [10,13]. The pandemic has,

indeed, created an atmosphere of uncertainty and risk. When these risks occur, different personality traits will have different impacts on behavioral intentions, and subjective perceptions of risks will impact travel choices [4].

The tourism industry is vulnerable to global crises. The spread of the COVID-19 pandemic has resulted in people deciding to cancel or postpone their travel plans at the last minute [2]. Providing immediate, honest, empathetic, and informative risk communication could be beneficial to a reduction in subjective doubts and perceptions of risk uncertainty, which would help people take appropriate precautions to enable travel [6,14].

Travel risk perception has been regarded as a hamper to tourists' behavioral intentions [15–17]. Health considerations, the destination risk image [18], risk communication [6], and assurances of cleanliness and social distancing [11] have affected tourist destination preferences during the COVID-19 pandemic. Neuburger and Egger [16] found that demographic variables affect tourists' risk perceptions and future behaviors. However, Razavi [19] suggested that personality traits may be a better predictor of individual behavioral intentions than demographic variables. Individuals in the same demographic group may have different preferences, decision-making processes, and behaviors [20]. Previous studies introduced personality traits as a predictor of individuals' behaviors and attitudes, such as behavioral intentions [21], inclinations toward adventurous behavior [22], attitudes toward climate change [23], environmental behaviors [24], risk perceptions toward genetically modified organisms [25], and travel protection behaviors [10]. During the COVID-19 pandemic, tourists with different personality traits exhibited different strategies while traveling, due to facing a health threat [10,21,26]. To better understand individual personality traits and behavior, previous studies have suggested that segmenting the market by personality traits helps to produce marketing strategies, such as providing personalized services [19] and developing brand identity strategies [27]. However, limited studies have addressed travel risk perceptions and behavioral intentions with regard to personality trait segments during the COVID-19 outbreak. As part of managing the sustainability of a destination, the creation of personality trait-based market segments could result in suitable marketing strategies and provide attractive tourism products, which may assure local economic sustainability and increase destination resilience during turbulent situations.

To fill the above gaps, this study aims to assess the risk perceptions and travel intentions of travelers who were segmented into groups based on their personality traits. By understanding personality traits in more depth, this study will encourage managers to offer suitable services to meet tourists' needs during the ongoing pandemic period.

## 2. Theoretical Framework

### 2.1. Personality Traits

Personality traits represent individuals' psychological characteristics, which produce their thoughts, attitudes, affects, and behaviors, as well as enabling the development of interpersonal strategies [28]. Personality traits can affect individuals' internet search behaviors [29], daily spatial behaviors [30], travel intentions during the pandemic [21], generalized anxiety and depressive symptoms [31], environmental protection behavior [32], and adventurous behaviors [22]. Personality traits have been measured by the Big Five model [33], which measures five constructs (i.e., agreeableness, extroversion, conscientiousness, neuroticism, and openness to experience) and is a relatively stable scale [33]. The Big Five model was introduced to explain entrepreneur personality [34–36], the likelihood of household solar energy adoption [24], engagement in environmental behavior [37], investor risk aversion [38], and risk perception [22,39]. Accordingly, the Big Five model would be useful for examining tourists' travel risk perceptions and their subsequent travel intentions.

### 2.2. Personality Traits and Tourism

In the tourism context, tourists with high levels of openness to experience or neuroticism search for more varied travel information than those with other more prominent personality traits [29]. Leri and Theodoridis [40] indicated that tourists with low neuroti-

cism and high agreeableness, extroversion, conscientiousness, and openness to experience give more attention to the servicescape, emotional stimulation, and revisit intention. Juric et al. [35] found that higher levels of agreeableness and openness to experience positively affect tourists using nonmonetary transactions on Airbnb. In the adventure tourism context, Lee and Tseng [22] indicated that those with high traits of openness to experience and extroversion exhibit more risk-taking attitudes and adventurous behaviors. Recently, travel risk perceptions related to the COVID-19 pandemic have changed tourist travel patterns [21]. Several studies have examined tourist reactions during the COVID-19 pandemic, based on their personality traits; for example, tourists with conscientiousness and neuroticism adopt social distance more often than those with other more prominent personality traits [10]. Zajenkowski et al. [26] also indicated that agreeableness indicates a higher willingness to accept pandemic restrictions. Talwar et al. [41] found that extroverted tourists preferred to travel during the COVID-19 pandemic, while tourists with high openness waited until after the pandemic slowdown. Tepavčević et al. [21] indicated that conscientiousness and neuroticism negatively influence travel intention, while extroversion and openness to experience positively influenced travel intention during the COVID-19 pandemic. Accordingly, tourist personality traits are an important antecedent variable in predicting tourist attitudes and behaviors.

### 2.3. Risk Perception toward Travel

Risk perception refers to the subjective perception of the uncertainty of things, so scholars employ different dimensions to measure it [42]. Recently, due to the continuous emergence of global pandemics, tourism risk perception has also been intensively debated [11,43]. Assessing risk perceptions, dimensions such as functional risk, physical risk, and facility risk, are usually considered due to the state of the facilities in the destination environment. Psychological risk and privacy risk are considered to result from the psychological feelings of tourists, and financial risk and performance risk are employed to assess cost-effectiveness [42,44–46].

Perceptions of tourism risk influence tourist decision-making, including the choice of attractions and tourism behaviors [4,16–18,47]. Confidence and perceptual choices lead to more responses characterized by psychological resistance [48]. With the number of people dying from coronary pneumonia continuing to increase worldwide, understanding the public perception of risk is increasingly important for tourism development. Previous studies have indicated that reducing the perceived risk can give tourists confidence and increase their willingness to revisit a destination [14]. Increasing the environmental disinfection and open space, reducing crowding in scenic spots, reducing human contact, and using more automated facilities can reduce health concerns and promote the economic development of the tourism industry during the pandemic [14]. Accordingly, during the uncertainty of the COVID-19 pandemic, decreasing people's risk perceptions with effective attention and real-time information can increase their travel intentions [6,14,18].

## 3. Methods

### 3.1. Research Instrument

A pretest was conducted between July 31 and August 4, 2021, via an online survey. Overall, 109 valid questionnaires were obtained. The questionnaire was assessed by item analysis, as well as by four tourism experts. The formal questionnaire consisted of three parts: personality traits, risk perceptions, and travel behaviors.

According to the conceptualization and application of personality traits [22], five dimensions were adopted to measure personality traits in this survey: neuroticism (5 items), extraversion (6 items), openness to experience (5 items), agreeableness (5 items), and conscientiousness (5 items). Based on the findings by Kim et al. [44] (2020) and Stone and Grønhaug [49], three dimensions were adopted to assess risk perceptions: physical risk (4 items), financial and benefit risk (6 items), and psychological risk (3 items). Indicators of travel behaviors were adopted from Lee's [50] findings, and three items (i.e., overall



satisfaction, willingness to revisit, and willingness to recommend the site to others) were adopted. The measurement items were changed based on item analysis and feedback from the tourism experts. Minor changes in wording were made to five items to improve readability and comprehensibility. Demographic variables were also recoded. The responses were scored on a Likert scale from completely disagree (1) to completely agree (7).

### 3.2. Questionnaire Survey

A cross-sectional questionnaire survey was administered to travelers who were visiting a tourist destination. A mixed approach via on-site and online questionnaire surveys was employed to collect the data. Relying on the travel destinations that were accessible and available, a convenience sampling approach was used to collect the data in such open venues. On the other hand, because the COVID-19 pandemic has severely hit the tourism industry and it is known that limiting physical contact is important to reduce the spread of COVID-19, to avoid contact among travelers, a purposive sampling and snow-balling approach was employed to collect the data via an online questionnaire survey. According to previous studies, with a sample error of 5% and a confidence level of 95%, a sample size of at least 385 individuals would be required [22].

The questionnaires were distributed between 16 August 2021, and 27 March 2022. Both online (<https://forms.gle/nBtuZZPN8m46PN8g9>, accessed on 30 December 2021) and on-site (Sun-Link-Sea Forest Ecological Resort, Sun-Moon-Lake National Scenic Area, Kenting, and Hinoki Village) questionnaire surveys were employed to collect the data. In total, 376 complete answers were obtained from the online survey, and 308 were obtained from the on-site questionnaire for the empirical study.

### 3.3. Data Analysis

The reliability, descriptive statistics, nonparametric analysis, and clustering and discriminant analyses were performed using IBM SPSS Statistics 26, and convergent validity and discriminant validity were assessed using LISREL 8.80 to analyze the data. The cluster analysis method was performed to quantitatively assess how travelers could be segmented by personality traits. A hierarchical cluster analysis was performed to identify five clusters using the Ward method, by calculating the Euclidean distance between the samples and forming clusters with a minimum within-cluster score [51]. Subsequently, the k-means clustering method was employed with the scores of the five personality traits to form five clusters using all the respondents. A multivariate analysis of variance (MANOVA) was used on the risk perceptions and travel behavior of respondents to assess whether there were significant between-group differences. When the MANOVA analytical results reached a significant level, analysis of variance (ANOVA) was used to assess whether the groups differed with regard to risk perceptions. While significant differences were identified, the Scheffe test was used to identify the differences among the five clusters.

### 3.4. Reliability and Validity

The Cronbach's alpha for neuroticism, extraversion, openness to experience, agreeableness, conscientiousness, physical risk, financial and benefit risk, and psychological risk were 0.913, 0.901, 0.899, 0.847, 0.906, 0.905, 0.890, and 0.950, respectively. All of these scores were greater than the benchmark of 0.70 [52], indicating that the research instrument has acceptable reliability. Table 1 shows the factor loadings, t-values, composite reliability (CR), and average variance extracted (AVE) for the five personality dimensions and three risk perception dimensions. All the CR scores exceeded 0.6, suggesting that these measures were reliable for the corresponding constructs. All the factor loadings were greater than the 0.5 threshold for the significance level, suggesting acceptable convergent validity. All the AVE scores were greater than the threshold of 0.5, suggesting satisfactory convergent and discriminant validity [53]. Moreover, all of the square roots of the AVEs exceeded the inter-correlations between the pairs of constructs and, thus, illustrated acceptable discriminant validity [53].

**Table 1.** Factor loading, t-value, average variance extracted (AVE), and composite reliability (CR) of the latent variables for personality traits and risk perception.

Latent Variables	Factor Loading	AVE	CR
<b>Personality traits</b>			
<i>Neuroticism</i>			
Get stressed out easily	0.88	0.68	0.91
Worry about things	0.88		
Fear for the worst	0.79		
Filled with doubts about things	0.75		
Panic easily	0.80		
<i>Extraversion</i>			
Talk a lot to different people at parties	0.69	0.61	0.90
Feel comfortable around people	0.69		
Start conversations	0.81		
Make friends easily	0.85		
Normally the life in a party	0.84		
Know how to captivate people	0.80		
<i>Openness (to experience)</i>			
Get excited by new ideas	0.78	0.65	0.90
Enjoy thinking about things	0.85		
Enjoy hearing new ideas	0.86		
Enjoy looking for a deeper meaning in things	0.84		
Having a vivid imagination	0.68		
<i>Agreeableness</i>			
Sympathize with others' feeling	0.80	0.54	0.85
Concerned about others	0.86		
Respect others	0.76		
Believe that others have good intentions	0.67		
Trust what people say	0.53		
<i>Conscientiousness</i>			
Carry out my plans	0.73	0.66	0.91
Pay attention to details	0.76		
Always prepared	0.87		
Make plans and stick to them	0.89		
Exacting in my work	0.81		
<b>Risk perception</b>			
<i>Physical risk</i>			
Traveling at this time, I am worried about the risk of catching the COVID-19 pandemic	0.85	0.71	0.91
At this time, I try to avoid traveling to popular attractions	0.85		
I don't even want to travel because of the risk of catching the COVID-19 pandemic	0.84		
Because of the current pandemic situation, I prefer to shorten my travel time	0.83		
<i>Financial and benefit risk</i>			
Traveling at this time will cost more	0.58	0.57	0.88
Traveling at this time, I am worried that the quality of tourist attractions does not meet the value	0.74		
Traveling at this time, I am worried that the travel information on the website may be different from the actual one	0.79		
Traveling at this time, I am worried that the quality of accommodation or food hygiene during the tour is not as good as expected	0.86		
Traveling at this time, I am worried about the inconvenience of transportation	0.72		
Traveling at this time, I am worried about the inconvenience of food and accommodation	0.79		
<i>Psychological risk</i>			
Traveling at this time makes me feel uncomfortable	0.94	0.84	0.94
Traveling at this time makes me feel anxious	0.91		
Traveling at this time makes me nervous	0.89		

All the t-value of factor loadings larger than 1.96; AVE: Average variance extracted =  $(\sum\lambda^2)/[\sum\lambda^2 + \sum(\theta)]$ ; CR: Composite reliability =  $(\sum\lambda)^2/[(\sum\lambda)^2 + \sum(\theta)]$ .

## 4. Results

### 4.1. Profiles of the Respondents

In summary, most respondents were female (56.4%), had a single marital status (52.8%), were between the ages of 20 and 39 (64.0%), were highly educated with university or college

degrees (59.3%), had an occupation as a business person (23.4%) or laborer (22.8%), had a monthly income between TWD 20,001 and 40,000 (34.7%) or TWD 40,001–60,000 (26.1%), and lived in Yunlin, Chiayi, Tainan (33.3%) and Taipei, New Taipei City, Ilan (24.7%; Table 2).

**Table 2.** Profiles of the respondents.

Variable	N	%
Gender		
Male	295	43.1
Female	386	56.4
Other	3	0.4
Marital status		
Single	361	52.8
Married	323	47.2
Age (years old)		
20–29 years old	507	38.8
30–39 years old	329	25.2
40–49 years old	255	19.5
50–59 years old	161	12.3
Over 60 years old	54	4.1
Educational level		
Junior high school and below	23	1.8
High school	269	20.6
University or college	775	59.3
Graduate school	240	18.4
Occupation		
Office worker or teacher	226	17.5
Agriculturist, farmer, or fisherman	21	1.6
Laborer	294	22.8
Business person	301	23.4
Housewife	62	4.8
Retire or none	44	3.4
Student	192	14.9
Others	149	11.6
Monthly income (TWD *)		
≤20,000	223	17.4
20,001–40,000	444	34.7
40,001–60,000	333	26.1
60,001–80,000	152	11.9
80,001–100,000	52	4.1
≥100,001	74	5.8
Residence		
Taipei, New Taipei City, Ilan	169	24.7
Taoyuan, Hsinchu, Miaoli	51	7.5
Taichung, Chungwa, Nantou	138	20.2
Yunlin, Chiayi, Tainan	228	33.3
Kaohsiung, Pingtung	79	11.5
Hualien, Taitung	12	1.8
Ponghu, Chinmen, Matsu	7	1.0

\* 1 US\$ =31.13 NT\$ as of 20 November 2022.

#### 4.2. Market Segmentation of the Travelers

Since the shift from six to five groups resulted in the largest percentage increase in the error coefficient, five clusters were optimally determined from the hierarchical cluster analysis. Next, five clusters were generated for all respondents by using the k-means clustering method based on the scores of the personality traits. Cluster 1 included 17.58% (n = 119) of the respondents. This group had the highest scores for neuroticism and was named as the sensitive travelers. Cluster 2 consisted of 16.69% (n = 113) of the respondents. This group had the highest scores for openness, agreeableness, and conscientiousness, and was named as the cogitative travelers. Cluster 3 accounted for 26.00% (n = 176) of

the respondents. This group had high scores for extraversion, openness, agreeableness, and conscientiousness, along with neuroticism, and was named as the temperate travelers. Cluster 4 consisted of 12.85% ( $n = 87$ ) of the respondents. This group had relatively low scores for openness to experience, agreeableness, and conscientiousness, and was named as the introverted travelers. Cluster 5 accounted for 26.88% ( $n = 182$ ) of the respondents. This cluster had a middle range for the five personality traits and was named as the moderate travelers.

The assessment of the cluster formation procedure indicated that 96.9% of the original grouped cases and 96.2% of the cross-validated grouped cases were correctly classified, indicating a relatively high accuracy rate. Sensitive travelers (97.5%), cogitative travelers (98.2%), temperate travelers (96.0%), introverted travelers (95.4%), and moderate travelers (97.3%) were correctly classified into their respective clusters. Consequently, the five groups indicated that the discriminant function was effectively identified.

The discriminant analysis revealed four significant canonical discriminant functions ( $p < 0.001$ ; Table 3). These analytical results suggested that the relationships among the functions and the dependent variables were effectively explained by the models (54.0%, 42.5%, 3.3%, and 0.2%, respectively). All the personality traits were assessed to be statistically significant based on Wilks's lambda tests, showing that all the personality traits contributed significantly to the discriminant function.

**Table 3.** Summary of discriminant analysis results.

Function	Eigenvalue	Variance Explained by Function (%)	Canonical Correlation	Wilks' Lambda	$\chi^2$	df	$p$
1	2.777	54.0	0.857	0.07	1780.506	20	<0.001
2	2.183	42.5	0.828	0.266	888.858	12	<0.001
3	0.172	3.3	0.383	0.846	111.958	6	<0.001
4	0.008	0.2	0.091	0.992	6.637	2	<0.05
Discriminant loading		Function 1	Function 2	Function 3	Function 4		
Sensitive travelers		−0.246	0.971	−0.071	0.014		
Cogitative travelers		0.612	0.062	−0.71	0.156		
Temperate travelers		0.453	0.040	0.019	−0.316		
Introverted travelers		0.316	0.137	0.404	−0.589		
Moderate travelers		0.383	0.159	0.431	0.826		

96.9% of original grouped cases correctly classified; 96.2% of cross-validated grouped cases correctly classified.

#### 4.3. Personality Trait Differences among the Five Clusters

One-way ANOVA and Scheffe's post-hoc tests in personality traits among five clusters showed that the personality traits differed significantly among the five clusters ( $p < 0.001$ ; Table 4), confirming the identification of distinct personality trait clusters. The mean of the sensitive travelers was statistically higher in the measures of neuroticism than the other four groups ( $p < 0.001$ ). Cogitative travelers were significantly higher in conscientiousness than other clusters ( $p < 0.001$ ) and significantly lower in neuroticism than other clusters ( $p < 0.001$ ). Temperate travelers scored significantly higher in neuroticism, agreeableness, and conscientiousness than sensitive travelers, introverted travelers, and moderate travelers ( $p < 0.001$ ). Introverted travelers scored significantly lower in openness to experience, agreeableness, and conscientiousness than sensitive travelers, cogitative travelers, temperate travelers, and moderate travelers ( $p < 0.001$ ). Moderate travelers had relatively moderate scores in all five personality traits.

**Table 4.** Results of one-way ANOVA in personality traits among five clusters.

Personality Trait	Cluster	Mean ± SE	F-Value	p	Post-Hoc Test
Neuroticism	a. Sensitive travelers (n = 119)	5.71 ± 0.07	364.59	0.000	a > c > d > e > b
	b. Cogitative travelers (n = 113)	2.27 ± 0.07			
	c. Temperate travelers (n = 176)	5.17 ± 0.06			
	d. Introverted travelers (n = 87)	3.14 ± 0.12			
	e. Moderate travelers (n = 182)	3.54 ± 0.06			
Extraversion	a. Sensitive travelers (n = 119)	3.03 ± 0.08	178.84	0.000	c, b > e > a, d
	b. Cogitative travelers (n = 113)	5.04 ± 0.09			
	c. Temperate travelers (n = 176)	5.07 ± 0.06			
	d. Introverted travelers (n = 87)	2.91 ± 0.11			
	e. Moderate travelers (n = 182)	3.52 ± 0.06			
Openness to experience	a. Sensitive travelers (n = 119)	4.58 ± 0.10	168.72	0.000	b, c > e > a > d
	b. Cogitative travelers (n = 113)	6.04 ± 0.06			
	c. Temperate travelers (n = 176)	5.90 ± 0.05			
	d. Introverted travelers (n = 87)	3.54 ± 0.09			
	e. Moderate travelers (n = 182)	4.96 ± 0.06			
Agreeableness	a. Sensitive travelers (n = 119)	5.16 ± 0.08	124.29	0.000	b, c > e, a > d
	b. Cogitative travelers (n = 113)	6.02 ± 0.06			
	c. Temperate travelers (n = 176)	5.87 ± 0.05			
	d. Introverted travelers (n = 87)	4.00 ± 0.10			
	e. Moderate travelers (n = 182)	5.38 ± 0.04			
Conscientiousness	a. Sensitive travelers (n = 119)	4.90 ± 0.11	114.67	0.000	b > c > e, a > d
	b. Cogitative travelers (n = 113)	5.99 ± 0.07			
	c. Temperate travelers (n = 176)	5.56 ± 0.07			
	d. Introverted travelers (n = 87)	3.39 ± 0.09			
	e. Moderate travelers (n = 182)	4.96 ± 0.06			

#### 4.4. Risk Perceptions and Travel Behavior Differences among the Five Clusters

Table 5 compares the risk perceptions (i.e., physical risk, financial and benefit risk, and psychological risk) and travel behaviors (i.e., overall satisfaction, willingness to revisit, and recommendation of the sites to others) of the five groups. Temperate travelers had the highest scores for physical risk, financial and benefit risk, and psychological risk, while introverted travelers had the lowest scores. Cogitative travelers had a significantly greater overall satisfaction than sensitive travelers and introvert travelers. Sensitive travelers were significantly less willing to travel than the other travelers. Cogitative travelers and temperate travelers were significantly more willing to recommend the site to others than sensitive travelers, introverted travelers, and moderate travelers.

**Table 5.** Comparisons for risk perceptions and travel behaviors of five groups by one-way ANOVAs.

Satisfaction/ Behavioral Intention	Cluster	Mean ± SE	F-Value	p	Bonferroni Test
Physical risk	a. Sensitive travelers	5.30 ± 0.14	15.15	0.000	c > a, b, e > d
	b. Cogitative travelers	5.30 ± 0.13			
	c. Temperate travelers	5.84 ± 0.09			
	d. Introverted travelers	4.55 ± 0.16			
	e. Moderate travelers	5.07 ± 0.09			

Table 5. Cont.

Satisfaction/	Cluster	Mean $\pm$ SE	F-Value	<i>p</i>	Bonferroni Test
Financial and benefit risk			10.98	0.000	c, a, b, e > d
	a. Sensitive travelers	4.85 $\pm$ 0.12			
	b. Cogitative travelers	4.59 $\pm$ 0.13			
	c. Temperate travelers	5.04 $\pm$ 0.10			
	d. Introverted travelers	4.01 $\pm$ 0.15			
Psychological risk			12.69	0.000	c, a > b, d, e
	a. Sensitive travelers	4.79 $\pm$ 0.15			
	b. Cogitative travelers	4.05 $\pm$ 0.16			
	c. Temperate travelers	4.89 $\pm$ 0.13			
	d. Introverted travelers	3.66 $\pm$ 0.17			
Overall satisfaction			2.71	0.029	b, c > d, e > a
	a. Sensitive travelers	4.26 $\pm$ 0.16			
	b. Cogitative travelers	4.94 $\pm$ 0.17			
	c. Temperate travelers	4.70 $\pm$ 0.13			
	d. Introverted travelers	4.41 $\pm$ 0.17			
Willingness to revisit			3.38	0.012	b, c, e, d > a
	a. Sensitive travelers	4.21 $\pm$ 0.17			
	b. Cogitative travelers	4.97 $\pm$ 0.18			
	c. Temperate travelers	4.77 $\pm$ 0.14			
	d. Introverted travelers	4.45 $\pm$ 0.18			
Willingness to recommend the site to others			2.55	0.038	b, c > a, d, e
	a. Sensitive travelers	4.33 $\pm$ 0.17			
	b. Cogitative travelers	4.98 $\pm$ 0.18			
	c. Temperate travelers	4.76 $\pm$ 0.14			
	d. Introverted travelers	4.47 $\pm$ 0.18			
	e. Moderate travelers	4.52 $\pm$ 0.13			

## 5. Discussion

### 5.1. Theoretical Implications

Scholars have suggested that travel risk negatively influences tourism satisfaction [54] and travel intention [17,21,55] during periods of health threat. Moreover, research on COVID-19 has explored the factors influencing travel behavior and intention, such as risk perceptions [11,16,47], travel attitudes [17], risk image [18], and personality traits [21,41]. Tepavčević et al. [21] indicated that individuals' travel anxiety, fears of the pandemic, and behavioral intentions during the COVID-19 period may vary with their personality traits. Several studies have used segmentation by personality traits to understand phenomena, such as mobile usage patterns [19] and fashion consciousness in Generation Y [27]. Previous studies have segmented tourists by actual travel behaviors [56], travel risk perceptions [16,55,57], and risk attitudes [58]. However, no study has deeply explored individual differences by segmenting tourist personality traits and has further identified the attributes of travel risk, satisfaction, and travel intention by marketing segmentation. By introducing strategies for marketing segmentation through tourist personality traits for destination managers to develop more effective marketing strategies during outbreaks, this study potentially contributes to the literature and applies the use of marketing strategies by researchers in tourism studies.

The empirical results indicated that sensitive travelers perceived risk at greater frequencies, but had the least satisfaction and travel intention, which is consistent with the findings of Tepavčević et al. [21] and Aumeboonsuke and Caplanova [38]. In outbreaks, neurotic tourists have more fears of the pandemic and are not willing to travel [21]. Moreover, Aumeboonsuke and Caplanova [38] reported that neurotic tourists have more risk aversion than people with other more prominent personality traits, which is consistent

with the behavioral intentions of sensitive travelers. This study also confirms that sensitive travelers have high risk perceptions of physical, financial, and beneficial factors, in addition to high psychological risks; they have the least satisfaction and lowest travel intention during outbreaks in these five segments, which contributes to the literature.

Cogitative travelers perceive fewer risks than sensitive travelers and temperate travelers, but represent the highest levels of satisfaction and behavioral intention. Bujisic et al. [59] found that people with a high trait of openness to experience have more satisfaction and destination loyalty than those with the other four personality traits because they immerse themselves into activities easily. Khoi et al. [60] argued that openness to experience encourages people to seek novel and inspirational activities, which fosters their satisfaction and loyalty. Leri and Theodoridis [40] also found that people with low neuroticism perceive the servicescape more acutely and have higher intentions to revisit. This study confirms that cogitative travelers had the highest satisfaction and behavioral intentions during the pandemic, which expands our knowledge of tourism during the COVID-19 pandemic.

The empirical results suggest that the temperate traveler group perceives the most risks of all the groups, which is consistent with the results of Jani et al. [29] and Siegrist et al. [61]; this indicates that travelers in this group are likely to search for more information and have more knowledge that leads them to perceive risks while traveling. With more knowledge, tourists can try their best to prevent risks and enjoy their trips, which led to higher satisfaction and loyalty during the pandemic. The results indicated that the levels of pandemic risk perception, satisfaction and behavioral intention of the temperate group seem to be the same as those of satisfaction with tourism development among residents [62] and the levels of behaviors associated with internet searches by tourists [29].

Introverted travelers have extremely different risk perceptions, satisfaction, and willingness to recommend the site to others from those of temperate travelers. Meanwhile, the moderate traveler group had moderate risk perceptions, satisfaction, and behavioral intentions among these five groups. This study identifies different personality trait segments and demonstrates that each segment had different risk perceptions, satisfaction levels, and travel intentions during the pandemic. Accordingly, this study fills research gaps and extends our knowledge of personality traits, risk perception, satisfaction, and travel intention during the pandemic.

## 5.2. Managerial Implications

According to Razavi's [19] study, segmenting by personality traits provides a better understanding of tourists' behavioral intentions than segmenting by demographic variables. Tourism managers should develop marketing strategies and provide suitable products and services based on these five segments to attract potential tourists during pandemic periods. Temperate travelers attach great importance to safety while traveling. Jani et al. [29] suggested that people with high extraversion and neuroticism traits search for pandemic information before traveling. Accordingly, destination managers need to convince them that destinations are safe by providing pandemic prevention measures on websites or social media. Moreover, managers should ensure that the facilities and the environment in the destination are sterilized periodically, or provide noncontact services to create safe places for tourists [63,64].

With high risk perception but low satisfaction, willingness to revisit, and willingness to recommend the site to others, sensitive travelers were found to worry too much and not be satisfied from the trip. Providing low-risk travel activities and environments is, therefore, suggested to allow sensitive travelers to increase their overall satisfaction and behavioral intentions in favor of the low-risk travel patterns in the COVID-19 pandemic period. With high neuroticism attributes, sensitive travelers may avoid interacting with people [35]; thus, tourism managers may provide outdoor recreation activities for single travelers, such as hiking and sightseeing, to reduce their risk perception and increase their satisfaction and recommendations.

Cogitative travelers have the highest ratings for satisfaction, willingness to revisit, and willingness to recommend the site to others; thus, managers should focus on this market segment. As this group has a high rating for travel risk perception, the destination managers should ensure that pandemic prevention measures are implemented precisely to reduce their risk perceptions. Moreover, managers can demonstrate the beauty of the destination and promote strategies (such as coupons for food, beverages, or accommodations) to attract cognitive travelers and raise their satisfaction. Based on the highest recommendation among these five segments, provoking bonuses to cogitative travelers for posting their destination pictures or messages on social media to allure other tourists can help managers promote their destination and ensure more tourists visits [29]. As individuals with high openness to experience, cogitative travelers are likely to search for information about the destination before traveling [29]. Tourism managers should update information on the destination homepage and social media, as well as demonstrate that pandemic prevention measures have been strictly implemented to convince these two segments of travelers. Moreover, marketers should provide interaction activities to meet the personality traits of various travelers, such as experiencing natural or cultural resources. Specifically, compared to temperate travelers, cognitive travelers have lower ratings of neuroticism and are likely to share posts on social media [65]; thus, tourism managers may encourage them to post images and messages, or check in on social media to promote the destination.

Moderate travelers represent the largest proportion of travelers. With mid-level ratings for risk perception and satisfaction, behavioral intention, and recommendation in these five segments, managers need to strengthen information on websites and social media, such as by emphasizing the beauty of destinations, offering assurance of sanitary environments, and offering rebates for services; this may relieve travelers' anxiety and raise satisfaction, loyalty, and pro-environmental behavior, ultimately achieving sustainable tourism [63,66,67]. Moreover, tourism marketers may offer all sorts of activities, well-designed services, and pandemic prevention environments to increase visitors' satisfaction, behavioral intentions, and positive word-of-mouth.

Introverted travelers have the lowest rating of the Big Five traits, risk perceptions, satisfaction, behavior intentions, and recommendation intentions, as they may not be motivated to contact other people. Tourism managers may provide self-guided interpretation services and noncontact services for these tourists to increase their satisfaction, willingness to revisit, and willingness to recommend the site to others, thereby increasing their pro-environmental behavior [68–70]. In addition, tourism managers should remind introverted travelers to obey pandemic prevention measures using placards to prevent pandemic outbreaks.

Accordingly, facing a competitive environment, destination managers should develop their own differentiated products, target consumer groups, build brand images, and introduce differentiated marketing strategies to establish competitive advantages during the pandemic [71].

### *5.3. Limitations and Future Research*

Despite the potential contribution, several research limitations should be acknowledged for future study directions. First, given the cross-sectional nature of this study, the present study failed to elucidate market segmentation for longer periods of time and might not be reflected in longitudinal travel segmentation [72]. To overcome this issue, a multiyear survey is needed.

Second, scholars claim that the Big Five are less reliable in non-WEIRD (i.e., Western, Educated, Industrialized, Rich, and Developed) countries [73]. The present study employed the Big Five to assess the personality traits that could affect the findings, but other personality traits should be investigated [73]. Accordingly, future work is recommended to re-examine segmentation marketing using measures of the Big Five personality traits and other personality traits from an international perspective by collecting multicultural and international data.



Third, although behavioral intentions are crucial for the attitudinal perspective, they seem to be poor predictors of actual behaviors [74,75]. To resolve this issue, further studies should employ qualitative approaches, such as direct behavioral observation, participant observation or implicit measurement techniques, to elucidate the actual behaviors of travelers [76].

Finally, an a priori assumption was made that respondents had thought about their behavioral intentions to travel, revisit, and recommend when conducting this study. However, respondents may not consider these intentions, leading to the survey forcing the respondents to express an opinion to complete the survey; thus, self-generated validity effect seems to be an issue [77,78]. To reduce this effect, adopting a counterbalancing question order with the survey questions arranged non-sequentially is recommended [79].

## 6. Conclusions

Although the market segmentation, travel risk perceptions, satisfaction, and behavior of travelers have been intensively elucidated and discussed in past research, limited previous studies have clarified the market segmentation of travelers based on their personality traits during the COVID-19 pandemic. This study first identified five market segments of travelers, assessed their personality traits, travel risk perceptions, satisfaction, and behaviors, and subsequently elucidated the differences in their travel risk perceptions, satisfactions and behavioral intentions, filling research gaps and contributing to the literature.

Understanding market segments can inform marketing efforts to target prospective travelers, assist tourist destination businesses in developing sustainability management and provide a competitive edge to managers by providing viable marketing strategies [80]. This study's findings elucidate five segments (i.e., sensitive travelers, cogitative travelers, temperate travelers, introverted travelers, and moderate travelers) that are deeply discussed within relevant theoretical frameworks, regarding individual differences by personality traits, travel risk, satisfaction, and behavioral intentions, providing valuable insights for the literature on tourism management.

Market segmentation allows tourism destinations to focus their resources to meet the needs of target travelers more effectively. This study's findings provide an effective tool for market segmentation to create differentiated marketing strategies for segments, and improve customer relationship management. Understanding potential target travelers and formulating differentiated marketing strategies for different travelers can lead to competitive advantages.

By proposing diverse marketing strategies in light of these findings, this study sheds light on previously reported but unexamined market segments among travelers during the COVID-19 pandemic. This study's market segmentation elucidates the reasons for travel and behavioral intentions, and ultimately leads to sustainable tourism.

Finally, we conclude that travelers (i.e., sensitive travelers, cogitative travelers, temperate travelers, introverted travelers, and moderate travelers) with different personality traits have different risk perceptions and travel behaviors. By providing information for differentiated marketing, the tourism industry can effectively develop diverse marketing strategies that target specific traveler segments to satisfy them; this can subsequently increase behavioral intentions. Therefore, this study extends knowledge on the travel destination market during the pandemic and significantly contributes to the literature.

**Author Contributions:** All listed authors have contributed directly to this paper. T.-H.L. was responsible for the study conception and design. T.-H.L. and F.-H.J. performed the data collection, data analysis and writing of the manuscript. All authors were responsible for carrying out critical revisions of the paper for content. All authors have read and agreed to the published version of the manuscript.

**Funding:** This research received no external funding.

**Institutional Review Board Statement:** Not applicable.

**Informed Consent Statement:** Not applicable.

**Data Availability Statement:** Not applicable.

**Conflicts of Interest:** The authors declare no conflict of interest.

## References

1. Cró, S.; Martins, A.M. Structural breaks in international tourism demand: Are they caused by crises or disasters? *Tour. Manag.* **2017**, *63*, 3–9. [CrossRef] [PubMed]
2. Uğur, N.G.; Akbiyık, A. Impacts of COVID-19 on global tourism industry: A cross-regional comparison. *Tour. Manag. Persp.* **2020**, *36*, 100744. [CrossRef] [PubMed]
3. Gössling, S.; Scott, D.; Hall, C.M. Pandemics, tourism, and global change: A rapid assessment of COVID-19. *J. Sustain. Tour.* **2021**, *29*, 1–20. [CrossRef]
4. Morakabati, Y.; Page, S.J.; Fletcher, J. Emergency management and tourism stakeholder responses to crises: A global survey. *J. Travel Res.* **2017**, *56*, 299–316. [CrossRef] [PubMed]
5. Ritchie, B.W.; Jiang, Y. A review of research on tourism risk, crisis and disaster management: Launching the annals of tourism research curated collection on tourism risk, crisis and disaster management. *Ann. Tour. Res.* **2019**, *79*, 102812. [CrossRef]
6. Bostrom, A.; Böhm, G.; O'Connor, R.E.; Hanss, D.; Bodi-Fernandez, O.; Halder, P. Comparative risk science for the coronavirus pandemic. *J. Risk Res.* **2020**, *23*, 902–911. [CrossRef]
7. Collins-Kreiner, N.; Ram, Y. National tourism strategies during the COVID-19 pandemic. *Ann. Tour. Res.* **2021**, *89*, 103076. [CrossRef]
8. Yang, Y.; Zhang, H.; Chen, X. Coronavirus pandemic and tourism: Dynamic stochastic general equilibrium modeling of infectious disease outbreak. *Ann. Tour. Res.* **2020**, *83*, 102913. [CrossRef]
9. Dolnicar, S.; Zare, S. COVID-19 and Airbnb—disrupting the disruptor. *Ann. Tour. Res.* **2020**, *83*, 102961. [CrossRef]
10. Abdelrahman, M. Personality traits, risk perception, and protective behaviors of Arab residents of Qatar during the COVID-19 pandemic. *Int. J. Ment. Health Addict.* **2022**, *20*, 237–248. [CrossRef]
11. Shin, H.; Kang, J. Reducing perceived health risk to attract hotel customers in the COVID-19 pandemic era: Focused on technology innovation for social distancing and cleanliness. *Int. J. Hosp. Manag.* **2020**, *91*, 102664. [CrossRef]
12. Horstmann, K.T.; Rauthmann, J.F.; Sherman, R.A.; Ziegler, M. Unveiling an exclusive link: Predicting behavior with personality, situation perception, and affect in a preregistered experience sampling study. *J. Pers. Soc. Psychol.* **2021**, *120*, 1317–1343. [CrossRef] [PubMed]
13. Machin, M.A.; Sankey, K.S. Relationships between young drivers' personality characteristics, risk perceptions, and driving behaviour. *Accid. Anal. Prev.* **2008**, *40*, 541–547. [CrossRef] [PubMed]
14. Assaf, A.; Scuderi, R. COVID-19 and the recovery of the tourism industry. *Tour. Econ.* **2020**, *26*, 731–733. [CrossRef]
15. Chua, B.L.; Al-Ansi, A.; Lee, M.J.; Han, H. Impact of health risk perception on avoidance of international travel in the wake of a pandemic. *Curr. Issues Tour.* **2021**, *24*, 985–1002. [CrossRef]
16. Neuburger, L.; Egger, R. Travel risk perception and travel behaviour during the COVID-19 pandemic 2020: A case study of the DACH region. *Curr. Issues Tour.* **2021**, *24*, 1003–1016. [CrossRef]
17. Sánchez-Cañizares, S.M.; Cabeza-Ramírez, L.J.; Muñoz-Fernández, G.; Fuentes-García, F.J. Impact of the perceived risk from COVID-19 on intention to travel. *Curr. Issues Tour.* **2021**, *24*, 970–984. [CrossRef]
18. Bhati, A.S.; Mohammadi, Z.; Agarwal, M.; Kamble, Z.; Donough-Tan, G. Motivating or manipulating: The influence of health-protective behaviour and media engagement on post-COVID-19 travel. *Curr. Issues Tour.* **2021**, *24*, 2088–2092. [CrossRef]
19. Razavi, R. Personality segmentation of users through mining their mobile usage patterns. *Int. J. Hum-Comput. Stud.* **2020**, *143*, 102470. [CrossRef]
20. Lin, C.F. Segmenting customer brand preference: Demographic or psychographic. *J. Prod. Brand Manag.* **2002**, *11*, 249–268. [CrossRef]
21. Tepavčević, J.; Blešić, I.; Petrović, M.D.; Vukosav, S.; Bradić, M.; Garača, V.; Gajić, T.; Lukić, D. Personality traits that affect travel intentions during pandemic COVID-19: The case study of Serbia. *Sustainability* **2021**, *13*, 12845. [CrossRef]
22. Lee, T.H.; Tseng, C.H. How personality and risk-taking attitude affect the behavior of adventure recreationists. *Tour. Geogr.* **2015**, *17*, 307–331. [CrossRef]
23. Rothermich, K.; Johnson, E.K.; Griffith, R.M.; Beingolea, M.M. The influence of personality traits on attitudes towards climate change—An exploratory study. *Pers. Individ. Differ.* **2021**, *168*, 110304. [CrossRef]
24. Poier, S. Towards a psychology of solar energy: Analyzing the effects of the Big Five personality traits on household solar energy adoption in Germany. *Energy Res. Soc. Sci.* **2021**, *77*, 102087. [CrossRef]
25. Whittingham, N.; Boecker, A.; Grygorczyk, A. Personality traits, basic individual values and GMO risk perception of twitter users. *J. Risk Res.* **2020**, *23*, 522–540. [CrossRef]
26. Zajenkowski, M.; Jonason, P.K.; Leniarska, M.; Kozakiewicz, Z. Who complies with the restrictions to reduce the spread of COVID-19? Personality and perceptions of the COVID-19 situation. *Pers. Individ. Differ.* **2020**, *166*, 110199. [CrossRef]
27. Kaur, H.; Anand, S. Segmenting Generation Y using the Big Five personality traits: Understanding differences in fashion consciousness, status consumption and materialism. *Young Cons.* **2018**, *19*, 382–401. [CrossRef]

28. Hogan, R.; Hogan, J.; Roberts, B.W. Personality measurement and employment decisions: Questions and answers. *Am. Psychol.* **1996**, *51*, 469–477. [CrossRef]
29. Jani, D.; Jang, J.H.; Hwang, Y.H. Big five factors of personality and tourists' Internet search behavior. *Asia Pac. J. Tour Res.* **2014**, *19*, 600–615. [CrossRef]
30. Ai, P.; Liu, Y.; Zhao, X. Big Five personality traits predict daily spatial behavior: Evidence from smartphone data. *Pers. Individ. Differ.* **2019**, *147*, 285–291. [CrossRef]
31. Nikčević, A.V.; Marino, C.; Kolubinski, D.C.; Leach, D.; Spada, M.M. Modelling the contribution of the Big Five personality traits, health anxiety, and COVID-19 psychological distress to generalised anxiety and depressive symptoms during the COVID-19 pandemic. *J. Affect. Disord.* **2021**, *279*, 578–584. [CrossRef] [PubMed]
32. Kim, M.J.; Hall, C.M.; Bonn, M. Can the value-attitude-behavior model and personality predict international tourists' biosecurity practice during the pandemic? *J. Hosp. Tour. Manag.* **2021**, *48*, 99–109. [CrossRef]
33. Costa, P.T.; McCrae, R.R. Personality disorders and the five-factor model of personality. *J. Pers. Disord.* **1990**, *4*, 362–371. [CrossRef]
34. Haddoud, M.Y.; Onjewu, A.K.E.; Al-Azab, M.R.; Elbaz, A.M. The psychological drivers of entrepreneurial resilience in the tourism sector. *J. Bus. Res.* **2022**, *141*, 702–712. [CrossRef]
35. Juric, J.; Lindenmeier, J.; Arnold, C. Do emotional solidarity factors mediate the effect of personality traits on the inclination to use nonmonetary peer-to-peer accommodation networks? *J. Travel Res.* **2021**, *60*, 47–64. [CrossRef]
36. Presenza, A.; Abbate, T.; Meleddu, M.; Sheehan, L. Start-up entrepreneurs' personality traits. An exploratory analysis of the Italian tourism industry. *Curr. Issues Tour.* **2020**, *23*, 2146–2164. [CrossRef]
37. Kvasova, O. The Big Five personality traits as antecedents of eco-friendly tourist behavior. *Pers. Individ. Differ.* **2015**, *83*, 111–116. [CrossRef]
38. Aumeboonsuke, V.; Caplanova, A. An analysis of impact of personality traits and mindfulness on risk aversion of individual investors. *Curr. Psychol.* **2021**; *in press*.
39. Zhang, Y.; Huang, Y.; Wang, Y.; Casey, T.W. Who uses a mobile phone while driving for food delivery? The role of personality, risk perception, and driving self-efficacy. *J. Saf. Res.* **2020**, *73*, 69–80. [CrossRef]
40. Leri, I.; Theodoridis, P. How do personality traits affect visitor's experience, emotional stimulation and behaviour? The case of wine tourism. *Tour. Rev.* **2020**, *76*, 1013–1049. [CrossRef]
41. Talwar, S.; Srivastava, S.; Sakashita, M.; Islam, N.; Dhir, A. Personality and travel intentions during and after the COVID-19 pandemic: An artificial neural network (ANN) approach. *J. Bus. Res.* **2022**, *142*, 400–411. [CrossRef]
42. Wolff, K.; Larsen, S.; Øgaard, T. How to define and measure risk perceptions. *Ann. Tour. Res.* **2019**, *79*, 102759. [CrossRef]
43. Dryhurst, S.; Schneider, C.R.; Kerr, J.; Freeman, A.L.; Recchia, G.; Van Der Bles, A.M.; Spiegelhalter, D.; Van Der Linden, S. Risk perceptions of COVID-19 around the world. *J. Risk Res.* **2020**, *23*, 994–1006. [CrossRef]
44. Kim, M.J.; Lee, C.K.; Petrick, J.F.; Kim, Y.S. The influence of perceived risk and intervention on international tourists' behavior during the Hong Kong protest: Application of an extended model of goal-directed behavior. *J. Hosp. Tour. Manag.* **2020**, *45*, 622–632. [CrossRef]
45. Xu, L.; Cong, L.; Wall, G.; Yu, H. Risk perceptions and behavioral intentions of wildlife tourists during the COVID-19 pandemic in China. *J. Ecotour.* **2021**; *in press*. [CrossRef]
46. Yin, J.; Cheng, Y.; Bi, Y.; Ni, Y. Tourists perceived crowding and destination attractiveness: The moderating effects of perceived risk and experience quality. *J. Destin. Mark. Manag.* **2020**, *18*, 100489. [CrossRef]
47. Bae, S.Y.; Chang, P.J. The effect of coronavirus disease-19 (COVID-19) risk perception on behavioural intention towards 'untact' tourism in South Korea during the first wave of the pandemic (March 2020). *Curr. Issues Tour.* **2021**, *24*, 1017–1035. [CrossRef]
48. Akhtar, N.; Nadeem Akhtar, M.; Usman, M.; Ali, M.; Iqbal Siddiqi, U. COVID-19 restrictions and consumers' psychological reactance toward offline shopping freedom restoration. *Serv. Ind. J.* **2020**, *40*, 891–913. [CrossRef]
49. Stone, R.N.; Grønhaug, K. Perceived risk: Further considerations for the marketing discipline. *Eur. J. Mark.* **1993**, *27*, 39–50. [CrossRef]
50. Lee, T.H. A structural model to examine how destination image, attitude, and motivation affect the future behavior of tourists. *Leis. Sci.* **2009**, *31*, 215–236. [CrossRef]
51. Everitt, B.; Landau, S.; Leese, M. *Cluster Analysis*, 4th ed.; Arnold: London, UK, 2001.
52. DeVellis, R.F.; Thorpe, C.T. *Scale Development: Theory and Applications*, 5th ed.; SAGE: New York, NY, USA, 2021.
53. Hair, J.J.F.; Black, W.C.; Babin, B.J.; Anderson, R.E. *Multivariate Data Analysis*, 8th ed.; Prentice-Hall: Hoboken, NJ, USA, 2019.
54. Dayour, F.; Park, S.; Kimbu, A.N. Backpackers' perceived risks towards smartphone usage and risk reduction strategies: A mixed methods study. *Tour. Manag.* **2019**, *72*, 52–68. [CrossRef]
55. Liu-Lastres, B.; Schroeder, A.; Pennington-Gray, L. Cruise line customers' responses to risk and crisis communication messages: An application of the risk perception attitude framework. *J. Travel Res.* **2019**, *58*, 849–865. [CrossRef]
56. Li, J.; Nguyen, T.H.H.; Coca-Stefaniak, J.A. Understanding post-pandemic travel behaviours—China's Golden Week. *J. Hosp. Tour. Manag.* **2021**, *49*, 84–88. [CrossRef]
57. Wang, J.; Liu-Lastres, B.; Ritchie, B.W.; Pan, D.Z. Risk reduction and adventure tourism safety: An extension of the risk perception attitude framework (RPAF). *Tour. Manag.* **2019**, *74*, 247–257. [CrossRef]
58. Karl, M.; Muskat, B.; Ritchie, B.W. Which travel risks are more salient for destination choice? An examination of the tourist's decision-making process. *J. Destin. Mark. Manag.* **2020**, *18*, 100487. [CrossRef]

59. Bujisic, M.; Bilgihan, A.; Smith, S. Relationship between guest experience, personality characteristics, and satisfaction: Moderating effect of extraversion and openness to experience. *Tour. Anal.* **2015**, *20*, 25–38. [CrossRef]
60. Khoi, N.H.; Phong, N.D.; Le, A.N.H. Customer inspiration in a tourism context: An investigation of driving and moderating factors. *Curr. Issues Tour.* **2020**, *23*, 2699–2715. [CrossRef]
61. Siegrist, M.; Bearth, A.; Hartmann, C. The impacts of diet-related health consciousness, food disgust, nutrition knowledge, and the Big Five personality traits on perceived risks in the food domain. *Food Qual. Prefer.* **2022**, *96*, 104441. [CrossRef]
62. Moghavvemi, S.; Woosnam, K.M.; Hamzah, A.; Hassani, A. Considering residents' personality and community factors in explaining satisfaction with tourism and support for tourism development. *Tour. Plan. Dev.* **2021**, *18*, 267–293. [CrossRef]
63. Chi, X.; Han, H.; Kim, S. Protecting yourself and others: Festival tourists' pro-social intentions for wearing a mask, maintaining social distancing, and practicing sanitary/hygiene actions. *J. Sustain. Tour.* **2022**, *30*, 1915–1936. [CrossRef]
64. Sun, W.; Zhang, F.; Tai, S.; Wu, J.; Mu, Y. Study on glacial tourism exploitation in the Dagu glacier scenic spot based on the AHP-ASEB method. *Sustainability* **2021**, *13*, 2614. [CrossRef]
65. Tsai, T.H.; Chang, H.T.; Chang, Y.C.; Chang, Y.S. Personality disclosure on social network sites: An empirical examination of differences in Facebook usage behavior, profile contents and privacy settings. *Comput. Hum. Behav.* **2017**, *76*, 469–482. [CrossRef]
66. Lee, T.H.; Jan, F.H. The effects of recreation experience, environmental attitude, and biospheric value on the environmentally responsible behavior of nature-based tourists. *Environ. Manag.* **2015**, *56*, 193–208. [CrossRef] [PubMed]
67. Lee, T.H.; Jan, F.H. The influence of recreation experience and environmental attitude on the environmentally responsible behavior of community-based tourists in Taiwan. *J. Sustain. Tour.* **2015**, *23*, 1063–1094. [CrossRef]
68. Apps, K.; Dimmock, K.; Huveneers, C. Turning wildlife experiences into conservation action: Can white shark cage-dive tourism influence conservation behaviour? *Mar. Policy* **2018**, *88*, 108–115. [CrossRef]
69. Lee, T.H.; Jan, F.H.; Chen, J.C. Influence analysis of interpretation services on ecotourism behavior for wildlife tourists. *J. Sustain. Tour.* **2021**; *in press*. [CrossRef]
70. Wang, J.; Hu, X.; Tong, C. Urban community sustainable development patterns under the influence of COVID-19: A case study based on the non-contact interaction perspective of Hangzhou City. *Sustainability* **2021**, *13*, 3575. [CrossRef]
71. Xiao, X.; Fang, C.; Lin, H.; Chen, J. A framework for quantitative analysis and differentiated marketing of tourism destination image based on visual content of photos. *Tour. Manag.* **2022**, *93*, 104585. [CrossRef]
72. Unanue, W.; Vignoles, V.L.; Dittmar, H.; Vansteenkiste, M. Life goals predict environmental behavior: Cross-cultural and longitudinal evidence. *J. Environ. Psychol.* **2016**, *46*, 10–22. [CrossRef]
73. Laajaj, R.; Macours, K.; Pinzon Hernandez, D.A.; Arias, O.; Gosling, S.D.; Potter, J.; Rubio-Codina, M.; Vakis, R. Challenges to capture the big five personality traits in non-WEIRD populations. *Sci. Adv.* **2019**, *5*, eaaw5226. [CrossRef]
74. Higham, J.; Reis, A.; Cohen, S.A. Australian climate concern and the 'attitude-behaviour gap'. *Curr. Issues Tour.* **2016**, *19*, 338–354. [CrossRef]
75. Juvan, E.; Dolnicar, S. The attitude-behaviour gap in sustainable tourism. *Ann. Tour. Res.* **2014**, *48*, 76–95. [CrossRef]
76. Creswell, J.W.; Creswell, J.D. *Research Design: Qualitative, Quantitative, and Mixed Methods Approaches*; Sage publications: New York, NY, USA, 2017.
77. Chandon, P.; Morwitz, V.G.; Reinartz, W.J. Do intentions really predict behavior? Self-generated validity effects in survey research. *J. Mark.* **2005**, *69*, 1–14. [CrossRef]
78. Henderson, I.L.; Tsui, K.W.H.; Ngo, T.; Gilbey, A.; Avis, M. Airline brand choice in a duopolistic market: The case of New Zealand. *Transp. Res. Part A Policy Pract.* **2019**, *121*, 147–163. [CrossRef]
79. Podsakoff, P.M.; MacKenzie, S.B.; Lee, J.Y.; Podsakoff, N.P. Common method biases in behavioral research: A critical review of the literature and recommended remedies. *J. Appl. Psychol.* **2003**, *88*, 879–903. [CrossRef]
80. Meepprom, S. A motive-based segmentation of special event visitors interacting in cultural events. *Event Manag.* **2022**; *in press*.

**Disclaimer/Publisher's Note:** The statements, opinions and data contained in all publications are solely those of the individual author(s) and contributor(s) and not of MDPI and/or the editor(s). MDPI and/or the editor(s) disclaim responsibility for any injury to people or property resulting from any ideas, methods, instructions or products referred to in the content.

## Article

# Perspectives for Tourism Development in the Post-Pandemic Period in the Opinions of University Students

Dariusz Jacek Olszewski-Strzyżowski \*, Marcin Pasek  and Mariusz Lipowski 

Faculty of Physical Culture, Gdansk University of Physical Education and Sport, 80-336 Gdansk, Poland

\* Correspondence: [dariusz.olszewski@awf.gda.pl](mailto:dariusz.olszewski@awf.gda.pl)

**Abstract:** The dynamic growth and evolution of tourism in recent times and its growing importance for the economies of many countries has been drastically hampered by the COVID-19 pandemic. The pandemic has not only affected tourism through travel restrictions and the associated difficulties faced by the tourism industry, but it has also changed people's tourism preferences (mass tourism has been replaced by more sustainable tourism), as well as their motives for undertaking tourism. The aim of this study is to assess students' views on the role of the COVID-19 pandemic in shaping their tourism experiences and beliefs about the future of tourism in the perspective of the pandemic and its global implications. The issue is of interest given the young age of the study participants and the belief that they are key influencers in shaping the image of global tourism in the post-pandemic period. The participants of this study were 196 students from higher education institutions in Gdansk, representing both tourism- and non-tourism-related majors. The aim of this study was achieved using the diagnostic survey method, collecting information about the respondents' beliefs based on a research tool in the form of a survey questionnaire. The results suggest that tourism activities and students' motives for engaging in them may change after the pandemic expires compared to before COVID-19. In general, studying tourism is associated with moderate attitudes towards the aftermath of the coronavirus compared to the more radical responses of students who do not study tourism. A limitation of this pilot study was the geographical restriction of the respondents to the Polish population, which makes it difficult at this stage to draw more generalized conclusions.

**Keywords:** youth; students; tourist activity; COVID-19 pandemic; trends; perspectives; contemporary tourism



**Citation:** Olszewski-Strzyżowski, D.J.; Pasek, M.; Lipowski, M. Perspectives for Tourism Development in the Post-Pandemic Period in the Opinions of University Students. *Sustainability* **2022**, *14*, 16833. <https://doi.org/10.3390/su142416833>

Academic Editors: Zygmunt Kruczek and Bartłomiej Walas

Received: 26 October 2022

Accepted: 12 December 2022

Published: 15 December 2022

**Publisher's Note:** MDPI stays neutral with regard to jurisdictional claims in published maps and institutional affiliations.



**Copyright:** © 2022 by the authors. Licensee MDPI, Basel, Switzerland. This article is an open access article distributed under the terms and conditions of the Creative Commons Attribution (CC BY) license (<https://creativecommons.org/licenses/by/4.0/>).

## 1. Introduction

As the consensus view is that the COVID-19 pandemic has had a significant impact on the global labour market [1–3], this can be considered in the perspective of tourism development both as a threat to the functioning of employers and as a barrier to participation in tourism trips. Young people and students approaching psychological, social and financial maturity will soon become an important segment of tourists, and their tourism activities should therefore be analysed and studied. Travelling and engaging in various tourism activities, and therefore accumulating various tourism experiences, plays significant roles in shaping the personalities of young people. It is therefore worth investigating how people (in this case, youth—students) choose the types of tourism activities they undertake and their level of involvement in these activities. This may help countries guide this group of consumers to appropriate tourism products and services in the future. At the same time, each type of tourism activity is dictated by certain motivations and is influenced by external factors, such as the finances of the tourist, the geopolitical and economic situation, the state of the pandemic in the intended destinations and their sense of security, which is at least partly related to the COVID-19 pandemic.

The analysis of the signalled research problem, due to the links between human behaviour and the epidemiological situation, defined as an ecological threat, refers to several

theoretical models. These include the Diffusion of Innovation Theory [4], considered in light of the phenomenon of the spread of new tourism trends in society. The issue of human functioning in the perspective of COVID-19, considered as a natural disaster and at the same time a source of crisis in the personal, social, financial and environmental dimensions, refers instead to the Ecosystem Theory [5]. Finally, the urgency of human adaptation under conditions of global change such as the effects of a pandemic is presumptively close to Resilience Theory [6].

The issue of shaping the tourism space in a pandemic and post-pandemic reality has received much attention in the last few decades [7–10]. The circumstances shaping tourism are conceptualised in a number of ways, among which, albeit infrequently, the issue of youth tourism engagement also appears [11]. Within this issue, the issue of the influence of the academic system through its directionally different subject matter on students' beliefs and attitudes relating to the stimulators and barriers to tourism development resulting from the coronavirus pandemic should be considered a research gap. Learning about these determinants may be important from the point of view of the potential presence of representatives of the younger generation in the various sectors of the tourism economy in the post-COVID period.

In relation to the above, the aim of this article is to identify motivations, preferences and trends related to tourism activity and to learn about the opinions of young students (studying majors related and unrelated to tourism at universities in Gdansk) on the role of the COVID-19 pandemic in shaping their tourism activities.

The realisation of this objective will enable the formulation of answers to several key research questions: To what extent will the COVID-19 pandemic affect the tourism potential of the destination in the following years? To what extent will the COVID-19 pandemic affect pro-tourism behaviour in future years? To what extent will the COVID-19 pandemic affect the uptake of tourism activities in the following years? To what extent will the COVID-19 pandemic affect the functioning of the Polish and international tourism industry in the years to come? To what extent will the COVID-19 pandemic affect the functioning and condition of tour operators in the years to come?

Regardless of the questions that arise, a natural one, as it follows from the division into two groups of respondents, is the research question with the following content: Do the opinions of tourism students and non-tourism students on the role of the COVID-19 pandemic in shaping tourism and its accompanying services differ?

The research hypothesis relating to this question contains an important caveat that does not allow it to be formulated categorically. This is because assuming the precise placement of students' answers on a scale is impossible to predict. This is due to the innovative nature of the research being presented. It is therefore difficult to make a reference in the discussion to the results of similar studies.

However, we can tentatively assume that tourism students are more aware of the realities governing current tourism supply and demand, and that they consider the motives for tourism activity in greater depth. This may be fostered by an in-depth knowledge resulting from a dedicated curriculum in a tourism-related degree program, easier access to bibliographic sources and to authorities in the field of tourism and, finally, their own tourism-oriented interests.

The suggestions made in this paper may be helpful in recognising whether studying tourism is part of the formation of an expanded consciousness compared to that of those showing a lack of basic tourism education. The possible lack of differences between the representatives of the two studied groups will indicate an inadequate level of content presented in tourism-related fields of study. In addition, the material presented is intended to fill the gaps related to this issue that can still be observed in the scientific literature.

This article is structured as follows: After the introductory section, the next section is dedicated to youth tourism, moving on to the circumstances surrounding tourism during the COVID-19 pandemic. The methodological section precedes the detailed analysis of the

research problem presented in the signalled five research areas. The final part of this paper is devoted to the discussion and conclusions.

## 2. Trends and Perspectives in Youth Tourism

Until recently, tourism undertaken by children and youths was treated as an unimportant element, especially in the context of international tourism. It used to be largely ignored by tourism services. Fortunately, in recent years, the situation has changed for the better—more and more tourist service providers understand the importance of this segment for the development of tourism (although, of course, the problem of the ‘social exclusion’ of the younger generation has not been entirely eliminated). According to the *Global Code Of Ethics For Tourism*, each one of us has the full right to tourism and to the freedom of movement for touristic purposes. Tourist activity should include respecting human rights, in particular protecting the rights of the most vulnerable groups—children, youths, the elderly and people with disabilities. This is why tourism for families, young people, students, elderly people and people with disabilities is supported by government bodies [12].

The right to engage in tourist activities today is encompassed in the term “accessible tourism” [13], not only in the context of disability, but also youth tourism. The concept of accessible tourism emphasises the need to create services and products and to promote them in a way that takes into account the specific needs of very different social groups (previously excluded from free access to touristic activities for various reasons). And thus it applies to elderly people, people with disabilities, families with children, children and youths, etc. Because youth tourism is a continuously developing segment of the tourism market (as well as access to work in tourist services), its value has been emphasised, for example, in the UNWTO 2030 Agenda for Sustainable Development and the 17 Sustainable Development Goals (SDGs), in particular in the scope of SDG 4—Quality Education and SDG 8—Decent Work and Economic Growth [14].

The current generation of young people and students is classified as the so-called Generation Z (sometimes used alternatively as Generation C—the “C” comes from the word “connected”, and means connected to networks and the Internet) which, according to a United Nations report, in 2019 represented the largest demographic group in the world (2.4 billion people—i.e., 32% of humanity) [15].

Research shows that the level of tourist activity is closely related to age [16]. According to Keyser, one’s age determines the amount of free time devoted to rest and tourism, as well as the likelihood of deciding to travel [17]. Hartman and Cordel report that people aged below 35 are characterised by the highest tourist activity, after which it starts dropping with age [18]. This claim is supported by Murrmann who reported that, among adults, the most touristically active group are those aged 18–24 (comprising 63% of tourists) [19]. Our group of interest is formed by university students aged between 19 and 25 (age brackets as per recommendations of various authors regarding studying this population) [20,21]. Łaciak indicates that youth studying at universities is the group with the highest tourist activity [22].

The tourism segment represented by students is very dynamic. They constitute a very large group of tourists who, through their attitudes, behaviour and preferences, largely shape the tourism market. For them, tourism is a way of life, plays a very important role in their personal development and provides benefits on many levels. There are many factors that motivate them to undertake tourism activities.

In recent years, youth tourism has become one of the fastest developing segments of international tourism. This growth translates into huge social and economic opportunities for local communities, because travelling young people stimulate local tourism businesses, engage in closer social interactions with the host population and support environmental protection. Already in 2010, UNWTO reported that about 20% of 940 million international tourists travelling the world are from this increasingly significant group of consumers [23].

The number increased in the years that followed (in 2016, it was more than 23% of over a billion of tourists travelling internationally every year) [24].

According to the World Youth Student and Educational (WYSE) Travel Confederation, travels by people aged 15 to 29 are motivated either partially or entirely by the desire to get to know other cultures (this includes cultural exchange visits), gaining life experience and/or taking the opportunity to educate oneself either in a formal or informal way outside one's usual environment [25].

In Poland, students are a relatively large social group (in 2021 this was 1.8 million people) [26]. According to research by various authors [27,28], as much as 80–90% of students engage in tourism, and all types of such activities are placed very high in the hierarchy of interests of this social group [29]. The main functions of tourism for youths include hedonist, compensatory, cognitive, emotional, social, adaptive and health functions [30]. These functions allow one to realise the process of education through tourism and self-education of the young generation, and, as a consequence, this aids the development of the personality of a young tourist [31].

According to the Polish Tourism Organisation, the discussed segment of tourists can be characterised as in Table 1 (taking into account both their short and long-term travels).

**Table 1.** The characteristics of the youth tourist segment, according to the Polish Tourism Organisation.

Type of Travel	Characteristics
Short-term	These are people aged about 25, unmarried, often still studying at universities or other educational institutions. They assess their material situation relatively well. In many cases, these are people who still live with their parents, and the ability to combine their own means with the means of their parents may improve their assessment of their material situation. Their main motivations for travelling are visiting friends and relatives, but they also travel for tourism and recreation.
Long-term	These are very young individuals (mean age ranging between 18–22) with primary or secondary education, who still attend schools or universities. They assess their material situation as average or rather good. They usually travel for a longer time to rest or engage in tourism, less frequently to visit friends and relatives.

Source: own elaboration based on: Marketingowa Strategia Polski w sektorze turystyki na lata 2008–2015 (Polish Marketing Strategy in The Tourism Sector for Years 2008–2015), Polska Organizacja Turystyczna (Polish Tourism Organisation), Warszawa, 2008 [32].

As pointed out by Żukowska, tourism allows youths to fulfil their natural need for movement and interest in the world while also providing the conditions for formulating conscious and responsible attitudes towards how it is conducted [33]. According to Alejziak, when we think about youth tourism, we should pay attention to its educational values, which shape and improve the personality of the travelling youths. This happens mainly through getting to know the world and through direct, personal contact with the fauna and flora and with the social life and the people of the visited areas. Partaking in tourism develops certain attitudes towards different areas of life, such as altruism, kindness, empathy and often friendship. Travels encourage the processes of integration, bonding, cooperation and common experiences [34]. According to Dimanche and Richards, tourist activity is an important need in the daily lives of young people, and they treat tourism as part of their lifestyle and statistically travel more frequently than other tourist segments [35,36].

As Blomgren and Ljungström and Wood note [37,38], the main factors that have influenced such a dynamic increase in tourism participation by the younger generation include, in particular, the development of and access to low-cost airlines and new forms of accommodation services, the sharing economy trend, access to the internet, more leisure time, financial support from parents, opportunities to participate in student exchanges and internships abroad (e.g., Erasmus).



It should be assumed that other characteristics of young tourists are the collection of experiences and the creation of content, price sensitivity, spontaneity and the search for individualised offers. Today's young people are characterised by their freedom to use all sorts of technologies; they use telephones, computers and, above all, the Internet, which means they are able to function in the virtual world as well as the real world at the same time. Haddouche and Salomone [39] point out that, in addition to using the Internet to organise a tourist trip, the young generation also wants to share experiences with others (via the Internet) during the trip, for which they mainly use social media (Facebook, Instagram, Snapchat, etc.).

Bizirgianni and Dionysopoulou [40] point out that many members of the younger generation, by visiting various tourist destinations and showcasing their trips on the internet or commenting online, become influencers, promote tourist attractions and encourage other potential tourists to visit tourist destinations.

At the same time, some researchers point out that motivation for tourism and travel by the young generation [41] is a multidimensional phenomenon because it involves seeking novelty, intellectual development and education, fun, recreation and enjoying the peace, experiencing the beauty of nature and the opportunity for socialising. The personalities of young people are not fully developed, which is why it is a research area that is difficult to interpret [36,42]. Thus, there is a need for further and deeper studies of this segment of tourists [43,44].

Table 2 shows the tourism industry (including Poland), too, sees young people as an important and increasingly significant customer segment for tourism products, changing and modifying its tourism offer.

**Table 2.** Tourism industry indications of selected new activities for the 'youth' segment.

Industry	Indicated Changes in Service Provision
Travel agencies	Changes in the organisation of events: in addition to typical leisure trips, entrepreneurs are increasingly offering thematic camps (e.g., "in the saddle", sailing, sports, for youtubers, etc.), language camps (English, German, Italian, Spanish) and offers and proposals for active leisure (sports and leisure games, sightseeing tours, competitions, field games, city games, questing, geocaching, etc.). Particular attention is paid to ensuring the safety of participants in the above activities.
Leisure and recreation offer	Changes in the organisation and forms of entertainment and recreation offered: events are being organised, which are increasingly interdisciplinary in nature (increasing the sense of security during the events, level of the quality of the services, diversity of offers and event programmes, etc.). Programmes include many proposals for active leisure, e.g., sports and recreational games, competitions, workshops, field games, city games, questing, geocaching, conventions (rallies of fans of comics, fantasy, youtubers, bloggers), educational games or games using ICT technologies (e.g., computer games, etc.).

Source: own elaboration based on document: "Badanie opinii pracodawców na temat obecnych i przyszłych kompetencji pracowników w sektorze turystyki", Rada ds. Kompetencji Sektora Turystyka Instytut Turystyki w Krakowie Sp. z o.o, Kraków 2018–2019 [45].

Being aware of the significant global disruption to tourism in recent years (in particular due to the COVID-19 pandemic), the UNWTO points to the important role of youth tourism, which will play a leading role in the future of tourism. During the first Global Youth Tourism Summit (GYTS), which took place on 27 June 2022–3 July 2022 in Sorrento, Italy, it was emphasised that young individuals have to play an active role in the "relaunch" of tourism and they should have a positive impact on making tourism more sustainable, inclusive and accessible [46]. The above is supported by global research conducted by Deloitte, which surveyed over 27,000 representatives of the younger generation. They found that despite individual challenges and personal fears, young people remain eager to promote positive change in their own communities, as well as in the world. This also pertains to the planning

and management of one's own tourist activity, especially where there is a risk of causing damage to local societies through the loss of authenticity [47]. This brings young people closer to the beliefs of representatives of previous generations of youth, especially hippies, who embraced the currently popular ideas of sustainable development and embodied authentic life and individuality, understood as living outside cities, close to and caring for nature [48].

### 3. Tourism during the COVID-19 Pandemic

As noted by Wendt and Olszewski-Strzyżowski [49], tourism is one of the fastest growing services in the modern world. The number of tourists between 1950 and 2018 increased almost 50 times and tourism revenues grew from USD 2 billion to USD 1.5 trillion; however, after a record-breaking 2019, the first quarter of 2020 began under the grip of a coronavirus outbreak, and tourism around the world faced a period of stagnation.

As per the WTTC report, COVID-19 and restrictions on the movement of international tourists caused the world economy to lose almost USD 4.5 billion, and, globally, the contribution of tourism to GNP decreased by 49.1% in comparison to 2019. The spending of intra-national visitors dropped by 45%, while the spending of international visitors dropped by 69.4%. In 2020, 62 million workplaces in tourist services were terminated or seriously affected [50]. The report also states that the segment of tourists who were most affected by the pandemic were women and youth.

As pointed out by Olszewski-Strzyżowski, up until very recently, we lived with the belief that tourism will continue developing forever and without limits (both in terms of tourist services as in terms of tourists' demand for services and products). Unfortunately, this unrestrained worldwide development of the tourism industry has been halted by the COVID-19 pandemic. This particular "tourism lock down" must have a significant influence on future attitudes and preferences in terms of types and forms of tourist activities, including an increase in interest in ecological, pro-social and sustainable approaches to tourism and a decline in mass tourism [51]. Other authors [52–54] also believe that before the COVID-19 pandemic, tourism was constantly developing, and the competition for a better share of the market of tourism destinations was a significant factor in this development. The disruption felt in 2020 due to the pandemic, which was unprecedented at the time, will continue to be felt for at least another few years by both tourists and tourism businesses all over the world.

According to Mirchandani, much evidence indicates that it will take many years for the tourism industry to recover the losses gained due to restrictions on international and intra-national movement [55]. This also shows that risks posed by events such as the global COVID-19 pandemic are relevant to almost every aspect of the global economy besides tourism [56]. Because of this global situation, tourist products have to be constantly developed, and destinations should offer a variety of tourist products that take into account the individual needs of tourists and the influence of the COVID-19 pandemic. Changes in tourist behaviour due to the pandemic phenomenon were identified in the UNWTO report, noting that travellers preferred to travel closer to home, which had a positive impact on domestic tourism; tourists were more likely to opt for nature holidays, rural tourism and road trips due to the many restrictions and the desire to spend time outdoors; young people travelled the most during the first year of the COVID-19 pandemic; the main concerns of consumers were health and safety measures and cancellation policies; consumers were more likely to book last-minute trips due to the unstable global situation and changing travel restrictions; for tourists, supporting the local community in the region visited was an important aspect [57].

Examples of countries taking such initiatives include Austria, by promoting information about travelling within the country (in particular, about the safety restrictions associated with the pandemic, e.g., when using cable cars); Cyprus, by informing tourists about COVID-19-related safety measures in public and tourist transport, hotels, restaurants, beaches, swimming pools and other tourist attractions; Grenada, by promoting the

“Pure Safe Travel” project to ensure that tourists adhere to the safety procedures in hotels, restaurants, transport and tourist attractions; Guatemala, by certifying the tourist services (“Bioseguridad Touristica”) provided by tourist agents, tourist accommodation, archaeological parks, protected areas, yacht marinas, guides and tourist transport organisers, who declare that they will adhere to the epidemiological guidelines associated with COVID-19 prevention; and Indonesia, by promoting the “InDOnesia CARE” project—certificates for tourist services (hotels, gastronomy, transport, etc.) applying the highest standards of cleanliness, health, hygiene, safety and natural environment protection in the context of fighting the pandemic. At the same time, tourists are encouraged to plan their vacation to the country after the COVID-19 pandemic: “Looking for fresh tourist spots to visit after the pandemic? How about taking an eco-friendly trip? Enlighten yourself with these eco-tourism spots in Indonesia to enhance your post-pandemic travel plans and to make a positive impact on the community” [58].

According to UNWTO, in 2020, 100% of the world tourist destinations introduced some travel restrictions: 45% completely forbade tourist entry, 30% either completely or partially cancelled international flights, 18% forbade entry from certain outside areas and 7% introduced other measures (e.g., a 14 day quarantine) [59].

The pandemic not only caused significant changes in the global tourism economy on many levels (countries, regions, destinations, tourist attractions, tourism industries, etc.) but also in the behaviours and motivations expressed by tourists (e.g., the choice of destinations, the choice of tourist services, frequency of travel, health and life protection, sense of safety associated with travel, etc.). As pointed out by Bernas i Pujer [60], individual safety usually constitutes one of the main criteria for selecting a destination for recreational travel (alongside cost and attractiveness), and it is also one of the external determinants that has a huge impact on decisions associated with travel. It is reasonable to believe that, in the age of the pandemic, concern for one’s health, life and wellbeing are the main determinants that tourists take into account when deciding to travel or to abandon their travelling plans.

At the same time, as pointed out by Zorcec and Pop-Jordanova [61], the COVID-19 pandemic has had significant consequences for mental health all over the world, which also impacts tourist behaviour; their study concerned a group of youths and showed that the pandemic can cause greater or lesser distress depending on an individual’s subjective assessment, which is influenced by their stable personality traits. The results of the study revealed significant changes in quality of life, lack of sense of security, changes in mood and behaviour, as well as pessimistic outlooks on the future.

#### 4. Materials and Methods

A total of 196 university students from Gdansk (Poland) took part in this study, including 117 representing the field of tourism and recreation and 79 students from non-tourism-related majors. The timing of the study, which occurred in spring 2022, covers the declining period of the COVID-19 pandemic, to which the aim of the study refers. The research was conducted using a diagnostic survey.

The diagnostic survey method is a way of gathering knowledge about the structural and functional parameters and dynamics of social phenomena. The knowledge gathered with its help also concerns the opinions and views of selected communities, as well as the intensity and directions of development of specific phenomena. It is concerned with all phenomena that do not have an institutional location, but are, on the contrary, as if dispersed in a global population. It is a proven effective way of assessing complex social phenomena. In this survey research, a survey technique was applied using a research tool in the form of a survey questionnaire of my own authorship prepared for this publication.

The questionnaire consisted of 37 questions about the degree of impact of the coronavirus pandemic on numerous tourism sectors, including tourist services. Respondents were given the opportunity to choose a response from options forming an 11-point scale, where a value of ‘0’ on the scale corresponded to the statement “to an extremely low degree”. The middle value of the scale, “5”, corresponded to the statement “to a medium

extent". The maximum value on the scale, "10", corresponds to the statement "to an extremely high degree". The planning of an odd number of scale points was aimed at a symmetric distribution of opinions with a neutral value placed in the middle of the scale.

The number of questions in the survey questionnaire analysed, in accordance with the adopted standards, was optimised with regard to the objectives of the study guiding the authors. At the same time, the number of questions was not too high in order to avoid respondent fatigue, which would exacerbate the tendency for subjective responses. An attempt was also made to avoid too few questions posing a threat to the full exploration of views.

The authors constructed the questions with the conviction that the general rules of question formulation were met. These rules refer to such features of the questions as their relevance, their adaptation to the intellectual level of the respondent or the elimination of references to events too distant in time. In addition, the questionnaire questions presented to the respondents were comprehensible and free of ambiguity. Any questions suggesting an answer were dispensed with and organised into several modules differentiated by content. Thematically, these modules referred to different spheres of perception of tourism reality.

The research tool prepared to meet the objective of this scientific project was constructed under the conditions of the dynamically changing reality accompanying the pandemic. This necessitated treating the current situation of the end of the pandemic very provisionally with the suspicion of non-repetition; hence, in light of time constraints, pilot studies aimed at verifying the reliability of this research tool were abandoned.

The selection of the research sample resulted from a bilateral agreement between the Gdansk University of Physical Education and Sport and one of the secondary schools located in close proximity. The close educational contact consisted, among other things, of lectures for schoolchildren and the promotion of study at this university among students. On the other hand, this cooperation was in accordance with an agreement made between the Pomeranian school superintendent and the ethics committee of the Gdansk University of Physical Education and Sport, represented by the rector. This agreement concerned the evaluation and stimulation of the quality of physical activity of school students in the Pomeranian Voivodeship (agreement number 17/03/05).

## 5. Tourist Trends in the Post-Pandemic Era According to University Students—Our Study

The conducted study allows us to draw the following conclusions: due to significant changes in recent years in global tourist activities, which were influenced by the COVID 19 pandemic, the motivations for tourism exhibited by young people (university students) may have also significantly changed. The description of the results of the study includes the content of each question and a short summary of the answers provided by participants in the two groups. The details are shown in the table below.

The author's assumption is that the changes resulting from the pandemic may concern issues and phenomena including, *inter alia*, the pro-tourist behaviour of tourism participants (travel motivations, choice of holiday destinations, etc.), progress or regression in the development of specific forms of tourism activity, the development or expansion of tourism destinations, the development of the tourism industry and the choice of means of tourism transport. These elements may evolve significantly under the influence of pandemics [62–65].

Taking this into account, the tables presented here contain the opinions expressed by the surveyed groups of tourism students and non-tourism students together with a detailed analysis of them.

Table 3 presents an analysis of respondents' answers to the questions in terms of the impact of the COVID-19 pandemic phenomenon on the destination's tourism potential in the following years.

**Table 3.** Characteristics of respondents' answers to questions within the module impact of the COVID-19 pandemic phenomenon on the tourism potential of the destination in the following years.

Questions	Answers	
	Tourism Students	Non-Tourism Students
To what extent will the COVID-19 pandemic phenomenon affect the reduction in tourism in big city spaces?	The dominant response among tourism students (23.9%) was to indicate a neutral option (value on the scale: "5"). In general, more responses fell into values higher than '5', including extremely high ratings (value on scale: '10'), which were indicated by 15.4% of respondents.	For non-tourism students, the dominant response option was "7" (34.2%) and "8" (26.6%), with the percentage of extremely high averages (scale value: "10") at 3.8%.
To what extent will the COVID-19 pandemic phenomenon affect promotional activities of unpopular tourist destinations?	The response option was indicated by the largest number of tourism students (24.8%). The answer was generally positive (value from "6" to "10") and was marked significantly more often than the answer option with values from "0" to "4".	A similar distribution on the response scale was observed among non-tourism students.
To what extent will the phenomenon of the COVID-19 pandemic affect changes in the budgets of regions/municipalities/cities implementing tourism-related tasks and projects?	For 28.4% of tourism students, they remained neutral to the question, but as many as 50.8% of respondents answered in the affirmative.	Among non-tourism students, these results were at the level of 22.8% and 46.8%, respectively.
To what extent will the phenomenon of the COVID-19 pandemic affect the conduct of tourism promotional activities at government/regional and local levels?	Response options from "6" to "10" were indicated in this case by 45.8% of tourism students, with 31% indicating a value of "5".	For non-tourism students, the values were 46.8% and 44.3%, respectively.
To what extent will the COVID-19 pandemic phenomenon affect the functioning of tourism information?	In the opinion of tourism students, the flow of tourist information will not change significantly under the impact of the pandemic. In total, 31% of respondents answered "5", while "3", "4", "6" and "7" were indicated by a further 38.8%.	In the group of non-tourism students, "5" was chosen by 32.9%, while "3", "4", "6" and "7" were indicated by as many as 57%.

Source: authors survey 2022.

The results of the answers to the questions included in the module relating to the impact of the COVID-19 pandemic on the tourism potential of the destination are relatively similar in the groups of tourism students and non-tourism students. With regard to some responses, some differences are noted, such as when extremely high ratings were indicated by 15.4% of tourism students vs. 3.8% of non-tourism students when answering the question on the degree of impact of the pandemic on the reduction in tourism in big cities.

Table 4 analyses respondents' answers to questions on the impact of the COVID-19 pandemic phenomenon on pro-tourism behaviour undertaken in subsequent years.

**Table 4.** Characteristics of respondents' answers to questions within the module impact of the COVID-19 pandemic phenomenon on pro-tourism behaviour in the following years.

Questions	Answers	
	Tourism Students	Non-Tourism Students
To what extent will the COVID-19 pandemic phenomenon affect the frequency of tourist trips to family and friends?	This is another example of a question to which tourism students responded most often in a neutral manner (value on a scale of '5')—23.1%.	In this case, non-tourism students appeared to be oriented towards higher values on the response scale, with dominant values of "7" (36.7%) and "8" (17.7%).
To what extent will the COVID-19 pandemic phenomenon affect the possible loss of funds previously invested in a tour operator's cancelled tour?	The distribution of responses among tourism students again showed a predominance of choosing a value of '5' or higher. In this case, however, it shows a sceptical attitude towards the possibility of recovering the money invested in a tour operator's cancelled tour. The predominant responses were '8' (20.5%) and '7' and '10' (13.7% each).	Compared to tourism students, in the group of non-tourism students, the responses were mainly values of "8" (27.8% of respondents) and "7" (15.2% of respondents), while a value of "10" was indicated by 11.4% of respondents.
To what extent will the COVID-19 pandemic phenomenon affect decisions to cancel trips abroad?	In the case of tourism students, significantly more people (20.5%) indicated a value of "0" compared to the opposite option (value of "10")—3.4%. As with the majority of responses from tourism students, "5" was the dominant choice (24.8%).	Non-tourism students indicated the response option of "0" more often (12.7%) than the opposite option, a value of "10" (1.3%). In this group, the neutral option ("5") had the highest score (29.1%).
To what extent will the COVID-19 pandemic phenomenon affect interest in travel outside the high tourist season?	According to tourism students, the pandemic will significantly increase interest in off-high season travel in the next few years. The dominant responses in this respect were "5" (23.9%), "7" (20.5%) and "6" (13.7%).	Slightly higher scores were achieved by non-tourism students than tourism students, as they mostly indicated a value of "7" (27.8%), "6" (22.8%) and "8" (20.3%).
To what extent will the COVID-19 pandemic phenomenon affect travel behaviour, motivations and changes in travel habits?	The pandemic will significantly affect tourist behaviour, motivation and change in habits. Among tourism students, 57% of respondents stated this with 23.3% remaining neutral to the question (value of "5").	Among non-tourism students, an affirmative attitude was represented by 50.6% of respondents and a neutral attitude by 31.6%.
To what extent will the phenomenon of the COVID-19 pandemic affect interest in tourist travel due to the need to comply with specific hygiene procedures to ensure pandemic-related safety?	Tourism students were overwhelmingly (35%) convinced that hygiene and sanitation procedures will moderately reduce interest in tourism trips. The next most dominant answers to this question were "7" (15.4%) and "10" (6%).	The most popular answer among non-tourism students was "7" (29.1%). With no one answering "10", this group was notable for the high percentage of "6" (19%) and "8" (17.7%).
To what extent will the COVID-19 pandemic affect tourists' sense of security (e.g., security in purchasing an offer, security in means of transport, security in the tourist destination)?	Safety issues will not be satisfactorily addressed in relation to the coronavirus pandemic. Doubts on this issue were reported by 51% of tourism students (who answered with a value from '6' to '10') with 24.1% indicating a value of '5'.	Safety issues will not be satisfactorily addressed in connection with the coronavirus pandemic. Doubts on this issue were reported by 82.3% of non-tourism students (who answered with values from '6' to '10') with 10.1% indicating a value of '5'.

Table 4. Cont.

Questions	Answers	
	Tourism Students	Non-Tourism Students
To what extent will the COVID-19 pandemic phenomenon affect older people's interest in tourism?	According to tourism students, the pandemic will reduce the interest of older people in tourism trips. A value of "5" was indicated by 23.9% of those surveyed, while values between "6" and "10" were indicated by 57.3% of those surveyed.	In the group of non-tourism students, a value of '5' was indicated by 22.8% of respondents, with 67.1% indicating a value from '6' to '10'. The distribution of responses in both groups was quite similar.
To what extent will the phenomenon of pandemic COVID-19 affect the interest of people with disabilities in tourism trips?	According to tourism students, interest in tourism among disabled people will not change under the impact of the pandemic. The predominant response was a value of '5' (34.2%) while the other scale options were indicated with relatively similar frequency.	For the first time in the case of this question, the response option '5' proved to be the most popular among non-tourism students (45.6%).
To what extent will the phenomenon of the COVID-19 pandemic affect the interest of socially excluded groups in domestic tourism, provided they are offered government support programmes (e.g., in Poland—the so-called "tourism voucher")?	Responses to this question among tourism students were generally favourable. The most frequently indicated values were '5' (21.4%), '7' (18.8%), '8' (16.2%) and '6' (14.5%).	The opinions of tourism students were similar to the dominant opinions of the non-tourism students, who answered '7' (25.3%), '6' (20.3%) and '8' (19%).

Source: authors survey 2022.

Among the responses to the question about the impact of the pandemic on pro-tourism behaviour, again there was a relatively small discrepancy in the opinions of tourism students and non-tourism students. Notably, non-tourism students were more convinced of the stimulating role of the pandemic phenomenon on such behavioural spheres as increasing the frequency of tourist trips to visit family and friends, as well as its limiting effect on interest in tourist trips due to the need to comply with specific hygiene and health safety procedures to counteract the negative effects of the pandemic.

Table 5 shows the characteristics of respondents' answers to the questions in the module on the impact of the COVID-19 pandemic phenomenon on tourism activities (types and forms of tourism) in the following years.

**Table 5.** Characteristics of respondents' answers to questions within the module impact of the COVID-19 pandemic phenomenon on the uptake of tourism activities (types and forms of tourism) in the following years.

Questions	Answers	
	Tourism Students	Non-Tourism Students
To what extent will the COVID-19 pandemic phenomenon affect children and young people's access to organised tourism trips (camps, school trips, sports camps)?	In this case, slightly more people indicated values from "6" to "10". However, among the tourism students, the neutral option with a value of "5" (26.5%) remained by far the dominant one.	The preferred options for non-tourism students were '6' (35.4%) and '7' (22.8%).
To what extent will the COVID-19 pandemic phenomenon affect interest in weekend tourism?	Among the tourism students, there was a neutral attitude towards this statement. The most common response was a value of "5" (30.8%) and symmetrically and indirectly adjacent values of "3" and "7" (15.4% each).	Non-tourism students were much more radical in their responses to this question, with indications of a value of '8' by 34.2% and a value of '7' by 26.6% of respondents.

Table 5. Cont.

Questions	Answers	
	Tourism Students	Non-Tourism Students
To what extent will the COVID-19 pandemic phenomenon affect the development of domestic tourism?	Tourism students considered that the pandemic would affect the development of domestic tourism in the coming years. A value of "5" was indicated in this case by 29.9% of the respondents, and values from "6" to "10" by a further 52.2%.	Similarly, non-tourism students opted for a value '5' (12.7%) and for values from '6' to '10' by as many as 83.5%.
To what extent will the phenomenon of the COVID-19 pandemic affect the development of domestic roundtrips?	In the opinion of tourism students, the pandemic will not have a major impact on the domestic touring offer. In this case, values from "3" to "7" were selected (indicated by as many as 84.7% of respondents).	The distribution of responses was quite similar in the group of non-tourism students; however, 83.5% of the responses were values from "4" to "8".
To what extent will the COVID-19 pandemic phenomenon affect the development of foreign roundtrip offerings?	Rather, the pandemic will reduce the offer of foreign round trips. There were few extremes of opinion in this respect among tourism students and, apart from the most frequently indicated value of "5", respondents most frequently opted for values of "6" and "7" (13.8% each).	No significant differences were perceived in the responses of non-tourism students compared to those of tourism students.
To what extent will the phenomenon of the COVID-19 pandemic affect the development of health tourism (i.e., health, spa, medical, spa and wellness)?	According to tourism students, the pandemic will increase the importance of health tourism. This is probably related to the increased public awareness of environmental health risks. A value of '5' was indicated by 29.1% in this case, and values between '6' and '10' by 55.5% of respondents.	The neutral response was once again not popular among non-tourism students (11.4%), in contrast to the significant number of values from '6' to '10' (82.3%).
To what extent will the COVID-19 pandemic phenomenon affect the development of sustainable tourism, including agri-tourism and eco-tourism?	In the group of tourism students, the response indications referred predominantly to an intermediate value ("5"). This was decided by 29.9% of respondents. This was confirmed by the second result (12%) of the indications for the values "3" and "7", thus symmetrically adjacent to the intermediate note.	Non-tourism students were in favour of indicating a value of '5' (20.3%), while the value '8' was their most frequently chosen value (34.2%).
To what extent will the phenomenon of the COVID-19 pandemic affect the development of cycling tourism?	The pandemic appeared to be a stimulator of the development of cycling tourism. This opinion was expressed by 73.4% of tourism students, who indicated a value of "5" and values from "6" to "10".	In an even stronger positive light, non-tourism students indicated a value of "5" and values from "6" to "10" (89.9% of respondents).

Source: authors survey 2022.

Apart from a number of similarities in the statements of tourism students and non-tourism students, differences in the views of representatives of both study groups existed, as a stronger conviction of non-tourism students about the key impact of the pandemic on weekend tourism and cycling tourism came to the fore.

Table 6 shows the characteristics of respondents' answers to the questions within the module impact of the COVID-19 pandemic phenomenon on the functioning of the tourism industry (both nationally and internationally) in the following years.



**Table 6.** Characteristics of respondents' answers to questions within the module impact of the COVID-19 pandemic phenomenon on the functioning of the tourism industry (both nationally and internationally) in the following years.

Questions	Answers	
	Tourism Students	Non-Tourism Students
To what extent will the COVID-19 pandemic phenomenon affect the development of the national tourism economy?	Tourism students were not likely to be optimistic about such a question. An overwhelming group of respondents (27.4%) indicated that the pandemic phenomenon would affect the development of the national tourism economy to a medium degree (value of '5'). A slightly lower option (value of '4') was indicated by 13.7% and an even lower option (value of '3') by 15.4%.	Non-tourism students took a more optimistic view of the issue compared to tourism students. Their answers were dominated by values of "8" (21.5%) and "7" (16.5%).
To what extent will the phenomenon of the COVID-19 pandemic affect the reduction in prices for tourism services?	Symptomatic among tourism students is the predominance (24.8%) of those indicating a value of "5". On the other hand, indications of a value of "10" were few (2.6%) compared to indications of a value of "0" (extremely low)—22.2%.	Non-tourism students were less critical of this question, indicating a zero in 11.1% of cases. In contrast, the largest proportion of this group (20.3%) indicated the value "8".
To what extent will the phenomenon of the COVID-19 pandemic affect the operation of travel agencies, hotels and other tourism operators and tourism participants themselves?	According to tourism students, the impact of the pandemic on the operation of travel agencies, hotels and other tourism operators as well as on tourists themselves is high and very high. Only 12% had opinions to the contrary, i.e., indications of values from "0" to "4".	A similar proportion of responses was observed in the group of non-tourism students, with a shift towards extremely high scores compared to tourism students being confirmed here once again.
To what extent will the COVID-19 pandemic phenomenon affect the risk of travel agency bankruptcies?	According to respondents, travel agency bankruptcies seem to be the inevitable result of the pandemic. In the group of tourism students, a value of "5" was indicated in this case by 22.2% of respondents, and values from "6" to "10" were indicated by a further 63.2%.	Indications of values of "5" were chosen less frequently by non-tourism students (10.1%), while indications of values from "6" to "10" were chosen significantly more often (88.6%) compared to tourism students
To what extent will the phenomenon of the COVID-19 pandemic affect the position of catering companies in the tourism market?	Again among tourism students, a value of "5" was the most frequently indicated value (23.1%). Options higher than this average were indicated by more people compared to the number of respondents indicating a value below "5".	The disproportion found among tourism students was more noticeable in the group of non-tourism students, who concentrated their indications on the value "7" (30.4%) and "8" (22.8%).
To what extent will the COVID-19 pandemic phenomenon affect the condition of business tourism and the exhibition industry?	Business tourism, including the exhibition industry, could be affected by the pandemic, according to those surveyed. Scale values between "6" and "10" were indicated (34.5%), with 44% of tourism students remaining neutral to this question (indicating a value of "5").	Among non-tourism students, they indicated a scale value of "6" to "10" (40.5%), while indications of "5" were 44.3%.
To what extent will the COVID-19 pandemic phenomenon affect the tourism industry's interest in the use of modern technologies (e.g., travel blogs, virtual guides, apps, etc.)?	This question was perceived favourably by tourism students. This time, indications of values of "5" were not dominant in the statements of this group of respondents (22.2%). More people (23.9%) indicated values of "8".	Non-tourism students had similar views to tourism students, with the most frequently indicated value being "7" (34.2%).
To what extent will the phenomenon of the COVID-19 pandemic affect possible retraining decisions and the departure of tourism industry employees to other professions?	The pandemic will affect the retraining decisions of tourism workers. An extremely high degree of agreement with this statement was identified by 11.1% of the tourism students surveyed, while an extremely low degree of agreement was identified by only 0.9%.	Here again, it is important to emphasise the greater disproportion between the extreme responses in the group of non-tourism students. The lowest indicated option was "2" (1.3%), while the indications of values from "6" to "8" (70.9%) definitely dominated.

Source: authors survey 2022.

Responses to questions referring to the impact of COVID-19 on the operation of the tourism industry showed more similarities than differences between the two groups of respondents. Non-tourism students were more likely to believe that the pandemic induced a more dynamic development of the domestic tourism business and catering companies.

Table 7 shows the characteristics of respondents' answers to the questions Table 6 shows the characteristics of respondents' answers to the questions within the module impact of the COVID-19 pandemic phenomenon on the functioning of the tourism industry (both nationally and internationally) in the following years.

**Table 7.** Characteristics of respondents' answers to questions within the module impact of the COVID-19 pandemic phenomenon on the operation and condition of tour operators in the following years.

Questions	Answers	
	Tourism Students	Non-Tourism Students
To what extent will the COVID-19 pandemic phenomenon affect the health of maritime carriers (passenger ferries and cruise ships—cruises)?	A pandemic will increase the risk of bankruptcy for maritime transport companies. Some tourism students (32.5%) were neutral on this question (indicating a value of "5"), but a further 41% were highly convinced (indicating values from "6" to "10").	In comparison, only 13.9% of non-tourism students indicated a value of "5", but in this group, the percentage of indications of values from "6" to "10" was significantly higher (74.7%) than among tourism students.
To what extent will the COVID-19 pandemic phenomenon affect the risk of bankruptcies of coach transport companies?	The pandemic will increase the risk of bankruptcy for coach transport companies. Some tourism students (33.3%) were neutral on this question (indicated value "5"), but a further 45.2% were convinced to a considerable degree (indicating values from "6" to "10").	In comparison, only 13.9% of non-tourism students indicated a value of "5", but in this group, the percentage of indications of values from "6" to "10" was significantly higher (77.2%) than among tourism students.
To what extent will the COVID-19 pandemic phenomenon affect the condition of domestic air carriers operating in Poland?	Tourism students remained neutral to this question. The vast majority of responses oscillated around the value "5", with 66.6% of all responses in the value range "3" to "7".	Similarly, among non-tourism students, the indication of the value "5" was the most common, with 83.5% indicating values from "3" to "7".
To what extent will the COVID-19 phenomenon affect the condition of foreign air carriers operating in Poland?	Tourism students remained neutral to this question. The vast majority of responses oscillated around a value of '5', with 70.6% of respondents favouring indications in the value range of '3' to '7'.	Similarly, among non-tourism students, indicating a value of '5' was the most common, with 74.7% of respondents favouring indications between '3' and '7'.
To what extent will the COVID-19 pandemic affect global air carriers?	Global air transport will not be clearly influenced by the pandemic in the next few years. The extreme response options (values of '0', '1', '9' or '10') were only chosen by 12.9% of tourism students.	Extreme answers were even less common among non-tourism students, with only 5% indicating extreme answers to this question (values of '0', '1', '9' or '10').
To what extent will the COVID-19 pandemic phenomenon affect interest in private car transport for tourism purposes?	Private car transport will be heavily used for tourism in the post-pandemic period. Values of "5" to "10" were chosen by 86.2% of the tourism students surveyed.	Options on a scale of '5' to '10' were indicated by 93.7% of non-tourism students in this case, giving them a lead of 7.5 percentage points over the tourism students group.

Source: authors survey 2022.

This module on the impact of the pandemic on the choice of tourist modes of transport highlighted the non-tourism students' stronger belief in the reductive impact of the coronavirus pandemic on maritime tourism (including the operation of passenger ferries and cruise ships). Representatives of this research group were also, compared to tourism students, more convinced of the threat of bankruptcies of coach transport companies.

## 6. Discussion

The answers to our questions given by youth/students (196 students of universities in Gdansk, Poland—either studying tourism or unrelated courses) revealed some discrepancies, likely the result of different levels of knowledge about the factors that influence tourism. The most common response across all questions selected by tourism students was five—to a moderate degree. This means that the representatives of this group avoided making any radical statements about the role of COVID-19 in shaping the realities of tourism. At the same time, this means that they do not overestimate the role of the pandemic, which can be seen in the large number of answers in the 6 to 10 range.

However, non-tourism students ascribe a higher impact to the pandemic, and usually assess its influence as positive. This can be seen in pronounced differences in answers to at least 8 of the 37 questions that made up the survey. These concerned, for example, the development of sustainable tourism (question 2), the development of Polish tourism entrepreneurship (question 3), decreases in the prices of tourist services in the next few years (question 4) and the promotion of less popular destinations driven by the pandemic (question 5). Non-tourism students were also more likely to believe that the pandemic will increase interest in travelling outside the summer season in the next few years (question 11), weekend getaways (question 16) and health tourism (question 18). They were more convinced about the post-pandemic development of intra-country tourism (question 17). The dominating belief that the pandemic has a strong influence on tourism held by non-tourism students was not, however, unanimously positive. In the case of answers to questions 25 and 26 regarding the risk of bankruptcy of bus and sea transport companies, the fact that this group selected higher answers indicates that they do not have optimistic predictions for these forms of business. In the context of the differences between the groups, a clear similarity in beliefs was seen in the answers to question 7, regarding the post-pandemic increase in interest in new technologies. Most respondents, independently of whether they studied courses related to tourism or not, agreed that the pandemic had a significant influence on the technologisation of tourism.

Unfortunately, the current literature has few studies that identify the motives, trends and opinions of students on the role of the COVID-19 pandemic in shaping their touristic reality. One study analysed trends in that realm among Interrail users in Turkey in order to identify the effect of the pandemic on the youth tourism market [66]. Data gathered via an online survey were analysed using factor analysis and showed that the influence of the pandemic on tourist behaviours can be explained in two dimensions: preferences regarding travel, and hygiene and safety. It was therefore concluded that the pandemic did not have a significant influence on the style of travel in this age group, but that it did, however, influence hygiene and safety. Moreover, it was concluded that the pandemic impacts women to a greater extent than men in terms of behaviours and preferences relating to travelling, as well as issues of hygiene and safety [67].

Another example of research was conducted by Szlachcik et al. [68] who investigated the impact of the pandemic on life, travel, choice of tourist destination, tourist activity, eco-tourism preferences and health and safety issues identified by international students from Europe and Asia studying at universities in Warsaw (a group of 719 respondents). The research showed that the COVID-19 pandemic had a significant impact on the travel behaviour of international students studying in Poland. Their travel motives, choice of destination (e.g., avoiding travel to crowded big cities after COVID-19—these are the responses of Asian students) and behaviour related to finding accommodation, hygiene, safety, etc. changed. Responses from European participants were more moderate.

In one of the few publications on topics linking youth, tourism and the pandemic, the impact of the first seven months of the COVID-19 pandemic on youth travel was analysed. A survey of youth tourism businesses between March and September 2020 found that youth tourism businesses were deprived of up to 70% of their business revenue. Youth tourism companies have taken a number of strategic steps in response to the crisis, including changing contract terms, expanding marketing activity, creating partnerships and moving

business online. As youth travel depends on social interaction, the industry faces serious challenges in the near future [11].

The pandemic has caused serious challenges for the youth travel industry, not only because of general travel restrictions but also because of the specific nature of youth travel. Above all, young travellers want to experience the local culture and build social contacts with hosts and other travellers, which has contributed to the growing popularity of youth hostels and hostels in Poland in recent years. However, this desire for social contact has now become a challenge for the tourism industry, as travel is associated with the spread of COVID-19 [69]. The need for social distance in accommodation and at attractions has reduced capacity and revenue for those businesses that continue to operate.

There is also the question of whether many destinations will want to return to the traditional pre-pandemic form of tourism. Indeed, many are now calling for a more creative travel model based on lower tourist numbers and more sustainable forms of tourism. Such forms are hard to come by now that people have become nervous not only about travelling but also about welcoming travellers. It is likely to be a long time before previous levels of mobility and socialisation are reached [70].

In the conclusion to his research, Asan [67] concludes that the pandemic will not necessarily have a fundamental impact on the attitudes and preferences of young tourists. On the other hand, however, following the prescribed behaviour of the rest of society, young people will attach greater importance to safety and hygiene than before.

There will also be increasing discussions about the tourism models that individual tourist regions plan to adopt in the future. In many places, this is likely to be a higher-spending option, reversing the decades-long trend of massification and pressure on prices. This could also reverse the democratisation of travel characteristic of the 20th century, making international travel a more exclusive product that only the more affluent will be able to afford. Another issue will emerge from this—the right to travel and possible support for those who cannot afford it, who often represent the younger part of the global population. Research carried out by the WYSE Travel Confederation [71] also pointed to growing concerns about epidemics, which in 2007 were seen as an issue accompanying travel by only 6% of young people while 10 years later this figure has risen to 12% and may steadily increase in the near future.

A study conducted by Szlachciuk and co-authors among 719 foreign students studying in Poland showed that the COVID-19 pandemic had a significant impact on their travel behaviour and, in terms of changing their motives for choosing travel destinations, the choice of destination and standard of accommodation, hygiene conditions and their sense of security [68].

Vanicek and Jarolimkova [72] surveyed tourism students at the Prague University of Economics and Business regarding their opinions on the impact of the COVID-19 pandemic (they conducted their research in 2020–2021). The research showed that the pandemic had a negative impact on the lives of the students surveyed; among other things, they cancelled their trips abroad in many cases. Despite the changes observed, they expect an increase in domestic tourism in the future (in the coming years) and a decrease in outbound and inbound tourism. Students also indicated the need to take measures to promote positive prospects for tourism development in the future, despite the stagnation and significant adverse changes in tourism markets caused by the COVID-19 pandemic.

A different conclusion in the perceptions of travel risks during the COVID-19 pandemic expressed by students was reached by Dragin and co-authors [73]. They surveyed tourism and hospitality students (206 people) at the University of Novi Sad (Serbia). The study showed that students could be a future segment of tourists to revive tourism after the COVID-19 pandemic, given that almost one in three respondents were ready to travel even in the COVID-19 crisis. Due to the COVID-19 pandemic, 69% of young tourists changed their choice of destination, but did not change the type of accommodation, travel companion or length of stay. The results also showed that younger generations of tourists were more concerned about the quality of the holiday, including health and non-health

risks. To some extent, young tourists were in denial about the risk of illness and expected to accumulate savings when travelling during the COVID-19 pandemic. The authors believe their research will help the tourism industry (including hotels) create holiday packages for these young consumers, as well as help stakeholders involved in providing services to young tourists during a pandemic.

Using a qualitative research project, Croatian authors had the opportunity to collect, analyse and discuss the views of tourism experts on the recovery and possible changes in post-COVID tourism. Long-term opportunities for transforming the tourism sector into a more sustainable and inclusive one are postulated, making proper use of regional competitive advantages [74].

Based on the feedback received and discussions with experts, Assaf and co-authors proposed an agenda for future research focusing on six key pillars: consumer behaviour, demand and performance modelling, forecasting, destination and facility management, informational technology and quality of life with a focus on sustainability. With all the uncertainty surrounding COVID-19 and the negative impact it has had on the tourism industry, now is the most opportune time for academic and industry experts to develop ideas to underpin recovery strategies [75].

The results of the Vietnam study confirm the significant negative impact of the pandemic on the tourism industry seen in other countries, characterised by a decline in visitor numbers, business, revenue and employment rates. Recovery in the post-pandemic period in the aforementioned sectors should be based on diversification and the provision of quality tourism products, relevant marketing, digital transformation and promotion of sustainable tourism [76].

In contrast, issues of personal security relating to safeguarding against potential sources of epidemic threats were addressed in a study by Armutlu and co-authors, who analysed the attitudes associated with the COVID-19 pandemic outbreak of Turkish tour operators towards Chinese tourists visiting the country. Despite the many other determinants of post-pandemic tourism development, the focus of attention is often shifted precisely towards health security [77].

Undoubtedly, all stakeholders in the tourism industry need to work together to make it sufficiently resilient to a pandemic crisis. With the help of a resilient approach from governments, market players, technology innovators and the industry's workforce, the tourism sector can eventually evolve in a much more sustainable way after a pandemic. Certainly, these efforts can be further supported by engaging local communities in tourism development [78].

In order to discover sustainable recovery paths for the tourism industry and the real impact of the COVID-19 outbreak on consumer perceptions and behaviour, Romanian quantitative research was developed using two different representative samples in May 2020 and December 2020. The results indicated that the pandemic has affected travel patterns and habits regarding economic factors. Psychological factors, primarily fear of contamination, affect the willingness to travel and preferences for holiday destinations. At least in the medium term, people will avoid travelling in large groups and staying in crowded places. Hygiene and health conditions at the destination can be important factors in travel decisions. Faced with a wary clientele, tourism businesses related to transport, accommodation and catering should improve their hygiene conditions to restore confidence [79].

While the impact of tourism and COVID-19 has received much attention, limited research has considered the perspective of local people working in tourism, especially those most affected by the pandemic. The views of tourism workers in Nha Trang, Vietnam, on the relationship between tourism and the COVID-19 pandemic and its impact on quality of life and the local economy were analysed. The role of a sustainable strategy was highlighted, including diversifying sources of tourists, multiplying sources of income for local people and improving tourism management by local authorities [80].

It should be objectively noted that the research presented is subject to certain limitations. This cannot constitute a fully supported claim, because this is the first time our tool has been used and because of the relatively low representativeness of the sample. The results of this study therefore require confirmation through studies on bigger groups that are more cross-sectional in terms of variables such as age, place of residence and level of education. The need to conduct them should be considered urgent, because people are at present accustomed to the pandemic. As a result, in the near future there may be a transformation of subjective perspectives on many phenomena, which will make it impossible to compare the results of this study with the results of future studies. It seems justified to also transform the questions of the structured interview into a survey questionnaire; however, this would have to be preceded by an assessment of the validity and reliability of the items of the questionnaire. Therefore, the proposal to create a survey questionnaire to monitor public opinion on the impact of COVID-19 on the current and future image of tourism only encourages a broader discussion. Understanding opinions about the biggest epidemiological threat in decades will contribute to an accurate assessment of the extent to which these opinions correspond to actual threats to world tourism. In addition, future research will focus more on qualitative research in order to gain a deeper understanding of young people's post-pandemic perspectives on trends in contemporary tourism.

## 7. Conclusions

The observed tendency amongst tourism students toward a more critical approach to the virus and its consequences may be the result of the acquisition of a deeper awareness of the real and potential threats associated with COVID-19 through their education.

The results presented in this study showed a relatively frequent divergence of opinions between tourism students and non-tourism students regarding the impact of COVID-19 on global tourism. The non-tourism students were more categorical in their statements. Particularly, significant differences were observed in responses to questions about the negative impact of COVID-19 on the development of domestic tourism (52.2% of tourism students indicating values of 6 to 10 versus 83.5% of non-tourism students indicating the same values), the development of health tourism (55.5% of tourism students indicating values of 6 to 10 versus 82.3% of non-tourism students indicating the same values), the possibility of travel agency bankruptcies (63.2% of tourism students indicating values of 6 to 10 versus 88.6% of non-tourism students indicating the same values), the operation of maritime means of tourist transport (41.0% of tourism students indicating values of 6 to 10 versus 74.7% of non-tourism students indicating the same values) and the possibility of bankruptcy of coach transport companies (45.2% of tourism students indicating values of 6 to 10 versus 77.2% of non-tourism students indicating the same values).

Referring to the research hypothesis presented, it is worth noting a fundamental trend manifested in many responses, expressed in the often neutral views towards the role of the COVID-19 pandemic expressed by tourism students. Against their background, non-tourism students were much more often radical in their responses. In other words, we can speak here of a greater focus on the scale of responses in the case of tourism students. Representatives of this group seem to attach less importance to the phenomenon of pandemics as a determinant of global tourism.

Conversely, it is difficult to prejudge whether the study of tourism associated with the moderate importance attributed to COVID-19 as a determinant of global travel development simultaneously implies a more favourable attitude towards sustainable tourism. Higgins-Desbiolles believes that the pandemic presents an opportunity for a paradigm shift in tourism towards sustainability [81], but this may apply both to those with and without educational links to tourism. The strategic orientation towards sustainability not seen in specific groups of society, but rather in the whole cross-section of society, remains regionally, regardless of the pandemic, in the shadow of the many shortages created by the war in Ukraine. Consequently, resource saving is rather involuntary as a result of travel restrictions due to global inflation. Of course, it would be better if a shift in thinking towards

sustainable tourism resulted from a deeper awareness rather than being forced by periodic crises. However, we will probably have to remain in anticipation of this momentous transformation of people, both connected and not connected by the educational system to tourism in the broadest sense.

**Author Contributions:** Conceptualization, D.J.O.-S. and M.P.; methodology, D.J.O.-S. and M.P.; software, D.J.O.-S. and M.P.; validation, D.J.O.-S. and M.P.; formal analysis, D.J.O.-S. and M.P.; investigation, D.J.O.-S. and M.P.; resources, M.L.; data curation, D.J.O.-S. and M.P.; writing—original draft preparation, D.J.O.-S. and M.P.; writing—review and editing, D.J.O.-S. and M.P.; visualization, M.L.; supervision, M.L.; project administration, D.J.O.-S. and M.P.; funding acquisition, D.J.O.-S. and M.P. All authors have read and agreed to the published version of the manuscript.

**Funding:** This research received no external funding.

**Institutional Review Board Statement:** The study was conducted according to the guidelines of the Declaration of Helsinki, and approved by the Institutional Review Board of GDANSK UNIVERSITY OF PHYSICAL EDUCATION AND SPORT acting on the basis of the Regulation of the Minister of National Education and Sport of 9 April 2002 on the conditions for conducting innovative and experimental activities by public schools and institutions, concluded an agreement with the Pomeranian school superintendent concerning the project of evaluation and stimulation of the quality of physical education in (PE) schools in the Pomorskie Voivodeship (Project Number 17/03/05).

**Informed Consent Statement:** Informed consent was obtained from all subjects involved in the study.

**Data Availability Statement:** Data are publicly available.

**Conflicts of Interest:** The authors declare no conflict of interest.

## References

1. Fana, M.; Pérez, S.T.; Fernández-Macías, E. Employment Impact of COVID-19 Crisis, from Short Term Effects to Long Terms Prospects. *J. Ind. Bus. Econ.* **2020**, *47*, 391–410. [CrossRef]
2. Adamowicz, M. COVID-19 Pandemic as a Change Factor in the Labour Market in Poland. *Sustainability* **2022**, *14*, 9197. [CrossRef]
3. Khan, M.; Parvaiz, G.S.; Bashir, N.; Imtiaz, S.; Bae, J.; Wang, S. Students' Key Determinant Structure towards Educational Technology Acceptance at Universities, during COVID 19 Lockdown: Pakistani Perspective. *Cogent Educ.* **2022**, *9*, 2039088. [CrossRef]
4. Rogers, E. *Diffusion of Innovations*; Free Press: New York, NY, USA, 2003.
5. James, R.K.; Gilliland, B.E. *Crisis Intervention Strategies*; Thomson Brooks/Cole: Belmont, CA, USA, 2013.
6. Stanley, S.; Sethuramalingam, V.; Pandian, S. Resilience: Its Nature and Significance (A Theoretical Overview). *Indian J. Soc. Work* **2018**, *79*, 5–30. [CrossRef]
7. Brouder, P. Reset Redux: Possible Evolutionary Pathways towards the Transformation of Tourism in a COVID-19 World. *Tour. Geogr.* **2020**, *22*, 484–490. [CrossRef]
8. Hall, C.M.; Scott, D.; Gossling, S. Pandemics, Transformations and Tourism: Be Careful What You Wish For. *Tour. Geogr.* **2020**, *22*, 577–598. [CrossRef]
9. Kock, F.; Nørfelt, A.; Josiassen, A.; Assaf, A.G.; Tsionas, M.G. Understanding the COVID-19 Psyche: The Evolutionary Tourism Paradigm. *Ann. Tour. Res.* **2020**, *85*, 103053. [CrossRef]
10. Weidmann, S.; Filep, S.; Lovelock, B. How Are Tourism Businesses Adapting to COVID-19? Perspectives from the Fright Tourism Industry. *Tour. Hosp. Res.* **2022**. [CrossRef]
11. Richards, G.; Morrill, W. The Challenge of COVID-19 for Youth Travel. *Rev. Bras. De Estud. Turísticos* **2021**, *11*, 1–8.
12. Available online: <https://www.Unwto.Org/Global-Code-of-Ethics-for-Tourism> (accessed on 26 October 2022).
13. Available online: <https://Webunwto.S3.Eu-West-1.Amazonaws.Com/S3fs-Public/2020-04/Moduleieng13022017.Pdf> (accessed on 26 October 2022).
14. Available online: [www.e-Unwto.Org/Doi/Book](http://www.e-Unwto.Org/Doi/Book) (accessed on 26 October 2022).
15. Available online: [https://Population.Un.Org/Wpp/Publications/Files/WPP2019\\_10KeyFindings.Pdf](https://Population.Un.Org/Wpp/Publications/Files/WPP2019_10KeyFindings.Pdf) (accessed on 26 October 2022).
16. Available online: <https://Stat.Gov.Pl/Obszary-Tematyczne/Kultura-Turystyka-Sport/Turystyka/Turystyka-i-Wypoczynek-w-Gospodarstwach-Domowych-w-2013-r-,3,3.Html> (accessed on 26 October 2022).
17. Keyser, H. *Tourism Development*; Oxford University Press: Cape Town, South Africa, 2002.
18. Hartmann, L.A.; Cordell, H.K. An Overview of the Relationship between Social and Demographic Factors Outdoor Recreation Participation. General Technical Report SE-52'. In *Outdoor Recreation Benchmark 1988*; Watson, A.E., Ed.; U.S. Department of Agriculture: Washington, DC, USA, 1989; pp. 255–274.
19. Murrmann, J. Uczestnictwo w Turystyce a Nierówności Społeczne We Współczesnej Polsce. In *Kultura Fizyczna a Różnice i Nierówności Społeczne [Red]*; Dziubiński, Z., Lenartowicz, M., Eds.; AWF: Warszawa, Poland, 2013; pp. 201–216.









20. Carpio, C.E.; Wohlgenant, M.K.; Boonsaeng, T. The Demand for Agritourism in the United States. *J. Agric. Resour. Econ.* **2008**, *33*, 254–269.
21. Simonsen, P.S.; Jorgenson, B.; Robbins, D. Cycling Tourism, Unit of Tourism Research at Research Centre of Bornholm, December 1998. pp. 77–78. Available online: [https://crt.dk/wp-content/uploads/12\\_rapport\\_Cycling\\_tourism.pdf](https://crt.dk/wp-content/uploads/12_rapport_Cycling_tourism.pdf) (accessed on 26 October 2022).
22. Łaciak, J. *Aktywność Turystyczna Mieszkańców Polski w Wyjazdach Turystycznych w 2012 Roku*; Instytut Turystyki: Warszawa, Poland, 2013.
23. Available online: <https://Www.Unwto.Org/Archive/Global/Publication/Am-Reports-Volume-2-Power-Youth-Travel> (accessed on 26 October 2022).
24. Available online: <https://Www.Unwto.Org/Archive/Middle-East/Publication/Report-Power-Youth-Travel> (accessed on 26 October 2022).
25. Available online: <https://Www.Wysetc.Org/about-Us/Facts-and-Stats/Definitions/> (accessed on 26 October 2022).
26. Available online: <https://Stat.Gov.Pl/Obszary-Tematyczne/Edukacja/Edukacja/Oswiata-i-Wychowanie-w-Roku-Skolnym-20202021,1,16.Html> (accessed on 26 October 2022).
27. Latosińska, J.; Ludwicka, D. Aktywność Turystyczna Młodzieży Akademickiej Na Przykładzie Wyższych Uczelni w Łodzi. *Turyzm* **2010**, *1*, 21–28. [CrossRef]
28. Lubowiecki-Vikuk, A.P.; Podgórski, Z. Zachowania i Preferencje Turystyczne Młodzieży Akademickiej. In *Współczesne Uwarunkowania i Problemy Rozwoju Turystyki*; Pawlusiński, R., Ed.; IGiGP, UJ: Kraków, Poland, 2013; pp. 149–158.
29. Brojek, A.; Bochenek, A. Sport-Tourism Interests in the Light of All The Interests of Physical Education Students in the Selected Academies in Poland, Sport-Tourism Interests of the Physical Education Students. *Pol. J. Sport Tour.* **2012**, *19*, 68–76. [CrossRef]
30. Lubański, K. Turystyka Jako Forma Wychowawcza. *Naucz. I Wychowawca* **1986**, 5–6.
31. Lubański, K. Turystyka Indywidualna a Psychologiczne Determinanty Zachowań. In *Spoleczno-Pedagogiczne Problemy Turystyki*; Malinowski, J., Ed.; Instytut Turystyki: Warszawa, Poland, 1988.
32. Polska Organizacja Turystyczna. *Marketingowa Strategia Polski w Sektorze Turystyki Na Lata 2008–2015*; Polska Organizacja Turystyczna: Warszawa, Poland, 2008.
33. Żukowska, Z. Aktywna Turystyka Młodzieżowa i Jej Wartości w Wychowaniu Do Zdrowego Stylu Życia. In *Aksjologia Turystyki*; Zbigniew, D., Ed.; SOS RP: Warszawa, Poland, 2006.
34. Aleziak, B. *Samowychowanie a Turystyka*; Albis: Kraków, Poland, 2008.
35. Dimanche, F. En Quête de La Generation “C”: Pour Un Nouvel Agenda Recherche Marketing et Tourisme. *Mondes Du Tour.* **2010**, *1*, 30–38. [CrossRef]
36. Richards, G. The New Global Nomads: Youth Travel in a Globalizing World. *Tour. Recreat. Res.* **2015**, *40*, 340–352. [CrossRef]
37. Blomgren, E.; Ljungström, S. *Youth Tourism: Impacts on Places from a Consumer Perspective*; Linnæus University: Växjö, Sweden, 2018.
38. Wood, S. Generation Z as Consumers: Trends and Innovation. 2013. Available online: <https://Liye.Info/Doc-Viewer> (accessed on 26 October 2022).
39. Haddouche, H.; Salomone, C. Generation Z and the Tourist Experience: Tourist Stories and Use of Social Networks. *J. Tour. Futures* **2018**, *4*, 69–79. [CrossRef]
40. Bizirgianni, I.; Dionysopoulou, P. The Influence of Tourist Trends of Youth Tourism through Social Media (SM) & Information Communication Technologies (ICTs). *Procedia—Soc. Behav. Sci.* **2013**, *73*, 652–660.
41. Pearce, P.L.; Lee, U.I. Developing the Travel Career Approach to Tourist Motivation. *J. Travel Res.* **2005**, *43*, 226–237. [CrossRef]
42. Arnett, J.J. Emerging Adulthood: Understanding the New Way of Coming of Age. In *Emerging Adults in America: Coming of Age in the 21st Century*; Arnett, J.J., Tanner, J.L., Eds.; APA: Washington, DC, USA, 2006; pp. 3–19.
43. Valentine, D.B.; Powers, T.L. Generation Y Values and Lifestyle Segments. *J. Consum. Mark.* **2013**, *30*, 597–606. [CrossRef]
44. Cavagnaro, E.; Staffieri, S.; Carrieri, A.; Burns, K.; Chen, N.; Fermani, A. Profiling for Sustainable Tourism: Young Travelers’ Self-Transcendence Values and Motivations. *Eur. J. Tour. Res.* **2021**, *28*, 2810. [CrossRef]
45. Rada ds. *Kompetencji Sektora Turystyka Instytut Turystyki w Krakowie Sp. z o.o. Badanie Opinii Pracodawców Na Temat Obecnych i Przyszłych Kompetencji Pracowników w Sektorze Turystyki*; Rada ds: Kraków, Poland, 2018.
46. Available online: <https://Webunwto.S3.Eu-West-1.Amazonaws.Com/S3fs-Public/2022-07/Newletter-Am43-July.Pdf?VersionId=Fj7Z9tG7fZ70kaYjRZEeaC4V0hNvijjr> (accessed on 26 October 2022).
47. Asian Development Bank (ADB); World Tourism Organization (UNWTO). *COVID-19 and the Future of Tourism in Asia and the Pacific*; Asian Development Bank: Manila, Philippines; World Tourism Organization: Madrid, Spain, 2022.
48. Poon, S. Love, Peace and Psychodelia: The Role of Symbols in the Sixties Counterculture. *Int. J. Multidiscip. Approach Stud.* **2016**, *3*, 155–172.
49. Wendt, J.A.; Olszewski-Strzyżowski, D.J. Changes in Air Tourism to Tunisia in 2009–2018. *Balt J. Health Phys. Act.* **2020**, *1*, 158–159. [CrossRef]
50. Available online: [Www.Wttc.Org/Research/Economic-Impact](http://Www.Wttc.Org/Research/Economic-Impact) (accessed on 26 October 2022).
51. Olszewski-Strzyżowski, D.J. Promotional Activities of Selected National Tourism Organizations (NTOs) in the Light of Sustainable Tourism (Including Sustainable Transport). *Sustainability* **2022**, *14*, 2561. [CrossRef]
52. Goodall, B. Understanding Holiday Choice. In *Tourism Concepts in the Critical Social Sciences*; Williams, S., Ed.; Routledge: London, UK, 2004; pp. 172–180.
53. Lowry, L.L. *The SAGE International Encyclopedia of Travel and Tourism: Cohen’s Model of Typologies of Tourists*; SAGE Publications Ltd: Thousand Oaks, CA, USA, 2017.



54. Haarhoff, R.; De Klerk, B. Destination South Africa: Analysis of Destination Awareness and Image by International Visitors. *Geof. Tour. Geosites* **2019**, *24*, 201–202.
55. Available online: <https://unfoundation.org/blog/post/five-global-issues-to-watch-in-2021/> (accessed on 26 October 2022).
56. Jędrzejowska, K.; Wróbel, A. Wielki Lockdown i Deglobalizacja: Wpływ Pandemii COVID-19 Na Gospodarkę Światową. *Rocz. Strateg.* **2020**, *21*, 1–26.
57. Available online: [www.unwto.org/impact-assessment-of-the-covid-19-outbreak-on-international-tourism](http://www.unwto.org/impact-assessment-of-the-covid-19-outbreak-on-international-tourism) (accessed on 26 October 2022).
58. Available online: <https://www.indonesia.travel/gb/en/trip-ideas/8-ideas-to-start-your-sustainable-journey-in-indonesia> (accessed on 26 October 2022).
59. Available online: <https://www.unwto.org/news/covid-19-travel-restrictions> (accessed on 26 October 2022).
60. Bernaś, B.; Pujer, K. Bezpieczeństwo i Zagrożenia w Turystyce. *Cent. Eur. Rev. Econ. Manag.* **2014**, *15*, 223–243.
61. Zorcec, T.; Pop-Jordanova, N. Young People and COVID-19 Pandemic in Our Country. *Sciend* **2022**, *43*, 15–21. [CrossRef]
62. Chen, X.; Duan, Y.; Ali, L.; Duan, Y.; Ryu, K. Understanding Consumer Travel Behavior during COVID-19. *Sustainability* **2021**, *13*, 13330. [CrossRef]
63. Cahigas, M.M.L.; Prasetyo, Y.T.; Alexander, J.; Sutapa, P.L.; Wiratama, S.; Arvin, V.; Nadlifatin, R.; Persada, S.F. Factors Affecting Visiting Behavior to Bali during the COVID-19 Pandemic: An Extended Theory of Planned Behavior Approach. *Sustainability* **2022**, *14*, 10424. [CrossRef]
64. Orden-Mejía, M.; Carvache-Franco, M.; Huertas, A.; Carvache-Franco, W.; Landeta-Bejarano, N.; Carvache-Franco, O. Post-COVID-19 Tourists' Preferences, Attitudes and Travel Expectations: A Study in Guayaquil, Ecuador. *Int. J. Environ. Res. Public Health* **2022**, *19*, 4822. [CrossRef]
65. Szczepanek, W.K.; Kruszyna, M. The Impact of COVID-19 on the Choice of Transport Means in Journeys to Work Based on the Selected Example from Poland. *Sustainability* **2022**, *14*, 7619. [CrossRef]
66. Aşan, K. The Impacts of COVID-19 Pandemic on the Youth Tourism Market. *Proceedings* **2020**, 501–504. Available online: [https://www.researchgate.net/publication/344158154\\_The\\_Impacts\\_of\\_Covid-19\\_Pandemic\\_on\\_the\\_Youth\\_Tourism\\_Market](https://www.researchgate.net/publication/344158154_The_Impacts_of_Covid-19_Pandemic_on_the_Youth_Tourism_Market) (accessed on 26 October 2022).
67. Aşan, K. COVID-19 Pandemic on Youth Tourism. *J. Mediterr. Tour. Res.* **2021**, *1*, 1–10.
68. Szlachciuk, J.; Kulykovets, O.; Debski, M.; Krawczyk, A.; Górska-Warsewicz, H. How Has the COVID-19 Pandemic Influenced the Tourism Behaviour of International Students in Poland? *Sustainability* **2020**, *14*, 8480. [CrossRef]
69. Farzanegan, M.R.; Gholipour, H.F.; Feizi, M.; Nunkoo, R.; Andargoli, A.E. International Tourism and Outbreak of Coronavirus (COVID-19): A Cross-Country Analysis. *J. Travel Res.* **2020**, *60*, 0047287520931593. [CrossRef]
70. Richards, G. Tourism and Resilience: From 'Overtourism' to No Tourism. Paper Presented to the Summer School on the Management of Creativity Organized by HEC Montreal and the University of Barcelona. 2020. Available online: [https://www.researchgate.net/publication/345813213\\_Tourism\\_and\\_Resilience\\_From\\_Overtourism\\_to\\_No\\_Tourism](https://www.researchgate.net/publication/345813213_Tourism_and_Resilience_From_Overtourism_to_No_Tourism) (accessed on 29 October 2022).
71. WYSE Travel Confederation. *New Horizons IV: A Global Study of the Youth and Student Traveller*; WYSE Travel Confederation: Amsterdam, The Netherlands, 2018.
72. Vanicek, J.; Jarolimkova, L. Development of Opinions of Tourism Students at the Prague University of Economics and Business on the COVID-19 Pandemic. *Manag. Bus. Res. Q.* **2021**, *18*, 60.
73. Dragin, A.; Mijatov, M.; Majstorovic, N.; Korovljevic, D. COVID-19 Pandemic and Young Tourists' Travel Risk Perceptions: Impacts on Travel Restrictions (Local and International) and Tourism. In *COVID-19 and a World of Ad Hoc Geographies*; Springer: Berlin/Heidelberg, Germany, 2021.
74. Ćorak, S.; Boranić Živoder, S.; Marušić, Z. Opportunities for Tourism Recovery and Development during and after COVID-19: Views of Tourism Scholars versus Tourism Practitioners. *Tourism* **2020**, *4*, 68. [CrossRef]
75. Assaf, A.G.; Kock, F.; Tsionas, M. Tourism during and after COVID-19: An Expert-Informed Agenda for Future Research. *J. Travel Res.* **2022**, *61*, 454–457. [CrossRef]
76. Vu, H.D.; Nguyen, A.T.N.; Nguyen, N.T.P.; Tran, D.B. Impacts and Restoration Strategy of the Tourism Industry Post-COVID-19 Pandemic: Evidence from Vietnam. *J. Tour. Futures* **2022**. [CrossRef]
77. Armutlu, M.E.; Can Bakır, A.; Sönmez, H.; Zorer, E.; Alvarez, M.D. Factors Affecting Intended Hospitable Behaviour to Tourists: Hosting Chinese Tourists in a Post-COVID-19 World. *Anatolia* **2021**, *32*, 218–231. [CrossRef]
78. Sharma, G.D.; Thomas, A.; Paul, J. Reviving Tourism Industry Post-COVID-19: A Resilience-Based Framework. *Tour. Manag. Perspect.* **2021**, *37*, 100786. [CrossRef] [PubMed]
79. Orîndaru, A.; Popescu, M.F.; Alexoaei, A.P.; Caescu, S.C.; Florescu, M.S.; Orzan, A.O. Tourism in a Post-COVID-19 Era: Sustainable Strategies for Industry's Recovery. *Sustainability* **2021**, *13*, 6781. [CrossRef]
80. Nguyen, H.V.; Quang, T.D.; Alang, T.; Ngo, L.D.H.; Nguyen, T.D. Toward Sustainable Tourism Practice in the Post-COVID-19: Perspectives from Nha Trang, Vietnam. *Cogent Soc. Sci.* **2022**, *8*, 2064590. [CrossRef]
81. Higgins-Desbiolles, F. Socialising Tourism for Social and Ecological Justice after COVID-19. *Tour. Geogr.* **2020**, *22*, 610–623. [CrossRef]

## Article

# Risks in the Role of Co-Creating the Future of Tourism in “Stigmatized” Destinations

Tamara Gajić <sup>1,2,3,\*</sup> , Dragan Vukolić <sup>3</sup> , Marko D. Petrović <sup>1,2</sup> , Ivana Blešić <sup>2,4</sup> , Miloš Zrnić <sup>5</sup> , Drago Cvijanović <sup>3</sup> , Dejan Sekulić <sup>3</sup> , Ana Spasojević <sup>6</sup>, Maja Obradović <sup>7</sup>, Ana Obradović <sup>7</sup>, Ilija Savić <sup>7</sup>, Jasmina M. Jovanović <sup>8</sup>, Mirjana Gajić <sup>8</sup>, Dobrila Lukić <sup>9</sup> and Željko Anđelković <sup>10</sup> 

- <sup>1</sup> Geographical Institute “Jovan Cvijić” SASA, Đure Jakšića 9, 11000 Belgrade, Serbia
  - <sup>2</sup> Institute of Sports, Tourism and Service, South Ural State University, Lenjina76, 454080 Chelyabinsk, Russia
  - <sup>3</sup> Faculty of Hotel Management and Tourism, University of Kragujevac, Vojvođanska 5a, 36210 Vrnjačka Banja, Serbia
  - <sup>4</sup> Department of Geography, Tourism and Hotel Management, Faculty of Sciences, University of Novi Sad, 21000 Novi Sad, Serbia
  - <sup>5</sup> Academy of Applied Studies—The College of Hotel Management, Kneza Višeslava 70, 11000 Belgrade, Serbia
  - <sup>6</sup> Faculty of Economics, University of Kragujevac, Đure Pucara Starog 3, 34000 Kragujevac, Serbia
  - <sup>7</sup> Faculty of Business Economics, Singidunum University, Danijelova 6, 11000 Belgrade, Serbia
  - <sup>8</sup> Faculty of Geography, University of Belgrade, 3/III Studentski Trg, 11000 Belgrade, Serbia
  - <sup>9</sup> Eighth Belgrade Grammar School, 71 Grčića Milenka, 11000 Belgrade, Serbia
  - <sup>10</sup> National Museum Niš, 14 Generala Milojka Lešjanina, 18105 Niš, Serbia
- \* Correspondence: tamara.gajic.1977@gmail.com



**Citation:** Gajić, T.; Vukolić, D.; Petrović, M.D.; Blešić, I.; Zrnić, M.; Cvijanović, D.; Sekulić, D.; Spasojević, A.; Obradović, M.; Obradović, A.; et al. Risks in the Role of Co-Creating the Future of Tourism in “Stigmatized” Destinations. *Sustainability* **2022**, *14*, 15530. <https://doi.org/10.3390/su142315530>

Academic Editors: Zygmunt Kruczek and Bartłomiej Walas

Received: 15 October 2022

Accepted: 14 November 2022

Published: 22 November 2022

**Publisher’s Note:** MDPI stays neutral with regard to jurisdictional claims in published maps and institutional affiliations.



**Copyright:** © 2022 by the authors. Licensee MDPI, Basel, Switzerland. This article is an open access article distributed under the terms and conditions of the Creative Commons Attribution (CC BY) license (<https://creativecommons.org/licenses/by/4.0/>).

**Abstract:** The primary goal of this paper was to investigate the strength of the influence of different types of risk on the travelers’ intention to visit destinations in future, that are, prejudiced due to COVID-19, marked as “stigmatized”, “isolated”, or “risky destinations”. Field interview research was conducted at the “Belgrade Nikola Tesla Airport” (Serbia). The results obtained by multiple regression analysis showed that all types of risks influenced the intention of travelers, with financial risk showing a more significant impact. Canonical discriminant analysis indicated that men were most afraid of human induced risk, service quality risk, natural disaster and COVID-19 risk, and they chose safer destinations. Among the women, the biggest fear was financial risk, socio-psychological risk, and food safety risk. Older respondents and those under the influence of external factors decided on safer destinations, while financial status did not play a significant role in predicting the choice of destination. The selection of the destination according to the degree of security was determined by the ordinal regression methodology. The entire research presents a certain novelty, because so far in the numerous studies on the topic of the negative consequences of COVID-19 on tourism, there has been no discussion of stigmatized or risky destinations that received that epithet, and were therefore negatively and unfairly marked in the minds of tourists for future visits.

**Keywords:** risks; COVID-19; stigmatized; destinations; tourism; Serbia

## 1. Introduction

From the beginning of the COVID-19 pandemic until today, some countries have been put on the very edge, and marked as “isolated” or “stigmatized” by creating prejudices among travelers [1]. These are countries such as China and Italy as well as some other countries that had the largest number of victims during the pandemic, where the future of tourism is still questionable [2,3]. Safety measures in some countries still exist, although they are in a minimal form such as wearing masks in public and maintaining a distance [4,5]. It has become a habit for all residents, but a new way of life [6]. In May 2022, the Chinese authorities introduced controlled movements and departures abroad, with extensive controls on the reason for departure, and certificates of receipt of all doses of vaccines, with the obligation of 14 days of quarantine, and the obligation to perform

a PCR test upon entering the country [7]. There has been a small number of people who have decided to visit China as tourists, but mostly for business reasons or to visit family [2]. When looking at the situation in Serbia, it can be seen that tourism is slowly recovering. In May 2022, compared to May 2021, the number of visits increased by 88.4%, while the number of overnight stays increased by 56.1% [1]. Passenger traffic in the first quarter of 2022 increased three times compared to the same period in 2021 to 46.1% less than the level of 2019 (40.8% less in March) [1].

Figure 1 illustrates the spread of the coronavirus around the world and the countries that had the highest percentage of deaths (2020).

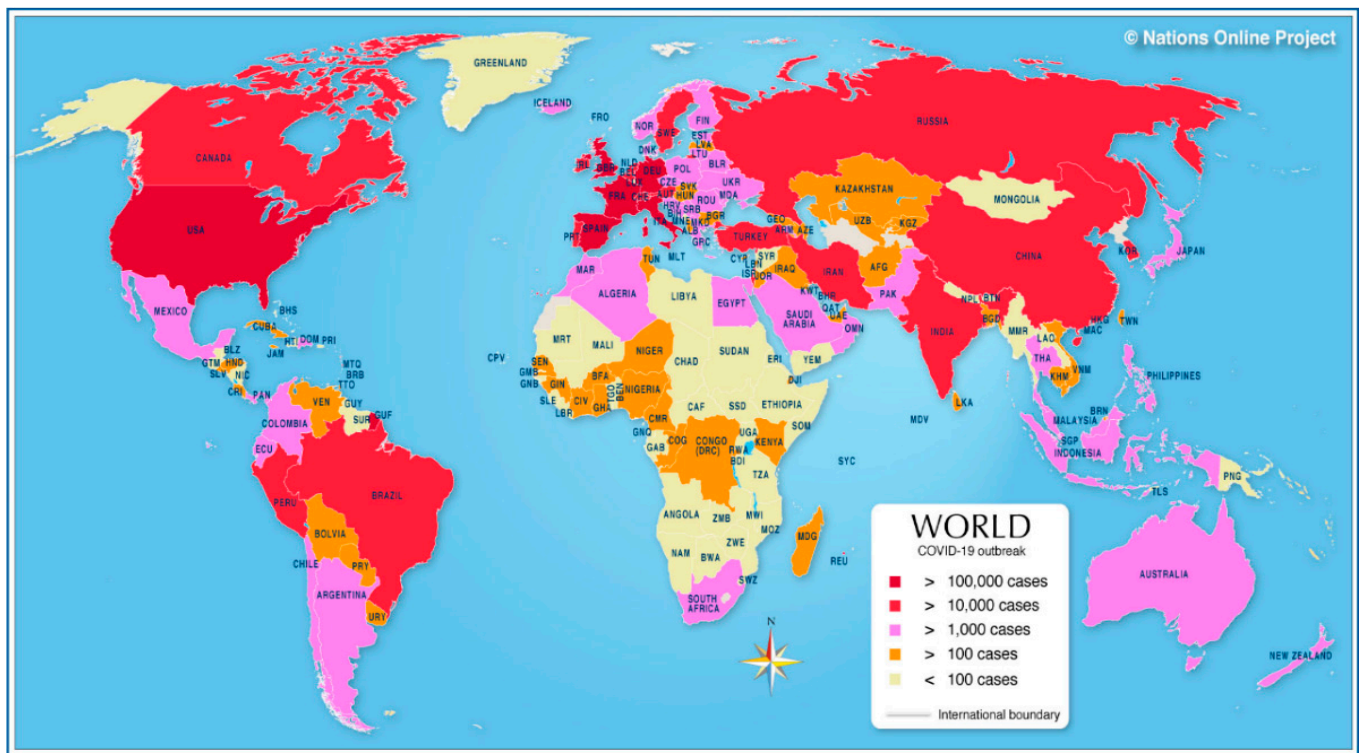

**Figure 1.** The world map of countries with number of confirmed COVID-19 cases (2020). Source: (<https://www.nationsonline.org/oneworld/map/New-Coronavirus-2019-nCoV-world-map.htm>, accessed on 17 September 2022).

There are no accurate data or research that have confirmed that the media or a negative experience is the main reason for creating prejudices and fears among travelers when making their decisions about future trips [1]. In some studies, it was only considered that the experience, together with the media presentation of the destination, is the way to create subjective feelings that will influence the decision-making of consumers [8]. The pandemic is not just a medical phenomenon, in any case, it has great implications for people's mental health and the fear of travel, especially to countries that have been under a lot of media attention due to the number of deaths [3,9]. Despite the modern age, health risks can be limiting factors during travel and threaten the safety of travelers [10,11]. Risk perception is generally a subjective assessment of possible situations during the trip, and it is individually created by different profiles of visitors [12,13]. The influence of risk on decisions about future trips, especially to countries marked as risk destinations, depends on the personal experience of travelers and their awareness of the crisis situation and negative consequences [14,15].

Based on existing research and available literature, the authors conducted a field interview research at the largest and busiest international airport in Serbia—Belgrade Nikola Tesla Airport (BEG). The survey was short and very precisely explained. It partly

relied on similar research conducted by Gajić et al. [1], which also related to fears of a pandemic and financial risk in different personality profiles.

Although there are many types of risks, the emphasis was placed on the consequences of the pandemic as a current issue related to the enemy of the civilized living of the 21st century. The importance of the research is reflected primarily in the examination of risk perception by travelers when making a decision to go to countries that are on the very margin in terms of visiting, after the pandemic. The goal was to determine how much the fear of the pandemic left negative awareness among travelers in the following period. Based on the results, it will be possible to determine the influence of internal and external factors (experience and media) on the creation of subjective fears in people during travel, predict their directions of movement, and predict future tourist flows should a new unforeseen crisis arise. The study provides insight into data that can be helpful in creating research and theories of tourist behavior in the post-COVID period.

## 2. Literature Review

The pandemic is changing the economy, tourism, and awareness in society [16–19]. COVID-19 has created great fears and anxiety among people [20,21], but only the short-term effects of the pandemic are visible, while the long-term effects related to consumer behavior in the future have not yet been fully observed [22,23]. Due to the fact that the impact of different types of risk on people's awareness has not been fully explored, Zaman et al. [10] developed a risk scale or construct that measured the intrapersonal anxiety of travelers, based on which it will be possible to predict future behavior if a pandemic or similar crisis situation occurs. All tourist decisions related to travel are determined by the perception of safety and security [24], and the perception of safety itself is a subjective attitude of an individual that implies understanding and knowledge of the type of risk [25–28]. In addition to the risk of infection, the same authors listed several other types of perceived risks that were no less important than the risk of a pandemic [16]. Some of these were: human induced risk (caused by human action), service quality risk (lack of quality service), natural disaster (nature hazards), financial risk (financial losses; unstable economy), socio-psychological risk (negative influence on the cultural factors of the people), and food safety risk (the risk of non-compliance with safety measures when preparing food) [16]. It is believed that in the post-COVID period, intact tourism will have a great impact, more precisely, destinations that did not feel the attack of the pandemic will gain a high position in the attendance market [29]. The pandemic has definitely created new domestic consumers who are turning to nature [30]. Certain studies have established five levels of risk associated with the intention to travel: psychological risk (the impact of purchases and decisions on the attitude towards oneself and on the level of self-esteem), social risk (how the impact of shopping on the attitude of others about us), physical risk (the impact of shopping on the physical state of financial risk (fear of money shortages), and time risk (costs related to planning and opportunity time costs) [31–33]. In the research on risk perception, this relationship with the pandemic and the intentions of tourists lacks a clear conceptualization and measurement [34]. A study conducted in Uruguay, where the sample was collected using a convenience sampling method, indicates that most travelers still had a high perception of the risk of COVID-19, but that there was interest in travelling to Uruguay. They obtained two groups of visitors who behaved differently under the influence of the fear of the pandemic: groups who were more willing to travel domestically and abroad during the pandemic, and groups who were more moderate and cautious about the risk of travel [35]. Some studies have indicated a strong influence of geopolitical risk on the movement of tourists [36]. However, there is significant evidence presented by Blešić et al. [13], where based on the types of tourists, they indicated the existence of differences in the objective and subjective perception of the risk of natural disasters.

Destinations that have suffered crisis situations, and the intention of tourists to visit the same destinations in the future have been the subject of research by many theoreticians in the field of tourism development [37–39], but very few studies have been carried out

on consumer behavior after the COVID-19 crisis, and their decision to visit “isolated” or “stigmatized” destinations [12]. In many cases, the perceived risk of COVID-19 was not a significant predictor in making a travel decision, but the negative impacts of the pandemic on tourism were certainly noted [40]. Pappas and Farmaki [37] proved with their results that respondents took the risk of contracting COVID-19 seriously, and that some respondents still did not feel comfortable on domestic trips, but wanted to believe in the hygiene measures taken at each location in the close future [41,42]. Qi et al. [39] used the theory of protection motivation to explain the intention and decision-making to travel during a crisis and determine their relationship. Their theory relies on the theory of expected values and explains the relationship between risk perception and “cognitive appraisal processes” and their influence on changes in intentions or attitudes.

The risk and fear of infection has influenced the great reluctance of visitors to restaurants and catering establishments in the future period [43,44]. Research has shown that the majority of travelers are more likely to change their travel plans to a destination that has an increased risk, while a minority of them indicate that they are less likely [45]. Serbian tourists are largely afraid of traveling abroad during the COVID-19 pandemic [8,46], but also the fear of the lack of funds or financial risk that may follow in the post-COVID period [14]. At the very beginning of the pandemic, an interesting survey was conducted in the Dach region of Germany on a sample of 1156 respondents, and an increase in the fear of COVID-19, travel risk perception, and travel behavior during a short stay in the destination was found [47]. The passenger’s risk perception is their search for information about a certain risk, and the subjective assessment of the severity of the risk affects their decisions regarding future travel [48]. Subjective prejudice as a consequence of something happening, and later subjective assessment of the chance of it happening again in the future, is a heuristic approach in personality psychology [14].

The influence of personality traits on the intention to travel during crises is known [49], where certain groups of personalities do not react to any prejudices about destinations after crisis situations, especially those that are exposed in the media and presented in people’s minds as isolated [8]. For certain personality types such as extroverts, the fear of risk has no influence on the decision to travel to a destination where the risk may be created again [14]. Alkieer et al. [46], in their research, claimed that the perception of travel risk and health-psychological risk was higher, in both periods, during and after the pandemic. Uncertainty, worry, fear, and anxiety were closely related to risk perception in the travel decision [50–53]. However, some research indicates that there are multiple vague theories about subjective risk perception on the travel decision in the future [52,54]. Ashikul et al. [2] arrived at the result that the COVID-19 pandemic affected the consciousness of people in the world toward the direction that they were even afraid to mix with the Chinese population. The strong influence of the media in presenting China as an isolated destination had consequences for Chinese tourism, according to the same research. Of course, other types of risk also affect the decision of travelers, and among them, both the risk of violence and socio-psychological risk had a significant negative impact on the participants’ intention to visit China [43]. Travel risk and management perceptions had a significant relationship with risk management, service provision, transport patterns, distribution channels, avoiding overcrowded destinations, and hygiene and safety [55–57]. One interesting study conducted in Macau found that high perceived travel risk during COVID-19 increased negative emotions and decreased travel intentions [58]. Research on risk perception in the COVID-19 period can contribute to the subsequent observation of consumers and the prediction of their behavior [59]. Any perceived risk worsens the mental state of tourists by creating anxiety [60], and negatively affects the decision-making to go to a given destination [61,62].

The media can influence people’s consciousness to create extreme fears and prejudices [63]. Certain theoreticians have previously investigated the strong influence of the media on the awareness of tourists [64], creating prejudices among travelers during the decision-making process regarding travel [12]. As much as the media create a panic situa-

tion, to another extent, they can restore the brand of the destination and create a positive image for people [57,65]. There are even opposing views that the media do not have such a strong influence on personal experience, decisions, and risk perception [66]. Media and social networks have a strong influence on tourists, but theories related to this are very limited [67,68]. The results revealed that past experience of traveling to certain regions simultaneously increases the intention to travel there again and decreases the intention to avoid areas, especially risky areas [69].

According to Carballo et al. [65], it was shown that women were more afraid of going to risky destinations than men, while men reported a bad experience regarding a risky destination to a greater extent than women did. Men were more risk tolerant and created weaker risk perceptions than women [70,71]. In people's minds, risk manifests itself differently in decision-making in relation to gender differences [72], which certainly creates an essential basis for further risk management and the understanding of tourists [73]. Risk is defined in different dimensions depending on personality traits, gender, culture, and previous experience [74]. The type of risk that creates the greatest fears for women when making travel decisions is physical violence or sexual harassment [75]. Furthermore, women are more afraid than men to make decisions to travel abroad because it seems an unsafe destination to them [76]. However, with the advent of the COVID-19 pandemic, women rated the image of China as a tourist destination higher than men [77].

Some earlier research pointed to different attitudes about the impact of the fear of infection on travelers, but also the lack of theories related to proving the impact of different types of risk on travel and the purchase of tourist products by travelers [78]. However, apart from the risk of a pandemic, along with the same power of influence on the travelers' awareness, there was also a financial risk [14], where the perception of that kind of risk and the attitude of customers did not show effects on satisfaction, but had a significant impact on intention behavior [12,79], and proved to be the most important factor in consumption [80].

The biggest criticism of the majority of research thus far is that almost no studies have highlighted the issue of the movement of visitors to destinations that have been marked as risky by the media, even after the pandemic has passed [1]. The awareness that dictates the movement pattern of the visitors is connected to the image of the situation that remains imprinted in the consciousness for a long period of time [56]. The question is what happens to their desire to visit such destinations in the future and how long it would take for those countries to regain their positive image from before the pandemic.

The fact is that there is no official evidence obtained through research of whether these destinations are still threatened, apart from media reports, about the influx of tourists. Of all the destinations that have been cited most in the media as risky, China is still under attack [46]. The data show that a strategy called the "zero covid" strategy was introduced in China. This means that there are still measures to limit movement, regardless of the elimination of all cases of infection in the country [81]. However, all the states that suffered the strongest impact of the pandemic are also facing other difficulties such as an economy that is slow to recover, climate change, the loss of technological giants in China, and the strained economic relations between China and the U.S. [82]. These are all factors that have a negative impact on the promotion of the tourist market, but the pandemic made a strong and crushing impact on these countries, and the aim of this research was to highlight the extent to which risk awareness is still represented among visitors in these countries [83]. Hypotheses are proposed on the basis of the mentioned similar literature and research problems (Figure 2):

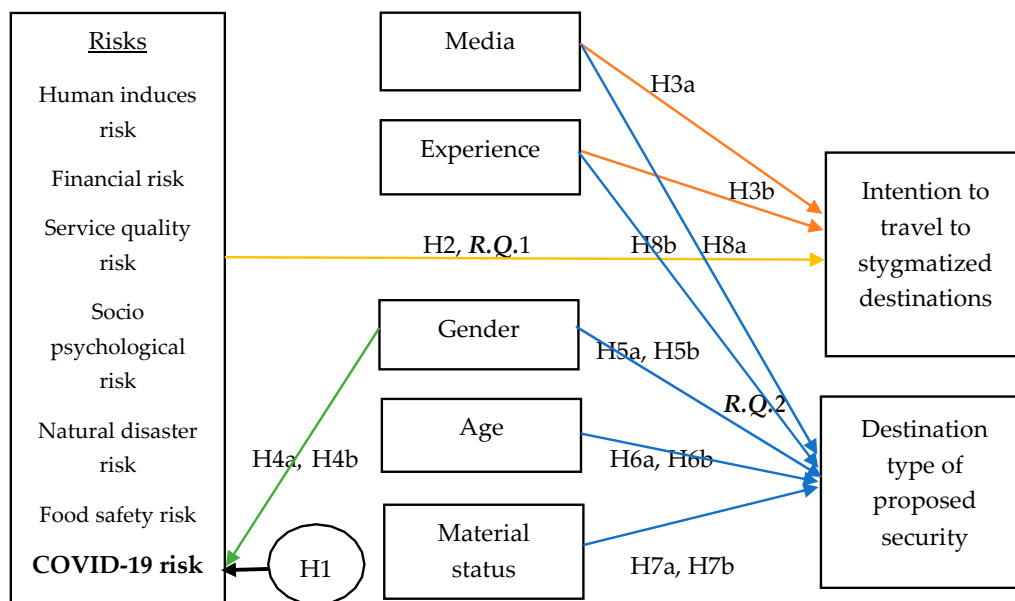

**Figure 2.** Proposed model of research with the defined hypotheses.

**H1:** People are most afraid of COVID-19.

**H2:** All types of risks have a significant impact on the intention to travel, without the influence of external factors (media, experiences).

**H3a:** Media, as a mediator, significantly changes the strength of the influence of different types of risk on the intention to travel to “stigmatized” destinations.

**H3b:** Experience, as a mediator, significantly changes the strength of the influence of different types of risk on the intention to travel to “stigmatized” destinations.

**H4a:** Women are more afraid of COVID-19.

**H4b:** Men are more afraid of COVID-19.

**H5a:** Women are more determined to go to “stigmatized” destinations.

**H5b:** Men are more determined to go to “stigmatized” destinations.

**H6a:** The elderly are more determined to go to “stigmatized” destinations.

**H6b:** Younger people are more determined to go to “stigmatized” destinations.

**H7a:** The rich are more determined to go to “stigmatized” destinations.

**H7b:** The poor are more determined to go to “stigmatized” destinations.

**H8a:** The media have a significant influence on the choice of destination according to the proposed level of safety.

**H8b:** Experience has a significant influence on choosing a destination according to the proposed level of safety.

### 3. Methodology

#### 3.1. Sample and Procedure

The research was carried out from January to July 2022 at the Belgrade Nikola Tesla Airport in the Serbian capital of Belgrade. The total sample was 522 respondents. The required sample size was calculated using the G\*power test [84]. Considering that there was a total of nine predictors (seven independent in the first step, and two inserted in the second step of the applied analysis) and one criterion, the required effect size was set at



$\eta^2 = 0.15$ , with a statistical power of 0.95, and it was calculated that a sample size of 166 respondents could be appropriate for this research. The authors of the paper, together with 45 students of the School of Tourism and Hotel Management in Vrnjačka Banja, collected the sample by interviewing passengers while they were waiting to check in for their flight. Two main research questions (R.Q.1–2) were appointed:

R.Q.1: Which of the mentioned fears is the most represented when making a decision about traveling in the future to the “stigmatized” destinations?

R.Q.2: Do some of the demographic and external factors (media and experience) influence the choice of destination in terms of its proposed level of safety?

The sample was not large due to limited flights in this period, and due to the non-cooperation of passengers with the research team. The research was of a voluntary nature, carried out in the context of a pilot study, and it was assumed that this number of respondents could be representative because the research was carried out at the airport in reduced working conditions. Each question was asked very clearly and briefly verbally, in order to obtain a quick answer from the passengers, without causing them to refuse. Of the total number of respondents, 25.4% belonged to the age group of 18 to 30 years, followed by 41.9% over 50 years, and 32.7% from 31 to 50 years. When looking at the demographic structure of the respondents, there was not a big difference regarding the gender structure as 49.4% of men and 50.6% of women were interviewed. Looking at the educational structure, it can be seen from the results that 63.8% had a university degree, and 36.2% had lower education, which means high school. Other groups had no share.

### 3.2. Measures

The authors used the existing risk scale from Zaman et al. [10]. These authors established a seven-point risk scale using multiple data collection methods including interviews, focus groups, and survey questionnaires. In addition, the authors of this research followed up on the research they conducted in 2021 on the topic of perceived fear of the pandemic and financial risk in relation to the psychological typology of personality [1]. The adopted scale contains the following types of risk: human induced risk (total of three items: political instability  $\alpha = 0.822$ , terrorism  $\alpha = 0.753$ , crime  $\alpha = 0.630$ ); financial risk (total of three items: additional costs  $\alpha = 0.797$ , higher prices than expected  $\alpha = 0.761$ , influence of the financial situation in the destination  $\alpha = 0.699$ ); service quality risk (total of three items: quality of accommodation and food, hospitality  $\alpha = 0.785$ , durability of tourist infrastructure  $\alpha = 0.892$ ); socio psychological risk (total of three items: influence of friends on the decision  $\alpha = 0.803$ , influence of family  $\alpha = 0.992$ , self-assessment  $\alpha = 0.942$ ); natural disaster risk (total of two items: natural disasters  $\alpha = 0.789$ , traffic accidents  $\alpha = 0.810$ ); food safety risk (total of two items: quality of food  $\alpha = 0.786$ , quantity of food  $\alpha = 0.709$ ); and COVID-19 risk (total of three items: fear of infection  $\alpha = 0.805$ , fear of dying  $\alpha = 0.929$ , fear of associated diseases  $\alpha = 0.860$ ). The values for two mediators were also obtained: media (total of two items: the media influence the choice of a tourist destination  $\alpha = 0.760$ , the media influence the perception of fear when traveling  $\alpha = 0.846$ ) and experience (total of two items: experience influences the choice of destination  $\alpha = 0.870$ , the experience affects the creation of fear when traveling in a crisis period  $\alpha = 0.690$ ). Only one criterion variable was called intention to travel (I intend to travel  $\alpha = 0.600$ , I do not intend to travel  $\alpha = 0.721$ ). Cronbach’s alpha values are given in parentheses, more precisely, the coefficient used to measure the reliability of each item or scale is given. It can be seen that the reliability of each item in this research is of high value. In addition, the authors, studying the literature related to the research of the development of the destination during crisis situations, divided or ranked the destinations according to the proposed degree of security. The first rank was made up of domestic destinations because it considered that they were the safest to travel and stay in during a crisis period; the second rank was foreign destinations that were not marked with a negative image; and the third rank was destinations that were marked as isolated or risky, and even “stigmatized” destinations.



### 3.3. Data Analysis

Statistical processing of the collected data was carried out using the statistical program SPSS, version 26.00. According to Tabacnick and Fidell [85], all variables were normally distributed (Sk and Ku are in the range  $-1.5$ – $1.5$ ), and parametric statistical analysis was used. Descriptive statistical analysis was used to process the obtained data to determine the average score for each of the items as well as the standard deviation. In this way, each type of risk was assessed. A five-point Likert scale was used, and in some questions, only coded yes and no answers were used. For the answers to the question about the safety of the destination, the respondents had three answers on offer, more precisely, three coded ranks of destinations, listed in the section above. Exploratory factor analysis includes the reduction and condensation of a set of manifest variables into a smaller number of latent variables [86]. Then, with the help of Horn's parallel method, the exact number of components that should be retained, which were obtained by exploratory factor analysis, was determined [87]. In this case, the exact number of seven factors to be retained was confirmed. A hierarchical regression analysis with mediation was performed in order to determine whether any of the predictors, in this case, risk types, can have a statistically significant impact on the decision to visit destinations that were considered high risk during the pandemic. More precisely, hierarchical analysis served as a statistical test of the effect of the mediator variables [88]. Experience and the media were taken as mediators, to see whether they significantly influenced the decision to travel to once very risky destinations due to the pandemic. In addition, the authors aimed to determine the differences in the perception of risk types in relation to the gender structure by means of a discriminative canonical analysis [89]. Canonical discrimination analysis procedures are primarily intended to examine the existence of differences between groups (i.e., of two or more experimental or real populations on a set of quantitative traits, and analyzing the nature of the structure or composition of those traits underlying the existing differences). These procedures basically boil down to transforming quantitative multivariate data in order to more economically and clearly see the differences between populations defined by the categories of some qualitative feature [90]. The authors used ordinal logistic regression analysis [56], coding the destinations according to the level of safety in three ranks or categories. Demographic factors and external factors (media and experience) were used as predictors in this type of regression. A graphical scheme of the research method can be seen in Figure 3.

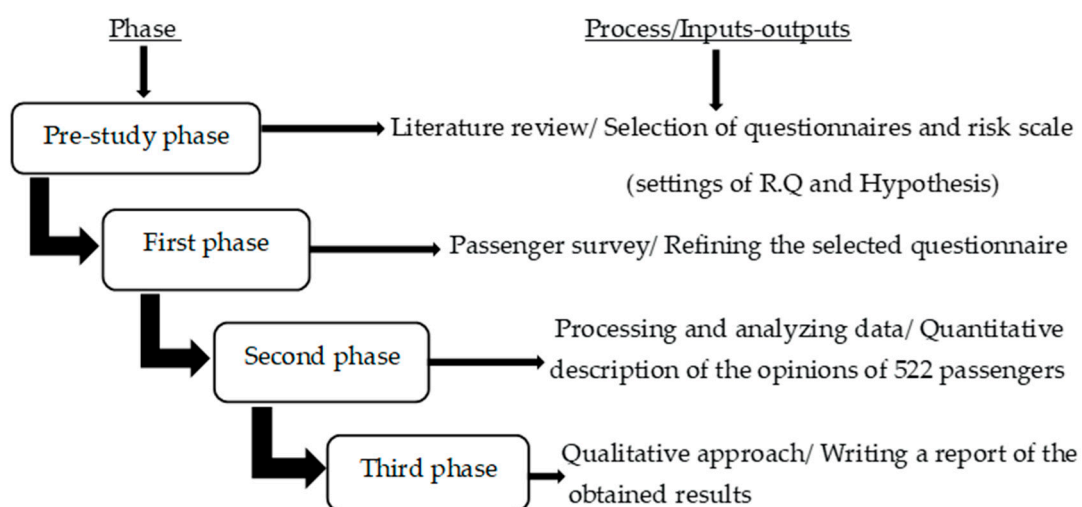

Figure 3. A graphical scheme of the research flow.

## 4. Results and Discussion

Taking into account the goal of the research, and in order to obtain answers to key questions and confirm hypotheses, a combined method of qualitative and quantitative

analyses was used. Combined research involves the use of primary and secondary data, in order to observe existing relationships between variables.

#### 4.1. Perceived Types of Risk and Their Impact on the Intention to Travel to Risky or Stigmatized Destinations

Table 1 gives the values of the arithmetic means for each type of risk as well as the values of the standard deviation. It can be seen that the highest average rating was given to financial risk, with a rating of  $m = 2.99$ , and socio-psychological risk of  $m = 2.67$ . The lowest value of the arithmetic mean was carried by the human induced risk  $m = 1.98$ . Then, the service quality risk was assessed with an average score of  $m = 2.19$ . The natural disaster risk was assessed with an average score of  $m = 2.17$ , while the food safety risk was assessed with  $m = 2.13$ . Regarding the COVID-19 risk, it had an average score of 2.06. Table 1 also shows the results of the exploratory factor analysis, which was confirmed by the mathematical Horn's parallel method. It was observed that a total of exactly seven factors were obtained from all the variables in the research. The total percentage of explained variance was 44.5%, while the first factor had the highest saturation in the value of 9.92%. The first factor in the largest percentage explains the common variance of the set of manifest variables, while the other factors have a lower percentage saturation.

**Table 1.** Results of descriptive and exploratory factor analysis.

Factors	m	sd	Total	% of Variance	Cumulative %
Human induced risk	1.98	1.169	3.188	9.924	9.924
Financial risk	2.99	1.422	2.218	6.932	16.896
Service quality risk	2.19	1.339	2.195	6.860	23.756
Socio psychological risk	2.67	1.412	1.806	5.642	29.398
Natural disaster risk	2.17	1.343	1.784	5.576	34.974
Food safety risk	2.13	1.346	1.559	4.872	39.846
COVID-19 risk	2.06	1.291	1.519	4.748	44.594
Domestic destinations	Foreign destinations		Stigmatized destinations		
36.5%	35.1%		28.4%		

Note: m—arithmetic means, sd—standard deviation.

Of the total number of respondents, 36.5% said that they would choose a domestic destination, 35.1% a foreign destination, while 28.4% said that they would like to travel to a stigmatized destination. Table 1 provides data that negate the initial hypothesis H1, that people are most afraid of COVID-19. In this research, the results show that it was insignificant, but still noticeable, that the majority of people perceived the fear of financial risk and socio-psychological risks more strongly than the fear of COVID-19. In this table, it can be seen as a partial answer to research question R.Q.1, which of the fears had the greatest influence on the decision to travel to stigmatized destinations.

#### 4.2. The Degree of Influence of Different Types of Risk on the Intention to Travel

Table 2 provides an insight into the results of the multiple hierarchical regression analysis, which shows the procedure before the introduction of the mediator (Step 1), and the procedure and results after the introduction of the mediator (Step 2). The results of the regression analysis show that a large percentage of the variance can be explained by all seven predictors, in both steps of the analysis, before and after the introduction of mediator variables, where unchanged statistical significance was observed (Step 1:  $R^2 = 0.0954$ ,  $F = 1502.143$ ,  $\text{sig} = 0.00$ ; Step 2:  $R^2 = 0.956$ ,  $F = 19.671$ ,  $p = 0.00$ ).

**Table 2.** Impact of the perceived risks on travel intention (multiple hierarchical analysis with mediation).

STEP 1				
	B	Beta	t	p
Human induced risk	0.120	0.154	14.777	0.001
Financial risk	0.148	0.234	16.908	0.000
Service quality risk	0.120	0.177	13.457	0.000
Socio psychological risk	0.127	0.198	14.623	0.000
Natural disaster risk	0.139	0.205	16.762	0.000
Food safety risk	0.155	0.230	17.006	0.000
COVID-19 risk	0.149	0.211	18.020	0.000
$R^2 = 0.954, F = 1502.143, sig = 0.000$				
STEP 2				
	B	Beta	t	p
Human induced risk	0.121	0.156	15.222	0.000
Financial risk	0.139	0.218	15.599	0.000
Service quality risk	0.118	0.174	13.495	0.000
Socio psychological risk	0.120	0.187	13.850	0.000
Natural disaster risk	0.139	0.204	16.973	0.000
Food safety risk	0.153	0.227	17.104	0.000
COVID-19 risk	0.146	0.208	18.005	0.000
Media	0.034	0.050	4.435	0.000
Experience	0.143	0.203	8.005	0.000
$R^2 = 0.956, F = 19.671, p = 0.000$				

Note: Dependent variable: intention to travel to “isolated, stigmatized or marked”. destinations, mediators: media, experience.

The  $R^2$  coefficient indicates how much percent of the variance can be explained. These results indicate that the model fits the data. The contribution of all seven predictors in predicting the criteria was significant, more precisely, each type of risk showed a statistical significance in predicting the decision to visit the destinations that were most affected by the pandemic. Table 2 shows the partial contribution data for each of the risks (b) as well as the correlation of how much they are related to the predictor ( $\beta$ ). The largest partial contribution was shown by the food safety risk ( $b = 0.155$ ) and financial risk ( $b = 0.148$ ), followed immediately by the natural disaster risk ( $b = 0.139$ ) and COVID-19 risk ( $b = 0.149$ ). It was shown that the risk of a pandemic from the given risk scale did not show the greatest contribution in influencing the predictor. However, adding mediators that were considered to be able to influence the perception of risk among travelers increased the partial contribution of pandemic risk ( $b = 0.146$ ), and food safety risk ( $b = 0.153$ ) was again in first place. In this case, experience and the media increased the people’s fear of going to certain destinations, more than financial fear. Given that the changes were insignificant or very small, and that each predictor had a partial contribution, which was partial mediation. Both mediators (experience and media) had statistical significance, but did not provide full mediation, because even before their introduction, all predictors significantly influenced the criterion variable.

After the obtained results of the multiple hierarchical analysis, hypothesis H2, that all types of risks have a significant impact on the intention to travel (without the influence of external factors), was confirmed. However, H3a and H3b were rejected, because the media and experience (although significant in predicting the intention to travel) did not

significantly change the strength of the influence of all types of risks on the intention to travel to stigmatized destinations. It was determined that it was a partial mediation, not a full mediation. Table 2 also shows the complete answer to research question R.Q.1, where it can be seen that each of the fears had an impact on the decision to travel to stigmatized destinations.

#### 4.3. The Influence of Sociodemographic Factors (Gender) on the Intention to Travel during a Crisis Situation

Table 3 gives the results of the discriminant canonical analysis. The authors aimed to determine the existence of differences between groups (i.e., two populations on a set of quantitative characteristics). The value of Wilks' Lambda was 0.943, which shows the statistical significance and that there were differences in relation to the composition. The canonical correlation value was 0.238, which means that 8.41% of the variance can be explained by this model, which is a very good value.

**Table 3.** General indicators of model fit with data.

Eigenvalue	Wilks' Lambda	Chi-Square	df	Sig.	Canonical Correlation
0.060	0.943	30.228	7	0.000	0.238

Table 4 shows that men had the greatest fear of human induced risk (−0.250), service quality risk (−0.209), natural disaster risk (−0.161), and COVID-19 risk (−0.135) while women were afraid of socio psychological risk (0.674), financial risk (0.514), and food safety risk (0.030).

**Table 4.** Indicators of different perceptions of risk in relation to the gender structure of the respondents (canonical discriminant analysis).

Standardized Canonical Discriminant Function Coefficients		Function 1
Socio psychological risk		0.674
Financial risk		0.514
Human induced risk		−0.250
Service quality risk		−0.209
Natural disaster risk		−0.161
COVID-19 risk		−0.135
Food safety risk		0.030
Functions at Group Centroids		
Male −0.270	Female 0.223	
Classification Results—Predicted Group Membership		
Male 58.5%	Female 41.5%	
56.5% of the original grouped cases correctly classified		

The probability that the respondent would belong to a group was 56.5%. The exact classification is shown in Table 4, where it can be seen that 58.5% of men and 41.5% of women belonged to these groups. How accurate the classification is can be shown by the fact that there was a 56.5% chance or probability that the respondent would belong to one of the given groups. Hypothesis H4a, that women are more afraid of COVID-19, was rejected, while hypothesis H4b, that fear of the pandemic is more pronounced in men, was confirmed. There were statistically significant differences in relation to composition, more precisely, there was a difference between the groups, that is, two populations on a set of quantitative characteristics. Simply put, there is a difference in the perception of types of risk in relation to the gender structure of the respondents.

#### 4.4. Choosing a Destination According to the Rank of Security, in Relation to Sociodemographic and External Factors (Media and Experience)

Table 5 provides insight into the results obtained by ordinal regression analysis, which was used to determine the choice of destination, with the fact that at the very beginning, the destinations were coded into three categories according to the level of safety. Sociodemographic factors that served as predictors for the possible selection of one of the three coded destinations were gender, age, and financial status, while the media and experience were used as external factors for the analysis.

**Table 5.** Results of ordinal logistic regression analysis.

		Estimate	Std. Error	Wald	df	Sig.
Predictors	Media	−0.619	0.609	1.035	1	0.009
	Experience	−0.466	0.603	0.597	1	0.040
Gender	Male	−0.411	0.245	2.818	1	0.003
	Female	0 <sup>a</sup>			0	
Age category	18–30	0.857	0.267	10.309	1	0.001
	31–50	−0.600	0.261	5.274	1	0.022
	51+	−0.389	0.485	8.723	1	0.000
Material status	300–500	−0.735	0.610	1.454	1	0.228
	500–1000 Euro	0.729	0.290	6.331	1	0.082
	1000+	0.184	0.443	4.343	1	0.068

Link function: Logit. <sup>a</sup>. This parameter is set to zero because it is assumed to be the opposite of the first category. Destination types are coded into three categories according to the level of security: 1. Domestic destination 2. Foreign destination (without negative image). 3. Stigmatized destination.

The general indicators of model fit showed that it fit well with the data, where the following values were obtained: Chi-square- 30.148,  $p = 0.00$ ; GOF (goodness-of-fit) with values 0.762, then Pseudo R2: Naglekerke 0.87. Destination categories were coded according to the level of security: (1) domestic destinations, (2) foreign destinations (destinations without a negative image), and (3) stigmatized destinations. The results showed that the media and experience had a statistical significance in the selection of the three coded destinations. Respondents who were influenced by the media and experience were more decisive in choosing the domestic destination as a safer type of vacation (media  $E = -0.619$ ; experience  $E = -0.466$ ). These results confirmed hypotheses H8a and H8b. Considering the data obtained by ordinal logistic regression analysis, men chose safer destinations coded under category 1, while women showed the opposite (H5a was confirmed and H5b rejected). Regarding age, it was observed that as a predictor, it plays an important role in choosing a destination, therefore, it was observed that all categories were more susceptible to choosing safer destinations. The older they were, the more likely they were to choose a safer destination (H6a rejected). Except for the category from 18 to 30 years old ( $E = 0.857$ ), where the choice of destination was the opposite, more precisely in that category, they were ready to go to isolated or less safe destinations (H6 was confirmed). Material status was not a statistically significant predictor, so the hypotheses H7a and H7b were rejected. These data provide an answer to the second research question (R.Q.2) of which of the demographic factors influence the choice of destination according to the proposed level of safety.

## 5. Discussion

Many studies that have been conducted have provided different results regarding the types of risks and their strength in the intention to travel. Rittichainuwat and Chakraborty [87] emphasized the stronger impact of health risks than the impact of ter-

rorism. Law [88] also highlighted the stronger impact of human risks compared to all of the other perceived types of risk. Some studies have highlighted the strong influence of geopolitical risk on the tourism sector [91]. However, all of the research that has been conducted thus far only talks about the types of risks and their impact on the visitors' decisions [92,93]. Some of them have highlighted risky destinations that have been marked with that label for many years due to economic instability or socio-political disharmony [94]. There has been almost no research focusing on decisions to travel to risky destinations after severe and unforeseen sudden crises or pandemics, especially after COVID-19 [95]. The main goal of this research was to determine which types of risk have the greatest influence on the visitors' intentions to go to countries that are somehow marked as risky after the pandemic. The results of the research show that financial and socio-psychological risk have a stronger influence on visitors' decisions than the risk of a pandemic.

Additionally, the research obtained data that indicate that each of the mentioned types of risk has an impact on making a decision about traveling to stigmatized destinations. It has been shown that the risk of a pandemic is not the only one and does not have the strongest negative effect on the number of consumers. By introducing factors that influence decision-making such as the media and experience, the situation remained unchanged. They did not have a decisive influence, nor did they increase the effect of the risk, nor did they reduce it. Similar investigations were conducted by Fuchs and Reichel [89], and Koji pointed out in their research on the territory of Israel, following the statistics of visits, that experience as well as psychological factors had the greatest influence on the intention to travel. Lepp and Gibson [45] claimed that experience was the main indicator for decision-making during some crisis situations. Giusti and Raya [90] believed that the strongest perception was human risks, which include terrorism and crime. Reisinger and Mavondo [56], based on research, believed that risks such as health, terrorism, criminality, and political instability were the strongest in their influence on the intention to travel. Chew and Jahari [92], in their research on the value of different types of risk, emphasized health as the most influential.

The influence of sociodemographic factors on risk perception was investigated by Sebra et al. [28]. Their results indicate the existence of heterogeneity in the tourist population in terms of risk perception and intention to travel. Previous research has shown that women are more afraid of traveling to destinations that are marked as risky, and showed more anxiety than men, and they feared for their safety from terrorism and socio-cultural risks [76]. In this research, the results indicated that men were most afraid of the risks caused by the human factor, the risk of not being satisfied with the required quality of services, the risk caused by natural disasters, and the risk of COVID-19. In contrast to the results obtained by male respondents, it was found that the greatest fear of financial risk, socio-psychological risk, and food safety risk was represented among women.

Yang et al. [96] investigated the tourists' risk perception toward Malaysia as a risky destination. They examined the effects of travel experience, prior risk experience, travel motivation, newspaper preference, gender, age, and nationality on the tourists' risk perception. They showed that age, gender, and nationality significantly influenced the choice of a safer destination. Kvítková et al. [93] indicated that domestic tourism is one of the safest types of travel. Similar results were obtained in this research, where it was found that men as well as the older category of pollution chose safer destinations according to the predetermined level of safety. Material status did not prove to be a significant factor in choosing a destination according to the degree of security.

## 6. Concluding Remarks

Many scientific papers have already been written and a lot of research has been conducted on the topic of the negative impact of COVID-19 on all sectors of the economy including tourism. The pandemic caused the most damage to tourism, but not only directly but also in indirect ways, creating fear or prejudice among travelers regarding the destinations where it had the strongest impact and left the biggest consequences. There was

even a study in which the authors found out that at the beginning of the pandemic, tourists were even afraid of socializing and having close encounters with Chinese residents [97,98], but women rated the image of China better than men [62]. However, there is little research on the topic of the fear of going to so-called “stigmatized” destinations, which are marked either by bad experiences or through social networks and the media. Under that term, isolated destinations can be counted primarily as the countries of China and Italy, which are synonymous with COVID-19. Their influence on the perception of fear and risk among travelers has not yet been investigated, especially whether the psychological aspect of the division of personality typology is also included. Of course, the perception of risk when making travel decisions is a subjective feeling, but the literature on it is very scarce. It is certain that China, as the country with the most tragic consequences of the pandemic, is facing other problems related to tourism, but also the entire economy. Some of them are the decline in the economy, the departure of large technological giants, the fall in the Chinese currency, social instability and poverty, climate change, etc. Many other countries that were also under strong attack by the invisible enemy of COVID-19 experienced the same fate, but according to media reports, their return to the tourist market is observed every day. The data provided in the manuscript indicate that China is still facing restrictive measures even after the pandemic, regardless of the fact that the epidemic is declining and the number of infected people is decreasing. It is not officially recorded anywhere that these countries are called “stigmatized” or “risky”, but somehow in society, this term has inevitably been imposed. The goal of the research was to determine the extent to which the risk of a pandemic continues to act as a brake in the mind of visitors in making decisions to travel to these countries. According to the available literature, the authors have tried to reach appropriate results related to the perception of different types of risk among passengers through a pilot study. The results indicated that the risk of a pandemic was not the strongest factor in making decisions for traveling to marked destinations. Additionally, it was found that men were more afraid of human induced risk, service quality risk, natural disasters, and COVID-19 risk, and they chose safer destinations. In the case of women, it turned out that they had a pronounced fear of financial risk, socio-psychological risk, and food safety risk. Regarding the demographic age structure, older respondents and those under the influence of external factors decided on safer destinations, while financial status did not play a significant role in predicting the choice of destination.

The innovativeness of this research was primarily reflected in the accentuation of research on visiting destinations that are unfairly marked by the tragedy of the invisible enemy of COVID-19. There are destinations that fall into the category of risky for tourists, but so far the topic of visiting destinations marked by the COVID-19 pandemic as high risk has not been addressed, even after the pandemic has passed. Additionally, the specificity of the research was reflected in the obtained results, where it might have been expected that there would be different results and that, as usual, women would be more afraid of the pandemic than men. Furthermore, it has been proven that material status did not play a role in determining the strength and type of fear among tourist consumers. In some normal circumstances and environment, material status has a significant contribution in consumer decision-making. COVID-19 certainly brought different and more serious consequences to the society of the 21st century, but also in the domain of access to research and areas of research.

#### *Limitations and Suggestions for Future Research*

There were difficulties primarily due to the problems faced by airlines in the post-COVID period, namely the lack of manpower, flight cancellations, long waits for check-in, nervousness, and non-cooperation with investigators. The passengers were quite reluctant to cooperate with the researchers due to the reasons given, which caused nervousness, impatience, and even panic reactions. Limiting circumstances include the travelers’ fears of giving answers because the post-COVID period is still a taboo topic. The respondents did not even want to talk about the topic of the pandemic in either a positive or negative

context, and especially not about what the consequences will be in the future. The older population in the research stands out as a group that refuses to cooperate on this issue.

The negative effects of the pandemic will only be fully realized in the coming period [83]; if there are no new waves of infection, the consequences of the pandemic on tourism will only be revealed [84]. The more information is available to travelers through social media and the media, the more subjective fear and prejudice will be created among travelers [85,86,99]. The importance of the research is reflected in the fact that, although only the pilot research, the results reached by the authors will be able to be used for larger and more significant research, theory development as well as application in practice, not only in the region but also wider. There is a lack of literature related to the implications of the pandemic on the travelers' decisions to visit destinations that were the hardest hit by the pandemic. These are destinations that can be said to be marked as isolated or stigmatized by the media or personal experience and subjective perception of the travelers.

Furthermore, these data can be the starting point to indicate a very interesting direction of research, which is preconceptions about destinations after the pandemic and general unforeseen crisis situations in tourism. For now, it is a topic that does not have enough research, so this research is a good basis for further investigation in the future. Additionally, based on this sample, it will be possible to predict or at least know the possible direction of research into personality types and their reactions to different types of risk. The passengers' risk perception can answer many questions regarding passenger behavior in the future if a similar crisis situation occurs. With the help of such and similar research, in the future, it will be possible to predict or assume the behavior of travelers, in the sense of whether certain destinations will make a quick return to the tourist market or will be marked in the future as undesirable to visit.

**Author Contributions:** Conceptualization, T.G., I.B. and M.D.P.; Methodology, T.G., I.B. and D.V.; Software, D.S.; Validation, D.C., M.Z. and D.S.; Formal analysis, A.S. and Ž.A.; Investigation, T.G., I.B., M.D.P. and D.V.; Resources, M.O. and A.O.; Data curation, I.S.; Writing—original draft preparation, T.G., M.D.P. and I.B.; Writing—review and editing, J.M.J.; Visualization, M.G.; Supervision, D.L. All authors have read and agreed to the published version of the manuscript.

**Funding:** This research received no external funding.

**Institutional Review Board Statement:** Not applicable.

**Informed Consent Statement:** Not applicable.

**Data Availability Statement:** Not applicable.

**Acknowledgments:** The research will be part of the project “The impact of the pandemic caused by the COVID-19 virus on increasing income in rural tourism” (01.07.2022 to 30.05.2023), based on the Agreement on the Regulation of Personal Rights and Obligations Regarding the Use of Incentives for Improving the System of Creating and Transferring Knowledge through Development of technical-technological, applied, developmental and innovative projects in secondary agriculture and rural development in 2022, concluded between the Ministry of Agriculture, Forestry, and Water Management, the Administration for Agrarian Payments and the Faculty of Hotel Management and Tourism in Vrnjačka Banja, University of Kragujevac.

**Conflicts of Interest:** The authors declare no conflict of interest.

## References

1. Gajić, T.; Petrović, D.M.; Blešić, I.; Radovanović, M.; Syromjatnikowa, J. The power of fears in the travel decision—COVID-19 against lack of money. *J. Tour. Futur.* **2021**, 1–22. [CrossRef]
2. Ashikul, H.; Farzana, A.; Mohammad, H.; Ishtiaque, A.; Abu Bakar, A. The Effect of Coronavirus (COVID-19) in the Tourism Industry in China. *Asian J. Multidiscip. Stud.* **2020**, 3, 1–7. Available online: <https://asianjournal.org/online/index.php/ajms/article/view/213/96> (accessed on 15 July 2022).
3. Ma, L.; Zhang, X.; Xu, F.; Yu, P. How to improve consumers' travel intentions under the COVID-19 pandemic: An empirical study in China. *Int. J. Sustain. Transp.* **2022**. *ahead-of-print*. [CrossRef]



4. Áurea, S.; Castanho, R.A.; Couto, G.; Pimentel, P. Post-Covid Tourism Planning: Based on the Azores Residents' Perceptions About the Development of Regional Tourism. *Eur. Plan. Stud.* **2022**. *ahead-of-print*. [CrossRef]
5. Diego, N.D.; Lorenzo, C. Sensitivity and Vulnerability of International Tourism by Covid Crisis: South America in Context. *Res. Glob.* **2021**, *3*, 100042. [CrossRef]
6. Ilieș, M.; Ilieș, D.; Josan, J.; Ilieș, A.; Ilieș, G. The Gateway of Maramureș Land. Geostrategical Implications in Space and Time, in *Annales. Ann. Istrian Mediter. Stud. Ser. Hist. Sociol.* **2010**, *20*, 469–480. Available online: <http://www.dlib.si/details/URN:NBN:SI:DOC-NNTIIVTV> (accessed on 14 October 2022).
7. Economy R.T.V. Name of the News Consulted. Year of the News. Available online: [https://www.rtv.rs/sr\\_lat/ekonomija](https://www.rtv.rs/sr_lat/ekonomija) (accessed on 15 July 2022).
8. Jonas, A.; Mansfeld, Y.; Paz, S.; Potasman, I. Determinants of health risk perception among low-risk-taking tourists traveling to developing countries. *J. Travel Res.* **2010**, *50*, 87–99. [CrossRef]
9. Tasci, A.D.A.; Sönmez, S. Lenient gun laws, perceived risk of gun violence, and attitude towards a destination. *J. Destin. Mark. Manag.* **2019**, *13*, 24–38. [CrossRef]
10. Zaman, K.; Bashir, S.; Afaq, Z.; Khan, N. COVID-19 Risk Perception of Travel Destination Development and Validation of a Scale. *SAGE Open* **2022**, *12*, 1–10. [CrossRef]
11. Wolff, K.; Larsen, S. Flux and permanence of risk perceptions: Tourists' perception of the relative and absolute risk for various destinations. *Scand. J. Psychol.* **2016**, *57*, 584–590. [CrossRef]
12. Gössling, S.; Scott, D.; Hall, C.M. Pandemics, tourism and global change: A rapid assessment of COVID-19. *J. Sustain. Tour.* **2020**, 1–20. [CrossRef]
13. Blešić, I.; Ivkov, M.; Tepavčević, J.; Popov Rajčić, J.; Petrović, M.D.; Gajić, T.; Tretiakova, T.N.; Syromiatnikova, J.A.; Demirović Bajrami, D.; Aleksić, M.; et al. Risky Travel? Subjective vs. Objective Perceived Risks in Travel Behaviour—Influence of Hydro-Meteorological Hazards in South-Eastern Europe on Serbian Tourists. *Atmos* **2022**, *13*, 1671. [CrossRef]
14. Yanga, Y.; Zhang, H.; Chen, X. Coronavirus pandemic and tourism: Dynamic stochastic general equilibrium modelling of infectious disease outbreak. *Ann. Tour. Res.* **2020**, *83*, 102913. [CrossRef] [PubMed]
15. Perpiña, L.; Prats, L.; Campubí, R. Image and risk perceptions: An integrated approach. *Curr. Issues Tour.* **2020**, 1–18. [CrossRef]
16. Rokni, L. The Psychological Consequences of COVID-19 Pandemic in Tourism Sector: A Systematic Review. *Iran J. Public Health* **2021**, *50*, 743–1756. [CrossRef] [PubMed]
17. Chang, C.L.; McAleer, M.; Ramos, V. The future of tourism in the COVID-19 era. *Adv. Decis. Sci.* **2020**, *24*, 218–230. [CrossRef]
18. Novelli, M.; Burgess, L.G.; Jones, A.; Ritchie, B.W. No Ebola . . . still doomed'—The Ebola induced tourism crisis. *Ann. Tour. Res.* **2018**, *70*, 76–87. [CrossRef] [PubMed]
19. Monaco, S. *Tourism, Safety and COVID-19: Security, Digitization and Tourist Behaviour*; Taylor & Francis: Oxfordshire, UK; Routledge: New York, NY, USA, 2022.
20. Cori, L.; Bianchi, F.; Cadum, E.; Anthonj, C. Risk perception and COVID-19. *Int. J. Environ. Res. Public Health* **2020**, *17*, 3114. [CrossRef]
21. Zorlu, K.; Tuncer, M.; Taşkın, G.A. The effect of COVID-19 on tourists' attitudes and travel intentions: An empirical study on camping/glamping tourism in Turkey during COVID-19. *J. Hosp. Tour. Insights* **2022**. *ahead-of-print*. [CrossRef]
22. Dryhurst, S.; Schneider, C.R.; Kerr, J.; Freeman, A.L.J.; Recchia, G.; Van der Bles, A.M.; Spiegelhalter, D.; van der Linden, S. Risk perceptions of COVID-19 around the world. *J. Risk Res.* **2020**, 1–13. [CrossRef]
23. Haywood, K.M. A Post-COVID Future: Tourism Community Re-Imagined and Enabled. *Tour. Geogr.* **2020**, *22*, 599–609. [CrossRef]
24. Zenker, S.; Braun, E.; Gyimóthy, S. Too afraid to Travel? Development of a pandemic (COVID-19) anxiety travel scale (PATS). *Tour. Manag.* **2021**, *84*, 1042–1086. [CrossRef]
25. Bae, S.Y.; Chang, P.J. The effect of coronavirus disease-19 (COVID-19) risk perception on behavioural intention towards 'untact' tourism in South Korea during the first wave of the pandemic. *Curr. Issues Tour.* **2020**, 1–19. [CrossRef]
26. Stone, R.N.; Grønhaug, K. Perceived risk: Further considerations for the marketing discipline. *Eur. J. Mark.* **1993**, *27*, 39–50. [CrossRef]
27. Richter, L.K. International tourism and its global public health consequences. *J. Travel Res.* **2003**, *41*, 340–347. [CrossRef]
28. Seabra, C.; Dolnicar, S.; Abrantes, J.L.; Kastenholz, E. Heterogeneity in risk and safety perceptions of international tourists. *Tour. Manag.* **2013**, *36*, 502–510. [CrossRef]
29. Boshoff, C. Service advertising: An exploratory study of risk perceptions. *J. Serv. Res.* **2002**, *4*, 290–298. [CrossRef]
30. O'Connor, P.; Assaker, G. COVID-19's effects on future pro-environmental traveler behavior: An empirical examination using norm activation, economic sacrifices, and risk perception theories. *J. Sustain. Tour.* **2022**, *30*, 89–107. [CrossRef]
31. Floyd, M.F.; Gibson, H.; Pennington-Gray, L.; Thapa, B. The effect of risk perceptions on intentions to travel in the aftermath of 11 September 2001. *J. Travel Tour. Mark.* **2004**, *15*, 19–38. [CrossRef]
32. Boksberger, P.E.; Bieger, T.; Laesser, C. Multidimensional analysis of perceived risk in commercial air travel. *J. Air Transp. Manag.* **2007**, *13*, 90–96. [CrossRef]
33. Woosnam, K.M.; Russell, Z.; Ribeiro, M.A.; Denley, T.J.; Rojas, C.; Hadjidakis, E.; Barr, J.; Mowe, J. Residents' pro-tourism behaviour in a time of COVID-19. *J. Sustain. Tour.* **2022**, *30*, 1858–1877. [CrossRef]
34. Abdulkareem, A.G.; Qader, D.J.; Ismael, N.H.; Othman, G. Impact of Quarantine Time in COVID-19 Pandemic Lockdown on Parents and their Children. *J. Zankoy Sulaimani* **2021**, *23*, 1–10. [CrossRef]

35. Brida, J.G.; Mogni, V.; Scaglione, M.; Seijas, M.N. Travel risk perceptions and behavior in the course of the COVID-19 pandemic: A cluster analysis. *J. Policy Res. Tour. Leis. Events* **2022**, 2–15. [CrossRef]
36. Gozgor, G.; Lau, M.C.K.; Zeng, Y.; Yan, C.; Lin, Z. The impact of geopolitical risks on tourism supply in developing economies: The moderating role of social globalization. *J. Travel Res.* **2022**, *61*, 872–886. [CrossRef]
37. Pappas, N.; Farmaki, A. Attributes attitudes and chaotic travel intentions during COVID-19. *Curr. Issues Tour.* **2022**, 1–17. [CrossRef]
38. De Rooij, P.; Liempt, A.V.; Bendegom, C.V. Should we stay, or should we go? The influence of risk perceptions on revisit intentions to cultural heritage during the COVID-19 pandemic. *J. Herit. Tour.* **2022**, *17*, 431–447. [CrossRef]
39. Qi, C.X.; Gibson, H.J.; Zhang, J.J. Perceptions of Risk and Travel Intentions: The Case of China and the Beijing Olympic Games. *J. Sport Tour.* **2009**, *14*, 43–67. [CrossRef]
40. Chi, C.G.; Ekinci, Z.; Ramkissoon, H.; Thorpe, A. Evolving effects of COVID-19 safety precaution expectations, risk avoidance, and socio-demographics factors on customer hesitation toward patronizing restaurants and hotels. *J. Hosp. Mark. Manag.* **2022**, *31*, 396–412. [CrossRef]
41. Kozak, M.; Kozak John, C.M.; Law, C.R. The Impact of the Perception of Risk on International Travellers. *Int. J. Tour. Res.* **2007**, *9*, 233–242. [CrossRef]
42. Perić, G.; Dramićanin, S.; Conić, M. The impact of Serbian tourists' risk perception on their travel intentions during the COVID-19 pandemic. *Eur. J. Tour. Res.* **2021**, *27*, 2705. [CrossRef]
43. Neuburger, L.; Egge, R. Travel risk perception and travel behaviour during the COVID-19 pandemic 2020: A case study of the DACH region. *Curr. Issues Tour.* **2021**, *24*, 1003–1016. [CrossRef]
44. Yue, M.; Asif, K.; Sughra, B.; Haoyue, W.; Yao, L.; Wenkuan, C. The Effects of COVID-19 Risk Perception on Travel Intention: Evidence From Chinese Travelers. *Front. Psychol.* **2021**, *12*, 2–15. [CrossRef]
45. Lepp, A.; Gibson, H. Sensation seeking and tourism: Tourist role, perception of risk and destination choice. *Tour. Manag.* **2008**, *29*, 740–750. [CrossRef]
46. Alkier, R.; Perić, S.; Dramićanin, S. Travel Risk Perception in a Health Crisis Caused by the COVID-19 Virus: The Case of Serbia. *Cent. Eur. Bus. Rev.* **2022**, *11*, 1–22. [CrossRef]
47. Brewer, N.T.; Weinstein, N.D.; Cuite, C.L.; Herrington, J.E. Risk perceptions and their relation to risk behavior. *Ann. Behav. Med.* **2004**, *27*, 125–130. [CrossRef]
48. Yang, C.L.; Nair, V. Risk Perception Study in Tourism: Are we Really Measuring Perceived Risk. *Procedia-Soc. Behav. Sci.* **2014**, *144*, 322–327. [CrossRef]
49. Chinazzi, M.; Davis, J.T.; Ajelli, M.; Gioannini, C.; Litvinova, M.; Merler, S. The effect of travel restrictions on the spread of the 2019 novel coronavirus (COVID-19) outbreak. *Science* **2020**, *368*, 395–400. [CrossRef]
50. Tsaur, S.H.; Tzeng, G.H.; Wang, K.C. Evaluating tourist risks from fuzzy perspectives. *Ann. Tour. Res.* **1998**, *24*, 796–812. [CrossRef]
51. Korinth, B. Impact of the COVID-19 Pandemic on International Tourism Income in Tourism Receiving Countries. *Sustainability* **2022**, *14*, 12550. [CrossRef]
52. Rahman, M.K.; Gazi, M.A.I.; Bhuiyan, M.A.; Rahaman, M.A. Effect of COVID-19 pandemic on tourist travel risk and management perceptions. *PLoS ONE* **2021**, *16*, e0256486. [CrossRef]
53. Vuković, D.B.; Zobov, A.M.; Degtereva, E.A. The Nexus Between Tourism and Regional Real Growth: Dynamic Panel Threshold Testing. *J. Geogr. Inst. "Jovan Cvijić" SASA* **2022**, *71*, 111–116. [CrossRef]
54. Elizabeth, A.; Adam, I.; Dayour, F.; Badu Baiden, F. Perceived impacts of COVID-19 on risk perceptions, emotions, and travel intentions: Evidence from Macau higher educational institutions. *Tour. Recreat. Res.* **2021**, *46*, 1–17. [CrossRef]
55. Matiza, T. Post-COVID-19 crisis travel behaviour: Towards mitigating the effects of perceived risk. *J. Tour. Futur.* **2022**, *8*, 99–108. [CrossRef]
56. Reisinger, Y.; Mavondo, F. Travel anxiety and intentions to travel internationally: Implications of travel risk perception. *J. Travel Res.* **2005**, *43*, 212–225. [CrossRef]
57. Carballo, R.R.; León, C.J.; Carballo, M.M. The perception of risk by international travellers. *Worldw. Hosp. Tour.* **2017**, *9*, 534–542. [CrossRef]
58. Karl, M.; Schmude, J. Understanding the role of risk (perception) in destination choice: A literature review and synthesis. *Tourism* **2017**, *65*, 138–155. [CrossRef]
59. Baugut, P.; Scherr, S. The news expectation predicament: Comparing and explaining what audiences expect from the roles and reporting practices of reporters on right-wing extremism. *Journalism* **2021**, *23*, 973–991. [CrossRef]
60. Breckenridge, J.N.; Zimbardo, P.G.; Sweeton, J.L. After years of media coverage, can one more video report trigger heuristic judgements? A national study of American terrorism risk perceptions. *Behav. Sci. Terror. Political Aggress.* **2010**, *2*, 163–178. [CrossRef]
61. Rather, R.A. Monitoring the impacts of tourism-based social media, risk perception and fear on tourist's attitude and revisiting behaviour in the wake of COVID-19 pandemic. *Curr. Issues Tour.* **2021**, *24*, 3275–3283. [CrossRef]
62. Wahlberg, A.A.; Sjöberg, L. Risk perception and the media. *J. Risk Res.* **2000**, *31*, 31–50. [CrossRef]
63. Liu, X.; Mehraliyev, F.; Liu, C.; Schuckert, M. The roles of social media in tourists' choices of travel components. *Tour. Stud.* **2019**, *20819*, 27–40. [CrossRef]

64. Sönmez, S.F.; Graefe, A. RDetermining future travel behavior from past travel experience and perceptions of risk and safety. *J. Travel Res.* **1998**, *37*, 171–177. [CrossRef]
65. Carballo, R.R.; León, C.J.; Carballo, M.M. Gender as moderator of the influence of tourists' risk perception on destination image and visit intentions. *Tour. Rev.* **2022**, *77*, 913–924. [CrossRef]
66. Yang, E.C.L.; Khoo-Lattimore, C.; Arcodia, C. A systematic literature review of risk and gender research in tourism. *Tour. Manag.* **2017**, *58*, 89–100. [CrossRef]
67. Zhang, K.Z.; Cheung, C.M.; Lee, M.K. Examining the moderating effect of inconsistent reviews and its gender differences on consumers' online shopping decision. *Int. J. Inf. Manag.* **2014**, *34*, 89–98. [CrossRef]
68. Wen, J.; Kozak, M.; Yang, S.; Liu, F. COVID-19: Potential effects on Chinese citizens' lifestyle and travel. *Tour. Rev.* **2020**, *76*, 74–87. [CrossRef]
69. Godovykh, M.; Pizam, A.; Bahja, F. Antecedents and outcomes of health risk perceptions in tourism, following the COVID-19 pandemic. *Tour. Rev.* **2021**, *76*, 737–748. [CrossRef]
70. Gao, X.; Cohen, S.; Hanna, P. Hitchhiking travel in China: Gender, agency and vulnerability. *Ann. Tour. Res.* **2020**, *84*, 103002. [CrossRef]
71. Reisinger, Y.; Crotts, J.C. The influence of gender on travel risk perceptions, safety, and travel intentions. *Tour. Anal.* **2009**, *16*, 793–807. [CrossRef]
72. Wang, L.; Wong, P.P.W.; Zhang, Q. Travellers' destination choice among university students in China amid COVID-19: Extending the theory of planned behaviour. *Tour. Rev.* **2021**, *76*, 749–763. [CrossRef]
73. Roehl, W.S.; Fesenmaier, D.R. Risk perceptions and pleasure travel: An exploratory analysis. *J. Travel Res.* **1992**, *30*, 17–26. [CrossRef]
74. Quan, L.; Al-Ansi, A.; Han, H. Assessing customer financial risk perception and attitude in the hotel industry: Exploring the role of protective measures against COVID-19. *Int. J. Hosp. Manag.* **2022**, *101*, 103123. [CrossRef]
75. Maignan, I.; Lukas, B.A. The nature and social uses of the Internet: A qualitative investigation. *J. Consum. Aff.* **1997**, *31*, 346–371. [CrossRef]
76. Faul, F.; Erdfelder, E.; Buchner, A.; Lang, A.-G. Statistical power analyses using G\*Power 3.1: Tests for correlation and regression analyses. *Behav. Res. Methods* **2009**, *41*, 1149–1160. [CrossRef] [PubMed]
77. Tabachnick, B.G.; Fidell, L.S. *Using Multivariate Statistics*, 6th ed.; Pearson: Boston, MA, USA, 2013; Available online: [https://www.scirp.org/\(S\(351jmbntvnsjt1aadkposzje\)\)/reference/ReferencesPapers.aspx?ReferenceID=1541229](https://www.scirp.org/(S(351jmbntvnsjt1aadkposzje))/reference/ReferencesPapers.aspx?ReferenceID=1541229) (accessed on 14 October 2022).
78. Myers, J.H.; Mullet, G.M. *Managerial Applications of Multivariate Analysis in Marketing*. Chicago; American Marketing Association: Chicago, IL, USA, 2003; Available online: <https://wild.on.worldcat.org/oclc/49921948> (accessed on 14 October 2022).
79. Horn, J.L. A rationale and test for the number of factors in factor analysis. *Psychometrika* **1965**, *30*, 179–185. [CrossRef] [PubMed]
80. Elazar, J.P. *Multiple Regression in Behavioral Research: Explanation and Prediction*, 2nd ed.; Holt, Rinehart and Winston: New York, NY, USA, 1982; Available online: <https://www.worldcat.org/title/multiple-regression-in-behavioral-research-explanation-and-prediction/oclc/8110048> (accessed on 14 October 2022).
81. BLIC, Business. 2022. Available online: <https://www.blic.rs/biznis/privreda-i-finansije/kineska-ekonomija-usporava-ovih-5-problema-koci-rast-druge-najvece-ekonomije-na-svetu/ym3> (accessed on 20 August 2022).
82. Aljazeera. TEME. 2022. Available online: <https://balkans.aljazeera.net/teme/2021/8/16/u-kini-nultog-kovida-paranoja-cvjeta-dok-turizam-slabi> (accessed on 20 August 2022).
83. Republic of Serbia. Ministry of Foreign Affairs. Available online: <https://www.mfa.gov.rs/en/citizens/travel-abroad/covid-19-travel-requirements> (accessed on 20 August 2022).
84. Press, S.J.; Wilson, S. Choosing Between Logistic Regression and Discriminant Analysis. *J. Am. Stat. Assoc.* **1978**, *73*, 699–705. Available online: <https://www.tandfonline.com/doi/abs/10.1080/01621459.1978.10480080> (accessed on 14 October 2022). [CrossRef]
85. McKay, R.J.; Campbell, N.A. Variable selection techniques in discriminant analysis I. Description. *Br. J. Math. Stat. Psychol.* **1982**, *35*, 1–29. [CrossRef]
86. McCullagh, P. Regression Models for Ordinal Data. *J. R. Stat. Society. Ser. B* **1980**, *42*, 109–142. Available online: <https://www.jstor.org/stable/2984952> (accessed on 14 October 2022). [CrossRef]
87. Rittichainuwat, B.; Chakraborty, G. Perceived travel risks regarding terrorism and disease: The case of Thailand. *Tour. Manag.* **2009**, *30*, 410–418. [CrossRef]
88. Law, R. The perceived impact of risks on travel decisions. *Int. J. Tour. Res.* **2006**, *8*, 289–300. [CrossRef]
89. Fuchs, G.; Reichel, A. Tourist destination risk perception: The case of Israel. *J. Hosp. Leis. Mark.* **2006**, *14*, 83–108. [CrossRef]
90. Giusti, G.; Raya, J.M. The effect of crime perception and information format on tourists' willingness/intention to travel. *J. Destin. Mark. Manag.* **2019**, *11*, 101–107. [CrossRef]
91. Joffe, H. Risk: From perception to social representation. *Br. J. Soc. Psychol.* **2003**, *42*, 55–73. [CrossRef] [PubMed]
92. Chew, E.Y.T.; Jahari, S.A. Destination image as a mediator between perceived risks and revisit intention: A case of post-disaster Japan. *Tour. Manag.* **2014**, *40*, 382–393. [CrossRef]
93. Kvítková, Z.; Petřů, Y.; Zíková, A. Domestic Tourism, its Potential to Compensate the Outage of International Arrivals Caused by COVID-19 and the Vulnerability of Different Groups of Countries. *Rev. Castell. Manch. Cienc. Soc.* **2021**, *30*, 99–114. [CrossRef]

94. Nicola, M.; Alsafi, Z.; Sohrabi, C.; Kerwan, A.; Al-Jabir, A.; Iosifidis, C.; Agha, M.; Agha, R. The socio-economic implications of the coronavirus and COVID-19 pandemic: A review. *Int. J. Surg.* **2020**, *78*, 168–179. [CrossRef]
95. Rodríguez-Morales, A.J.; MacGregor, K.; Kanagarajah, S.; Patel, D.; Schlagenhaut, P. Going global-travel and the 2019 novel coronavirus. *Travel Med. Infect. Dis.* **2020**, *33*, 101578. [CrossRef]
96. Yang, E.C.L.; Sharif, S.P.; Khoo-Lattimore, C. Tourists' risk perception of risky destinations: The case of Sabah's eastern coast. *Tour. Hosp. Res.* **2015**, *15*, 206–221. [CrossRef]
97. Aliperti, G.; Cruz, A.M. Investigating tourists' risk information processing. *Ann. Tour. Res.* **2019**, *79*, 102803. [CrossRef]
98. Ilies, A.; Hurley, P.D.; Ilies, D.C.; Baias, S. Tourist animation—A chance adding value to traditional heritage: Case study's in the Land of Maramures (Romania). *Rev. Etnogr. Şi Folc. J. Ethnogr. Folk.* **2017**, *1–2*, 131–151. Available online: <https://rcin.org.pl/igipz/dlibra/metadatasearch?action=AdvancedSearchAction&type=3&val1=References:%22Ilie%C5%9F+A.%2C+Hurley+P.D.%2> (accessed on 20 July 2022).
99. Aldao, C.; Blasco, D.; Espallargas, M.P. Lessons from COVID-19 for the future: Destination crisis management, tourist behaviour and tourism industry trends. *J. Tour. Futures* **2022**, 1–15. [CrossRef]

## Article

# Crisis Management in Restaurants: The Case of Polish Restaurants during the COVID-19 Pandemic

Marek Nowacki <sup>1,\*</sup>  and Marianna Nurkowska <sup>2</sup><sup>1</sup> Department of Finance and Banking, WSB University in Poznań, 61-895 Poznań, Poland<sup>2</sup> Independent Researcher, 61-001 Poznań, Poland

\* Correspondence: marek.nowacki@wsb.poznan.pl

**Abstract:** The article aims to identify effective actions taken by the catering industry as part of crisis management during the COVID-19 pandemic. The time scope of the research concerns the first wave of the COVID-19 pandemic in the period from 13 March to 18 May 2020. The research method used in the study was a questionnaire survey (CAWI). The survey results showed that the most frequent action taken by restaurants was applying for government assistance. On the other hand, most marketing activities were related to the assessment of the situation and the prospects for restaurants. Relationships were also found between restaurant management activities and restaurant characteristics (number of employees, number of years of operation and location). The developed research tool can help in assessing effective actions taken by restaurant managers during a crisis.

**Keywords:** crisis management; COVID-19 epidemic; catering industry; restaurants



**Citation:** Nowacki, M.; Nurkowska, M. Crisis Management in Restaurants: The Case of Polish Restaurants during the COVID-19 Pandemic. *Sustainability* **2022**, *14*, 14631. <https://doi.org/10.3390/su142114631>

Academic Editors: Zygmunt Kruczek and Bartłomiej Walas

Received: 20 September 2022

Accepted: 1 November 2022

Published: 7 November 2022

**Publisher's Note:** MDPI stays neutral with regard to jurisdictional claims in published maps and institutional affiliations.



**Copyright:** © 2022 by the authors. Licensee MDPI, Basel, Switzerland. This article is an open access article distributed under the terms and conditions of the Creative Commons Attribution (CC BY) license (<https://creativecommons.org/licenses/by/4.0/>).

## 1. Introduction

Crises have become an everyday reality in the modern world. The most important in the 21st century have been the attack of 11 September 2001 on the World Trade Center, the Bali attacks, the SARS epidemic in 2002–2004, the Arab Spring 2010–2012, the global financial crisis in 2007–2009, and even the influenza A/H1N1 pandemic in the years 2009–2010, which caused the death of 284,000 people around the world [1]. One can claim that at any given moment, somewhere in the world, we are dealing with some crisis.

Such crises have a very strong impact on the world economy, especially on the hospitality and tourism sector. The COVID-19 pandemic and related restrictions had a very strong impact on the hospitality and restaurant industry, threatening to close many of them and cause millions of employees around the world to lose their jobs [2–5]. The global tourism economy lost \$1.3 trillion in revenue in 2020 as a result of the pandemic, and 100–120 million jobs in tourism [6] were at risk.

According to a GFK report, during the pandemic in Poland, the restaurant industry saw a huge decrease in sales and in the number of catering establishments [7]. Compared to 2019, in 2021 the market value dropped to PLN 28.5 billion, i.e., by over 22 per cent. Over these two years, the number of establishments shrunk, in turn, by almost 10,000, down to 63,000. In terms of the number of establishments, the pandemic returned the market to 2009 levels.

Many authors emphasize the importance of developing a survival strategy for the restaurant sector [8,9], which has been severely affected by the COVID-19 pandemic [10]. It is also very important to identify the factors governing the resilience of hospitality firms and restaurants in the face of the crisis [11–13], as well as a financial recovery strategy [14] and innovation in terms of food ordering and delivery platforms [15].

Previous studies on the impact of the pandemic on the functioning of restaurants have focused on the qualitative identification of crisis management procedures [16,17], the prospects for the use of artificial intelligence in future crises [18], quantitative identification

of actions in a crisis [19] or qualitative identification of factors influencing the survival of restaurants during a crisis [20,21]. Neise et al. [13] identified the factors governing the resilience of restaurants, which included economic and financial performance, tangible and intangible assets, short-term response, and experience of the manager. The short-term response activities included only delivery and takeaway services, the coronavirus relief program and short-term assistance.

The authors of this article did not find any articles in which other authors identified effective actions in the field of restaurant management in the face of a crisis, especially a pandemic. Therefore, it is extremely important to identify the factors and practices that will help entrepreneurs to survive periods of crisis. There are no quantitative tools for diagnosing effective management strategies for tourism enterprises (especially restaurants) in times of crisis. There are also no tools for the quantitative identification of effective actions undertaken during a crisis in the gastronomy industry.

Hence, the purpose of this article is to identify effective actions taken by the gastronomy industry as part of crisis management during the COVID-19 pandemic. The following research question was therefore posed: What restaurant activities are effective during a crisis caused by an epidemic?

## 2. Literature Review

### 2.1. Restaurant Management in a Crisis

As mentioned in the introduction, crises affecting restaurants can be of various types, as discussed by Tse et al. [16], who divided them into external factors (physical environment—e.g., natural disaster or technological failure, and human or social environment—e.g., confrontation or malevolence) and internal factors (e.g., management failure). Each of these types of crisis requires different restaurant crisis management. For restaurant management in the crisis during the SARS outbreak in Hong Kong, Tse et al. [16] proposed the following actions: cost reduction, revenue enhancement (change of marketing mix and decrease in perceived physical risk).

Various authors have compiled lists of actions that are desirable during a crisis. For example, Israeli and Reichel [22] created a list of practices for hotels in Israel, and Okumus and Karamustafa [23] in Turkey. Aviad A. Israeli [19] identified a list of crisis management practices for the restaurant industry, categorizing them into human resources, marketing, maintenance and government assistance. He stated that government support is important, and that improved competitiveness and cost-cutting activities are crucial. Israeli [19] writes that when identifying practices used in the crisis management of restaurants, two dimensions should be taken into account: the importance of the measures, and the usage of these measures. Therefore, when constructing a questionnaire to measure crisis management practices in the restaurant industry, he examined the importance of the usage of each practice separately. However, Israeli [18] contented himself with constructing a questionnaire, but did not investigate the effect of any of these practices on resilience or the state of restoration.

Several articles on restaurant management during the COVID-19 pandemic were recently published. The authors identify activities in the field of restaurant management during the pandemic. A. Motoc [24] analysed the role of a leader in crisis management and resilience for restaurants in Romania. The author stated that strong qualities of an attentive, communicative, flexible and motivating leader, a decentralized culture, commitment among employees, and a creative culture in a restaurant all go together to determine the degree of integration of crisis management and strategic planning. A. Gkoumas [25] identified seven factors for restaurant viability during the COVID-19 pandemic in Taiwan. Three of them, that is the cultural context, social cohesion and the cooperation of restaurant professionals, are essential to the effectiveness of any strategy for containing the coronavirus.

N. Messabia et al. [21] found that Canadian small- and medium-sized enterprises (SMEs) suffered during the pandemic from stress, shortage of employees, financial losses, liquidity problems, closures, reopening and difficulties with adapting to change. To over-

come this crisis, entrepreneurs had to demonstrate resilience, innovation and strategic management. The support of Canadian federal programs helped them a great deal. Messabia et al. [21] proposed a six-element model of restaurant management in a crisis, which consists of entrepreneurial experience, federal government funding, sound financial management, innovation in diverse service offerings, the strategic management of human resources, and the support of family members.

A.M. Elshaer [26] examined the response of Egyptian restaurants to COVID-19. The author successfully documents the decisions and activities related to four aspects: leadership practices, managing stakeholders' cooperation, operational procedures and marketing reputation. Neise et al. [13] identified the factors important for resilience in German restaurants. They concluded that ex ante business problems and financing by loans or credit reduce the likelihood of owners perceiving their businesses as resilient, whereas delivery and takeaway services, ownership of property and the higher age of the owners increase the likelihood of enterprise resilience.

Restaurant adaptation strategies in Malaysia were studied by Lai et al. [27]. Three prominent areas of adaptations made by decision-makers were identified based on continuous news reports and media content. Commonly made adaptations involve actions to (i) nurture creativity, (ii) sustain reputation, and (iii) maintain profitability. In addition, F. Alkasbeh [18] reviewed the literature in the field of food advertising on social media in the context of the impact of COVID-19 on restaurant marketing and management practices. He identified two areas of such activities: artificial intelligence and digital media ads and the importance of social media ads during COVID-19.

Other studies analyzed the impact of the COVID-19 pandemic on the condition of restaurants [4], the early effects of the pandemic and accompanying stay-at-home orders on restaurant demand [28], and consumers' perceptions of risk about restaurant food and its packaging [29].

## 2.2. The COVID-19 Pandemic in Restaurants in Poland

The first cases of COVID-19 in Poland were observed in mid-March 2020. As the disease spread very quickly, on 12 March 2020, an epidemic was announced in Poland resulting in limitations on movement and the closure of most service industries. Numerous restrictions were imposed on citizens, including the obligation to wear masks when leaving the house, and hours for seniors in stores from 10.00 to 12.00 from Monday to Friday. This resulted in a limitation of movement and the closing of most service industries. Mass events, weddings and concerts were completely cancelled, and parks, green areas and even forests were closed.

In connection with the announcement of the epidemiological threat on 12 March 2020, from 13 March 2020 the activities of gastronomic establishments were banned. This decision remained in force until 18 May 2020. At that time, the gastronomy industry could only sell take-out dishes or delivery, without hosting customers [30].

From 18 May 2020, gastronomy establishments were re-opened for customers, but under some restrictions. A limit was in place for the number of people on the premises (1 person per 4 m<sup>2</sup>) and the disinfection of tables after each client was introduced. It was compulsory to maintain a distance between the tables, a minimum of 2 m, and a distance of 1.5 m between guests sitting at separate tables. Waiters were ordered to serve customers in masks and gloves. Only families or people from one household could sit at one table. Otherwise, only individuals were allowed to sit at the tables [30].

In the second half of March 2020, 68% of companies and gastronomic establishments completely suspended their activity, while 32% were open and operated in a limited way [31]. For the establishments to survive the first shutdown of the economy, actions were introduced to limit financial losses. During the first lockdown period, restaurants had to limit their activities to take-out sales and providing dishes by delivery. In the spring of 2020, the largest intermediary companies in the supply of food offered by restaurants were Glovo, Uber Eats, Pyszne.pl, Głodny.pl and Wolt. During Easter, restaurants offered the

possibility of ordering dishes and traditional sweets with home delivery or personal pickup in the form of catering [32].

Due to the prevailing COVID-19 pandemic and the deteriorating situation of Polish gastronomy at that time, many initiatives were created to support restaurants during their closure. The portal *wspieramgastro.pl* became popular, in which the following initiatives came to the help of restaurateurs: #safedoy— a campaign that aimed to promote a Code of Good Practice when transporting meals; #SmacznewSparta—an event organized by the HoReCA Employers Association, aimed at supporting gastronomic businesses; #wspieramzamaz—this is a nationwide campaign addressed to Polish restaurateurs and people who want to support their favourite places. To increase sales during the pandemic, restaurants began to promote dishes in jars. Chefs' sauces, soups, dishes and preserves were very popular, especially for people under quarantine [32].

### 3. Method

The research among restaurant managers was carried out using a survey questionnaire. The research was conducted from October 2020 to March 2021. Online questionnaires were sent to 123 randomly selected restaurants present on TripAdvisor. As a result, 51 completed questionnaires were obtained.

The questionnaire consisted of 20 statements regarding activities used by restaurants in crisis management during the first wave of the COVID-19 pandemic wave. The content of the questionnaire was developed based on the work of Aviad Israeli [19], with the statements divided into categories: human resources, marketing, maintenance and government assistance, which was modified and supplemented with additional items (Table 2). The statements were assessed on a five-level scale, from 1—"generally no" to 5—"very intensively". The respondents assessed the condition of the restaurant with three statements: "How do you assess the current situation of the restaurant compared to its functioning before the pandemic?" (1—"very bad" to 5—"very good"), "How do you assess the impact of the pandemic on the functioning of your restaurant?" (1—"very negative", 5—"very positive"), "How do you assess the prospects of the functioning of your restaurant in the next year?" (1—"very bad prospects", 5—"very good prospects") (Table 2).

The restaurants studied employed a varying number of staff: 11–15 employees (25.5%), 2 to 5 employees (11%), and one employee (19.6%) (Table 1). Most restaurants have been in operation for 11 to 35 years (31.4%), or from 3 to 5 years (29.4%). Most of the restaurants studied were located in the city centre (31.4%) and outside the city centre (23.5%). Only 5% of the restaurants were located out of the city.

**Table 1.** Research sample characteristics (N = 51).

Restaurant Feature	Number of Restaurants	% Restaurants
Number of employees		
1	10	19.6
2–5	11	21.6
6–10	8	15.7
11–15	13	25.5
16–34	9	17.6
Number of years of operation		
1–2	12	23.5
3–5	15	29.4
6–10	8	15.7
11–35	16	31.4



**Table 1.** *Cont.*

Restaurant Feature	Number of Restaurants	% Restaurants
Location		
In the very centre of the city	8	15.7
In the city centre	16	31.4
Outside the city centre	12	23.5
In the suburbs	10	19.6
Out of the city	5	9.8

Analysis of the relationship between the variables was performed using multiple regression analysis. The analysis of intergroup differences was performed using the non-parametric Kruskal-Wallis H test and the Mann-Whitney U test. All calculations were made with Statistica 13.0 software.

#### 4. Results

In the first stage of the analysis, the ranking of actions taken by restaurants in the initial period of the COVID-19 pandemic was calculated. The restaurants most often applied for exemption from ZUS (Zakład Ubezpieczeń Społecznych—The Social Insurance Institution) contributions, for government funding for salaried employees, for advertising in the media, applied for micro-loans and applied for deferrals in the payment of municipal taxes (Table 2). The list shows that four of the five most frequently undertaken actions belonged to the "Government assistance" group. In turn, at the end of the ranking were activities such as replacing high-tenure employees, increased reliance on outsourced human resources, reducing menu prices, cost cutting by using less expensive substitutes, and price drops with special offers. These actions mainly belong to the human resources and marketing groups.

In addition, Table 2 presents the opinions of restaurant managers regarding the assessment of the condition and prospects for the operation of their restaurants during the pandemic and one year in the future. The managers assessed the current situation of the restaurant as slightly below average ( $M = 2.37$ ), and the operating prospects for the following year as slightly above average ( $M = 2.76$ ), with a standard deviation close to 1. This proves an average assessment of the restaurant's condition as neither positive nor negative in the first period of the pandemic. Only the impact of the pandemic on the condition of the restaurant was assessed as "quite negative" ( $M = 1.74$ ;  $SD = 1.05$ ).

**Table 2.** Ranking of activities undertaken by restaurants during the COVID-19 pandemic.

Items	Rank	M	SD
<i>Human resources</i>			
Reducing the labour force by laying off employees or by unpaid vacation	14	2.19	0.99
Reducing the number of working days per week	15	2.00	1.10
Reducing the pay rate	12	2.23	0.95
Replacing high-tenure employees with new employees	20	1.43	0.79
Increased reliance on outsourced human resources	19	1.67	0.90

Table 2. Cont.

Items	Rank	M	SD
<i>Marketing</i>			
Joint marketing campaigns with other traders (e.g., pyszne.pl, ubereats.pl or other restaurants)	11	2.30	1.06
Advertising in the media (e.g., social media)	3	2.98	0.92
Price drops with special offers	16	1.82	0.94
Reducing menu prices	18	1.67	0.87
Introducing new services (catering, delivery, etc.)	7	2.72	1.18
Adding a business menu or changing the business menu offerings	13	2.22	1.11
Change of restaurant operating hours	10	2.40	0.99
<i>Maintenance</i>			
Cost cutting by postponing systems maintenance	9	2.42	1.79
Cost cutting by using less expensive substitutes in the kitchen	17	1.82	0.99
Extending credit or postponing scheduled payments	6	2.76	1.02
<i>Government assistance</i>			
Applying for a microloan of 5000 PLN for companies with up to 10 employees to cover current expenses *	4	2.92	1.16
Applying for exemption from ZUS contributions for 3 months *	1	3.18	0.87
Applying for government funding for salaried employees (so-called ‘parking’) *	2	3.00	1.07
Applying for deferrals in the payment of municipal taxes (delay in repayment of rent, utility costs) *	5	2.91	1.01
Communicating “business as usual”	8	2.64	1.08
<i>Assessment of the situation and prospects of the restaurant</i>			
How do you assess the current situation of the restaurant compared to its functioning before the pandemic? *	-	2.37	1.15
How do you assess the impact of the pandemic on the functioning of your restaurant? *	-	1.73	1.08
How do you evaluate the prospects for the operation of your restaurant in the next year? *	-	2.76	1.05

Notes: \*—additional items proposed by the authors of this article.

In the next step, a regression analysis was performed where the dependent variable was the assessment of the state and prospects of the restaurants during the COVID-19 pandemic, and the independent variables were the actions taken by restaurants during the pandemic. Most relationships—as many as six—were found for the group of “Marketing” activities: “Joint marketing campaigns with other traders” has a positive relationship with both “Assessing the impact on restaurants” and “Evaluating the prospects of restaurants”. “Reducing menu price” has a positive relationship with “Comparing the restaurant with before the pandemic” and “Adding a business menu” or “Changing the business menu offerings” has a positive relationship with “Evaluating the prospects of the restaurant” (Table 3). Interestingly, “Introducing new services” has a negative relationship with “Assessing the impact on restaurants” and “Evaluating the prospects of restaurants”. This may result from the fact that such activities were taken by restaurants that were very strongly affected by the pandemic, who negatively perceived the prospects of functioning during the pandemic. This perception of the economic reality influenced the intensification of activities in the development of new services, especially catering and delivery of dishes to customers.

In the next group-Human resources-three relationships were found. “Replacing high-tenure employees with new employees” is related to “Comparing the restaurant before the pandemic” and “Evaluating the prospects of restaurants”. This is a negative relationship,

which means that restaurants perceiving the pandemic impact strongly and evaluating the prospects very negatively reduced high-tenure staff by replacing them with new employees.

In the next group of activities, Maintenance, two inverse relationships were found between “Cost cutting by using less expensive substitutes”, “Comparing before the pandemic” and “Evaluating the prospects of restaurants”. In the last group of measures—Government assistance—one relationship was found between “Applying for a micro-loan” and “Assessing the impact on restaurants”. This means that restaurants which saw the strong impact of the pandemic sought government support in the form of a micro-loan.

**Table 3.** Regression analysis results: actions vs. assessment of the situation and prospects of restaurants.

Items	Compared to before the Pandemic		Assessing the Impact on Restaurants		Evaluating the Prospects	
	beta	p	beta	p	beta	p
<i>Human resources</i>						
Reducing the labour force by laying off employees or by unpaid vacation	0.075	0.705	0.120	0.550	−0.148	0.409
Reducing the number of working days per week	0.482	0.100	0.287	0.328	<b>0.540</b>	<b>0.044</b>
Reducing the pay rate	−0.237	0.350	−0.365	0.160	−0.130	0.569
Replacing high-tenure employees with new employees	<b>−0.760</b>	<b>0.014</b>	−0.232	0.437	<b>−0.879</b>	<b>0.002</b>
Increased reliance on outsourced human resources	0.223	0.370	−0.084	0.739	0.384	0.093
<i>Marketing</i>						
Joint marketing campaigns with other traders	0.405	0.099	<b>0.552</b>	<b>0.030</b>	<b>0.573</b>	<b>0.012</b>
Advertising in the media	−0.199	0.338	−0.215	0.310	−0.315	0.099
Price drops with special offers	−0.174	0.466	−0.029	0.904	−0.133	0.536
Reducing menu prices	<b>0.729</b>	<b>0.008</b>	0.246	0.354	0.385	0.108
Introducing new services	−0.443	0.071	<b>−0.512</b>	<b>0.041</b>	<b>−0.842</b>	<b>0.000</b>
Adding a business menu or changing the business menu offerings	0.113	0.673	0.149	0.584	<b>0.533</b>	<b>0.034</b>
Change of restaurant operating hours	−0.086	0.647	−0.064	0.735	0.043	0.799
<i>Maintenance</i>						
Cost cutting by postponing systems maintenance	0.043	0.815	0.020	0.916	0.020	0.905
Cost cutting by using less expensive substitutes in the kitchen	<b>−0.608</b>	<b>0.013</b>	−0.477	0.052	<b>−0.594</b>	<b>0.008</b>
Extending credit or postponing scheduled payments	0.052	0.843	0.020	0.939	0.168	0.482
<i>Government assistance</i>						
Applying for a microloan of 5000 PLN for companies with up to 10 employees to cover current expenses	0.317	0.146	<b>0.479</b>	<b>0.034</b>	0.362	0.069
Applying for exemption from ZUS contributions for 3 months	0.076	0.742	−0.406	0.089	−0.028	0.893
Applying for government funding for salaried employees	−0.098	0.582	0.045	0.803	0.044	0.786
Applying for deferrals in the payment of municipal taxes	−0.086	0.680	−0.102	0.631	−0.216	0.257
Communicating “business as usual”	0.408	0.082	0.185	0.429	0.012	0.953
R <sup>2</sup>	0.466		0.448		0.563	

Note: significant relationships between the variables are highlighted in bold.

An analysis of the differences between the actions and perception of the impact of the pandemic and the features of the restaurant revealed only three significant differences (Table 4). First of all, statistically significant differences were found in “Reducing the number of working days per week”, depending on the number of restaurant employees. A detailed analysis showed that restaurants with 6 to 10 and 11 to 15 employees reduced the number of employees significantly less than others. The largest restaurants (from 16 to 34 employees) reduced the number of employees the most.

**Table 4.** The diversity of actions and perception of the impact of the pandemic depending on the features of the restaurant (Kruskal-Wallis H test).

Items	Number of Employees		Number of Years of Operation		Location	
	H	p	H	p	H	p
<i>Human resources</i>						
Reducing the labour force by laying off employees or by unpaid vacation	3.24	0.51	2.65	0.44	4.64	0.32
Reducing the number of working days per week	<b>13.11</b>	<b>0.01</b>	2.68	0.44	0.65	0.95
Reducing the pay rate	7.03	0.13	5.29	0.15	2.93	0.56
Replacing high-tenure employees with new employees	0.75	0.94	2.11	0.54	4.02	0.40
Increased reliance on outsourced human resources	2.11	0.71	3.81	0.28	5.61	0.22
<i>Marketing</i>						
Joint marketing campaigns with other traders	2.18	0.70	7.43	0.059	4.57	0.33
Advertising in the media	4.96	0.29	5.00	0.17	2.64	0.61
Price drops with special offers	1.16	0.88	0.44	0.93	5.63	0.22
Reducing menu prices	4.27	0.36	2.73	0.43	2.62	0.64
Introducing new services	0.82	0.93	5.19	0.15	8.69	0.06
Adding a business menu or changing the business menu offerings	6.91	0.14	5.09	0.16	<b>9.63</b>	<b>0.04</b>
Change of restaurant operating hours	6.32	0.17	3.74	0.29	3.27	0.51
<i>Maintenance</i>						
Cost cutting by postponing systems maintenance	1.20	0.87	2.51	0.47	3.15	0.53
Cost cutting by using less expensive substitutes in the kitchen	3.78	0.43	1.51	0.67	3.92	0.41
Extending credit or postponing scheduled payments	3.47	0.48	1.68	0.56	3.70	0.44
<i>Government assistance</i>						
Applying for a micro loan of 5000 PLN	7.56	0.10	4.88	0.18	6.16	0.18
Applying for exemption from ZUS contributions for a period of 3 months	5.43	0.24	1.48	0.68	0.45	0.97
Applying for government funding for salaried employees	5.48	0.24	0.72	0.86	5.78	0.21
Applying for deferrals in the payment of municipal taxes	0.59	0.96	1.38	0.71	3.34	0.51
Communicating “business as usual”	6.66	0.15	6.61	0.08	3.07	0.54
<i>Assessment of the situation and prospects of the restaurant</i>						
How do you assess the current situation of the restaurant compared to its functioning before the pandemic?	2.37	0.66	2.48	0.47	3.69	0.44
How do you assess the impact of the pandemic on the functioning of your restaurant?	<b>9.78</b>	<b>0.04</b>	0.42	0.93	4.95	0.29
How do you evaluate the prospects for the operation of your restaurant in the next year?	2.05	0.72	1.19	0.75	4.30	0.36

Notes: significant differences between groups are highlighted in bold.

Another difference was in “Adding a business menu” or “Changing the business menu offerings” depending on the location of the restaurant. Here, the most active in this action were restaurants located outside the centre, and the least active restaurants were located outside the city. The last difference was in “How do you assess the impact of the pandemic on the functioning of your restaurant?” depending on the number of restaurant employees. Here, the impact of the pandemic was most perceived by one-person restaurants and least by the biggest restaurants.

## 5. Discussion

In this study, an attempt has been made to answer the question: What restaurant activities are effective during a crisis caused by an epidemic? For this purpose, the activities undertaken by Polish restaurants during the COVID-19 pandemic were examined. Of all the activities taken, the most common was requesting government assistance. These are completely different activities than, for example, in Israel during periods of peace or periods of terrorist crisis (dominated by layoffs and cost-cutting) [19], or the SARS epidemic in Hong Kong, where mainly cost reduction and revenue management were used. This indicates the widespread availability of government support during the COVID-19 pandemic in Poland, while such support was not as strong during the other crises described by the above-mentioned authors. However, a study from Taiwan [25] showed that cultural context, social cohesion and the cooperation of restaurant professionals are essential to the effectiveness of any strategy for containing the coronavirus. Taiwanese culture, combined with the social cohesion between various groups, was a key factor in ensuring public security and business sustainability. Unfortunately, in Poland, society is much less disciplined and the way the crisis was managed by the PiS (Prawo i Sprawiedliwość—Law and Justice Party) government led to one of the highest numbers of deaths per capita in the world [33].

To identify effective activities in the field of restaurant management during the pandemic, a regression analysis was performed. Despite the greatest activity of restaurants being in the field of government assistance, the regression analysis showed that it is the marketing activities that are most closely related to the outlook for survival in the pandemic period. The wide range of these activities includes lowering prices, joint marketing campaigns with other restaurants, and introducing new services. Interestingly, unlike the activities described by F. Alkasasbeh [18] including food advertising on social media and artificial intelligence and digital media ads during COVID-19, the above research did not confirm the relationship of advertising activity on social media with the restaurants’ future prospects, although these were in third place in terms of popularity. Perhaps this is due to the limited time frame of the research, and because the effects of such marketing activities may not yet have been noticed by restaurant managers.

In the available literature on the subject, there is no data on the relationship between the size of the restaurant, the length of its operation and its resilience during the pandemic. The results of our study indicate that there are, however, a few relationships. Restaurants with 6 to 15 employees were the most resistant to employment reduction. The limited number of available tables in the restaurant was irrelevant. Large restaurants also proved to be the most resilient to the impact of the pandemic, as they had greater opportunities for marketing, maintenance and human resources management.

There were no differences in activities or in the assessment of the impact on the condition of the restaurant depending on the number of years of operation of the restaurant, as was also found by Headd [34], Parsa et al. [35] and Neise et al. [13]. This proves that it is not the number of years of operation that is important, but rather the state of the restaurant in the years preceding the pandemic, and, as stated by Neise et al. [13], the age of the manager also has a significant relationship to the resilience of the restaurant during the crisis.

Finally, restaurants located outside the city are in a much worse position than those in cities, as they have severely limited options for marketing activities. Other factors con-

tributing to the resilience of restaurants, in addition to those identified by Neise et al. [13], are ownership of property and the higher age of the owners.

## 6. Conclusions

### *Summary*

The COVID-19 pandemic has had a very strong impact on the tourism industry, especially on the gastronomy sector both in Poland and around the world. In the above article, we tried to identify the actions taken by Polish restaurants during the pandemic to assess their effectiveness. The most frequently undertaken activities by managers of Polish restaurants were those from the group applying for government support, as well as from the maintenance and marketing group. However, it is not the activities in the field of government assistance but rather those in marketing that are significantly related to the condition and prospects for the survival of restaurants during the pandemic. In addition, differentiation in activities depending on the size and location of restaurants was found: restaurants with an average number of employees (i.e., 6 to 15) lay off workers to a lesser extent, while the smallest restaurants felt the impact of the pandemic on business the most.

The developed questionnaire for assessing restaurant activities during the pandemic and the method of assessing the effectiveness of these activities may be used in other fields of the tourist industry and other fields of the national economy. As a result of the research, clear procedures of activities for restaurants to undertake should be created and recommended for during a crisis (not only a pandemic), as well as activities for local governments and the national government. The chaos that prevailed in this area during the pandemic in Poland caused the collapse of many restaurants and other tourist enterprises, and caused a huge increase in the number of infections and deaths.

## 7. Limitations and Future Research

This article provides insights into how selected Polish restaurants dealt with the first wave of the COVID-19 pandemic. However, this article has some limitations. This survey was carried out on a very small group of restaurants, which was caused by the reluctance of managers to participate in the survey. Further research should consider a significantly larger research sample.

Our research was carried out on a relatively small research sample, and the actual state of restaurants and their ability to survive during the pandemic were not verified. The study was limited to examining the subjective opinions of restaurant managers about this condition. Therefore, in further research, it would be necessary to include a larger group sample and correlate the collected data (i.e., actions taken by restaurants) with the actual state of the restaurant from a different time perspective.

Moreover, the dependent variable used was the subjective assessment of the current economic situation of the restaurant and its prospects made by managers. To increase the accuracy and reliability of the measurement, indicators of the restaurant's actual financial situation and business performance should be taken into account.

The above research focused on assessing a snapshot perception of the condition of restaurants. In subsequent studies, longitudinal studies should be carried out, i.e., it should be verified how the restaurants studied survived the crisis, and whether and in what economic condition they are functioning after the crisis. In addition, further research should take into account other variables that were not used in this study. These include manager characteristics (experience and age), restaurant characteristics (economic and financial performance before the crisis, ownership, financing, etc.) [13], as well as features of the business environment (restaurant operating conditions).

**Author Contributions:** Conceptualization, M.N. (Marek Nowacki) and M.N. (Marianna Nurkowska); methodology, M.N. (Marek Nowacki) and M.N. (Marianna Nurkowska); software, M.N. (Marek Nowacki); validation, M.N. (Marek Nowacki); formal analysis, M.N. (Marek Nowacki); investigation, M.N. (Marek Nowacki); writing—original draft preparation, M.N. (Marek Nowacki) and M.N.

(Marianna Nurkowska); writing—review and editing, M.N. (Marek Nowacki). All authors have read and agreed to the published version of the manuscript.

**Funding:** This research received no external funding.

**Institutional Review Board Statement:** Not applicable.

**Informed Consent Statement:** Not applicable.

**Conflicts of Interest:** The authors declare no conflict of interest.

## References

1. Pandemia grypy A/H1N1. 2022. Available online: [https://pl.wikipedia.org/wiki/Pandemia\\_grypy\\_A/H1N1](https://pl.wikipedia.org/wiki/Pandemia_grypy_A/H1N1) (accessed on 15 September 2022).
2. Karim, W.; Haque, A.; Anis, Z.; Ulfy, M.A. The movement control order (mco) for covid-19 crisis and its impact on tourism and hospitality sector in Malaysia. *Int. Tour. Hosp. J.* **2020**, *3*, 1–7.
3. Nicola, M.; Alsafi, Z.; Sohrabi, C.; Kerwan, A.; Al-Jabir, A.; Iosifidis, C.; Agha, M.; Agha, R. The socio-economic implications of the coronavirus and COVID-19 pandemic: A review. *Int. J. Surg.* **2020**, *78*, 185–193. [CrossRef] [PubMed]
4. Brizek, M.G.; Frash, R.E.; McLeod, B.M.; Patience, M.O. Independent restaurant operator perspectives in the wake of the COVID-19 pandemic. *Int. J. Hosp. Manag.* **2021**, *93*, 102766. [CrossRef] [PubMed]
5. Gossling, S.; Scott, D.; Hall, C.M. Pandemics, tourism and global change: A rapid assessment of COVID-19. *J. Sustain. Tour.* **2021**, *29*, 1–20. [CrossRef]
6. UNWTO. COVID-19 and Tourism. 2021. Available online: <https://www.unwto.org/covid-19-and-tourism-2020> (accessed on 7 October 2022).
7. Mazurkiewicz, R. Rzeź Restauracji. Zyskały Tylko Wielkie Sieci. Rzeczpospolita. 2022. Available online: <https://www.rp.pl/gastronomia/art19317031-rzez-restauracji-zyskaly-tylko-wielkie-sieci> (accessed on 23 January 2022).
8. Sigala, M. Tourism and COVID-19: Impacts and implications for advancing and resetting industry and research. *J. Bus. Res.* **2020**, *117*, 312–321. [CrossRef] [PubMed]
9. Kim, J.; Kim, J.; Lee, S.K.; Tang, L. Effects of epidemic disease outbreaks on financial performance of restaurants: Event study method approach. *J. Hosp. Tour. Manag.* **2020**, *43*, 32–41. [CrossRef]
10. Muller, C. Will Dine-In Restaurants Survive the Pandemic? Futurity. 19 May 2020. Available online: <https://www.futurity.org/restaurants-after-covid-19-pandemic-2369632/> (accessed on 4 October 2020).
11. Türkcan, K.; Erkuş-Öztürk, H. The impact of economic and political crises on the survival of tourism-related firms: Evidence from Antalya. *Tour. Econ.* **2019**, *26*, 1152–1174. [CrossRef]
12. Altin, M.; Ridderstaat, J.; Lelo de Larrea, G.; Köseoglu, M.A. Influence of institutional economics on firm birth and death: A comparative analysis of hospitality and other industries. *Int. J. Hosp. Manag.* **2020**, *86*, 102442. [CrossRef]
13. Neise, T.; Verfürth, P.; Franz, M. Rapid responding to the COVID-19 crisis: Assessing the resilience in the German restaurant and bar industry. *Int. J. Hosp. Manag.* **2021**, *96*, 102960. [CrossRef]
14. Yost, E.; Kizildag, M.; Ridderstaat, J. Financial recovery strategies for restaurants during COVID-19: Evidence from the US restaurant industry. *J. Hosp. Tour. Manag.* **2021**, *47*, 408–412. [CrossRef]
15. Türkes, M.C.; Stancioiu, A.F.; Baltescu, C.A.; Marinescu, R.-C. Resilience Innovations and the Use of Food Order & Delivery Platforms by the Romanian Restaurants during the COVID-19 Pandemic. *J. Theor. Appl. Electron. Commer. Res.* **2021**, *16*, 3218–3247. [CrossRef]
16. Tse, A.C.B.; So, S.; Sin, L. Crisis management and recovery: How restaurants in Hong Kong responded to SARS. *Hosp. Manag.* **2006**, *25*, 3–11. [CrossRef]
17. Madeira, A.; Palrão, T.; Mendes, A.S. The Impact of Pandemic Crisis on the Restaurant Business. *Sustainability* **2021**, *13*, 40. [CrossRef]
18. Alkasasbeh, F. The Effects of COVID-19 on Restaurant Industry: A Perspective Article. *J. Innov. Digit. Mark.* **2020**, *1*, 22–31. [CrossRef]
19. Israeli, A. Crisis-management practices in the restaurant industry. *Hosp. Manag.* **2007**, *26*, 807–823. [CrossRef]
20. Fusté-Forné, F.; Husain, A. We are open: Understanding crisis management of restaurants as pandemic hits tourism. *J. Hosp.* **2020**, *3*, 41–48.
21. Messabia, N.; Fomib, P.-R.; Koolib, C. Managing restaurants during the COVID-19 crisis: Innovating to survive and Prosper. *J. Innov. Knowl.* **2022**, *7*, 100234. [CrossRef]
22. Israeli, A.; Reichel, A. Hospitality crisis management practices: The Israeli case. *Int. J. Hosp. Manag.* **2003**, *22*, 353–372. [CrossRef]
23. Okumus, F.; Karamustafa, K. Impact of an economic crisis: Evidence from Turkey. *Ann. Tour. Res.* **2005**, *32*, 942–961. [CrossRef]
24. Motoc, A. Crisis Management and Resilience for Restaurants in Romania during the COVID-19 Pandemic. *Manag. Dyn. Knowl. Econ.* **2020**, *8*, 435–449. [CrossRef]
25. Gkoumas, A. Developing an indicative model for preserving restaurant viability during the COVID-19 crisis. *Tour. Hosp. Res.* **2022**, *22*, 18–31. [CrossRef]

26. Elshaer, A.M. Restaurants' Response to COVID-19 Pandemic: The Realm of Egyptian Independent Restaurants. *J. Qual. Assur. Hosp. Tour.* **2022**, *23*, 716–747. [CrossRef]
27. Lai, H.B.J.; Zainal Abidin, M.R.; Hasni, M.Z.; Ab Karim, M.S.; Che Ishak, F.A. Key adaptations of SME restaurants in Malaysia amidst the COVID-19 Pandemic. *Int. J. Res. Bus. Soc. Sci. (2147-4478)* **2020**, *9*, 12–23. [CrossRef]
28. Yang, Y.; Liu, H.; Chen, X. COVID-19 and restaurant demand: Early effects of the pandemic and stay-at-home orders. *Int. J. Contemp. Hosp. Manag.* **2020**, *32*, 3809–3834. [CrossRef]
29. Byrd, K.; Her, E.S.; Fan, A.; Almanza, B.; Liu, Y.; Leitch, S. Restaurants and COVID-19: What are consumers' risk perceptions about restaurant food and its packaging during the pandemic? *Int. J. Hosp. Manag.* **2021**, *94*, 102821. [CrossRef]
30. Ograniczenia Działalności. Ograniczenia Działalności Gastronomicznej, Rozrywkowej Oraz Funkcjonowania Galerii Handlowych. 2020. Available online: <https://www.gov.pl/web/koronawirus/ograniczenia-dzialalnosci-gastronomicznej-rozrywkowej-oraz-funkcjonowania-galerii-handlowych> (accessed on 7 March 2021).
31. Kaszuba-Janus, M. GfK: Prawie 40 proc. Gości Wspierało Gastronomię w Czasie Lockdownu. 2020. Available online: <https://www.horecanet.pl/gfk-prawie-40-proc-gosci-wspieralo-gastronomie-w-czasie-pandemii> (accessed on 7 March 2021).
32. Nurkowska, M. Zarządzanie Restauracją w Kryzysie: Działania Podejmowane Podczas Pandemii COVID-19 [Restaurant Management in Crisis: Actions Taken during the COVID-19 Pandemic]. Master's Thesis, WSB University in Poznan, Poznań, Poland, 2021, *unpublished*.
33. Mortality Analyses. 2022. Available online: <https://coronavirus.jhu.edu/data/mortality> (accessed on 12 September 2022).
34. Headd, B. Redefining business success: Distinguishing between closure and failure. *Small Bus. Econ.* **2003**, *21*, 51–61. [CrossRef]
35. Parsa, H.G.; Van Der Rest, J.P.I.; Smith, S.R.; Parsa, R.A.; Bujisic, M. Why restaurants fail? Part IV: The relationship between restaurant failures and demographic factors. *Cornell Hosp. Q.* **2015**, *56*, 80–90. [CrossRef]



## Article

# Contextual Factors of Resilient Tourism Destinations in a Pandemic Situation: Selected Cases from North and South Tyrol during the SARS-CoV-2 Pandemic

Elisabeth Nöhammer <sup>1,\*</sup> , Marco Haid <sup>2</sup> , Philipp Corradini <sup>3</sup> , Susanne Attenbrunner <sup>1</sup>, Peter Heimerl <sup>2</sup> and Robert Schorn <sup>4</sup>

<sup>1</sup> Institute for Management and Economics in Healthcare, UMIT Tirol—Private University for Health Sciences, Medical Informatics and Technology, Eduard-Wallnoefer-Zentrum 1, 6060 Hall in Tirol, Austria

<sup>2</sup> Division for Management in Health and Sport Tourism, UMIT Tirol—University for Health Sciences, Medical Informatics and Technology, Eduard-Wallnoefer-Zentrum 1, 6060 Hall in Tirol, Austria

<sup>3</sup> Institute for Regional Development, Eurac Research, Viale Druso 1, I-39100 Bolzano, Italy

<sup>4</sup> Institute of Psychology, UMIT Tirol—University for Health Sciences, Medical Informatics and Technology, Eduard-Wallnoefer-Zentrum 1, 6060 Hall in Tirol, Austria

\* Correspondence: elisabeth.noehammer@umit-tirol.at

**Abstract:** This study examines critical factors for tourism destination resilience in the first year of the SARS-CoV-2 pandemic in North Tyrol (AT) and South Tyrol (IT). Based on a mixed-method approach, the summer seasons of 2019 and 2020 are compared regarding change in overnight stays in 26 municipalities. The results highlight the importance of the classical 4Ps of marketing and specific contextual factors. These and their implications for research and practice are discussed. Marketing mix aspects most relevant for resilience in a highly tourism-dependent region are outlined.

**Keywords:** resilience; absorption; SARS-CoV-2; Tyrol; marketing; marketing mix



check for updates

**Citation:** Nöhammer, E.; Haid, M.; Corradini, P.; Attenbrunner, S.; Heimerl, P.; Schorn, R. Contextual Factors of Resilient Tourism Destinations in a Pandemic Situation: Selected Cases from North and South Tyrol during the SARS-CoV-2 Pandemic. *Sustainability* **2022**, *14*, 13820. <https://doi.org/10.3390/su142113820>

Academic Editors: Zygmunt Kruczek and Bartłomiej Walas

Received: 29 September 2022

Accepted: 23 October 2022

Published: 25 October 2022

**Publisher's Note:** MDPI stays neutral with regard to jurisdictional claims in published maps and institutional affiliations.



**Copyright:** © 2022 by the authors. Licensee MDPI, Basel, Switzerland. This article is an open access article distributed under the terms and conditions of the Creative Commons Attribution (CC BY) license (<https://creativecommons.org/licenses/by/4.0/>).

## 1. Introduction

As an important part of the global economy [1,2], the tourism industry contributes significantly to economic development in various regions [3,4]. It is characterized by intense competitive rivalry, risk, leverage, capital intensity [5]. Moreover, it is inherently vulnerable to various types of crises [6,7], especially to the regional occurrence of infectious diseases [8]. Crises and disasters always harm tourism [9], especially in destinations that are highly dependent on tourism such as remote rural areas [10]. These destinations and the industry, in general, are pressured to quickly recover and/or adapt. Doing so sustainably in the sense of a rapid reaction using existing resources is essential in the first phase of reacting to a crisis, while keeping a strategic outlook on the long-term effects of chosen coping strategies.

As an example, and case, this paper examines how the hospitality and tourism industry of North and South Tyrol (the former in Austria, the latter in Italy) was affected by the pandemic and which characteristics of the marketing mix influence different levels of resilience by comparing municipalities with substantial versus more moderate losses. For this, quantitative data on overnight stays of the summer 2020 are compared to 2019 and analyzed in depth. Furthermore, the findings of the data analysis are complemented by information gathered through qualitative interviews. This paper focuses on short-term resilience and absorptive capacity, thereby addressing this gap in the literature.

The contribution of the study is twofold: First, it contributes to a deeper understanding of tourism destinations from a resilience and crisis perspective and highlights critical (survival) factors in a pandemic changed macro-environment. Second, limitations for assessing and evaluating resilience-relevant characteristics of tourism destinations are

explored and discussed. Thereby, scale in the sense of different levels of action and operation is applied, plus the marketing mix concept as a framework for analysis.

### 1.1. Resilience in Tourism and Tourist Destinations

The concept of resilience has seen a proliferation of different definitions, of which one of the most utilized is the one provided by the United Nations Office for Disaster Risk Reduction [11]. It defines resilience as “[t]he ability of a system, community or society exposed to hazards to resist, absorb, accommodate, adapt to, transform and recover from the effects of a hazard in a timely and efficient manner [ . . . ]” [11].

As the first step in a resilience assessment, the object under scrutiny and the disruption impacting the object need to be defined [12]. For the present paper, the impacts of the SARS-CoV-2 pandemic on tourism destinations will be analyzed. The latter are socioeconomic systems composed of many actors collaborating to create a coherent tourism product [13]. The term destination is used at different scales and can be applied to a municipality or part thereof, a region, a country, and even larger transnational areas [14]. The present paper uses the term destination to refer to political districts consisting of geographically connected individual municipalities, of which eight per destination are analyzed (also see Section 2).

The current disruption affecting tourism destinations can be defined as an external shock whose sudden emergence revealed the vulnerability of the tourism systems regarding disease outbreaks [15,16]. In case of a shock, coping is especially challenging, as there is a sudden increase in uncertainty, requiring immediate actions in an often complex and volatile situation [17].

Depending on the magnitude and the temporal continuation of the shock, the intensity of its impact on tourism destinations can be minor or long-lasting, requiring different coping strategies. Initially, the aim is absorbing the disruption while maintaining the overall system structure [18–20]. This pursuit of system stability in the face of turmoil is delineated by the concept of Engineering Resilience. It focuses on the duality between the preservation of the system’s initial equilibrium and a certain degree of systemic flexibility, although the latter does not lead to a modification of the system’s structures [21,22]. In case of the temporal persistence of the effects of the disruption, adaptations can be necessary through which the system’s structure is slightly modified [23]. Destinations that managed an initial reaction to the shock better, i.e., more sustainably, could be expected to have an economic and temporal advantage for proceeding through the coping phases. This hypothesis, however, needs to be investigated, starting by analyzing which destinations recover in a more timely manner in terms of overnight stays and focusing the notion of Absorptive Capacity.

According to Cutter et al. [24], “absorptive capacity is the ability of the community to absorb event impacts using predetermined coping responses”. Due to the novelty of the situation [25], the complex structure of tourism destinations [26], the high level of uncertainty regarding the future development of the pandemic [27], and the limited innovative capabilities of family tourism businesses [28], which are a cornerstone of alpine tourism [13], immediate responses to the situation are challenging. These were required in the first year of the pandemic and its summer season, lasting from May to October 2020.

The initial phase of the crisis was characterized by the closure of the tourism businesses and infrastructures, demarking the inoperative dimension of the tourism industry, during which internal economic resources were utilized to counteract the loss of revenue, which was followed by the depletion of public economic resources in order to support (tourism) businesses and employees [29,30]. Although the restrictions were alleviated, the effects of the pandemic lasted well throughout 2020 (and, of course, in the subsequent years). Due to limited immediate infrastructural and organizational flexibility, the short-term absorptive coping mechanisms of tourism systems during severe disruptions largely rely on marketing activities within the scope of national pandemic-related travel regulations.

## 1.2. Marketing Mix (7P)

The marketing mix is “the most fundamental concept of marketing” [31] with a history of several decades of development and refinement [31,32], leading to a widely used framework of seven elements. This is based on the so-called 4P model of marketing that focuses on tangible products and thus considers the product itself, its price, promotion, and place/distribution [33]. By adding three elements relevant for services, namely physical evidence, process, and people (or: participants), the model becomes applicable for tourism [34], which combines tangible and intangible aspects [35].

With a certain product, a company aims at satisfying client needs. This has to be communicated to the prospective customers (promotion), and its accessibility needs to be ensured via distribution channels, etc. (place), as well as a price set determining its value [36]. In the tourism context, the product typically is a product-service mix; thus, this P can be described as “the overall impression of the intangible, experiential product”, while place also refers to location [32]. Physical evidence is mainly relevant within the service sector as the perceivable context influences the perception of its worth and quality [36,37], it constitutes “the tangible aspects of the experiential product” [32]. People refer to the organizations’ staff dealing with the (prospective) clients, while processes comprise all activities connected to delivering a service [36,37].

Research shows that all elements of the enlarged marketing mix (7Ps) are relevant [38], but their importance depends on the type of tourism [32]. The concept provides a basic categorization of important elements but needs to be more comprehensive and refined for specific settings, approaches, and situations. Some contexts might require further elements such as co-creation/production of the experience with the client, which is included in specific concepts that were proposed [35], or adding a quality and productivity dimension to highlight their importance for the interaction between client and organization [36]. To be generalizable, this paper builds on the commonly employed 7P model, which is recommended for tourism research as it provides a broad base for application and analysis [32].

The definition of destination outlined above employs an ecosystem perspective, highlighting the actors’ interdependence and activities. Thus, we apply the marketing mix perspective on the unique selling proposition (collectively) created for the destination. As Calgaro et al. [39] highlight regarding the climate change crisis, the vulnerability of destinations regarding external shocks depends on their characteristics. These need to be taken into account to define sustainable short-term and long-term reactions. Focusing on the factors not relevant solely for climate change, our conceptual framework (see Section 2 and Appendix A) summarizes them based on the marketing mix elements.

This work examines the marketing mix and its effects on resilience in terms of absorptive capacity based on a mixed-methods design. We investigate municipalities in North and South Tyrol, which are highly tourism-dependent regions in Austria and Italy. In crises, first reactions are of high relevance. This paper aims at providing deeper insights into this phase, which has not been intensively researched so far.

## 2. Materials and Methods

A conceptual framework (see Figure 1) was created by the authors which is based on the combination of resilience and marketing, differentiating between individual organizations (hotels, etc.) and destinations, but also highlighting that the former are located in the latter.

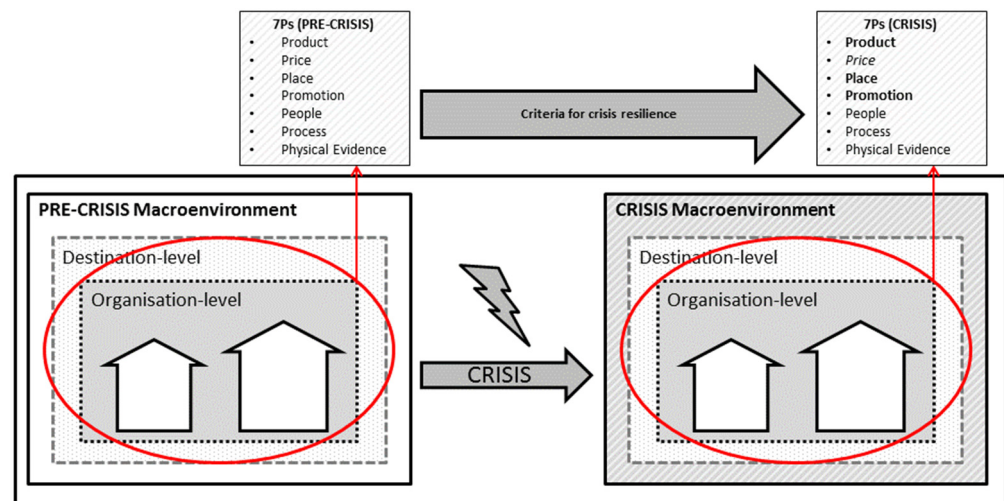

**Figure 1.** Conceptual Framework.

The model assumes a changing macroenvironment (from pre-crisis to crisis macroenvironment) due to the COVID-19 pandemic (e.g., lockdowns, guest limitations) and postulates that the marketing mix criteria and conditions of destinations are decisive for their crisis resilience. As the scope of changes and options for resilience differ depending on the time of analysis, the status within and after the pandemic needs to be distinguished. During a crisis, reactions are limited to given facts and possibilities at hand. However, these can already affect post-crisis choices due to path dependency, creating a dynamic interdependence. Therefore, and as the crisis is still ongoing, the paper focuses on factors connected to resilience during the pandemic from an absorptive capacity point of view.

In addition, the framework includes scale as a further theoretical perspective by considering different levels (organization level and destination level), thus recognizing that individual levels alone cannot fully control or realize tourism development and resilience [40,41]. Rather, stakeholder collaboration within and between the levels is seen as crucial, especially for resilience [42,43]. This applies not only to adaptation measures regarding corporate social responsibility, as highlighted by Font and McCabe [43], but also to the utilization of existing elements of the marketing-mix portfolio and conditions of the destination influencing its absorptive capacity. As the SARS-CoV-2 pandemic has shown, the global and national contexts have to be considered regarding, for example, travel restrictions and lockdowns, which are leading to forced standstills within the hospitality industry [44]. Thus, we assume place as location, as well as promotion, and product to be the most important aspects during the phase in which absorptive capacity is prominently needed.

This study uses a mixed-method research design, following a pragmatic approach [45,46] as widely used in tourism research [47–49]. Resilience is operationalized using overnight stays, as this is considered a direct and objective measure of tourism development [50,51] and a characteristic variable of resilience and stability in a tourism system context [50].

## 2.1. Study Areas

For a map, please refer to [52].

### 2.1.1. North Tyrol

Before COVID-19, tourism accounted for 17.5% of North Tyrol's gross value-added. Almost every fourth full-time job was connected to the tourism industry [53]. It is characterized by family-run small and medium-sized enterprises [3,54] but also by regional differences and seasonal fluctuations [48]. Due to the COVID-19 pandemic, tourism flows experienced substantial declines [55], although compared to urban tourism, faster recovery is expected in areas close to nature, within which the majority of the main tourism desti-

nations are located in North Tyrol [56]. Moreover, except for the first lockdown in March 2020, health tourism was always possible in North Tyrol during the pandemic.

### 2.1.2. South Tyrol

In South Tyrol, the tourism structure is characterized by a prevalence of family-run small and medium-sized enterprises as well [57]. In 2019, tourism (defined as accommodation and food service activities by the National Statistic Institute) accounted for 11.4% of South Tyrol's gross value-added [58]. After this year, within which the highest tourism flows ever have been recorded, due to the pandemic and subsequent closing of borders as well as national lockdowns, in 2020, a sharp decline in arrivals and overnight stays was registered, amounting to an overall decrease of 35% of the overnight stays in comparison to 2019 [58]. Thus, it is especially interesting to see variations of impacts on destinations in South Tyrol and to which determinants this might be attributed.

## 2.2. Study Design

The study is structured in two parts: First, following a quantitative approach, it identifies destinations with higher and lower resilience based on the number of overnight stays. The analytical process is described in detail in Section 2.2.1. Second, based on the findings and selections of the first part, qualitative analyses were conducted to identify criteria and factors that can explain the differences between the winning and losing municipalities and thus destinations. We did so by combining two qualitative approaches: interviews with selected experts as well as structured analyses of the websites of the municipalities. In Section 2.2.2, the qualitative approaches are described in detail.

The results of all analyses were triangulated, which is an approach that examines the convergence, complementarity, and dissonance of findings gathered with different methods [59]. This data triangulation allows deriving an overall picture from many partial results and thus increasing the validity of conclusions [59,60]. Concretely, two researchers examined all data for consistencies, complementarities, and dissonances. This was completed in a constant process of discussion and reflection. Two additional researchers were involved at the end of the triangulation to validate and evaluate the analysis, the commonalities and dissonances found in terms of the research objective. Another researcher acted as an “external reviewer” to ensure the reliability and validation of the entire research process [61].

### 2.2.1. Identification of Destinations to Be Further Investigated

Publicly available data [55,62] on overnight stays in North Tyrol and South Tyrol were analyzed to identify destinations and their municipalities with higher and lower losses in overnight stays. For that, the period May–October in 2019 (pre-COVID 19 pandemic) was compared to 2020 (COVID 19 pandemic), since the free movement of people was allowed and possible during this period of the pandemic.

The two political districts in both North and South Tyrol with the highest number of overnight stays in absolute terms in 2019 were selected. During the specified period, they represented more than 30% of the total number of overnight stays in North Tyrol and more than 50% in South Tyrol. For each of the four selected districts, two municipalities with the best overnight stay development between 2019 and 2020 from May to October were selected according to *absolute* overnight stays as well as two according to *relative* (percentage) development. Similarly, in each of the four districts, two municipalities with the worst developments in *absolute* overnight stays and two with the worst *relative* developments were selected. Per political district, we thus analyzed eight municipalities, resulting in a total of 24. The capitals of North Tyrol (Innsbruck) and South Tyrol (Bozen) were added, leading to a total of 26.

To avoid distortions caused by municipalities with a particularly low level of tourism (these usually have only a marginal decline due to the pandemic in the already few overnight stays), only municipalities that had at least 1% of the overall overnight stays in the period from May to October 2019 were included in the analysis. This resulted in

a reduction in the number of considered municipalities to 21 for Pustertal, and to 17 for Burggrafenamt. For the selected municipalities, the information on overnight stays was supplemented by additional data on visitor origin and supply structure, respectively, types of accommodation (e.g., hotel categories, camping, commercial and private accommodation). Although the data are publicly available and there are publications disclosing changes in overnight stays [63,64], the municipalities in this paper are anonymized to avoid impacts on the image of destinations with more pronounced losses in overnight stays.

### 2.2.2. In-Depth Analysis to Identify Key Resilience Criteria

We employed a structured website analysis and qualitative interviews with people employed in mostly higher (leadership/management) positions in the tourism ecosystem and further tourism stakeholders. The website analysis results were independently coded by two members of the research team [65]. To provide maximum independence and validity testing, one utilized a deductive approach based on a coding framework developed beforehand that summarized key elements mentioned in the literature (i.e., [39]), representing the elements of the marketing mix. Following Mayring [66], the contents of the websites were assigned to the deductive coding framework. The other followed an inductive thematic open coding approach [67]. In doing so, the codes were openly and freely formed into as many categories as possible, incident by incident, without a framework [67,68]. Both approaches are described in research as valid options depending on the research aim [69]. As this paper is designed to build theory and test it, both were needed. The researchers independently developed summative abstractions and assumptions (interpretations) based on the results. These were compared and found to be identical, which was also tested by cross-checking combinations of codes using the software-based inductive coding data. This had additionally the advantage that, referring to McHugh [70], the inter-rater reliability of the analysis was increased in addition to the higher data respectively evaluation quality. The categories that were created covered: demographic aspects of the destination, its reachability and touristic infrastructure, the target groups, the design of product/service packages and its adequacy regarding the target groups, promotional efforts and their quality plus fit to target groups, pricing, booking processes, client satisfaction reports, interaction with the target group(s) and the evaluation of the website (attractiveness, reports about services and touristic infrastructure). The results were then clustered to differentiate between winning and losing destinations.

The qualitative interviews were unstructured and problem-centered [71]. In an exploratory process, this offers the advantage of generating comprehensive data and insights by flexibly focusing on lived experiences and attitudes [72]. The interviews aimed at enquiring regarding chances as well as challenges of the local tourism industry during the pandemic, differences between types of tourism and touristic offers, also engaging expert knowledge regarding specific geographical areas. Within the unstructured interviews, these were the main topics. Depending on the interviewee, these were emphasized to varying degrees depending on the interview process. In this way, it was possible to focus on individual persons, their perspectives, and professional areas, thus obtaining a more complete picture.

Based on Teddlie and Yu [73], we used purposive sampling. Purposive sampling involves intentionally selecting participants based on the purpose of the research, certain characteristics, or roles because they, in particular, can provide important information [73,74]. Within purposive sampling, the sample was drawn sequentially with the advantage of exploratively obtaining continually new relevant insights for the research objective [73,75]. In total, 12 interview partners were chosen from the professional networks of the authors, ensuring a trust base for valid responses, with the aim of representing a wide variety of stakeholders in the tourism sector. The interview pool thus encompassed: managers and owners of different types of hotels, managers and employees of tourism organizations, tourism-related organizations and organizations in the tourism ecosystem, employees of hotels with specific health offer-related roles, and the guest/patient perspective. The final sample size of 12 interviews

was determined by theoretical saturation, i.e., conducting as many interviews as needed until sufficient data are collected and no new findings are obtained [76]. Theoretical saturation was discussed among the authors, reflected upon, and validated by the “external reviewer” [61] described above.

The interviewees were informed about the purposes of the study before the interview and were asked for their written consent for the anonymous utilization of the information for the subsequent qualitative analysis. The interviews were conducted from February to July 2021 on the participants’ premises in person or via telephone calls by one of the authors and lasted between 10 and 70 min. The interviews were summarily transcribed based on thought protocols and notes. This procedure fulfills the analytical requirements of the present study and its objective as, in particular, it enables identifying and combining themes and patterns [77]. In addition, nine phone calls to hotels were performed to check to which degree-specific information given by the interviewees was observable in practice, namely the concrete conditions for using health touristic offers during the pandemic.

### 3. Results

In this section, the quantitative and qualitative results are described and combined.

#### 3.1. Selected Tourism Destinations for the Quantitative Analysis

The quantitative analysis was based on the comparison of the overnight stays of 2019 and 2020 of selected tourism destinations in North and South Tyrol. As the quantitative data are collected and made available by the regional statistical institutes at the municipal level of both regions, it was possible to analyze the changes in tourism flows on this level [55,62]. In order to identify the municipalities on which to conduct the quantitative (and subsequent qualitative) analysis out of the 279 municipalities in North and 116 municipalities in South Tyrol, the approach described in Section 2.2.1 was utilized.

Table 1 shows the absolute change of overnight stays in the chosen destinations of both North and South Tyrol. North Tyrol is shown in the two left columns, listing the political districts identified and the municipalities analyzed. The same is shown for South Tyrol to the right. Table 2 follows the same structure and depicts the relative changes in overnight stays.

**Table 1.** Absolute change of overnight stays between 2019 and 2020 (municipalities anonymized with capital letter indicating absolute Winners and Losers).

North Tyrol		South Tyrol	
Political District	Municipality	Political District	Municipality
Schwaz	Winner:	Burggrafenamt	Winner:
	Schwaz_W1: −11,160		Burggrafenamt_W1: −20,326
	Schwaz_W2: −11,918		Burggrafenamt_W2: −24,265
	Loser: Schwaz_L1: −222,963		Loser:
	Schwaz_L2: −150,776		Burggrafenamt_L1: −382,190
			Burggrafenamt_L2: −356,186
Kitzbüchel	Winner:	Pustertal	Winner:
	Kitzbüchel_W1: −3527		Pustertal_W1: −11,261
	Kitzbüchel_W2: −7515		Pustertal_W2: −17,788
	Loser:		Loser:
	Kitzbüchel_L1: −151,521		Pustertal_L1: −130,844
	Kitzbüchel_L2: −146,731		Pustertal_L2: −92,272
Capital	Innsbruck: −612,817	Capital	Bozen: −195,842

**Table 2.** Relative change of overnight stays between 2019 and 2020 (municipalities anonymized with lower-case letter indicating relative winners and losers).

North Tyrol		South Tyrol	
Political District	Municipality	Political District	Municipality
Schwaz	Winner: Schwaz_w1: −12.88% Schwaz_w2: −16.95%	Burggrafenamt	Winner: Burggrafenamt_w1: −23.56% Burggrafenamt_w2: −26.46%
	Loser: Schwaz_l1: −43.29% Schwaz_l2: −35.88%		Loser: (Actually Burggrafenamt_L1, but already inserted within the absolute losers) Burggrafenamt_l1: −41.94% Burggrafenamt_l2: −41.87%
Kitzbühel	Winner: (Kitzbühel_W1, which already ranges within the absolute winners, thus not included here) Kitzbühel_w1: −13.34% Kitzbühel_w2: −19.49%	Pustertal	Winner: Pustertal_w1: −11.94% Pustertal_w2: −12.30%
	Loser: Kitzbühel_l1: −49.26% Kitzbühel_l2: −45.78%		Loser: Pustertal_l1: −34.41% Pustertal_l2: −31.18%
Capital	Innsbruck: −61.3%	Capital	Bozen: −45.2%

A larger decline of overnight stays was observed in urban areas in comparison to rural municipalities.

### 3.1.1. Tourism Flows in North Tyrol

In North Tyrol, nearly 100% of the summer tourist flows originate in Germany, Austria, the Netherlands, Switzerland and Liechtenstein, and Belgium. These source markets are also arranged based on their quantitative importance, with Germany usually accounting for between 60% and 70% and Austria up to approximately 10% of the overall tourism flows. In 2020, the German market remained the most important for the Kitzbühel and Schwaz district. Furthermore, its importance even partly increased in relation to other source markets, the apparent reason for which is the immediate proximity of these Austrian districts to the German border. The minor losses, e.g., in the Zillertal region (e.g., Schwaz\_W2 and Schwaz\_l1) can be partly explained by their geographical location. In addition, the domestic market recorded a significant increase in overnight stays in both districts and all the municipalities included therein. The percentage of domestic tourists in the municipality of Kitzbühel\_L1 rose from 24.02% in 2019 to 31.40% in 2020. The municipalities Schwaz\_W1 and Schwaz\_L2 are among the vacation destinations that more than doubled the relative percentage of domestic tourists in the summer of 2020 (Schwaz\_W1 from 5.14% in 2019 to 11.17% and Schwaz\_L2 from 8.61% in 2019 to 16.28% in 2020). The surroundings of the latter allow for a wide variety of sports and outdoor activities, including water sports, offering adventure moments for families as well as those seeking peace and quiet, making it a popular spot for locals and domestic tourists. Dutch tourists travelled to Tyrol slightly less (roughly between −1% and −3%). Campsites were more in demand in the 2020 tourism year than other types of accommodation. Swiss and Liechtenstein tourists were also registered in North Tyrol in summer 2020, but there were slight decreases in the district of Kitzbühel as in the municipality of Kitzbühel\_L1 −1.8%, Kitzbühel\_w1 −0.51%, Kitzbühel\_L2 −1.79%, and Kitzbühel\_w2 −0.14%. The municipalities of Kitzbühel\_W2 (+0.16%), Kitzbühel\_l2 (+0.3%) and Kitzbühel\_l1 (+0.32%) recorded a relative increase. In the district of Schwaz, there was a decrease of 0.86% in overnight stays by Swiss and Liechtenstein tourists in Schwaz\_L2. A visible increase was recorded in Schwaz\_W1, for which in 2019, the Swiss and Liechtenstein market accounted for 4.56%, rising to 8.28% in 2020. The 5th relevant country of origin for summer tourists in North Tyrol is Belgium,



which in the district of Kitzbühel showed a slight increase in two of eight municipalities (Kitzbühel\_w1 and Kitzbühel\_W2), and in the district of Schwaz, half of the municipalities hosted more Belgian guests (Schwaz\_L2, Schwaz\_w2, Schwaz\_W1, Schwaz\_I1) and the other half recorded a decrease (Schwaz\_L1, Schwaz\_I2, Schwaz\_w1, Schwaz\_W2).

Finally, it should be mentioned that in both political districts (excluding the third, Innsbruck), (1) both families and individual tourists are attracted with various offers, (2) nature and the mountains stand for sports, exercise, and thus health (fresh mountain air) and (3) numerous attractions are located in close proximity of each other, which provides convenience.

### 3.1.2. Tourism Flows in South Tyrol

On the political district level, regarding the source markets within the summer season (May–October 2019), Burggrafenamt exhibited a differing structure compared to Pustertal. While the former heavily depended on international tourists (Germans: 74% of the overall overnight stays in 2019), the latter focused on the domestic market (Italians: 55% of the overall overnight stays in 2019). Although throughout the summer season of 2020, international travel was gradually restored, and the share of the domestic market overnight stays saw an increase in both areas, the strong dependence of the Burggrafenamt on international tourists resulted in a decrease of  $-38\%$  of the overall overnight stays ( $-2,184,535$  overnight stays), while Pustertal recorded a  $-20\%$  ( $-1,122,629$  overnight stays).

All tourism destinations saw a substantial increase in the share of domestic tourists during the summer season 2020, which was even subsidized by the Italian state for certain groups of tourists (mainly families), and a decrease in the main international source market, namely Germany. This may be connected to the higher number of German Tourists in North Tyrol, who could have preferred a closer destination and crossing only one border in a still volatile sanitary situation.

On the level of the identified tourism destinations, a similar pattern, although not as prominent, can be identified. In general, within the identified winner and loser municipalities of both political districts, the first four source markets account for at least 90% of the overall overnight stays, namely, domestic tourism, Germany, Austria, as well as the pooled overnight stays of the guests from Switzerland and Liechtenstein. The remaining overnight stays accounted for the pooled overnight stays of the guests from Belgium, the Netherlands and Luxemburg (BENELUX), and other countries, which, due to their minor importance as source markets, are not further itemized.

The tendency toward a higher share of domestic tourism during 2019 was a general feature of the winning destinations in comparison to the losing destinations, except for Burggrafenamt\_L1, which, being a city destination, saw an overall, quite conspicuous decrease in the overnight stays in absolute and relative terms. Although the losing destinations also saw a significant increase in the domestic market in 2020, which on occasion was even higher in comparison to the winning destinations (for example, Burggrafenamt\_W1 had a  $+9.7\%$  increase, while Burggrafenamt\_L1 a  $+15.4\%$  increase; Pustertal\_w1 had a  $13.4\%$  increase, while Pustertal\_I1 a  $24.2\%$  increase), the main feature of the winning destinations in comparison to the losing destinations in absolute and relative overnight stays is that the former had a higher share of domestic tourism already in the year previous to the pandemic than the latter. This underlines the assumption that the traditional structure of the source markets has an influence on the absorptive capacity of tourism destinations. They initiate absorptive mechanisms to slightly modify the distribution of the source markets, but their path dependency concerning their past structure inhibits a more extensive absorption of the repercussions of the shock: in this case, the diminishment of international tourism flows.

### 3.2. Website Analysis

The website analysis and the collection of additional information about the municipalities and the touristic offers revealed several differences between winning and losing municipalities. The former, in comparison, predominantly exhibit the following characteristics.

1. Winning municipalities have fewer residents (less than 1500).
2. There are two types of winning municipalities:

Type 1: They are presented as quiet, not very crowded, or even untouched destinations. This is expressed either by explicitly highlighting these facts or by not providing much information about the destination and a low degree of marketing activities.

Type 2: Highly professional marketing, targeting various guest groups (especially families), showcases the variety of the touristic offerings, as well as beautiful nature and rather relaxed activities, which are mentioned in text and shown in pictures, or a mix of more adventurous and more quiet offerings.

The winning municipalities seem to have or convey less emphasis on tourism, i.e., they are mostly not tourism hotspots. They focus mainly on the following target groups: family and children, people with an affinity for sports, couples, as well as elderly, and—which distinguishes them from most destinations with a more pronounced reduction in overnight stays—their advertising has a high degree of target group(s) related fit. Moreover, they offer alternative overnight accommodations to (more expensive) hotels, such as places for camping, apartments, vacation homes, or similar. The winning destinations also seem to tend to be lower priced than the losing ones. Having fewer residents, placing less emphasis on tourism, and offering a broader range of accommodation structures may attract guests who intend to avoid crowds and prefer quiet, less crowded destinations and accommodations.

Municipalities with bigger losses in overnight stays mainly have the following characteristics:

1. They are tourism hotspots, classic destinations known to attract large tourism flows.
2. While some have highly professional marketing, the websites of others are not attractive, and their marketing is not targeted and suggests they are only alternative quarters for nearby locations that are too expensive. Here, being a small destination may have a negative effect, especially in case of marketing mergers and shared web presences.
3. While nature and family are important in their marketing, tradition and events are also highlighted.
4. Some only focus on winter tourism.
5. Many are known to have a high number of regular guests from countries where travel bans were active.
6. Many target the high-price segment.

No differences could be found concerning positive or negative ratings and generally the quality of marketing or web presence.

### 3.3. Interviews

The lockdowns are described as existential and emotional shocks (Interviews 6, 7) for all major stakeholders of hotels covered here (owners, employees, guests); the situation itself was extremely unclear and chaotic for all concerned. Major internal issues were (a) costs, (b) use of time, and (c) employees. Covering costs was approached by navigating through possibilities for state aid (Interviews 5, 6, 7, 8, 9)—checking for applicability, applying for them, safeguarding the entitlement, and finding commercial possibilities for supplementing state aids when, for example, providing take away food was permitted. Many opted for using the lockdown time for renovation activities (Interview 6). Concerns were raised regarding the re-opening due to an increase in resignations of employees, opting for professions that have been perceived as being more pandemic-safe or having more regular working hours, also through professional retraining (Interviews 1, 6, 8). Keeping in steady contact with employees was described as highly important

(Interview 6). While staff are already sourced from other countries (Interview 8), this might also become more important in the future. Regarding external considerations, a re-orientation regarding target markets was started (Interview 6), and cancellation policies were adapted (shortened to increase trust) (Interviews 1, 6). Countries with a high number of people already vaccinated and the domestic market were seen as being more interesting for future marketing activities (Interview 6). The behavior of guests was described as peculiar in summer 2020: while many were satisfied with less service than usual and were observed to simply enjoy to be able to travel to a hotel (Interview 7) and increase their spending while on vacation (e.g., opting for the more expensive wines), other guests were even more demanding, expecting an excessive degree of attention (Interview 6). Moreover, sport activities seemed to be more important than before, just as spending time outdoors (Interviews 1, 2). While health-related activities seemed to be on the rise, hotels with a specific focus on health tourism (incl. rehabilitation) were also allowed to open in Austria except during the first lockdown in spring (Interviews 3, 5). However, the booking situation was (much) below average, and, as there was no required closure, there were different conditions for state aids (Interview 3, 5, 9). Guests complained about the reduced services due to closures of, for example, the spa and sauna areas to comply with SARS-CoV-2 restrictions (Interview 11), in addition to curfews and not having the possibility to receive visitors (Interview 10).

### 3.4. Summary of Results

Municipalities and destinations that comparatively lost more overnight stays in the summer of 2020 versus 2019 are cities, places known to be (rather expensive) touristic hotspots, those which have a higher dependence on international guests, and those with seemingly unaligned marketing activities. Cities are more densely populated, which might lead to a fear of crowded areas and subsequent health risks. Moreover, the gastronomic offer was limited due to official regulations. Destinations with fewer losses in overnight stays tend to be small, have an image of being rather untouched but offering a wide variety of activities for various target groups (always including families), as well as being affordable. Thus, while product design and offer are crucial, adequate placement and targeted promotion as well as reasonable pricing need to complement the package. Thus, the classic four Ps need to be considered and combined. As mentioned above, the 4P as well as the 7P model provide only a rough overview of aspects relevant for marketing and need to be more refined. Appendix A does so for the results of the findings of this paper.

In summer 2020, the package that customers found most attractive seemed to be geared toward products that appeal to audiences that value nature, more relaxed activities, or a wide variety in a more limited setting. Thus, product, place, and promotion are the most important elements of the marketing mix in terms of absorption mechanisms (see Figure 1), with more details provided in the Appendix A. Service (processes) was described as relevant by some guests. People, however, was rather seen as internal issue in the context of Human Resources and personnel retention. Physical evidence was analyzed on the websites regarding the content and pictures shown and had to be subsumed and related to the degree of professionalism in promotion.

## 4. Discussion

The SARS-CoV-2 pandemic heavily impacts global tourism [78,79], especially in regions which exhibit a high economic dependence of the sector. As a first reaction and stage of resilience, existing resources have to be employed to buffer and absorb a crisis impact [18–20]. This paper investigated the resilience of municipalities' tourism industry in North and South Tyrol during the SARS-CoV-2 pandemic during summer 2020. The principal motivation to focus on tourism is twofold: On one side, both regions exhibit a strong economic dependence on the tourism industry. On the other, tourism has been seen as positively contributing to regional economic resilience [80] also due to its inherent ability

to recover in a timely manner [81]. In this context, the paper is of interest to comparable regions on a global level.

Moreover, the paper expands current literature regarding the phases of resilience and regarding scale and scope on the destination level, as other studies, e.g., only focus on high category hotels [82–84], other organizational types such as restaurants [85,86] or tourism organizations [87].

Based on a mixed-methods design, the relative and absolute changes of overnight stays were investigated for six destinations—three in South Tyrol and three in North Tyrol, totaling 26 municipalities which were analyzed in-depth using additional data regarding countries of origin of guests, touristic infrastructure, etc. Furthermore, we conducted interviews, and the websites of the destinations were qualitatively analyzed. The results were linked to the marketing mix and the wider context.

In times of massive external change and uncertainty, strategic adaptation or transformation is discouraged if the direction of change is unclear, while a focus on existing resources [88] can be suggested. This approach becomes even more relevant if sudden shocks, such as the pandemic, have an overarching effect on tourism destinations, which are embedded in regional economies. Following the notion of Engineering Resilience, the timely response of individual actors, such as accommodation providers, supported by the tourism destinations, is vital in order to absorb the effects of the disruption and preserve the overall regional socioeconomic structure [80]. We examined the marketing mix and its effects on resilience in terms of absorptive capacity in this context. The findings show which destinations coped in a better way and link this to certain characteristics. This can be used within destinations to analyze the adequacy of existing resources and strategies for the current situation and future sustainable development. Aiming at resistance [89], the analysis of critical factors for absorptive capacity leads to insights for improving resilience for uncertain times.

Based on the analysis, destinations, as “coherent geographical region[s] with uniform identity and various tourism products” [90], were likely to experience more moderate losses during the pandemic when their offer included nature, health, and family-related activities. Family and health are values that gained in importance during the pandemic and could be safely provided for in nature- and outdoors-oriented destinations. Both North and South Tyrol have a broad offer of the latter, resulting in the resilience of many destinations. While catering to values (of the target groups) is a general suggestion for success in any business, a focus on those that are of highest relevance and crisis-resistant is advised for based on the results found here.

In addition, we found that in a pandemic situation, customer satisfaction may not completely depend on the marketing mix and its composition but can be overruled by what is legally possible (external dimension) and clients’ gratefulness for enjoying the opportunity of vacations as such, since these were long forbidden due to the lockdowns. Especially, the qualitative data showed that—at least in the short term—things are different from before: the product itself receives a higher status for the clients and satisfaction is reached quicker. Sustainable business models needed not to be very innovative, which, however, may change in the future [85]. Offer structures that seem sustainable at first sight—health tourism—which was allowed under certain conditions after the first lockdown—did not necessarily lead to the economic success of specialized accommodations due to the cancellations of clients and other requirements for state aids.

In the Appendix A, the findings and theoretical foundations are combined in a framework that summarizes key success factors mentioned in the literature (i.e., [39]). Filtering these using a client-centered focus led to the following facets and their elements: temporal aspects (season and weather), destination infrastructure (attractiveness, availability, accessibility), accommodation (demographic aspects, marketing mix, guest type, staff, cost structure). For the destination itself, the ideal configuration of the outlined elements depends on its geographical size, the revenue generated by tourism, as well as likely also the number of inhabitants and those working in tourism or related

branches. In the first stage of resilience (absorption), municipalities with a lower number of inhabitants were rather successful in the summer season in Tyrol, which may indicate that they are perceived as safer because they are less crowded, and therefore, a lower risk of infection with the SARS-CoV-2 virus may be assumed. Revenues and incomes result in taxes and economic stability but also define the starting points of over-tourism and overdependence on tourism.

The internal dilemma of planning for accommodation structures is characterized by the interdependence of cost structures, booking patterns, and personnel requirements. Depending on what is booked when by whom, strategic and operative personnel planning is possible, and costs are predictable. In a pandemic context, however, destination-external political decisions guide booking patterns. In case travel bans lead to a (massive) cut in booking numbers, contract specifications with suppliers and personnel determine the organization's leeway to cut costs and financial support by the government, if available. State interventions strengthen absorptive capacity and therefore engineering resilience. Thus, a balance is still possible, and an increased focus on the domestic market can enable stabilizing effects [91,92].

Our analysis provides a framework of resilience that allows for specifically investigating and differentiating destination characteristics in global health crises. The model might not only be applicable for the latter but also for analyzing destination attractiveness for health-risk-averse clients. While design, including nature, is rather place dependent, investing in wellness and family-oriented activities provides ways to increase the absorptive capacity in terms of resilience for most destinations, just as it leads to increasing the fit of the promotional activities. For a short-term oriented resilience, the offer would need to be in place before the occurrence of the shock. Adapting the portfolio might require more investment in promotion activities which needs to be balanced by adequate returns in the long run and thus needs to be carefully weighed depending on the estimated duration of the (health-related) crisis.

#### 4.1. Limitations

As highlighted throughout the paper, the reference number employed is overnight stays. However, depending on state aid, high losses may not automatically result in economic problems for the destinations in the short run. The amount may even be the reason for not opening a hotel (to decrease variable costs), which is causally connected to reduced overnight stays. Nevertheless, sectoral interdependencies and time may lead to different conclusions that need to be uncovered. Interrelationships can also be positive and increase a destination's internal sustainability, for example, by improving the local infrastructure and thus staying attractive for the local population, avoiding rural exodus, nudging innovation, reducing over tourism, and so on.

In addition, the reported renovations, together with our own cautiousness and lack of personnel, might have led to decisions to avoid working at full capacity in summer 2020, which would also make more pronounced reductions in overnight stays a strategic aim and not a loss. Requiring financial reserves, this may be more likely for organizations in municipalities with previously very high overnight numbers ('tourism hotspots'). Thus, during the first summer season within the pandemic, the image as a tourism hotspot seems problematic based on the data, but the reasons and developments need further investigation.

We empirically studied two regions (North and South Tyrol) with specific cultural, historical, and (crisis-related) regulatory peculiarities. Thus, a generalization of the findings for regions with very different characteristics and preconditions must be viewed critically. However, being regions highly reliant on tourism and thus pressed to react with few immediate possibilities, the paper offers important insights into first stage coping successes.

#### 4.2. Future Research Requirements

There are some suggestions in the literature regarding pandemic-induced changes in the tourism sector, especially related to the increased shortage of personnel and importance of human resource management (see, for example, Baum et al., 2020), focus on digitalization [93,94], higher importance of hygiene [93–96] as well as health and well-being [94]. As expectations of managers regarding required measures [93,95,97], these elements cover all 7Ps of the marketing mix, and their impact needs to be investigated over time. This is necessary, as our results indicate that their relevance may depend on the phase and type of resilience researched and location [92,98]. As regional efforts may play a vital role [41], destinations with less dependence on tourism need to be investigated.

In this paper, we focused on municipalities with a very marked focus on tourism and as a more pronounced impact of the pandemic could be expected there, with a higher pressure to react. While less touristy municipalities are likely to experience fewer losses in overnight stays, they and their ecosystem might not be completely self-reliant but rather be impacted by interdependencies. Moreover, they might have more potential to increase the number of overnight stays and/or might be more sought after because they are less populated and thus considered safer by tourists—fewer people indicate a lower risk for infection [99]. Nevertheless, distance rules require more spacious areas within accommodation structures, potentially favoring higher class hotels. Future research should thus also incorporate tourist motives for post-pandemic destination choice and differentiate between sources utilized for information. Campsites offering more luxury and high booking flexibility might become much sought after. How different accommodations promote their offers and whether, for example, they try to compensate for or add to the destination marketing professionalism, is interesting in this context. As this paper has shown, a concise marketing mix and corresponding client communication can alleviate pandemic-induced economic shocks.

**Author Contributions:** Conceptualization, E.N. and M.H.; methodology, E.N., M.H., P.C., S.A. and R.S.; software, E.N., M.H. and S.A., validation, E.N., M.H., P.C., S.A. and R.S.; formal analysis, E.N., M.H., P.C., S.A. and R.S.; investigation, E.N., M.H., P.C., S.A. and R.S.; data curation, E.N., M.H., P.C., S.A. and R.S.; writing—original draft preparation, E.N., M.H., P.C. and S.A.; writing—review and editing, E.N., M.H. and P.H.; visualization, E.N., M.H., P.C., S.A. and R.S.; supervision, E.N. and R.S.; project administration, E.N.; funding acquisition, P.H. All authors have read and agreed to the published version of the manuscript.

**Funding:** The APC was funded by Division for Management in Health and Sport Tourism, UMIT Tirol—Private University for Health Sciences, Medical Informatics and Technology.

**Institutional Review Board Statement:** The interviewees participated based on informed consent and are not identifiable. An ethical review is not required based on Austrian regulations nor institutional guidelines. This is confirmed by the institutional review board (RCSEQ—Research Committee for Scientific Ethical Questions (UMIT Tirol/fhg).

**Informed Consent Statement:** Informed consent was obtained from all subjects involved in the study.

**Data Availability Statement:** Publicly available datasets were analyzed in this study. These data can be found here: NT: <https://www.tirol.gv.at/statistik-budget/statistik/tourismus/#c76985> (accessed on 30 August 2022). ST: <https://qlikview.services.siag.it/QvAJAXZfc/opendoc.htm?document=Tourismus.qvw&host=QVS%40titan-a&anonymous=true>] (accessed on 30 August 2022).

**Acknowledgments:** The authors wish to thank the student group supervised by R.S. for their assistance especially with the Website Analysis. Moreover, the authors express their thanks to all colleagues involved in the initial discussions of the project idea.

**Conflicts of Interest:** The authors declare no conflict of interest.

## Appendix A

The framework below summarizes the findings. In addition to briefly describing the elements, they are related to a pandemic situation. These are described in more detail below in the table. The extensiveness of the framework allows for thematic analysis and for detecting the pandemic specifics, which addresses the research gap.

**Table A1.** Framework.

Facet	Description of Facet	Facet Element	Description of Facet Element	Relevance in a Pandemic Situation
Infrastructural Factors: Destination Infrastructure	Contextual factors influencing the touristic potential regarding a destination's infrastructure can be subdivided into three aspects: its attractiveness, availability, and accessibility.	Attractiveness	The general attractiveness is defined by the image of the destination, which is dependent on the number and type of tourists per year/season and the touristic ecosystem available: shopping possibilities, tourism infrastructure (bars, restaurants), leisure facilities (golf court, amusement park, horseback riding facilities . . . ), and other attractions or regions to visit in the proximity. It is important to note here that general attractiveness might not automatically lead to a high number of overnight stays in case the number of secondary residences is high.	The attractiveness of a destination is connected to its perceived health-related safety level in a pandemic situation, leading to a higher demand of overnight stays in less populated rural areas. In addition, destinations providing outdoor activities, especially for families, were well booked. As children suffered intensively during the lockdown, families might have tried to compensate the negative effects by purposefully opting for these destinations.
		Availability	Availability is characterized by the size of the destination (number of beds in the required categories) and temporal aspects. Some destinations are tightly connected to specific activities only possible in certain seasons and/or weather conditions.	During a pandemic situation, availability depends on which accommodations are not (voluntary and involuntary) closed and which types of activities are not banned. Medical rehabilitation and regeneration programs, for example, were allowed in Northern Tyrol except during the first lockdown.
		Accessibility	The accessibility of a destination refers to how easy it can be reached, from where, and (explored) by whom. This factor refers to classical travel infrastructure but also to the specific requirements of guests with special needs.	In a pandemic context, accessibility depends on travel bans based on regional classifications of dangerous areas.
Accommodation Level Factors	On the accommodation level, we distinguish three groups of stakeholders: owners, employees, and clients (guests, tourists). While the factors that influence resilience in a crisis such as a pandemic are interdependent, some are of more relevance for a specific group, and some are generic.	Demographic aspects	Demographic aspects are generic and comprise size, age, category, location, physical accessibility, and type of booking accepted (online/calls/platform/ . . . ).	In the pandemic, rather remote areas were preferred, which is most likely because they are considered safer. In addition, camping, which provides the highest possible flexibility of quickly leaving a place, was more popular.

Table A1. Cont.

Facet	Description of Facet	Facet Element	Description of Facet Element	Relevance in a Pandemic Situation
		Marketing mix The most important element of the marketing mix (price, product, promotion, placement, people (employees), physical surrounding, and process) is the type of the offer.	The offer design is of major interest for the clients, but it also needs to be staffed with the right people and profitable, thus attractive enough. PR activities promoting the offer need to take specifics regarding target groups into account and must have a certain degree of professionalism. In North and South Tyrol, bus tourism, sports tourism (incl. training of teams), health tourism, individual tourism (family, couples, tourists/business travel), business travel (incl. further education/seminars), and city trips are of relevance. Depending on the focus of the hotel, it was more affected by the pandemic regulations.	During the pandemic and partly even the hard lockdowns, specific health-related tourism was allowed. However, since accommodations with this specific offer were not forced to close, they also received no state funding. Regulations also allowed food delivery offers that could generate extra income for hotels with sufficient kitchen facilities (and guaranteed employee safety). The classic four Ps seem to be the most relevant in the absorption state, with price slightly less important than the other Ps.
		Type of guest	Depending on whether an accommodation relies on regular guests or not, their typical countries of origin, socioeconomic status, needs, and travel motives, the marketing mix needs to be adapted	In a pandemic context, fear may be a strong motive to decide against traveling, making emotion management highly relevant in marketing efforts. This could be addressed, for example, by stressing the hygiene rules that are followed or by highlighting the availability of self-catering apartments. However, there may be a higher homogeneity in simply being happy to be on holiday. Adapting cancellation strategies can help guests feel safer.
		Staff	As tourism is very service-centered, trained staff is vital. Thus, the availability of (qualified) employees in the region, their attraction, training, and retention are vital, especially if local personnel is required. Otherwise, staff need to be attracted from other areas and countries.	Mentioned as (potential) shortage factor in a (continuing) pandemic situation, and as a group highly impacted by forced closures. Employee retention strategies are highlighted.
		Cost structure	Resilient economic success is only feasible with a sound cost structure. In tourism, this depends very much on the level of fixed costs (infrastructure, personnel, long-term contracts with suppliers), which is determined by the general offer design.	In a pandemic context, governmental financial support, insurances, and reserves can be used to balance reductions in cash flow. All factors that increase the level of organizational control over the cost structure, booking patterns and personnel requirements, thus alleviating the dilemma of planning, lead to higher resilience.



Due to the focus on the summer season, temporal aspects proved to be largely irrelevant in this paper.

## References

- Nooripoor, M.; Khosrowjerdi, M.; Rastegari, H.; Sharifi, Z.; Bijani, M. The role of tourism in rural development: Evidence from Iran. *GeoJournal* **2020**, *86*, 1705–1719. [CrossRef]
- Cicin-Sain, B. Conserve and sustainably use the oceans, seas and marine resources for sustainable development. *UN Chron.* **2015**, *51*, 32–33. [CrossRef]
- Glowka, G.; Zehrer, A. Tourism Family-Business Owners' Risk Perception: Its Impact on Destination Development. *Sustainability* **2019**, *11*, 6992. [CrossRef]
- Khosrojerdi, M.; Nooripoor, M. Identifying rural tourism development strategies for Doroodzan District: The integration of strategic planning and Artificial Neural Network techniques. *J. Spat. Plan.* **2017**, *21*, 167–196.
- Singal, M. How is the hospitality and tourism industry different? An empirical test of some structural characteristics. *Int. J. Hosp. Manag.* **2015**, *47*, 116–119. [CrossRef]
- Zhong, L.; Sun, S.; Law, R.; Li, X. Tourism crisis management: Evidence from COVID-19. *Curr. Issues Tour.* **2021**, *24*, 2671–2682. [CrossRef]
- Ritchie, B.W. Chaos, crises and disasters: A strategic approach to crisis management in the tourism industry. *Tour. Manag.* **2004**, *25*, 669–683. [CrossRef]
- Law, R. The perceived impact of risks on travel decisions. *Int. J. Tour. Res.* **2006**, *8*, 289–300. [CrossRef]
- Breitsohl, J.; Garrod, B. Assessing tourists' cognitive, emotional and behavioural reactions to an unethical destination incident. *Tour. Manag.* **2016**, *54*, 209–220. [CrossRef]
- Stotten, R.; Maurer, M.; Herrmann, H.; Schermer, M. Different Forms of Accommodation in Agritourism: The Role of Decoupled Farmer-Based Accommodation in the Ötztal Valley (Austria). *Sustainability* **2019**, *11*, 2841. [CrossRef]
- UNISDR. International Strategy for Disaster Reduction. Available online: <https://www.undrr.org/terminology/resilience> (accessed on 27 May 2021).
- Carpenter, S.; Walker, B.; Anderies, J.M.; Abel, N. From metaphor to measurement: Resilience of what to what? *Ecosystems* **2001**, *4*, 765–781. [CrossRef]
- Flagestad, A.; Hope, C.A. Strategic success in winter sports destinations: A sustainable value creation perspective. *Tour. Manag.* **2001**, *22*, 445–461. [CrossRef]
- Sainaghi, R. From contents to processes: Versus a dynamic destination management model (DDMM). *Tour. Manag.* **2006**, *27*, 1053–1063. [CrossRef]
- Walker, B.H.; Carpenter, S.R.; Rockstrom, J.; Crépin, A.-S.; Peterson, G.D. Drivers, “slow” variables, “fast” variables, shocks, and resilience. *Ecol. Soc.* **2012**, *17*, 30. [CrossRef]
- Lew, A.A. Scale, change and resilience in community tourism planning. *Tour. Geogr.* **2014**, *16*, 14–22. [CrossRef]
- Espiner, S.; Orchiston, C.; Higham, J. Resilience and sustainability: A complementary relationship? Towards a practical conceptual model for the sustainability–resilience nexus in tourism. *J. Sustain. Tour.* **2017**, *25*, 1385–1400. [CrossRef]
- Béné, C.; Wood, R.G.; Newsham, A.; Davies, M. Resilience: New utopia or new tyranny? Reflection about the potentials and limits of the concept of resilience in relation to vulnerability reduction programmes. *IDS Work. Pap.* **2012**, *2012*, 1–61. [CrossRef]
- De Roo, G.; Hillier, J. Spatial planning, complexity and a world ‘out of equilibrium’: Outline of a non-linear approach to planning. In *Complexity and Planning*; Routledge: London, UK, 2016; pp. 159–194.
- Basurto-Cedeño, E.M.; Pennington-Gray, L. An applied destination resilience model. *Tour. Rev. Int.* **2018**, *22*, 293–302. [CrossRef]
- Folke, C. Resilience: The emergence of a perspective for social–ecological systems analyses. *Glob. Environ. Change* **2006**, *16*, 253–267. [CrossRef]
- Luthe, T.; Wyss, R. Assessing and planning resilience in tourism. *Tour. Manag.* **2014**, *44*, 161–163. [CrossRef]
- Scuttari, A.; Corradini, P. Multidisciplinary approaches to resilience in tourism destination studies: A conceptual framework. In *Destination Resilience*; Routledge: London, UK, 2018; pp. 33–48.
- Cutter, S.L.; Barnes, L.; Berry, M.; Burton, C.; Evans, E.; Tate, E.; Webb, J. A place-based model for understanding community resilience to natural disasters. *Glob. Environ. Change* **2008**, *18*, 598–606. [CrossRef]
- Worldometer. COVID-19 Coronavirus CASES. Available online: <https://www.worldometers.info/coronavirus/coronavirus-cases/#case-distribution> (accessed on 1 June 2022).
- Sainaghi, R.; Baggio, R. Complexity traits and dynamics of tourism destinations. *Tour. Manag.* **2017**, *63*, 368–382. [CrossRef]
- Altig, D.; Baker, S.; Barrero, J.M.; Bloom, N.; Bunn, P.; Chen, S.; Davis, S.J.; Leather, J.; Meyer, B.; Mihaylov, E. Economic uncertainty before and during the COVID-19 pandemic. *J. Public Econ.* **2020**, *191*, 104274. [CrossRef] [PubMed]
- Elmo, G.C.; Arcese, G.; Valeri, M.; Poponi, S.; Pacchera, F. Sustainability in tourism as an innovation driver: An analysis of family business reality. *Sustainability* **2020**, *12*, 6149. [CrossRef]
- Alonso, A.D.; Kok, S.K.; Bressan, A.; O’Shea, M.; Sakellarios, N.; Koresis, A.; Solis, M.A.B.; Santoni, L.J. COVID-19, aftermath, impacts, and hospitality firms: An international perspective. *Int. J. Hosp. Manag.* **2020**, *91*, 102654. [CrossRef]
- Sigala, M. Tourism and COVID-19: Impacts and implications for advancing and resetting industry and research. *J. Bus. Res.* **2020**, *117*, 312–321. [CrossRef] [PubMed]

31. Wolfe Sr, M.J.; Crotts, J.C. Marketing mix modeling for the tourism industry: A best practices approach. *Int. J. Tour. Sci.* **2011**, *11*, 1–15. [CrossRef]
32. Kwok, L.; Tang, Y.; Yu, B. The 7 Ps marketing mix of home-sharing services: Mining travelers' online reviews on Airbnb. *Int. J. Hosp. Manag.* **2020**, *90*, 102616. [CrossRef]
33. McCarthy, E.J.; Shapiro, S.J.; Perreault, W.D. *Basic Marketing*; Irwin-Dorsey: Georgetown, ON, Canada, 1979.
34. Booms, B.H.; Bitner, M.J. New management tools for the successful tourism manager. *Ann. Tour. Res.* **1980**, *7*, 337–352. [CrossRef]
35. Pomeroy, A.; Noble, G.; Johnson, L.W. Conceptualising a contemporary marketing mix for sustainable tourism. *J. Sustain. Tour.* **2011**, *19*, 953–969. [CrossRef]
36. Wickham, M. Thana-marketing strategy: Exploring the 8Ps that dare not speak their name. *Int. J. Bus. Strategy* **2009**, *9*, 194–201.
37. Salman, D.; Tawfik, Y.; Samy, M.; Artal-Tur, A. A new marketing mix model to rescue the hospitality industry: Evidence from Egypt after the Arab Spring. *Future Bus. J.* **2017**, *3*, 47–69. [CrossRef]
38. Hiransomboon, K. Marketing mix affecting accommodation service buying decisions of backpacker tourist traveling at Inner Rattanakosin Island in Bangkok, Thailand. *Procedia Econ. Financ.* **2012**, *3*, 276–283. [CrossRef]
39. Calgaro, E.; Lloyd, K.; Dominey-Howes, D. From vulnerability to transformation: A framework for assessing the vulnerability and resilience of tourism destinations. *J. Sustain. Tour.* **2014**, *22*, 341–360. [CrossRef]
40. Hall, C.M. *Tourism Planning: Policies, Processes and Relationships*; Pearson Education: London, UK, 2008.
41. Fusté-Forné, F.; Michael, N. Limited tourism: Travel bubbles for a sustainable future. *J. Sustain. Tour.* **2021**, 1–18. [CrossRef]
42. Filimonau, V.; De Coteau, D. Tourism resilience in the context of integrated destination and disaster management (DM2). *Int. J. Tour. Res.* **2020**, *22*, 202–222. [CrossRef]
43. Font, X.; McCabe, S. Sustainability and marketing in tourism: Its contexts, paradoxes, approaches, challenges and potential. *J. Sustain. Tour.* **2017**, *25*, 869–883. [CrossRef]
44. Czarnecki, A.; Dacko, A.; Dacko, M. Changes in mobility patterns and the switching roles of second homes as a result of the first wave of COVID-19. *J. Sustain. Tour.* **2021**, 1–19. [CrossRef]
45. Patton, M.Q. *Qualitative Research and Evaluation Methods*, 3rd ed.; Sage Publications: Thousand Oaks, CA, USA, 2002.
46. Patton, M.Q. *Qualitative Research & Evaluation Methods: Integrating Theory and Practice*, 4th ed.; Sage Publications: Thousand Oaks, CA, USA, 2015.
47. Nomm, A.H.L.; Albrecht, J.N.; Lovelock, B. Advocacy and community leadership as functions in national and regional level destination management. *Tour. Manag. Perspect.* **2020**, *35*, 100682. [CrossRef]
48. Albrecht, J.N.; Haid, M.; Finkler, W.; Heimerl, P. What's in a name? The meaning of sustainability to destination managers. *J. Sustain. Tour.* **2022**, *30*, 32–51. [CrossRef]
49. Queiros, D.; Mearns, K. Khanyayo village and Mkhambathi Nature Reserve, South Africa: A pragmatic qualitative investigation into attitudes towards a protected area. *J. Sustain. Tour.* **2019**, *27*, 750–772. [CrossRef]
50. Quendler, E. The position of the farm holiday in Austrian tourism. *Open Agric.* **2019**, *4*, 697–711. [CrossRef]
51. Dupeyras, A.; MacCallum, N. Indicators for Measuring Competitiveness in Tourism: A Guidance Document. 2013. Available online: <https://www.oecd.org/cfe/tourism/indicators%20for%20measuring%20competitiveness%20in%20tourism.pdf> (accessed on 28 September 2022).
52. Transparent Administration. Did You Know? Available online: <https://www.europaregion.info/en/euregio/about-us/did-you-know/> (accessed on 19 October 2022).
53. Wirtschaftskammer\_Tirol. Die Treibende Wirtschaftskraft. Available online: [https://www.wko.at/branchen/t/tourismus-freizeitwirtschaft/Tourismusbroschuere2015\\_3.pdf](https://www.wko.at/branchen/t/tourismus-freizeitwirtschaft/Tourismusbroschuere2015_3.pdf) (accessed on 12 November 2020).
54. Kallmuenzer, A.; Nikolakis, W.; Peters, M.; Zanon, J. Trade-offs between dimensions of sustainability: Exploratory evidence from family firms in rural tourism regions. *J. Sustain. Tour.* **2018**, *26*, 1204–1221. [CrossRef]
55. Land Tirol. Tourismus in Tirol. Available online: <https://www.tirol.gv.at/statistik-budget/statistik/tourismus/> (accessed on 24 February 2021).
56. Tourismuspresse. Staeadtetourismus von COVID-19 Besonders Betroffen. Available online: [https://www.tourismuspresse.at/presseaussendung/TPT\\_20200409\\_TPT0004/staedtetourismus-von-covid-19-besonders-betroffen](https://www.tourismuspresse.at/presseaussendung/TPT_20200409_TPT0004/staedtetourismus-von-covid-19-besonders-betroffen) (accessed on 15 December 2020).
57. Raich, F. *Governance Räumlicher Wettbewerbseinheiten: Ein Ansatz für die Tourismus-Destination*; Springer: New York, NY, USA, 2006.
58. ISTAT—Italian National Institute of Statistics. Main Spatial Aggregates of the Italian National Account: Value Added by Activity Branch. 2022. Available online: <http://dati.istat.it/viewhtml.aspx?il=blank&vh=0000&vf=0&vcq=1100&graph=0&view-metadata=1&lang=it&QueryId=11479#> (accessed on 18 October 2022).
59. Adams, J.; Bateman, B.; Becker, F.; Cresswell, T.; Flynn, D.; McNaughton, R.; Oluboyede, Y.; Robalino, S.; Ternent, L.; Sood, B.G.; et al. Effectiveness and acceptability of parental financial incentives and quasi-mandatory schemes for increasing uptake of vaccinations in preschool children: Systematic review, qualitative study and discrete choice experiment. *Health Technol. Assess.* **2015**, *19*, 1–176. [CrossRef]
60. O'Cathain, A.; Murphy, E.; Nicholl, J. Three techniques for integrating data in mixed methods studies. *BMJ* **2010**, *341*, c4587. [CrossRef]
61. Creswell, J.W. *Qualitative Inquiry and Research Design: Choosing among Five Traditions*; Sage Publications, Inc.: Thousand Oaks, CA, USA, 1998; p. xv, 403.

62. ASTAT. Tourism in South Tyrol. Available online: <https://qlikview.services.sdiag.it/QvAJAXZfc/opendoc.htm?document=Tourismus.qvw&host=QVS%40titan-a&anonymous=true> (accessed on 27 May 2021).
63. Amt der Tiroler Landesregierung. Der Tourismus im Sommer. Available online: [https://www.tirol.gv.at/fileadmin/themen/statistik-budget/statistik/downloads/Tourismus/Der\\_Tourismus\\_im\\_Sommer\\_2020.pdf](https://www.tirol.gv.at/fileadmin/themen/statistik-budget/statistik/downloads/Tourismus/Der_Tourismus_im_Sommer_2020.pdf) (accessed on 10 June 2021).
64. Tirol Tourism Research. Sommersaison 2020. Available online: <https://www.ttr.tirol/statistik/archiv/sommersaison-2020> (accessed on 1 June 2021).
65. O'Connor, C.; Joffe, H. Intercoder reliability in qualitative research: Debates and practical guidelines. *Int. J. Qual. Methods* **2020**, *19*, 1609406919899220. [CrossRef]
66. Mayring, P. Qualitative Content Analysis: Theoretical Background and Procedures. In *Approaches to Qualitative Research in Mathematics Education: Examples of Methodology and Methods*; Bikner-Ahsbals, A., Knipping, C., Presmeg, N., Eds.; Springer: Dordrecht, The Netherlands, 2015; pp. 365–380.
67. Charmaz, K. *Constructing Grounded Theory: A Practical Guide Through Qualitative Analysis*; Sage: Thousand Oaks, CA, USA, 2006.
68. Glaser, B.G.; Strauss, A.L. *The Discovery of Grounded Theory: Strategies for Qualitative Research*; Routledge: London, UK, 2017.
69. Mayring, P. Qualitative content analysis. *Forum Qual. Soc. Res.* **2000**, *1*. Available online: <https://www.qualitative-research.net/index.php/fqs/article/view/1089/2385> (accessed on 28 September 2022).
70. McHugh, M.L. Interrater reliability: The kappa statistic. *Biochem. Med.* **2012**, *22*, 276–282. [CrossRef]
71. Witzel, A. The Problem-Centered Interview. *Forum Qual. Soc. Res.* **2000**, *1*, 9.
72. Zhang, Y.; Wildemuth, B.M. Unstructured interviews. In *Applications of Social Research Methods to Questions in Information and Library Science*; Wildemuth, B.M., Ed.; Libraries Unlimited: Santa Barbara, CA, USA, 2017; pp. 239–247.
73. Teddlie, C.; Yu, F. Mixed Methods Sampling: A Typology With Examples. *J. Mix. Methods Res.* **2007**, *1*, 77–100. [CrossRef]
74. Maxwell, J.A. Designing a qualitative study. In *Handbook of Applied Social Research Methods*; Sage Publications, Inc.: Thousand Oaks, CA, USA, 1998; pp. 69–100.
75. Flick, U. *An Introduction to Qualitative Research*; Sage: Thousand Oaks, CA, USA, 1998.
76. Guest, G.; Bunce, A.; Johnson, L. How Many Interviews Are Enough?: An Experiment with Data Saturation and Variability. *Field Methods* **2006**, *18*, 59–82. [CrossRef]
77. McLellan, E.; MacQueen, K.M.; Neidig, J.L. Beyond the Qualitative Interview: Data Preparation and Transcription. *Field Methods* **2003**, *15*, 63–84. [CrossRef]
78. Gu, Y.; Onggo, B.S.; Kunc, M.H.; Bayer, S. Small Island Developing States (SIDS) COVID-19 post-pandemic tourism recovery: A system dynamics approach. *Curr. Issues Tour.* **2021**, *25*, 1481–1508. [CrossRef]
79. Gössling, S.; Scott, D.; Hall, C.M. Pandemics, tourism and global change: A rapid assessment of COVID-19. *J. Sustain. Tour.* **2021**, *29*, 1–20. [CrossRef]
80. Bellini, N.; Grillo, F.; Lazzeri, G.; Pasquinelli, C. Tourism and regional economic resilience from a policy perspective: Lessons from smart specialization strategies in Europe. *Eur. Plan. Stud.* **2017**, *25*, 140–153. [CrossRef]
81. Sharma, G.D.; Thomas, A.; Paul, J. Reviving tourism industry post-COVID-19: A resilience-based framework. *Tour. Manag. Perspect.* **2021**, *37*, 100786. [CrossRef] [PubMed]
82. Kaushal, V.; Srivastava, S. Hospitality and tourism industry amid COVID-19 pandemic: Perspectives on challenges and learnings from India. *Int. J. Hosp. Manag.* **2021**, *92*, 102707. [CrossRef]
83. Shi, F.; Shi, D.; Weaver, D.; Chavez, C.E.S. Adapt to not just survive but thrive: Resilience strategies of five-star hotels at difficult times. *Int. J. Contemp. Hosp. Manag.* **2021**, *33*, 2886–2906. [CrossRef]
84. Sobaih, A.E.E.; Elshaer, I.; Hasanein, A.M.; Abdelaziz, A.S. Responses to COVID-19: The role of performance in the relationship between small hospitality enterprises' resilience and sustainable tourism development. *Int. J. Hosp. Manag.* **2021**, *94*, 102824. [CrossRef]
85. Breier, M.; Kallmuenzer, A.; Clauss, T.; Gast, J.; Kraus, S.; Tiberius, V. The role of business model innovation in the hospitality industry during the COVID-19 crisis. *Int. J. Hosp. Manag.* **2021**, *92*, 102723. [CrossRef]
86. Neise, T.; Verfürth, P.; Franz, M. Rapid responding to the COVID-19 crisis: Assessing the resilience in the German restaurant and bar industry. *Int. J. Hosp. Manag.* **2021**, *96*, 102960. [CrossRef]
87. Kuščer, K.; Eichelberger, S.; Peters, M. Tourism organizations' responses to the COVID-19 pandemic: An investigation of the lockdown period. *Curr. Issues Tour.* **2021**, *25*, 247–260. [CrossRef]
88. Bennett, N.; Lemoine, G.J. What a difference a word makes: Understanding threats to performance in a VUCA world. *Bus. Horiz.* **2014**, *57*, 311–317. [CrossRef]
89. Martin, R. Regional economic resilience, hysteresis and recessionary shocks. *J. Econ. Geogr.* **2012**, *12*, 1–32. [CrossRef]
90. Binter, U.; Ferjan, M.; Neves, J.V. Marketing mix and tourism destination image: The study of destination bled, Slovenia. *Organizacija* **2016**, *49*, 209–223. [CrossRef]
91. Jin, X.; Bao, J.; Tang, C. Profiling and evaluating Chinese consumers regarding post-COVID-19 travel. *Curr. Issues Tour.* **2021**, *25*, 745–763. [CrossRef]
92. Neuburger, L.; Egger, R. Travel risk perception and travel behaviour during the COVID-19 pandemic 2020: A case study of the DACH region. *Curr. Issues Tour.* **2021**, *24*, 1003–1016. [CrossRef]
93. Bonfanti, A.; Vigolo, V.; Yfantidou, G. The impact of the COVID-19 pandemic on customer experience design: The hotel managers' perspective. *Int. J. Hosp. Manag.* **2021**, *94*, 102871. [CrossRef]

94. Jiang, Y.; Wen, J. Effects of COVID-19 on hotel marketing and management: A perspective article. *Int. J. Contemp. Hosp. Manag.* **2020**, *32*, 2563–2573. [CrossRef]
95. Herédia-Colaço, V.; Rodrigues, H. Hosting in turbulent times: Hoteliers' perceptions and strategies to recover from the COVID-19 pandemic. *Int. J. Hosp. Manag.* **2021**, *94*, 102835. [CrossRef]
96. Pillai, S.G.; Haldorai, K.; Seo, W.S.; Kim, W.G. COVID-19 and hospitality 5.0: Redefining hospitality operations. *Int. J. Hosp. Manag.* **2021**, *94*, 102869. [CrossRef] [PubMed]
97. Garrido-Moreno, A.; García-Morales, V.J.; Martín-Rojas, R. Going beyond the curve: Strategic measures to recover hotel activity in times of COVID-19. *Int. J. Hosp. Manag.* **2021**, *96*, 102928. [CrossRef]
98. Chan, J.; Gao, Y.L.; McGinley, S. Updates in service standards in hotels: How COVID-19 changed operations. *Int. J. Contemp. Hosp. Manag.* **2021**, *33*, 1668–1687. [CrossRef]
99. Li, Y.; Yao, J.; Chen, J. The negative effect of scarcity cues on consumer purchase decisions in the hospitality industry during the COVID-19 pandemic. *Int. J. Hosp. Manag.* **2021**, *94*, 102815. [CrossRef]

## Article

# Structural Model of Community Social Capital for Enhancing Rural Communities Adaptation against the COVID-19 Pandemic: Empirical Evidence from Pujon Kidul Tourism Village, Malang Regency, Indonesia

Gunawan Prayitno <sup>1,\*</sup> , Ainul Hayat <sup>2</sup>, Achmad Efendi <sup>3</sup>, Aidha Auliah <sup>1</sup> and Dian Dinanti <sup>1</sup>

<sup>1</sup> Regional and Urban Planning Department, Faculty of Engineering, Universitas Brawijaya, Malang 65145, Indonesia

<sup>2</sup> Faculty of Administrative Sciences, Universitas Brawijaya, Malang 65145, Indonesia

<sup>3</sup> Department of Statistics, Faculty of Mathematics and Natural Sciences, Universitas Brawijaya, Malang 65145, Indonesia

\* Correspondence: gunawan\_p@ub.ac.id; Tel.: +62-8119694532

**Abstract:** Pujon Kidul Village, Pujon District, Malang Regency, is an area with tourism potential that has been developed since 2017 with the concept of agricultural tourism. Throughout the development of tourism villages, Pujon Kidul Village has succeeded in accelerating economic growth and providing jobs for the community. However, during the COVID-19 pandemic, tourism villages have been severely affected, leading to the temporary closure of tourist attractions and community businesses. This research aimed to identify what indicators form social capital variables and the relationship between social capital variables and community adaptation patterns in dealing with pandemics in the study location. This was quantitative research with confirmatory factor analysis to determine the indicators of forming social capital and structural equation modeling analysis to determine the relationship between the variables. Based on the findings, it is known that trust in forming a social network is 0.468. Furthermore, the social network forms community actions of 0.046 and influences community resilience by 0.007. Therefore, good social capital will make it easier for the community to participate in collective action as a form of caring for each other during the pandemic. This action also influences the community to survive in a pandemic crisis, thus creating an adaptation pattern for the Pujon Kidul Tourism Village community in facing a pandemic.

**Keywords:** social capital; pandemic; collective action; community adaptation; SEM analysis



**Citation:** Prayitno, G.; Hayat, A.; Efendi, A.; Auliah, A.; Dinanti, D. Structural Model of Community Social Capital for Enhancing Rural Communities Adaptation against the COVID-19 Pandemic: Empirical Evidence from Pujon Kidul Tourism Village, Malang Regency, Indonesia. *Sustainability* **2022**, *14*, 12949. <https://doi.org/10.3390/su141912949>

Academic Editors: Zygmunt Kruczek and Bartłomiej Walas

Received: 4 August 2022

Accepted: 4 October 2022

Published: 10 October 2022

**Publisher's Note:** MDPI stays neutral with regard to jurisdictional claims in published maps and institutional affiliations.



**Copyright:** © 2022 by the authors. Licensee MDPI, Basel, Switzerland. This article is an open access article distributed under the terms and conditions of the Creative Commons Attribution (CC BY) license (<https://creativecommons.org/licenses/by/4.0/>).

## 1. Introduction

Since December 2019, the world has been shocked by the outbreak of coronavirus COVID-19; this virus is endemic in almost all parts of the world and has become a hot topic of discussion because of the many deaths it causes worldwide. Since then, the number of COVID-19 cases has increased rapidly and caused a pandemic. Several countries, including Indonesia, have established policies such as social distancing to reduce the high rate of disease transmission [1]. This policy is carried out on a large scale and impacts people's lives in small rural areas. Efforts to deal with pandemics in rural areas can be carried out effectively because of community solidarity [2]. Individual or community solidarity is one of the concepts of social capital used to increase individuals' or communities' capacity for social development [3].

The COVID-19 pandemic impacts not only the economic aspect but also the environment and all aspects of people's lives, especially the social aspects of society [4–6]. Likewise, in the face of the current pandemic crisis, the existence of norms, trust, and social networks to support social capital allows individuals to more easily access various sources such as information, assistance, and other shared resources as a form of support between

communities [7]. Owned social capital will encourage self-awareness to act and sympathize with others [8]. The three elements of social capital, trust, norms, and social networks, become very important in facilitating collective action [9]. Collective action is a condition in which a group of people acts together [9,10]. Collective action can occur because of social capital, which jointly encourages joint action to benefit a society [11]. It can also be said that collective action will succeed if it is based on strong social capital [12–14]

According to Nugraha et al. (2021), the social capital of rural communities encourages collective action to develop agrotourism for sustainable agriculture. The development of agrotourism that involves the community is a form of social capital relationship with collective action [15]. Likewise, Kusumastuti's research (2016) shows social capital as an element that plays a role in building collective action to survive crises. The existence of social capital in rural communities refers to social norms, trust, and social networks that can facilitate collective action to respond to crises [16].

Pujon Kidul Village is one of the areas located in Pujon District, Malang Regency, which has tourism potential by utilizing agriculture, which is supported by the village's geographical location in the highlands [17]. Pujon Kidul Tourism Village was first developed in 2017 with the concept of agricultural tourism and got a first-place award from the ministry of tourism for community business activities in the tourism sector [18]. The development of a tourism village that involves many communities will reflect the social behavior of the village community itself, which shows how the social capital is built between communities, which includes community social relations. [19]. Support from the community by having strong social capital will make it easier to develop tourism in the region [20–22]. Village communities that have social capital will have a sense of ownership of what is in their area. With that sense of ownership, the community will be involved in supporting development in the village [23]. The sense of ownership will also influence the community in finding ways to get involved [24,25]. Throughout the development of tourism villages, Pujon Kidul Village has succeeded in accelerating economic growth and providing jobs for the community. Pujon Kidul Tourism Village has succeeded in increasing the village original income (PADes) every year since the development of tourism villages in 2017 with only Rp. 3,472,132,500 and continued to increase until in 2019 it reached Rp. 17,658,023,447. The significant increase in PADes shows the effect of village tourism activities on improving the village economy.

However, during the COVID-19 pandemic, Pujon Kidul Tourism Village was affected economically, socially, and culturally. The pandemic has led to the elimination of social and cultural activities such as village cleaning, community service, and cultural villages due to the policy of restrictions from the village government. Pujon Kidul Tourism Village also temporarily closed tourist attractions, which resulted in the laying off of tourism workers, as many as 92 rice field cafe workers, and 30 parking attendants, as well as the closure of community businesses [26]. Social capital is believed to be the society's principal capital in solving various life problems [27–29]. Based on the explanation, in dealing with the COVID-19 pandemic, it is crucial to strengthen the social capital of the community as one of the efforts to support the success of collective action, which is manifested in the resilience of the community in the face of the COVID-19 pandemic. Likewise, Pujon Kidul Village has the status of a tourism village that not only involves the village community but also visiting tourists. Therefore, this research is important to learn the factors that form the community social capital and the relationship of social capital with facilitating collective action to create a resilient community in the face of the COVID-19 pandemic in Pujon Kidul Tourism Village.

## 2. Materials and Methods

This study had two objectives: to identify the factors that contribute to the village community's social capital and to describe the role of social capital in facilitating collective action and fostering a resilient community in the face of the COVID-19 pandemic. Based on these two objectives, the variables used in this study were social capital (trust, norms,

and networks), collective action from community initiatives and collective action from the village government, and community resilience.

### 2.1. Data Collection Methods

The primary and secondary data collection methods were used to obtain information and data in this study. The secondary data were obtained from literature and agency studies, the primary data—through questionnaires, interviews, and observations. The sampling method in this study used a population of 1250 households living in Pujon Kidul Village. This study used proportional stratified random sampling, taking samples from the subpopulations in the study population considering their size [30]. The sample in this study was determined based on the table of Isaac and Michael (1981). The sample was determined with a 5% margin of error, yielding a sample of 275 households from the population of 1250 households. The distribution of this sample was spread across three hamlets, namely Maron Hamlet, Tulungrejo Hamlet, and Krajan Hamlet.

### 2.2. Methods of Analysis

This research was conducted using a quantitative approach based on the two research objectives. The first objective was to determine the factors that form social capital using confirmatory factor analysis (CFA). The second objective was to describe the relationship of social capital with collective action and community resilience using structural equation modeling (SEM) analysis.

#### 2.2.1. Confirmatory Factor Analysis (CFA)

Confirmatory factor analysis (CFA) is part of SEM (structural equation modeling) analysis. In the CFA test, validity and reliability tests are carried out on the indicators forming the latent variables of the study, wherein one variable is measured by one or more indicators [31]. The CFA analysis has the following stages [32]:

- a. Performance of the theoretical model development.
- b. Drawing of a path diagram of the relationship between variables and indicators.
- c. Change of the path diagram in the model into equations.
- d. Obtaining model estimate values.
- e. Assessment of the model identification.
- f. Assessment of the goodness-of-fit criteria.

The CFA in this study was conducted to determine whether the indicators for forming community social capital could adequately form the latent variables of social capital (social networks, norms, and trust).

#### 2.2.2. Structural Equation Modelling (SEM)

This study used structural equation modeling (SEM) analysis, which can analyze the relationship between constructs in research, including indicators and latent variables, as well as measure errors in direct measurement [33]. SEM analysis can be performed after confirmatory factor analysis (CFA). In addition, the following steps can be taken for comprehensive modeling in SEM analysis [32]:

- a. Review of the theories, hypotheses, and previous research literature.
- b. Development of theoretical frameworks.
- c. Development of research model specifications.
- d. Determination of research samples and sample measurements.
- e. Performance of parameter estimates.
- f. Performance of goodness-of-fit tests.
- g. Modification of the model.
- h. Development of the discussion, research suggestions, policy implications, and conclusions.



This study used CFA and SEM analysis with AMOS 24 on latent variables and indicators. In addition, this study used SEM to analyze the relationship of the community social capital with collective action during the pandemic in Pujon Kidul Tourism Village.

### 3. Results and Discussion

#### 3.1. Geographical Conditions in Pujon Kidul Tourism Village

Pujon Kidul Village is administratively located in Pujon District, Malang Regency [34] (Figure 1). According to the Pujon Kidul Village Profile (2021), Pujon Kidul Village has an area of 486.40 hectares and is divided into three hamlets, nine community units (RW), and twenty neighboring units (RT). Pujon Kidul Village is located between  $7^{\circ}21'N$  and  $7^{\circ}31'LS$  and  $110^{\circ}10'W$  and  $111^{\circ}40'E$  with the following regional boundaries:

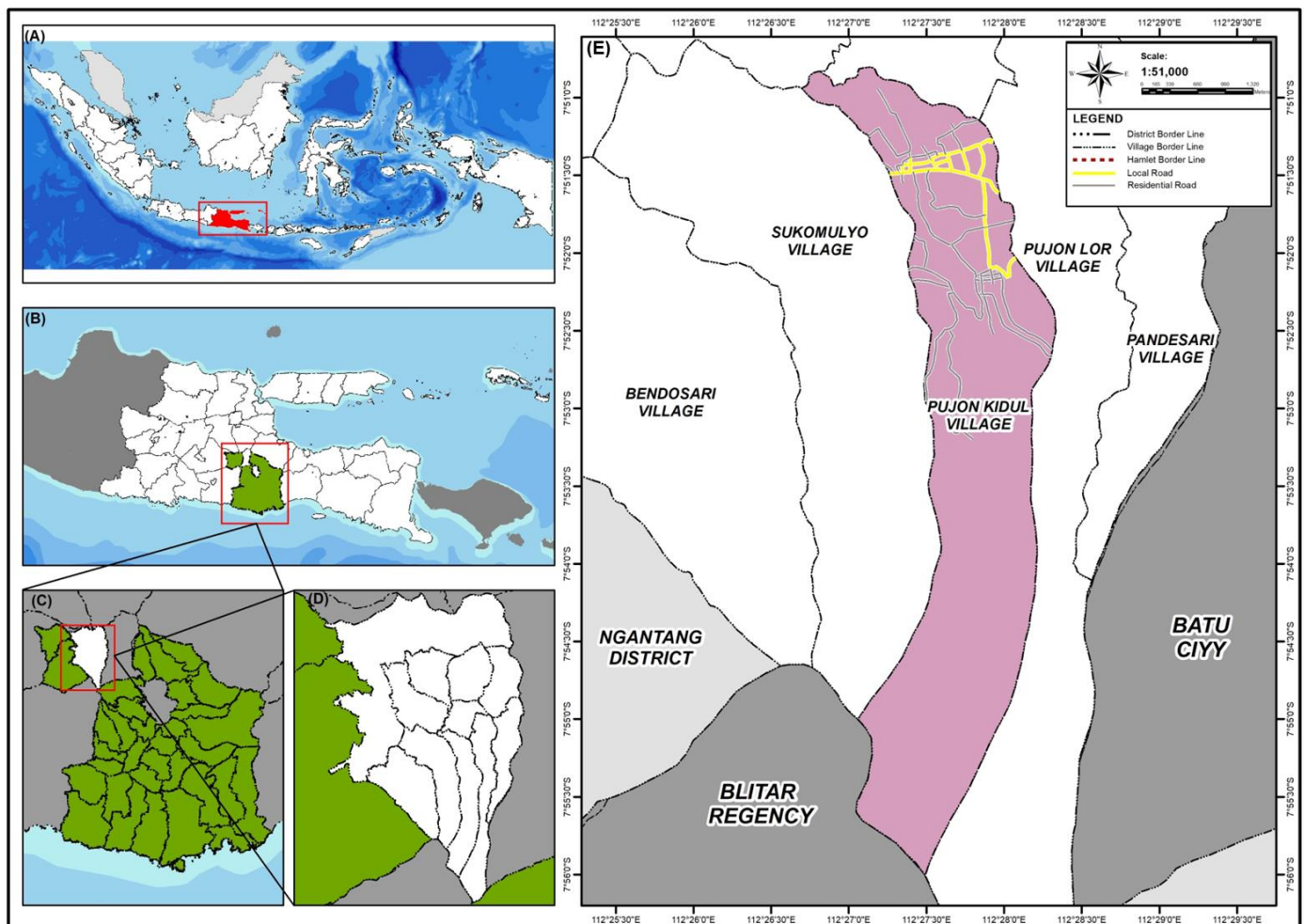

**Figure 1.** Map of the study area (A) East Jawa, Indonesia. (B) Malang Regency, East Jawa. (C) Map of Malang Regency, the highlighted area shows Pujon District. (D) Villages in Pujon District. (E) Map of Pujon Kidul Village.

North: Ngroto Village.  
 South Side: Perhutani Forest.  
 East: Pujon Lor Village.  
 West: Sukomulyo Village.

#### 3.2. Economic Conditions in Pujon Kidul Tourism Village

The main potential of Pujon Kidul Village is in agriculture and plantations; with this potential, the majority of community work is in the agricultural and livestock sectors with



a total of 1730 people. Therefore, this is an opportunity used by the community to become an agriculture-based tourism village with the main tourist object being cafe sawahs. The existence of these tourism activities makes Pujon Kidul Village an agrotourism village and provides an increase in the economy for the community and the village original income (PADes). Therefore, the economy of Pujon Kidul Village is engaged in the agricultural and tourism sectors.

However, the condition of Pujon Kidul Tourism Village during the COVID-19 pandemic is undoubtedly different from before the outbreak. According to the Pujon Kidul Bumdes data (2022), the most visible impact of changes due to the pandemic is a decrease in the number of tourists, which impacts a decrease in income. For example, the number of tourists visiting tourism villages decreased in 2019 by 601,858, decreasing to 418,272 in 2020, 224,162 in 2021, and as many as 99,254 in April 2022. In addition, due to the pandemic, in Pujon Kidul Village, tourist attractions were also closed temporarily due to the policy of implementing community activity restrictions (PPKM) (Figure 2a,b).



**Figure 2.** Empty tourist parking lots due to tourist closures and closed tourist entrances. Source: survey results, 2021.

### 3.3. Explanation of Social Capital Characteristics during the Pandemic in Pujon Kidul Tourism Village

Characteristics of the Pujon Kidul Tourism Village community social capital can be determined based on the choice of answers to the questions addressed to the respondents. The answers are explained and illustrated with descriptive statistics. There were five answer choices for each question given: strongly disagree (SD), disagree (D), moderately agree (MA), agree (A), and strongly agree (SA). The following are indicators that measure social capital:

1. Trust (T). This variable is divided into seven indicators, including trust in neighbors (T1), trust in immigrants (T2), trust in the government (T3), trust in traditional leaders (T4), trust in religious leaders (T5), trust in tourism institutions (T6), and communication between people (T7).
2. Norms (N). This variable is divided into two indicators, including obedience to customs (N1) and attendance at traditional events (N2).
3. Social networks (NW). This variable consists of five indicators, including willingness to build cooperation (NW1), participation in religious activities (NW2), participation in social activities (NW3), willingness to give opinions during meetings (NW4), and participation in community groups (NW5).

Based on the data on social capital characteristics of Pujon Kidul Village in Table 1, it can be seen that the answers from 275 respondents were dominated by choice five, or strongly agree (SA), for the 14 indicators, which means that the people of Pujon Kidul

Village strongly agree with the indicators of trust (K), norms (N), and social networks (J). The detail of the data of respondents is in the supplementary material.

**Table 1.** Characteristics of social capital in Pujon Kidul Tourism Village.

Variable	Indicator	Strongly Disagree (SD) (1)	Disagree (D) (2)	Moderately Agree (MA) (3)	Agree (A) (4)	Strongly Agree (SA) (5)	Mode
Trust	T1	0.36%	0.73%	14.18%	24.73%	60.00%	5
	T2	1.82%	3.27%	22.18%	34.55%	38.18%	5
	T3	0.73%	4.00%	20.73%	33.09%	41.45%	5
	T4	0.73%	1.82%	11.27%	36.36%	49.82%	5
	T5	0.73%	10.18%	17.09%	34.55%	37.45%	5
	T6	0.00%	1.45%	19.27%	32.00%	47.27%	5
	T7	0.00%	7.64%	22.55%	32.73%	37.09%	5
Norms	N1	0.00%	0.00%	9.45%	42.55%	48.00%	5
	N2	0.00%	2.55%	17.82%	41.45%	38.18%	4
Social networks	NW1	0.36%	3.27%	9.09%	39.64%	47.64%	5
	NW2	0.36%	0.36%	27.64%	38.55%	33.09%	4
	NW3	0.36%	3.27%	29.82%	40.36%	26.18%	4
	NW4	0.00%	7.27%	21.09%	33.09%	38.55%	5
	NW5	1.09%	5.45%	20.36%	36.36%	36.73%	5

### 3.4. Explanation of Collective Action Characteristics during the Pandemic in Pujon Kidul Tourism Village

Characteristics of the collective action of the Pujon Kidul Tourism Village community can be determined based on the choice of answers to the questions addressed to the respondents. The answers are explained and illustrated with descriptive statistics. There were five answer choices for each question given: strongly disagree (SD), disagree (D), moderately agree (MA), agree (A), and strongly agree (SA). In addition, the following are indicators that measure collective action:

- a. Collective action from village governments consists of three indicators, including decision-making in taking collective action from the village government (CG1), participation in collective action from the village government (CG2), and frequency of collective action from the village government (CG3)
- b. Collective action from community initiatives consists of three indicators, including decision-making in carrying out collective action from community initiatives (CC1), participation in collective action from community initiatives (CC2), and frequency of taking collective action from community initiatives (CC3).

Based on the data on the characteristics of collective action in Pujon Kidul Village in Table 2, it can be seen that the answers from 275 respondents were dominated by choices three and five. Several types of collective action involving the community dealt with the pandemic in Pujon Kidul Tourism Village.

**Table 2.** Characteristics of collective action in Pujon Kidul Village.

Variable	Indicator	Strongly Disagree (SD) (1)	Disagree (D) (2)	Moderately Agree (MA) (3)	Agree (A) (4)	Strongly Agree (SA) (5)	Mode
Collective action from the village government	CG1	3.27%	12.73%	28.36%	42.18%	13.45%	4
	CG2	3.27%	13.09%	46.18%	26.91%	10.55%	3
	CG3	20.36%	24.36%	35.27%	12.73%	7.27%	3
Collective action from community initiatives	CC1	0.00%	0.00%	21.45%	24.73%	53.82%	5
	CC2	0.00%	11.64%	17.09%	34.18%	37.09%	5
	CC3	3.64%	12.36%	19.64%	30.91%	33.45%	5

The respondents' answer choices are based on the questionnaire results described in Figure 3, illustrating that most respondents were involved in collective action based on the type of action: from the government or from the community. In that case, an action from the community is an action with most respondents often involved. The main difference is that in decision-making, the community more often follows the decision-making of the community's collective action than the decision-making of the collective action of the government. However, even though the community is involved in making decisions for collective action from the community, it is not necessarily the community that participates in taking action from the community, and it is not necessarily the community that participates that takes collective action from the community. Likewise, with collective action from the government (Figure 3), it can be seen that the graph is decreasing for the two types of collective action.

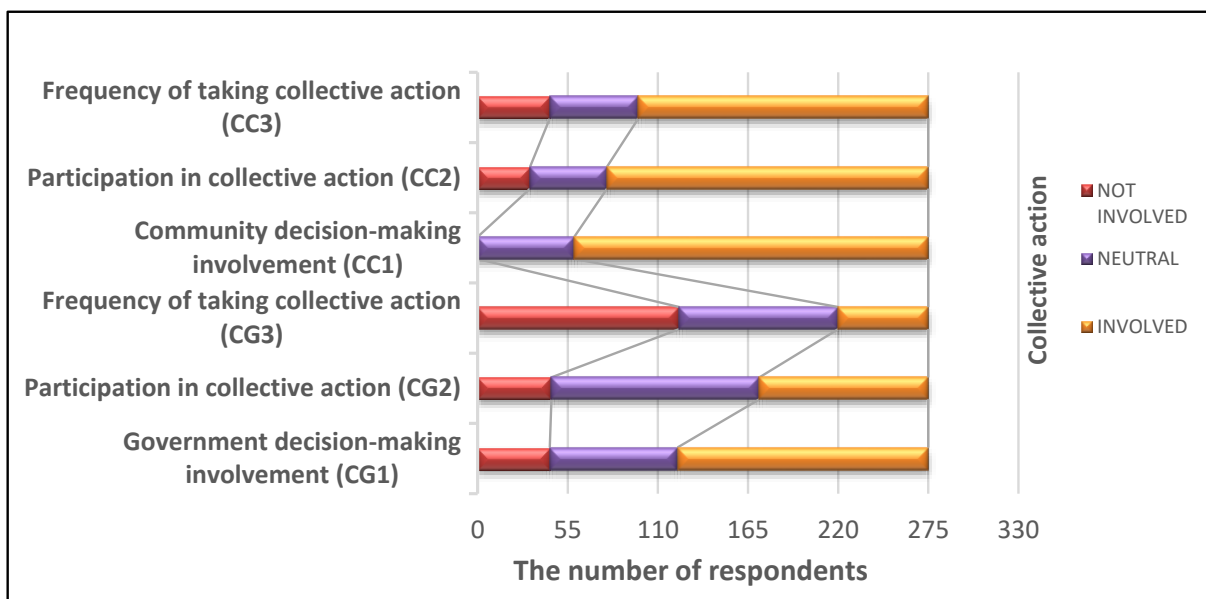
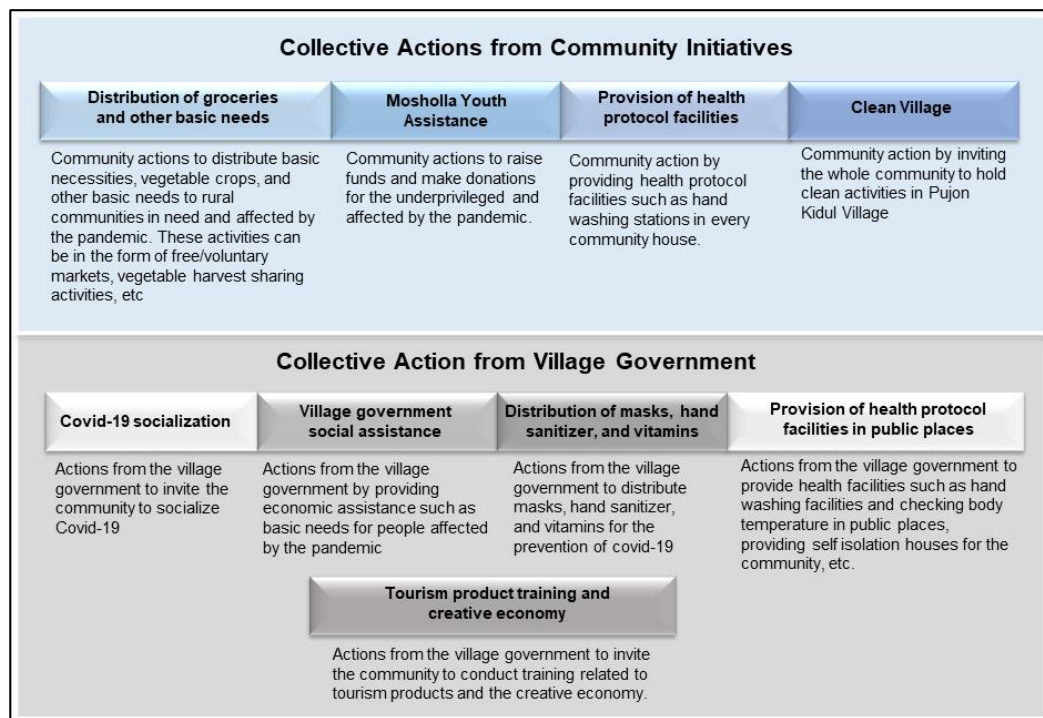

Figure 3. Characteristics of collective action from the government and the community.

The types of activities carried out by the community dealing with COVID-19 are described in Figure 4 in the types of collective action from the community and the government. The community's collective action consists of four activities, while the collective action of the government consists of five activities. Collective action from the community, including distributing necessities and other basic needs, mentoring youth prayer groups, providing health protocol facilities, and cleaning villages, come from community initiatives, while collective action of the village government includes the socialization during the COVID-19 pandemic, social assistance from the village government, distribution of masks, hand sanitizer, and vitamins, procurement of health protocol facilities in public places, and training on tourism products and creative economy.



**Figure 4.** Types of collective action during the pandemic in Pujon Kidul Tourism Village.

*3.5. Explanation of Community Resilience Characteristics during the Pandemic in Pujon Kidul Tourism Village*

Characteristics of community resilience of the Pujon Kidul Tourism Village community can be determined based on the choice of answers to the questions addressed to the respondents. The answers are explained and illustrated with descriptive statistics. The answer choices consisted of five answer choices for each question given: strongly disagree (SD), disagree (D), moderately agree (MA), agree (A), and strongly agree (SA). Additionally, the following are indicators that measure community resilience: community resilience, knowledge of COVID-19 (CR1), community security (CR2), availability of health protocol facilities in the village (CR3), and community perceptions of assistance and contributions (CR4).

Based on the data on the characteristics of community resilience in Pujon Kidul Village in Table 3, it can be seen that the answers from 275 respondents were dominated by choices four and five.

**Table 3.** Characteristics of community resilience in Pujon Kidul Village.

Variable	Indicator	Strongly Disagree (SD) (1)	Disagree (D) (2)	Moderately Agree (MA) (3)	Agree (A) (4)	Strongly Agree (SA) (5)	Mode
Community resilience	CR1	0.73%	1.09%	3.27%	39.64%	55.27%	5
	CR2	0.36%	1.45%	5.82%	36.73%	55.64%	5
	CR3	0.73%	1.45%	17.45%	47.27%	33.09%	4
	CR4	1.82%	1.82%	23.64%	60.36%	12.36%	4

Some respondents have a very understanding of COVID-19 and feel very safe in the community. This is supported by the availability of health protocol facilities in good condition that could be used in the village (Figure 5). However, some respondents feel that the community and the government assist the community, but the assistance is only enjoyed by certain groups (Figure 4).

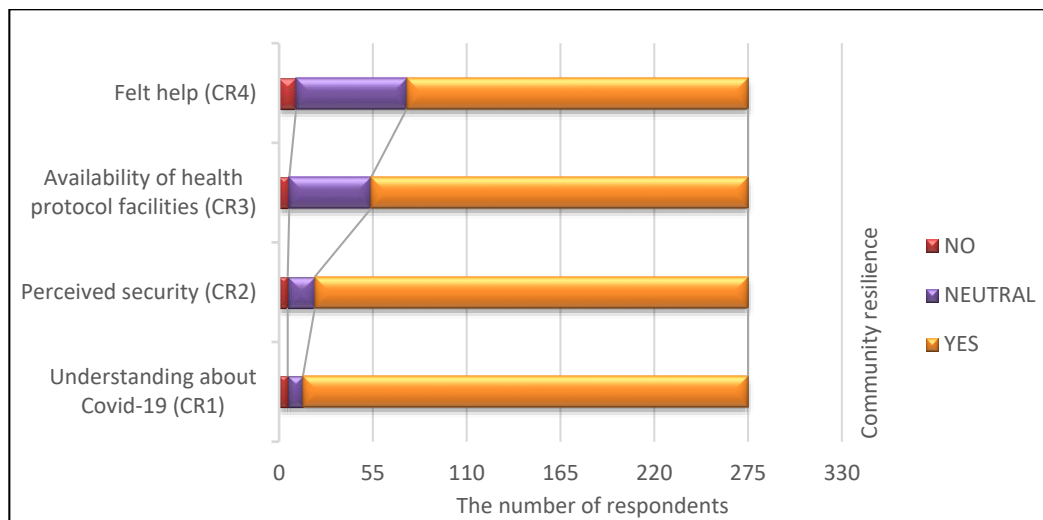

**Figure 5.** Characteristics of community resilience.

### 3.6. Confirmatory Factor Analysis (CFA), the Results of the Analysis for the First Purpose of the Research

Confirmatory factor analysis was conducted to analyze the indicators of social capital formation in the study locations. Social networks, beliefs, and norms are the dimensions that make up social capital. The CFA analysis in this study is a second-order CFA. First, the latent variable of trust (T) has indicators including trust in neighbors (T1), trust in immigrants (T2), trust in the government (T3), trust in traditional leaders (T4), trust in religious leaders (T5), trust in tourism institutions (T6), and communication between people (T7). Second, the norms variable (N) consists of obedience to customs (N1) and attendance at traditional events (N2). The social networks variable (NW) consists of willingness to build cooperation (NW1), participation in religious activities (NW2), participation in social activities (NW3), willingness to give opinions during meetings (NW4), and participation in community groups (NW5). The CFA analysis was carried out in two stages with the following estimation results and goodness of fit (Figure 6a,b).

Based on the estimated value and feasibility of goodness of fit (Figure 6), it can be seen that in stage 1, there were two invalid confidence variables because they had a loading factor of 0.5, including T6 (0.097), T7 (0.061), and NW3 (0.469). Two indicators needed to be discarded to proceed to the next stage. In the next stage (second stage), the CFA model fit was recalculated, and the indicators that make up the social capital variable were obtained. The trust variable was formed by trust in neighbors (T1) (0.689), trust in immigrants (T2) (0.533), trust in the government (T3) (0.527), trust in traditional leaders (T4) (0.631), and trust in religious leaders (T5) (0.572). The social networks variable was formed by willingness to build cooperation (NW1) (0.548), participation in religious activities (NW2) (0.526), willingness to give opinions during meetings (NW4) (0.629), and participation in community groups (NW5) (0.719). The norms variable was formed by obedience to customs (N1) (0.747) and attendance at traditional events (N2) (1.099).

The loading factor value describes how much influence the indicator has on the formation of the latent variable. For example, this indicates that the indicator of trust in neighbors was the most influential in forming trust. On the other hand, attendance at traditional events was the most influential in forming norms, and participation in community groups was the most influential indicator in forming social networks in Pujon Kidul Village.



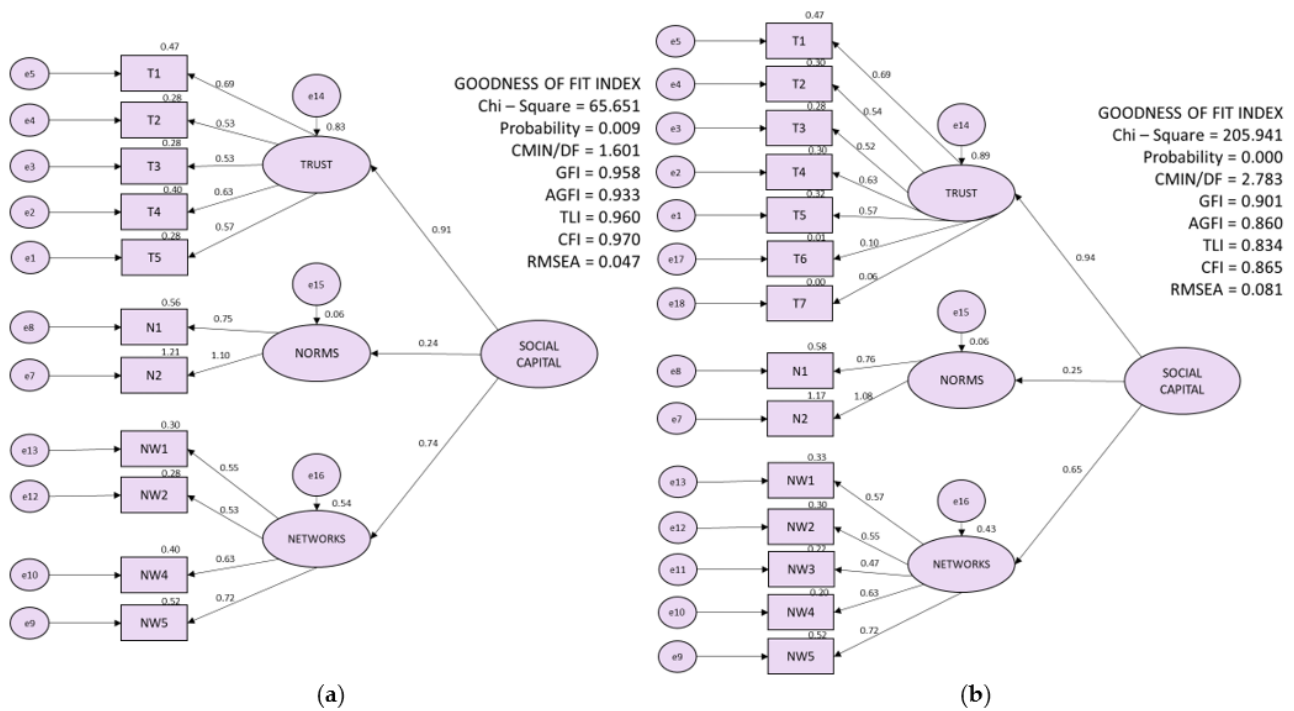

**Figure 6.** This is a figure from the CFA analysis. (a) The first stage of the social capital CFA model. (b) The second stage of the social capital CFA model.

### 3.7. Structural Equation Modelling (SEM), the Results of the Analysis for the Second Purpose of the Research

Structural equation modeling was conducted to identify the relationship between social capital and community adaptation patterns depicted through collective action and community resilience in Pujon Kidul Village. SEM analysis was carried out with three alternative models, which described the relationship between the social capital, collective action, and community resilience variables. These three models had different paths. Model 1 described the direct relationship of norms and networks to trust. Then, trust was directly related to the collective action of the government and the community which was considered to affect the community resilience variable. Model 2 described the direct relationship of the social networks and trust variables to the norms variable. The norms were directly related to the collective action of the government and community, which affected the community resilience variables. Finally, model 3 described the direct relationship between the trust, norms, and social networks variables. The social networks were directly related to collective action that was considered to be able to affect community resilience.

In this study, the three models were compared with the estimated value and goodness of fit (Figure 6). Then, one of the fittest models was selected based on the chi-squared, probability, GFI, CMIN/DF, TLI, AGFI, RMSEA, and CFI criteria.

Based on the estimated value and goodness of fit (Figure 7a–c) of the three SEM models, model 3 was the fittest model among the three alternative models. This is because in the path diagram's depiction, the model's eligibility requirements were at least 4–5 GOFI criteria, and the three models were fit. However, model 3 was the fittest because it met five criteria. There is a lower chi-squared limit value of 299.954 (lower than the df limit value), the CMIN/DF value was 1.648, the GFI value was 0.906, the AGFI value was 0.881, the TLI value was 0.962, the CFI value was 0.967, and the RMSEA value was 0.049. Meanwhile, the relationship between the variables described in model 3 is a direct relationship between the two variables of trust and norms. The relationship between the two is directly related to the network, and the network is directly related to the community's collective action that affects community resilience.

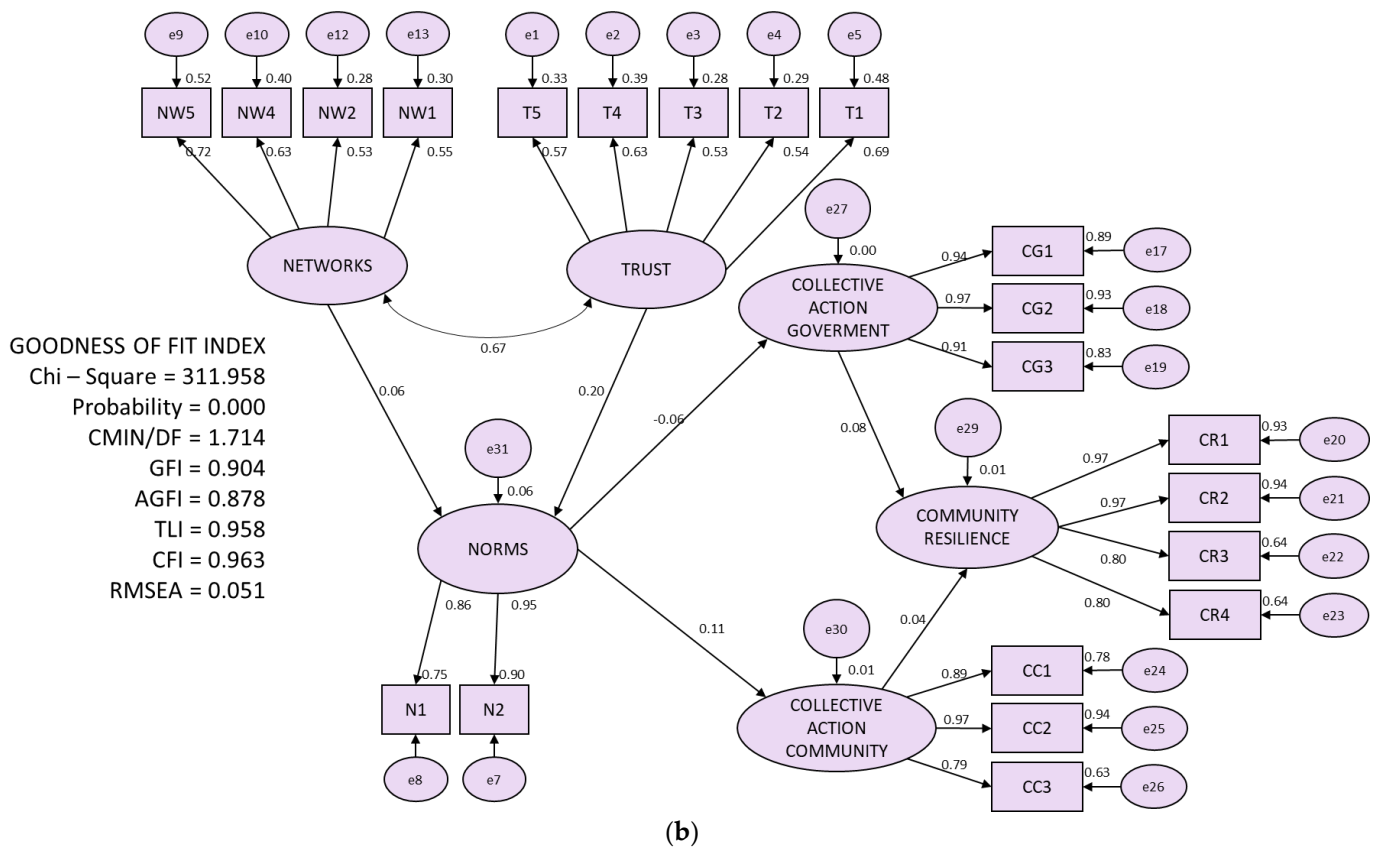
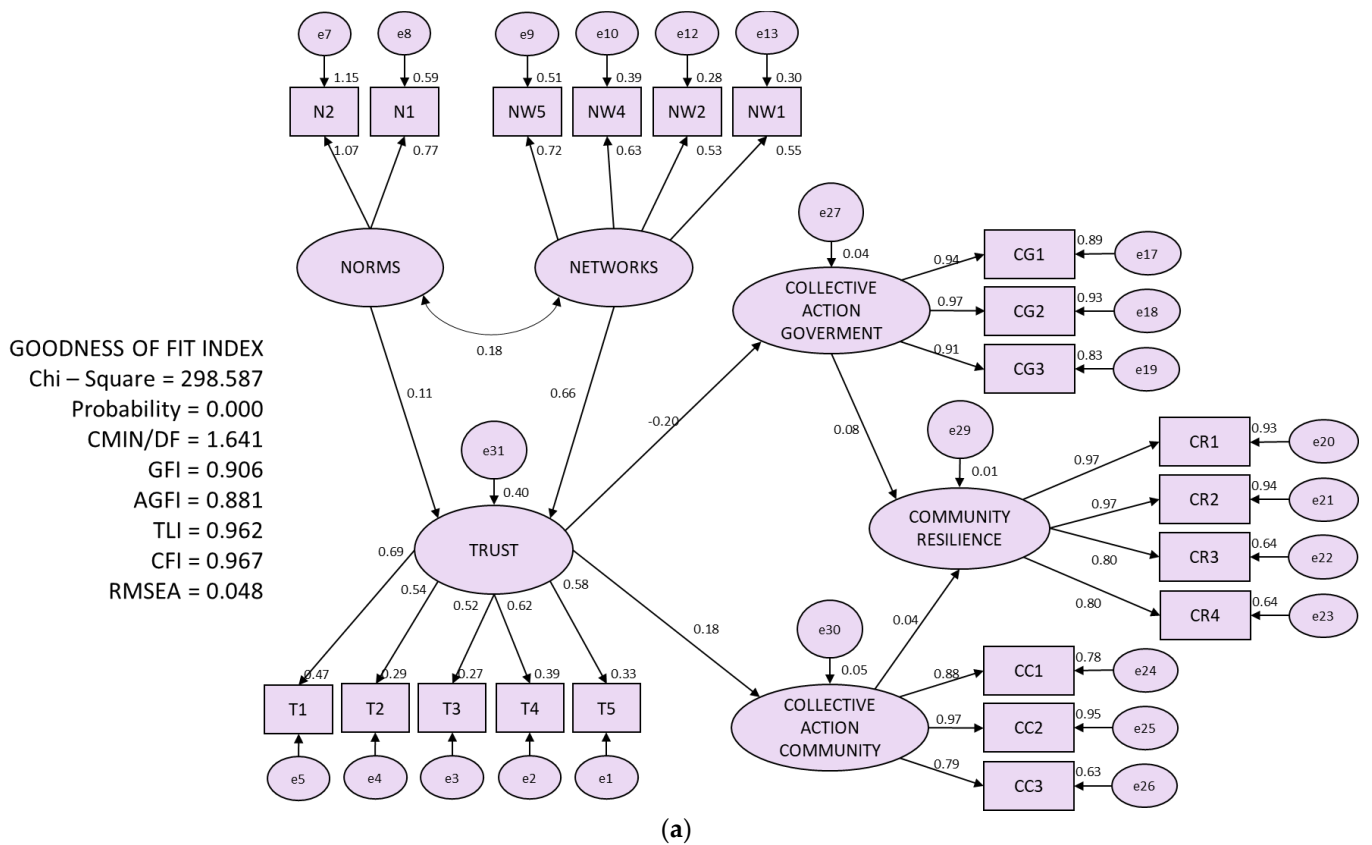

Figure 7. Cont.

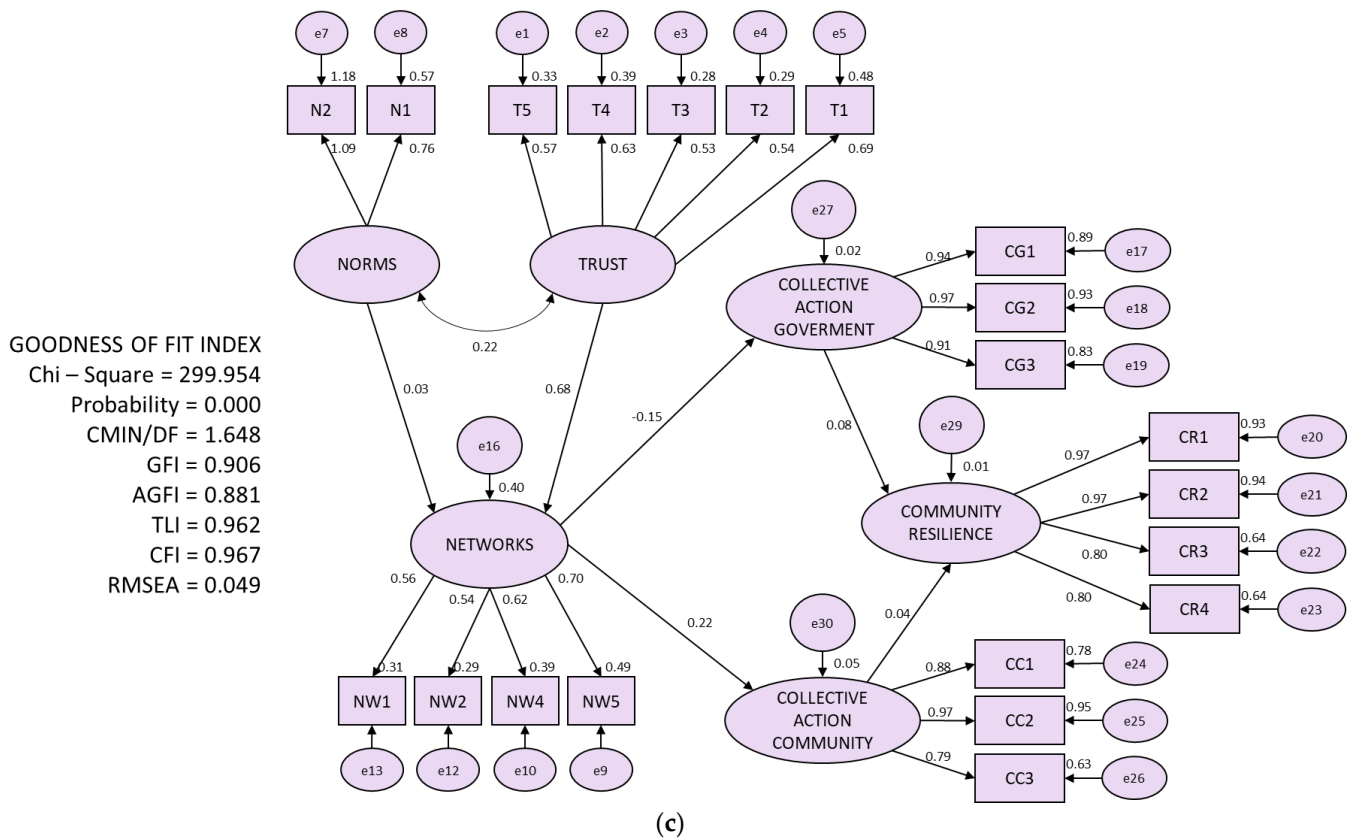

Figure 7. (a) Model 1 SEM, (b) Model 2 SEM (c) Model 3 SEM.

The influence of the relationship between variables in Model 3 can be seen from the values of the Squared Multiple Correlation (R<sup>2</sup>). First, trust positively influences social networks, which is 0.468. Then the network variable has a positive effect on community action with a value of 0.046, and the community action variable has a positive effect on community resilience with a value of 0.007. The positive effect of community action means that the higher the trust, the better the network formed, and a well-formed network increases the community’s initiative to take collective action. Then the higher the community’s initiative to take collective action, the better the community’s resilience; thus, the relationship between these three variables can form an adaptation pattern during the Pujon Kidul Village community pandemic.

Social capital is the main capital in moving individuals or groups of people to live their daily lives. Strong social capital will raise the public’s desire to be in-volved. The Pujon Kidul community, which has good social capital conditions, will make it easier for the community to participate in collective action as a form of caring for each other during the pandemic. Then this action also influences the community to survive in a pandemic crisis. Therefore, social capital can support an adaptation pattern of the Pujon Kidul Village community facing a pandemic.

4. Conclusions

The indicators that describe the latent variable of social capital in Pujon Kidul Tour-ism Village are the latent variable of trust formed by five indicators: trust in neighbors, trust in immigrants, trust in the government, trust in traditional leaders, and trust in religious leaders. Likewise, the latent variable of norms is formed by two indicators consisting of adherence to customs and attendance at traditional events. Finally, the social network variable consists of 4 indicators formed Willingness to build cooperation, Participation in religious activities, Willingness to give opinions during meetings, and Participation in community groups.



SEM's findings link social capital variables, collective action, and community resilience interrelationships. For example, model 3 SEM describes the relationship between trust variables that affect network variables by 0.468. The network variables affect community actions by 0.046, and community action variables affect community resilience by 0.007. Therefore, better social capital will form a good pattern of community adaptation through collective action and community resilience during the Pujon Kidul Village pandemic.

**Supplementary Materials:** The following data of supporting information can be downloaded at: <https://www.mdpi.com/article/10.3390/su141912949/s1>.

**Author Contributions:** Conceptualization, G.P. and A.A.; methodology, G.P., A.A.; software, A.E.; validation, A.E., A.H. and A.A.; formal analysis, G.P.; investigation, A.A.; resources, D.D.; data curation, A.A.; writing—original draft preparation, G.P. and A.A.; writing—review and editing, G.P.; visualization, A.A.; supervision, D.D.; project administration, G.P.; funding acquisition, G.P. All authors have read and agreed to the published version of the manuscript.

**Funding:** This research was funded by DRPM DIKTI and LPPM Universitas Brawijaya, grant No. 1071.64//UN10.C10/TU/2022, and the APC was funded by DRPM DIKTI and LPPM Universitas Brawijaya.

**Institutional Review Board Statement:** The study did not require ethical approval. Not applicable for studies not involving humans or animals.

**Informed Consent Statement:** The study did not involve humans.

**Data Availability Statement:** Not applicable.

**Acknowledgments:** This research was made possible with the support of Universitas Brawijaya and DRPM DIKTI. We also acknowledge the Local Government of Pujon Kidul Village's assistance in collecting data from our respondents. Finally, we appreciate the support of the entire survey team.

**Conflicts of Interest:** The authors declare no conflict of interest.







## References

1. Jason; Roslynlia; Gunawan, A.A.S. Forecasting Social Distancing impact on COVID-19 in Jakarta using SIRD Model. *Procedia Comput. Sci.* **2021**, *179*, 662–669. [CrossRef] [PubMed]
2. Khotimah, K.; Sarmini, S.; Imron, A. Family based social capital in handling of COVID-19 prevention in blitar district. *J. Partisipatoris* **2020**, *2*, 84–95. [CrossRef]
3. Mathbor, G.M. Enhancement of community preparedness for natural disasters: The role of social work in building social capital for sustainable disaster relief and management. *Int. Soc. Work* **2007**, *50*, 357–369. [CrossRef]
4. Sadri, A.M.; Ukkusuri, S.V.; Lee, S.; Clawson, R.; Aldrich, D.; Nelson, M.S.; Seipel, J.; Kelly, D. The role of social capital, personal networks, and emergency responders in post-disaster recovery and resilience: A study of rural communities in Indiana. *Nat. Hazards* **2018**, *90*, 1377–1406. [CrossRef]
5. Luo, M.; Zhang, D.; Shen, P.; Yin, Y.; Yang, S.; Jia, P. COVID-19 lockdown and social capital changes among youths in China. *Int. J. Health Policy Manag.* **2021**, *11*, 1301–1306. [CrossRef] [PubMed]
6. Makridis, C.A.; Wu, C. How social capital helps communities weather the COVID-19 pandemic. *PLoS ONE* **2021**, *16*, e0245135. [CrossRef]
7. Reininger, B.M.; Rahbar, M.H.; Lee, M.; Chen, Z.; Alam, S.R.; Pope, J. Social capital and disaster preparedness among low income Mexican Americans in a disaster prone area. *Soc. Sci. Med.* **2013**, *83*, 50–60. [CrossRef]
8. Liu, Q.; Wen, S. Does social capital contribute to prevention and control of the COVID-19 pandemic? Empirical evidence from China. *Int. J. Disaster Risk Reduct.* **2021**, *64*, 102501. [CrossRef]
9. Nayak, A.K. Developing Social Capital through Self-help Groups. *Indore Manag. J.* **2015**, *7*, 18–24.
10. Hwang, D.; Stewart, W.P. Social Capital and Collective Action in Rural Tourism. *J. Travel Res.* **2017**, *56*, 81–93. [CrossRef]
11. Grootaert, C.; Van Bastelaer, T. (Eds.) *Understanding and Measuring Social Capital: A Multi-Disciplinary Tool for Practitioners*; World Bank: Washington, DC, USA, 2002.
12. Jacobs, E.; Hofman, I. Aid, Social Capital and Local Collective Action: Attitudes Towards Community-Based Health Funds and Village Organizations in Rushan. *Oxf. Univ. Press Community Dev. J.* **2020**, *55*, 399–418. [CrossRef]
13. Ido, A. The effect of social capital on collective action in community forest management in cambodia. *Int. J. Commons* **2019**, *13*, 777. [CrossRef]
14. Pramanik, P.; Ingkadjaya, R.; Achmadi, M. The Role of Social Capital in Community Based Tourism. *J. Indones. Tour. Dev. Stud.* **2019**, *7*, 62–73. [CrossRef]

15. Nugraha, A.T.; Prayitno, G.; Hasyim, A.W.; Roziqin, F. Social capital, collective action, and the development of agritourism for sustainable agriculture in rural Indonesia. *Evergreen* **2021**, *8*, 1–12. [CrossRef]
16. Kusumastuti, A. Modal Sosial dan Mekanisme Adaptasi Masyarakat Pedesaan dalam Pengelolaan dan Pembangunan Infrastruktur. *MASYARAKAT J. Sociol.* **2016**, *20*, 81–97. [CrossRef]
17. Prayitno, G.; Dinanti, D.; Efendi, A.; Hayat, A.; Dewi, P.P. Social Capital of Pujon Kidul Communities in Supporting the Development of the COVID-19 Resilience Village. *Int. J. Sustain. Dev. Plan.* **2022**, *17*, 251–257. [CrossRef]
18. Ira, W.S.; Muhamad, M. Partisipasi Masyarakat pada Penerapan Pembangunan Pariwisata Berkelanjutan (Studi Kasus Desa Wisata Pujon Kidul, Kabupaten Magelang). *J. Pariwisata Ter.* **2020**, *3*, 124–135. [CrossRef]
19. Puspitaningrum, E.; Lubis, D.P. Modal Sosial dan Partisipasi Masyarakat dalam Pembangunan Desa Wisata Tamansari di Kabupaten Banyuwangi. *J. Sains Komun. dan Pengemb. Masy.* **2018**, *2*, 465–484. [CrossRef]
20. Zhang, Y.; Xiong, Y.; Lee, T.J.; Ye, M.; Nunkoo, R. Sociocultural Sustainability and the Formation of Social Capital from Community-based Tourism. *J. Travel Res.* **2020**, *60*, 656–669. [CrossRef]
21. Birendra, K.C.; Morais, D.B.; Seekamp, E.; Smith, J.W.; Peterson, M.N. Bonding and bridging forms of social capital in wildlife tourism microentrepreneurship: An application of social network analysis. *Sustainability* **2018**, *10*, 315. [CrossRef]
22. Zhao, W.; Ritchie, J.R.B.; Echtner, C.M. Social capital and tourism entrepreneurship. *Ann. Tour. Res.* **2011**, *38*, 1570–1593. [CrossRef]
23. Khazami, N.; Lakner, Z. The mediating role of the social identity on agritourism business. *Sustainability* **2021**, *13*, 11540. [CrossRef]
24. Setokoe, T.J.; Ramukumba, T. Challenges of community participation in community-based tourism in rural areas. *WIT Trans. Ecol. Environ.* **2020**, *248*, 13–22. [CrossRef]
25. Kizos, T.; Plieninger, T.; Iosifides, T.; García-Martín, M.; Girod, G.; Karro, K.; Palang, H.; Printsman, A.; Shaw, B.; Nagy, J.; et al. Responding to landscape change: Stakeholder participation and social capital in five european landscapes. *Land* **2018**, *7*, 14. [CrossRef]
26. Irawati, D. Tutup Sementara, Kafe Sawah Pujon Kidul Kehilangan Omzet Miliaran Rupiah. 2020. Available online: <https://www.kompas.id/> (accessed on 8 June 2021).
27. Deng, X.; Zeng, M.; Xu, D.; Qi, Y. Does social capital help to reduce farmland abandonment? Evidence from big survey data in rural china. *Land* **2020**, *9*, 360. [CrossRef]
28. Gorda, A.O.S.; Romayanti, K.N.; Anggreswari, N.P.Y. Social capital, spiritual capital, human capital, and financial capital in the management of child welfare institutions. *Int. J. Soc. Sci. Humanit.* **2018**, *2*, 12–20. [CrossRef]
29. Garrigos-Simon, F.J.; Botella-Carrubi, M.D.; Gonzalez-Cruz, T.F. Social capital, human capital, and sustainability: A Bibliometric and visualization analysis. *Sustainability* **2018**, *10*, 4751. [CrossRef]
30. Arikinto, S. *Prosedur Penelitian Suatu Pendekatan Praktek*; Rineka Cipta: Jakarta, Indonesia, 2006.
31. Wijanto, S.H. *Structural Equation Modeling Dengan Lisrel, Konsep dan Tutorial*; Graha Ilmu: Jakarta, Indonesia, 2008.
32. Haryono, S. *Metode SEM Untuk Penelitian Manajemen Dengan AMOS 22.00, LISREL 8.80 dan Smart PLS 3.0*; Badan Penerbit PT; Intermedia Personalita Utama: Jakarta, Indonesia, 2016.
33. Haryono, S. Structural Equation Modelling untuk Penelitian Manajemen Menggunakan AMOS. *J. Ekon. Bisnis* **2014**, *7*, 23–34.
34. BPS. Kecamatan Pujon Dalam Angka (Pujon Sub District in Figures). 2021. Available online: <https://malangkab.bps.go.id/publication/2021/09/24/d1fa50a5156012261deddd0/kecamatan-pujon-dalam-angka-2021.html> (accessed on 24 August 2022).

## Article

# How Did the COVID-19 Pandemic Affect Functional Relationships in Activities between Members in a Tourism Organization? A Case Study of Regional Tourism Organizations in Poland

Wojciech Fedyk <sup>1</sup>, Mariusz Sołtysik <sup>1</sup>, Justyna Bagińska <sup>2,\*</sup>, Mateusz Ziemia <sup>3</sup>, Małgorzata Kołodziej <sup>4</sup> and Jacek Borzyszkowski <sup>5</sup>

<sup>1</sup> Department of Tourism, Wrocław University of Health and Sport Sciences, al. I.J. Paderewskiego 35, 51-612 Wrocław, Poland

<sup>2</sup> Department of Tourism and Recreation, WSH University in Wrocław, ul. Ostrowskiego 22, 53-238 Wrocław, Poland

<sup>3</sup> Faculty in Chorzow, WSB University in Poznan, ul. Sportowa 29, 41-506 Chorzów, Poland

<sup>4</sup> Department of Biomechanics, Wrocław University of Health and Sport Sciences, al. I.J. Paderewskiego 35, 51-612 Wrocław, Poland

<sup>5</sup> Faculty of Business, WSB University in Gdansk, al. Grunwaldzka 238A, 80-266 Gdansk, Poland

\* Correspondence: justyna.baginska@handlowa.eu



check for updates

**Citation:** Fedyk, W.; Sołtysik, M.; Bagińska, J.; Ziemia, M.; Kołodziej, M.; Borzyszkowski, J. How Did the COVID-19 Pandemic Affect Functional Relationships in Activities between Members in a Tourism Organization? A Case Study of Regional Tourism Organizations in Poland. *Sustainability* **2022**, *14*, 12671. <https://doi.org/10.3390/su141912671>

Academic Editors: Zygmunt Kruczek and Bartłomiej Walas

Received: 15 September 2022

Accepted: 1 October 2022

Published: 5 October 2022

**Publisher's Note:** MDPI stays neutral with regard to jurisdictional claims in published maps and institutional affiliations.



**Copyright:** © 2022 by the authors. Licensee MDPI, Basel, Switzerland. This article is an open access article distributed under the terms and conditions of the Creative Commons Attribution (CC BY) license (<https://creativecommons.org/licenses/by/4.0/>).

**Abstract:** A key research question that fits within the main objective is to identify the negative and positive effects of the COVID-19 pandemic on the functional relationships between members of regional tourism organizations (RTOs) in Poland. The study consisted of three stages: desk research, a diagnostic survey, as well as qualitative, and statistical analyses. Empirical data from all 16 Polish RTOs (regional DMOs) on 19 variables were collected. No significant symptoms of the negative impact of the COVID-19 pandemic on the functional relationship between RTOs and their stakeholders were found, except for the observed increased number of limitations of RTOs' activities aimed at benefiting their members. As part of the study's secondary objectives, key variables and methods were indicated. They identify the functional relationships of RTOs with member entities, with the environment, and are useful in building the effectiveness of the organization at the regional level in crisis situations. As the pragmatic goal of the study, a research tool was proposed that can be implemented to evaluate relations with the environment in other tourism destination management organizations at various levels of the tourism economy.

**Keywords:** tourism; COVID-19; impact; DMO; stakeholder

## 1. Introduction

The complicated network of existing multidimensional connections between the entities of the modern tourism market encourages attempts to assess the scale and nature of the relationship between these entities and their partners, and in their activities aimed at developing tourism in a given area. Constant tightening of relations between entities of the tourism economy is perceived as an element of building a competitive edge, but also often as a kind of panacea for the negative impact of crisis situations on tourism, which includes the COVID-19 pandemic. Some of the processes and relations of the tourism market during the COVID-19 pandemic were subject to strong turbulences, both in terms of supply and demand. Thus, there is an urgent need to search for new methods and techniques assessing the functioning of entities in the tourism economy—to whom a key role in the development of the tourism economy at the regional level is assigned.

The above-mentioned phenomena and the problems of the broadly defined tourism sphere are particularly and clearly manifested in various types of organizations operating

in the areas of tourist reception, which also include DMOs—such as the regional tourism organizations operating in Poland. It should be emphasized that, so far, RTOs in Poland have not been the subject of in-depth research into changes in these organizations caused by external factors, including such strong (and mainly negative) factors as the COVID-19 pandemic. This, therefore, makes this research significant, not only in a scientific, but also in a pragmatic sense. The existing, and few, studies of Polish DMOs at the regional level have focused mainly on the assessment of the effects of the COVID-19 pandemic on the current activities of the organization (mainly in the area of marketing and operational activities) [1]. On the other hand, the issue of assessing the degree and nature of the impact of crisis phenomena, such as the COVID-19 pandemic, specifically the relationship of RTOs with ordinary members of the organization, as well as with the close and distant environment, has not been addressed so far. Thus, these are a current challenge for researchers and experts. The importance of the research in question also stems from the fact that Polish DMOs at the regional level are strongly differentiated in terms of quality and quantity. This is due to a very long process of their creation (specifically the 2000–2007 period), and a different degree of organizational maturity, which was formed over a period of 20 years during their operation in Poland. Importantly, Polish RTOs are, at present, expecting changes in their functioning, due to the planned reformation of the formal and legal foundations of their operation, alongside the Polish Tourist Organization (which is the classic NTO, i.e., National Tourism Organization) and local tourist organizations (DMOs at the local level).

## 2. Literature Review

### 2.1. Stakeholders in Tourism

Tourism is a complex system that brings together a number of entities involved in its development. Stakeholders are closely related to the tourism economy. In general, stakeholders are entities that can have an impact on, and may be affected by, the results of a tourism organization's goals [2]. The main groups of stakeholders include: residents, tourists, economic entities, tourism decision makers, and destination management organizations [3]. Stakeholders play a particularly important role in the shaping of the modern tourism economy. This is largely due to the complex nature of tourism and its interdisciplinarity [4]. Without the support of stakeholders operating in a given region (destination), it is difficult to develop tourism in a given form [5]. The last 25 years have seen an increase in research and analysis on stakeholder involvement in tourism planning and development [6].

Relationships between stakeholders influencing the shape of tourism economy requires development of applicable rules. This, in turn, implies taking specific actions by many entities, including those not directly related to tourism, such as residents [7]. There are, relatively speaking, many problems related to the involvement of stakeholders in the development of tourism in a given destination. In many cases this is due to the limited nature of the relationship between the public and private sectors [8]. An important factor limiting cooperation between individual stakeholder groups is the lack of appropriate institutional structures, which in turn hinders their participation in the tourism management process [9]. This, in turn, implies other challenges, such as the selection of a leader responsible for tourism management in a given region [10].

The complexity and dynamics of the relationship between stakeholders' [11] results, *inter alia*, from differences in development perspectives or adopted goals [12] is an important distinction. Regardless of the different approaches and different goals of specific groups of stakeholders, it can be assumed that there is quite a lot of agreement as to the role of tourism in the development of individual destinations, especially in areas where economic development is based on tourism [13]. This results in the need to involve various groups of stakeholders, as it is a particularly important element of effective management of a tourist destination [14]. One should be aware that the level of stakeholder engagement may (and should be) different, depending on the impact and importance of individual

entities [15]. Regardless, stakeholder involvement should take place at all stages of tourism destination management [16].

Destination management organizations (DMOs) play an important role in shaping the relationship between the stakeholders. These organizations are responsible for developing strategies tailored to the expectations of all members of the tourism management system, and, in particular, to individual stakeholder groups [17]. Through their activities, DMOs can contribute to a measurable success of the tourism sphere in a given destination. These DMOs' activities include not only external activities (such as marketing), but also internal ones, i.e., the coordination of stakeholder activities. These may be both external stakeholders, who are not members of the organization, and internal stakeholders, who are formal members of the organization; therefore, they can participate in the implementation of the organization's projects [18]. Internal stakeholders are of particular importance as they have a real influence on the direct activities of the organization. Their ideas and initiatives may contribute not only to the creation and strengthening of appropriate relations in the organization, but may also have an impact on shaping the directions of activities, thereby boosting the development of tourism in the region.

## *2.2. Impact of COVID-19 on Tourism*

The multidimensional shock caused by the COVID-19 pandemic should be considered globally, as it has resulted in dramatic and structural changes in various sectors [19]. This is especially discernable in the tourism industry, where virtually every subsector has suffered from the effects of the pandemic [20]. In the pre-pandemic decade, tourism development had been very dynamic [21], and it was suddenly stopped. The COVID-19 pandemic turned out to be the most severe crisis in the history of tourism development and has completely changed the market situation [22]. Global tourism in 2020 was recorded as one of the largest drops in history: the number of international tourist trips fell by as much as 74% compared to the previous year, which translates to over 1 billion fewer tourists than in 2019. The decline in tourism revenues has been USD 1.3 trillion, which is over 11 times more than during the global economic crisis of 2009 [23]. One can say that the COVID-19 pandemic has put tourism into a state of "forced hibernation" [24]. Currently, it is not possible to estimate the scope of the COVID-19 impact on tourism, as the course and duration of the pandemic are both still unknown and unpredictable [25].

Despite the drastic changes on the tourism market, there are voices pointing to a new "face" of tourism, and changes in the challenges facing tourism. Some researchers assume that the pandemic caused only a temporary inhibition of previously occurring phenomena of overtourism and overcrowding of tourism destinations [26]. It is estimated that the impact of the pandemic was varied, depending on tourism form. The return of the tourism industry to the pre-COVID-19 state will be linked to the form of participation proposed to tourists [27–29]. The pandemic had many unprecedented consequences, including influencing tourists' lifestyles, behaviors, and travel patterns [30]. The COVID-19 pandemic also resulted in other, often unfavorable, consequences, such as, creating a negative image of traveling [31]. There has also been a general increase in mental disorders caused by isolation, including an increased sense of anxiety, which has had an impact on the frequency and form of people's participation in tourism [32,33]. The image of a tourist destination may be constantly changing, and the COVID-19 pandemic may have a significant impact on its further shaping [34].

All the above-mentioned phenomena contribute to the emergence of many new challenges. The COVID-19 pandemic also offers the potential to "reevaluate" tourism development plans [35]. The situation that has arisen may also be a starting point for in-depth reflections [36] and for a revision of tourism development plans. This calls for a verification, and even making far-reaching changes in the activities of entities that are responsible both for the development of tourism and for creating an appropriate image of the destination. First of all, tourism organizations must adapt their activities to the changing reality resulting from the COVID-19 pandemic. These entities have to deal with maintaining a

proper image, and, in a wider context, restoring the situation from before the pandemic. Moreover, new challenges result not only from the destructive nature of the pandemic, but also from the creation of “teaching effects” by organizations, e.g., in terms of the emergence of new activity patterns [37]. It is assumed that tourism organizations responsible for developing tourism will adopt extensive growth strategies in the near future to revitalize the tourism industry and meet the reshaping demand [26]. In order to make up for the losses incurred during the current crisis, it will be necessary for the tourism sector to increase their marketing activities [38] and to develop a systemic approach to these activities at many organizational levels [39]. As a result of limiting many forms of international and domestic tourism, competition between entities operating within the tourism market may also intensify [40]. In order to adapt to the new reality, an important role is played by changes in the supply and demand side of the tourism economy caused by the COVID-19 pandemic. For example, travelers’ tendencies to avoid a number of international travel destination types should prompt DMOs to take appropriate measures to, for example, promote domestic tourism [41]. The components of tourism offers, or products expected by tourists—who increasingly look for destinations (including accommodation facilities or attractions) that guarantee a sense of security (mainly sanitary and epidemiological) on the basis of national or regional voucher systems, certification, and recommendation with active participation of DMOs at various levels—are also changing [1]. What is important is that travelers, as a result of concerns about contracting SARS-CoV-2, will cancel or delay their trips (up until the last minute), in line with the spread of news about the scale of the pandemic in a given destination. This poses a serious challenge for tourism organizers, for example, in terms of travel insurance, or for DMOs in terms of promotion. DMOs must be agile and flexible in their actions in order to counteract a decline in demand or an imbalance in supply [25]. In addition, entities offering tourist services were also obliged by regional authorities to suspend their business for fear of a growing epidemic threat—both from tourists and employees of these entities [27]. Moreover, building the resilience of the tourism industry (i.e., stabilization of demand and supply) in the pandemic and post-pandemic period will require a government response, and the implementation of technological innovations or being part of the local structures of tourism management (including DMOs), which will facilitate restoring the confidence of consumers in tourism services [28]. The changes caused by the COVID-19 pandemic are the starting point for reflecting on a new tourism model, especially on a regional scale. Therefore, DMOs will be forced to reorient their marketing strategies [42,43].

### 2.3. *Idea of Regional Structures in Tourism*

The structures responsible for the development of tourism have a long history. They are created and developed at various levels of administration. In this respect, significant importance is assigned to regional structures. However, it should be clearly emphasized that the precise definition and identification of the regional structures that are responsible for tourism is fundamentally difficult [44]. This is due to many reasons, including difficulties in defining the term “region” [45], or in insufficient recognition of regional tourism phenomenon [46]. Regardless, it can be concluded that regional tourism management systems include many entities that are organizing and managing tourism in a given region [47]. The creation and shaping of regional tourism structures take place when the appropriate administrative division in a given country allows it, or when the appropriate local structures decide to consolidate forces and together create appropriate entities implementing tourism goals in a destination. However, it should be remembered that regional tourism entities are often subject to the influence, actions, and decisions of national structures [48].

The system of regional tourism structures is complex. In addition to traditional local self-governments, nowadays, in most European countries, the so-called regional tourism organizations (RTOs) are the most prominent. In broader terms, in most destinations the structures responsible for regional tourism take the form of public–private partnerships [49]. The experience of many countries shows that this form of tourism organization in the region

is considered effective, and thus contributes to the achievement of many tangible benefits, e.g., in terms of risk diversification [50] or joint in decision making [51]. Hence, in many cases, efforts are made to “delegate” many tourism powers to RTOs [52]. The scope of activities within RTOs’ structures is quite diverse, although in the literature it is most often assumed that they are entities responsible for the marketing of a concentrated tourist area [53]. A special role of RTOs should be seen in the development of integrated tourist offerings in a region with the use of the 8Ps of marketing mix (product, price, promotion, place, people, partnerships, programming, and packaging) [54]. Nevertheless, it is more and more often reported that the scope of activities of these entities is wider. This is due to the fact that regional structures in tourism are constantly evolving, which results in changes within the scope of their tasks, the degree of responsibility [55], and the delegation of tasks to other entities [56]. Generally, the most important task of RTOs is the focus on two fields: destination development (by supporting entrepreneurship in the field of tourism or the development of regional tourism infrastructure) and destination marketing (through promotion, image management, or Internet activity management) [57]. RTOs are strongly oriented towards shaping tourism, and, at the same time, aware of their role in conducting this. This is largely due to the extensive relationship with the private sector [58]. The tasks facing regional DMOs are inherently quite difficult, due to the fact they represent specific alliances that involve giving up a certain level of autonomy and power [59]. Research conducted on regional structures in tourism clearly shows that this area has still not been properly penetrated and requires further, in-depth analyses [60]. This issue is important as it results from the dynamic changes taking place within tourism and its organizational structures. Additionally, it is determined by the direct relationship between the analyzed structures and the regional economic policy [61].

#### 2.4. Organization of Tourism in Poland

In Polish tourism, during various stages of its historical development, numerous introductions and the forming of new organizational systems of tourism have been observed [62]. The current system of organizing tourism in Poland was introduced following the patterns applied in many European Union countries [63] and is identical with the territorial division of the country. In 2000, three types of structures were distinguished, i.e., the Polish Tourism Organization, who act as the national tourism organization (NTO); regional tourism organizations (RTOs), who are responsible for the promotion of tourism at the regional level; and local tourism organizations (LTOs), who perform parallel functions at the local level [64]. Currently, there are 16 regional tourism organizations in Poland (in all regions, i.e., provinces) and approx. 125 local tourism organizations.

The Polish Tourism Organization is mainly responsible for promoting the country. Its statutory tasks also include: ensuring the functioning and development of the Polish tourism information system in the country and in the world; initiating, giving opinions, and supporting plans for the development and modernization of tourist infrastructure; and inspiring the creation of regional and local tourism organizations [65]. Regional tourism organizations (RTOs) and local tourism organizations (LTOs) perform similar functions, but at lower levels of the country’s territorial division. Their main tasks include: tourist promotion of their area of operation; supporting the functioning and development of tourist information; initiating, giving opinions and supporting plans for the development and modernization of tourist infrastructure; and cooperation with the Polish Tourism Organization [65]. In general, the division of tasks and responsibilities in the field of tourism, which are adopted and binding in Poland, is similar to the solutions in force in other countries, and, by definition, these entities fulfill the functions of DMOs at various levels of administration [44,66–69].

In addition, the national tourism administration (NTA) is responsible for strategic tasks resulting from the adopted tourism policy of the country. Its functions are currently performed by the Ministry of Economic Development, Labor and Technology. The indicated ministry, following the example of other countries, is responsible for general tasks related to

creating development and indicating directions for the promotion of tourism, as well as the development, implementation, and monitoring of tourism programs or in handling matters related to the country's tourism development [70]. In addition, it should be mentioned that, apart from the entities mentioned, there are a number of other organizations in Poland that influence the general shape of the organization of tourism systems in the country, including: tourism chambers, tourist associations, local government units, and others [64].

Generally, the tourism management system that is adopted, and in force, in Poland indicates a relatively orderly division of tasks and responsibilities between individual entities at various levels of administration. At the same time, new opportunities for shaping the development of the tourism economy that have emerged as a result of the country's three-tier territorial division are a challenge for all participants in the tourism management process, i.e., public sector entities, private sector partners, and non-profit institutions [71]. The 21-year history of organizational structures in Polish tourism shows that they have already reached a certain maturity [72]. Nevertheless, these structures also require some kind of "reorganization", which results from many problems such as forms of cooperation that are implemented on a limited level [73]. In addition, relatively few scientific studies have been published in recent years to assess selected aspects of the activity of specific organizational structures in Polish tourism [74]. Hence, there is a need for detailed research in this area. Further, this is also due to the drastic changes taking place on the tourist market (including the organization network), which have been caused by the COVID-19 pandemic.

All regional tourism organizations operating within Poland are subjected to assessment from the perspective of their relations with stakeholders. RTOs were established in 2000–2006 under the Act of 25 June 1999 as enacted by the Polish Tourism Organization [64]. The number of regular RTO members is constantly growing. Since 2006, it has increased by 58.31%. RTOs, (with a total of 1584 ordinary members in 2021, 114 employees, and 141 board members), have become an important element of the tourism system in the course of the 21-year evolution of their operation [75–78]. They have even gained the status of a regional leader [52] or an instrument of regional tourism policy [79].

A brief description of the various levels of tourism management in Poland, including all types of DMOs, is a necessary background for the analysis of the research subject—which is here RTOs. The RTOs as entities have multidimensional and complex relations with the PTO (further environment) and various LTOs (closer environment) and not only with the ordinary members of organizations. These relations are also analyzed in this study.

To sum up the literature review: the importance of modern tourism management structures (based on the example of Polish organizations) was emphasized, with a simultaneous emphasis on the special role of cooperation between individual stakeholders. In the time of the COVID-19 pandemic, this issue is particularly important from the point of view of maintaining appropriate relations between stakeholders, or—as in the case of this analysis—with member entities. Considering the catastrophic impact of the COVID-19 pandemic on the entirety of the tourist environment, these relations should be examined and assessed. It can be assumed that just as the COVID-19 pandemic left its mark on the entire global tourism sector, it could also have an impact on the relationship between individual entities that make up DMOs, such as RTOs in Poland. This issue has not been studied in great detail so far. At the same time, the authors assume that a detailed analysis of changes in such relationships may be the starting point for improving the activities of DMOs in crisis situations.

The presented literature studies allowed for the formulation of the main aim of the study, which is to identify the negative and positive effects of the COVID-19 pandemic on the relations between members in a tourism organization, especially in terms of the effective fight against crisis phenomena that are not uncommon in the tourism economy. Indirect goals of the study were, in turn, to indicate the variables thus identifying the nature of RTOs' relations with member entities and the environment during the crisis. As well as an attempt to propose a research tool (which will need to be easy to implement) that can be



used to assess the nature of the relationship with the environment in other types of tourism destination management organizations at various levels.

Based on the above considerations, the following hypotheses were adopted in this study:

**Hypothesis 1 (H1):** *The COVID-19 pandemic has limited relationships with and activities between RTOs and organization members.*

**Hypothesis 2 (H2):** *As a result of the COVID-19 pandemic, RTOs have revised the importance and validity of their core activities to organization members in terms of marketing and support strategies.*

**Hypothesis 3 (H3):** *Due to restrictions, RTOs have taken or planned new or additional forms of action for organization members to reduce the adverse effects of the COVID-19 pandemic.*

### 3. Materials and Methods

In this study, primary and secondary data were analyzed, including literature on the subject; plans and reports on RTOs activity; analytical study; data from the Central Statistical Office (Local Data Bank); and data from websites. A review of scientific publications concerning tourism stakeholders, cooperation and types of relations in the tourism economy, mainly in terms of characterizing the functioning of tourism organizations, the degree and nature of the impact of the COVID-19 pandemic on tourism, and the functioning of tourism management systems at the national and regional level was carried out. Direct research based on a diagnostic survey with the use of a questionnaire (both closed and open questions) with the use of a Google Forms application was of key methodological importance (the questionnaire form was included in the supplementary materials for the paper). The substantive components of the survey were based on previous DMOs research [73–77] and the process involved consultation (upon preparing the questionnaire) with experts from the Polish Tourist Organization and selected experts, who had previously performed managerial roles in DMOs. The primary study (i.e., the questionnaire) was conducted in August–September 2021 on all RTOs operating within Poland (16 organizations, whole population) with a total of 1584 members. The survey was addressed to opinion leaders in the DMOs (organization presidents and office directors, as they are the most knowledgeable people about the organization) and aggregated responses to the survey questions from all of the 16 organizations were received (i.e., no survey was rejected). The research was carried out on the basis of a questionnaire containing, in addition to the basic data of the organization (e.g., name, address, year of establishment, legal form), 19 variables, which included, among others:

- Forms of the organization’s activity (including member support strategy) in the period before and during the COVID-19 pandemic,
- The nature of the impact of the COVID-19 pandemic on the organization, especially regarding relations with members,
- Types of activities undertaken by the organization for the benefit of organization members in order to reduce the effects of the COVID-19 pandemic,
- Changes introduced in the organization’s model of activities and in the forms and types of relationships with members caused by the COVID-19 pandemic.

In order to carry out further analysis and achieve the set aim of the research, questions no.: 2, 5, 6, 8, 10–13, and 15 (see the supplementary materials) were taken into account. The selection of specific variables from the survey for extended analyses was related to the study purpose and the posed hypotheses. The variables were statistically tested in terms of their interrelationships and the correlations based on the adopted research process scheme (see Figure 1). The analysis of responses to selected questions helped to assess the relationship between the limitations in RTOs observed during the pandemic (question 8), changes in the importance of basic activities of the organization (questions 5–6), and their relationships with members (questions 11–13), which thus helped to determine whether

RTOs (in view of the above) have taken (question 10) or planned (question 15) actions (and what) to reduce the effects of the pandemic for their members (which were assessed on the basis of questions 8, 5–6, 11–13) (see Figure 2). With regard to the obtained answers to the open-ended questions, a standard solution of aggregating individual responses into synthetic groups was adopted, and then the grouped responses were subjected to statistical calculations.

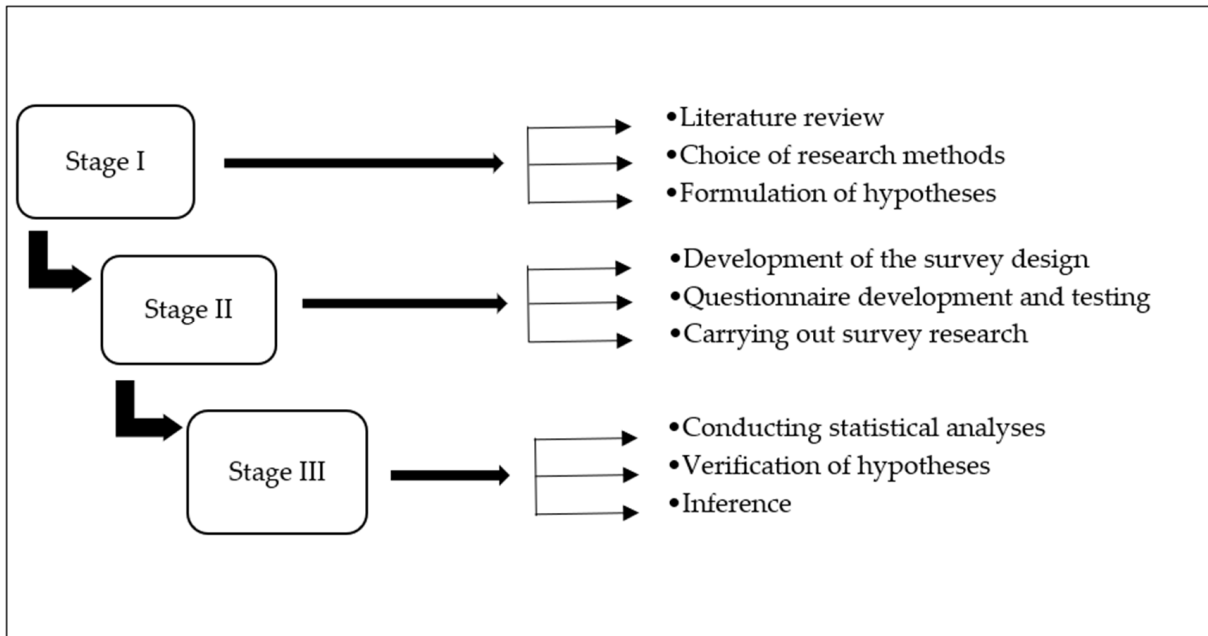

Figure 1. Graphical scheme of study design. Source: own elaboration.

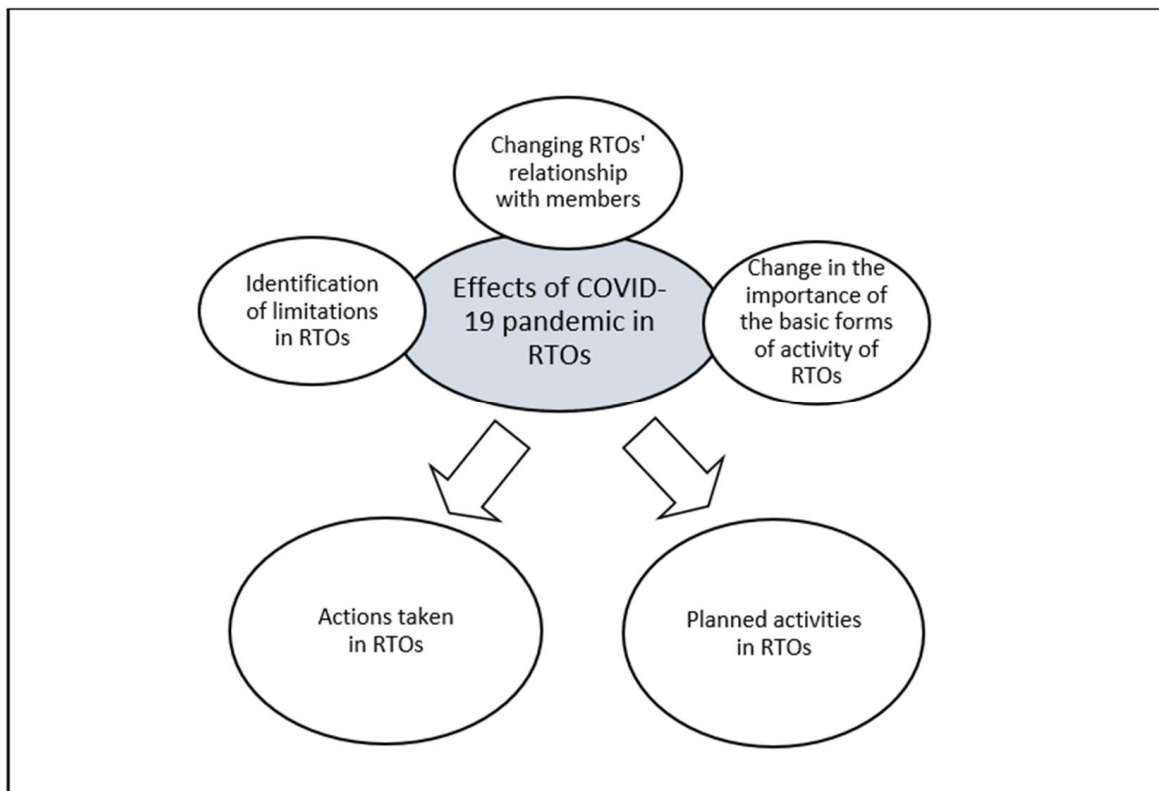

Figure 2. Scheme for assessing selected effects of the COVID-19 pandemic and their relationship with the type of actions taken and planned by RTOs. Source: own elaboration.

The formulation of the conclusions was based on the methods of deduction and comparative analysis, using the technique of describing the differences and similarities. The authors also used their own observations and experiences, as professionally active participants in the tourism management system in Poland (via the participant observation method). In order to simplify the presentation of the studied phenomena and the identified problems, the data obtained in the survey were aggregated, limiting the number of the presented observations only to the most important results:

- The importance of the activities of regional tourism organizations in the period before (BP) and during (DP) the COVID-19 pandemic;
- Forms of regional tourism organizations' activities in the period before and during the COVID-19 pandemic, in terms of marketing activities (MA) and support strategies (SSA);
- Medians of point values broken down into variables of marketing activities (Mema) and variables of the support strategy (Mess);
- The nature of the pandemic's impact on organizations (AR1–8—limitations of the organization's activity, expressed by 8 partial variables), and their relations with member entities (SR1–3—structural relations-3 partial variables);
- Support for member entities during a pandemic, in terms of actions taken (AT1–8—8 partial variables) and planned actions (PA1–9—9 partial variables);
- Relationships between the impact on the activities of the organization (AR1–10), changes in relations with member entities (SR1–3), and the actions taken (AT1–8) and planned actions (PA1–9) during the COVID-19 pandemic.

For qualitative (categorized) data, the percentage of the frequency of occurrence was calculated. The results for the data on a 6-point scale (0–5 points) were presented as median  $\pm$  quartile deviation (MED  $\pm$  QD). The Shapiro–Wilk test did not confirm the distribution of variables' normality ( $p < 0.05$ ). The differences between the assessment of the importance of RTO activities before and during a pandemic were tested by the Wilcoxon test. For categorized variables, the  $\chi^2$  Pearson test or the z-score test for two proportions was used. The relationships between the variables were assessed by the  $\rho$ -Spearman's rank correlation coefficient with the Student's t-significance test for the correlation coefficient. The statistical significance of the results was accepted at  $p < 0.05$ . All analyses were performed using TIBCO Statistica® 13.3.0 (StatSoft Poland, Ltd. Kraków, Poland).

#### 4. Results

Statistical analysis of the primary data obtained as a result of the research, allowed, within the assumed scope, to determine the measurable indicators and correlations used to evaluate the cooperation of RTOs with its member entities in Poland. The main focus was on the issues of cooperation (relations) of entities in the tourism sector in individual administrative regions of Poland, and on the comparative analysis of the activities and cooperation of RTOs—before and during the COVID-19 pandemic. The status and significance of the RTOs' activities, both before the pandemic (BP) and during the pandemic (DP), in terms of marketing activities (MA), and support strategy activities (SSA), were assessed using the 11 types of RTO activity spheres and cooperating entities; these were then subsequently assessed on a scale of 0 to 5 points. The opinions of individual institutions regarding the type and degree of undertaken activities—before and during the COVID-19 pandemic—expressed on a 6-point scale, indicate a very similar status in terms of synthetic values. It was decided to present the research results as a continuum (before and during the COVID-19 pandemic), and in some sections there were also future implications for both analyzed periods as inextricably linked, interacting with each other, as well as allowing for comparative analyses.

Detailed research results are presented by the median of scoring, divided into marketing activity variables ( $Me_{ma}$ ), and support strategy variables ( $Me_{ss}$ ), as shown in Table 1. With regard to the various forms of activity of the surveyed organizations that were implemented before the COVID-19 pandemic, the distinguishing indicators were characterized

by the following spheres: cooperation with the environment and relations with stakeholders ( $Me_{ma} = 5.0$ ); tourist information ( $Me_{ma} = 5.0$ ); and product development ( $Me_{ma} = 4.0$ ). The lowest values of the indicators were characteristic of such forms of the RTOs' booking tourist services ( $Me_{ma} = 1.0$ ) and crisis management ( $Me_{ss} = 2.5$ ).

**Table 1.** Assessment of the importance of selected activity forms of RTOs in the period before the pandemic and during the pandemic on a 0–5 scale (median  $\pm$  quartile deviation)—Wilcoxon's test for differences.

	Before the Pandemic BP	During the Pandemic DP	MED $\pm$ QD Differences	<i>p</i> -Value
Marketing activities (MA)				
Traditional promotional activities	4.0 $\pm$ 0.5	3.0 $\pm$ 0.5	−2.0 $\pm$ 0.75	0.002
Modern promotional activities	4.0 $\pm$ 0.5	5.0 $\pm$ 0.0	0.5 $\pm$ 0.5	0.169
Tourist information	5.0 $\pm$ 0.5	3.5 $\pm$ 0.5	−0.5 $\pm$ 1.0	0.012
Service reservation	1.0 $\pm$ 1.75	2.5 $\pm$ 2.0	0.0 $\pm$ 1.25	0.441
Product development	4.0 $\pm$ 0.5	4.0 $\pm$ 0.5	−0.5 $\pm$ 0.5	0.024
Support strategy activities (SSA)				
Planning of tourism development	4.0 $\pm$ 0.25	4.0 $\pm$ 0.75	0.0 $\pm$ 0.75	0.959
Development of human resources	4.0 $\pm$ 0.0	4.0 $\pm$ 0.75	0.0 $\pm$ 0.75	0.767
Development of ICT	4.0 $\pm$ 1.5	5.0 $\pm$ 0.5	1.0 $\pm$ 0.5	0.008
Crisis management	2.5 $\pm$ 0.75	4.5 $\pm$ 1.0	1.5 $\pm$ 0.75	0.003
Cooperation with the environment	5.0 $\pm$ 0.5	5.0 $\pm$ 0.5	0.0 $\pm$ 0.0	0.345
Promoting the idea of sustainable development	4.0 $\pm$ 0.75	4.0 $\pm$ 0.75	0.0 $\pm$ 0.5	0.477

MED—Median; QD—quartile deviation; and statistical significance at  $p < 0.05$ . Source: own elaboration based on surveys.

During the COVID-19 pandemic, a substantial change in the significance and intensity of many directions of the surveyed organizations' activities is noticeable, especially in what were the previously dominant spheres, now in favor of activities that were—in many cases—complementary or secondary before the pandemic. Among the distinguishing indicators of the importance of the forms of RTOs' activity in the pandemic period, actions in the field of support strategies were noted. Marketing activities were characterized by lower values of indicators. The highest rates ( $Me_{ma} = 5.0$ ) in the sphere of RTOs' activities during the pandemic were characterized by modern promotional activities, as well as cooperation with the environment and relations with stakeholders ( $Me_{ss} = 5.0$ ), as well as the development of information systems and technologies ( $Me_{ss} = 5.0$ ). It should be clearly emphasized here that the values of indicators of the surveyed RTOs, in terms of member and the environment support strategy, definitely exceeded the values of indicators for marketing activities (including for the benefit of RTOs members). These values being, respectively, at the level of: SSA = ( $Me_{ss} = 4.0$ – $5.0$ ), MA = ( $Me_{ma} = 2.5$ – $5.0$ ).

The assessment of the importance of selected RTOs' activity forms, both before the pandemic and during the COVID-19 pandemic, is presented in Table 1. During the pandemic (according to the respondents' assessments) there was a significant decrease in the importance of RTOs' marketing activities related to traditional promotional activities ( $p = 0.002$ ), tourist information ( $p = 0.012$ ), and the development of tourism products ( $p = 0.024$ ). Compared to the period before the pandemic, the importance of the strategy of supporting the development of technologies, information systems ( $p = 0.008$ ), and crisis management ( $p = 0.003$ ) in the pandemic period was rated higher. The significance of other forms of RTOs' activity was assessed as similar in both analyzed periods ( $p > 0.05$ ).

Most RTOs identified the negative effects of the COVID-19 pandemic (AR1–8) on their activities and their relations with the environment (SR1–3), both administrative and social, i.e., 62.5% of responses. It should be noted that a quarter of organizations do not see changes in their relations with the closer and more distant environment, and therefore in their own activities, which would be a consequence of the impact of the pandemic

(see Figure 3). Only one out of six organizations that declared no adverse impact from the pandemic reported no limitations or restraints during this period. Two organizations assessed the impact of the pandemic on their activities as positive, but both indicated a few limitations that constituted, albeit to a small extent, a negative impact of the pandemic on their functioning.

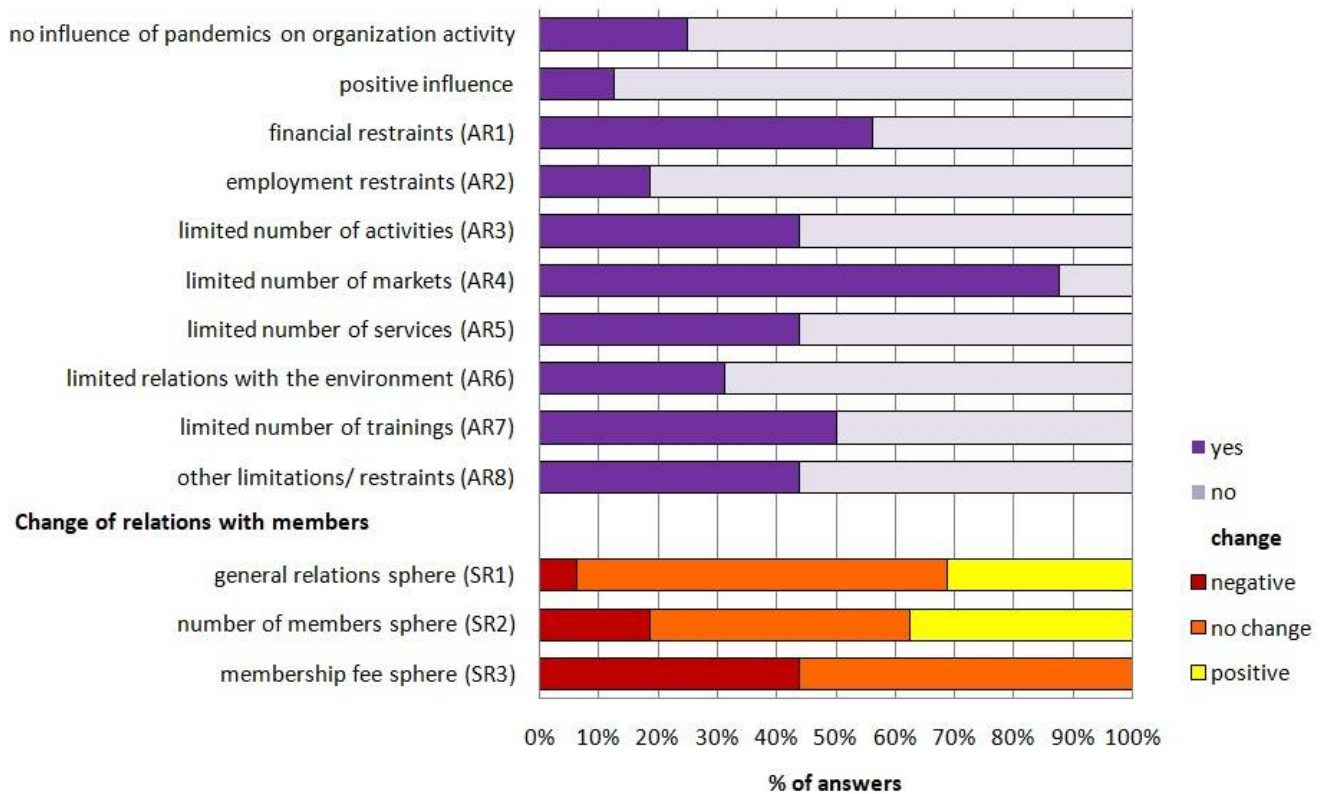

**Figure 3.** Influence of COVID-19 pandemic on the organizations’ activities (AR1–8) and structural relations of RTOs (SR1–3) (n = 16). Source: own elaboration based on surveys.

Among the total indicated limitations (AR1–8) (see Figure 3), resulting from the pandemic, which accompanied contacts and the relations of the organization with the environment and their core activities, the most frequently indicated limitation was the number of markets where activities were taken (AR4 = 88%,  $p < 0.001$ ), limited financing of the organization’s activities (AR1 = 56%,  $p > 0.05$ ), and limitation of activities in the area of pro-tourism training (AR7 = 50%,  $p > 0.05$ ). Most RTOs found no impact of the pandemic on employment (AR2 = 19%,  $p < 0.001$ ) or cooperation with the environment (AR6 = 31%,  $p = 0.034$ ).

In the majority of the studied RTOs, pandemic conditions did not result in significant changes in the relations with member entities (SR1–3). In terms of three specific spheres: general relations (SR1), the number of members (SR2), and membership fees (SR3) similar indications of the surveyed organizations were recorded, thus defining the impact of the pandemic at a neutral level. In the highest dimension, the lack of impact of the COVID-19 pandemic on inter-subject relations in RTOs was determined in terms of general relations (SR1 = 62.5% of responses). On the other hand, the increase in the level of relations under the influence of the pandemic was indicated by the surveyed organizations most often in terms of the change in the number of members (SR2 = 37.5% of responses). No significant deterioration of the RTOs’ relationship with member entities was observed, save for the observed reduction in the amount of membership fees as a result of the pandemic (SR3 = 44%,  $p > 0.05$ ).

The most common activities undertaken by RTOs in supporting members (AT1–8) were free promotional activities for members. This was assessed at the maximum rate

(AT4 = 100%) and also the organization of the trainings (AT3 = 87.5%) (see Figure 4). In the case of other activities undertaken by the surveyed organizations for and within mutual relations with member entities, the indicators did not exceed 50%. Most of the organizations did not reduce the cost of providing their own services for their members (AT5 = 6.3%) or the amount of membership fees (AT2 = 31.3%), and did not implement assistance in the preparation of applications for commercially available subsidies under pandemic conditions (AT7 = 12.5%).

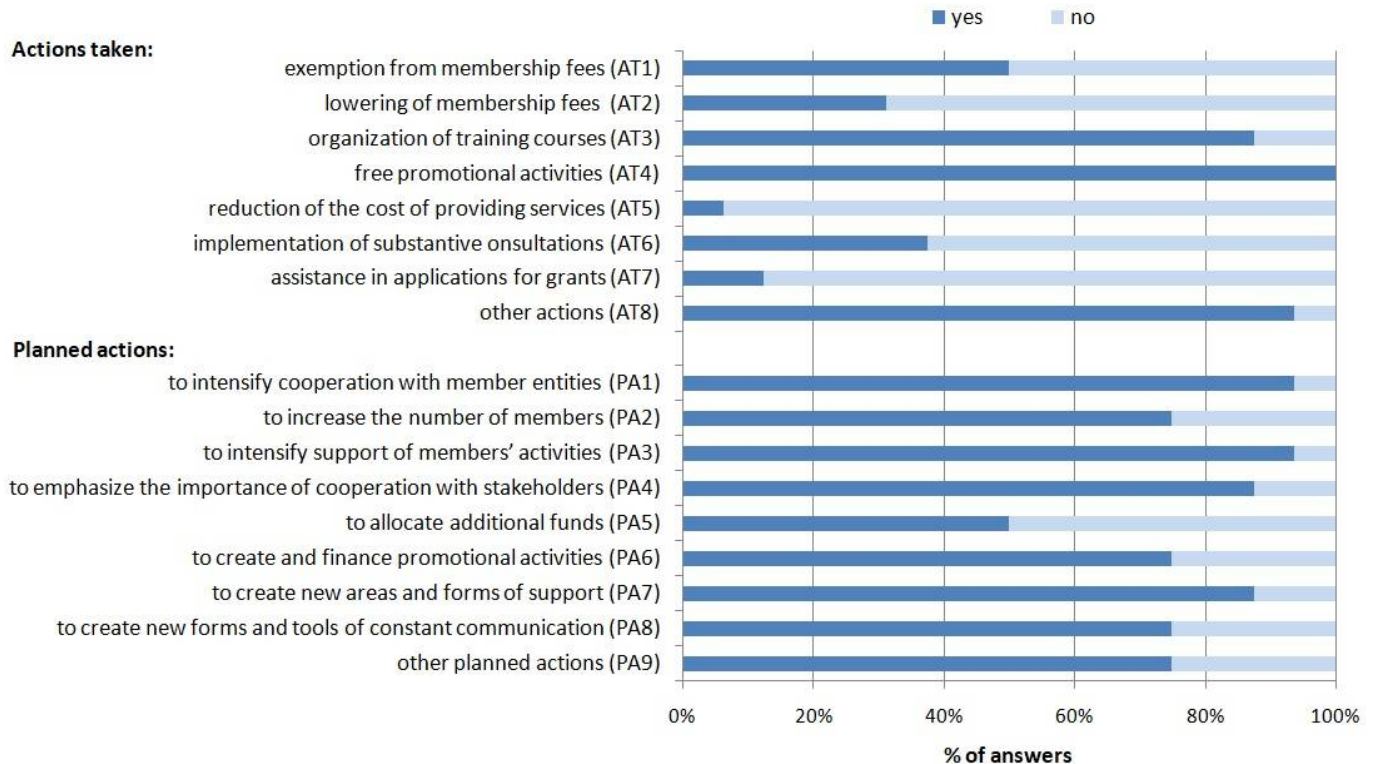

**Figure 4.** Actions taken and planned by RTOs to support member entities during the pandemic. Source: own elaboration based on surveys.

In terms of the “return to normal”, all RTOs declared planning from three to nine activities (PA1–9) in the area of cooperation with member entities (see Figure 4). Among the distinguishing indicators of the surveyed organizations, the activities of intensifying cooperation and increasing support in the activities of member entities (PA1 and PA3, respectively = 93.8%) dominated. Nearly 90% of activities planned by the surveyed organizations to strengthen the level of relations between member entities were focused on the spheres of emphasizing the importance of cooperation with stakeholders (PA4 = 87.5%) and creating new areas and forms of support (PA7 = 87.5%). In the remaining cases of cooperation-type activities planned by RTOs with the external environment, similar to the activities already undertaken, the lowest value of the financial indicators was observed, which was specified by only half of the surveyed entities as “additional financial support”—PA5 = 50%.

Different types of activities undertaken (AT1–8) and planned (PA1–9) by RTOs did not significantly correlate with the indicated effects of the pandemic (AR1–10  $p > 0.05$  for  $\chi^2$  tests). The conducted analyses verified the relationship between the number of declared actions (AT1–8) and planned actions (PA1–9)—on a scale from 0 to 9, according to Figure 2—as well as the intensity of the negative impact of the pandemic on cooperation with members and the environment (AR1–8; SR1–3) (Figure 3). The intensity of the pandemic’s impact on the activity of RTOs (AR1–8) was assessed by the sum of the restrictions (the number of restrictions from 0 to 8, according to Figure 4) and the sum of changes in relations with member entities (SR1–3)—on a scale of  $-3$  for negative changes in each of the 3 tested areas



to +3 for positive changes in each of the 3 tested areas, according to Figure 3. In Figure 5, the graphs on the diagonal of the diagram matrix show the distribution of the values of variables that were included in the cross-correlation analysis. The dispersion of values against the straight trend line for most correlations between individual variables indicates their poor, or indeed no, covariance. The values of the Spearman's rank coefficients ( $\rho$ ) were included only in those charts that showed significant correlations between the variables. A relationship was observed between the increase in the number of limitations in the RTOs' activity (AR1–8) and unfavorable changes in relations with members (SR1–3) ( $\rho = -0.52$ ,  $p = 0.037$ ), while positive changes in these relations (SR1–3) correlated with a larger number of planned activities to improve cooperation (PA1–9) ( $\rho = 0.51$ ,  $p = 0.045$ ). However, the relationship between the number of actions taken by RTOs (AT1–8) and the adverse effects of the pandemic (AR1–8) identified by them has not been confirmed (see Figure 5).

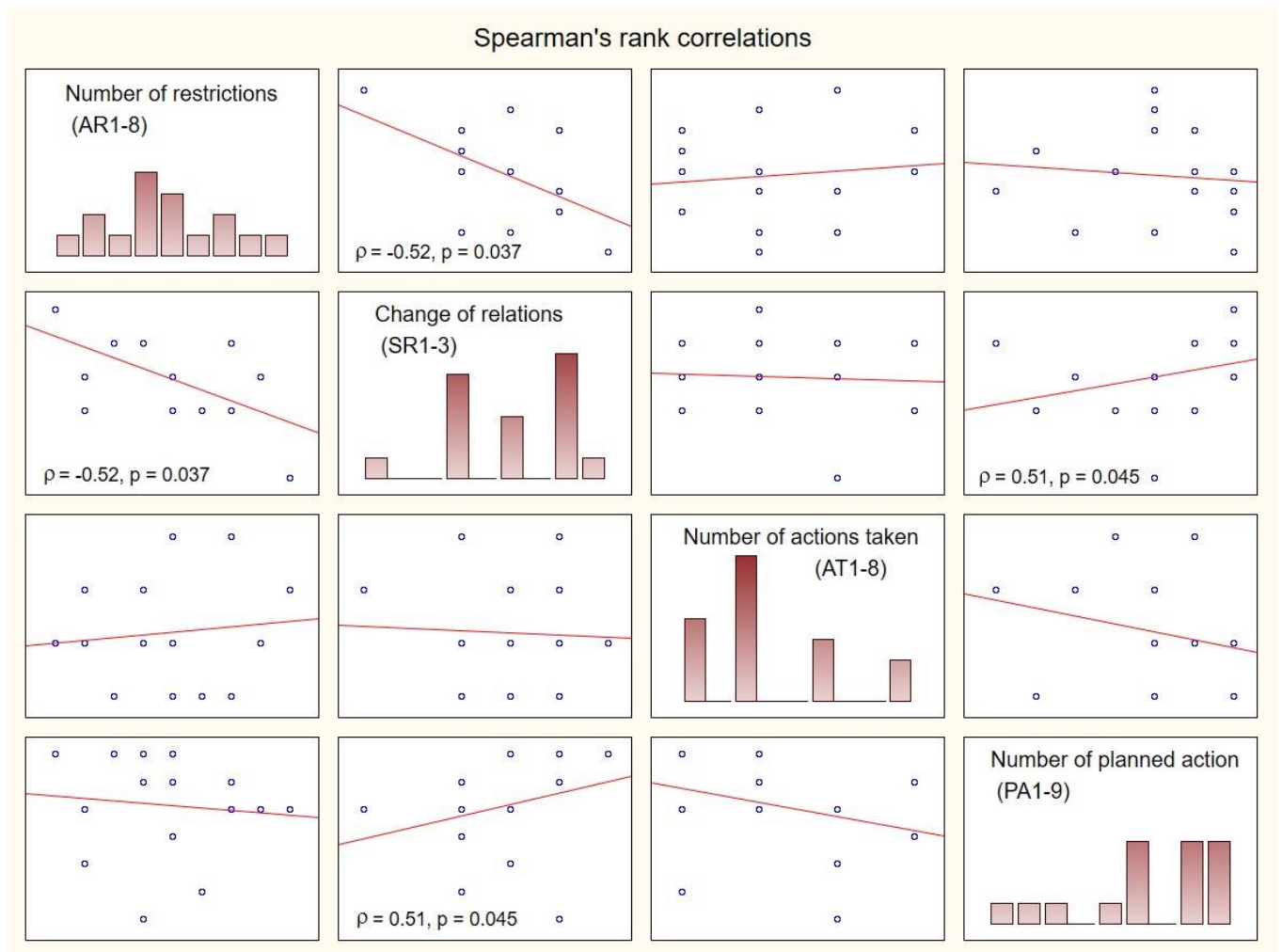

**Figure 5.** Relationships between restrictions on the RTOs' activities, changes in relations with member entities, the undertaken, and planned actions during the COVID-19 pandemic. Note: AR1–8—number of restrictions/constraints on a scale from 0 to 8; SR1–3—change in relations on a scale from –3 for unfavorable to +3 for favorable; AT1–8—number of activities undertaken on a scale from 0 to 8; PA1–9—number of planned activities on a scale from 0 to 9;  $\rho$ —Spearman's correlation coefficient; and  $p$ -value of t-test for the correlation coefficient. Rho and  $p$ -values were reported only for significant correlations. Unmarked scatterplots show correlations of unconfirmed significance. The values of  $\rho$  and  $p$  were reported only for significant correlations, for the correlations in the remaining scatter plots,  $p > 0.05$  was adopted. Source: own elaboration based on surveys.

## 5. Discussion and Conclusions

Focusing on cooperation is inscribed in the functional core of modern tourism organizations in the economy; it is based on knowledge and competences [73,80] and becomes particularly important in the event of emergence of crisis phenomena (i.e., pandemics, acts of terrorism, overtourism, and natural disasters). Additionally, the requirement of comprehensive cooperation, included in the philosophy of each organization operating within the tourist services sector, results from the core offer that these organizations present to their clients or members. Additionally, the paradigm of a modern organization (also often operating as a tourism enterprise), emphasizing the need to cooperate with its members and other business partners, thereby co-creating an offer (here, a regional tourist product) for the client, seems obvious [73].

The role of DMOs in times of crisis is particularly important, which was demonstrated in this study. These organizations, including the studied RTOs, have been shown to engage with and support their stakeholders, both internal and external [81], which at the same time contradicts Hypothesis 1. It has been falsified for most types of relationships and forms of activity for the benefit of organization members. Only the negative impact of the COVID-19 pandemic on the number of markets for the RTOs' marketing activities, conducted in cooperation with members of the organization, was confirmed. These activities must be planned and require both time and close coordination to avoid potential conflicts with stakeholders [82].

The functioning of DMOs in crisis situations should also accelerate the transition from the traditional dimension of the organization (M—marketing) to the concept of DMOs understood through the prism of “management” [44]; in other words, the transition from destination marketing to destination management [83]. This was confirmed in the conducted studies, which showed that during the COVID-19 pandemic the surveyed organizations put more emphasis on strictly nonmarketing activities (see Hypothesis 2), thereby focusing their attention on the operational activities of the RTOs for the benefit of members via destination management in crisis conditions. Thus, it seems necessary to justify the change in the philosophy of the DMOs' operation, with a transition from intervention through promotion to coordination of stakeholder activities in areas of common interest [84]. This, at the same time, corresponds with Hypothesis 3 (which is confirmed in the research) i.e., about the existing limitations in the undertaking or planning by RTOs' new or additional forms of activities; this being for the benefit of organization members in order to reduce the adverse effects of the COVID-19 pandemic. As a consequence, DMOs and stakeholders can contribute to maximizing mutual benefits [85].

The results of the research obtained by the authors also confirm other analyses, e.g., references [39,86,87] carried out so far that relate to changes in DMOs under the conditions of the COVID-19 pandemic, which also corresponds to the adopted and achieved main goal of the study. This resulted in destination management organizations' (DMO) and policymakers' interventions in the tourism industry, for instance by providing stimulus payments to the tourism industry, or by restricting mobility and ordering business closures [39]. Research carried out by Kuščeret et al. [86] confirm the involvement of DMOs in the process of reviving tourism. Organizations are expected not only to provide tangible help (such as applying for subsidies, advertising, or promotion), but also to support cooperation between stakeholders. According to Pillmayer et al. [87], DMOs will often focus on short-term goals, including operations and stakeholder management. In a context of constant time pressure and a reluctance to take high risks, there is little time for dealing with long-term strategic issues, such as innovation management and related organizational approaches. Nevertheless, this research has shown that the planned activities in the context of stakeholder support are far-reaching and go beyond those currently implemented. Hence, the scope of cooperation between DMOs and stakeholders will play an increasingly important role [88].



### 5.1. Theoretical Implications

In destination management, interactions between complex networks of public and private stakeholders cocreate value [89,90]. The selection and involvement of individual stakeholders determines the final shape of tourism management system in a destination, and a special role in this respect is assigned to DMOs. A DMO's governance model determines its ability to catalyze broad-based participatory stakeholder decision making [91]. Hence, DMOs can, and should, be required to be fully involved in the process of creating a competitive destination, together with all stakeholders. This process should also take into account crisis situations that are faced by modern tourism.

The conducted analysis clearly confirmed the importance of cooperation in the tourism sector and in the organizations representing it. At the same time, the research made it possible to identify the key variables describing the nature of the relationship of RTOs with members and the environment in the period of crisis, which is in line with the adopted intermediate goal of the study. The deliberations in this paper complement the considerations related to crisis management in the tourism industry so far, especially in the context of the impact of the COVID-19 pandemic on tourism [1,39,92,93]. This is even more important, as nowadays, given the global outbreak of the COVID-19 pandemic and the economic downturn faced by many countries, crisis management has again attracted organizational and research attention [20,94]. In particular, this paper fills the theoretical gap related to the involvement of destination management organizations in relationships with stakeholders in the time of the COVID-19 pandemic. It indicates the directions of activities that can be used by other researchers in the context of supporting stakeholders via DMOs and other tourism organizations.

In addition, the obtained results may be a starting point for wider research in the field of building organizational resilience in regard to the impact of crisis phenomena. This issue seems to be of particular importance to the tourism and hotel industry, as achieving organizational resilience when a sudden crisis or a disaster occurs is important for the sustained growth of tourism organizations [95]. Resilience frameworks can be used to better understand vulnerability to crises and disasters at the planning and prevention phase. However, it can also help us to better understand response strategies and future planning (i.e., in building future resilience) [96]. Additionally, organizations should consider crisis and disaster management resilience as an important part of their culture [97]. Therefore, the research results may contribute to further attempts to develop original, new concepts, relating to building relationships between destination management organizations and stakeholders. This issue seems to be important not only from the COVID-19 pandemic perspective, but also in other potential crisis situations.

### 5.2. Practical Implications

The negative impact of the COVID-19 pandemic on the functioning of RTOs, in terms of their relations with member entities (here: joint marketing activities for members of the organization), revealed in the research, provokes reflection. Therefore, urgent actions by RTOs—aimed at developing multidirectional principles of cooperation and shaping relations with members of tourism organizations during crisis phenomena (that are not, as stated before, uncommon cases in the tourism economy)—are necessary. RTOs must adapt their activities to the changing reality resulting from the COVID-19 pandemic, while struggling to maintain a proper image, and in a wider context, to restore the prepandemic situation. Contemporary travelers' tendency to avoid a number of types of destinations, and forms of international travel (also regarding COVID-19 threats) should persuade RTOs to take appropriate measures to strengthen the promotion of domestic tourism, including those based on intensified relations with their members.

Against the backdrop of the literature review, it is also worth noting that the methods and techniques for assessing relations with DMO members in the event of crisis phenomena are few and based mainly on survey research, which implies difficulties in obtaining a representative sample of empirical research respondents (who are often reluctant to express

an opinion). Nevertheless, the methodology and technique of researching the functional relationships within an organization during the COVID-19 pandemic, adopted by the authors, can be implemented in the organizational practice in RTOs, or in other organizations responsible for development of tourism in the region, due to their functionality, nearly zero costs, and simplicity of implementation (thus one of the intermediate objectives of the study was successfully implemented).

### 5.3. Limitations and Further Research

This study has some limitations, because in-depth considerations focus on the analyses of only a few selected variables (out of a total of 21 in the survey), but the obtained results can be considered an interesting basis for comparative analyses of the nature of relations with members of other types of organizations (i.e., DMOs) acting for the development of tourism at the local or regional level. This paper is based on the subjective opinions of RTOs' representatives, nevertheless, the opinions obtained from this group of stakeholders allowed this study to capture the overall approach of the organization to shaping relations with members in times of crises in the tourism economy, including those caused by phenomena such as the COVID-19 pandemic.

There is a need to broaden the spectrum of assessing the quality of relations between tourism organizations (including RTOs or other types of DMOs) with the tourism economy stakeholders, which is now becoming a strategic goal of researchers from many scientific disciplines. This is justified in the light of the results of available research and empirical analyses, which show that relations in organizations are perceived as a phenomenon (feature) shaping the position of an organization, its specific brand, and are often also treated as an indicator of its effectiveness and efficiency. Nevertheless, while exercising caution in inference, it can also be indicated that the study and assessment of these relationships in tourism organizations with a smaller scale of activity (or, in any case, less numerous) are often marginalized. An interesting research challenge in the near future is also the assessment of the impact of other random crisis phenomena—such as wars or natural disasters—which drastically limit the development of many tourism spheres, on tourism organizations and membership relations. Searching for the synergy of tourism stakeholders' interests (as concentrated in organizations) in crisis situations in the environment, should become a priority for the entire tourism industry, including researchers studying DMOs.

**Supplementary Materials:** The following supporting information can be downloaded at: <https://www.mdpi.com/article/10.3390/su141912671/s1>, Questionnaire: Cooperation and Activity of Regional Destination Management Organizations (DMO) with Various Member Organization Entities in the COVID-19 Pandemic Period.

**Author Contributions:** Conceptualization, W.F., M.S. and J.B. (Jacek Borzyszkowski); methodology, W.F., M.S., J.B. (Justyna Bagińska) and M.K.; formal analysis, W.F., M.S., J.B. (Jacek Borzyszkowski), M.K., J.B. (Justyna Bagińska) and M.Z.; investigation, W.F., M.S., J.B. (Jacek Borzyszkowski), M.K., J.B. (Justyna Bagińska) and M.Z.; resources, W.F., M.S. and J.B. (Jacek Borzyszkowski); writing—original draft preparation, writing—review and editing, W.F., M.S., J.B. (Jacek Borzyszkowski), M.K., J.B. (Justyna Bagińska) and M.Z.; supervision, W.F., M.S. and J.B. (Jacek Borzyszkowski); project administration, W.F., M.S. and J.B. (Jacek Borzyszkowski); translations, J.B. (Justyna Bagińska); software, visualization, M.K. All authors have read and agreed to the published version of the manuscript.

**Funding:** This research received no external funding.

**Institutional Review Board Statement:** Not applicable.

**Informed Consent Statement:** Not applicable.

**Data Availability Statement:** Not applicable.

**Acknowledgments:** We are particularly grateful to the management of the Regional Tourism Organizations (DMOs regional level) in Poland for supporting the research process.

**Conflicts of Interest:** The authors declare no conflict of interest.

## References

1. Fedyk, W.; Sołtysik, M.; Bagińska, J.; Ziemia, M.; Kołodziej, M.; Borzyszkowski, J. Changes in DMO's Orientation and Tools to Support Organizations in the Era of the COVID-19 Pandemic. *Sustainability* **2022**, *14*, 11611. [CrossRef]
2. Freeman, R.E. *Strategic Management: A Stakeholder Approach*; Cambridge University Press: Cambridge, UK, 2015. [CrossRef]
3. Okumus, F.; van Niekerk, M.; Koseoglu, M.A.; Bilgihan, A. Interdisciplinary research in tourism. *Tour. Manag.* **2018**, *69*, 540–549. [CrossRef]
4. UNWTO. Overtourism? Understanding and Managing Urban Tourism Growth Beyond Perceptions. 2018. Available online: [www.e-unwto.org/doi/book/10.18111/9789284419999](http://www.e-unwto.org/doi/book/10.18111/9789284419999) (accessed on 1 February 2022).
5. Andriotis, K. Community Groups Perceptions of and Preferences for Tourism Development: Evidence from Crete. *J. Hosp. Tour. Res.* **2005**, *29*, 67–90. [CrossRef]
6. McCabe, S.; Sharples, M.; Foster, C. Stakeholder engagement in the design of scenarios of technology-enhanced tourism services. *Tour. Manag. Perspect.* **2012**, *4*, 36–44. [CrossRef]
7. Šegota, T.; Mihalič, T.; Kuščer, K. The impact of residents' informedness and involvement on their perceptions of tourism impacts: The case of Bled. *J. Destin. Mark. Manag.* **2017**, *6*, 196–206. [CrossRef]
8. Canavan, B. Tourism stakeholder exclusion and conflict in a small island. *Leis. Stud.* **2017**, *36*, 409–422. [CrossRef]
9. Hatipoglu, B.; Alvarez, M.D.; Ertuna, B. Barriers to stakeholder involvement in the planning of sustainable tourism: The case of the Thrace region in Turkey. *J. Clean. Prod.* **2016**, *111*, 306–317. [CrossRef]
10. Zmysłony, P.; Pilarczyk, M. Identification of overtourism in Poznań through the analysis of social conflicts. *Stud. Perieget.* **2020**, *30*, 9–24. [CrossRef]
11. Byrd, E.T. Stakeholders in sustainable tourism development and their roles: Applying stakeholder theory to sustainable tourism development. *Tour. Rev.* **2007**, *62*, 6–13. [CrossRef]
12. Hieu, V.M.; Rašovská, I. A proposed model on Stakeholders Impacting on Destination Management as mediator to achieve sustainable tourism development. *Trendy V Podn.* **2018**, *8*, 90–102. [CrossRef]
13. Abbasian, S.; Onn, G.; Arnautovic, D. Overtourism in Dubrovnik in the eyes of local tourism employees: A qualitative study. *Cogent Soc. Sci.* **2020**, *6*, 1775944. [CrossRef]
14. Moreno Mendoza, H.; Santana Talavera, A.; León, C.J. The Role of Stakeholder Involvement in the Governance of Tourist Museums: Evidence of Management Models in the Canary Islands. *Herit. Soc.* **2018**, *11*, 229–248. [CrossRef]
15. Kiryluk, H.; Glińska, E.; Ryciuk, U.; Vierikko, K.; Rollnik-Sadowska, E. Stakeholders engagement for solving mobility problems in touristic remote areas from the Baltic Sea Region. *PLoS ONE* **2021**, *16*, e0253166. [CrossRef] [PubMed]
16. Arizpe, M.; Arizpe, O.; Gamez, A. Communication and public participation processes in the sustainable tourism planning of the first capital of the Californias. *WIT Trans. Ecol. Environ.* **2008**, *115*, 7. [CrossRef]
17. Ong, C.-E.; Minca, C.; Felder, M. The historic hotel as 'quasi-freedom machine': Negotiating utopian visions and dark histories at Amsterdam's Lloyd Hotel and 'Cultural Embassy'. *J. Herit. Tour.* **2014**, *10*, 167–183. [CrossRef]
18. Grzeszczyk, T. *Metody Oceny Projektów z Dofinansowaniem Unii Europejskiej*; Wydawnictwo Placet: Warsaw, Poland, 2006.
19. Dolnicar, S.; Zare, S. COVID19 and Airbnb—Disrupting the Disruptor. *Ann. Tour. Res.* **2020**, *83*, 102961. [CrossRef]
20. Gössling, S.; Scott, D.; Hall, C.M. Pandemics, tourism and global change: A rapid assessment of COVID-19. *J. Sustain. Tour.* **2021**, *29*, 1–20. [CrossRef]
21. Nientied, P. Rotterdam and the question of new urban tourism. *Int. J. Tour. Cities* **2020**, *7*, 344–360. [CrossRef]
22. Vegnuti, R. Cinque Terre, Italy—A case of place branding: From opportunity to problem for tourism. *Worldw. Hosp. Tour. Themes* **2020**, *12*, 471–483. [CrossRef]
23. UNWTO. 2020: Worst Year in Tourism History with 1 Billion Fewer International Arrivals. 2021. Available online: <https://www.unwto.org/news/2020-worst-year-in-tourism-history-with-1-billion-fewer-international-arrivals> (accessed on 7 February 2022).
24. Bausch, T.; Gartner, W.C.; Ortanderl, F. How to Avoid a COVID-19 Research Paper Tsunami? A Tourism System Approach. *J. Travel Res.* **2020**, *60*, 467–485. [CrossRef]
25. Uğur, N.G.; Akbıyık, A. Impacts of COVID-19 on global tourism industry: A cross-regional comparison. *Tour. Manag. Perspect.* **2020**, *36*, 100744. [CrossRef] [PubMed]
26. Tiwari, P.; Chowdhary, N. Czy pandemia COVID-19 czasowo zatrzymała zjawisko overtourism? *Turyzm/Tourism* **2021**, *31*, 91–96. [CrossRef]
27. Correa-Martínez, C.L.; Kampmeier, S.; Kümpers, P.; Schwierzeck, V.; Hennies, M.; Hafezi, W.; Kühn, J.; Pavenstädt, H.; Ludwig, S.; Mellmann, A. A Pandemic in Times of Global Tourism: Superspreading and Exportation of COVID-19 Cases from a Ski Area in Austria. *J. Clin. Microbiol.* **2020**, *58*, e00588-20. [CrossRef] [PubMed]
28. Sharma, G.D.; Thomas, A.; Paul, J. Reviving tourism industry post-COVID-19: A resilience-based framework. *Tour. Manag. Perspect.* **2020**, *37*, 100786. [CrossRef]
29. Zielinski, S.; Botero, C.M. Beach Tourism in Times of COVID-19 Pandemic: Critical Issues, Knowledge Gaps and Research Opportunities. *Int. J. Environ. Res. Public Health* **2020**, *17*, 7288. [CrossRef]
30. Wassler, P.; Fan, D.X. A tale of four futures: Tourism academia and COVID-19. *Tour. Manag. Perspect.* **2021**, *38*, 100818. [CrossRef]
31. Godovykh, M.; Ridderstaat, J. Health outcomes of tourism development: A longitudinal study of the impact of tourism arrivals on residents' health. *J. Destin. Mark. Manag.* **2020**, *17*, 100462. [CrossRef]

32. Ahmed, M.Z.; Ahmed, O.; Aibao, Z.; Hanbin, S.; Siyu, L.; Ahmad, A. Epidemic of COVID-19 in China and associated Psychological Problems. *Asian J. Psychiatry* **2020**, *51*, 102092. [CrossRef]
33. Kock, F.; Nørfelt, A.; Josiassen, A.; Assaf, A.G.; Tsonas, M.G. Understanding the COVID-19 tourist psyche: The Evolutionary Tourism Paradigm. *Ann. Tour. Res.* **2020**, *85*, 103053. [CrossRef]
34. Zenker, S.; Kock, F. The coronavirus pandemic—A critical discussion of a tourism research agenda. *Tour. Manag.* **2020**, *81*, 104164. [CrossRef]
35. Wen, J.; Kozak, M.; Yang, S.; Liu, F. COVID-19: Potential effects on Chinese citizens' lifestyle and travel. *Tour. Rev.* **2020**, *76*, 74–87. [CrossRef]
36. Lehto, X.; Davari, D.; Park, S. Transforming the guest–host relationship: A convivial tourism approach. *Int. J. Tour. Cities* **2020**, *6*, 1069–1088. [CrossRef]
37. Tomes, N. “Destroyer and Teacher”: Managing the Masses during the 1918–1919 Influenza Pandemic. *Public Health Rep.* **2010**, *125*, 48–62. [CrossRef] [PubMed]
38. Seraphin, H.; Ivanov, S. Overtourism: A revenue management perspective. *J. Revenue Pricing Manag.* **2020**, *19*, 146–150. [CrossRef]
39. Sigala, M. Tourism and COVID-19: Impacts and implications for advancing and resetting industry and research. *J. Bus. Res.* **2020**, *117*, 312–321. [CrossRef]
40. Niezgoda, A.; Markiewicz, E.; Kowalska, K. *Internal Substitution in the Tourism Market: Effects of the Covid-19 Pandemic*; Poznań University of Economics and Business Press: Poznań, Poland, 2021; pp. 127–136. [CrossRef]
41. Gupta, V.; Cahyanto, I.; Sajnani, M.; Shah, C. Changing dynamics and travel evading: A case of Indian tourists amidst the COVID 19 pandemic. *J. Tour. Futur.* **2021**; ahead of print. [CrossRef]
42. Collins-Kreiner, N.; Ram, Y. National tourism strategies during the Covid-19 pandemic. *Ann. Tour. Res.* **2020**, *89*, 103076. [CrossRef]
43. Paquin, A.G.; Schwitzguébel, A.C. Analysis of Barcelona's tourist landscape as projected in tourism promotional videos. *Int. J. Tour. Cities* **2021**, *7*, 257–277. [CrossRef]
44. Borzyszkowski, J. Organizacje Zarządzające Obszarami Receptji Turystycznej. In *Istota, Funkcjonowanie, Kierunki Zmian*; Wydawnictwo Uczelniane Politechniki Koszalińskiej: Koszalin, Poland, 2015.
45. Baidal, J.A.I. REGIONAL TOURISM PLANNING IN SPAIN. *Ann. Tour. Res.* **2004**, *31*, 313–333. [CrossRef]
46. Lopes, A.P.F.; Muñoz, M.M.; Alarcón-Urbistondo, P. Regional tourism competitiveness using the PROMETHEE approach. *Ann. Tour. Res.* **2018**, *73*, 1–13. [CrossRef]
47. Perkins, R.; Khoo-Lattimore, C.; Arcodia, C. Understanding the contribution of stakeholder collaboration towards regional destination branding: A systematic narrative literature review. *J. Hosp. Tour. Manag.* **2020**, *43*, 250–258. [CrossRef]
48. Kamann, S. *Destination Marketing Organizations in Europe. An In-Depth Analysis*; Destination Marketing Association International (DMAI)–NHTV Breda University of Applied Sciences: Breda, The Netherlands, 2008.
49. Bramwell, B.; Lane, B. Critical research on the governance of tourism and sustainability. *J. Sustain. Tour.* **2011**, *19*, 411–421. [CrossRef]
50. Nipa, N.J.; Sultana, J.; Rahman, H. Prospect of Private-Public Partnership in Tourism of Bangladesh. *J. Investig. Manag.* **2015**, *4*, 73. [CrossRef]
51. Gkoumas, A. Evaluating a standard for sustainable tourism through the lenses of local industry. *Heliyon* **2019**, *5*, e02707. [CrossRef] [PubMed]
52. Valente, F.; Dredge, D.; Lohmann, G. Leadership and governance in regional tourism. *J. Destin. Mark. Manag.* **2015**, *4*, 127–136. [CrossRef]
53. Zahra, A. *Regional Tourism Organisations in New Zealand from 1980 to 2005: Process of Transition and Change*; Department of Tourism and Hospitality Management University of Waikato: Hamilton, New Zealand, 2006.
54. Klimek, K.; Doctor, M. Are alpine destination management organizations (DMOs) appropriate entities for the commercialization of summer tourism products? *J. Destin. Mark. Manag.* **2018**, *10*, 181–190. [CrossRef]
55. Malenkina, N.; Ivanov, S. A linguistic analysis of the official tourism websites of the seventeen Spanish Autonomous Communities. *J. Destin. Mark. Manag.* **2018**, *9*, 204–233. [CrossRef]
56. Pike, S.; Ives, C. The restructuring of New Zealand's Regional Tourism Organisations. *J. Destin. Mark. Manag.* **2018**, *9*, 371–373. [CrossRef]
57. Presenza, A. *The Performance of a Tourist Destination. Who Manages the Destination? Who Plays the Audit Role?* University of Molise: Campobasso, Italy, 2005.
58. Hay, B. The independence referendum in Scotland: A tourism perspective on different political options. *J. Tour. Futur.* **2016**, *2*, 125–136. [CrossRef]
59. Kalandides, A.; Kavartzis, M.; Boisen, M.; Atorough, P.; Martin, A. The politics of destination marketing. *J. Place Manag. Dev.* **2012**, *5*, 35–55. [CrossRef]
60. Fedyk, W.; Sołtysik, M.; Oleśniewicz, P.; Borzyszkowski, J.; Weinland, J. Human resources management as a factor determining the organizational effectiveness of DMOs: A case study of RTOs in Poland. *Int. J. Contemp. Hosp. Manag.* **2021**, *33*, 828–850. [CrossRef]
61. Jeuring, J.H. Discursive contradictions in regional tourism marketing strategies: The case of Fryslân, The Netherlands. *J. Destin. Mark. Manag.* **2016**, *5*, 65–75. [CrossRef]

62. Wojciechowska, J. Ścieżki rozwoju organizacyjnego turystyki w Polsce—Od rewolucyjnego po ewolucyjny system. *Pr. Nauk. Univ. Ekon. We Wrocławiu* **2012**, *258*, 89–102.
63. Zawilińska, B. Działalność lokalnych organizacji turystycznych w Karpatach Polskich. *Zesz. Nauk. Univ. Ekon. W Krakowie* **2010**, *842*, 103–119.
64. Borzyszkowski, J. *Organizacja i Zarządzanie Turystyką w Polsce*; CeDeWu: Warszawa, Poland; Wyższa Szkoła Bankowa w Gdańsku: Gdańsk, Poland, 2011.
65. USTAWA z dnia 25 czerwca 1999 r. o Polskiej Organizacji Turystycznej. Available online: <https://www.pot.gov.pl/attachments/article/1420/Tekst%20jednolity%20ustawy%20o%20Polskiej%20Organizacji%20Turystycznej.pdf> (accessed on 10 August 2022).
66. Morrison, A.M. *Marketing and Managing Tourism Destinations*; Routledge: London, UK, 2013. [CrossRef]
67. Pike, S. *Destination Marketing: An Integrated Marketing Communication Approach*; Elsevier: Amsterdam, The Netherlands, 2008; Volume 1.
68. Dębski, M. Współpraca interesariuszy destynacji w procesie kreowania jej konkurencyjności. *Organ. I Kierowanie. Organ. Manag.* **2012**, *152*, 73–86.
69. Walas, B. *Marketingowa Strategii Rozwoju Turystyki POT 2012–2020*; Polska Organizacja Turystyczna: Warszawa, Poland, 2012.
70. Ministerstwo Rozwoju, Pracy i Technologii. Available online: <https://www.gov.pl/web/rozwoj-praca-technologia/departament-turystyki>. (accessed on 12 March 2022).
71. Żegleń, P.; Rzepko, M. Działalność regionalnych organizacji turystycznych (ROT-ów) i ich wpływ na rozwój turystyki w regionie na przykładzie Podkarpackiej Regionalnej Organizacji Turystycznej. *Ekon. Probl. Tur.* **2018**, *41*, 113–120.
72. Lulewicz-Sas, A. Ewaluacja jako narzędzie doskonalenia organizacji. *Optimum. Stud. Ekon.* **2013**, *3*, 101–111. [CrossRef]
73. Fedyk, W.; Morawski, M. Regionalne organizacje turystyczne—Organizacjami współpracy. Prawda czy fałsz? *Folia Tur.* **2014**, *32*, 241–274.
74. Fedyk, W. Struktura zarządów regionalnych organizacji turystycznych w Polsce jako uwarunkowanie skuteczności działania organizacji. *Rozpr. Nauk. Akad. Wych. Fiz. We Wrocławiu* **2015**, *51*, 26–37.
75. Fedyk, W. Regionalne organizacje turystyczne jako Destination Management Company—Probiznesowy model działania. *Folia Tur.* **2018**, *47*, 27–52. [CrossRef]
76. Fedyk, W.; Morawski, M.; Bakowska-Morawska, U.; Langer, F.; Jandová, S. Model of cooperation in the network of non-enterprise organizations on the example of Regional Tourist Organizations in Poland. *Ekon. Probl. Tur.* **2018**, *44*, 113–137.
77. Fedyk, W.; Kachniewska, M. Uwarunkowania skuteczności funkcjonowania regionalnych organizacji turystycznych w Polsce w formule klastra. *Ekon. Probl. Tur.* **2016**, *33*, 135–150.
78. Gołembski, G.; Niezgoda, A. Organization of tourism in Poland after twenty years of systemic changes. In *European Tourism Planning and Organisation Systems: The EU Member States*; Costa, C., Panyik, E., Buhalis, D., Eds.; Channel View Publications: Bristol, UK, 2014; pp. 243–256.
79. Fortes, S.; Mantovaneli Junior, O. Desarrollo regional y turismo en Brasil. políticas en el Valle Europeo. *Estud. Y Perspect. Tur.* **2009**, *18*, 655–671.
80. Gardiner, S.; Scott, N. Successful tourism clusters: Passion in paradise. *Ann. Tour. Res.* **2014**, *46*, 171–173. [CrossRef]
81. Wang, Y.; Fesenmaier, D.R. Collaborative destination marketing: A case study of Elkhart county, Indiana. *Tour. Manag.* **2007**, *28*, 863–875. [CrossRef]
82. Abou-Shouk, M.A. Destination management organizations and destination marketing: Adopting the business model of e-portals in engaging travel agents. *J. Travel Tour. Mark.* **2017**, *35*, 178–188. [CrossRef]
83. Ejarque-Bernet, J. *Modelos innovadores de Gestión y Promo-Comercialización turística en un Entorno de Competencia*; XIV Congreso AECIT: Gijón, Spain, 2010; pp. 645–662.
84. Vargas, A. COVID-19 crisis: A new model of tourism governance for a new time. *Worldw. Hosp. Tour. Themes* **2020**, *12*, 691–699. [CrossRef]
85. Cehan, A.; Eva, M.; Iațu, C. A multilayer network approach to tourism collaboration. *J. Hosp. Tour. Manag.* **2021**, *46*, 316–326. [CrossRef]
86. Kuščer, K.; Eichelberger, S.; Peters, M. Tourism organizations' responses to the COVID-19 pandemic: An investigation of the lockdown period. *Curr. Issues Tour.* **2021**, *25*, 247–260. [CrossRef]
87. Pillmayer, M.; Scherle, N.; Volchek, K. Destination Management in Times of Crisis—Potentials of Open Innovation Approach in the Context of COVID-19? In *Information and Communication Technologies in Tourism*; Wörndl, W., Koo, C., Stienmetz, J.L., Eds.; Springer: Cham, Switzerland, 2021; pp. 517–529. [CrossRef]
88. Jiang, Y.; Ritchie, B.W.; Verreynne, M. Building tourism organizational resilience to crises and disasters: A dynamic capabilities view. *Int. J. Tour. Res.* **2019**, *21*, 882–900. [CrossRef]
89. Cabiddu, F.; Lui, T.-W.; Piccoli, G. Managing value co-creation in the tourism industry. *Ann. Tour. Res.* **2013**, *42*, 86–107. [CrossRef]
90. Rihova, I.; Buhalis, D.; Moital, M.; Gouthro, M.B. Social layers of customer-to-customer value co-creation. *J. Serv. Manag.* **2013**, *24*, 553–566. [CrossRef]
91. Trunfio, M.; della Lucia, M. Co-creating value in destination management leveraging on stakeholder engagement. *E Rev. Tour. Res.* **2019**, *16*, 2–3.
92. Baum, T.; Hai, N.T.T. Hospitality, tourism, human rights and the impact of COVID-19. *Int. J. Contemp. Hosp. Manag.* **2020**, *32*, 2397–2407. [CrossRef]

93. Dube, K.; Nhamo, G.; Chikodzi, D. COVID-19 cripples global restaurant and hospitality industry. *Curr. Issues Tour.* **2020**, *24*, 1487–1490. [CrossRef]
94. Qiu, R.T.; Park, J.; Li, S.; Song, H. Social costs of tourism during the COVID-19 pandemic. *Ann. Tour. Res.* **2020**, *84*, 102994. [CrossRef] [PubMed]
95. Orchiston, C.; Prayag, G.; Brown, C. Organizational resilience in the tourism sector. *Ann. Tour. Res.* **2016**, *56*, 145–148. [CrossRef]
96. Ritchie, B.W.; Jiang, Y. A review of research on tourism risk, crisis and disaster management: Launching the annals of tourism research curated collection on tourism risk, crisis and disaster management. *Ann. Tour. Res.* **2019**, *79*, 102812. [CrossRef]
97. Sawalha, I. Managing adversity: Understanding some dimensions of organizational resilience. *Manag. Res. Rev.* **2015**, *38*, 346–366. [CrossRef]

## Article

# Course of Values of Key Performance Indicators in City Hotels during the COVID-19 Pandemic: Poland Case Study

Monika Widz <sup>1,\*</sup>, Renata Krukowska <sup>1,\*</sup>, Bartłomiej Walas <sup>2</sup> and Zygmunt Kruczek <sup>3</sup>

<sup>1</sup> Department of Regional Geography and Tourism, Faculty of Earth Sciences and Spatial Management, Maria Curie-Skłodowska University, 20-718 Lublin, Poland

<sup>2</sup> Faculty of Tourism and Recreation, University College of Tourism and Ecology, 34-200 Sucha Beskidzka, Poland

<sup>3</sup> Institute of Tourism, Faculty of Tourism and Recreation, University School of Physical Education in Krakow, 31-571 Krakow, Poland

\* Correspondence: monika.widz@umcs.pl (M.W.); renata.krukowska@umcs.pl (R.K.)

**Abstract:** The main goal of this article is to assess the functioning of hotels during the crisis caused by the COVID-19 pandemic. The analysis was carried out on the basis of selected Key Performance Indicators (KPI) in hotels in Polish cities (Kraków; Poznań; Tri-City: Gdańsk, Gdynia, Sopot; Warsaw; Wrocław). The time range of the analysis covers the whole period of the COVID-19 pandemic in Poland (March 2020–February 2022) with data for 2019—before the outbreak of the pandemic. The analysis of the collected results of OCC, ADR, and RevPAR generally indicates instability of the basic economic indicators dependent not only on the demand limited by the pandemic restrictions but also on the type of tourism prevailing in individual cities. There is a difference between the hotel industry in cities, based mainly on foreign guests and business tourism, and the hotel industry in tourist/coastal regions, which are dominated by leisure tourism. During the greatest restrictions, hotels in Poland recorded huge drops in KPIs: a 95% drop in OCC and RevPAR. It was also found that the instability of demand during the pandemic and rapid changes in the values of the indicators prove the need for greater use of KPI benchmarks.

**Keywords:** hotel; COVID-19; OCC; ADR; RevPAR; revenue management; Poland



check for updates

**Citation:** Widz, M.; Krukowska, R.; Walas, B.; Kruczek, Z. Course of Values of Key Performance Indicators in City Hotels during the COVID-19 Pandemic: Poland Case Study. *Sustainability* **2022**, *14*, 12454. <https://doi.org/10.3390/su141912454>

Academic Editor: Jun (Justin) Li

Received: 3 August 2022

Accepted: 26 September 2022

Published: 30 September 2022

**Publisher's Note:** MDPI stays neutral with regard to jurisdictional claims in published maps and institutional affiliations.



**Copyright:** © 2022 by the authors. Licensee MDPI, Basel, Switzerland. This article is an open access article distributed under the terms and conditions of the Creative Commons Attribution (CC BY) license (<https://creativecommons.org/licenses/by/4.0/>).

## 1. Introduction

The course of the SARS-CoV-2 coronavirus pandemic and its negative economic dimension has been one of the hottest topics of recent years, and its effects will be experienced for many years to come. Already in the first months of 2020, the European Parliament estimated that the European Union tourism industry, which employs around 13 million people, will lose around EUR 1 trillion in revenue per month due to the spread of the COVID-19 pandemic [1]. According to the UNWTO data, in 2020 the global tourism economy regressed by 30 years in performance. In comparison to 2019, the loss of international tourist arrivals accounted for 74% and the loss in international tourism receipts was estimated at USD 1.3 trillion [2]. As shown by the UNWTO data, 62 million travel jobs were lost in 2020, representing a drop of 18.5%, leaving just 272 million employees across the sector globally, compared to 334 million in 2019 [3]. Based on the latest data, global international tourist arrivals more than doubled (+130%) in January 2022 compared to 2021 [4]. Presently, international tourism is expected to continue its gradual recovery in 2022 (however, the war in Ukraine poses new challenges).

For many hospitality companies, this is the most difficult time in the entire history of their business. It should be remembered that this is not the first crisis to affect the tourism economy, although it has certainly never had such a character and magnitude [5]. Indeed, the sector has proved to be one of the most vulnerable to the negative impact of the pandemic and related restrictions. The instability in the tourism sectors since March 2020

has caused problems in maintaining a steady and predictable movement of people around the world, and the crisis caused by the outbreak of the pandemic has contributed to several key adverse outcomes. These include loss of liquidity for tourism businesses, difficulties in meeting tax obligations, seeking state assistance, etc.

The empirical objective of the article is to evaluate the performance of hotels in the crisis caused by the COVID-19 pandemic from the point of view of selected economic and operational indicators in hotels. In the literature on the subject, the crisis in the functioning of the company is analyzed through various approaches: as a consequence of certain events, a stage in the development of an enterprise, a pathology, or a process occurring in an enterprise [6]. In this article, the phenomenon of crisis is interpreted as a consequence of unplanned events occurring in the company's environment, which disrupt or threaten the normal functioning of the company [7]. In order to illustrate the processes taking place, several indicators were selected to provide information on the financial condition of the company. These are the so-called Key Performance Indicators (hereinafter KPIs) serving as a numerical measurement tool that describes the performance of the hotel. The KPI analyses of hotels were carried out in five Polish cities considered to be important centres of the city break and meeting industry: Kraków, Poznań, Tri-City (Gdańsk, Gdynia, Sopot), Warsaw and Wrocław. Among these cities, due to its coastal location, only Tri-City represents the leisure segment in addition to city tourism.

The data on the negative economic effects of the pandemic published by various international institutions and research centers mainly include integrated indicators for the entire tourism economy, such as employment, share in GDP, number of tourists, etc. There is a small number of analyses of individual sectors, such as travel agencies or hotels. Hence, the proposed research is a case study of representations for city hotels throughout the country, in this case in Poland. The variability in individual KPI values during the pandemic illustrates not only the negative impact of the decline in the number of guests, but also the decline in the alleged profitability of hotels.

## 2. Literature Review

The outbreak of the global SARS-CoV-2 coronavirus pandemic determined the transformation of a large social and economic area, one of the main elements of international economic growth in recent decades [8].

In the literature, there are numerous analyses and studies of the COVID-19 pandemic and its impact on various economic spheres, including tourism. Some of the first studies focused on the country that was the source of the COVID-19 infection: China [9–12]. As suggested by Estrada et al. [10], the Chinese tourism sector can suffer of a decrease in demand in 75%. Noteworthy, in terms of global tourism, China is both an important tourist destination and a major source market. There are also studies of Sri Lanka [13], Italy [14], and Australia [15]. They present, to a varying extent, the effects of the development of the pandemic and its impact on the economies of these countries.

One of the sectors with the highest impact of the COVID-19 pandemic is hospitality [16–18]. As indicated by the results reported by Smith Travel Research (STR), the occupancy rates in accommodation facilities in March 2020 fell by as much as 96% in Italy, 68% in China, 67% in the UK, 59% in the US, and 48% in Singapore compared to 2019 figures [19]. Detailed studies indicate that the COVID-19 has a large negative effect on the operation of accommodation facilities, as reflected by the core indicators. The impact of the COVID-19 pandemic on the hotel industry has been examined from an international perspective [20–22] or countries, among others, in the US [23], China [24], India [25], Indonesia [26], Israel [27], and Poland [28,29]. The analysis included not only hotels but also short-term vacation rentals [30,31] or small lodging establishments [32]. Attention was also drawn to modelling the realisation of pent-up demand based on the relationship between the incoming traffic of online booking platforms in the hospitality sector and the volume of tourist arrivals in the context of the COVID-19 spread [33]. Financial analyses [32,34] and economic indicators of hotels during the pandemic have also been described [23,28,35,36]. Importantly, the



indicators used in the evaluation must be specific, measurable, achievable, relevant, and time-bound. This is the so-called SMART criterion, the scope of which has been described by, e.g., Shahin and Mahbod [37].

The assessment of hotel KPIs is important for surviving an economic crisis [38]. Measuring KPIs can help a company decide whether they are operating in an appropriate way and whether the hotel company's performance is competitive or not. Analysing and monitoring a relevant set of KPIs can also help a hotel achieve its sales targets. The most commonly used indicators such as the occupancy percentage (OCC), ADR (average revenue), and RevPAR (revenue per room) should be analysed on a daily basis [39].

The time of the pandemic provoked considerations of the sustainability of the hotel industry described globally [40] and illustrated by the example of the hotel industry in Poland [41], as the hotel occupancy rates continued to fall [42,43].

From this point of view, sustainable hotel industry should apply to all areas and management tools, as the basic, practiced KPIs are not sufficient. HOTREC—a Confederation of National Hotel, Restaurant and Cafeteria [44] manifests numerous initiatives, inter alia, in the field of legal regulations and innovative concepts of management in the hotel industry. There is a tendency in the hotel industry to increase the interest in hotels that apply the principles of sustainable development [45,46]. More and more, guests who want to express their support for environmental protection choose hotels that declare a green economy and claim to be environmentally friendly [47]. Many facilities in the hospitality industry implement low-emission energy technologies to reduce the concentration of carbon dioxide in the atmosphere. The conducted research shows that the implementation of the Sustainable Development Goals during the COVID-19 pandemic was not endangered, and was even extended in social initiatives [41]. This is confirmed by the research on the attitudes of tourism stakeholders towards the goals of sustainable development in one of the cities analyzed in this article, which is Kraków [48], and the opinions of hotel industry leaders from Sweden, the USA, and Israel [49].

At the same time, the issues of sustainability should be viewed not only from the point of view of environmental protection but also tools and techniques for managing the enterprise. It was the period of the pandemic that proved that the analyzed indicators based solely on financial KPIs are short-sighted in crisis situations and do not fit into the concept of change management. Social and technological changes also justify the adjustment of analytical indicators [50].

The dynamic transformation of the epidemiological situation in individual countries was associated with the need for tourism companies to obtain state subsidies depending on the states' concept of protecting the national market. The subsidies, known in Poland as editions of the so-called 'anti-crisis shield', were intended to sustain employment levels and maintain businesses for the duration of the freeze of their normal market activity. Hotels faced the challenge of having to redefine their business models.

### 3. Operation of Hotels during the Pandemic

Prior to the announcement of the pandemic, the hospitality market in Poland was in a booming phase and hoteliers were experiencing a period of prosperity. Between 2015 and 2019 alone, the number of guests in hotels increased by 6 million, including foreigners by 1 million and the number of nights provided by more than 12 million from 32.7 to 44.8 million [51]. Unfortunately, the trend was abruptly interrupted with the restrictions introduced by successive decisions of the authorities of individual countries, leading to a complete halt in international tourism.

The hotel sector was therefore one of the most negatively affected by the COVID-19 pandemic through the administrative restrictions on operations and the drastic reduction in both domestic and international demand. According to Statistics Poland, there were 17.9 million tourists staying in all tourist accommodation establishments in 2020, which was almost half the number of tourists from the previous year. Hotels also suffered from the administrative restrictions on catering operations and a drop in activity to essentially zero

affected the MICE segment during the pandemic. In 2020, after many years of uninterrupted growth, there was a decline in the number of accommodation establishments (by 8.5% y-o-y) and beds offered in these establishments (by 6.1% y-o-y) [51]. In the tourist travel segment, the decrease in demand for hotel services was related to the fear of infection and a reduction in trips and stays by private individuals. It is worth noting that even in the 2020 holiday season, i.e., during the relative weakening of the pandemic, small facilities (houses, holiday cottages, often located outside tourist destinations) were very popular, while there was less interest in stays in hotels, which naturally generate concentrations of people.

In Poland, the first case of COVID-19 was reported on 4 March 2020, and the government declared an Epidemic State of Emergency on 14 March. The first major restrictions on hotel operations were introduced between 1 April and 3 May 2020, when facilities mostly had to be closed. From 4 May 2020, there was a gradual process of ‘unfreezing’ hotel operations (Figure 1).

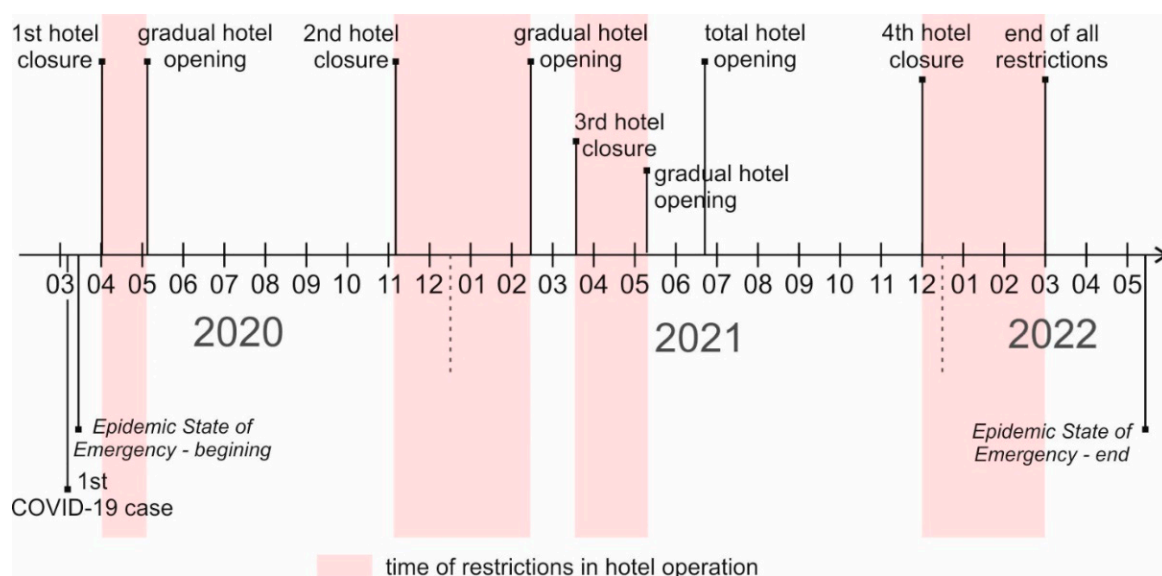

**Figure 1.** Timeline of the COVID-19 hotel restrictions in Poland.

As early as in April 2020, interviews on the economic state of the hotel sector began to be published (mainly by the Economic Chamber of Polish Hotel Management publishing the results of surveys conducted among its members every 2–3 months on its website). Due to different methods and sample sizes, they cannot be comparable; nevertheless, they show the attitude and state of the hotel industry at different moments of the pandemic and formal restrictions on movement, opening of services, and flight connections. The data collected reveal the scale of losses, demand, areas of expected government assistance, the labour market situation, or prospects for restart, with each of the studies conducted under slightly different pandemic circumstances and constraints [52].

In autumn 2020, the exponential increase in infections recorded from the beginning of October led to the return of the restrictions. As of 7 November 2020, hotels were only allowed to accommodate guests using hotel services as part of business travel. Hotel restaurants remained closed, and meals were only served to rooms. The data on accepted bookings for the following months confirmed the high uncertainty on the hotel services market, the tendency to postpone purchasing decisions until the last minute, and the lack of visible prospects for a recovery in business traffic.

The decision to open hotel facilities to all guests was not taken by the government until February 2021, but under a limited sanitation regime: 50% of rooms available, closed restaurants (meals served in the room), pools open while maintaining 1.5 m distancing, closed saunas, etc.

In spring 2021, the epidemic situation in Poland continued to deteriorate and the hotels had to suspend their operations again. From 8 May 2021, the hotels were opened to guests with a maximum occupancy of 50% and closed restaurants and wellness and spa areas. From 28 May, restaurants were opened under a strict sanitary regime (maximum occupancy of 50%) and special events were allowed inside the facilities (limit of up to 50 people). With the start of the summer holidays, the government reduced many of the restrictions. The occupancy limits in hotels and restaurants increased to 75%—the limits did not apply to groups of young people under the age of 12 and fully vaccinated persons.

The restrictions persisted until 1 December 2021, when the limit of persons in hotels was reduced to 50% (vaccinated persons were not included in this number). These regulations were tightened from 15 December, when the limit of unvaccinated persons allowed in the facility was reduced to 30%. They were in force until the end of February 2022. As of 1 March 2022, all hotel occupancy limits were lifted. However, new challenges arose a few days earlier, as the war in neighbouring Ukraine began.

#### 4. Material and Methods

The research process of the assessment of hotel operations during the crisis caused by the COVID-19 pandemic was divided into six main stages: (1) KPI selection; (2) city selection; (3) hotel selection; (4) method selection; (5) data collection; (6) KPI analysis (Figure 2). These stages are described below.

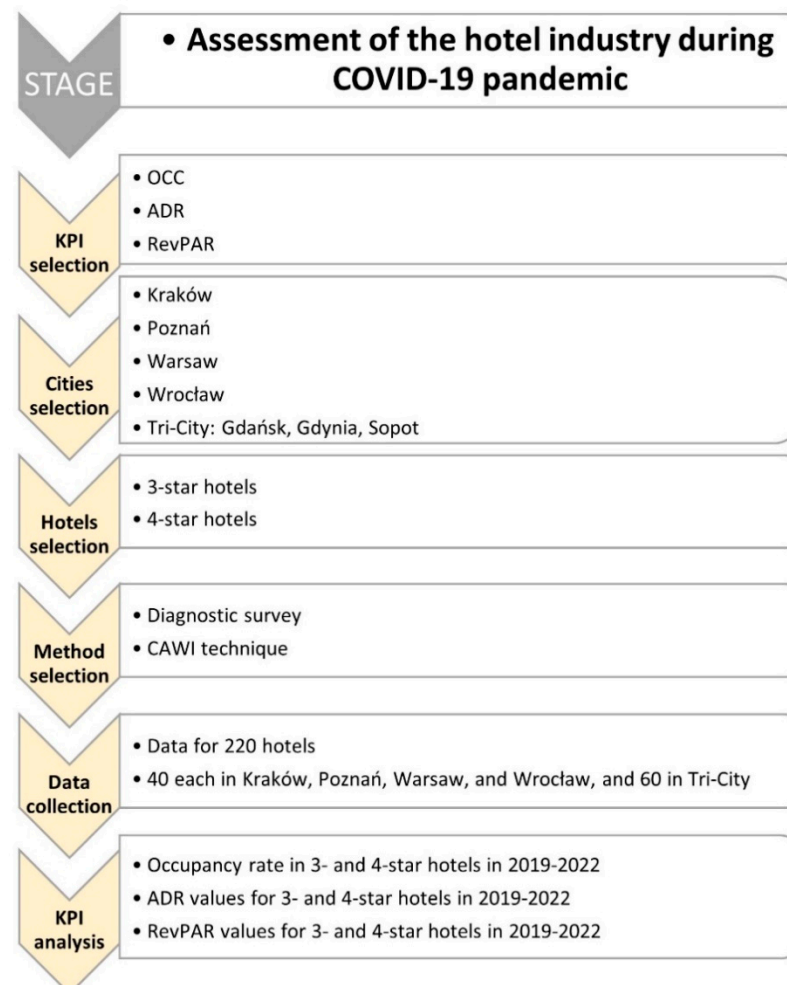

Figure 2. Flow chart of research process.

#### 4.1. KPI Selection

The quantifiable measures that allow a company to assess the revenue management strategies are the Key Performance Indicators (KPIs). Therefore, the assessment was carried out using three of the main economic and operational indicators [23,28,39,53–56]:

- (1) OCC (*Occupancy*)—the room occupancy rate (expressed as a percentage), indicating the ratio of the number of rented rooms to the nominal number of rooms (the total number of rooms prepared for tourists on each day of hotel operation) [57]:

$$\text{OCC (Occupancy)} = \frac{\text{Rooms sold}}{\text{Rooms available for sale}} [\%] \quad (1)$$

OCC is one of the most popular KPI's in the hotel industry for revenue management, highlighting how much of the available space in a hotel is actually being utilised. However, it should be used in conjunction with other metrics because the goal is to maximise revenue, not occupancy rate. For this reason, the occupancy rate should always be viewed in context, alongside average daily rate and revenue per available room.

- (2) ADR (*Average Daily Rate*)—an indicator of the average daily income per occupied room per day excluding breakfast [58]:

$$\text{ADR (AverageDailyRate)} = \frac{\text{Rooms revenue (net of VAT)}}{\text{Rooms sold}} [\text{EUR}] \quad (2)$$

By using ADR, hotel management can know the average price paid per room on a specific day and monitor trends over a longer time frame. It should be noted that only rooms that were actually available for sale should be included in the calculation (rooms used by employees or complimentary rooms that were allocated to guests should not be taken into account).

- (3) RevPAR (*Revenue Per Available Room*)—an indicator of the level of revenue per available room in relation to the occupancy of the facility [59]:

$$\text{RevPAR (RevenuePerAvailableRoom)} = \frac{\text{Rooms revenue (net of VAT)}}{\text{Rooms available for sale}} [\text{EUR}] \quad (3)$$

RevPAR is a metric used in the hospitality industry to assess a property's ability to fill its available rooms at an average rate. It allows for obtaining a more accurate and broad picture of the hotel's performance and helps to see how much revenue the hotel made within a certain period of time.

Analysis of the above indicators provides a broader view of the hotel's financial performance and thus its ability to operate on the market. In contrast, it does not indicate the effectiveness of the full management, as it only indicates acquired guests and not potential ones. The analysed indicators are certainly not the only ones that allow management accounting, but even a slight increase in the occupancy level (OCC) or average price (ADR) yields a significant increase in the revenue on an annual basis. Given the hotel indicators, it is possible to keep track of deviations that affect the hotel's profitability or cost structure.

#### 4.2. Cities Selection

The research was conducted in five Polish cities (Kraków, Poznań, Warsaw, Wrocław, and Tri-City—the metropolitan area of three cities: Gdańsk, Gdynia, Sopot), where the largest number of hotels, bed places, and accommodated tourists occur, according to Statistics Poland data [60] (Figure 3, Table 1).

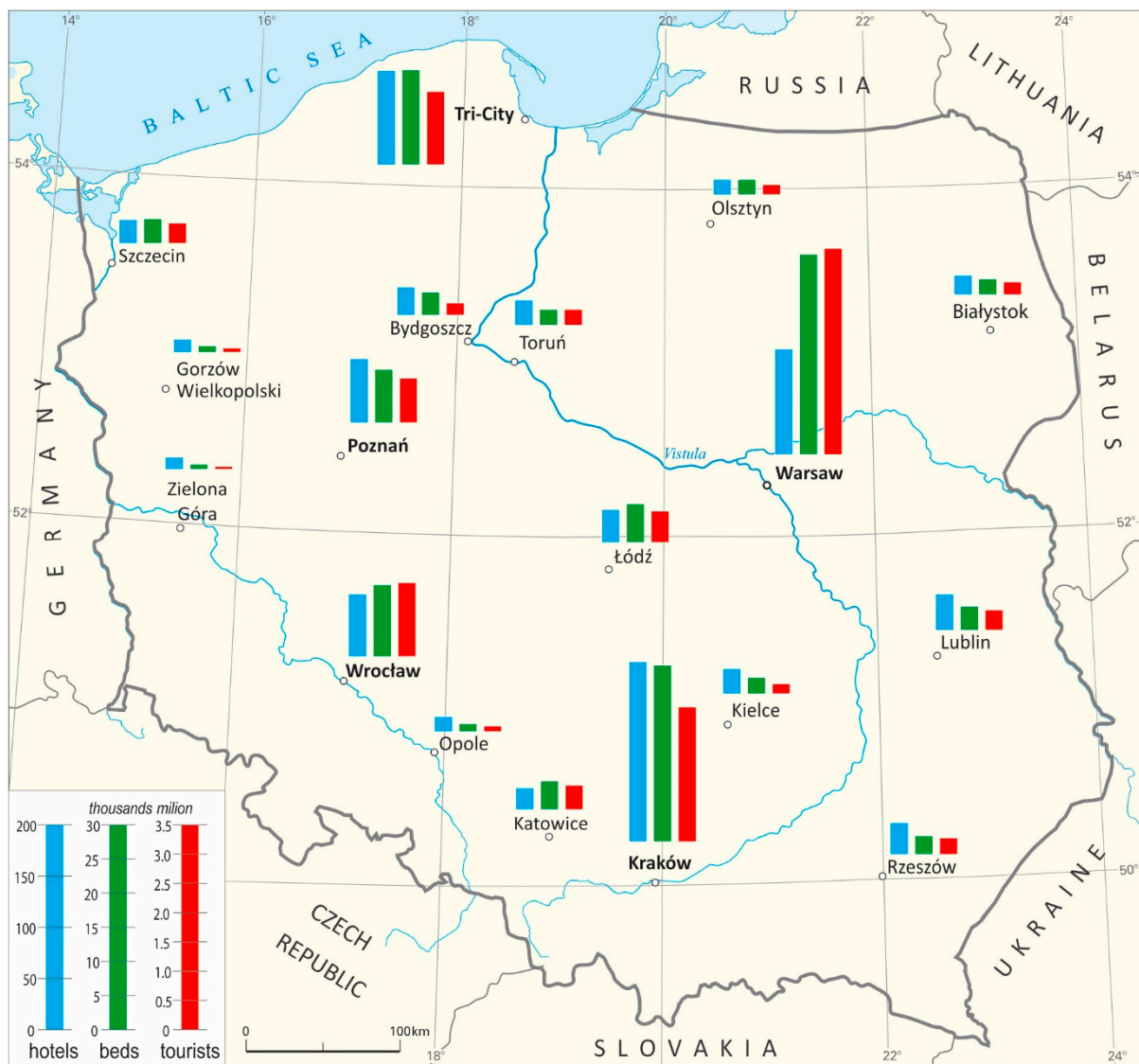

**Figure 3.** Number of hotels, bed places, and tourists accommodated in the selected Polish cities in 2019 (source: based on “Tourism in 2019” [60]).

**Table 1.** Number of hotels, bed places, and tourists accommodated in analyzed Polish cities in 2019.

City	Total Number	Category					During Categorisation
		5-Star	4-Star	3-Star	2-Star	1-Star	
Hotels							
Poland	2635	76	418	1318	559	136	128
Kraków	167	13	49	81	17	5	2
Poznań	59	3	15	32	8	1	–
Tri-City <sup>a</sup>	87	11	15	45	14	–	2
Warsaw	98	14	19	37	19	6	3
Wrocław	58	7	13	27	4	4	3
Bed places in hotels							

Table 1. Cont.

City	Total Number	Category					During Categorisation
		5-Star	4-Star	3-Star	2-Star	1-Star	
Poland	286,231	19,191	82,023	122,433	41,546	11,087	9951
Kraków	24,618	2548	8638	8842	3582	869	139
Poznań	7424	480	2725	3281	902	36	–
Tri-City <sup>a</sup>	13,202	2141	3436	6030	1501	–	94
Warsaw	27,868	5710	9020	8060	2726	1837	515
Wrocław	10,047	1546	2710	3907	788	773	323
Tourists accomodated in hotels							
Poland	23,511,588	1,851,601	7,230,202	9,783,583	2,993,850	974,781	677,571
Kraków	2,194,340	200,270	854,872	856,761	180,155		102,282
Poznań	719,508	51,756	248,879	314,531		104,342	–
Tri-City <sup>a</sup>	1,188,367	182,036	358,397	509,478	131,404	–	7052
Warsaw	3,345,722	665,510	1,039,913	1,038,881	312,792		288,626
Wrocław	1,203,967	183,961	340,291	435,518	81,602	131,328	31,267

<sup>a</sup> metropolitan area of three cities: Gdańsk, Gdynia, and Sopot; source: based on “Tourism in 2019” [60].

#### 4.3. Hotels Selection

As of 31 July 2019, the number of tourist accommodation facilities in Poland amounted to 19.2 thousand facilities. The structure of the establishments was dominated by guest rooms and agrotourism lodgings, which together constituted almost 60% of all tourist accommodation facilities. As a rule, these are small facilities with several bed places. The next largest group of facilities was hotels, whose share was 14%, but these offer over 32% of all facilities bed places [60].

The size of the hotel sector in Poland amounted to over 2635 hotels (of which nearly 75% in cities), offering almost 290,000 beds. For detailed analyses, three- and four-star hotels were selected, which both offer the largest number of beds (which is 71%) and are the most frequently chosen category of hotels by tourists nationally (which is 72%) and in the individual cities (Table 1).

#### 4.4. Method Selection

To collect data, needed to calculate the KPIs, a diagnostic survey using the Computer-Assisted Website Interview (CAWI) technique was applied. CAWI is considered a quantitative method in which numeric parameters are determined in given units so the subject of the investigations can be characterized. It is currently the most quickly developing survey method. It enables the data to be collected much cheaper and quicker in comparison to traditional methods [61,62]. The choice of survey method was determined by the constraints of the pandemic, the ability to easily reach a large number of respondents, and the speed of obtaining results. The use of the CAWI technique to survey businesses has additional justification. According to Statistics Poland [63], 100% of businesses with at least 10 employees and providing accommodation and catering services have internet access.

Surveys were sent to the management of three- and four-star hotels in selected cities.

#### 4.5. Data Collection

The data were collected monthly in two study periods:

1. January 2019 to February 2020—the period before the pandemic was declared;
2. March 2020 to February 2022—the entire duration of the pandemic in Poland.

The research covered 220 hotels (8.4% of all hotels in Poland), 40 each in Kraków, Poznań, Warsaw, and Wrocław, and 60 in Tri-City. Two survey forms were received back from each hotel (the first covered the period before the announcement of the pandemic and

the second covered the entire duration of the pandemic in Poland), resulting in a total of 440 questionnaires to be analysed.

#### 4.6. KPI Analysis

On the basis of data and information obtained from the hotels' management KPIs have been calculated by the Authors. KPIs analysis: OCC, ADR and RevPaR for three- and four-star hotels, for the period 2019–2022 are presented in Chapter 5. Results—hotel economic indicators in the COVID-19 pandemic.

### 5. Results—Hotel Economic Indicators in the COVID-19 Pandemic

Clearly, the constraints described above have had an impact on the economic performance of the hotels, which is reflected in the economic indicators achieved.

The first strong collapse in hotel occupancy (OCC) was already recorded in March 2020 (Figure 4)—from 61.7% in February to 19.4% (average for all cities). The comparison of these figures to data from the previous year demonstrated a large difference, as the OCC in March 2019 was on average 66.3%. Already in April, the OCC fell to an average of 2.8% (the lowest value—at 0%—was recorded in Poznań and Kraków, and the highest was noted in Wrocław 10.0%). A slight increase in the OCC of the hotels to 7.2% and 17.2% on average was recorded in May and June 2020, respectively. Already in this period, differences between individual cities are noticeable, and results above the average were recorded in Tri-City and Wrocław.

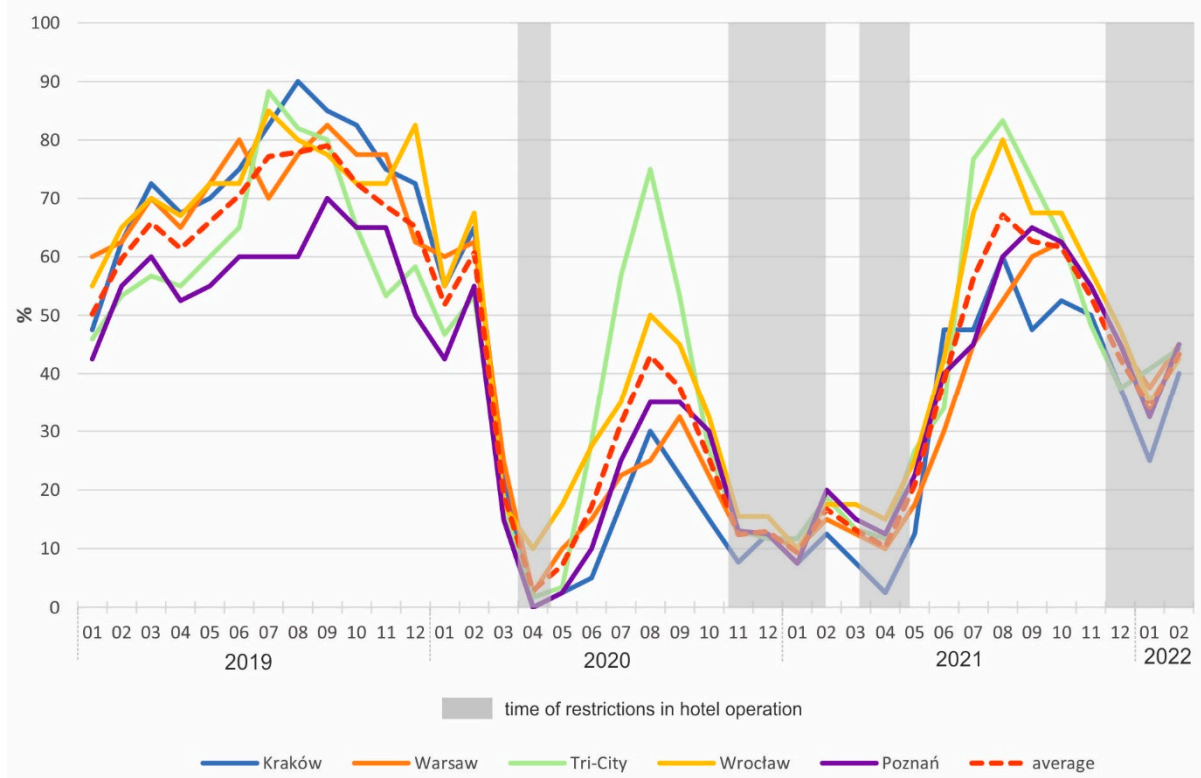

**Figure 4.** Occupancy rate in 3- and 4-star hotels in selected Polish cities in 2019–2022.

Summer 2020 was associated with the improvement of the OCC in the hotels of the cities in question. In the following three months of July–September, the average hotel occupancy rate was over 40% (max. average value—August 2020—43%). During this period, however, significant disparities between the cities were noticeable. The highest OCC, at a level similar to the pre-pandemic period (75%), was recorded by the hotels in Tri-City.



The following autumn-winter months (November 2020 to April 2021) were again a period of a significant decrease in the OCC, with the rate at a level of several per cent (not exceeding 20%), compared to the 50–70% achieved in 2019 over a comparable period.

From May 2021 onwards, an increase in occupancy rates was recorded to a value of 20.8% in May and 38.8% in June. It is noticeable that this increase was very similar in all the analysed cities. The further increases in the OCC values were also associated with the holiday months, with its average increasing to 56.3% in July and 67.2% in August. Although the average value was significantly lower than in 2019, the values recorded in two cities: Wrocław (80.0%) and Tri-City (83.3%) were at levels similar to the pre-pandemic period.

From September 2021, a gradual decline in the hotel OCC was observed, with an average of 34.2% in January 2022 and the lowest values recorded in Kraków. In February, the occupancy rate increased. The average OCC values for the consecutive years were 67.8% in 2019, 26.8% in 2020, and 37.7% in 2021.

Another analysed indicator—ADR, i.e., the average income received per room rented (excluding breakfast), is determined independently of the occupancy of the property. The average ADR determined for 2019 at EUR 63.1 (For simplicity, a rate of 1 EUR (EUR) = 4.5 PLN was used) fell to EUR 55.3 in 2020. In 2021, the ADR increased to EUR 58.0. The analysis of the changes in the ADR occurring with the course of the pandemic showed that its value decreased successively from April 2020 (Figure 5). In 2020, there was no increase in the ADR value in the spring-summer months (May–September), in contrast to 2019. The first increase in its value was recorded in February and the next in May 2021. The increasing ADR indicated an improvement in the situation, but the values achieved were still lower than in 2019.

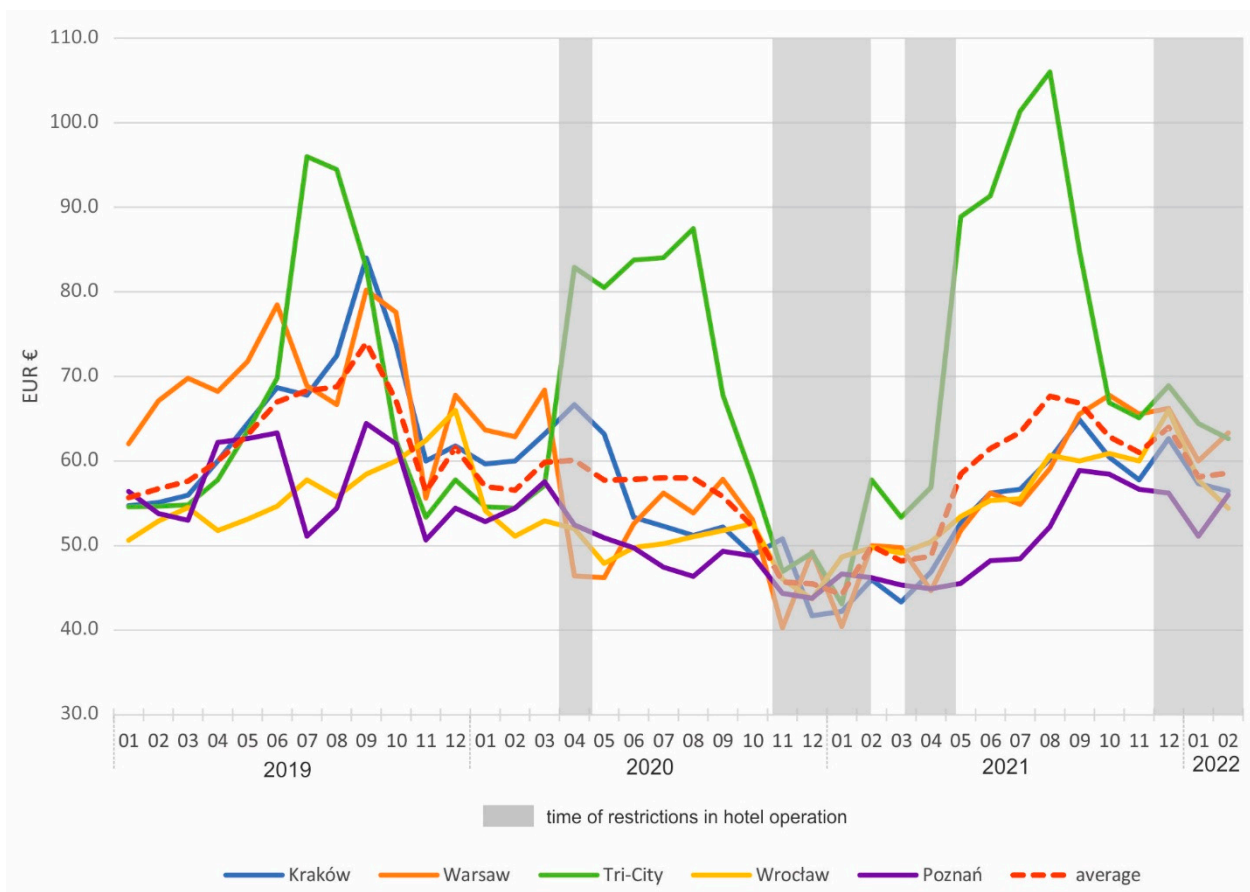

**Figure 5.** ADR values for 3- and 4-star hotels in selected Polish cities in 2019–2022.

The comparison of the average ADR values in the different months of the analysed years revealed that only in the first four months of 2020 the ADR was comparable to the



results from 2019, which is related to the fact that the pandemic outbreak occurred in March. From May 2020 onwards, the ADR value was lower in each month, compared to the previous results, over the entire subsequent year. The ADR reached a value close to that of 2020 only in June 2021, and a gradual increase in the indicator value was noticeable from this point onwards. A breakthrough month was November 2021, as the ADR value (EUR 61.1) was higher than the corresponding value in the two previous years (2019—EUR 56.4; 2020—EUR 45.8). From then on (until February 2022), the highest month-to-month ADR value was recorded.

The last of the analysed indicators RevPAR, i.e., the revenue per available room, is an indicator of performance in the hotel industry. From March 2020 to June 2021, the average RevPAR was below even the lowest values recorded for 2019 (in January and February—EUR 28.0 and EUR 36.9, respectively). July 2021 was the first month in which the average index exceeded the minimum values recorded for 2019.

RevPAR first fell dramatically to EUR 11.8 in March and as low as EUR 2.0 in April (Figure 6). In the following months, it gradually increased, reaching a maximum average value of EUR 26.7 in 2020. The turn of 2020 and 2021 (November–April) was a period when RevPAR exceeded EUR 11 in none of the analysed cities. From May 2021, a gradual increase in RevPAR was noticeable, reaching a maximum average value of EUR 47.3 in August 2021.

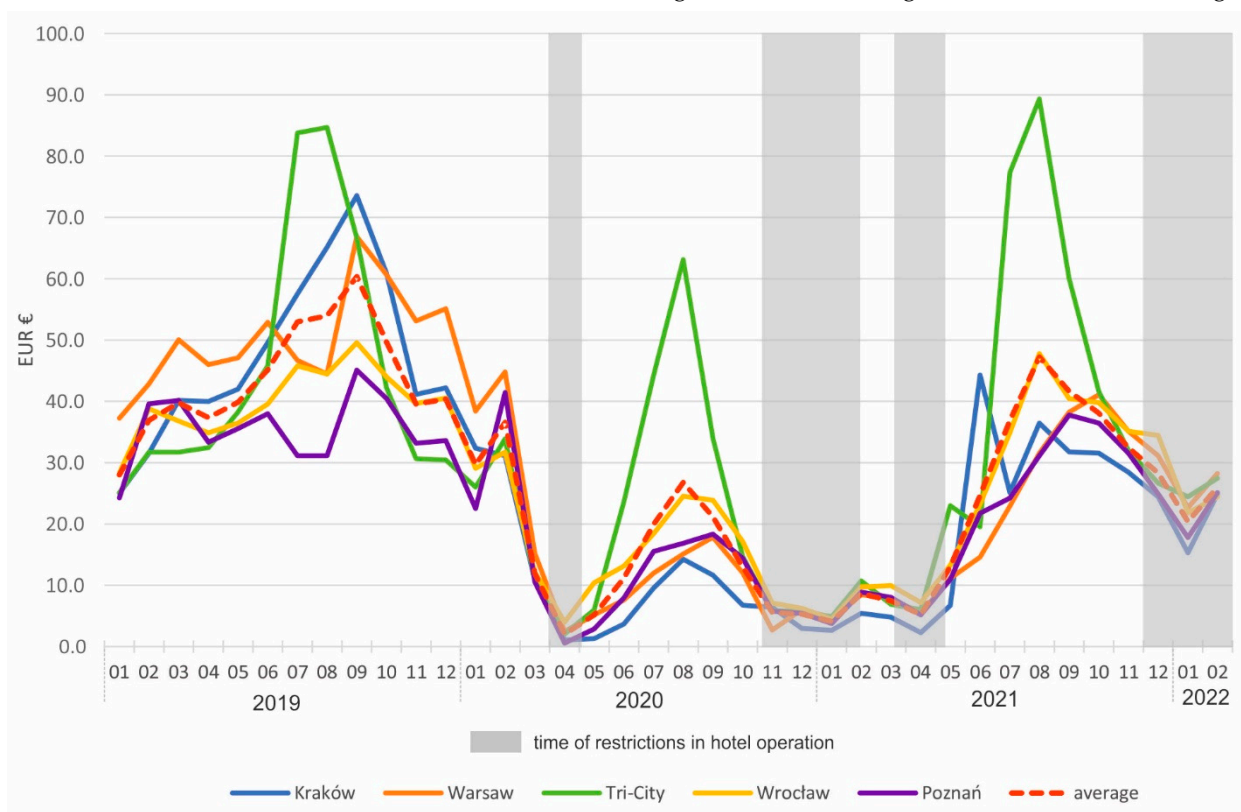

**Figure 6.** RevPAR values for 3- and 4-star hotels in selected Polish cities in 2019–2022.

## 6. Discussion

From the day of the introduction of the epidemic alert in Poland, a sharp drop in new bookings and a significant increase in cancellations of existing reservations began to be recorded. Not only individual stays but also group bookings and conferences were cancelled. Therefore, already at the beginning of the pandemic, the Polish hotel industry experienced its negative effects [28], as it did in other countries [23,38]. At the time of the greatest restrictions, both the USA [23,56] and Poland recorded huge drops in KPIs. Polish hotels recorded an approximately 95% decline in the OCC and RevPAR values. Hotels in cities dominated by foreign tourism suffered the greatest losses. However, it should be noted that Wrocław showed the highest occupancy rate during this period, among not only

all major cities in Poland but also in Central and Eastern Europe [64,65]. As suggested in the trade magazine [66], high rates may have been achieved thanks to accommodated foreign workers employed in various investments in the city, who could not back home because of closed borders and largely restricted international flights.

The gradual ‘unfreezing’ of hotels operation was a slow process [67], especially since international tourist traffic was virtually non-existent. In the months that brought a considerable loosening of the restrictions—the holiday period (July–August)—the occupancy rates improved, as clearly seen in Tri-City. These were the highest results not only in Poland but also in the entire CEE region. Following the STR SHARE Center data [65], it was found that none of the other areas surveyed by the STR managed to exceed an occupancy rate above 35%. However, the lowest occupancy rates were achieved by the hotels in Kraków and Warsaw, whose market was based on foreign guests. The disparity between the hotel industry in the coastal tourist regions and the city hotel industry was noted again in the summer of 2021. The hotel occupancy rates significantly increased in the Tri-City (even surpassed the pre-pandemic statistics), which, in conjunction with high interest in a holiday by the Polish seaside, drove the prices up and led to a 50% increase in RevPAR. Data showed how psychological factors, i.e., the fear of infection and the increased caution of foreign tourists as well as the various restrictions imposed also in other countries, have deterred a significant proportion of tourists from previous holiday activity. These circumstances were also noted among Polish tourists who, according to the report [68], have chosen domestic holidays and spent their summer holidays exclusively in the country site. The diversity of indicators between coastal regions and cities clearly showed how the dynamic is more heterogeneous than ever depending on the region and the time of year. Such a process was also noticed during the pandemic in the French hotel industry [69].

The autumn–winter period was another very difficult time for the hotel industry, also in Poland. According to estimates [70], the number of tourists was significantly smaller and resulted in a drop in the OCC. Surveyed hotels in the vast majority, declared that they would have difficulties in maintaining liquidity and did not expect to make an operating profit earlier than the end of 2021. As many as 97% of the hotels predicted a return to the 2018–2019 revenue levels no earlier than in 2022 [71]. The optimistic time for the hotel industry came to an end with the introduction of strict regulations which were in force until the end of February 2022.

By observing the course of KPIs during the pandemic, hoteliers became aware of the impact of factors related to their competitive environment on economic outcomes. The Economic Chamber of Polish Hotel Management put forward some general demands to support and sort out issues with the greatest relevance to the hotel industry in Poland [72] and worldwide. These include the exclusion of hotels from the so-called minimum tax, the introduction of a zero VAT rate for hotel services, the updating of categorisation regulations and the increased protection of the name ‘hotel’, the regulation of short-term rentals, the outlawing of so-called narrow clauses used by online booking portals (OTAs), quality certifications, changes in employee rights, the liberalisation of running businesses, or the simplification of public procurement law. This means extending the analyses of hotel productivity to include non-economic indicators as well. Among these indicators, the ones reflecting changes and reactions on the demand side should be taken into account to a greater extent, which can be seen again in some countries (the Baltic states, the Czech Republic, and even Austria) after the outbreak of the war in Ukraine.

## 7. Conclusions

Prior to the announcement of the pandemic, the hospitality market was in a dynamic phase and hoteliers were experiencing a period of prosperity. Unfortunately, the trend was abruptly interrupted. The restrictions introduced had a negative impact primarily on international and domestic tourism and, consequently, on the entire hotel industry.

Based on the analyses carried out, it was concluded that:

- 2020–2021 proved to be the most difficult period for the hospitality industry in its entire history. Indeed, the sector has proven to be one of the most vulnerable to the negative impact of the pandemic and its associated restrictions.
- a clear discrepancy has emerged between the urban hotel industry, based primarily on foreign guests and business tourism, and the hotel industry in coastal tourist regions where domestic leisure tourists predominate.
- the gradual increase in the OCC index in 2022 cannot be the basis for assessing the economic condition of hotels, because the losses incurred in the pandemic and measured by, for example, RevPAR will require a longer time perspective.

It was also found that KPI indicators (resulting from demand volatility during pandemic) are not fully sufficient for assessing hotel productivity and management tools. This underscores the need to increasingly utilise competitor-based revenue KPI benchmarks [73] or balanced scorecard [74]. Attention is also drawn to the need for revenue management flexibility in order to convert the revenue indicator into profit. It is even proposed to develop a value stream mapping (VSM) model based on six key drivers: organisational culture, demand forecasting, dynamic distribution channels, competition breakdown, dynamic and customised pricing, and daily reviewing [75].

Studies conducted during the COVID-19 pandemic in hotels in Poland and elsewhere, e.g., in Hungary [38], indicate that financial KPIs such as ADR and RevPAR are still important in the assessment of hotel performance. However, it has been noted that it is worthwhile to extend the analyses with non-economic indicators, e.g., employee satisfaction and loyalty [38], if hotel managers wish to ensure high quality of services and achieve high levels of guest satisfaction and productivity at the same time [76,77].

## 8. Limitations and Future Work

The research was conducted during the COVID-19 pandemic and the presented indicators relate to the crisis period, which is atypical for hotel operations. Only a representative group of three-star and four-star hotels were covered by them, as the majority of hotels in lower categories do not run revenue management and, consequently, do not calculate the RevPAR index. The choice of hotels has been limited to the most important tourist cities in Poland. Only economic KPIs were analyzed. In the future, in the post-co-vid period, similar research should be continued, supplemented with the creation of non-economic indicators, extended by hotel analyses to include five-star hotels and those of a lower standard, and also those located in other cities with different functions.

**Author Contributions:** Conceptualization, R.K. and M.W. Methodology, R.K. and M.W. Formal analysis, R.K. and M.W. Resources, R.K. and M.W. Writing—original draft preparation, R.K., M.W., B.W. and Z.K. Writing—review and editing, R.K., M.W., B.W. and Z.K. All authors have read and agreed to the published version of the manuscript.

**Funding:** This research received no external funding.

**Institutional Review Board Statement:** Not applicable.

**Informed Consent Statement:** Not applicable.

**Data Availability Statement:** Not applicable.

**Acknowledgments:** We are particularly grateful to the management of hotels in Poland for supporting the research process.

**Conflicts of Interest:** The authors declare no conflict of interest.

## References

1. COVID-19 and the Tourism Sector. European Parliament (EP). Available online: [https://www.europarl.europa.eu/RegData/etudes/ATAG/2020/649368/EPRS\\_ATA\(2020\)649368\\_EN.pdf](https://www.europarl.europa.eu/RegData/etudes/ATAG/2020/649368/EPRS_ATA(2020)649368_EN.pdf) (accessed on 2 June 2021).
2. 2020: A Year in Review. COVID-19 and Tourism. UNWTO. Available online: <https://www.unwto.org/covid-19-and-tourism-2020> (accessed on 22 June 2021).





3. Economic Impact Reports. WTTC. Available online: <https://wttc.org/Research/Economic-Impact> (accessed on 22 June 2021).
4. Tourism Enjoys Strong Start to 2022 While Facing New Uncertainties. Barometer UNWTO (25 March 2022). Available online: <https://www.unwto.org/taxonomy/term/347> (accessed on 9 May 2022).
5. Gössling, S.; Scott, D.; Hall, C.M. Pandemics, tourism, and global change: A rapid assessment of COVID-19. *J. Sustain. Tour.* **2020**, *29*, 1–20. [CrossRef]
6. Sochoń, M. Podatność przedsiębiorstwa na kryzys—Koncepcja ostrzegania przed zagrożeniem wystąpienia kryzysu w przedsiębiorstwie. *Mod. Manag. Rev.* **2017**, *24*, 179–189. Available online: <http://doi.prz.edu.pl/pl/pdf/zim/304> (accessed on 22 June 2021). [CrossRef]
7. Oldcorn, R. *Management*, 2nd ed.; Palgrave Macmillan: London, UK, 1989; ISBN 9780333487969.
8. Smoliński, M.; Zakrzewska, L. Normalność 2.0, Harvard Business Review Polska (1 August 2020). Available online: <https://www.ican.pl/a/normalnos-20/DKRXcLEmh> (accessed on 22 June 2021).
9. Ayittei, F.; Ayittei, M.; Chiwero, N.; Kamasah, J.; Dzuovor, C. Economic impacts of Wuhan 2019-nCoV on China and the world. *J. Med. Virol.* **2020**, *92*, 473–475. [CrossRef]
10. Estrada, M.; Park, D.; Lee, M. How a Massive Contagious Infectious Diseases Can Affect Tourism, International Trade, Air Transportation, and Electricity Consumption? The Case of 2019 Novel Coronavirus (2019-nCoV) in China. *SSRN Electron. J.* **2020**, 3540667. Available online: [https://papers.ssrn.com/sol3/papers.cfm?abstract\\_id=3540667](https://papers.ssrn.com/sol3/papers.cfm?abstract_id=3540667) (accessed on 16 June 2020). [CrossRef]
11. Hoque, A.; Shikha, F.A.; Hasanat, M.W.; Arif, I.; Hamid, A.B.A. The Effect of Coronavirus (COVID-19) in the Tourism Industry in China. *Asian J. Multidiscip. Stud.* **2020**, *3*, 52–58. Available online: <https://asianjournal.org/online/index.php/ajms/article/view/213/96> (accessed on 16 June 2021).
12. McCartney, G. The impact of the coronavirus outbreak on Macao. From tourism lockdown to tourism recovery. *Curr. Issues Tour.* **2020**, *24*, 2683–2692. [CrossRef]
13. Ranasinghe, R.; Damunupola, A.; Wijesundara, S.; Karunarathna, C.; Nawarathna, D.; Gamage, S.; Ranaweera, A.; Idroos, A.A. Tourism after Corona: Impacts of COVID-19 Pandemic and Way forward for Tourism, Hotel and MICE Industry in Sri Lanka. *SSRN Electron. J.* **2020**. Available online: [https://papers.ssrn.com/sol3/papers.cfm?abstract\\_id=3587170](https://papers.ssrn.com/sol3/papers.cfm?abstract_id=3587170) (accessed on 18 June 2021). [CrossRef]
14. Panarese, P.; Azzarita, V. The Impact of the COVID-19 Pandemic on Lifestyle: How Young people have Adapted Their Leisure and Routine during Lockdown in Italy. *Young* **2021**, *29*, S35–S64. [CrossRef]
15. Folinas, S.; Metaxas, T. Tourism: The Great Patient of Coronavirus COVID-2019. *Int. J. Adv. Res.* **2020**, *4*, 365–375. Available online: <https://mpr.ub.uni-muenchen.de/103515/> (accessed on 18 June 2021). [CrossRef]
16. Kaushal, V.; Srivastava, S. Hospitality and tourism industry amid COVID-19 pandemic: Perspectives on challenges and learnings from India. *Int. J. Hosp. Manag.* **2020**, *92*, 103012. [CrossRef]
17. Aigbedo, H. Impact of COVID-19 on the hospitality industry: A supply chain resilience perspective. *Int. J. Hosp. Manag.* **2021**, *98*, 103012. [CrossRef]
18. Burhan, M.; Salam, M.T.; Hamdan, O.A.; Tariq, H. Crisis management in the hospitality sector SMEs in Pakistan during COVID-19. *Int. J. Hosp. Manag.* **2021**, *98*, 103037. [CrossRef]
19. Sorells, M. Data Shows Severe Impact of Coronavirus on Global Hospitality Industry. Phocus Wire (26 March 2020). Available online: <https://www.phocuswire.com/str-global-hotel-data-march-21-coronavirus> (accessed on 16 June 2020).
20. Sanabria-Díaz, J.M.; Aguiar-Quintana, T.; Araujo-Cabrera, Y. Public strategies to rescue the hospitality industry following the impact of COVID-19: A case study of the European Union. *Int. J. Hosp. Manag.* **2021**, *97*, 102988. [CrossRef] [PubMed]
21. Duarte Alonso, A.; Kok, S.K.; Bressan, A.; O’Shea, M.; Sakellarios, N.; Koresis, A.; Buitrago Solis, M.A.; Santoni, L.J. COVID-19, aftermath, impacts, and hospitality firms: An international perspective. *Int. J. Hosp. Manag.* **2020**, *91*, 102654. [CrossRef] [PubMed]
22. Ostrowska-Tryzno, A.; Pawlikowska-Piechotka, A. Tourism, the hotel industry at the time of the COVID-19 pandemic. *Sport Tur. Srod. Czas. Nauk.* **2022**, *5*, 139–152. [CrossRef]
23. Ozdemir, O.; Dogru, T.; Kizildag, M.; Mody, M.; Suess, C. Quantifying the economic impact of COVID-19 on the U.S. hotel industry: Examination of hotel segments and operational structures. *Tour. Manag. Perspect.* **2021**, *39*, 100864. [CrossRef]
24. Hao, F.; Xiao, Q.; Chon, K. COVID-19 and China’s Hotel Industry: Impacts, a Disaster Management Framework, and Post-Pandemic Agenda. *Int. J. Hosp. Manag.* **2020**, *90*, 102636. [CrossRef]
25. Nair, G.K.; Hameed, S.; Prasad, S. Ready for recovery: Hoteliers’ insights into the impact of COVID-19 on the Indian hotel industry. *Res. Hosp. Manag.* **2021**, *11*, 199–203. [CrossRef]
26. Japutra, A.; Situmorang, R. The repercussions and challenges of COVID-19 in the hotel industry: Potential strategies from a case study of Indonesia. *Int. J. Hosp. Manag.* **2021**, *95*, 102890. [CrossRef]
27. Shay, R.; Cohen, E. The COVID-19 pandemic effect on stock prices of leading public chain hotels in Israel. In *Reviving Tourism, in the Postpandemic Era*, 1st ed.; Evangelos, C., Anestis, F., Eds.; School of Economics and Business, International Hellenic University: Sindos, Greece, 2022.
28. Napierała, T.; Leśniewska-Napierała, K.; Burski, R. Impact of Geographic Distribution of COVID-19 Cases on Hotels’ Performances: Case of Polish Cities. *Sustainability* **2020**, *12*, 4697. [CrossRef]
29. Piechaczek, A. Polish Domestic Tourism in the Face of SARS-CoV-2 Pandemic. *Folia Oeconomica Acta Univ. Lodz.* **2021**, *2*, 29–42. [CrossRef]

30. Soh, J.; Seo, K. An Analysis of The Impact of Short-Term Vacation Rentals on the Hotel Industry. *J. Hosp. Tour. Res.* **2021**. [CrossRef]
31. Medeiros, M.; Xie, J.; Severt, D. Exploring relative resilience of Airbnb and hotel industry to risks and external shocks. *Scand. J. Hosp. Tour.* **2022**, *22*, 274–283. [CrossRef]
32. Rivera, M.; Kizildag, M.; Croes, R. COVID-19 and small lodging establishments: A break-even calibration analysis (CBA) model. *Int. J. Hosp. Manag.* **2021**, *94*, 102814. [CrossRef]
33. Kostynets, V.; Kostynets, I.; Olshanska, O. Pent-up demand's realization in the hospitality sector in the context of COVID-19. *J. Int. Stud.* **2021**, *14*, 89–102. [CrossRef]
34. Wieczorek-Kosmala, M. COVID-19 impact on the hospitality industry: Exploratory study of financial-slack-driven risk preparedness. *Int. J. Hosp. Manag.* **2021**, *94*, 102799. [CrossRef]
35. Lock, S. Impact of COVID-19 on Hotel RevPAR in Europe 2020. Statista (10 November 2021). Available online: <https://www.statista.com/statistics/1128655/covid-19-change-in-trevpar-europe/> (accessed on 9 May 2022).
36. Lock, S. Global Change in Travel and Tourism Revenue due to COVID-19 2019–2020. Statista (7 January 2022). Available online: <https://www.statista.com/forecasts/1103426/covid-19-revenue-travel-tourism-industry-forecast> (accessed on 9 May 2022).
37. Shahin, A.; Mahbod, M.A. Prioritization of key performance indicators. An integration of analytical hierarchy process and goal setting. *Int. J. Product. Perform. Manag.* **2007**, *56*, 226–240. [CrossRef]
38. Németh, M.; Gyurác-Németh, P. Key performance indicators before and during/after the “COVID-19 times” in the Hungarian hotel sector. In *Reviving Tourism, in the Postpandemic Era*, 1st ed.; Evangelos, C., Anestis, F., Eds.; School of Economics and Business, International Hellenic University: Sindos, Greece, 2022; ISBN 978-618-5630-06-5.
39. Srivastava, N.; Maitra, R. Key performance indicators (KPI) in the hospitality industry: An emphasis on accommodation business of 5 star hotels of National Capital Region. *Int. J. Tour. Hosp. Res.* **2016**, *2*, 34–40. [CrossRef]
40. Chang, L.-C.; McAleer, M.; Ramos, V.A. Charter for Sustainable Tourism after COVID-19. *Sustainability* **2020**, *12*, 3671. [CrossRef]
41. Dahlke, P.; Orfin-Tomaszewska, K.; Sosnowski, P. Sustainability in the Hospitality Industry in the Shadow of the COVID-19 Pandemic: A Case Study of the Hospitality Industry in Poland. Available online: [https://www.e3s-conferences.org/articles/e3sconf/abs/2021/83/e3sconf\\_dsdm2021\\_08002/e3sconf\\_dsdm2021\\_08002.html](https://www.e3s-conferences.org/articles/e3sconf/abs/2021/83/e3sconf_dsdm2021_08002/e3sconf_dsdm2021_08002.html) (accessed on 21 May 2022).
42. Krishnan, V.; Mann, R.; Seitzman, N.; Wittkamp, N. Hospitality and COVID-19: How Long Until ‘No Vacancy’ for US Hotels? (10 June 2020). Available online: <https://www.mckinsey.com/industries/travel-logistics-and-infrastructure/our-insights/hospitality-and-covid-19-how-long-until-no-vacancy-for-us-hotels> (accessed on 21 May 2021).
43. Hoisington, A. 5 Insights about How the COVID-19 Pandemic Will Affect Hotels. *Hotel Management* (17 March 2020). Available online: <https://www.hotelmanagement.net/own/roundup-5-insights-about-how-covid-19-pandemic-will-affect-hotels> (accessed on 21 May 2021).
44. Annual Report 2020–2021. HOTREC, June 2021. Available online: <https://www.hotrec.eu/wp-content/customer-area/storage/f365e34316edd2cbe372d1bbfb08a372/HOTREC-Annual-Report-20-21.pdf> (accessed on 10 September 2022).
45. Barber, N.A. Profiling the Potential “Green” Hotel Guest: Who Are They and What Do They Want? *J. Hosp. Tour. Res.* **2012**, *38*, 361–387. [CrossRef]
46. Peng, N.; Chen, A. Luxury Hotels Going Green—The Antecedents and Consequences of Consumer Hesitation. *J. Sustain. Tour.* **2019**, *27*, 1374–1392. [CrossRef]
47. Kim, Y.J.; Kim, W.G.; Choi, H.-M.; Phetvaroon, K. The Effect of Green Human Resource Management on Hotel Employees’ Eco-Friendly Behavior and Environmental Performance. *Int. J. Hosp. Manag.* **2019**, *76*, 83–93. [CrossRef]
48. Szromek, A.R.; Kruczek, Z.; Walas, B. Stakeholders’ Attitudes towards Tools for Sustainable Tourism in Historical Cities. *Tour. Recreat. Res.* **2021**, 1–13. [CrossRef]
49. Shapoval, V.; Hägglund, O.; Pizam, A.; Abraham, V.; Carlbäck, M.; Nygren, T.; Smith, R.M. The COVID-19 pandemic effects on the hospitality industry using social systems theory: A multi-country comparison. *Int. J. Hosp. Manag.* **2021**, *94*, 102813. [CrossRef] [PubMed]
50. Danilewicz, D. Management Challenges in the Hotel Industry in the Face of Social and Technological Changes. In *Wyzwania Społeczne i Technologiczne a Nowe Trendy w Zarządzaniu Współczesnymi Organizacjami*; Urbaniak, M., Tomaszewski, A., Eds.; SGH: Warszawa, Poland, 2020; ISBN 978-83-8030-374-4.
51. Tourism in 2020. Statistics Poland (SP). Tables in XLSX Format in ZIP File. Available online: <https://stat.gov.pl/en/topics/culture-tourism-sport/tourism/tourism-in-2020,1,18.html> (accessed on 21 June 2021).
52. Walas, B. *Badania Opinii Pracodawców Podsektora Hotelarstwa w Czasie Pandemii COVID-19*; Instytut Turystyki: Kraków, Poland, 2021.
53. Enz, C.A.; Canina, L.; Walsh, K. Hotel-industry averages: An inaccurate tool for measuring performance. *Cornell Hotel Rest. A* **2001**, *42*, 22–32. [CrossRef]
54. Lieberman, W.H. Getting the most from revenue management. *J. Revenue Pricing Manag.* **2003**, *2*, 103–115. [CrossRef]
55. Hayes, D.K.; Miller, A.A. *Revenue Management for the Hospitality Industry*; John Wiley & Sons: Hoboken, NJ, USA, 2011; ISBN 978-0-470-39308-6.
56. Smart, K.; Ma, E.; Qu, H.; Ding, L. 2021. COVID-19 impacts, coping strategies, and management reflection: A lodging industry case. *Int. J. Hosp. Manag.* **2021**, *94*, 102859. [CrossRef]
57. Landman, P. Occupancy Rate, Xotels. Available online: <https://www.xotels.com/en/glossary/occupancy-rate> (accessed on 12 September 2022).

58. Hotel KPI's Explained: ADR, REVPAR and GOPPAR, Revfine.com. Available online: <https://www.revfine.com/what-is-adr-revpar-goppar/> (accessed on 12 September 2022).
59. Key Performance Indicators, Fáilte Ireland, Business Tools. Available online: [https://www.failteireland.ie/FailteIreland/media/WebsiteStructure/Documents/2\\_Develop\\_Your\\_Business/1\\_StartGrow\\_Your\\_Business/Key-Performance-Indicators.pdf](https://www.failteireland.ie/FailteIreland/media/WebsiteStructure/Documents/2_Develop_Your_Business/1_StartGrow_Your_Business/Key-Performance-Indicators.pdf) (accessed on 12 September 2022).
60. Tourism in 2019. Statistics Poland (SP). Tables in XLSX Format in ZIP File. Available online: <https://stat.gov.pl/en/topics/culture-tourism-sport/tourism/tourism-in-2019,1,17.html> (accessed on 21 June 2021).
61. Wójcicki, T. Application of the CAWI method for the holistic support of innovation transfer to business practice. *Maint. Probl.* **2012**, *4*, 175–186.
62. Barbu, A.; Isaic-Maniu, A. Data collection in Romanian market research: A comparison between prices of PAPI, CATI and CAWI. *Manag. Mark.* **2021**, *6*, 349–364. Available online: [file:///C:/Users/User/Downloads/DATA\\_COLLECTION\\_IN\\_ROMANIAN\\_MARKET\\_RESEARCH\\_A\\_COMP-2.pdf](file:///C:/Users/User/Downloads/DATA_COLLECTION_IN_ROMANIAN_MARKET_RESEARCH_A_COMP-2.pdf) (accessed on 20 September 2022).
63. Wykorzystanie Technologii Informatycznych w Jednostkach Administracji Publicznej, Przedsiębiorstwach i Gospodarstwach Domowych w 2019 Roku, Statistics Poland. 2020. Available online: <https://stat.gov.pl/obszary-tematyczne/nauka-i-technika-spolnoczenstwo-informacyjne/spoleczenstwo-informacyjne/wykorzystanie-technologii-informacyjno-komunikacyjnych-w-jednostkach-administracji-publicznej-przedsiębiorstwach-i-gospodarstwach-domowych-w-2019-roku,3,18.html> (accessed on 20 September 2022).
64. Market Report. Poland Market Update. Horwath HTL (August 2020). Available online: <https://www.hospitalitynet.org/file/152008876.pdf> (accessed on 14 September 2021).
65. STR SHARE Center. Available online: <https://str.com/training/academic-resources/share-center> (accessed on 4 June 2022).
66. Kwiecień w Hotelach: RevPAR w Krakowie—3,9 zł, Obłożenie w Trójmieście—3,5 Proc., Hotelarz (20 May 2020). Available online: <https://www.e-hotelarz.pl/artykul/67719/kwiecien-w-hotelach-revpar-w-krakowie-39-zl-oblozenie-w-trojmiescie-35-proc-2/> (accessed on 14 September 2021).
67. Działania Hoteli w Związku z Pandemią Koronawirusa—Wyniki Ankiety IGHP. Izba Gospodarcza Hotelarstwa Polskiego (23 April 2020). Available online: <https://www.ighp.pl/aktualnosci/szczegoly-aktualnosci?NewsID=46938> (accessed on 14 September 2021).
68. Turystyka Letnia w Czasach Pandemii. Komunikat z Badań (125/2020). Available online: [https://www.cbos.pl/SPISKOM.POL/2020/K\\_125\\_20.PDF](https://www.cbos.pl/SPISKOM.POL/2020/K_125_20.PDF) (accessed on 14 September 2021).
69. Panayotis, V. Assessment of the Hotel Industry in 2021: The French Hotel Industry Still Marked by the Crisis in 2021, Positive Signals Can Be Seen at the End of the Year. *Hospitality ON Magazine*, 17 January 2022, Updated on 17 March 2022. Available online: <https://hospitality-on.com/en/hotel-trends/assessment-hotel-industry-2021-french-hotel-industry-still-marked-crisis-2021-positive> (accessed on 20 September 2022).
70. Wykorzystanie Turystycznej Bazy Noclegowej w Polsce w Październiku i Listopadzie 2020 r. Statistics Poland (SP). Available online: <https://stat.gov.pl/obszary-tematyczne/kultura-turystyka-sport/turystyka/wykorzystanie-turystycznej-bazy-noclegowej-w-polsce-w-pazdzierniku-i-listopadzie-2020-r,6,23.html> (accessed on 14 September 2021).
71. Fatalny Październik w Hotelach—Ceny Wciąż Spadają, Gości Brak. Izba Gospodarcza Hotelarstwa Polskiego (9 November 2020). Available online: <https://www.ighp.pl/aktualnosci/szczegoly-aktualnosci?NewsID=51764> (accessed on 14 September 2021).
72. Hotelarstwie w Dobie COVID-19 Podczas V Forum Hotelarzy IGHP. Izba Gospodarcza Hotelarstwa Polskiego (9 October 2020). Available online: <https://www.ighp.pl/aktualnosci/szczegoly-aktualnosci?NewsID=50786> (accessed on 14 September 2021).
73. Magnini, V.; Crotts, C.J.; Calvert, E. The increased importance of competitor benchmarking as a strategic management tool during COVID-19 recovery. *Int. Hosp. Rev.* **2021**, *35*, 280–292. [CrossRef]
74. Fatima, T.; Elbanna, S. Balanced scorecard in the hospitality and tourism industry: Past, present and future. *Int. J. Hosp. Manag.* **2020**, *91*, 102656. [CrossRef] [PubMed]
75. Zaki, K. Implementing dynamic revenue management in hotels during COVID-19: Value stream and wavelet coherence perspectives. *Int. J. Contemp. Hosp. Manag.* **2022**, *34*, 1768–1795. [CrossRef]
76. Wadongo, B.; Odhuno, E.; Kambona, O.; Othunon, L. Key performance indicators in the Kenyan hospitality industry: A managerial perspective. *Benchmarking Int. J.* **2010**, *17*, 858–875. [CrossRef]
77. Mohamadkhani, K.; Lalardi, M.N. Emotional intelligence and organizational commitment between the hotel staff in Tehran, Iran. *Am. J. Bus. Manag.* **2012**, *1*, 54–59. [CrossRef]

## Article

# Changes in DMO's Orientation and Tools to Support Organizations in the Era of the COVID-19 Pandemic

Wojciech Fedyk <sup>1</sup>, Mariusz Sołtysik <sup>1</sup>, Justyna Bagińska <sup>2,\*</sup>, Mateusz Ziemia <sup>3</sup>, Małgorzata Kołodziej <sup>4</sup> and Jacek Borzyszkowski <sup>5</sup>

<sup>1</sup> Department of Tourism, Wrocław University of Health and Sport Sciences, al. I.J. Paderewskiego 35, 51-612 Wrocław, Poland

<sup>2</sup> Department of Tourism and Recreation, WSH University in Wrocław, ul. Ostrowskiego 22, 53-238 Wrocław, Poland

<sup>3</sup> Faculty in Chorzów, WSB University in Poznań, ul. Sportowa 29, 41-506 Chorzów, Poland

<sup>4</sup> Department of Biostructure, Wrocław University of Health and Sport Sciences, al. I.J. Paderewskiego 35, 51-612 Wrocław, Poland

<sup>5</sup> Faculty of Business, WSB University in Gdańsk, al. Grunwaldzka 238A, 80-266 Gdańsk, Poland

\* Correspondence: justyna.baginska@handlowa.eu

**Abstract:** Following the COVID-19 pandemic, the tourism industry has been hit by the biggest crisis in its history. Its effects are visible throughout the tourism industry, including the management system (DMOs). The study aim is to determine the changes that have been taking place in the operation of the destination management organizations (DMOs) in Poland as a result, including the usage of existing or expected organizational support tools. The study consisted of three stages: desk research, diagnostic survey, and qualitative and statistical analyses. Empirical data from all 16 regional DMOs in Poland were collected, including the use and effectiveness of the anti-crisis assistance programs, expectations towards the support tools, actions taken to mitigate the pandemic effects, and the changes in selected marketing activities and support strategies in the pre- and post-pandemic period. The study results indicated the insufficient availability of tools supporting the organizations' activities during a pandemic and little use by the DMOs of most of the tools offered by the anti-crisis programs, alongside a moderate assessment of their effectiveness. The need to modify anti-crisis programs and/or expand them to include other forms of assistance available to the DMOs was identified. The proposed research tool can be implemented to assess the necessary actions taken during the crisis in other types of tourism organizations in various regions.

**Keywords:** tourism; COVID-19; impact; DMO; support tools



**Citation:** Fedyk, W.; Sołtysik, M.; Bagińska, J.; Ziemia, M.; Kołodziej, M.; Borzyszkowski, J. Changes in DMO's Orientation and Tools to Support Organizations in the Era of the COVID-19 Pandemic. *Sustainability* **2022**, *14*, 11611. <https://doi.org/10.3390/su141811611>

Academic Editor: J. Andres Coca-Stefaniak

Received: 16 August 2022

Accepted: 13 September 2022

Published: 15 September 2022

**Publisher's Note:** MDPI stays neutral with regard to jurisdictional claims in published maps and institutional affiliations.



**Copyright:** © 2022 by the authors. Licensee MDPI, Basel, Switzerland. This article is an open access article distributed under the terms and conditions of the Creative Commons Attribution (CC BY) license (<https://creativecommons.org/licenses/by/4.0/>).

## 1. Introduction

Since early 2020, the coronavirus (COVID-19) pandemic has affected all aspects of human life [1]. This is especially discernable in the tourism industry, where virtually every sub-sector has suffered from the effects of the pandemic [2]. In the decade before the pandemic, tourism development was very dynamic [3], and it was suddenly stopped. The COVID-19 pandemic turned out to be the most severe crisis in the history of tourism development and completely changed the market situation [4]. Since March 2020, tourism businesses have been facing difficulties in a dynamic and uncertain environment. The COVID-19 pandemic reality should be considered as a factor of uncertainty, which translates into a “bleak picture” of tourism and thus a less favorable economic situation for the entities providing tourism services [5]. The impact of the COVID-19 on the tourism industry has unquestionably been huge. For example, airlines have ceased flights in countries significantly affected by the coronavirus and have grounded their fleet as they suspended operations [6]. Similarly, hotels (and the hospitality sector in general) have witnessed a decline in occupancy rates, and in a few cases, discrimination against Chinese nationals

was stated [7]. The effect of the pandemic is also evidenced in the events sector as mega events, including the Olympic Games, have been cancelled and postponed. Researchers estimate that the effects on tourism risk perceptions, destination marketing, and crisis management will be long-lasting even after the pandemic is controlled [8].

Coping with various, often unpredictable, events is a big challenge for a destination. This also applies to the impact of the COVID-19 pandemic. Therefore, considerable attention is paid to the functioning of individual destinations during the crisis. The key aspect relating to the operation of a destination is the participation of the different groups interested in its development, i.e., the stakeholders. The extent of the collaboration of tourism businesses with one another, their employees, and other stakeholders, such as destination management organizations (DMOs) and disaster management professionals, will also play a role [9]. This issue has become particularly important in recent years, including during the COVID-19 pandemic, and many destinations and tourism entities have a lot of catching up to do in this regard. Although all stakeholders must be involved in the process of creating destination resilience, a special role should certainly be played by the entities created to manage tourism, i.e., destination management organizations (DMOs) [10]. DMOs and tourism organizations can promote effective destination marketing by implementing appropriate risk communication strategies according to the crisis stage of the region [11]. Destination management organizations, while they typically operate proactively in the realm of marketing, are also responsible for taking a leadership role during and after a time of crisis to help the local tourism industry react to and recover from the event [12].

Therefore, it seems appropriate to pay attention to the impact of the COVID-19 pandemic on the functioning of DMOs. These organizations play an important role in creating the tourism function and development of individual destinations. It is also worth remembering that the main function of a DMO is to coordinate stakeholder efforts toward a shared vision [13]. The ability to carry out this task is determined by the quantity and the quality of the contacts the DMO has with local stakeholders and the governmental agencies [14]. In this regard, it can be assumed that the COVID-19 pandemic, which is affecting DMOs, will also affect the functioning of the entire destination, including the individual companies operating in its area. This is in line with Blackman et al. [15], who highlight the importance of DMOs in supporting the organizational learning of local tourism businesses, but who, concurrently, identify the complexity of the tourism industry, its diversity, and its managerial conservatism as critical impediments of organizational learning.

Against the background of the above considerations, the aim of the study was to determine the nature of the changes that took place in the operation of DMOs under the influence of crisis phenomena—in this case the COVID-19 pandemic, including through the existing or expected support tools in the closer and more distant environment of the organizations in Poland. Identification of the nature of the changes caused by COVID-19 in the DMOs' operating systems, which is the aim of the study, is of key importance for indicating the directions and features of the necessary evolution of tourism management systems in a given region in order to increase the competitiveness of regional tourism. The practical purpose of this study was also to propose an implementable research tool for the analysis of the necessary operational activities that should be undertaken in crisis conditions in other types of tourism organizations in the regions. Polish DMOs are already mature organizations, and they are currently waiting for transformation (including the currently processed formal and legal changes regarding the system of collecting and redistributing the tourist tax). Moreover, DMOs and the government administration in the field of tourism expect the development of tools allowing for the modification of management methods. Taking this into account, further studies of DMOs (regional and local) are also necessary, especially those covering the issues of the detailed determination of their new operational roles in the post-pandemic period.

The issue of the changes in the orientation of DMOs caused by crisis phenomena in a turbulent environment is marginalized by researchers, and the existing research focuses mainly on the general assumptions and models of operation related to the preparation of



DMOs for crisis situations [10,15]. In the last two years, scientists' interest in the impact of COVID-19 on the tourism sector has clearly increased [2,11], but such studies often ignored the role of DMOs. This study is an attempt to fill the knowledge gap and the research gap in assessing the degree of adaptation of tourism organizations in response to various types of crises, which may be of significant importance in building the resilience of DMOs and tourist destinations [9,12]. It is important because in the current situation it is impossible to predict the subsequent analogous crisis phenomena which are characteristic of VUCA (Volatility—Uncertainty—Complexity—Ambiguity) surroundings [5].

## 2. Literature Review

The focus on cooperation is the operational and functional core of modern tourism organizations in an economy based on knowledge and competence and managed by knowledge [16,17], and it becomes particularly important in the event of the emergence of crisis phenomena (i.e., pandemics, acts of terrorism, overtourism, natural disasters) in a turbulent tourism environment. Compulsory multi-directional cooperation should be included in the philosophy of the operational activity of each organization of the tourism sphere in times of crisis [18], especially in relation to those entities that act for the benefit of many types of stakeholders and play key roles; these are often regional leaders in the tourism management system at the regional level [19,20] or a specific instrument of regional tourism policy [21]. In addition, such types of organizations undoubtedly include destination management organizations (DMOs) [22], including Polish regional tourism organizations [23–25].

What is important is that DMOs are assigned many strategic roles and goals [26,27] which determine the forms and directions of the organizations' activities in cooperation with internal and external stakeholders in the region [28–30]. At the same time, it is worth emphasizing that the current uncertainty or instability in the operation of DMOs was mainly the result of the pragmatic concerns of the organizations [31,32], including such variables as the amount of membership fees and the sources of financing, the number of members, the level of obtained external subsidies, the stability of the management board, etc., and this has not been fully verified (excluding single case studies—see: [33,34]) by the highly influential random events, including the global COVID-19 pandemic. In a tourism economy where only uncertainty is certain [35], knowledge becomes a key source of sustainable competitive advantage [17,36] (especially when the phenomena in the tourism environment are random or highly destructive, such as the COVID-19 pandemic [37]). Thus, research on the regional structures operating in tourism clearly indicates that this area has still not been properly penetrated and requires further in-depth analysis [38,39], especially in the face of the challenges of the modern tourism economy, which requires a sustainable evolution of the DMOs' operation [40–42], often simultaneously with crisis phenomena in the environment [43].

The COVID-19 pandemic has prompted the need for different types of DMO interventions, either by regional tourism decision makers or tourism policy institutions [6,44]. The stakeholders of regional tourism markets who assemble in DMOs must cooperate and join forces in order to develop resilience in tourism, including during the COVID-19 pandemic [18]. DMOs, as destination management organizations, are atypical organizations for various reasons, but what one should pay attention to is the fact that their activities are also assessed according to their organizational effectiveness and efficiency [45], including supporting their own members and stakeholders in the region.

It should be emphasized that due to their position in tourism management systems in regions, DMOs often take the roles of precursors of operational activities and initiators of the implementation of new types of support tools for the stakeholders of the regional tourism market in the fight against the negative impact of crisis phenomena [46]. Restrictions in the sphere of organization, the handling of tourist traffic, or the promotion of tourism in regions caused by the COVID-19 pandemic, in a specific way forced the need to look for procedures, technologies, or operational instruments, referred to as crisis driver

innovations [47], in order to survive and continue the activities of the tourism market entities (including DMOs and their members). In an emergency, DMOs must undergo an organizational metamorphosis to survive the crisis of the COVID-19 pandemic and develop further, in order to be more flexible, inventive, and original in action [34,46]. In a crisis situation, DMOs must be involved in the internal and external support of their stakeholders (often small entrepreneurs and organizations from many tourism sectors), which requires coordination to ensure the coherence and effectiveness of action [27,48]. The communication of DMOs with members of the organization, stakeholders of the tourism economy, and tourists is also crucial in the time of the COVID-19 pandemic [49]. These activities must be planned, and they require both time and close coordination to avoid potential conflicts with stakeholders [50]. It seems necessary to change the philosophy of the DMOs' operations, with a transition from intervention, through promotion, to coordination of stakeholder activities in areas of common interest [51]. As a consequence, DMOs and stakeholders can contribute to maximizing mutual benefits [52].

It is assumed that the tourism organizations responsible for developing tourism will adopt extensive growth strategies in the near future to revitalize the tourism industry and meet the reshaping demand [53]. In order to make up for the losses incurred during the current crisis, it will be necessary for the tourism sector to increase its marketing activities [54] and develop a systemic approach to these activities at many organizational levels [6]. For example, the travelers' tendency to avoid a number of international travel destination types should prompt DMOs to take appropriate measures to, for example, promote domestic tourism [55]. The changes caused by the COVID-19 pandemic are the starting points for reflection on a new tourism model, especially on a regional scale. DMOs will be forced to reorient their marketing strategies [56,57].

To conclude the above considerations, it is worth confirming that the COVID-19 pandemic clearly influenced the functioning of the entire tourism sector [58–60], and it has largely affected DMOs as well [33]. Therefore, it seems justified to research and analyze the impact of the pandemic on DMOs, as well as on the anti-crisis measures taken by these organizations. It should be remembered that such actions are (or could have been) taken at various times during the pandemic, e.g., during the lockdown or immediately after it [61], which to a large extent could have diversified both the scope and the scale of the undertaken projects. This can be seen, for example, in the context of crisis communication. For example, at an early stage, the DMO should provide visitors with accurate and up-to-date information. In the medium term, marketing campaigns can effectively generate a positive message in the media. Finally, in the final stage, it becomes important to restore the image of the destination and provide relevant information to reassure tourists and rebuild confidence in traveling [62–64].

The literature review presented above fits in with the subject matter of this study. First of all, it concerns the most important issues relating to the importance of DMOs in the contemporary tourism market, including the scope of their activities [22,26,27]. Researchers rightly emphasize the dominant role of DMOs in creating the tourism function [13,24]. Such a role can also be expected from DMOs in the context of specific crisis situations [13,46]. It is particularly important in the field of the DMOs' relationship networks with their internal and external stakeholders [49]. Functioning in the time of the COVID-19 pandemic or other crises affects the scope of activities of an organization [33]; this is often the result of limited possibilities, e.g., financial or organizational possibilities. This affects practically all spheres of an organization's functioning, and even its philosophy [51]. Therefore, there is a need for in-depth analyses and considerations that would indicate the needs and expectations of these organizations in terms of support from the external environment. There are no such studies in the scientific literature, and the vast majority relating to the activity of DMOs in crisis situations is related to the undertaken [49], proposed, or expected actions [56,57]. It can be assumed that this study to a large extent fills the gap related to the needs of DMOs in the era of functioning in specific crisis situations. Contrary to many previously published studies, this work focuses on the expectations of the organizations.

Based on the above considerations, the following hypotheses were adopted in the study:

**Hypothesis 1.** *As a result of the COVID-19 pandemic, the organizations modified their priorities and revised their ventures, and thus, the importance of marketing activities and the elements of the support strategy in the assessment of DMOs changed.*

**Hypothesis 2.** *During the COVID-19 pandemic, DMOs made effective use of external support tools that were common and widely available.*

**Hypothesis 3.** *DMOs expect external support tools to mitigate the effects of the COVID-19 pandemic, provided they are dedicated to them.*

### 3. Materials and Methods

The research process was divided into three stages with the use of multidirectional analyses and the operation scheme presented in Figure 1 below.

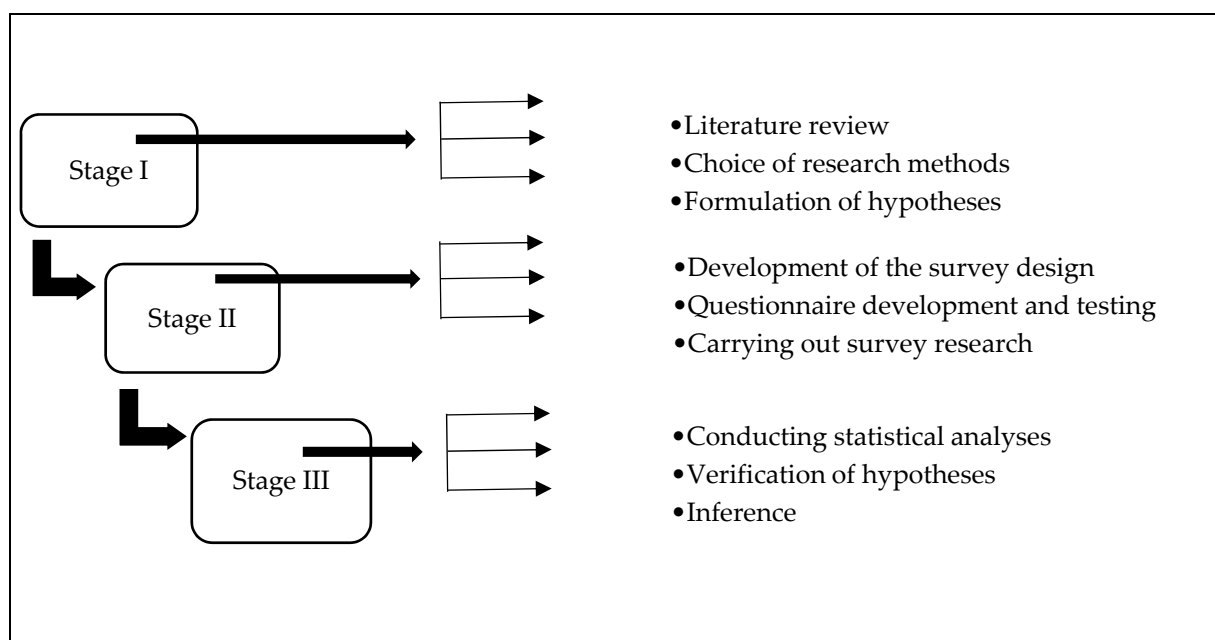

**Figure 1.** Graphical scheme of study design. Source: own elaboration.

In this study, primary and secondary data were analyzed, including the literature on the subject, the plans and reports on DMO activity, analytical study, data from the Central Statistical Office [65], and data from websites. A review of the scientific publications was made on the real and postulated directions of the development of DMOs; the areas and tools of cooperation of DMOs with the environment in the tourism economy, mainly in terms of the characteristics of their functioning (operational and marketing activities); the degree and nature of the impact of the COVID-19 pandemic on tourism; and the functioning of the management systems of tourism at the regional level with the participation of DMOs. Direct research based on a diagnostic survey with the use of a questionnaire (with both closed and open questions) with the use of the Google Forms application was of key methodological importance (the questionnaire form was included in the Supplementary Materials for the paper). The substantive components of the survey were based on previous DMO research (see [25,29,32,39]) and the process involved consultation (upon preparing the questionnaire) with experts from the Polish Tourist Organization and selected experts who had previously performed managerial roles in DMOs. The primary study (questionnaire) was conducted in August–September 2021 on all DMOs operating in Poland (16 organizations, whole

population) with a total of 1,504 members. There was no sampling as the research covered the entire population of DMOs in Poland, and all obtained questionnaires (fully completed according to the questions and cafeteria responses) were qualified for statistical analyses. The research was carried out on the basis of a questionnaire containing, in addition to the basic data of the organization (e.g., name, address, year of establishment, and legal form), substantive issues in the fields of, among others, the DMOs' activities limiting the effects of the COVID-19 pandemic, the importance of anti-crisis measures in the future, changes in the organizations' orientation towards anti-crisis tools—before and after the pandemic—and the level of the use, availability, and effectiveness of external support, as well as the DMOs' expectations in this respect on the part of entities from the immediate and further environment.

In order to carry out further analysis and achieve the set aim of the research, question numbers 6, 9, 16, 17, 18, 19, 20, and 21 (see the Supplementary Materials) were taken into account. The formulation of the conclusions was based on the methods of deduction and comparative analysis, using the technique of describing the differences and similarities. The authors also used their own observations and experiences as professionally active participants in the tourism management system in Poland (participant observation method). In order to simplify the presentation of the studied phenomena and identified problems, the data obtained in the survey were aggregated, limiting the number of the presented observations only to the most important results.

The analysis covered the respondents' answers regarding the available elements of the anti-crisis assistance program, which were used by organizations during the COVID-19 pandemic; the overall assessment of the effectiveness of these programs and solutions for the activities of the DMOs; the expectations regarding the support of other entities; and the actions taken to reduce the effects of the crisis related to the pandemic. In the description of the analyzed research issues, measurable synthetic indicators were used:

- Iai—indicator of internal actions (the sum of the values of the indications confirming the undertaken activities in relation to the maximum (possible to obtain) number of indications for all variables);
- Iaspa—indicator for assessing the significance of planned activities—after COVID-19 (the sum of the indicated point values for the individual variables (on a scale of 0–5), in relation to the maximum (possible to obtain) total point value for all the variables);
- Ir—indicator of reorientation in terms of the importance of actions—before and after COVID-19 (difference in the sum of the point values for individual variables (on a scale of 0–5), in both periods);
- Iues—indicator of the use of external support (the number of indications confirming the use of support in relation to the number of organizations);
- Ilaex—indicator of the lack of availability of external support (the number of indications of “not applicable” to the number of organizations);
- Iese—external support effectiveness indicator (the sum of the indicated point values for the individual variables (on a scale of 0–5), in relation to the maximum—possible sum of the point value for all the variables);
- Ieres—indicator of expectations regarding external support (the number of indications confirming the expectations of support in relation to the number of organizations).

For the above indices, the response differentiation coefficient was calculated as the ratio of the standard deviation to the mean percentage of the individual indications and adopted as the dispersion index (DI). For the qualitative (categorized) data, the frequency of occurrence (%) was calculated, and for the leading research issues, the significance of the structure indicator was checked using the Z-test for one proportion.

The results for the data on a 5-point scale (1–5 points) were presented as median  $\pm$  quartile deviation (MED  $\pm$  QD). The Shapiro–Wilk test did not confirm the normality of the distribution of the variables ( $p < 0.05$ ). The relationships between the variables were assessed by the Spearman's rank correlation coefficient with the Student's *t*-significance test for the correlation coefficient. The statistical significance of the results was accepted at  $p < 0.05$ .

According to the recommendations of Ferguson [66] for the correlation of data from social sciences, the values of Spearman's coefficient in the range of  $0.20 \leq \rho < 0.50$  were adopted as values characterizing the effect size of "practical" significance, for  $0.50 \leq \rho < 0.80$  the effect was assessed as moderate and for  $\rho \geq 0.80$  as strong. The differences between the dependent variables were checked by the Wilcoxon test. The statistical significance of the results was accepted at  $p < 0.05$ . All analyses were performed using TIBCOStatistica® 13.3.0 (StatSoft Poland Ltd., Kraków, Poland).

#### 4. Results

The statistical analysis of the primary data obtained as a result of the research allowed, within the assumed scope, the determination of the measurable indicators for the identification of the changes in the orientation of the surveyed DMOs resulting from the impact of the pandemic on their activities and the assessment of the organizational support tools used in terms of internal and external systems.

The total values of the DMOs' indications in relation to the measures taken to minimize the effects of the pandemic (expressed by the internal actions index—Iai) were at the level of Iai = 55%, with the dispersion index value—DI = 71%. The most common actions taken by organizations to reduce the effects of the crisis related to the pandemic included more detailed ongoing monitoring and analysis of the situation on the tourism market, indicated by all organizations (100%) as standard but also priority action in crisis situations, as well as the implementation of training systems to support tourism with the use of e-learning, undertaken by 94% of the surveyed organizations. A high implementation rate (in the structure of the DMOs' activities, intended to limit the negative impact of the pandemic on their functioning) was also indicated in the case of the changing of the rules and techniques for maintaining relationships with members of the organization (88%) and closer cooperation with other entities—75% (Figure 2). None of the surveyed organizations, both in their actual and their planned activities, took into account changes in their own organizational structure. Moreover, to a small extent, efforts were made to increase expenditure on the activities of the organization and to increase the number of markets—activities declared in both cases by 13% of organizations (Figure 2). The number of activities undertaken by the organization did not correlate with the number of support elements used, nor with the number of expectations regarding the support of other entities ( $\rho < 0.20$ ).

The assessments of the surveyed organizations regarding the importance of selected forms of activities planned for implementation in a post-pandemic situation (expressed by the Iaspa index = 88%; DI = 11%) indicate significant changes in their orientation, both in terms of marketing activities and support strategies. The results of detailed analyses of the opinions of the DMOs (defined on a scale of 0–5 for individual activities) indicate the dominant role of activities focusing on modern promotion in the near future (including, among others: guerilla marketing, viral marketing, e-mail marketing, and social media marketing). This type of future activity was indicated by all the surveyed organizations to the highest degree (MED  $\pm$  QD =  $5.0 \pm 0.0$ —on a 5-point scale). In the assessment of the marketing activities and support strategies, all organizations also indicated, as the leading form, cooperation with the environment (MED  $\pm$  QD =  $5.0 \pm 0.0$ ), with a noted, slightly lower score (98%—the maximum value; DI = 10.3%) and in order of importance—development of technology and reservation systems—96% (respectively, MED  $\pm$  QD =  $5.0 \pm 0.0$ ; DI = 11.3%). A high, over 90% degree of evaluation of the importance of post-pandemic activities was also recorded in the case of the development of tourism products, the planning of tourism development and human resources development, and the education and improvement of the quality of the tourist staff. Traditional promotional activities were rated the lowest—68% (MED  $\pm$  QD =  $3.5 \pm 1.0$ ) of the maximum point value and with a relatively high degree of differentiation (DI = 34.0%), followed by the crisis management strategy (78%; MED  $\pm$  QD =  $4.0 \pm 0.75$ ) and the reservation of services (75%; MED  $\pm$  QD =  $4.0 \pm 0.5$ ) (Table 1). The overall assessment of the future importance

of the support strategy was higher than the assessment of the importance of marketing activities ( $p = 0.034$ ). The revealed values of the DMOs' indications, in terms of assessing the importance of the planned marketing and strategic activities, prove a relatively similar direction of their planned organizational and management proceedings in the post-pandemic period. However, the dispersion index (DI) values of the point values of the indications (from DI = 0% to DI = 34.0%), noted in the case of the evaluation of the individual forms of activities, turn out not to confirm, despite a low level, the consistency of the surveyed organizations in this regard.

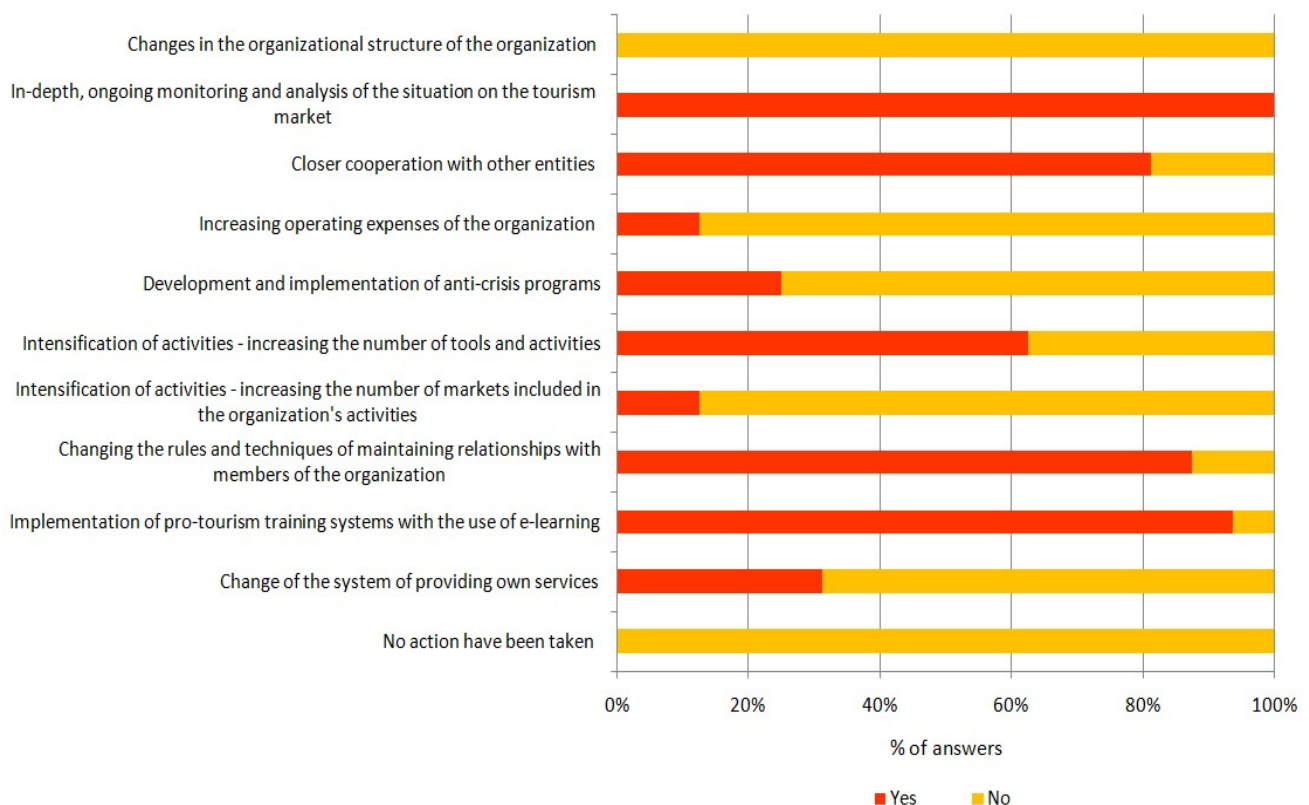

**Figure 2.** Actions taken by Polish DMOs to limit the effects of the crisis related to the COVID-19 pandemic. Source: own elaboration based on the survey.

**Table 1.** Assessment of the significance of selected forms of DMO activities in the future (for the years 2022–2023) against the background of the effects of the COVID-19 pandemic (on a scale of 0–5 points).

Marketing Activities MED ± QD		Support Strategy Activities MED ± QD	
Traditional promotional activities	3.5 ± 1.0	Planning of tourism development	5.0 ± 0.25
Modern promotional activities	5.0 ± 0.0	Development of human resources	5.0 ± 0.5
Tourist information	4.5 ± 0.5	Development of ICT	5.0 ± 0.0
Service reservation	4.0 ± 0.5	Crisis management	4.0 ± 0.75
Product development	5.0 ± 0.5	Cooperation with environment	5.0 ± 0.0
		Promoting the idea of sustainable development	5.0 ± 0.5
Overall assessment	4.5 ± 0.5	Overall assessment	5.0 ± 0.0

MED—median; QD—quartile deviation; overall assessment—median of partial assessments. Source: own elaboration based on the survey.

An extremely important issue that could show in a very real dimension the changes in the orientation of DMOs—including their philosophies of operation and the practical solutions in the organizations' operating models, caused by the COVID-19 pandemic, but

also in the potential threats of other crises—was to identify the differences in the assessment of the significance of the selected activities after the pandemic and the assessment of their significance before the COVID-19 pandemic (Figure 3). The sizes of the differences in the assessment of the importance of the activities in both periods were determined using the measurable reorientation index (Ir). The reorientation index (Ir) in this case ranged from  $-16.3\%$  to  $37.5\%$ . The highest values of differences were recorded in the scope of such forms of activities as the booking of tourist services (Ir =  $37.5\%$ ); crisis management (Ir =  $32.5\%$ ); and the development of technologies and information systems (Ir =  $26.3\%$ ).

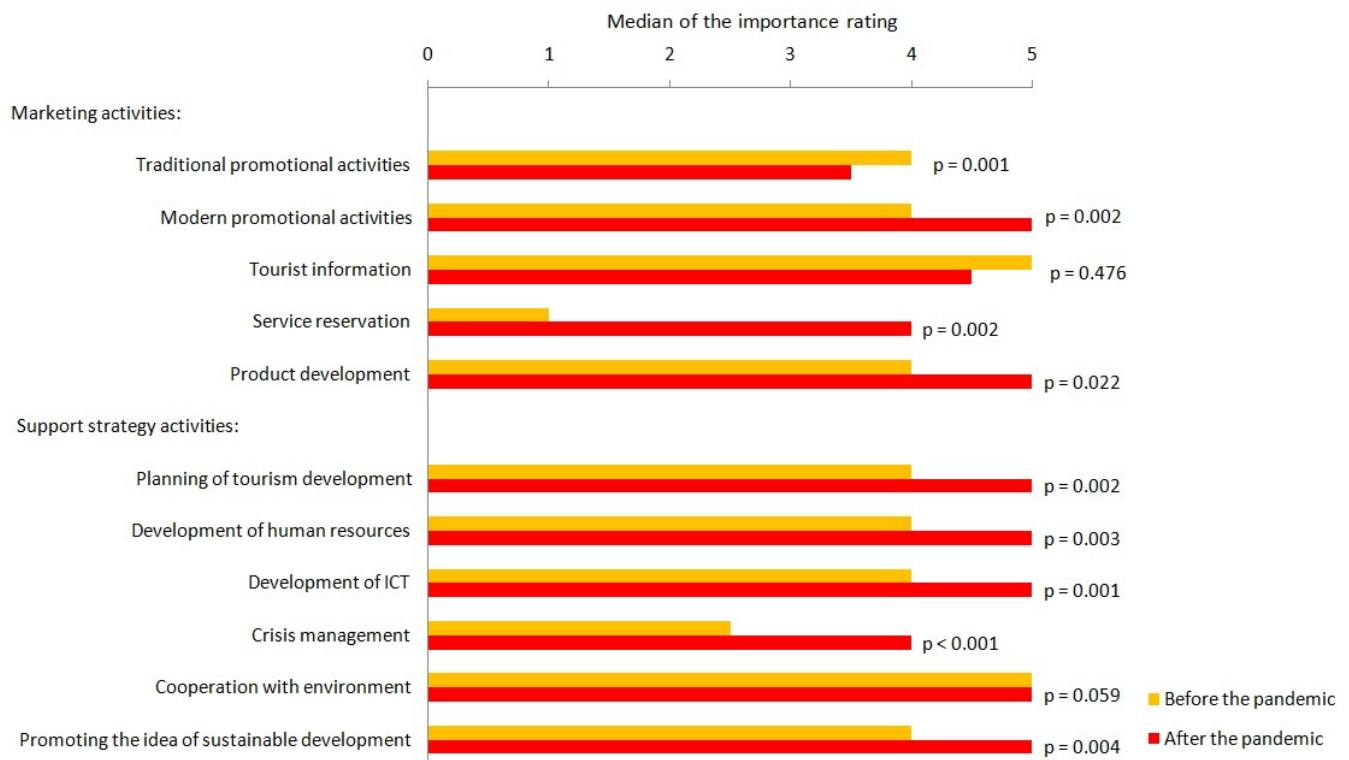

**Figure 3.** Assessment of the importance of selected activity forms of DMOs in the period before the pandemic and after the pandemic on a 0–5 scale—Wilcoxon’s test for differences. Source: own elaboration based on the survey.

Only traditional promotional activities (Ir =  $-16.3\%$ ), according to the organization’s assessment, and tourist information (Ir =  $-1.3$ ) lost their importance after the pandemic compared to the previous period. For the remaining forms, for which the differences in assessments were significant, their importance increased after the pandemic, and the reorientation index did not exceed the value of  $20\%$ . The only form of activity whose significance value did not change as a result of the impact of the pandemic was cooperation with the environment (Ir =  $0\%$ ).

The qualitative assessments related to the organizational reorientation in the areas of philosophy of action and practical solutions in potential crisis situations constituted a significant supplement to the observed changes in the meaning of the action mechanisms, as defined by the DMOs. Among the majority of the surveyed organizations, no reevaluation of the status of cooperation with the closer and more distant environment, due to the COVID-19 pandemic, was observed. No changes in the current operating philosophy were confirmed by  $60\%$  of the organizations. The most frequently indicated changes in this area, as declared by the organizations, were remodeling and adaptation to potential crisis conditions; remodeling and adaptation of leading organizational documents (statute and budget); intensification of cooperation with the environment in the form of increasing activities in the digital space; and increasing the participation of structural and external

entities in the fields of conceptualization, coordination, and implementation of promotional and development projects.

Contrary to the sphere of the philosophy of action, the changes in the field of future solutions, in particular the prevention or the minimizing of the effects of crises (including COVID-19), were confirmed in the future by the majority of organizations (60%). Among the most frequently presented proposals for solutions that may increase the possibilities and speed of the response to crisis situations by DMOs in the future were the implementation and intensification of financial mechanisms, both external and internal (in the system and at the national, regional, and local level of the DMOs); the legal and procedural support for domestic tourism market entities; the standardization and stabilization of business operations based on fixed assumptions which were also realistic in relation to potential crisis situations; and the increasing and intensifying of the structure of the marketing activities, both at the institutional level and at the tourist destination level.

The assessment of the availability, use, and effectiveness of external support tools for reducing the effects of the COVID-19 pandemic was described using measurable synthetic indicators showing both the frequency of the DMOs' indications in terms of individual issues and their value on a point scale. The total values of the organizations' indications were presented using the external support utilization index (Iues), the external support unavailability index (Ilaex), and the external support effectiveness index (Iese). All the indices were calculated and reported as percentages.

Table 2 shows the degree of use and the assessment of the effectiveness of the individual elements of the anti-crisis programs available for DMOs. Most of the support elements (from 9 to 13 elements) indicated in Table 2 did not apply to five of the organizations. One of the organizations did not indicate any element of support that would apply to it. The synthetic indicator of the use of external support (Iues) was at a significantly low level, Iues = 11.5%, and at the same time, there was a very strong differentiation of the indications of the organizations confirming the use of any form of support tools (DI = 207.3%). A definitely distinctive tool that all the DMOs used (in the regions where they were available) were the exemptions from social security contributions. The remaining support tools had the participation of only a small fraction of the organizations and were incidental in nature, oscillating in these cases at the level of 1% of the indications.

The indicator of the lack of availability of support (Ilaex) was at the level of Ilaex = 28.4% (DI = 34.4%). Among the most frequently mentioned forms of external support, which the DMOs expected to use in the regions of their operations and which they did not obtain due to their unavailability, the following were distinguished in particular: co-financing for the costs of running a business—44%; non-returnable loans—38%; and funds from state support, e.g., a financial shield—38%.

The results of the detailed analyses of the opinions of the DMOs (defined on a scale of 0–5 for the effectiveness of the individual tools) indicate an average level of their evaluation. In synthetic terms, it was determined by the value of the external support effectiveness indicator, Iese = 56.1%, with the differentiation of the indications, DI = 14.4%. The exemptions from social security contributions were defined by the surveyed DMOs as the dominant external support tool, the effectiveness of which was also rated the highest among the other anti-crisis programs and solutions available in a given area for the organization and its members (76.3% of the maximum value of indications and the highest median values: MED ± QD = 4.0 ± 1.0). Only three organizations benefited from the co-financing of wages and funds from the so-called “financial shield” or other forms of state support. Despite the fact that the organizations did not use the other indicated elements of the anti-crisis assistance programs, they assessed their effectiveness at a similar level, as the median of the scores was 3 for all of them (Table 2). None of the organizations indicated the reasons for not using particular forms of support (the answer was not obligatory). No relationship was found between the number of support elements used and the total assessment of their effectiveness ( $\rho = -0.07$ ,  $p = 0.811$ ).



**Table 2.** Scale of use and availability of anti-crisis programs for DMOs and evaluation of their effectiveness.

DMO Support Tools	Indicator of the Use of External Support [Iues]	Indicator of the Lack of Availability of External Support [Ilaex]	Indicator of the Use of External Support [Iues] (MED ± QD)
Exemptions from social security fees	100% (14)	13% (2)	76% 4.0 ± 1.0
Standstill benefit (e.g., for social security fees)	9% (1)	31% (5)	59% 3.0 ± 0.0
Non-refundable loans	10% (1)	38% (6)	55% 3.0 ± 0.5
Co-financing of the costs of running a business	0	44% (7)	54% 3.0 ± 0.5
Co-financing of employees' salaries and social security fees	27% (3)	31% (5)	61% 3.0 ± 0.5
Funds obtained from the so called "Financial shield" or other forms of support from the state	30% (3)	38% (6)	61% 3.0 ± 0.5
Grants and liquidity loans from EU aid funds	0	31% (5)	55% 3.0 ± 0.5
Subsidies from public and local government institutions	0	31% (5)	58% 3.0 ± 0.0
Exemptions from office rent	8% (1)	19% (3)	58% 3.0 ± 0.8
Funds from special fundraising organizations run by other organizations or private individuals	0	31% (5)	46% 3.0 ± 1.0
Subsidies from other institutions from the environment	0	19% (3)	54% 3.0 ± 0.5
Sponsorship of private persons and other business entities	0	31% (5)	49% 3.0 ± 1.0
Other	0	13% (2)	44% 3.0 ± 1.0

Source: own elaboration based on the survey.

Against the background of the scale of use, availability, and effectiveness of the support tools used during the COVID-19 pandemic to reduce its effects, an assessment was also made of the expectations of the DMOs in relation to the potential sources for obtaining them; those sources were public, private, and social. The values of the indications of the surveyed organizations indicate a significant demand of the organization for numerous forms of anti-crisis assistance, especially from direct and indirect supreme institutions, such as those of the local and central government administrations. The synthetic index determined for the purpose of assessing the analyzed features (Ieres—index of expectations regarding external support) reached the level of Ieres = 53%, with a strong dispersion of readings at DI = 66.8%.

Among the expectations regarding support from other entities, all the DMOs indicated the need for support from the regional government (100%). The next most frequently indicated entities from whom aid was expected were the government and/or the Ministry of Tourism and the National Tourist Organization (93.8%) and the institutions operating the EU aid funds (87.5%). The least frequently indicated by the DMOs as sources of expected aid for counteracting the COVID-19 pandemic were private persons, local tourist organizations, and other entities (Figure 4). In the case of these sources, the values of the indications among the DMOs did not exceed 25%. A statistically significant and moderate relationship was confirmed between the number of entities indicated by the organizations that were expected to receive support and the number of elements of anti-crisis assistance programs that did not apply to a given organization (were not available for it) ( $\rho = 0.51$ ,  $p = 0.044$ ). A slightly weaker and negative relationship was observed between the number of expected support forms and the number of used forms of anti-crisis aid ( $\rho = -0.42$ ,  $p = 0.103$ ).

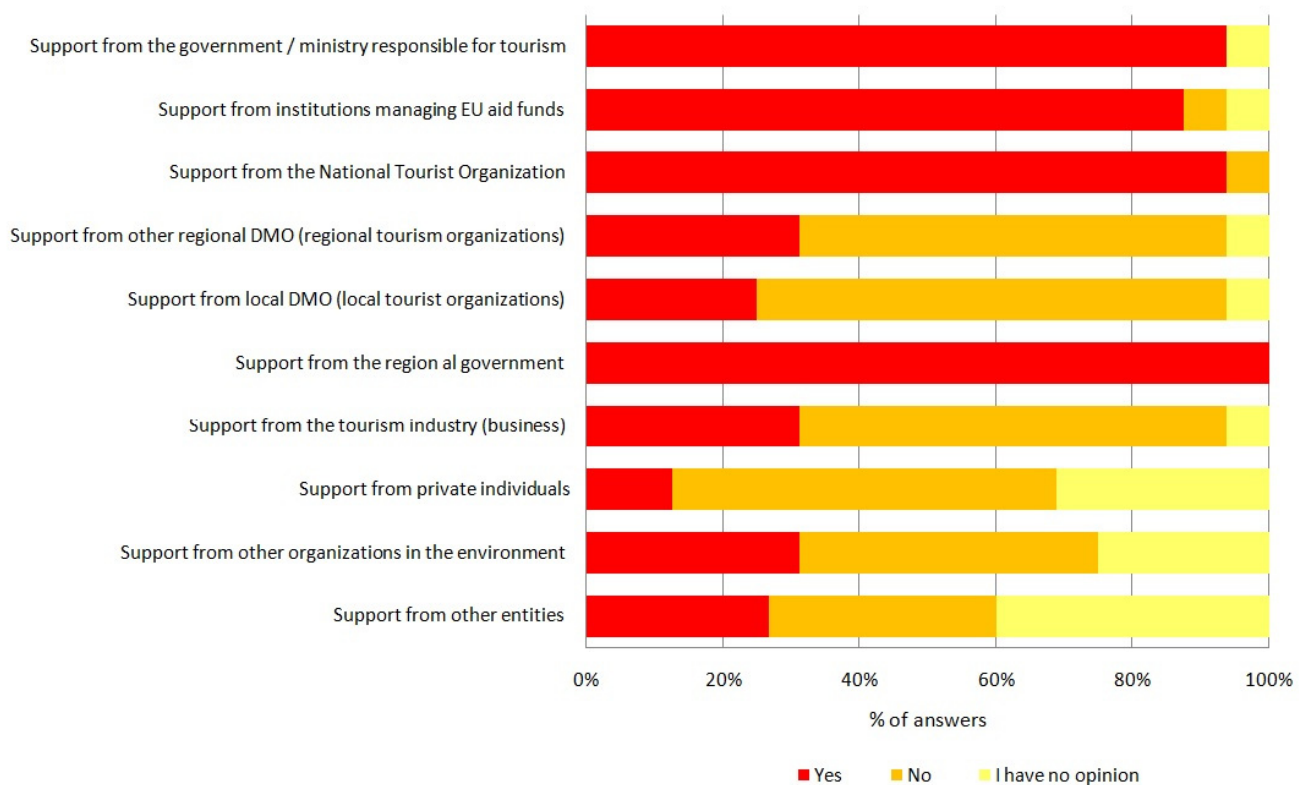

**Figure 4.** Expectations of Polish DMOs in terms of support from entities in the close and distant environment. Source: own elaboration based on the survey.

Despite the lack of statistical significance of this correlation, the value of the Spearman coefficient exceeded the minimum effect size representing a “practically” significant impact on the data from the social sciences [66].

## 5. Discussion

The COVID-19 pandemic evidently shook the tourism economy around the world [58–60]; this resulted in a parallel boom in scientific research [67], which was subject to the need for in-depth reflection—here, it was more about the amount of research time and distance—when assessing the nature of the impact of the pandemic on the tourism sphere or its local operators, such as DMOs and tourism industry stakeholders.

The research conducted among all 16 regional DMOs in Poland seems to confirm the opinions and position of the many researchers talking about the reorientation of the organizations’ activities. Based on the analyses, it has been shown (see Hypothesis 1) that as a result of the COVID-19 pandemic the importance of actions and support strategy elements in the assessment of the DMOs has changed. For most of the activities specified in the research, significant changes were found in the assessment of their significance, as confirmed by the results of the organizations’ opinions, both in terms of the number of indications and the score value. The organizations modified their priorities and thus revised the implemented and planned activities. First of all, it is noticeable that the importance of the projects in the field of the support strategies is growing. This confirms the opinions of many scientists about the need and change of orientation of the studied organizations [51].

The crisis in the tourism environment caused by the COVID-19 pandemic accelerated the process of the DMOs’ own evolution towards the concept of DM and MO (destination management and marketing organization). DMOs also prompted the expansion of support activities and an integrated approach, which covered various areas of intervention at the management level [68], or they implemented remedial strategies in the tourism economy [40,69]. The crisis caused by COVID-19 also forced the need to adapt (or even

change) the tourism management model in the DMOs' systems and their adaptation to the requirements of new times and new phenomena [51]. The obtained results of the research conducted among Polish DMOs clearly confirmed the growing importance of activities in the field of crisis management. At the same time, it is worth mentioning another sphere of activities, namely that relating to cooperation with the environment, including stakeholders. These activities were highly rated even before the pandemic, and the importance of this factor was confirmed by the DMOs' plans for the coming years. These organizations have been shown to engage with and support both their internal and their external stakeholders [48]. These activities must be planned, and they require both time and close coordination to avoid potential conflicts with stakeholders [50]. Taking into account the above deliberations and the survey results, a conclusion can be drawn about the urgent need to amend the catalog of roles (established by statutory norms in Poland) that should be performed by regional DMOs in times of crisis. This catalog should be established in consultation with the practitioners employed in DMOs and the scientific community, with the support of key system stakeholders.

The proposed changes are also a confirmation of previous research relating to both the change in the orientation of the DMOs and the need to adapt the organizations to the changing market conditions, especially in crisis situations. DMOs need to adapt their marketing and management strategies to the rapid changes and uncertainties in the COVID-19 period, including using stakeholder management theories and agile thinking in order to be more flexible in crisis periods [70] post-pandemic; it is also necessary to open up to an innovative solution for the DMOs' operation strategies, including the use of new technologies [71] or even a digital communication strategy with members and the environment [72]. Developing the catalog of the DMOs' e-support tools (including its members), such as e-learning training or hybrid conferences, is a need of the moment, and as shown by the conducted research, DMOs expect them in the regions. It is also necessary for DMOs to look for patterns to follow in the benchmarking formula [73] to introduce support tools that will allow the industry to respond faster and more effectively to crisis phenomena in regional tourism and its components. For example, the COVID-19 pandemic has "brought to their knees" the organizers of the meetings industry in cities and destinations and at the same time has caused changes in the ITC tools used in DMC activities in the MICE sector [73]. Therefore, it seems necessary to involve the scientific community and business and management practitioners in the search for good practices in tourist-developed destinations in the field of anti-crisis actions and then implement them in the organizational practices of Polish DMOs.

At the same time, when referring to the received and expected support by the surveyed organizations, quite significant differences in the declarations of the DMOs can be noticed. The results of the observations and the conducted analyses did not allow the confirmation of the effective use of the available support tools by the Polish DMOs (see Hypothesis 2). Obviously, this does not mean that these organizations are reluctant to accept the proposed anti-crisis solutions and instruments. In this regard (here, the low absorption of support tools), it is more likely that the regions cannot benefit from the support because in many cases the available tools were not directed directly to the DMOs, but to all market entities, including the tourism economy. Nevertheless, the surveyed DMOs clearly expect support from entities from the external environment, which refers directly to the adopted Hypothesis 3, including the observation that the lack of availability of individual elements of anti-crisis programs or the low level of their use by DMOs determined a greater number of indicated entities, from which support was expected.

It is worth mentioning that although a given DMO usually plays the role of a leader in a given destination, it is not possible for this organization to deal with problems arising from specific crisis situations on its own. For example, in many cases the government or its designated agencies should take over some of the responsibilities related to, inter alia, crisis response and interventions [33]. Regardless of the administrative level at which DMOs operate (national, regional, and local), government interventions are necessary,

for example, to ensure adequate resources, financial support, and the implementation of policies that may contribute to the revival of tourism [74]. Thus, DMOs do not have the legal, organizational, or financial capacity to independently solve specific problems on a regional scale. Therefore, they seek communication with regional or government authorities and institutions in situations such as the COVID-19 pandemic, which direct DMOs into the appropriate strategic directions and even legal actions [75].

In the opinion of the DMOs, the help of the government authorities in many cases is insufficient, which was also noticeable during the various phases of the COVID-19 pandemic. The responsibility of national government has often been resolved through the adopted general government tourism and communication policy. At the same time, the expectations of tourism market entities, including DMOs, are much more advanced and mainly include financial support, such as subsidies and tax breaks, which are considered to be key determinants of the revival of tourism [33]. This is certainly worrying, as the industry expects much more concrete action and a fair and effective distribution of funds during a crisis [76]. Therefore, the expectations of the surveyed DMOs seem to be right in terms of supporting their activities in many dimensions, including marketing and strategic ones. Researchers have confirmed [77] that government policy and intervention are practically essential to strengthening and further developing resilience in the time of the COVID-19 pandemic. Governments were also responsible for a quick response and the need to adapt to the existing threats [78]. During the pandemic, the government has also become a much bigger actor in the tourism economy (e.g., re-nationalization of airlines and other tourism companies and tourism infrastructure such as airports) [6]. This is quite unique for COVID-19, as previous crises have generated research and institutional interest, but they did not have policy impact, particularly on tourism [59]. The issue to be resolved, however, is the scope and size of such support. Sigala [6] considers governmental interventions as ‘economic support (e.g., subsidies, tax reliefs) to tourism business and employees’, while Sharma et al. [18] plead for governmental stimulus packages and interventions. For Higgins-Desbiolles [76], however, tourism businesses and organizations are just about always eager to return back to “normal” by accepting governmental interventions and stimulus packages, leading to questions regarding their fairness, effectiveness, and distribution. The scope of intervention in this respect should, of course, be much wider [79]. The government should deliver information as far as possible to residents and tourists in order to make them feel comfortable and to gain their trust. At the same time, the government should make use of various technologies and social media channels to communicate with residents and tourists to obtain their feedback with policy responses.

Regardless of the adopted hypotheses and their verification, it can be concluded that the role of DMOs in the modern tourism economy is of key importance, and the status of the activities of these organizations has increased, especially in the difficult period of the COVID-19 pandemic [46,49,80,81]. DMOs can, or even should, be treated as the basic entities responsible for the comprehensive management of a destination, including its image [10,82]. Nowadays, DMOs play a key role in the exchange of information between stakeholders and try to manage increasingly complex relationships in their environment and in the region [83], which should be manifested in the creation of new forms of cooperation or support tools that DMOs use.

## 6. Conclusions

The COVID-19 pandemic has left its mark on the operation of all tourism sectors and has particularly severely destabilized the operation of regional tourism management structures, including DMOs. The need to urgently assess the impact of crisis phenomena on the functioning of DMOs was the basis for the analyses undertaken in this study. These analyses allowed for the identification of changes in the organization’s orientation and also showed deficiencies in the types of operating tools and support mechanisms of the organizations, both from the internal perspective and from the environment. The key problems of DMOs today derive from the lack of dedicated support and targeted tools on

the part of some entities and external systems, including the EU. Therefore, it becomes necessary to increase the involvement of tourism policy entities at different levels of the administrative division of the state, and in this regard, it is necessary to provide for the specific roles of both public and private entities in the action supporting DMOs. As shown by the conducted analyses and the literature review, DMOs have all the features and predispositions to become the most important players in the tourism market of a given destination, including in times of crisis, provided that they are supported by the broadly understood environment.

## 7. Limitations and Further Research

The research results contained in the study relating to the reorientation of activities, as well as the obtained and expected support by the DMOs, have specific limitations, which at the same time may define further directions of research and analysis:

1. The in-depth considerations presented in the study focus on the analyses of only a few selected variables (out of a total of 21 included in the questionnaire), but nevertheless, the obtained data and results may be the basis for conducting comparative analyses of the nature and support tools used by other types of organizations (for their members) working for the development of tourism at a local or regional level. Despite the fact that the research was based on the subjective opinions of the DMOs' representatives, the opinions obtained from the stakeholders make it possible to indicate the type of orientation of the DMOs (including their members) towards the implemented or expected support tools in times of crises in the tourism economy, including those caused by phenomena such as the COVID-19 pandemic.
2. The conducted analysis was limited only to the Polish market and specifically to regional DMOs. Thus, the obtained results do not reflect the general picture of the reorientation of the pro-tourism organizations and the perception of the obtained and expected support tools. Hence, it would be reasonable to extend the research to include organizations operating in other countries, as well as to represent other levels of administration (including national and local DMOs). Obtaining the detailed data would allow for their comparison and, consequently, show the similarities and differences in terms of both individual countries and various levels of administration working for the development of tourism in a given area.
3. The obtained research results are quite limited, especially in the context of assessing the changes in the types of activities and support tools, as they only show the position of the DMOs. These organizations are key players in the contemporary tourism market, but their activities are nevertheless based on extensive cooperation between representatives of the public and the private sectors. In many cases (as in Poland), these organizations additionally have a complicated and diverse structure of membership and cooperating entities in the environment. Therefore, it would also be reasonable to conduct research and analyses relating to the perception of changes in the activities of DMOs by their stakeholders from the immediate and distant environment, as well as the evaluation of the obtained support tools.

The need to conduct qualitative assessments of the support activities undertaken by DMOs with the participation, or for the benefit, of members of the organization should be a strategic goal of interdisciplinary research, especially in the face of the rapidly changing conditions of the tourism sphere functioning caused by various types of crises. Future research on the specification of the roles and tasks to be performed by regional-level DMOs and the operational modes of the organizations towards stakeholders and tourist administration entities at various levels during crisis phenomena should be considered crucial. Against the background of the available sources of knowledge and the review of the scientific publications, it can be cautiously stated that the research and evaluation of the forms, tools, and instruments of support for DMOs (including its members) in crisis situations are strongly limited or even marginalized. This situation limits the chance to implement management innovations in tourism organizations [84], including those

such as DMOs, which have to face the growing wave of various types of threats in the tourism economy and in the functioning of the tourism sphere in tourism reception areas. The search for the most effective and efficient support systems for tourism stakeholders (concentrated in pro-tourism organizations) in crisis situations in the environment should become a priority for the entire sphere of tourism economy entities, with the involvement of the scientific communities researching DMOs.

**Supplementary Materials:** The following supporting information can be downloaded at: <https://www.mdpi.com/article/10.3390/su141811611/su141811611/s1>, File S1: Questionnaire.

**Author Contributions:** Conceptualization, W.F., M.S. and J.B. (Jacek Borzyszkowski); methodology, W.F., M.S., J.B. (Jacek Borzyszkowski) and M.K.; formal analysis, W.F., M.S., J.B. (Jacek Borzyszkowski), M.K., J.B. (Justyna Bagińska) and M.Z.; investigation, W.F., M.S., J.B. (Jacek Borzyszkowski), M.K., J.B. (Justyna Bagińska) and M.Z.; resources, W.F., M.S. and J.B. (Jacek Borzyszkowski); writing—original draft preparation, writing—review and editing, W.F., M.S., J.B. (Jacek Borzyszkowski), M.K., J.B. (Justyna Bagińska) and M.Z.; supervision, W.F., M.S. and J.B. (Jacek Borzyszkowski); project administration, W.F., M.S. and J.B. (Jacek Borzyszkowski); translations, J.B. (Justyna Bagińska); software, visualization, M.K. All authors have read and agreed to the published version of the manuscript.

**Funding:** This research received no external funding.

**Institutional Review Board Statement:** Not applicable.

**Informed Consent Statement:** Not applicable.

**Data Availability Statement:** Not applicable.

**Acknowledgments:** We are particularly grateful to the management of the DMOs (regional level) in Poland for supporting the research process.

**Conflicts of Interest:** The authors declare no conflict of interest.

## References

1. Kang, E.M.; Lee, S.K. The Impact of Monetary Benefits in a Pandemic Situation—Navigating Changes in Customer Loyalty through Negative Switching Barriers in the Hotel Industry. *Sustainability* **2022**, *14*, 8079. [CrossRef]
2. Gössling, S.; Scott, D.; Hall, C.M. Pandemics, tourism and global change: A rapid assessment of COVID-19. *J. Sustain. Tour.* **2021**, *29*, 1–20. [CrossRef]
3. Nientied, P. Rotterdam and the question of new urban tourism. *Int. J. Tour. Cities* **2020**, *7*, 344–360. [CrossRef]
4. Vegnuti, R. Cinque Terre, Italy—A case of place branding: From opportunity to problem for tourism. *Worldw. Hosp. Tour. Themes* **2020**, *12*, 471–483. [CrossRef]
5. Lubowiecki-Vikuk, A.; Sousa, B. Tourism Business in a VUCA World: Marketing and Management Implications. *J. Environ. Manag. Tour.* **2021**, *12*, 867–876. [CrossRef]
6. Sigala, M. Tourism and COVID-19: Impacts and implications for advancing and resetting industry and research. *J. Bus. Res.* **2020**, *117*, 312–321. [CrossRef]
7. Wen, J.; Aston, J.; Liu, X.; Ying, T. Effects of misleading media coverage on public health crisis: A case of the 2019 novel coronavirus outbreak in China. *Anatolia* **2020**, *31*, 331–336. [CrossRef]
8. Ying, T.; Wang, K.; Liu, X.; Wen, J.; Goh, E. Rethinking game consumption in tourism: A case of the 2019 novel coronavirus pneumonia outbreak in China. *Tour. Recreat. Res.* **2020**, *46*, 304–309. [CrossRef]
9. Jiang, Y.; Ritchie, B.W.; Verreynne, M. Building tourism organizational resilience to crises and disasters: A dynamic capabilities view. *Int. J. Tour. Res.* **2019**, *21*, 882–900. [CrossRef]
10. Borzyszkowski, J. Destination management organizations (DMO's) and crisis management. *J. Tour. Serv.* **2013**, *4*, 6–17.
11. Han, S.; Yoon, A.; Kim, M.J.; Yoon, J.-H. What influences tourist behaviors during and after the COVID-19 pandemic? Focusing on theories of risk, coping, and resilience. *J. Hosp. Tour. Manag.* **2022**, *50*, 355–365. [CrossRef]
12. Cartier, E.A.; Taylor, L.L. Living in a wildfire: The relationship between crisis management and community resilience in a tourism-based destination. *Tour. Manag. Perspect.* **2020**, *34*, 100635. [CrossRef]
13. Toubes, D.R.; Araújo-Vila, N.; Brea, J.A.F. Be water my friend: Building a liquid destination through collaborative networks. *Tour. Manag. Perspect.* **2020**, *33*, 100619. [CrossRef]
14. Paraskevas, A.; Arendell, B. A strategic framework for terrorism prevention and mitigation in tourism destinations. *Tour. Manag.* **2007**, *28*, 1560–1573. [CrossRef]
15. Blackman, D.; Kennedy, M.; Ritchie, B. Knowledge management: The missing link in DMO crisis management? *Curr. Issues Tour.* **2011**, *14*, 337–354. [CrossRef]

16. Gardiner, S.; Scott, N. Successful tourism clusters: Passion in paradise. *Ann. Tour. Res.* **2014**, *46*, 171–173. [CrossRef]
17. Della Lucia, M.; Dimanche, F.; Giudici, E.; Camargo, B.A.; Winchenbach, A. Enhancing tourism education: The contribution of humanistic management. *Humanist. Manag. J.* **2021**, *6*, 429–449. [CrossRef]
18. Sharma, G.D.; Thomas, A.; Paul, J. Reviving tourism industry post-COVID-19: A resilience-based framework. *Tour. Manag. Perspect.* **2020**, *37*, 100786. [CrossRef]
19. Presenza, A.; Sheehan, L.; Ritchie, J.B. Towards a model of the roles and activities of destination management organizations. *J. Hosp. Tour. Leis. Sci.* **2005**, *3*, 1–16.
20. Valente, F.; Dredge, D.; Lohmann, G. Leadership and governance in regional tourism. *J. Destin. Mark. Manag.* **2015**, *4*, 127–136. [CrossRef]
21. Fortes, S.; Mantovaneli Junior, O. Desarrollo regional y turismo en Brasil: Políticas En El Valle Europeo. *Estud. Perspect. Tur.* **2009**, *18*, 655–671.
22. Pike, S. *Destination Marketing: An Integrated Marketing Communication Approach*; Elsevier Inc.: Oxford, UK, 2008; Volume 1.
23. Debski, M. Współpraca interesariuszy destynacji w procesie kreowania jej konkurencyjności”. *Organizacja i Kierowanie. Organ. Manag.* **2012**, *152*, 73–86.
24. Borzyszkowski, J. *Organizacje Zarządzające Obszarami Receptji Turystycznej. Istota, Funkcjonowanie, Kierunki Zmian*; Wydawnictwo Uczelniane Politechniki Koszalińskiej: Koszalin, Poland, 2015.
25. Fedyk, W. Regionalne organizacje turystyczne jako Destination Management Company—Probiznesowy model działania. *Folia Tur.* **2018**, *47*, 27–52. [CrossRef]
26. Klimek, K. The Role of Destination Management Organizations (DMOs) in Commercialization of Summer Tourism Products. New Challenges for Mountain Destinations in an Integrated and Global e-Market Place. *Èkon. Probl. Tur.* **2017**, *40*, 19–28. [CrossRef]
27. Xie, W.; Li, H.; Yin, Y. Research on the Spatial Structure of the European Union’s Tourism Economy and Its Effects. *Int. J. Environ. Res. Public Health* **2021**, *18*, 1389. [CrossRef] [PubMed]
28. Borzyszkowski, J. Ocena działalności organizacji zarządzających obszarami receptji turystycznej—Implikacje dla teorii i praktyki. *e-Mentor* **2016**, *66*, 46–54.
29. Fedyk, W.; Morawski, M.; Morawska-Bąkowska, U.; Langer, F.; Jandová, S. Model of cooperation in the network of non-enterprise organizations on the example of Regional Tourist Organizations in Poland. *Èkon. Probl. Tur.* **2018**, *44*, 113–137.
30. Khan, T.; Tariq Khan, M.; Ahmed Khan, N.; Ahmed, S.; Ali, M. Connotation of Organizational Effectiveness and Factors Affecting It. *Int. J. Bus. Behav. Sci.* **2012**, *2*, 21–29.
31. Borzyszkowski, J. Problem finansowania organizacji zarządzających obszarami receptji turystycznej—Przykład struktur lokalnych. *Èkon. Probl. Tur.* **2018**, *41*, 23–30.
32. Fedyk, W. Struktura zarządów regionalnych organizacji turystycznych w Polsce jako uwarunkowanie skuteczności działania organizacji. *Rozpr. Nauk. Akad. Wych. Fiz. Wrocławiu* **2015**, *51*, 26–37.
33. Kuščer, K.; Eichelberger, S.; Peters, M. Tourism organizations’ responses to the COVID-19 pandemic: An investigation of the lockdown period. *Curr. Issues Tour.* **2021**, *25*, 247–260. [CrossRef]
34. Golja, T. The behavior and response of regional Destination Management Organizations in the two recovery phases of tourism destination amid Covid-19 Pandemic. The case of Croatia. *Tur. Estud. Prät.* **2021**, *10*, 1–18.
35. Nonaka, I. The knowledge-creating company. *Harv. Bus. Rev.* **2007**, *85*, 162.
36. Gallupe, B. Knowledge management systems: Surveying the landscape. *Int. J. Manag. Rev.* **2001**, *3*, 61–77. [CrossRef]
37. Yang, Y.; Zhang, C.X.; Rickly, J.M. A review of early COVID-19 research in tourism: Launching the Annals of Tourism Research’s Curated Collection on coronavirus and tourism. *Ann. Tour. Res.* **2021**, *91*, 103313. [CrossRef]
38. Fedyk, W.; Sołtysik, M.; Oleśniewicz, P.; Borzyszkowski, J.; Weinland, J. Human resources management as a factor determining the organizational effectiveness of DMOs: A case study of RTOs in Poland. *Int. J. Contemp. Hosp. Manag.* **2021**, *33*, 828–850. [CrossRef]
39. Fedyk, W.; Kachniewska, M. Uwarunkowania skuteczności funkcjonowania regionalnych organizacji turystycznych w Polsce w formule klastra. *Èkon. Probl. Tur.* **2016**, *33*, 135–150.
40. Ağačević, A.; Jusufbegović, E. COVID-19 Pandemic Strategies in Tourism Activity as Guidelines for Ex-Yugoslavia Countries Tourism Recovery. *Int. Bus. Res.* **2021**, *14*, p87. [CrossRef]
41. Holešinská, A. DMO—A dummy-made organ or a really working destination management organization. *Czech J. Tour.* **2013**, *2*, 19–36. [CrossRef]
42. Klimek, K. Destination management organisations and their shift to sustainable tourism development. *Eur. J. Tour. Hosp. Recreat.* **2013**, *4*, 27–47.
43. Rivera, J.; Pastor, R.; Punzon, J.G. The Impact of the Covid-19 on the Perception of DMOs about the Sustainability within Destinations: A European Empirical Approach. *Tour. Plan. Dev.* **2021**, 1–29. [CrossRef]
44. Manczak, I.; Gruszka, I. Averting the effects of the COVID-19 pandemic in tourism—A semantic field analysis. *Pr. Kom. Geogr. Przem. Pol. Tow. Geogr.* **2021**, *35*, 164–176.
45. Foris, D.; Florescu, A.; Foris, T.; Barabas, S. Improving the Management of Tourist Destinations: A New Approach to Strategic Management at the DMO Level by Integrating Lean Techniques. *Sustainability* **2020**, *12*, 10201. [CrossRef]
46. Bulchand-Gidumal, J. Post-COVID-19 recovery of island tourism using a smart tourism destination framework. *J. Destin. Mark. Manag.* **2022**, *23*, 100689. [CrossRef]

47. Bessant, J.; Rush, H.; Trifilova, A. Crisis-driven innovation: The case of humanitarian innovation. *Int. J. Innov. Manag.* **2015**, *19*, 1540014. [CrossRef]
48. Wang, Y.; Fesenmaier, D.R. Collaborative destination marketing: A case study of Elkhart county, Indiana. *Tour. Manag.* **2007**, *28*, 863–875. [CrossRef]
49. Cambra-Fierro, J.; Fuentes-Blasco, M.; Gao, L.X.; Melero-Polo, I.; Trifu, A. The influence of communication in destination imagery during COVID-19. *J. Retail. Consum. Serv.* **2022**, *64*, 102817. [CrossRef]
50. Abou-Shouk, M.A. Destination management organizations and destination marketing: Adopting the business model of e-portals in engaging travel agents. *J. Travel Tour. Mark.* **2017**, *35*, 178–188. [CrossRef]
51. Vargas, A. Covid-19 crisis: A new model of tourism governance for a new time. *Worldw. Hosp. Tour. Themes* **2020**, *12*, 691–699. [CrossRef]
52. Cehan, A.; Eva, M.; Iațu, C. A multilayer network approach to tourism collaboration. *J. Hosp. Tour. Manag.* **2021**, *46*, 316–326. [CrossRef]
53. Tiwari, P.; Chowdhary, N. Czy pandemia COVID-19 czasowo zatrzymała zjawisko overtourism? *Turyzm/Tourism* **2021**, *31*, 91–96. [CrossRef]
54. Seraphin, H.; Ivanov, S. Overtourism: A revenue management perspective. *J. Revenue Pricing Manag.* **2020**, *19*, 146–150. [CrossRef]
55. Gupta, V.; Cahyanto, I.; Sajjani, M.; Shah, C. Changing dynamics and travel evading: A case of Indian tourists amidst the COVID 19 pandemic. *J. Tour. Futur.* **2021**. *ahead-of-print*. [CrossRef]
56. Collins-Kreiner, N.; Ram, Y. National tourism strategies during the Covid-19 pandemic. *Ann. Tour. Res.* **2020**, *89*, 103076. [CrossRef]
57. Paquin, A.G.; Schwitzguébel, A.C. Analysis of Barcelona’s tourist landscape as projected in tourism promotional videos. *Int. J. Tour. Cities* **2021**, *7*, 257–277. [CrossRef]
58. Brouder, P. Reset redux: Possible evolutionary pathways towards the transformation of tourism in a COVID-19 world. *Tour. Geogr.* **2020**, *22*, 484–490. [CrossRef]
59. Hall, C.M.; Scott, D.; Gössling, S. Pandemics, transformations and tourism: Be careful what you wish for. *Tour. Geogr.* **2020**, *22*, 577–598. [CrossRef]
60. Lim, W.M. Conditional recipes for predicting impacts and prescribing solutions for externalities: The case of COVID-19 and tourism. *Tour. Recreat. Res.* **2021**, *46*, 314–318. [CrossRef]
61. Larsen-Zarechnova, M.; Grauslund, D.; Madsen, J.H. Danish Destination Management Organisations’ response to Covid-19: An overview. In *Transformations in Uncertain Times: Future Perfect in Tourism, Hospitality and Events, Proceedings of the 31st Annual Conference, CAUTHE 2021, Fremantle, Australia, 9–12 February 2021*; Jose, P., Sigala, M., Whitelaw, P., Ye, I., Eds.; CAUTHE, 2021; pp. 314–318. Available online: <https://www.ucviden.dk/en/publications/danish-destination-management-organisations-response-to-covid-19> (accessed on 15 May 2021).
62. Frisby, E. Communicating in a crisis: The British Tourist Authority’s responses to the foot-and-mouth outbreak and 11th September, 2001. *J. Vacat. Mark.* **2003**, *9*, 89–100. [CrossRef]
63. Williams, C.; Ferguson, M. Recovering from crisis. Strategic alternatives for leisure and tourism providers based within a rural economy. *Int. J. Public Sect. Manag.* **2005**, *18*, 350–366. [CrossRef]
64. Dias, Á.; Patuleia, M.; Silva, R.; Estêvão, J.; González-Rodríguez, M.R. Post-pandemic recovery strategies: Revitalizing lifestyle entrepreneurship. *J. Policy Res. Tour. Leis. Events* **2021**, *14*, 97–114. [CrossRef]
65. Główny Urząd Statystyczny. Bank Danych Lokalnych. 2021. Available online: <https://bd.stat.gov.pl/BDL/start> (accessed on 10 May 2022).
66. Ferguson, C.J. An effect size primer: A guide for clinicians and researchers. *Prof. Psychol. Res. Pract.* **2009**, *40*, 532–538. [CrossRef]
67. Filep, S.; King, B.; McKercher, B. Reflecting on tourism and COVID-19 research. *Tour. Recreat. Res.* **2022**, 1–5. [CrossRef]
68. Zhang, Y.; Blasco, D. Destination management amid COVID-19: A case study in La Cerdanya, Spain. *Anatolia* **2021**, *33*, 116–127. [CrossRef]
69. Maisel, L. Post-COVID-19 Destination Marketing Organizations: Unmasking the Next Normal, University of Southern California ProQuest Dissertations Publishing. 2022. Available online: <https://www.proquest.com/openview/898611ee2926bb7b9017bc0b47e341ed/1?pq-origsite=gscholar&cbl=18750&diss=y> (accessed on 10 May 2022).
70. Au-Yeung, M.A.M.; Tung, V.W.S.; Tse, S.W.T. Agile destination management and marketing. *Tour. Recreat. Res.* **2022**, 1–11. [CrossRef]
71. Pillmayer, M.; Scherle, N.; Volchek, K. Destination Management in Times of Crisis—Potentials of Open Innovation Approach in the Context of COVID-19? In *Information and Communication Technologies in Tourism*; Springer: Cham, Switzerland, 2021. [CrossRef]
72. De Filippo, M.; Bencivenga, A.; Colangelo, D.; Pepe, A. The Digital Communication Strategies of Regional DMOs at the Time of COVID-19. *Fuori Luogo. Riv. Sociol. Territ. Tur. Tecnol.* **2020**, *7*, 81–87. [CrossRef]
73. Magnini, V.P.; Crotts, J.C.; Calvert, E. The increased importance of competitor benchmarking as a strategic management tool during COVID-19 recovery. *Int. Hosp. Rev.* **2020**, *35*, 280–292. [CrossRef]
74. Wawoczny, M. Bon turystyczny jako forma interwencjonizmu państwowego w pobudzaniu turystyki krajowej w czasie pandemii COVID-19. In *Wiedza-Gospodarka-Społeczeństwo. Współczesne Wymiary Ryzyka w Przedsiębiorstwach i Jednostkach Samorządu Terytorialnego*; Gródek-Szostak, Z., Niemczyk, A., Eds.; Polskie Towarzystwo Inżynierii Rolniczej: Kraków, Poland, 2021; pp. 97–105.



75. Blake, A.; Sinclair, M. Tourism crisis management. *Ann. Tour. Res.* **2003**, *30*, 813–832. [CrossRef]
76. Higgins-Desbiolles, F. Socialising tourism for social and ecological justice after COVID-19. *Tour. Geogr.* **2020**, *22*, 610–623. [CrossRef]
77. Ioannides, D.; Gyimóthy, S. The COVID-19 crisis as an opportunity for escaping the unsustainable global tourism path. *Tour. Geogr.* **2020**, *22*, 624–632. [CrossRef]
78. Janssen, M.; van der Voort, H. Agile and adaptive governance in crisis response: Lessons from the COVID-19 pandemic. *Int. J. Inf. Manag.* **2020**, *55*, 102180. [CrossRef] [PubMed]
79. Wong, J.W.C.; Lai, I.K.W. The mechanism influencing the residents' support of the government policy for accelerating tourism recovery under COVID-19. *J. Hosp. Tour. Manag.* **2022**, *52*, 219–227. [CrossRef]
80. Melián-Alzola, L.; Fernández-Monroy, M.; Hidalgo-Peñate, M. Hotels in contexts of uncertainty: Measuring organisational resilience. *Tour. Manag. Perspect.* **2020**, *36*, 100747. [CrossRef] [PubMed]
81. Mizrachi, I.; Gretzel, U. Collaborating against COVID-19: Bridging travel and travel tech. *Inf. Technol. Tour.* **2020**, *22*, 489–496. [CrossRef]
82. Chatzigeorgiou, C.; Christou, E. Destination branding and visitor brand loyalty: Evidence from mature tourism destinations in Greece. *Tourismos* **2016**, *11*, 102–120.
83. Matthew, T.; McNeice, J. *Destination Design: A Design Thinking Approach to Tourism Development through the Evolution of Destination Management Organizations*; MRP OCAD University Open Research Repository; OCAD University: Toronto, ON, Canada, 2022.
84. Gruszka, I.; Manczak, I. Innovation in tourism in the COVID-19 pandemic—The perspective of experts. *Horyz. Polityki* **2022**, *13*, 215–230. [CrossRef]

## Article

# Beyond Airbnb. Determinants of Customer Satisfaction in P2P Accommodation in Time of COVID-19

Adam Pawlicz <sup>1,\*</sup> , Ema Petaković <sup>2</sup>  and Ana-Marija Vrtodušić Hrgović <sup>2</sup><sup>1</sup> Institute of Management, University of Szczecin, Cukrowa 8, 71-004 Szczecin, Poland<sup>2</sup> Faculty of Tourism and Hospitality Management, University of Rijeka, Primorska 46, p.p. 97, 51410 Opatija, Croatia

\* Correspondence: adam.pawlicz@usz.edu.pl

**Abstract:** As the P2P (peer-to-peer) accommodation market is expanding, there is a growing interest in the factors affecting customer satisfaction. The previous literature largely concentrates on Airbnb users and tends to use online questionnaires as research data. To address this gap, we analyze the key attributes affecting customer satisfaction in the P2P accommodation market in 2020, the first year of the pandemic, based on onsite research. This will allow the authors to examine the key determinants of customer satisfaction across many platforms. Based on previous research, a conceptual model was developed, and two dimensions of service quality were created: host service quality and facility service quality. An offline primary survey was conducted, and the model was tested using exploratory factor analysis, correlation analysis, and regression analysis. The empirical results show a strong relationship between host service quality and facility service quality and customer satisfaction. This study provides clear theoretical insights to advance our knowledge about the determinants of customer satisfaction. Our results are in line with previous research, despite the survey being conducted during the first year of the pandemic and with the use of offline questionnaires. Furthermore, this study offers practical implications for both peer-to-peer and institutional market actors.

**Keywords:** customer satisfaction; P2P accommodation market; exploratory factor analysis; service quality; COVID-19



**Citation:** Pawlicz, A.; Petaković, E.; Vrtodušić Hrgović, A.-M. Beyond Airbnb. Determinants of Customer Satisfaction in P2P Accommodation in Time of COVID-19. *Sustainability* **2022**, *14*, 10734. <https://doi.org/10.3390/su141710734>

Academic Editors: Zygmunt Kruczek and Bartłomiej Walas

Received: 14 July 2022

Accepted: 22 August 2022

Published: 29 August 2022

**Publisher's Note:** MDPI stays neutral with regard to jurisdictional claims in published maps and institutional affiliations.



**Copyright:** © 2022 by the authors. Licensee MDPI, Basel, Switzerland. This article is an open access article distributed under the terms and conditions of the Creative Commons Attribution (CC BY) license (<https://creativecommons.org/licenses/by/4.0/>).

## 1. Introduction

The sharing economy refers to the P2P (peer-to-peer) online marketplace that allows individuals to optimize the use of their idle resources [1]. Its emergence was associated with the foundation of Airbnb, whose business model became iconic and irrevocably transformed the tourism market worldwide. The innovation of a new technology-driven distribution platform allowed Airbnb to grow to the point of affecting existing accommodation providers in the second decade of the XXI century [1,2]. Soon, its model was adopted by other tourism intermediaries, especially in urban areas. The unprecedented surge of the P2P accommodation market in the second decade of the 21st century has only been temporarily interrupted by the COVID-19 pandemic. In fact, the supply in this market is much more flexible than the hotel supply [3] and can adjust faster to pandemic shock [4]. Airbnb, the leading and iconic intermediary in the P2P accommodation market, has revolutionized the hospitality market worldwide. Although its impact can be seen in all destinations, the most profound market changes are observed in urban areas [5]. Following these changes, scientific research on P2P accommodation is booming, with Airbnb being an important focus of tourism academics, while other intermediaries and P2P markets outside urban areas are neglected [6,7]. The development of the P2P accommodation market is closely related to the sustainable development of any destination. In rural and protected areas, it has traditionally been considered a sustainable form of consumption that is associated with less production of emissions and chemicals, less construction and

landscape destruction, and better quality of life for locals. In more recent literature, this view has been questioned as the rapid development of Airbnb in city destinations often leads to overtourism, unfair competition, increase in the overall cost of living, congestion, increase in the price of real estate, etc. [8]. Inevitably, the growing number of suppliers in the P2P accommodation market has led to more intense competition in terms of both the product and its delivery, which soon gained the attention of tourism research. Achieving high customer satisfaction leads to more loyal customers [9] and improves traditional and electronic word-of-mouth [10,11]. Empirical evidence exists that two main dimensions of service quality determine customer satisfaction: host service quality and facility service quality [12,13]. The former relates to product delivery while the latter deals with the tangible elements of P2P accommodations and their location. Existing studies show that both dimensions positively impact overall customer satisfaction [14,15]. All the studies, however, are based on the exclusive research of Airbnb users and were conducted online. This may affect the findings, as tourism memories may differ during and after product consumption [16].

Accordingly, the aim of this article is to investigate the interrelationship between service quality dimensions and customer satisfaction in P2P accommodation, based on the onsite research with tourists who made a purchase both with Airbnb and other distribution channels. In 2020, we conducted our research in Croatia, a popular leisure destination, using traditional questionnaires. Following the previous research, we used exploratory factor analysis, correlation analysis, and regression analysis [17,18].

Next, this paper presents the relevant literature on service quality and customer satisfaction in the P2P accommodation market. The conceptual model and hypothesis development are described. The research design is then presented, and the results are discussed. The discussion, practical and theoretical implications, and future research avenues constitute the last part of this paper.

## 2. Theoretical Background

### 2.1. P2P Accommodation Market

A peer-to-peer market is characterized by a great heterogeneity of both production and consumption. Such markets have been fundamentally transformed by the introduction of internet platforms that operate as a de facto intermediary. eBay and other platforms have managed to significantly lower both transaction costs and information asymmetry, thus not only increasing the efficiency of existing markets but also helping to create many new markets [19].

In the accommodation market, this is reflected by the supply represented by individuals offering their houses or rooms to tourists. However, the peer-to-peer (P2P) accommodation sector existed long before sharing economy platforms emerged, as the renting of idle rooms to tourists was common in numerous tourism resorts. P2P supply and demand were brought together not only through traditional travel agencies and catalogs but also at transportation hubs such as railway or bus stations where local providers would look for potential prospects. Moreover, there were many repeat visitors, and traditional word-of-mouth was important in acquiring new customers. As in markets for tangible goods, new internet-based intermediaries (e.g., Expedia) started to operate in hospitality in the last decade of the twentieth century [20]. At first, their primary focus was the hotel market. Only about ten years later was the first hospitality P2P intermediary, called a sharing economy platform, launched. In fact, in current academic discourse, the P2P accommodation sector is often associated solely with an Airbnb-mediated market, e.g., [21], and to a much lesser extent with other, new sharing economy platforms. Indeed, Airbnb, a new intermediary, managed to revolutionize the hospitality market in the second decade of the 21st century. The platform itself claims to be used worldwide by 4 million hosts that managed 5.6 million listings in 2020 [22]. Its growth has completely changed the hospitality market in many urban destinations by expanding the supply base, increasing supply elasticity, and lowering prices. Although Airbnb is credited with having a very

wide coverage of P2P supply in urban areas, in rural and resort locations, other distribution channels are still very important.

The growing competition among P2P accommodation providers has been paralleled by the surging academic interest in service quality and customer satisfaction in this segment of the hospitality market. Early research in this area drew inevitably on the existing knowledge from the traditional hospitality field. Therefore, prior to examining previous studies, it is instrumental to stress the differences between traditional and P2P accommodation services. These differences can be examined in the field of the tangible elements of products and social interactions. Providers in the P2P market are not limited by most industry-specific regulations that apply to traditional hospitality providers [23]. Hence, service characteristics such as room size and amenities are much less predictable in the P2P market than in traditional hospitality. Still, sharing economy platforms have managed to successfully address this area of information asymmetry by requiring detailed descriptions of the offered apartments, along with photos. Another, and from the perspective of service quality, much more important difference between traditional and P2P hospitality lies in the social interaction between hosts and guests or, as [24,25] put it, in the area of technical quality. Social interaction is a vital part of both service quality and customer satisfaction in hospitality. Technical quality refers to three major dimensions of hospitality service: 1. sociability (behavior of the people within the service setting), 2. valence (post-consumption assessments), and 3. waiting time [26]. In traditional hospitality, social interaction refers to the relationship between guests and personnel, while in P2P, the personal characteristics of the host often play an important part in social interaction. In fact, some sharing economy platforms ask tourists to evaluate both the premises they stayed in and the host's attitude. In sharing economy platforms where accommodation is provided without monetary payment (e.g., CouchSurfing), social interaction is even the *raison d'être* for both being a host and a guest [27]. Indeed, a host's personal photo is one of the key elements in establishing trust between transaction parties [28]. Another major difference between the P2P and traditional hospitality market is the distinction between supply and demand. Whereas in the traditional market, supply is represented by hotel entrepreneurs, and demand consists of tourists and intermediaries, in the P2P market, there are, as the name suggests, peers from both sides of market exchange. As a result, some peers using one Airbnb account, for example, can have experience as both a guest and a host. This led Moon et al. [29] to examine both host satisfaction and guest satisfaction with Airbnb, which is rare in traditional hospitality.

## 2.2. Systematic Literature Review

In order to assess the current research on service quality in relation to customer satisfaction in the P2P accommodation market, a systematic literature review was adopted. We searched for academic contributions in the Web of Science database, which is commonly used in studies based on systematic literature reviews. As a search string, we looked for three blocks. The first and second blocks referred to service quality and satisfaction, respectively, while the third looked at the P2P accommodation market (Table 1). Moreover, we limited our search to contributions written in English.

**Table 1.** Systematic literature review search strings.

Block	Search Term
Service Quality Satisfaction	Service Quality Satisfaction
P2P accommodation	"short term rental" OR "accommodation AND sharing" or "P2P accommodation" OR "peer-to-peer accommodation" OR "Peer-to-peer accommodations" OR Airbnb OR tujia OR Xiaozhu OR homeaway

The original search, conducted on 1 September 2021, resulted in 32 academic contributions. Six contributions were eliminated in abstract screening, and another six contributions in the full text screening stage. We removed those papers as they did not deal with attempts to measure or provide theoretical insights about either service quality or consumer satisfaction. Additionally, one paper was removed as we were not able to find its full text.

The final database resulted in 19 research papers that were written on average by 3.11 authors, which is an average figure in economics and management sciences. The geographical distribution of first-author affiliation is also similar to previous systematic literature studies, where the U.S.A. (five papers) and the U.K. (three papers) are at the top. Three academics authored two papers each, while the remaining academics authored only one each. Not surprisingly, hospitality journals were chosen most often to publish this research, with the *International Journal of Hospitality Management* (four) and *International Journal of Contemporary Hospitality Management* (three) being at the top of the list. Finally, similar to other reviews in the field of the sharing economy, the majority of results were relatively recent publications, with only one contribution published in 2015, three in 2017, three in 2018, three in 2019, six in 2020, and three in 2021. Not all of the contributions focused on the relationship between service quality and customer satisfaction; some addressed only one of the two concepts.

### 2.3. Service Quality and Customer Satisfaction in the P2P Accommodation Market

Do key service quality dimensions have a direct effect on customer satisfaction and repurchase intention? Among the very few previous studies examining the influence of specific service quality dimensions on satisfaction and repurchase intention, the empirical results show conflicting findings.

Measuring service quality is usually based on the general hospitality approach or, to a lesser extent, on studies from other sharing economy areas. The studies in our review used two main methods to evaluate service quality: an online survey (seven papers) and an analysis of reviews (four papers). The analysis of reviews, in all four cases, was based on data from the website of the nonprofit organization Inside Airbnb, which provides scraped data from the Airbnb website for numerous destinations. These enormous datasets (ranging from 215 k to 3 m reviews) were analyzed using specialized software, which had two approaches.

In the first approach, the goal was to identify major keywords occurring in reviews and then cluster them into topics [30,31]. The clusters that were identified consisted of: overall evaluation of the stay, the location of the unit, the physical accommodation unit and the building itself, or the hosts' management of the listed accommodation in [31], or pleasure and joy, neighborhood, hosting and value, in the work of [30]. In comparison with traditional hospitality, there is a greater emphasis on safety and security, the different ways that guests interact with hosts, and listings accuracy [31]. The second approach used sentiment analysis which was based on identifying positive and negative expressions in reviews, assigning them a value of either 1 or 0, and finally, calculating a sentiment score [32,33]. Similar to previous studies, researchers found that hosts with fewer rooms can be more focused on guests and, consequently, receive higher rating scores, which is a signal of service quality [33]. Güçlü et al. [32] found that the area of „tangible and host characteristics“ related to the host encounter experience and accommodation facilities is very important for tourists.

The second group of papers dealt with contributions where various service quality aspects were operationalized in structural equation models using customer-based quantitative opinions. Here, service quality was conceptualized mostly as multiple constructs. The only two exceptions were the early work of Möhlmann [15] and Lalicic & Weismayer [9], where the service quality was operationalized as a single construct. The number of constructs relating to service quality in the remaining contributions ranges from two in the work of Huarng & Yu [14], where only “network platform service quality” and “lodging service quality” were identified, to as many as six in [13]. Service quality construct(s) were

mostly used as predictors in structural equation modeling (SEM). In a contribution by C.V. Priporas, Stylos, Rahimi, et al. [34], service quality functioned both as a construct, explained by other service quality dimensions constructs, and as a predictor of consumer satisfaction and loyalty.

Customer satisfaction (CS) was the subject of 13 papers. Similar to the papers addressing service quality (SQ) discussed above, all contributions can be divided into two areas: papers where CS was conceptualized using text processing tools and papers on quantitative research where CS was measured based on an online survey. Additionally, in one study, CS was researched using interviews [35]. In two studies where text processing tools were employed, CS was quantified using sentiment analysis in which all the collected reviews were scanned against a list of positive and negative words. In a more recent study, Ding et al. [36] separately analyzed positive and negative reviews.

Similar to studies dealing with service quality, in most of the contributions, satisfaction is researched from the guest perspective, hence the consumer satisfaction (CS), which is in line with the general hospitality literature. Still, Thaichon et al. [35] attempted to determine the factors that influence both host and guest satisfaction, which is in line with the original sharing economy value cocreation notion, in which renting a room results not only in economic exchange but also in mutually enriching social interaction.

In the remaining 10 papers, CS was measured using customer opinions. SEM was applied in nine papers. CS was conceptualized either as a construct, with the number of measurements varying from 2 [37] to 7 [29] in five papers or as a single measurement in the remaining studies. Usually, satisfaction was explained by constructs that relate to tangible service quality and social interactions between guest and host, while CS was used mostly as a predictor of repurchase intention.

An overview of the use of service quality and consumer satisfaction in SEM research conducted in the field of sharing economy accommodation is presented in Supplementary Table S1 while key relationship constructs are depicted in Table 2.

From a methodological perspective, the analyzed papers investigated P2P accommodation settings from two main perspectives. In the first group (five papers), the research sample consisted of respondents who had an Airbnb experience. In general, consumer behavior was explored, i.e., results are not confined to any particular destination. Respondents were from Taiwan [14], the U.S.A., Canada [12], and Germany [15], and in two cases, the location was not specified. In three articles, the respondents were recruited using Amazon's Mechanical Turk (MTurk), an online survey application, which is used by businesses to outsource jobs to those who can perform these tasks virtually [12,38]. In three other sources, students constituted the respondent group [9,14,15]. In two other articles, tourists visiting Phuket, Thailand, were chosen [13,34]. While most of these papers deal exclusively with Airbnb accommodation settings, the paper by [14] compares Airbnb and hotel service quality settings. In addition to Airbnb, Möhlmann's paper [15] also explores the determinants of choosing another sharing economy platform—Car2go—a car-sharing service. The number of respondents ranged from 202 to 614.

**Table 2.** Key construct relationships in P2P hospitality literature (supporting literature for cocreation factors).

Implications	Sources
SQ → loyalty	[9,13]
Tangibles → SQ	[13,34]
Understanding & caring (social interaction) → SQ	[13,29,34]
Information Quality (IQ) → Satisfaction	[37]
Satisfaction → Purchase Intention (PI)	[14,37,39,40]
SQ → Satisfaction	[14,15]
Amenities → CS	[38]

Based on the systematic literature review, the following research gaps have been identified.

1. The research in all studies included in our review was conducted with the use of online tools. Conducting online research is certainly cost- and time-effective and enables a larger sample that may consist of respondents from diverse geographical areas. Moreover, web surveys do not suffer from interviewer bias and can be completed at the respondents' convenience [41]. Additionally, the use of platforms such as MTurk or Qualtrics enables researchers to include a small monetary incentive, facilitates the inclusion of verification questions, and prevents duplicate participation. The use of online tools also has its drawbacks, such as the exclusion of individuals who have no access to or have difficulties with internet use which may provide different results [42]. As there is no research that compares the use of online and offline tools either in hospitality markets or in P2P markets, one can only speculate about the potential bias with the use of either method.
2. All 19 contributions are based on Airbnb data, and in 13 contributions the name of Airbnb is even present in the article's title. In three studies, Airbnb is compared with traditional hospitality [40,43,44], while in one paper, Airbnb data are compared with another sharing economy platform [15]. Drawing conclusions from Airbnb data for the whole P2P accommodation market is warranted in the case of urban destinations where this market has surged after the introduction of this sharing economy platform. Tourists who use Airbnb and other sharing economy platforms are usually innovative, highly educated, and have a higher income than average [45]. Conversely, in leisure destinations, which have a higher share of repeat visitors and longer average lengths of stay, other more traditional distribution channels are used more often [46]. Therefore, research results regarding Airbnb users cannot always be generalized to the whole P2P market.

#### 2.4. Conceptual Model and Hypothesis Development

As shown in the systematic literature review SLR analysis, the link between service quality and consumer satisfaction is easy to observe, as the latter is defined as the difference between product performance and an evaluative standard [47]. In the realm of the P2P accommodation market, the SLR shows that service quality is divided into various constructs that are related to the social interactions between host and guest (empathy, experience, social value, cocreation), the hospitality product (amenities quality, information quality, location, cleanliness, price/value, financial info security, internet capability, location, safety), and other factors, such as platform service quality.

In order to understand and compare the findings of previous studies, it is essential to analyze the measurement items, as, in many cases, constructs of similar names consist of very different data. For example, the construct "service quality" can be related to host behavior [9], the quality of intermediary services provided by a sharing economy platform [15], or both the tangible and intangible aspects of P2P service [30].

##### 2.4.1. Host Service Quality

According to Airbnb and many other intermediaries, an authentic experience is one of the key advantages of P2P accommodation. A taste of local culture, interaction with local life, and a personal relationship with hosts are often said to be key factors in determining customer satisfaction [40].

Hosting behavior was added by C. V. Priporas, Stylos, Rahimi, et al. [34] to the construct "understanding and caring", which comprises flexibility, friendliness, individual attention, and assistance. In their I-P analysis, they also included hosting area, in addition to check-in flexibility, response speed, helpfulness, extra help, and friendliness. The same approach was adopted by Ranjbari et al. [30]. In this vein, Ju et al. [12] found that host service quality had a high impact on customer satisfaction based on both tourist review analysis and an econometric model. In the construct "host service quality", they included

hosts' friendliness, helpfulness, ability to make guests feel at home, and ability to address the guests' interests. Two constructs in the field of host service quality were adopted by Lalicic & Weismayer [9], one being related to social interactions between host and guest ("hospitality hosting behavior") and the other ("service quality") to hosts' responsiveness, assurance, empathy, and reliability. Tajeddini et al. [44] adopted a very similar approach.

Another group of contributions emphasized the importance of social interactions between host and guest. For example, Lee & Kim [48] stated that product involvement plays a moderating role between hedonic value and CS. In this vein, Sthapit et al. [39] identified a "co-creation" construct that involved the measurement of interactions between hosts and guests, while Thaichon et al. [35] and Moon et al. [29] proved that human interaction was beneficial for both guests and hosts. A slightly different approach was adopted by Kreeger et al. [38], who were able to prove that "empathy" shown by personnel has a positive effect on business travelers' satisfaction.

Ding et al. [36] were the first to observe that different types of Airbnb properties are associated with different satisfaction components. Importantly, they showed that "home-like experience" and "help from hosts" are valued mostly by visitors of shared rooms and private rooms, whereas guests renting an entire property or hotel rooms tend to value "room size" and "amenities" much more. This leads us to the following hypothesis:

**Hypothesis 1 (H1).** *Host service quality has a positive impact on overall customer satisfaction.*

#### 2.4.2. Facility Service Quality

Facility service quality refers mostly to the tangible elements of an accommodation product. The connection between a guest's opinion of an apartment's amenities, space and appearance, and consumer satisfaction has a long history in hospitality. The very foundation of major hotel classification schemes is based on the availability of services, size of a room, and room amenities, as these are factors that can be objectively assessed by a committee that grants the hotel the right to use stars in their marketing. The importance of these elements to customer satisfaction has already been widely analyzed in general hospitality research [49]. In the P2P hospitality market, these elements are depicted and photographed on intermediaries' platforms and widely covered providers' websites in order to inform clients and create corresponding expectations.

In our SLR, the tangible elements of a hospitality product are featured in almost all research contributions that are related to a particular hospitality experience. Similar to the host service quality discussion above, the names of the construct in SEM research and the collections of items vary across the examined research papers. The constructs were named "Lodging service quality" [14] and "Tangibles" in [13,34]. Ranjbari et al. [30] used two constructs: "Accommodation and facilities" and "Neighborhood", while Kreeger et al. [38] used three constructs, "Amenities", "Location", and "Cleanliness". In our research, we followed the approach of Ju et al. [12] and adopted "Facility service quality" in order to avoid creating more academic confusion in P2P research. Factors often included in those constructs were the following: "Location" [12,38], "Furnishings and equipment" [30,38], "Unit security" [30], "Cleanliness" [12,30,38] "Decoration" and "View" [30]. A different approach was observed in [13,34], who mentioned tangibles where they asked about food and beverages, adequacy of capacity, equipment, materials, and atmosphere. The contributions that were based on sentiment analysis, i.e., the results of which were based on the review analysis, identified other factors as well that could be added to this list: "sleep disturbance" [31,36] and "thermal management" [31]. All these contributions proved that facility service quality impacts consumer satisfaction. Hence, the second hypothesis:

**Hypothesis 2 (H2).** *Facility service quality has a positive impact on overall customer satisfaction.*



This study argues that service quality measured by two independent variables: host service quality and facility service quality has a positive impact on tourist satisfaction (Figure 1).

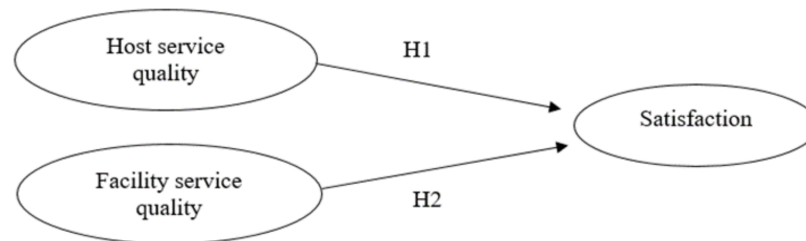

**Figure 1.** A framework of the determinants of consumer satisfaction in P2P accommodation.

### 3. Research Design

#### 3.1. Data

The research was conducted in Croatia, more specifically in 10 Croatian counties, covering both coastal and mainland regions of the country as part of the project Focus on Quality in Household Accommodation—Guest Perspective. In Croatia, the majority of overnights and arrivals are realized in the coastal regions, but the mainland regions were also included in this research in order to take into account the diversity of the sample. When observing the accommodation capacity in Croatia, the importance of P2P accommodation becomes clear. This type of accommodation accounted for 60.9% of beds offered to tourists in all accommodations in Croatia in 2020. A comparison was made with Italy, Spain, Greece, France, and Portugal, the competitive tourism countries in the Mediterranean. The percentage of beds in P2P accommodation is the highest in Italy (34.9%), Greece (27.9%), and Spain (24.6%), followed by France (19.0%) and Portugal (15.7%) [50]. According to Eurostat data for 2019, the most overnights in P2P accommodation were recorded in Croatia (50%), France (25.8%), Greece (24.9%), Italy (22.3%), Spain (17.5%) and Portugal (13.9%) [50].

#### 3.2. Variables and Measures

The research focused on the development of a measurement tool, a structural questionnaire that can be used to measure service quality in P2P accommodations. The target population of this study were guests staying in P2P accommodation, which, according to Eurostat category 55.2, includes four categories: rooms, apartments, studio-type suites, and holiday homes [50]. This classification was chosen to make the data comparable with other EU countries. In this study, all P2P accommodation platforms such as Airbnb, Booking.com, and Expedia, direct contact with the host, or booking through travel agencies were considered.

Given the specificity of the 2020 tourist season and the unfavorable epidemiological situation, the sample in this study is somewhat smaller than in previous studies. Hair et al. [51] indicate that the sample should include 100 or more respondents and note that the recommended sample size should be at least five times the number of variables analyzed. Another suggestion for sample size is at least 10 cases for each item, and the ratio of subjects to variables [STV] should not be lower than 5 [52]. The study was conducted using an offline questionnaire provided in four languages (Croatian, English, German, and Italian). The sample included tourists from 17 countries. Multiple choice questions were used to rate overall satisfaction and service quality on a Likert scale from 1 to 5. A protest was conducted on a sample of 10 respondents, including hosts and people who have used P2P accommodations in the past. The questionnaire was corrected based on the suggestions.

A tourist survey was conducted during the summer months of 2020 (from July to September). The questionnaires were distributed to interviewers who were in contact with private owners and guests who chose this segment of the offering. The research was conducted in collaboration with seven interviewers, previously educated in the responsible conduct of research and in relation to the objectives and purpose of the study.

Renters/hosts from all over the country, providing different types of facilities, were included in the research. The analysis was conducted on a sample of 168 tourists who stayed in P2P accommodations.

## 4. Results

### 4.1. Survey Participants

Descriptive statistics used to examine the demographic and travel characteristics of the sample are shown in Supplementary Table S2.

Most of the respondents who participated in the study and stayed in P2P accommodation were women (53.7%). The sample indicates that over 50% of the respondents were between the ages of 20 and 39. The majority of respondents were from Croatia and other nearby countries accessible by car (Germany, Italy, Austria, and Slovenia). As the study was conducted during the pandemic tourism season of 2020, the share of domestic overnights in Croatia increased at the expense of foreign tourists due to the unfavorable epidemiological situation and travel threats during this period. A similar situation is observed in the sample of our study.

Examining the travel characteristics of the sample, it is possible to observe that guests mostly stayed in apartments (58.9%) and rooms (19.0%) and booked their vacations largely using platforms such as Booking.com (29.5%), Airbnb (20.1%), and Expedia (1.9%). A third of the guests (32.7%) booked their accommodation through direct contact with the host, a possible reason for this being the current epidemiological situation related to COVID-19 and the interest of guests to obtain comprehensive information about epidemiological conditions at the destination in direct contact with the host. Overall, the 2020 tourism season was specific because of COVID-19. The safety and health of guests are paramount. P2P accommodation, unlike other tourist facilities, offers absolute privacy and a home-like atmosphere, which was a great advantage of this type of accommodation during COVID-19.

### 4.2. Exploratory Factor Analysis

Factor analysis was performed to define the variables in the model by extracting the factors. The analysis resulted in three factors extracted from 18 items. The Kaiser–Meyer–Olkin measure is 0.874, which indicates that the excluded factors contain enough variables. A strong correlation between variables and factors was demonstrated by the significance of Bartlett’s test ( $p < 0.01$ ). A rotated component version was used to provide a reliable content interpretation. Of the three factors that resulted from the factor analysis, two factors were interpreted and later used in the research, and one factor was excluded from further analysis. Since the third factor, which contained six items, could not be interpreted in theory or practice, and had no meaningful relationship within the extracted items or to this or previous research, it was decided to exclude it from further analysis. Factor analysis is a cyclical process in which solutions are continuously refined and compared until the most meaningful solution is reached [53,54]. The following factors were deleted from the matrix within the third factor: “I am well informed about the services”, “I am well informed about the offering in the destination (info map)”, “Internet connection in this property is free, Internet connection in this property is fast”, “The property is clean and tidy”, and “The property has a landscaped natural environment”.

The remaining two factors explained about 55.5% of the variance. Most factor loadings were higher than 0.50, indicating a high correlation between the extracted factors and their items. Tabachnick and Fidell [53] suggest that correlations greater than 0.30 are sufficient to justify the formation of factors. The factors were named according to the characteristics of the variables that compose them, as follows: Factor #1: host service quality, Factor #2: facility service quality (Table 3).

**Table 3.** Factor analysis and reliability analysis results of service quality in P2P accommodation.

Items ( <i>n</i> = 10)	Factors		
	1	2	Communalities
The host responds promptly to the guest's inquiries and is always ready to assist the guest	0.769		0.714
The host has an individual approach to the guests	0.768		0.699
The renter/host has the necessary knowledge to fulfill the requirements of the guest	0.739		0.765
The host is always ready to help the guest	0.584		0.606
The property is well equipped		0.774	0.706
The property has a modern and attractive appearance		0.757	0.690
The location of the property is good		0.564	0.414
The property retained its authenticity		0.554	0.658
The contents and appearance of the property correspond to the information on the sales channels		0.547	0.669
The property is spacious/comfortable		0.481	0.449
Eigenvalue	6.594	1.507	8.101
% of variance	38.790	8.864	55.553
Cronbach's alpha	0.831	0.807	0.897
Number of items	4	6	10

The results of the reliability analysis showed good internal consistency of the factors, as Cronbach's alpha coefficients of the exchanged factors were 0.807 and 0.831, well above the minimum value of 0.60 [49]. The Cronbach's alpha for the scale showed high reliability of 0.897.

To determine the relationship between the dimensions of service quality and overall customer satisfaction, a correlation analysis was performed.

The Spearman coefficient was used to show the relationship between the correlations of the two variables with the one dependent variable (Table 4). The value of this test is in the interval  $-1 \leq r \leq +1$ , where the - sign indicates a negative (inverse) correlation, while the + sign indicates a positive correlation [55]. The higher the value of the Spearman correlation coefficient, the stronger the correlation between the variables (more significant).

**Table 4.** Spearman's correlation coefficients between independent (Host service quality and Facility service quality) and dependent variables (Satisfaction).

Independent Variables	Satisfaction (Dependent Variable)	
Host service quality	Correlation Coefficient	0.602 **
	Significance	0.000
Facility service quality	Correlation Coefficient	0.582 **
	Significance	0.000

\*\* Correlation is significant at the 0.01 level (2-tailed).

Spearman correlation analysis was used to sufficiently confirm the relationship between the two variables. There is a positive correlation between facility service quality and satisfaction ( $r = 0.582$ ,  $p < 0.001$ ) and between host service quality and satisfaction ( $r = 0.602$ ,  $p < 0.001$ ). Both correlation coefficients show a moderate positive relationship.

To test the main research hypothesis, a multiple regression analysis was performed to determine the influence of the independent variables (two dimensions extracted in factor analysis) on the dependent variable (overall customer satisfaction). Overall satisfaction with the service provided was measured with two variables: "How satisfied are you with your stay?" and "Compared to the money you have spent, how satisfied you are with your stay".

The coefficient of determination ( $R^2$ ) represents the proportion of variance explained by the regression model [51]. It can take values between 0 and 1. The higher its value, the better the regression model predicts the dependent variable (Table 5).

**Table 5.** Multiple regression analysis.

Model Fit				
Multiple R	0.676			
R <sup>2</sup>	0.457			
Adjusted R <sup>2</sup>	0.451			
Standard error	0.49008			
F ratio	65.769			
Significance	0.000			
Independent variable	b	Beta	t	Sig.
Constant	1.100		3.644	0.000
Host service quality	0.331	0.330	4.299	0.000
Facility service quality	0.459	0.416	5.430	0.000

Predictors: (Constant) Facility service quality, Host service quality; Dependent Variable: Customer Satisfaction.

The results show a strong relationship ( $R = 0.676$ ) within the model. According to the coefficient of determination ( $R^2 = 0.457$ ) and the adjusted coefficient of determination (adjusted  $R^2 = 0.451$ ), 45.7% of the variance for achieving guest satisfaction in P2P accommodations can be explained by the variables “Host service quality” and “Facility service quality”.

In addition, the F ratio ( $F = 65.769$ ,  $p < 0.001$ ) indicates that the regression model statistically significantly predicts guest satisfaction in P2P accommodations. This means that this combination of independent variables significantly predicts the dependent variable, i.e., “Facility service quality” and “Host service quality” successfully explain “Customer Satisfaction”. The predictive power of the two independent variables of the multiple regression model analyzed is justified since the independent variables contribute statistically significantly to the model. The variable Facility service quality has visibly higher predictive power in explaining the dependent variable “Customer satisfaction” ( $b_2 = 0.416$ ,  $t = 5.430$ ,  $p < 0.001$ ) followed by Host service quality ( $b_1 = 0.330$ ,  $t = 4.299$ ,  $p < 0.001$ ) (Figure 2).

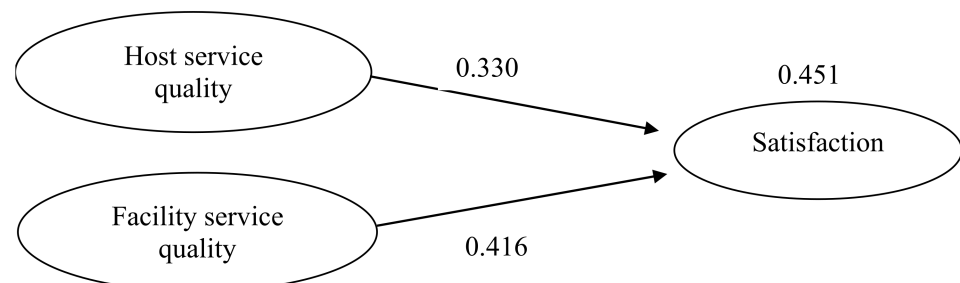
**Figure 2.** Multiple regression analysis results.

Since facility service quality has been shown to have a greater impact on guest satisfaction, hosts should focus on improving this segment of the offering. Although the host’s service quality had a somewhat smaller impact in this study, it has been shown to still have an impact on guest satisfaction, and for this reason, this aspect of service should also be taken into consideration.

As a majority of previous contributions were based on Airbnb data, we decided to conduct a multigroup analysis between respondents that booked the property through the Airbnb application (20.1%) and those that used other P2P accommodation platforms (Booking.com, Expedia, direct contact with the host or travel agents) (79.9%). A multigroup analysis was performed using the Mann–Whitney test, and it was found that there was no statistically significant difference ( $U = 1874$ ,  $p = 0.932$ ) in the satisfaction of guests staying in Airbnb accommodation and guests staying in other types of P2P accommodation. The observed difference in average ranks (Airbnb = 77.55, Other P2P = 76.86) is considered random; that is, its statistical significance was not demonstrated. Furthermore, to compare the differences between two groups in independent variables, the Mann–Whitney test

was used. Based on the test results, it was found that there was no statistically significant difference in the perception of host service quality ( $U = 1755, p = 0.520$ ) and facility service quality ( $U = 1836, p = 0.801$ ).

## 5. Discussion

### 5.1. Theoretical Implications

In view of the rapid growth of P2P tourism that has only been temporarily impeded by COVID-19, this study conducted a systematic literature review to identify the research gaps in the service quality research in this field. Previous research on service quality in the P2P hospitality market was conducted based almost exclusively on Airbnb data and data collected online. Moreover, a vast majority of contributions were based on pre-pandemic data. To address these research gaps, we conducted offline research with 168 questionnaires collected in the first year of the pandemic. As questionnaires were collected onsite, we were able to measure customer perception of service quality not only from Airbnb users but also from those who used other distribution channels in the P2P accommodation market.

This study articulates two major dimensions of service quality (host and facility) that determine consumer satisfaction. Although our research does not determine new service quality attributes, it validates existing dimensions in an offline pandemic environment. We were able to confirm a positive relationship between both host and facility service quality and customer satisfaction, which was also observed in previous studies [13,31,34]. Our findings are also in line with the work of Lalicic and Weismayer [9], where a relationship between satisfaction and loyalty has been established. We demonstrated that the importance of service quality attributes in the P2P accommodation market is in line with previous research based only on Airbnb data alone. Moreover, this study contributes to the existing literature by testing a relationship between service quality and consumer satisfaction in the P2P accommodation market in an offline environment. Therefore, our findings are instrumental in facilitating future P2P quantitative research applications.

### 5.2. Practical Implications

Our findings may assist industry practitioners in prioritizing service attributes for P2P strategic accommodation management, as shown in Table 3. Both facility and host service quality impact the overall customer satisfaction, but each service quality dimension contributes differently to the overall satisfaction, which may later affect future post-consumption behavior and word-of-mouth. The findings are also vital for the entire hospitality industry, as they delineate the differences between the distribution channels. More importantly, there are no differences between factors that impact satisfaction between guests that use Airbnb and those who do not use them to purchase a hospitality service. Our research was based on data from questionnaires handed out to guests after their visit to accommodation establishments, and the results are in line with previous studies based on online research tools. As a result, building a market segmentation based on distribution channels is ineffective, which might be of paramount importance to small providers with a very limited marketing budget. Furthermore, we found that the relationship between service quality and customer satisfaction in the P2P accommodation market did not change during the recent COVID-19 pandemic, as our results are consistent with findings from previous research.

## 6. Conclusions

It was found that host service quality and facility service quality significantly influence the guests' satisfaction with the service offered in P2P accommodations. The host service quality dimension is specific to P2P accommodations because hotels, hostels, camps, and other types of accommodations have trained staff who perform their work in contact with the guest. In P2P accommodation, the host is the person who most commonly performs all of the above tasks. Hosts should be available to the guest before, during, and after the stay; they should have a personal approach, possess the necessary knowledge and skills,

and always be at the guest's disposal. This dimension has been shown to have a significant impact on guest satisfaction. Facility service quality has a stronger influence on guest satisfaction. In P2P accommodations, it is particularly important to consider the quality of the service provided, taking into account national criteria and additionally introducing quality label criteria that can improve the service delivery process.

## 7. Limitations

This study encounters a number of limitations, most notably the sample size. The study was conducted with offline surveys in the wake of a global pandemic caused by the Coronavirus. This type of accommodation was of particular interest to tourists during this period due to its remoteness, privacy, and accessibility. Because of the situation and the advantages of this type of accommodation at the time of the pandemic, it is possible that guests who would not otherwise choose this type of accommodation did so. The location is also one of the limitations of the study, as the survey was conducted in only one country, which may mean that the results cannot be generalized to other countries. We believe that the study should be expanded in theoretical and practical terms by focusing on the process of service delivery and guest satisfaction.

**Supplementary Materials:** The following supporting information can be downloaded at: <https://www.mdpi.com/article/10.3390/su141710734/s1>. Table S1. Operationalization of service quality (SQ) and consumer satisfaction (CS) in sharing economy accommodation quantitative research. Table S2. Demographic and travel characteristics of the sample.

**Author Contributions:** Conceptualization A.-M.V.H. and A.P.; data curation, A.-M.V.H. and E.P.; methodology, A.-M.V.H. and E.P.; supervision, A.P. and A.-M.V.H.; writing—original draft, E.P. and A.P.; writing—review & editing, E.P. and A.P.; funding acquisition, A.-M.V.H. and E.P. All authors have read and agreed to the published version of the manuscript.

**Funding:** This paper was funded under the project line ZIP UNIRI of the University of Rijeka for the project ZIP-UNIRI-116-3-19.

**Institutional Review Board Statement:** Not applicable.

**Informed Consent Statement:** Not applicable.

**Data Availability Statement:** The data used for the analysis could not be shared publicly.

**Conflicts of Interest:** The authors declare no conflict of interest.

## References

1. Camilleri, M.A. The Planning and Development of the Tourism Product. In *Tourism Planning and Destination Marketing*; Emerald Group Publishing Ltd.: Bingley, UK, 2018; pp. 1–23, ISBN 9781787562912.
2. Guttentag, D. Progress on Airbnb: A literature review. *J. Hosp. Tour. Technol.* **2019**, *10*, 814–844. [CrossRef]
3. Gyódi, K. Airbnb and hotels during COVID-19: Different strategies to survive. *Int. J. Cult. Tour. Hosp. Res.* **2021**, *16*, 168–192. [CrossRef]
4. Medeiros, M.; Xie, J.; Severt, D. Exploring relative resilience of Airbnb and hotel industry to risks and external shocks. *Scand. J. Hosp. Tour.* **2022**, *22*, 274–283. [CrossRef]
5. Adamiak, C. Current state and development of Airbnb accommodation offer in 167 countries. *Curr. Issues Tour.* **2019**, 1–19. [CrossRef]
6. Medina-Hernandez, V.C.; Marine-Roig, E.; Ferrer-Rosell, B. Accommodation sharing: A look beyond Airbnb's literature. *Int. J. Cult. Tour. Hosp. Res.* **2020**, *14*, 21–33. [CrossRef]
7. Kuhzady, S.; Seyfi, S.; Béal, L. Peer-to-peer (P2P) accommodation in the sharing economy: A review. *Curr. Issues Tour.* **2020**, 1–16. [CrossRef]
8. Zmysłony, P.; Leszczyński, G.; Waligóra, A.; Alejziak, W. The Sharing Economy and Sustainability of Urban Destinations in the (Over)tourism Context: The Social Capital Theory Perspective. *Sustainability* **2020**, *12*, 2310. [CrossRef]
9. Lalicić, L.; Weismayer, C. A model of tourists' loyalty: The case of Airbnb. *J. Hosp. Tour. Technol.* **2018**, *9*, 80–93. [CrossRef]
10. Huang, D.; Coghlan, A.; Jin, X. Understanding the drivers of Airbnb discontinuance. *Ann. Tour. Res.* **2020**, *80*, 102798. [CrossRef]
11. Liang, L.J.; Choi, H.C.; Joppe, M. Understanding repurchase intention of Airbnb consumers: Perceived authenticity, electronic word-of-mouth, and price sensitivity. *J. Travel Tour. Mark.* **2018**, *35*, 73–89. [CrossRef]



12. Ju, Y.; Back, K.-J.; Choi, Y.; Lee, J.-S. Exploring Airbnb service quality attributes and their asymmetric effects on customer satisfaction. *Int. J. Hosp. Manag.* **2019**, *77*, 342–352. [CrossRef]
13. Priporas, C.-V.; Stylos, N.; Vedanthachari, L.N.; Santiwatana, P. Service quality, satisfaction, and customer loyalty in Airbnb accommodation in Thailand. *Int. J. Tour. Res.* **2017**, *19*, 693–704. [CrossRef]
14. Huarng, K.-H.; Yu, M.-F. Customer satisfaction and repurchase intention theory for the online sharing economy. *Rev. Manag. Sci.* **2019**, *13*, 635–647. [CrossRef]
15. Möhlmann, M. Collaborative consumption: Determinants of satisfaction and the likelihood of using a sharing economy option again. *J. Consum. Behav.* **2015**, *14*, 193–207. [CrossRef]
16. Kim, J.J.; Fesenmaier, D.R. Measuring Emotions in Real Time: Implications for Tourism Experience Design. *J. Travel Res.* **2015**, *54*, 419–429. [CrossRef]
17. Ruan, Y. Perceived host-guest sociability similarity and participants' satisfaction: Perspectives of airbnb guests and hosts. *J. Hosp. Tour. Manag.* **2020**, *45*, 419–428. [CrossRef]
18. Tussyadiah, I.P.; Pesonen, J. Impacts of Peer-to-Peer Accommodation Use on Travel Patterns. *J. Travel Res.* **2016**, *55*, 1022–1040. [CrossRef]
19. Einav, L.; Farronato, C.; Levin, J. Peer-to-Peer Markets. *Annu. Rev. Econ.* **2016**, *8*, 615–635. [CrossRef]
20. Law, R.; Chen, F. Internet in Travel and Tourism-Part II: Expedia. *J. Travel Tour. Mark.* **2000**, *9*, 83–87. [CrossRef]
21. Benítez-Aurioles, B. A proposal to regulate the peer-to-peer market for tourist accommodation. *Int. J. Tour. Res.* **2021**, *23*, 70–78. [CrossRef]
22. Airbnb Revenue and Usage Statistics. Available online: <https://www.businessofapps.com/data/airbnb-statistics/> (accessed on 17 January 2022).
23. Williams, C.C.; Horodnic, I.A. Regulating the sharing economy to prevent the growth of the informal sector in the hospitality industry. *Int. J. Contemp. Hosp. Manag.* **2017**, *29*, 2261–2278. [CrossRef]
24. Ali, F.; Hussain, K.; Konar, R.; Jeon, H.-M. The Effect of Technical and Functional Quality on Guests' Perceived Hotel Service Quality and Satisfaction: A SEM-PLS Analysis. *J. Qual. Assur. Hosp. Tour.* **2017**, *18*, 354–378. [CrossRef]
25. Asma, S.; Dine, M.S.B.; Wafaa, B.; Redouan, A. The Effect of Perception Quality/Price of Service on Satisfaction and Loyalty Algerians Customers Evidence Study Turkish Airlines. *Int. J. Econ. Manag. Sci.* **2018**, *7*, 503. [CrossRef]
26. Wu, H.-C.; Ko, Y.J. Assessment of Service Quality in the Hotel Industry. *J. Qual. Assur. Hosp. Tour.* **2013**, *14*, 218–244. [CrossRef]
27. Molz, J.G. Couchsurfing and network hospitality: 'It's not just about the furniture'. *Hosp. Soc.* **2012**, *1*, 215–225. [CrossRef]
28. Ert, E.; Fleischer, A. What do Airbnb hosts reveal by posting photographs online and how does it affect their perceived trustworthiness? *Psychol. Mark.* **2020**, *37*, 630–640. [CrossRef]
29. Moon, H.; Miao, L.; Hanks, L.; Line, N.D. Peer-to-peer interactions: Perspectives of Airbnb guests and hosts. *Int. J. Hosp. Manag.* **2019**, *77*, 405–414. [CrossRef]
30. Ranjbari, M.; Esfandabadi, Z.S.; Scagnelli, S.D. A big data approach to map the service quality of short-stay accommodation sharing. *Int. J. Contemp. Hosp. Manag.* **2020**, *32*, 2575–2592. [CrossRef]
31. Sutherland, I.; Kiatkawsin, K. Determinants of Guest Experience in Airbnb: A Topic Modeling Approach Using LDA. *Sustainability* **2020**, *12*, 3402. [CrossRef]
32. Guclu, B.; Roche, D.; Marimon, F. City Characteristics That Attract Airbnb Travellers: Evidence from Europe. *Int. J. Qual. Res.* **2020**, *14*, 271–290. [CrossRef]
33. Zhu, L.; Lin, Y.; Cheng, M. Sentiment and guest satisfaction with peer-to-peer accommodation: When are online ratings more trustworthy? *Int. J. Hosp. Manag.* **2020**, *86*, 102369. [CrossRef]
34. Priporas, C.-V.; Stylos, N.; Rahimi, R.; Vedanthachari, L.N. Unraveling the diverse nature of service quality in a sharing economy. *Int. J. Contemp. Hosp. Manag.* **2017**, *29*, 2279–2301. [CrossRef]
35. Thaichon, P.; Surachartkumtonkun, J.; Singhal, A.; Alabastro, A. Host and guest value co-creation and satisfaction in a shared economy: The case of Airbnb. *J. Glob. Sch. Mark. Sci.* **2020**, *30*, 407–422. [CrossRef]
36. Ding, K.; Choo, W.C.; Ng, K.Y.; Ng, S.I.; Song, P. Exploring Sources of Satisfaction and Dissatisfaction in Airbnb Accommodation Using Unsupervised and Supervised Topic Modeling. *Front. Psychol.* **2021**, *12*, 659481. [CrossRef]
37. Chen, C.-C.; Chang, Y.-C. What drives purchase intention on Airbnb? Perspectives of consumer reviews, information quality, and media richness. *Telemat. Inform.* **2018**, *35*, 1512–1523. [CrossRef]
38. Kreeger, J.C.; Smith, S.J.; Parsa, H. Airbnb and Business Travelers: A Prospect Theory Explanation. *Int. J. Hosp. Tour. Adm.* **2021**, *1*–33. [CrossRef]
39. Sthapit, E.; Del Chiappa, G.; Coudounaris, D.; Bjork, P. Determinants of the continuance intention of Airbnb users: Consumption values, co-creation, information overload and satisfaction. *Tour. Rev.* **2019**, *75*, 511–531. [CrossRef]
40. Birinci, H.; Berezina, K.; Cobanoglu, C. Comparing customer perceptions of hotel and peer-to-peer accommodation advantages and disadvantages. *Int. J. Contemp. Hosp. Manag.* **2018**, *30*, 1190–1210. [CrossRef]
41. Schillewaert, N.; Meulemeester, P. Comparing Response Distributions of Offline and Online. *Int. J. Mark. Res.* **2005**, *47*, 163–178. [CrossRef]
42. Riva, G.; Teruzzi, T.; Anolli, L. The Use of the Internet in Psychological Research: Comparison of Online and Offline Questionnaires. *CyberPsychol. Behav.* **2003**, *6*, 73–80. [CrossRef]

43. Vigolo, V. Hospitality and Older Tourists: A Focus on Accommodation Choices. In *Older Tourist Behavior and Marketing Tools; Tourism Hospitality & Event Management*; Springer International Publishing AG: Cham, Switzerland, 2017; pp. 105–124, ISBN 978-3-319-47735-0.
44. Tajeddini, K.; Rasoolimanesh, S.M.; Gamage, T.C.; Martin, E. Exploring the visitors' decision-making process for Airbnb and hotel accommodations using value-attitude-behavior and theory of planned behavior. *Int. J. Hosp. Manag.* **2021**, *96*, 102950. [CrossRef]
45. Tussyadiah, I.P. An Exploratory Study on Drivers and Deterrents of Collaborative Consumption in Travel. In *Information and Communication Technologies in Tourism 2015*; Springer: Cham, Switzerland, 2015. [CrossRef]
46. Jones, R.; Alford, P.; Wolfenden, S. Entrepreneurial Marketing in the Digital Age: A Study of the SME Tourism Industry. In Proceedings of the Global Research Symposium on Marketing and Entrepreneurship, Chicago, IL, USA, 12–14 August 2015.
47. Westbrook, R.A.; Oliver, R.L. The Dimensionality of Consumption Emotion Patterns and Consumer Satisfaction. *J. Consum. Res.* **1991**, *18*, 84–91. [CrossRef]
48. Lee, S.; Kim, D.-Y. Brand personality of Airbnb: Application of user involvement and gender differences. *J. Travel Tour. Mark.* **2018**, *35*, 32–45. [CrossRef]
49. Dominici, G.; Guzzo, R. Customer Satisfaction in the Hotel Industry: A Case Study from Sicily. *Int. J. Mark. Stud.* **2010**, *2*, 3–12. [CrossRef]
50. Eurostat Nights Spent at Tourist Accommodation Establishments. Available online: [https://appsso.eurostat.ec.europa.eu/nui/show.do?dataset=tour\\_occ\\_ninat&lang=en](https://appsso.eurostat.ec.europa.eu/nui/show.do?dataset=tour_occ_ninat&lang=en) (accessed on 15 November 2021).
51. Hair, J.F.; Black, W.C.; Babin, B.J.; Anderson, R.E. *Multivariate Data Analysis*, 7th ed.; Pearson: New York, NY, USA, 2010.
52. Bryant, F.B.; Yarnold, P.R. Principal-Components Analysis and Exploratory and Confirmatory Factor Analysis. In *Reading and Understanding Multivariate Statistics*; Grimm, L.G., Yarnold, P.R., Eds.; American Psychological Association: Washington, DC, USA, 1995; pp. 99–136.
53. Tabachnick, B.G.; Fidell, L.S. *Using Multivariate Statistics*, 4th ed.; Allyn & Bacon: Needham Heights, MA, USA, 2001.
54. Beavers, A.S.; Lounsbury, J.W.; Richards, J.K.; Huck, S.W.; Skolits, G.J.; Esquivel, S.L. Practical Considerations for Using Exploratory Factor Analysis in Educational Research. *Pract. Assess. Res. Eval.* **2013**, *18*, 6. [CrossRef]
55. Hauke, J.; Kossowski, T. Comparison of Values of Pearson's and Spearman's Correlation Coefficients on the Same Sets of Data. *Quaest. Geogr.* **2011**, *30*, 87–93. [CrossRef]



## Article

# Measuring the Impact of Greece as a Safe Branding Tourist Destination: Evidence from Spain and Greece

Theodore Metaxas <sup>1,\*</sup>, Laura Juárez <sup>2</sup> and Meletios Andrinou <sup>1</sup><sup>1</sup> Department of Economics, University of Thessaly, 38333 Volos, Greece; mandrinou@uth.gr<sup>2</sup> Department of Marketing and Communication, European University of Madrid, 28224 Madrid, Spain; laura.juarez@universidadeuropea.es

\* Correspondence: metaxas@uth.gr

**Abstract:** After the first wave of the COVID-19 outbreak, many tourist destinations promoted a safe, COVID-free image to attract tourists. The main purpose of this paper is to examine and analyze the effect that the image of a place as a safe tourist destination (STD)—in our case, Greece—can have on the decision-making processes of tourists who were willing to take summer holidays in 2020 amid the COVID-19 pandemic. We examined the relationships between destination safety perceptions, trust, attractive attributes of destinations, travel intentions, and health-protective behavior for domestic and inbound tourists from Spain. This study confirms differences in destination safety perceptions among domestic and inbound tourists from countries that have suffered significant negative impacts due to the novel coronavirus.

**Keywords:** COVID-19; safety; tourism branding; health-protective behavior; Greece–Spain



**Citation:** Metaxas, T.; Juárez, L.; Andrinou, M. Measuring the Impact of Greece as a Safe Branding Tourist Destination: Evidence from Spain and Greece. *Sustainability* **2022**, *14*, 4440. <https://doi.org/10.3390/su14084440>

Academic Editors: Zygmunt Kruczek and Bartłomiej Walas

Received: 17 February 2022

Accepted: 30 March 2022

Published: 8 April 2022

**Publisher's Note:** MDPI stays neutral with regard to jurisdictional claims in published maps and institutional affiliations.



**Copyright:** © 2022 by the authors. Licensee MDPI, Basel, Switzerland. This article is an open access article distributed under the terms and conditions of the Creative Commons Attribution (CC BY) license (<https://creativecommons.org/licenses/by/4.0/>).

## 1. Introduction

After the travel restrictions imposed by several national authorities worldwide because of the COVID-19 pandemic, the reopening of the tourism sector was accompanied by a reduced willingness to travel on the part of tourists [1]. Given the threat of COVID-19 infection, health-related risks were highly evaluated among other travel risks, e.g., crime or terrorism [2]. The increasing number of COVID-19 cases and mortality rates affect humans' anxiety and fear levels, leading to contact- and travel-avoidance [3]. These psychological reactions motivate travel fear, which stems from tourists' perceptions of the possibility of being affected by COVID-19 while traveling and the severity of the effects [4]. The alleviation of fears and increased travel motivation may be achieved by the successful management of COVID-19 and the efficient implementation of health measures [3]. However, any unconditional lifting of travel restrictions combined with a poor epidemiological picture may negatively affect the image of a destination [5].

This study was conducted when the vaccines against COVID-19 had not been used and local authorities used non-pharmaceutical interventions to manage the current pandemic successfully. Thus, it aims to provide valuable insights regarding the differences in health-safety perceptions, travel intentions, and health-protective behaviors between domestic and international tourists who intended to travel during the summer after the first wave of the COVID-19 pandemic.

## 2. Literature Review

### 2.1. The Case of COVID-19

On 11 March 2020, the WHO declared a pandemic caused by a new virus originating from China. Despite experts' warnings, the novel coronavirus, SARS-CoV-2, was largely disregarded by national authorities worldwide, and it spread to over 146 countries [6]. Most countries responded to the emergency with several non-pharmaceutical methods,

such as social distancing, voluntary or required home isolation, and obligatory wearing of mouth and nose coverings. However, the daily growing number of COVID-19 cases in many countries obligated their respective authorities to implement additional measures, such as closing schools, restaurants, bars, and hotels, imposing travel restrictions, and closing borders, among other steps taken in the implementation of general lockdowns.

The apprehension among the public created by the rapid transmission of the COVID-19 virus and the imposed travel restrictions affected the tourism and travel sector more than any other. After the first wave of the pandemic, many countries reopened their economies and simultaneously ensured health-safety conditions. Over the last twenty years, global tourism has faced various crises. Still, none of them, not even the 2008 economic crisis, affected the growth of the tourism sector as much as COVID-19 has [7].

## 2.2. *The COVID-19 Pandemic in Greece and Spain*

In Greece, the first COVID-19 case was reported on 26 February 2020. A month later, Greece had 93 cases and 12 deaths. As a result, the prime minister announced a total ban on public movement, the closure of almost all businesses, including hotels, and the closure of the Greek borders. On 15 June, Greece reopened its borders and the first foreign tourists arrived. Authorities were optimistic about reopening the tourism and hospitality sector due to the successful management of the COVID-19 pandemic [8]. In Spain, the first confirmed COVID-19 case was reported on 31 January 2020. On 13 March, the Spanish government announced a total lockdown. The first day without a reported death by COVID-19 was 1 June 2020, and on 21 June the Spanish government ended the alarm. As of 1 July 2020, Spain had reported over 255,000 confirmed COVID-19 cases and almost 30,000 deaths [9]. The first wave of COVID-19 affected Spain and Greece differently. Spain was one of the most affected countries in Europe, while Greece was less affected. Therefore, it is interesting to investigate how the advertisement of a place as a health-safe tourist destination (STD)—in our case, Greece—affects the decision-making processes of tourists who experienced the COVID-19 pandemic differently.

## 2.3. *Health-Safety as a Criterion of Choosing a Tourist Destination*

The COVID-19 pandemic has proved tourism's vulnerability to crises that threaten tourists' sense of safety [10]. Tourists' safety primarily refers to the safety of their persons and their property. Reisinger and Movondo [11] pointed out that ensuring safety is the primary condition of normal tourism development. However, nowadays, tourists are more mobile than ever, and failing to make them feel safe may change their choice of destination, leading to long-term impacts on tourist destinations and their economies [12].

Over recent decades, health crises have been accelerated by tourist movements. In Singapore, the SARS outbreak deterred overseas tourists from visiting the country, with significant negative impacts on the country's economy [13]. Moreover, travelers considered Ebola a severe health risk, and this also increased travel avoidance [14]. South Korea estimated the loss of tourism due to the MERS outbreak at USD 3.1 billion [15]. COVID-19 has created international anxiety among travelers. As long as traveling is considered unsafe, tourism will decline [10]. Once tourists perceive a destination as risky, the growth and development of the tourism industry in question will be negatively affected [16]. Therefore, understanding tourists' decision-making processes is critical to explaining and predicting their travel intentions and behavior.

## 2.4. *Previous Studies and Hypothesis Development*

Tourists' perceptions of risk and uncertainty are significantly correlated with their decision-making processes regarding travel destinations [17]. Similar to Crompton's [18] definition, destination health-safety perception can be defined as a set of beliefs, ideas, and impressions that tourists have regarding the health-safety of a destination. Based on this assumption, it is likely that an attractive health-safety image will increase the probability of a destination to be chosen [19].

As concerns the attractiveness of destinations, Hu and Ritchie [20] claimed that the combination of the tourism facilities and services motivates tourists to visit a destination. Similarly, Kim and Perdue [19] argued that the attractiveness of destinations is determined by both their physical attributes and the internal psychological factors of tourists. Floyd and Pennington-Gray [21] included safety as one of the most important characteristics of destinations. Especially nowadays, tourists' perceptions regarding the safety and security of destinations are positively related to their travel decision-making process [22]. Tourists are expected to be attracted by destinations with appealing natural environments and therapeutic activities that will assist them in improving their psychology after the lockdown period [23]. Thus, a positive relationship between destination safety image perception (DSIP) and destinations' attractive attributes might occur.

**Hypothesis 1-1(a).** *There is a positive association between health-safety perceptions and the attractive destination attributes for Greek tourists.*

**Hypothesis 1-1(b).** *There is a positive association between health-safety perceptions and attractive destination attributes for Spanish tourists.*

**Hypothesis 1-2.** *The positive relation between tourists' health-safety perceptions and destinations' attractive attributes will be stronger for Greeks than for Spaniards.*

Ajzen [24] pointed out that attitudes toward a behavior, subjective norms, and perceived behavioral controls are the antecedents of a person's intention to engage in a particular behavior. In the tourism literature, behavioral intentions refer to tourists' willingness to visit, revisit, or recommend a tourist destination [25]. The vast body of tourism literature supports this direct and positive relationship [26–28]. For example, Styliadis et al. [28] argued that overall destination image, perceived quality, and satisfaction are positively related to the behavioral intentions of domestic tourists in Israel. Additionally, Khan et al. [27] revealed that cognitive and psychological perceptions influenced young women's intentions to visit India. Finally, Caber et al. [26] examined the German tourists' perceptions of Greece and Spain and they claimed that the low-risk perceptions of both countries positively influenced their destination selection behavior and travel intentions. Thus, we can claim that a positive relationship between DSIP and tourists' travel intentions might occur during a pandemic outbreak.

**Hypothesis 2-1(a).** *There is a positive association between health-safety perceptions and travel intentions for Greek tourists.*

**Hypothesis 2-1(b).** *There is a positive association between health-safety perceptions and travel intentions for Spanish tourists.*

**Hypothesis 2-2.** *The positive correlation between tourists' health-safety perceptions and their travel intentions will be higher for Spaniards than for Greeks.*

The relationship between tourists' perceptions and trust has recently attracted the attention of researchers. Chung and Kwon [29] defined trust as the personal feeling of security and the intention to rely on others. According to Artigas et al. [30], trust is a multidimensional construct that includes the tourists, the locals, and the public and private institutions of a destination that are expected to be honest, benevolent, and competent. One of our aims is to explore the relationship between the tourists' safety perceptions and trust. Loureiro and González [31] revealed that, in rural destinations, the image perceptions directly affect tourists' perceived quality, satisfaction, and trust. Additionally, Artigas et al. [30] claimed that tourists' cognitive perceptions and affective evaluations for a destination are positively related to their trust. Thus, a positive relationship between DSIP and trust might occur.

**Hypothesis 3-1(a).** *There is a positive association between health-safety perceptions and trust for Greek tourists.*

**Hypothesis 3-1(b).** *There is a positive association between health-safety perceptions and trust for Spanish tourists.*

**Hypothesis 3-2.** *The positive relation between tourists' health-safety perceptions and trust will be stronger for Greeks than for Spaniards.*

As mentioned before, health risks are one of the higher-ranked travel risks. Chien et al. [32] claimed that health risks increase tourists' worries and motivate their health-protective behavior. Li et al. [33] argued that crisis-sensitive tourists might shorten their holidays in the post-pandemic era. However, destination managers could use mass media, social media, and destination websites to influence and manipulate the destination image and tourists' behavior [34]. Thus, a positive relationship between DSIP and tourist health-protective behavior could be configured.

**Hypothesis 4-1(a).** *There is a positive association between health-safety perceptions and health-protective behavior of Greek tourists.*

**Hypothesis 4-1(b).** *There is a positive association between the health-safety perceptions and the health-protective behavior of Spanish tourists.*

**Hypothesis 4-2.** *The positive relation between tourists' health-safety perceptions and their health-protective behavior will be stronger for Greeks than for Spaniards.*

The relationship between tourists' trust and destinations' attractive attributes has attracted limited research interest. Research interest on tourists' trust focuses on its relationship with eWOM [35], travel avoidance [36], and loyalty [31]. However, according to Jensen and Svendsen [37], destination attractiveness is improved if tourists' social trust increases. Artigas et al. [30] also revealed that destinations' attractive attributes are useless if tourists do not trust the destination. Tourists' trust in the government pandemic management influences their travel intentions [36]. Thus, the following hypothesis may be formulated:

**Hypothesis 5-1(a).** *There is a positive association between tourists' trust and the attractive destination attributes for Greek tourists.*

**Hypothesis 5-1(b).** *There is a positive association between tourists' trust and the attractive destination attributes for Spanish tourists.*

**Hypothesis 5-2.** *The positive relation between tourists' trust and the attractive destination attributes will be stronger for Greeks than for Spaniards.*

In the post-COVID-19 era, fear may increase travel avoidance. Nevertheless, Zheng et al. [36] argued that trust in the government's effective management of the pandemic significantly influences tourists' travel intentions. Likewise, Jensen and Svendsen [37] claimed that social trust motivates tourists' visit intentions on destinations and contributes to the destinations' safety perceptions. However, Abraham et al. [38] argued that domestic tourists might lose their trust and avoid local destinations if their government fails to manage the pandemic. Thus, a positive relationship between trust and tourists' travel intentions may occur when a destination is perceived as safe.

**Hypothesis 6-1(a).** *There is a positive association between tourists' trust and the travel intentions of Greek tourists.*

**Hypothesis 6-1(b).** *There is a positive association between tourists' trust and the travel intentions of Spanish tourists.*

**Hypothesis 6-2.** *The positive relationship between tourists' trust and travel intentions will be stronger for Greeks than for Spaniards.*

Previous studies have explored the relationship between tourists' trust and their behavior intentions [35]. However, few studies have examined the impact of trust on tourists' health-protective behavior. For example, Bish and Michie [39] revealed that high trust levels in authorities are associated with the personal protective behavior of tourists during a pandemic. Similarly, Liao et al. [40] argued that during the spread of H1N1 influenza, high trust levels in formal education messages increased the personal health-protective behavior of tourists. Although limited attention has been given to understanding how tourists' trust beliefs affect their health-protective behavior during the COVID-19 [41], the following hypothesis can be formulated:

**Hypothesis 7-1(a).** *There is a positive association between tourists' trust and the health-protective behavior of Greek tourists.*

**Hypothesis 7-1(b).** *There is a positive association between tourists' trust and the health-protective behavior of Spanish tourists.*

**Hypothesis 7-2.** *The positive relationship between tourists' trust and health-protective behavior will be higher for Greeks than for Spaniards.*

Tourists' intentions to travel depend on their past travel experiences or their perceptions regarding their safety. Studies have confirmed that health-protective measures mitigate the reduced travel intentions during health crises [42]. Travel restrictions and tourists' anxiety decreased travel intentions during the COVID-19 pandemic. However, researchers claimed that people coming from highly exposed countries (as concerns as the first wave of coronavirus) are expected to travel immediately after the lifting of travel restrictions. These tourists may develop health-protective behaviors, and safe tourist destinations could attract them [43]. Thus, a positive relationship between travel intentions and tourist health-protective behavior may occur.

**Hypothesis 8-1(a).** *There is a positive association between tourists' travel intentions and the health-protective behavior of Greek tourists.*

**Hypothesis 8-1(b).** *There is a positive association between tourists' travel intentions and the health-protective behavior of Spanish tourists.*

**Hypothesis 8-2.** *The positive relation between tourists' travel intentions and health-protective behavior will be stronger for Spaniards than for Greeks.*

Attractiveness plays a vital role in destination-choice processes, and avoidance behavior may influence tourists' decision-making [44]. During an outbreak, health and safety are featured as the most essential destination attributes over other attributes, such as gastronomy and natural environment. Moreover, tourists' behavior is expected to be shifted to a more health-protective behavior [45]. Before the pandemic, the negative impact of over-tourism on destinations received much attention [46]. Destinations attract high tourists flow, leading to crowded places. Nowadays, tourists develop a more health-protective behavior when they visit crowded attractions under the fear of the COVID-19 infection [47]. Thus, a positive relationship between attractive destinations attributes and tourist health-protective behavior may occur.

**Hypothesis 9-1(a).** *There is a positive association between the destinations' attractive attributes and the health-protective behavior of the Greek tourists.*

**Hypothesis 9-1(b).** *There is a positive association between the destinations' attractive attributes and the health-protective behavior of the Spanish tourists,*

**Hypothesis 9-2.** *The positive relation between the destinations' attractive attributes and the health-protective behavior will be stronger for Spaniards than for Greek tourists.*

Figure 1 summarizes the hypothesized model.

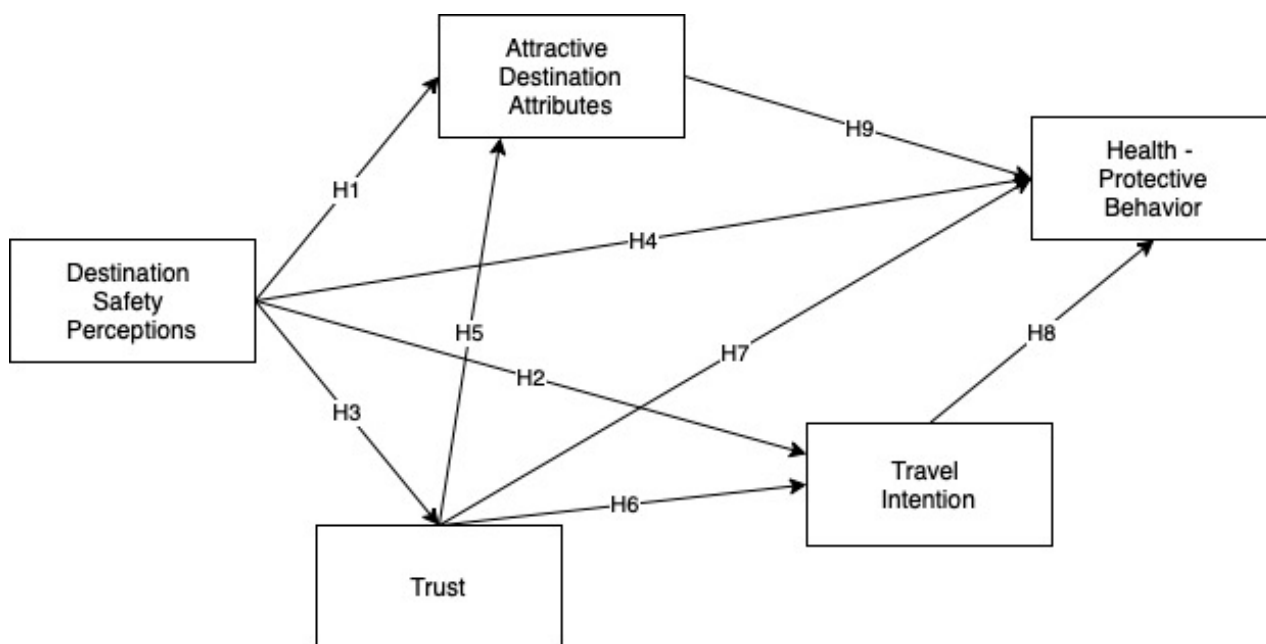

**Figure 1.** Hypothesized Model.

### 3. Methods

#### 3.1. Research Design

A questionnaire was developed consisting of 23 grounded-in-theory questions, and an online survey was conducted between 1 June 2020 and 31 July 2020. Participants were recruited through *LinkedIn* from users who were willing to take summer holidays after the first wave of COVID-19. The questionnaire was designed to measure how tourists perceive Greece as a safe destination. Greek tourists were chosen as a sample because they are part of the domestic tourism market of a country that had successfully managed the first wave of COVID-19. Spaniards were selected as a sample because they are part of the inbound tourism market; additionally, the first wave of the COVID-19 had severely hit their country. The questionnaire was developed in Greek, English, and Spanish in order to manage cross-country issues. Two academics revised it, and it was then shared on social media along with the purpose of the study.

The first section of the questionnaire was focused on the participants' sociodemographics. The second section consisted of questions regarding the participants' safety perceptions, Greece's attractive attributes, trust in the destination, travel intentions, and health-protective behavior. Four items were used to measure the participants' perceptions regarding Greece's image as a safe destination. Tourists' trust consisted of nine measurement items [30]. Attractive destination attributes were measured using four measurement items [48]. Three measurement items were used regarding the participants' travel intentions [49], and three measurement items regarding participants' health-protective behavior [42]. All items were measured with a 7-point Likert scale.

### 3.2. Sociodemographic Profile

In total, 951 respondents participated in the survey; 551 were Greeks and 400 were Spaniards. No missing data was observed, and further analysis was conducted. SPSS v.23 was used to extract the respondents' profiles from each country. Table 1 summarizes sample characteristics. Females represented 51.5% of the Greek respondents and 57.5% of the Spaniards. Regarding the annual personal income, 54.3% of Greeks declared an annual income less than €15,000, and 67.5% of Spaniards stated an annual income between €15,001 and €30,000. These differences may be explained by looking at the World's Bank data on both countries' per capita income (Greece = €14,170 and Spain = €21,440). The income results were translated into the results regarding the travel spending in both countries. Greeks spent under €1000 and Spaniards €1501 to 2000 on vacations when they travel. Regarding the current pandemic, the majority of respondents from both countries were not infected by COVID-19. However, only 5.8% of Greeks declared a family member infected by the novel coronavirus, while 53% of Spaniards had an infected family member.

**Table 1.** Sociodemographic Profile.

Variable	Category	Greece	Spain
Country			
N.		Percentage %	Percentage %
Gender	Male	48.5%	42.5%
	Female	51.1%	57.5%
Age	18–24	16.0%	20.5%
	25–34	19.6%	26.0%
	35–49	39.9%	30.3%
	50–65	23.4%	14.0%
	>65	1.1%	9.3%
Education Level	Primary School	0.4%	1.8%
	High School	12.3%	34.3%
	Graduated Degree	48.6%	45.5%
	Postgraduate Degree	38.7%	18.5%
Annual Income	<10,000€	31.8%	6.3%
	10,001–15,000€	22.5%	5.0%
	15,001–20,000€	12.9%	28%
	20,001–30,000€	15.8%	39.5%
	30,001–45,000€	8.0%	12.5%
	>45,000€	9.1%	8.8%
Travel Spending	<1000€	50.8%	10.3%
	1001–1500€	21.1%	20.0%
	1501–2000€	12.9%	40.0%
	2001–3000€	8.9%	19.5%
	3001–4500€	5.3%	7.0%
	>4500€	1.1%	3.3%
Sicked yourself by COVID-19	Yes	5.8%	5.3%
	No	94.2%	94.8%
Sicked family member by COVID-19	Yes	5.8%	53.0%
	No	94.2%	47.0%

Exploratory Factor Analysis (EFA), Multi-Groups Confirmatory Factor Analysis (MGCFA), and Multi-Groups Structural Equation Model (MGSEM) were performed in the further analysis. The EFA was conducted to transform the large datasets into smaller ones that contained the majority of the information that could be used in the subsequent analy-

sis [50]. Next, a Confirmatory Factor Analysis (CFA) tested the goodness of fit of our model. Finally, to identify any cross-cultural differences between the groups, an MGCFA was conducted [51].

### 3.3. Analysis

A maximum-likelihood factor analysis with Promax rotation was used to examine the simplicity and clarity of factor loadings and structure. To extract the number of factors, the criteria we applied included a minimum eigenvalues of 1.0 and a factor loading of individual items with a minimum loading of 0.5 or higher, and the total item variance explained by the retained factors should be high, with 60% as a minimum target [52]. KMO was 0.908, and Bartlett's test of sphericity  $p$ -value was  $<0.05$ , indicating that EFA could be pursued [53]. Eventually, internal reliability was estimated for all factors, and it exceeded the minimum desired reliability of 0.70 [52], while the total variance was 76.45%.

In the next step we tested the hypothesized model (Figure 1) in two stages. First, CFA was performed to validate the measurement model using the five latent constructs identified by the EFA. All constructs were correlated to estimate each construct's overall fit, validity, and reliability. Next, Multi-Group CFA was performed using SPSS Amos v.23, and several fit indices were examined to support the model goodness of fit. As recommended in the literature, when performing CFA analysis for the Comparative Fit Index (CFI) and the Goodness of Fitness Index (GFI), values from 0.90 and above generally represents a good fit. For the Root Mean Squared Error of Approximation (RMSEA), values  $< 0.08$  suggest an acceptable fit [53]. While, the Standardized Root Mean Square Residual (SRMR) is an absolute measure of fit, and values  $< 0.08$  generally indicate a good fit [54]. Finally, the  $\chi^2/df$  ratio values less than 5 show a good fit [55].

Initially, the hypothesized model was tested in the multi-group to examine model fit per group. In the multi-group model fit indices, values were  $\chi^2/df = 4.694$ , CFI = 0.956, GFI = 0.922, RMSEA = 0.062, and SRMR = 0.063. The results support that the model achieved the recommended values and was accepted. Table 2 summarizes the goodness-of-fitness results from the CFA of the multi-group model, Greeks, and Spaniard groups.

**Table 2.** Measurement Model for Constructs.

Variable	Item	Factor Loading	Cronbachs' $\alpha$	CR	AVE
Trust	...		0.950	0.954	0.656
	... in the implementation of health protocols by C-level tourism executives	0.859			
	... in the implementation of health protocols by business	0.864			
	... in good cooperation between business and health system	0.885			
	... in good cooperation between business and the general secretariat for civil protection	0.869			
	... in the implementation of health protocols in transport and transport infrastructure	0.830			
	... in safe, well-organized, and modern tourism infrastructure	0.759			



Table 2. Cont.

Variable	Item	Factor Loading	Cronbachs' $\alpha$	CR	AVE
	Greece is a safe European country in full compliance with the health protocols set out in the European Union	0.784			
	... in the safety and precautionary measures introduced by the Greek government	0.742			
	... in the policies and measures introduced by the European Union	0.671			
Destination Safety Perception			0.893	0.869	0.686
	Low rates of coronavirus infections across the county	0.957			
	Low coronavirus death rate across the county	0.885			
	Successful management of the COVID-19	0.821			
	Greece is a Safe Tourist Destination for 2020	0.619			
Attractive Attributes			0.867	0.870	0.629
	The uniqueness/distinctiveness of the destination	0.867			
	The historical/cultural character of the destination	0.834			
	Natural environment of the destination	0.801			
	Traditional cuisine/food products	0.645			
Health-Protective Behavior			0.905	0.911	0.774
	I will comply with the health protocols of my planned destination country	0.970			
	I will comply with the health protocols of my planned vacation accommodation	0.885			
	I will comply with applicable safety and precautionary measures	0.801			
Travel Intentions			0.852	0.853	0.660
	I will go on vacation as long as there is access to accurate information and news	0.830			

**Table 2.** *Cont.*

Variable	Item	Factor Loading	Cronbachs' $\alpha$	CR	AVE
	I will go on vacation as long as health infrastructures and health care services can be found	0.800			
	I will go on vacation to a promiscuous and unforgettable travel destination offering at the same time a high level of safety	0.821			

Furthermore, we examined the composite reliability and discriminant validity (Table 2). Cronbach's  $\alpha$  and composite reliability (CR) values surpassed the 0.7 criteria, and the lowest average variance extracted (AVE) values were greater than 0.5, as suggested [53]. As a final step, values of skewness and kurtosis were estimated to examine the normality of our data. Our results showed that skewness values were between  $-1.784$  and  $-0.406$ , and kurtosis values ranged from  $-0.803$  to  $3.639$  (Table 2). According to Kline [56], normality values for skewness range,  $\pm 2$ , and kurtosis values,  $\pm 7$ , vary. Thus, we can support that our results fall into normal ranges.

Finally, Table 3 shows all the square roots of AVE for each latent construct greater than their correlations with other constructs, indicating the discriminant validity of the constructs [57].

**Table 3.** Discriminant validity.

Construct	DSP	TR	ADA	HSB	TI
Destination Safety Perception	<b>0.830</b>				
Trust	0.486 ***	<b>0.810</b>			
Attractive Destination Attributes	0.362 ***	0.273 ***	<b>0.793</b>		
Health-Safety Behavior	0.360 ***	0.273 ***	0.108 ***	<b>0.880</b>	
Travel Intention	0.220 ***	0.356 ***	0.333 ***	0.339 ***	<b>0.812</b>

Note: DSP = Destination Safety Perception, TR = Trust, ADA = Attractive Attributes, HSB = Health-Safety Behavior, TI = Travel Intentions, Square Root of AVE values. \*\*\* Denotes  $p < 0.001$ .

Because all scales in this study were assessed and determined to have appropriate measurement characteristics, testing hypotheses was the next stage in the analysis. We subsequently conduct the multi-group analysis to examine the hypothesized relationships proposed in the conceptual model and test the differences between notions. Table 4 highlights the results from analyzing the model's fitness to each sample's data and the multi-group analysis.

**Table 4.** Goodness of fitness of the models.

Model	CMIN	df	CMIN/df	CFI	GFI	RMSEA	SRMR
Unconstrained model	1432.33	418	3.427	0.946	0.887	0.051	0.071
Constrained model	1610.99	445	3.620	0.938	0.874	0.053	0.073

Source: AMOS output.

As shown in Table 4, the significant difference ( $p < 0.001$ ) in chi-square statistic  $\Delta\chi^2 = 178.66$  and  $\Delta df = 27$  shows that the structural relationships are significantly different between the two segments. Thus, as is recommended, we examined scalar invariance by comparing the latent constructs' means. The z-score method ( $z = \text{mean difference} / \text{standard error}$ ) was employed to compare the means of parameters between Greek and Spanish tourists. According to theory, when  $|z| > 1.645$  and the  $p$ -value is less than 0.05, there is a substantial difference between the two groups [58].

#### 4. Results

Table 5 shows the comparisons of results by country. We utilized unstandardized coefficient estimates to analyze differences and similarities because the variances differed between groups [59].

**Table 5.** Significant results of comparisons of the path coefficients between Greek and Spanish group.

Hypothesis	Unconstrained Model		
	Greeks Estimates	Spaniards Estimates	Z-Score
H1: Destination Safety Perception→Attractive Attributes	0.102	0.969 ***	8.358 ***
H2: Destination Safety Perception→Travel Intention	0.159 *	0.514 ***	3.671 ***
H3: Destination Safety Perception→Trust	0.597 ***	0.568 ***	−0.425
H4: Destination Safety Perception→Health Protective Behavior	0.150 ***	0.170 *	0.191
H5: Trust→Attractive Attributes	0.165 ***	−0.054	−2.194 *
H6: Trust→Travel Intention	0.323 ***	0.014	−3.371 ***
H7: Trust→Health Protective Behavior	−0.052	−0.257 ***	−3.184 ***
H8: Travel Intention→Health Protective Behavior	0.315 ***	0.519 ***	2.808 ***
H9: Attractive Attributes→Health Protective Behavior	0.052	0.215 ***	2.347 *

Note: \*\*\* denotes  $p$ -value < 0.001, \* denote  $p$ -value < 0.05.

Accordingly, the relationship between safety perception and attractive destination attributes between groups was partially confirmed. A positive and strong coefficient was revealed only for Spaniards ( $\beta = 0.969$ ,  $p < 0.001$ ). Thus, Hypothesis 1-1(a) was rejected, hypothesis 1-1(b) was confirmed, and Hypothesis 1-2 was rejected.

In the next hypothesis, safety perception significantly affected tourists' travel intentions in both groups. According to our results, significant differences among groups revealed that the Spaniards' coefficient is higher. Thus, Hypothesis 2-1(a), Hypothesis 2-1(b), and Hypothesis 2-2 were confirmed.

A strong relationship between tourists' safety perceptions and trusts was revealed for both nationalities. Thus, Hypothesis 3-1(a) and Hypothesis 3-1(b) were confirmed. No significant differences were observed between groups, indicating homogeneity in tourists' perceptions. Thus, Hypothesis 3-2 was rejected.

A positive relationship between tourists' safety perceptions and their health-protective behavior was revealed for both nationalities. Thus, Hypothesis 4-1(a) and Hypothesis 4-1(b) were confirmed. No significant differences were observed between groups, indicating homogeneity in tourists' perceptions. Thus, hypothesis 4-2 was rejected.

Next, we assumed a positive connection between tourists' trust and attractive destination attributes. Only Hypothesis 5-1(a) was confirmed (Greek:  $\beta = 0.165$ ,  $p < 0.001$ ). A non-significant relationship was revealed for Spanish tourists. Thus, Hypothesis 5-1(b) and Hypothesis 5-2 were rejected.

Additionally, a positive relation between tourists' trust and their travel intention was proposed. Only in the case of Greek tourists was the relationship supported. Thus hypothesis 6-1(a) was confirmed (Greek:  $\beta = 0.323$ ,  $p < 0.001$ ) and Hypothesis 6-1(b) and Hypothesis 6-2 were rejected.

We examined the relationship between tourists' trust and their health-protective behavior. A positive significant relationship was revealed only in the case of Spanish tourists (Spaniards  $\beta = 0.215$ ,  $p < 0.001$ ). Thus, Hypothesis 7-1(a) was rejected, hypothesis 7-1(b) was confirmed, and Hypothesis 7-2 was rejected.

A positive relationship was revealed between tourists' travel intentions and their health-protective behavior for both nationalities. Thus, Hypothesis 8-1(a) and Hypothesis 8-1(b) were confirmed. However, a stronger relationship was revealed for Spanish tourists (Greek:  $\beta = 0.315$ ,  $p < 0.001$ ; Spaniards  $\beta = 0.519$ ,  $p < 0.001$ ) which provides support in our hypothesis (Hypothesis 8-2).

Finally, the positive relationship between destination attractive attributes and tourists' health-protective behavior was not confirmed for either nationality. Thus, Hypothesis 9-1(a),

Hypothesis 9-1(b), and hypothesis 9-2 were rejected. Nevertheless, a negative relationship is revealed for Spanish tourists (Spaniards  $\beta = -0.257$ ,  $p < 0.001$ ). The results are represented graphically in Figure 2.

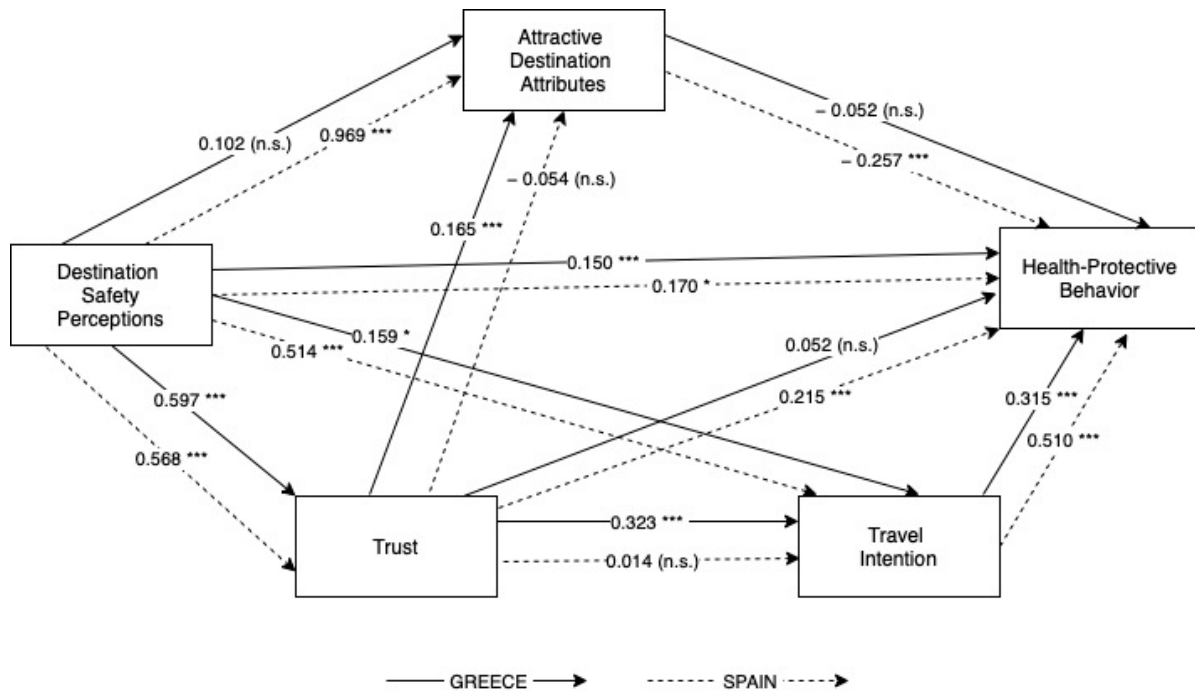

**Figure 2.** Cross-country comparison. Note: Unstandardized path estimates, \*\*\* denotes  $p < 0.001$ , \* denotes  $p < 0.05$ , n.s. denotes non-significant.

## 5. Discussion

After the first wave of the COVID-19 pandemic, a cross-country study was performed to examine similarities and variations in the perceptions of local and foreign visitors about Greece. The present study aims to explore the effect of Greece's image as a Safe Tourist Destination on tourists who were willing to take summer holidays in 2020. Greeks were selected because they constitute the domestic tourism market, and according to the literature, they should be the primary target market in the early post-pandemic recovery period [60,61]. Spaniards were selected because they come from a country with one of the highest COVID-19 infections and mortality rates in Europe, but still, they show interest in travel [43,61]. Unlike most of the previous studies, which are mainly focused on risk perceptions provoked by COVID-19, the present study is focused on tourists' safety perceptions. Nine hypotheses were developed based on the literature review, and valuable theoretical and managerial insights were revealed.

The present study provides valuable insights into the importance of the health-safety destination's image in the recovery period after a health crisis. Moreover, differences in the perceptions between domestic and inbound tourists are revealed. Several theoretical implications can be derived from our findings. Health-safety perceptions of Greeks, who represent the domestic tourism market, are positively related to their trust, travel intentions, and health-protective behavior. For Spaniards, who represent the inbound tourism market, their health-safety perceptions are additionally positive related to Greece's attractiveness as tourism destination. Our findings reinforce the findings of previous studies. For example, Kim and Perdue [19] claimed that the destinations' cognitive image influences its attractiveness and improves tourists' experience. According to Hsu et al. [62], destination safety and security are positively related to attributes such as its natural scenery and local cuisine. Wen et al. [63] argued that safety became essential in tourists' travel decisions after the SARS outbreak. During the COVID-19 pandemic, studies also confirmed the significant relationship between safety perceptions and travel intentions [64]. Our results are also

in accordance with Artigas et al. [30], who proposed that trust in a destination is related to its reputation, tourists' cognitive perceptions, and their affective evaluations. In our case, tourists' trust toward Greece, especially regarding implementing the health protocols by local authorities and businesses, was empowered because it was perceived as a safe tourist destination.

According to our model, tourists' perceptions regarding Greece as a health-safe destination positively influenced their health-protective behavior. Likewise, Rončák et al. [65] claimed that tourists are willing to choose their destination based on possible health risks in the early pandemic period. Caber et al. [26] revealed that Greece's safety image positively influences tourists' choices. However, during the summer vacations after the first wave of the coronavirus in Europe, the lack of a vaccine against COVID-19 made tourists more cautious about possible infection and more willing to comply with all the health protocols. Thus, we can claim that tourists are eager to choose Greece as a health-safe destination for their vacation during a pandemic. Still, the lack of pharmaceutical interventions increases their health-protective behavior when they travel. Our result reinforces Orîndaru et al. [61] regarding tourists' priority on the appropriate implementation of health protocols in their decision-making process. Additionally, a stronger and more positive relationship between travel intention and health-protective behavior for international than domestic tourists is revealed. It seems that tourists intend to travel soon after the travel restrictions are lifted. However, as Zheng et al. [36] claimed, tourists' fear of being infected by COVID-19 when traveling makes them seek destinations that apply strict measures against the coronavirus spread. Tourists' fears of infection may also motivate them to develop health-protective behaviors when traveling [66].

However, differences are observed between domestic and inbound tourists, highlighting the importance of using different strategies to attract different segments of tourists. On the one hand, tourists' trust positively influences their travel intentions and Greece's attractiveness only for the domestic tourism market. Similarly, Moreno-Luna et al. [67] have also pointed out that destination recovery strategies should be focused on the domestic tourism market by strengthening and developing experiential, active, and rural tourism. On the other hand, only inbound tourists' trust is positively related to their health-protective behavior. Our findings reinforce previous studies [68,69], which suggest that tourists develop more health-safety behaviors during a pandemic, and they choose a destination they trust regarding the implementation of health protocols. Thus, we argue that tourists' confidence in local authorities in managing a health crisis may motivate them to comply with the destination's rules and health protocols to reduce health risks. Contrary to other studies, which argue that tourists are not hesitating to visit events or crowded places as long as the health protocols are observed [65], Greece's attractive attributes were negatively related to the Spaniards' health-protective behavior. Our findings may be justified by the fact that, in the early post-coronavirus days, travel was still limited, and popular attractions (e.g., historical sites) were less crowded. Thus, tourists adopt a less health-protective behavior that offers the opportunity of escaping from the "new" social distancing norm because they feel less at risk.

Some practical implications can arise from the present study that can assist destination policy-makers and tourism businesses in the post-COVID-19 recovery period. The tourism sector experiences an unprecedented period due to the travel bans imposed by many countries to prevent the spread of the novel coronavirus. According to the World Tourism Organization [70], the COVID-19 pandemic caused a 74% reduction in tourist arrivals worldwide. To limit all the negative impacts, policy-makers should apply effective recovery plans with respect to the health-safety conditions in the destinations. Promoting a health-safe destination image affects the psychology of domestic and inbound tourists differently. Thus, different methods are required to approach these two market segments.

Ensuring a destination's health-safety conditions during the pandemic and promoting a safe image may increase tourist flows. Domestic tourists should be the target tourism market in the short-term period. However, inbound tourists are also willing to visit health-

safe destinations when travel restrictions are lifted. Tourists trust social media more than other sources for information about a destinations' safety conditions [69]. Thus, destinations should use social media to provide transparent information about their current pandemic situation and the health measures taken to ensure visitors safety and to promote their health-safety image. Nevertheless, tourists intend to travel to safe destinations, but their perceived severity regarding the pandemic's impact increases their protective behaviors [43]. However, it is also essential that tourism authorities pay attention when promoting their destination's health-safety condition because COVID-19 deniers may also be attracted, leading to a spiking infection rate within the destination [71].

Tourists are expected to use the internet more frequently to access information about tourism destinations' health situation and make reservations remotely [72]. Tourism businesses should invest in technological innovations. Thus, we suggest that businesses invest in their presence on the internet by developing or upgrading their websites, to provide helpful information and links regarding the health measures they take against the spread of the coronavirus on their websites, to provide mobile-friendly reservations systems on their websites, and to offer contactless check-in systems through mobile apps. Such approaches may increase tourists' trust and help businesses to attract their target markets.

Our findings provide empirical evidence to destinations' policy-makers who are willing to increase their share in the domestic tourism market in the post-pandemic period. Strategies to enhance tourists' trust in their hygiene environment and improve their attractiveness should be developed. Recreation, gastronomic, and rural tourism are expected to be favorable among tourists in the post-pandemic period, which offers destinations the opportunity to reposition themselves to internal tourists. By ensuring health conditions and providing less crowded places, tourism destinations may moderate the negative effects on their economies by increasing the numbers of domestic tourists. Additionally, more crowded destinations may use the post-pandemic period to redesign their tourism development model to reduce mass tourism, increase other types of tourism, and improve their sustainability.

Less crowded destinations are also expected to attract international tourists. Based on the results obtained in the present research, inbound tourists may see those places as an opportunity to feel more released and to develop a less health-protective behavior and escape from the "new" normality of social distancing caused by the novel coronavirus. Health protocols should be followed to ensure destinations' and tourists' safety. Tourism businesses should use clear information about the health protocols that tourists should follow. However, tourism businesses should redesign their environment or develop new services (e.g., health retreat centers, recreation activities) in respect of the need of tourists to escape from a stressful quarantine period they may have lived in their countries.

## 6. Conclusions

The negative impacts of COVID-19 on the tourism sector have attracted research interest. This paper contributes to research on destination safety, tourists' perceptions, and tourists' protective behavior. Our findings highlight the critical impact of tourists' safety perceptions regarding the destination on their travel intention and their health-protective behavior and the cross-cultural differences regarding the role of tourists' trust and destinations' attractiveness. The study highlights the preference of tourists towards destinations that provide a health-safety environment. Results suggest that during a health crisis, tourism policy-makers should use all possible tools to analyze and profile their potential tourists to attract them to the destination.

The study presents some limitations. The exploratory nature and the specificities of the sample suggest caution in the generalization of the findings. In addition, we must note that the present study was conducted after the first wave of the novel coronavirus. After the summer vacations, countries experienced a second and a third wave of COVID-19. During this period, people may have lived under extended lockdowns, which could have caused changes in their safety perceptions and travel intentions. Vaccinations from the

end of 2020 reduced peoples' health concerns, increased their willingness to travel, and decreased their health-protective behavior.

**Author Contributions:** Conceptualization, T.M.; methodology, T.M. and M.A.; formal analysis, M.A.; investigation, T.M. and L.J.; resources, L.J.; writing—original draft preparation, T.M., L.J. and M.A.; writing—review and editing, T.M.; supervision, T.M.; project administration, T.M. All authors have read and agreed to the published version of the manuscript.

**Funding:** This research received no external funding.

**Institutional Review Board Statement:** Not applicable.

**Informed Consent Statement:** Not applicable.

**Data Availability Statement:** Not applicable.

**Conflicts of Interest:** The authors declare no conflict of interest.

## References

- Zhang, K.; Hou, Y.; Li, G. Threat of infectious disease during an outbreak: Influence on tourists' emotional responses to disadvantaged price inequality. *Ann. Tour. Res.* **2020**, *84*, 102993. [CrossRef] [PubMed]
- Jonas, A.; Mansfeld, Y.; Paz, S.; Potasman, I. Determinants of health risk perception among low-risk-taking tourists traveling to developing countries. *J. Travel Res.* **2011**, *50*, 87–99. [CrossRef]
- Agyeiwaah, E.; Adam, I.; Dayour, F.; Badu Baiden, F. Perceived impacts of COVID-19 on risk perceptions, emotions, and travel intentions: Evidence from Macau Higher Educational Institutions. *Tour. Recreat. Res.* **2021**, *46*, 195–211. [CrossRef]
- Zheng, D.; Luo, Q.; Ritchie, B.W. The role of trust in mitigating perceived threat, fear, and travel avoidance after a pandemic outbreak: A multigroup analysis. *J. Travel Res.* **2021**, *61*, 581–596. [CrossRef]
- Song, K.-H.; Choi, S. A study on the behavioral change of passengers on sustainable air transport after COVID-19. *Sustainability* **2020**, *12*, 9207. [CrossRef]
- Hall, C.M.; Scott, D.; Gössling, S. Pandemics, transformations and tourism: Be careful what you wish for. *Tour. Geogr.* **2020**, *22*, 577–598. [CrossRef]
- Gössling, S.; Scott, D.; Hall, C.M. Pandemics, tourism and global change: A rapid assessment of COVID-19. *J. Sustain. Tour.* **2020**, *29*, 1–20. [CrossRef]
- Pappas, N.; Glyptou, K. Accommodation decision-making during the COVID-19 pandemic: Complexity insights from Greece. *Int. J. Hosp. Manag.* **2021**, *93*, 102767. [CrossRef]
- WHO. Coronavirus Disease (COVID-19) Dashboard. Available online: <https://covid19.who.int/> (accessed on 9 September 2020).
- Nazneen, S.; Hong, X.; Ud Din, N. COVID-19 crises and tourist travel risk perceptions. *SSRN Electron. J.* **2020**. [CrossRef]
- Reisinger, Y.; Mavondo, F. Travel anxiety and intentions to travel internationally: Implications of travel risk perception. *J. Travel Res.* **2005**, *43*, 212–225. [CrossRef]
- Novelli, M.; Gussing Burgess, L.; Jones, A.; Ritchie, B.W. “No Ebola . . . still doomed”—The Ebola-induced tourism crisis. *Ann. Tour. Res.* **2018**, *70*, 76–87. [CrossRef] [PubMed]
- Henderson, J.C.; Ng, A. Responding to crisis: Severe Acute Respiratory Syndrome (SARS) and hotels in Singapore. *Int. J. Tour. Res.* **2004**, *6*, 411–419. [CrossRef]
- Cahyanto, I.; Wiblishauser, M.; Pennington-Gray, L.; Schroeder, A. The dynamics of travel avoidance: The case of Ebola in the U.S. *Tour. Manag. Perspect.* **2016**, *20*, 195–203. [CrossRef] [PubMed]
- Choe, Y.; Wang, J.; Song, H. The impact of the Middle East Respiratory Syndrome Coronavirus on inbound tourism in South Korea toward sustainable tourism. *J. Sustain. Tour.* **2020**, *29*, 1117–1133. [CrossRef]
- Garg, A. Travel risks vs. tourist decision making: A tourist perspective. *Int. J. Hosp. Tour. Syst.* **2015**, *8*, 47–57. [CrossRef]
- Karl, M. Risk and uncertainty in travel decision-making: Tourist and destination perspective. *J. Travel Res.* **2018**, *57*, 129–146. [CrossRef]
- Crompton, J.L. An assessment of the image of Mexico as a vacation destination and the influence of geographical location upon that image. *J. Travel Res.* **1979**, *17*, 18–23. [CrossRef]
- Kim, D.; Perdue, R.R. The influence of image on destination attractiveness. *J. Travel Tour. Mark.* **2011**, *28*, 225–239. [CrossRef]
- Hu, Y.; Ritchie, J.R.B. Measuring destination attractiveness: A contextual approach. *J. Travel Res.* **1993**, *32*, 25–34. [CrossRef]
- Floyd, M.F.; Pennington-Gray, L. Profiling risk perceptions of tourists. *Ann. Tour. Res.* **2004**, *31*, 1051–1054. [CrossRef]
- Shaikh, A.S.; Dars, A.; Memon, K.; Kazi, A.G. A study of factors affecting travel decision making of tourists. *J. Econ. Info* **2020**, *7*, 1–10. [CrossRef]
- Wen, J.; Wang, C.C.; Kozak, M. Post-COVID-19 Chinese Domestic Tourism Market Recovery: Potential Influence of Traditional Chinese Medicine on Tourist Behaviour. *Anatolia* **2021**, *32*, 121–125. [CrossRef]
- Ajzen, I. The theory of planned behavior. *Organ. Behav. Hum. Decis. Process.* **1991**, *50*, 179–211. [CrossRef]

25. Afshardoost, M.; Eshaghi, M.S. Destination image and tourist behavioural intentions: A meta-analysis. *Tour. Manag.* **2020**, *81*, 104154. [CrossRef]
26. Caber, M.; González-Rodríguez, M.R.; Albayrak, T.; Simonetti, B. Does perceived risk really matter in travel behaviour? *J. Vacat. Mark.* **2020**, *26*, 334–353. [CrossRef]
27. Khan, M.J.; Chelliah, S.; Ahmed, S. Factors influencing destination image and visit intention among young women travellers: Role of travel motivation, perceived risks, and travel constraints. *Asia Pac. J. Tour. Res.* **2017**, *22*, 1139–1155. [CrossRef]
28. Styliadis, D.; Belhassen, Y.; Shani, A. Destination image, on-site experience and behavioural intentions: Path analytic validation of a marketing model on domestic tourists. *Curr. Issues Tour.* **2017**, *20*, 1653–1670. [CrossRef]
29. Chung, N.; Kwon, S.J. Effect of trust level on mobile banking satisfaction: A multi-group analysis of information system success instruments. *Behav. Inf. Technol.* **2009**, *28*, 549–562. [CrossRef]
30. Marinao Artigas, E.; Yrigoyen, C.C.; Moraga, E.T.; Villalón, C.B. Determinants of trust towards tourist destinations. *J. Destin. Mark. Manag.* **2017**, *6*, 327–334. [CrossRef]
31. Loureiro, S.M.C.; González, F.J.M. The importance of quality, satisfaction, trust, and image in relation to rural tourist loyalty. *J. Travel Tour. Mark.* **2008**, *25*, 117–136. [CrossRef]
32. Chien, P.M.; Sharifpour, M.; Ritchie, B.W.; Watson, B. Travelers' health risk perceptions and protective behavior: A psychological approach. *J. Travel Res.* **2017**, *56*, 744–759. [CrossRef]
33. Li, J.; Nguyen, T.H.H.; Coca-Stefaniak, J.A. Coronavirus impacts on post-pandemic planned travel behaviours. *Ann. Tour. Res.* **2021**, *86*, 102964. [CrossRef] [PubMed]
34. Bhati, A.S.; Mohammadi, Z.; Agarwal, M.; Kamble, Z.; Donough-Tan, G. Motivating or manipulating: The influence of health-protective behaviour and media engagement on Post-COVID-19 travel. *Curr. Issues Tour.* **2020**, *24*, 2088–2092. [CrossRef]
35. Mohammed Abubakar, A. Does EWOM influence destination trust and travel intention: A medical tourism perspective. *Econ. Res. Istraživanja* **2016**, *29*, 598–611. [CrossRef]
36. Zheng, D.; Luo, Q.; Ritchie, B.W. Afraid to travel after COVID-19? Self-protection, coping and resilience against pandemic “travel fear”. *Tour. Manag.* **2021**, *83*, 104261. [CrossRef]
37. Jensen, S.; Svendsen, G.T. Social trust, safety and the choice of tourist destination. *Bus. Manag. Horiz.* **2016**, *4*, 1–9. [CrossRef]
38. Abraham, V.; Bremser, K.; Carreno, M.; Crowley-Cyr, L.; Moreno, M. Exploring the consequences of COVID-19 on tourist behaviors: Perceived travel risk, animosity and intentions to travel. *Tour. Rev.* **2020**, *76*, 701–717. [CrossRef]
39. Bish, A.; Michie, S. Demographic and attitudinal determinants of protective behaviours during a pandemic: A review. *Br. J. Health Psychol.* **2010**, *15*, 797–824. [CrossRef]
40. Liao, Q.; Cowling, B.; Lam, W.T.; Ng, M.W.; Fielding, R. Situational awareness and health protective responses to pandemic influenza a (H1N1) in Hong Kong: A cross-sectional study. *PLoS ONE* **2010**, *5*, e13350. [CrossRef]
41. Uddin, S.; Imam, T.; Khushi, M.; Khan, A.; Moni, M.A. How did socio-demographic status and personal attributes influence compliance to COVID-19 preventive behaviours during the early outbreak in Japan? Lessons for pandemic management. *Pers. Individ. Dif.* **2021**, *175*, 110692. [CrossRef]
42. Lee, C.K.; Song, H.J.; Bendle, L.J.; Kim, M.J.; Han, H. The impact of non-pharmaceutical interventions for 2009 H1N1 influenza on travel intentions: A model of goal-directed behavior. *Tour. Manag.* **2012**, *33*, 89–99. [CrossRef] [PubMed]
43. Boto-García, D.; Leoni, V. Exposure to COVID-19 and travel intentions: Evidence from Spain. *Tour. Econ.* **2021**. [CrossRef]
44. Peng, J.; Xiao, H. How does smog influence domestic tourism in China? A case study of Beijing. *Asia Pac. J. Tour. Res.* **2018**, *23*, 1115–1128. [CrossRef]
45. Bratić, M.; Radivojević, A.; Stojiljković, N.; Simović, O.; Juvan, E.; Lesjak, M.; Podovšovnik, E. Should I stay or should I go? Tourists' COVID-19 risk perception and vacation behavior shift. *Sustainability* **2021**, *13*, 3573. [CrossRef]
46. Gössling, S.; McCabe, S.; Chen, N. (Chris) A socio-psychological conceptualisation of overtourism. *Ann. Tour. Res.* **2020**, *84*, 102976. [CrossRef]
47. Kim, Y.-J.; Kang, S.-W. Perceived crowding and risk perception according to leisure activity type during COVID-19 using spatial proximity. *Int. J. Environ. Res. Public Health* **2021**, *18*, 457. [CrossRef]
48. Moreno-González, A.A.; León, C.J.; Fernández-Hernández, C. Health destination image: The influence of public health management and well-being conditions. *J. Destin. Mark. Manag.* **2020**, *16*, 100430. [CrossRef]
49. Xie, C.; Zhang, J.; Morrison, A.M. Developing a scale to measure tourist perceived safety. *J. Travel Res.* **2020**, *60*, 1232–1251. [CrossRef]
50. Plucker, J.A. Exploratory and confirmatory factor analysis in gifted education: Examples with self-concept data. *J. Educ. Gift.* **2003**, *27*, 20–35. [CrossRef]
51. Brown, G.T.L.; Harris, L.R.; O'Quin, C.; Lane, K.E. Using multi-group confirmatory factor analysis to evaluate cross-cultural research: Identifying and understanding non-invariance. *Int. J. Res. Method Educ.* **2017**, *40*, 66–90. [CrossRef]
52. Hinkin, T.R. A brief tutorial on the development of measures for use in survey questionnaires. *Organ. Res. Methods* **1998**, *1*, 104–121. [CrossRef]
53. Hair, J.F.; Black, W.C.; Babin, B.J.; Anderson, R.E. *Multivariate Data Analysis*, 7th ed.; Pearson Education: London, UK, 2010.
54. Hu, L.; Bentler, P.M. Fit indices in covariance structure modeling: Sensitivity to underparameterized model misspecification. *Psychol. Methods* **1998**, *3*, 424–453. [CrossRef]
55. Kline, R.B. *Principles and Practice of Structural Equation Modeling*, 2nd ed.; Guilford Press: New York, NY, USA, 2005.



56. Kline, R.B. *Principles and Practice of Structural Equation Modeling*, 4th ed.; Guilford Press: New York, NY, USA, 2016.
57. Fornell, C.; Larcker, D.F. Evaluating structural equation models with unobservable variables and measurement error. *J. Mark. Res.* **1981**, *18*, 39. [CrossRef]
58. Xu, H.; Tracey, T.J.G. Use of multi-group confirmatory factor analysis in examining measurement invariance in counseling psychology research. *Eur. J. Couns. Psychol.* **2017**, *6*, 75–82. [CrossRef]
59. Aliperti, G.; Cruz, A.M. Investigating tourists' risk information processing. *Ann. Tour. Res.* **2019**, *79*, 102803. [CrossRef]
60. Turnšek, M.; Brumen, B.; Rangus, M.; Gorenak, M.; Mekinc, J.; Lešnik Štuhec, T. Perceived threat of COVID-19 and future travel avoidance: Results From an Early Convenient Sample in Slovenia. *Acad. Tur.* **2020**, *13*, 3–19. [CrossRef]
61. Orîndaru, A.; Popescu, M.-F.; Alexoaei, A.P.; Căescu, Ș.-C.; Florescu, M.S.; Orzan, A.-O. Tourism in a post-COVID-19 era: Sustainable strategies for industry's recovery. *Sustainability* **2021**, *13*, 6781. [CrossRef]
62. Hsu, S.-C.; Lin, C.-T.; Lee, C. Measuring the effect of outbound Chinese tourists travel decision-making through tourism destination image and travel safety and security. *J. Inf. Optim. Sci.* **2017**, *38*, 559–584. [CrossRef]
63. Wen, Z.; Huimin, G.; Kavanaugh, R.R. The impacts of SARS on the consumer behaviour of Chinese domestic tourists. *Curr. Issues Tour.* **2005**, *8*, 22–38. [CrossRef]
64. Mertzanis, C.; Papastathopoulos, A. Epidemiological susceptibility risk and tourist flows around the world. *Ann. Tour. Res.* **2021**, *86*, 103095. [CrossRef]
65. Rončák, M.; Scholz, P.; Linderová, I. Safety concerns and travel behavior of generation Z: Case study from the Czech Republic. *Sustainability* **2021**, *13*, 13439. [CrossRef]
66. Dryhurst, S.; Schneider, C.R.; Kerr, J.; Freeman, A.L.J.; Recchia, G.; van der Bles, A.M.; Spiegelhalter, D.; van der Linden, S. Risk Perceptions of COVID-19 around the world. *J. Risk Res.* **2020**, *23*, 994–1006. [CrossRef]
67. Moreno-Luna, L.; Robina-Ramírez, R.; Sánchez, M.S.-O.; Castro-Serrano, J. Tourism and sustainability in times of COVID-19: The case of Spain. *Int. J. Environ. Res. Public Health* **2021**, *18*, 1859. [CrossRef] [PubMed]
68. Hassan, T.H.; Salem, A.E. The importance of safety and security measures at Sharm El Sheikh Airport and their impact on travel decisions after restarting aviation during the COVID-19 outbreak. *Sustainability* **2021**, *13*, 5216. [CrossRef]
69. Țuclea, C.-E.; Vrânceanu, D.-M.; Năstase, C.-E. The role of social media in health safety evaluation of a tourism destination throughout the travel planning process. *Sustainability* **2020**, *12*, 6661. [CrossRef]
70. UNWTO. International Tourist Numbers Could Fall 60–80% in 2020, UNWTO Reports. Available online: <https://www.unwto.org/news/covid-19-international-tourist-numbers-could-fall-60-80-in-2020> (accessed on 9 September 2020).
71. Williams, N.L.; Wassler, P.; Ferdinand, N. Tourism and the COVID-(Mis)Infodemic. *J. Travel Res.* **2020**, *61*, 214–218. [CrossRef]
72. Araújo-Vila, N.; Fraiz-Brea, J.A.; Pereira, A.M. Societal changes due to “COVID-19”. An analysis of the tourism sector of Galicia, Spain. *Sustainability* **2021**, *13*, 8449. [CrossRef]

## Article

# The Bridge at the End of the World: Linking Expat's Pandemic Fatigue, Travel FOMO, Destination Crisis Marketing, and Vaxication for "Greatest of All Trips"

Umer Zaman <sup>1,\*</sup>, Stuart J. Barnes <sup>2</sup>, Saba Abbasi <sup>3</sup>, Mahwish Anjam <sup>4</sup>, Murat Aktan <sup>5</sup>  
and Muddasar Ghani Khwaja <sup>6</sup>

<sup>1</sup> Endicott College of International Studies (ECIS), Woosong University, Daejeon 34606, Korea

<sup>2</sup> Marketing, Operations and Systems Group, Newcastle University Business School, Newcastle University, 5 Barrack Road, Newcastle upon Tyne NE1 4SE, UK; stuart.barnes@newcastle.ac.uk

<sup>3</sup> Department of Management Sciences, National University of Modern Languages (NUML), Islamabad 44000, Pakistan; abbasi.saba56@gmail.com

<sup>4</sup> College of Business Studies, Al-Ghurair University, Dubai 37374, United Arab Emirates; m.anjum@agu.ac.ae

<sup>5</sup> Faculty of Economics and Administrative Sciences, Mugla Sitki Kocman University, Mugla 88000, Turkey; murataktan@mu.edu.tr

<sup>6</sup> Departamento Académico de Ciencias de la Gestión-Sección Gestión, Pontificia Universidad Católica del Perú, San Miguel, Lima 15088, Peru; khawajamuddasar@gmail.com

\* Correspondence: umerzaman@endicott.ac.kr



**Citation:** Zaman, U.; Barnes, S.J.; Abbasi, S.; Anjam, M.; Aktan, M.; Khwaja, M.G. The Bridge at the End of the World: Linking Expat's Pandemic Fatigue, Travel FOMO, Destination Crisis Marketing, and Vaxication for "Greatest of All Trips". *Sustainability* **2022**, *14*, 2312. <https://doi.org/10.3390/su14042312>

Academic Editors: Zygmunt Kruczek and Bartłomiej Walas

Received: 20 January 2022

Accepted: 15 February 2022

Published: 17 February 2022

**Publisher's Note:** MDPI stays neutral with regard to jurisdictional claims in published maps and institutional affiliations.

**Abstract:** The rebirth of global tourism with a massive rebound is anticipated due to an emerging touristic behavior coined as vaxication (i.e., post-vaccination travel). Despite the ongoing fatigue triggered by the COVID-19 pandemic, travelers' fear of missing out (FOMO), and destination crisis marketing (DCM) can further accelerate travelers' momentum towards vaxication. To address this critical knowledge gap in COVID-19 tourism, the present study aimed to examine the effect of pandemic fatigue on vaxication intention for the greatest of all trips (GOAT) under the moderating influence of travel FOMO and destination crisis marketing. Drawing on data of international expatriates in the United Arab Emirates (N = 356) and using covariance-based structural equation modeling with Mplus, the findings provide new evidence supporting a positive impact of international expat's pandemic fatigue on vaxication intention for GOAT. Interestingly, this relationship is significantly reinforced by the international expat's travel FOMO as well as tourism destinations switching gears from 'managing crisis' to 'marketing crisis'. Based on prominent theories (i.e., theory of planned behavior, cognitive load theory, and protection motivation theory) and newly developed scales (i.e., travel FOMO and destination crisis marketing), the study implications are directed towards an out-pacing trajectory of global tourism return prompted by pandemic fatigue, travel FOMO, destination crisis marketing, and vaxication intention for the greatest of all trips.

**Keywords:** pandemic fatigue; travelers' fear of missing out (FOMO); destination crisis marketing; post-COVID-19 tourism; vaxication intention; greatest of all trips (GOAT); international expats; theory of planned behavior; cognitive load theory; protection motivation theory



**Copyright:** © 2022 by the authors. Licensee MDPI, Basel, Switzerland. This article is an open access article distributed under the terms and conditions of the Creative Commons Attribution (CC BY) license (<https://creativecommons.org/licenses/by/4.0/>).

## 1. Introduction

The growing travel optimism (e.g., travelers' belief that the worst of the pandemic is behind us) may still be premature, owing to the existent gap between travelers' expectations and the host destinations' restricted realities [1,2]. Reckless crisis marketing by destinations could create an inevitable risk even for the vaccinated travelers (including those who received their third/booster dose), as they might not be fully immune to the latest twist in the COVID-19 outbreaks (e.g., surge of omicron among the fully vaccinated) [3,4]. Despite the uncontrolled and chaotic outbreak of new COVID-19 variants (e.g., delta and omicron), the desire to travel remains significant across the globe [1–3]. The global tourism in the

midst of the pandemic mirrored a USD 4.5 trillion loss in tourism revenues, including a massive decline of 74 percent in international arrivals, an unconditional halt on mass gatherings (e.g., festivals, music concerts, and sporting events), closure of public facilities (e.g., gyms and museums), and restrained leisure activities (e.g., highly restrictive travel and tourism) [1–4]. The induction of COVID-19 restrictions and forced lockdowns made the situation worse for everyone posing severe threats to psychological and cognitive health [2]. Among various types of psychological distress, pandemic fatigue is one of the alarming consequences triggered by the prolonged COVID-19 pandemic. The constant fear of being infected, the continuous press and public discussions about COVID-19, the uncertain and evolving circumstances, and last but not least, forced lockdowns for an unknown period caused emotional exhaustion and mental fatigue across the globe [3]. The antecedents and outcomes of the COVID-19 pandemic fatigue have been recently explored [4–6]. Travel and tourism (being a constitutive force in everyday life) offer an escape from daily routine to refresh the mental state and uplift the subconscious morale [7]. However, travel closure has left emotionally exhausted and fatigued individuals with no obvious choices to escape the lockdowns and restrictions of the pandemic. As soon as the COVID-19 vaccines became a reality (e.g., the arrival of Pfizer, AstraZeneca, and Moderna vaccines), the idea of relaxing travel restrictions (subject to COVID-19 vaccination) became more viable [8,9], hence signaling a beacon of hope to kickstart global travel.

Fully vaccinated travelers are expected to face lesser barriers (e.g., facilitated and/or smooth entry at host destinations) as compared to unvaccinated (or partially vaccinated) travelers, who are obligated to undergo mandatory quarantines and have a negative PCR COVID-19 test [8–10]. These explicit conditions gave birth to a new phenomenon of “vaxication” (“vaxi-” from “vaccination” and “-cation” from “vacation”) [9,10]. Vaxication (referred to as the first vacation after vaccination) also commemorates special offers and incentives from tourism destinations to fully vaccinated travelers [9]. Consequently, individuals experiencing pandemic fatigue are incited to get fully vaccinated to resurrect their long-awaited travel. The emerging vaxication trend in response to the pandemic fatigue indicates a possible connection between the two tenets of tourism under (and after) COVID-19 [3,9]. Travel planners are stimulated to deploy crisis marketing campaigns using vaccine and vacation advertising bundles to encourage immunization among wishful travelers [10,11].

The COVID-19 pandemic has not reached its endgame yet, whereas the global vaxication drive is still on the move. Hence, the influential role (and repercussions) of touristic behaviors toward vaxication requires immediate scholarly attention [9]. Vaxication has emerged as a promising touristic behavior with the ability to resurrect global tourism by ensuring the required healthcare and protective measures (e.g., vaccine passports) to visit a preferred destination [12,13]. However, the concept of vaxication remains largely ignored and under-investigated in the COVID tourism and consumer behavior research [9]. The underlying relationship between pandemic fatigue and vaxication intention could possibly be influenced by multiple cognitive states and real-world iterations as a consequence of the various phases (and conditions) of the COVID-19 pandemic [4]. Relating to the cognitive phenomenon, travelers’ fear of missing out (FOMO) is a psychological state of anxiety and over-concern of missing out on the chance of traveling to a favorable destination [14]. FOMO has been explored in different domains of consumer behavior (e.g., educational activities and sporting events) [15–20]; however, the role of travel FOMO within the discrete and complex choices of tourism products and services remains largely unknown. In order to experience vaxication, travelers experiencing FOMO might be more willing to get vaccinated, as they are overly concerned with missing out on a travel opportunity just because of non-vaccination [21].

Similarly, destination crisis marketing can mobilize travelers towards vaxication intention while they find ways to overcome their pandemic fatigue [4,11]. Destination crisis marketing refers to a set of communications aligned with the travelers’ unwavering expectations about destinations (e.g., authenticity, transparency, empathy, humility, creativity, and

optimism) during a crisis (e.g., COVID-19 pandemic) [11]. By enduring crisis marketing strategies, tourism destinations can generate high appeal among travelers for their first trip after vaccination [11,22]. Alternatively, ignorance of destination crisis marketing can impose a lack of destination visibility and preparedness for hosting a safe tourism experience [23]. Consequently, travelers in search of vacation for the greatest of all trips (i.e., first mega trip after vaccination) are inclined to cancel their plans for a destination that seems insensitive and/or irresponsible in dealing with the pandemic crisis. The travel presence and perspectives of international expatriates play an influential role in the development and restoration of global tourism. The international expats' community serves as a critical foundation in reframing destinations as worldwide centers of tourism attractiveness [24,25]. Moreover, expats are regarded as trustworthy information hubs, as they become vital collaborators in destination marketing initiatives across the globe [4,26]. The significance of international expats' is particularly heightened in developing nations, which are frequently exposed to socio-political unrest and violent conflicts [27,28]. Given the growing importance of expats in branding nations as safe, popular, and attractive destinations for tourism [4,26], the present study aimed to unfold the effect of expats' pandemic fatigue on their vacation intention for the greatest of all trips (GOAT), under the moderating influence of travel FOMO and destination crisis marketing.

## 2. Theoretical Background and Hypotheses Development

### 2.1. International Expat's Pandemic Fatigue

To assess the repercussions of the COVID-19 outbreak, a lot of focus has been put into its health and psychological effects on the thinking, decisions, and actions of individuals undergoing the pandemic's adverse experiences [4]. Pandemic fatigue is one of the most notable and persistent impacts of COVID restrictions, regulations, and lockdowns on human psychology. The World Health Organization described it as a set of rational and predictable behaviors of humans in response to long-term, unsettled disasters and crises [4,29]. It is a psychological state of extensively feeling isolated, tense, and demotivated that develops over time as a result of a variety of circumstances, notably drastic changes in personal experiences, surrounding and environment, community interactions, and social systems. Pandemic fatigue has been studied in different contexts and focus groups. MacIntyre et al. [30] studied the induction and intensity of this psychological phenomenon in different age groups. The authors concluded that young individuals are more likely to experience pandemic fatigue due to decreased opportunities for socializing and traveling. Focusing on the expat community, Zaman et al. [4] investigated the effects of pandemic fatigue (PF) in the travel and tourism context, where PF was found to stimulate revenge travel behavior among the expat community. Speaking of expats, their role as a strategic partner and vital stakeholder for tourism marketing has been well recognized, especially due to their deeper and superior knowledge about destinations [4,26].

In contrast to occasional travelers who likely suffer from stereotypes and first-time expressions, expats can be deemed as long-term tourists who have literally built their lives in a foreign land, therefore being immersed in the local culture and traditions. In essence, expats are always reliable sources of information for their fellow homeland citizens as well as for international travelers, especially when destinations go through major crises, such as the COVID-19 global pandemic [4,26]. As previously said, PF affects people's state of mind and psychological wellbeing, leading to behavioral acclimatization in order to adjust to the "new reality". As a result, the pandemic has resulted in long-term changes in consumer purchasing habits, consumer preferences, and business strategies [31]. Consumers have evolved various behaviors to govern their sentiments and well-being caused by apparent uncertainty and protracted lockdowns. For example, most customers are aware of emerging e-commerce platforms, have switched from their once famous supermarkets, and have adopted alternate consumption behaviors and platforms [32,33]. PF has caused economic and social instability in the tourism sector. People perceive travel as an escape from everyday routines and the psychological load of the epidemic during continuous

lockdowns [34]. As a result of the epidemic, many individuals have adjusted their travel plans, flocking to remote and rural regions to avoid the virus and enjoy time in the natural world [35]. With the urge to escape from this captivity, people are inclined to make such bold decisions that were unlikely to be considered in normal conditions. For example, some people may hesitate to take vaccination for COVID-19, but due to its imperative status for traveling, they are likely to pursue it [9]. Pandemic fatigue can be best explained from the lens of cognitive load theory (CLT) by Sweller [36]. The theory provides a fundamental paradigm for comprehending how the outbreak may be affecting people's psychological performance in many ways. The COVID-19 pandemic has also introduced new modes of performing routine tasks, which require additional information and resources, thus adding to the overall stress level. Secondly, the dynamic and uncertain conditions distracting from daily life add to the extraneous cognitive load [34–36].

## 2.2. *Vaxication Intention for "Greatest of All Trips"*

The travel trend report recently released by Expedia highlighted a dominant touristic mindset that seeks the "greatest of all trips" (referred to as GOAT) involving unique tourism aspirations, including (1) scrapping the schedule, (2) splurge-cation, (3) immersive discovery, (4) sensation seeking, and (5) unfiltered enjoyment [37]. In addition, a new concept ("vaxication") has also emerged in the midst of the COVID-19 pandemic by blending two desirable practices—vaccination and vacation. Vaxication intention refers to an individual's desire to go on a vacation after being fully vaccinated for COVID-19 [9]. As vaccination is more of a necessity than a choice for vacation travel, the surge in the trend of vaxication is an indicator of a much-needed boost in reviving the travel and tourism industry [4,9].

In the seemingly post-acceleration phase of COVID-19, when the pandemic spread is either in the stationary or decline phase, the lockdowns and regulations are becoming relaxed gradually. Additionally, owing to the advent of multiple immunization options (e.g., types of COVID-19 vaccines), the situation has been eased out to some extent; therefore, everyday life is expected to return to normalcy [4,9]. The general practices of social freedom, tourism, and traveling are also anticipated to rejuvenate as soon as the majority of the global population is immunized against COVID-19. Hence, immunity from COVID-19 is becoming a mandatory status for multiple social activities and, more specifically, tourism activities such as traveling from one country to another, vacation traveling, and even inter-city/state traveling in some countries [9]. In the case of global tourism, although vaccination for COVID-19 has been regulated as a requirement, it is regarded more as a social need than legal binding [10].

Being a newly emerging concept, vaxication has yet to be extensively examined in post-COVID tourism research. Zaman et al. [9] empirically validated that COVID-19 branded destination safety (CBDS) boosts vaxication intention while travel shaming and travel incentives act as significant moderators of the relationship. Theoretically, vaxication intention can be explained by some of the prominent theories related to psychology, human behavior, and healthcare. The theory of planned behaviors [38] provides a justification for the health and well-being concerns of travelers dictating their decision of pre-travel vaccination (vaxication) and choice of safer/COVID-free destination [39]. Similarly, the protection motivation theory [40] also provides theoretical reinforcement to the concept of vaxication. The theory proposes that the two factors, i.e., an apparent threat (i.e., COVID-19 exposure) and a possible enduring measure (i.e., vaccination), are the direct influencers of people's decision-making process when facing protection and safety concerns (i.e., when planning for tours or vacations). Wang et al. [41] also highlighted the health-related choices of travelers under the influence of the protection motivation theory. An individual's vaxication drive can be better explained through the theoretical lens of planned behavior [42]. The theory of planned behavior defines human actions as an outcome of the association between one's attitude, perceived control over his/her behavior, and social norms. Therefore, one's vaxication behavior can be justified by his/her positive attitude

toward traveling during the pandemic and the vaccine's perceived benefit in the prevention of the infection. Although the concept of vaccination is still evolving, it shows promise in boosting post-COVID tourism [9].

### 2.3. Travel Fear of Missing Out (FOMO)

Travel FOMO refers to the individual's fear of missing out on travel opportunities and experiences, especially when others (e.g., friends and family) are (or may be suspected of) traveling [14,43,44]. FOMO can be conceptualized by the self-determination theory [45], which explains the three inherent psychological needs of humans: relatedness, autonomy, and competence. Individuals who are less satisfied with their psychological needs have evidenced higher FOMO [14], and according to the theory, if these needs are satisfied, individuals are capable of self-determination and thus have less FOMO. Among several generic psychological impacts of the COVID-19 pandemic, the fear of missing out (FOMO) is one of the most visible and influential psychological phenomena. Although the FOMO concept was originally introduced in a completely different domain [14], it perfectly synchronizes with the COVID-19 (and post-COVID) tourism industry when considering the traveler's fear of missing out on opportunities of socializing, traveling, and adventure [4,14].

FOMO is a feeling of anxiety and apprehension of an individual (e.g., prospective travelers) who experience the fear of missing out on a chance of any event of satisfaction, social interaction, or something that satisfies their personal needs. The FOMO concept has been applied to different contexts in previous studies [14,19,20,43,44]. Initially, Przybylski et al. [14] explained FOMO in a psychological context and developed the construct to measure FOMO. Alt [20] explored FOMO among adolescents and its connection with their learning approach. In another study, Alt et al. [19] explored the FOMO effect on college student's social media engagement [19]. Abel et al. [43] concentrated their research on the relationship between the degree of social media consumption and levels of FOMO. Similarly, this psychological concept has been studied in different contextual settings [15–18]; however, it has not been particularly applied in the travel and tourism context. The present study is the first effort of integrating fear of missing out (FOMO) in the domain of travel and tourism, thus forming a new concept of travel FOMO [43].

### 2.4. Destination Crisis Marketing

Crisis marketing is a set of marketing strategies to successfully lead a business out of a crisis while securing its strong and long-term future [11]. Integrated into the tourism industry, crisis marketing is the use of marketing strategies by tourism destinations as measures of survival (and subsequent revival) when faced with a crisis [11,46]. The fusion of crisis marketing with destination marketing gives birth to destination crisis marketing—a useful business tool for the revival of tourism and attracting prospective travelers during (and after) a crisis [11]. The concept of crisis marketing in the era of COVID-19 tourism relates to the efforts of travel and hospitality businesses as well as governments to promote their destinations in a way that travelers are fully aware of the pandemic conditions, availability of services, and responsiveness of the host destinations (e.g., authenticity, transparency, empathy, humility, creativity, and optimism) during the crisis [11,47]. For example, if a country plans to re-open tourism for locals as well as global travelers, then the government and tourism planners should devise effective crisis marketing strategies (e.g., digital online campaigns) to promote their destination as safe and responsive during the crisis [11,48]. Although the strategies adopted during crisis marketing mainly depend on the nature of the disaster or crisis, the prime purpose remains the same that is, to ensure the survival of a business during a crisis and revival after it, instead of making massive profits on the cost of people's life and healthcare risk. Several studies have focused on finding the pathways for the revival of global tourism by marketing destinations as safe during the COVID-19 crisis [11,46–48].

Glyptou [46] focused on the restoration and co-creation of destination image in recovery from the COVID-19 crisis. Similarly, Ahmad et al. [47] empirically highlighted the

positive effect of destination image and visit intentions of the travelers in the post-pandemic tourism industry. A recent study by Singh et al. [48] emphasized the availability of COVID-related information, staff vaccination details, outdoor spaces show-off, and post-pandemic schedules as a key factor to attract travelers in the recovery phase. In post-COVID-19 tourism, when the indicators of business revival start to shine and the industry begins to bloom once again, different marketing practices can be used to influence the decision-making of travelers while selecting a tourism destination. In another study, Iso-Ahola's theory of motivation was employed in the context of the tourism industry, highlighting a higher level of motivation was desirable for thrilling tourism experiences [49]. Moreover, the authors also argued that recreational events and tourism are driven by personal getaways, individual striving, social retreat, and interpersonal relationships.

### 2.5. *International Expat's Pandemic Fatigue and Vaccination Intention for GOAT*

The restrictions and lockdown during COVID-19 posed several adverse impacts on the psychological health of the people. The new routines, economic uncertainty, unsteady pandemic situations, and continuous risk of being exposed to the pandemic caused anxiety and unrestful state of mind in the general masses [4]. Considering the expats' community, the situation becomes worse as it is difficult for even natives to stay at home for an extended period. With the relaxation in lockdowns and travel restrictions, people with traveling interests are more eager to plan vacations and tours to make up for the lost time [4,9]. As studied by Zaman et al. [4], pandemic fatigue has a significant positive effect on revenge travel among the expat community, where revenge travel refers to planning tours and vacations in response to COVID-19 lockdowns to escape from the exhausting routine.

The theory of planned behavior asserts that human behavior is the product of one's perception of the current conditions and one's response to those conditions [50]. The severe conditions caused by the pandemic initially had an adverse psychological impact on global tourism. However, the advent of vaccines has eased travel restrictions, hence contributing to the normalization of the tourism industry along with other aspects of our daily lives [9]. In other words, the vaccines helped in reducing people's health risk perceptions, and subsequently, intentions to make up for the lost time during the pandemic were increased. This phenomenon could also be explained by the protection motivation theory, which posits that human actions and decisions are affected by their perceived threats and coping capabilities against those threats [9,40]. The fact that global vaccination campaigns have reduced the individuals' health risk perceptions while increasing their perceived coping abilities (i.e., behavioral control), many people have started to plan their very next vacations to immerse themselves in new and meaningful experiences. Since vaccination has become a legal requirement and a prerequisite for traveling, people are also left no choice but to get vaccinated in order to travel again to global tourism destinations [9]. Therefore, one can argue that once being suffered from the pandemic, individuals (e.g., expats experiencing the pandemic fatigue more than natives) will practice vaccination (i.e., take vaccination before vacation) to be able to set out on their greatest trip ever [4,9]. Based on these theoretical arguments, the first hypothesis is generated as:

**Hypothesis 1 (H1).** *International expats' pandemic fatigue has a significant positive effect on the vaccination intention for GOAT.*

### 2.6. *Moderating Influence of Travel FOMO*

The psychological concept of FOMO, when applied to the tourism industry, relates to the irrational anxiety of travelers missing opportunities for vacation travel and socializing [4,14,43]. Having already been exhausted from lockdowns and restrictions, people desire to avenge their lost time and engage in tourism activities [4,14,51]. However, international traveling can only occur when the travelers have received the required dosage of vaccines before traveling. In context, the anxiety and fear of missing out on the chance to travel are expected to fuel the individuals' desire to and willingness for vaccination. In a previous study, Bright and Logan [17]

asserted that FOMO has a significant influence on the feeling of deprivation; therefore, this cognitive appeal is expected to influence the decision-making process of travelers regarding vacation planning and destination selection (i.e., moderating the effects of pandemic fatigue on vaccination intentions for GOAT) [4]. In other words, despite experiencing pandemic fatigue, if a traveler does not feel much anxiety about missing out on travel opportunities, then he or she may postpone or even cancel the vacation travel plans, which ultimately avoids vaccination [4,9]. In contrast, if a person feels travel FOMO extensively, he or she may be more urged to practice vaccination, thus, affecting the relationship between expat's pandemic fatigue and vaccination intention for GOAT. This cognitive appeal, therefore, could act as a moderator on the relationship between expat's pandemic fatigue and vaccination intention for GOAT [4,9,14].

Applying the theoretical lens of stimulus-organism-response (SOR) theory [52], the proposed moderating impact of travel FOMO on the relationship between expat's pandemic fatigue and vaccination intention for GOAT can be substantiated. The SOR theory postulates that a stimulus event causes an emotional reaction, which subsequently induces a behavioral response. Furthermore, recent evidence has demonstrated that consumers' decision-making and purchasing behavior are significantly correlated to the extent of fear and greed emotions as a consequence of COVID-19 [21]. In a similar vein, Yan et al. [53] validated the role of psychological or emotional state in determining the effect of a stimulus on consumer behavior of either selection or rejection. Having discussed the theoretical explanations above, one could possibly argue that pandemic fatigue results in an emotional reaction (i.e., the fear of missing out on traveling opportunities), which will stimulate the behavioral response (i.e., the willingness to get vaccinated before traveling). Therefore, the second hypothesis for the present study is framed as follows.

**Hypothesis 2 (H2).** *Travel FOMO significantly and positively moderates the effects of international expats' pandemic fatigue on the vaccination intention for GOAT.*

### 2.7. Moderating Effects of Destination Crisis Marketing

Crisis marketing is a combination of business marketing strategies to ensure brand visibility and responsiveness during any crisis (e.g., COVID-19 pandemic) [11]. Destination crisis marketing in the midst of the COVID-19 pandemic would boost the visibility of vacation and travel locations for those who want to revenge travel [4,9,11]. Marketing destinations as "safe from COVID-19", "re-opened after the pandemic", or "first post-lockdown trip" and implementing travel incentives will most likely enhance people's travel intentions and, therefore, willingness to vaccination [4,9]. A positive destination image has been evidenced to have a positive link with a traveler's intention to visit, even in the midst of the COVID-19 pandemic [47]. For instance, if a person plans to refresh his/her mental health by traveling but cannot find a suitable location abroad due to the crisis mismanagement at those destinations, he/she could consider postponing or even canceling her/his travel plan, which eventually diminishes vaccination intention. Likewise, having been deprived of leisure activities (due to the ongoing pandemic), the destination choices during (and after) COVID-19, combined with effective destination crisis marketing strategies, could create greater interest for vaccination [9,11]. The destination marketing efforts during the COVID-19 crisis seem to have a direct influence on the relationship between expats' pandemic fatigue and vaccination intention for GOAT [9,11].

Destination crisis marketing in an influential moderating mechanism can also be theoretically explained by the psychological reactance theory [54], which highlights the consumption behaviors and purchasing patterns in uncertain (e.g., COVID-19) conditions [21]. According to the psychological reactance theory, the consumers will continue their first-choice behaviors if they feel the freedom of decision-making, whereas they will intend to do the opposite if they perceive threats to their freedom of choice [55]. Additionally, for pandemic tourism, an adverse consumption behavior such as "canceling or postponing a travel plan" arises when travelers face hindrance (i.e., poor destination crisis marketing) in



performing their first-choice behavior (selecting a good location/destination for vacation). This phenomenon can also be described by the popular theory of planned behavior [38], which asserts that the extent of people's perceived control will induce positive attitudes and behavior. Therefore, being able to find multiple destinations and feeling free to choose among them (i.e., belief part of the theory), travelers are motivated to choose the finest destination and go for the greatest of all trips (i.e., behavior part of the theory) [9,11,38]. In light of the above arguments, the third hypothesis of the research is framed as follows.

**Hypothesis 3 (H3).** *Destination crisis marketing significantly and positively moderates the effects of international expats' pandemic fatigue on the vaxication intention for GOAT.*

Based on the theoretical underpinning and scholarly evidence from prior research, the conceptualized model for the present study is graphically presented in Figure 1.

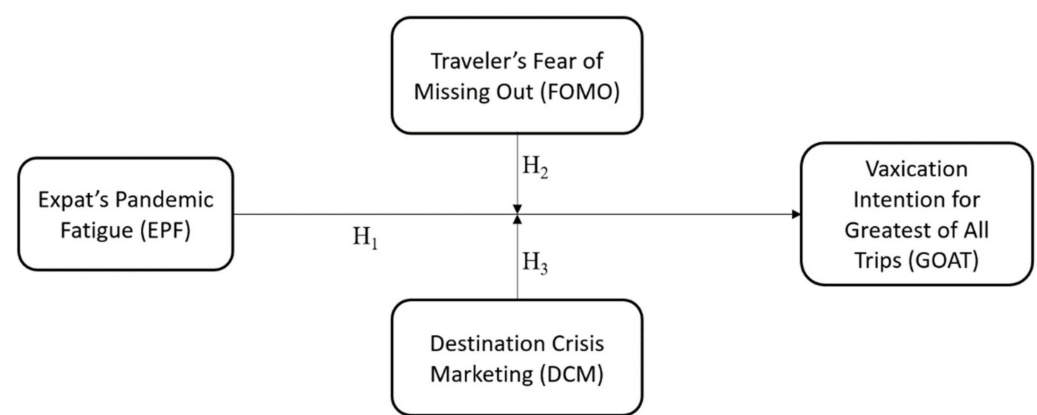

**Figure 1.** Conceptual model of Expats' Vaxication Intention for GOAT.

### 3. Materials and Methods

#### 3.1. Sampling and Procedure

The intended research objective of the present study was to investigate the conceptual model of vaxication intention for GOAT and its relationship with international expats' pandemic fatigue, travel fear of missing out (FOMO), and destination crisis marketing. The research population comprised members of the international expat's communities in United Arab Emirates (UAE), which provided the respondent's pool of volunteering participants (N = 450). Pilot testing was conducted with a subset of the initial pool (N = 60) to assess the understandability of the survey and included questions. The final pool of acceptable, adequate, and error-free surveys consisted of 356 responses. Owing to the rigorous COVID-19 regulations, data relevant to the international expats' community was obtained through direct emails, which involved the distribution of online surveys individually. We also included expats' social media groups, which limited face-to-face interactions. The volunteering international expats were searched and approached through different social media platforms (e.g., Facebook, LinkedIn, and WhatsApp, etc.), including NGO's and organizations working for foreigners in UAE, during mid-December 2021 (when the daily reported new cases of COVID-19 were less than 1000). In addition, the foreign embassies and permanent missions, as well as the international business community, were also contacted through emails. These selective strategies of accessing the initial pool of international expats and then selecting the final research sample were a combination of non-probability sampling methods, including purposive sampling and snowball sampling. Non-probability sampling has been extensively employed in earlier studies, and it has proven useful in similar contexts, especially when undertaken during a crisis [4,9]. The informed consent of volunteering expats was taken before the research, and their personal information was kept confidential throughout the research process. Moreover, sample coding was to avoid any chances of partiality in information handling or analysis.

### 3.2. Measures

The conceptual model of this study included a total of four latent constructs, namely expat's pandemic fatigue (independent variable), vaccination intention for greatest of all trips "GOAT" (dependent variable), travel fear of missing out "FOMO" (moderating variable), and destination crisis marketing (moderating variable), respectively. To measure these latent constructs, two scales were carefully developed (i.e., travel FOMO and DCM), while two scales were selectively adapted (i.e., expat's pandemic fatigue and vaccination intention for GOAT). Importantly, the psychometric scale properties were well established after review and constructive feedback taken from senior academics (n = 5) and tourism industry practitioners (n = 4). The "expat's pandemic fatigue" was measured with the help of a 9-item construct adapted from Zaman et al. [4], which inquired the expats about the level of tiredness and fatigue as a result of COVID-19 restrictions and bans, their constant dread of contagion, and the detrimental psychological impact of COVID-19 media and social conversations. The items were coded as EPF1-EPF9 and were set on a 5-point Likert scale where 1 represented strong disagreement and 5 indicated strong agreement. Similarly, vaccination intention for GOAT was measured using an adapted scale (including 7 items coded as VGOAT1-VGOAT7) from Zaman et al. [4] as well as guidance from prominent literature [9,37,56]. A 10-item construct was developed to measure Travel FOMO [15,16,20]. The items were designed on a 5-point Likert scale and were coded as TFOMO1-TFOMO10. Lastly, the destination crisis marketing construct (including 7-items coded as DCM1-DCM7) was also developed after an extensive literature review and guidance from seminal research on crisis communication, crisis marketing, destination crisis management, and tourism crisis communication, respectively [57–68].

### 3.3. Data Analysis

For a quantitative investigation of the formulated conceptual model, the covariance-based structural equation modeling (CB-SEM) approach was used [69]. The SEM method and its greatest applications have received a lot of scholarly attention across disciplines (e.g., tourism marketing, technology management, construction management, and project management). However, various studies have recommended the SEM approach depending on the type of variables and gathered data, while emphasizing the benefits of SEM over other techniques (e.g., higher reliability of path coefficients) [70,71]. SEM has been widely employed in cognitive and social studies [4,9], whereas CB-SEM is one of the dominant SEM methods that offers more reliable statistical estimations for model fitness, in contrast to the partial least squares structural equation modeling (PLS-SEM) [9]. Using the Mplus statistical program, the CB-SEM approach was applied to the study data (N = 356). Mplus provides a variety of time-saving, and convenient (user-friendly) statistical simulations for analytical solutions. In a simple layout, the Mplus software provides a number of techniques, simulations, and built-in programs. The use of diagrammatic forms to illustrate analyses and outcomes aids in the better presentation of work [72].

## 4. Results

### 4.1. Demographic Outcomes

The demographic classification of the respondent's final pool (N = 356) was carried out before the in-depth analysis of the conceptualized model of the study. Table 1 presents the summary of the demographic profiles of the respondents. It can be observed that the gender split of the sample is almost even with an exact 50% of the respondents belonging to the male gender, 46.3% as female, while 3.7% preferring not to disclose their gender. Further classification indicated that most of the respondents belonged to the age bracket of 31 to 35 years (31.5%), while 25–30 years had a second majority with 26.1% respondents. A total of 105 respondents (29.5%) had an annual income ranging from USD 50,001 to USD 75,000, and 23.9% respondents belonged to USD 25,001 to USD 50,000 group. The majority (i.e., 52.8%) of the respondents had a traveling frequency of one to two times per year, while 26.4% of respondents traveled around three to five times each year (before the COVID-19

pandemic). The research sample is a fine mix of multidimensional demographics; therefore, evenly distributed and impartial data can be expected from this sample. Moreover, the sample also represents the general population demographics of expats in the UAE [73], so the findings of this study can be expected to have a good generalization potential.

**Table 1.** Demographic Profiles of International Expats (N = 356).

Items	Frequency	Percentage	
Gender	Male	178	50.0%
	Female	165	46.3%
	Prefer not to say	13	3.7%
Age	18–24 years	57	16.0%
	25–30 years	93	26.1%
	31–35 years	112	31.5%
	36–40 years	59	16.6%
	41–45 years	27	7.6%
	46 years and above	8	2.2%
	Annual Income (equivalent in USD)	USD 25,000 or less	59
	USD 25,001–USD 50,000	85	23.9%
	USD 50,001–USD 75,000	105	29.5%
	USD 75,001–USD 100,000	65	18.3%
	USD 100,001–USD 150,000	32	8.9%
	USD 150,001 and above	10	2.8%
Frequency of vacation travel before COVID-19	Once or twice per year	188	52.8%
	Three to five times per year	94	26.4%
	Six to eight times a year	59	16.6%
	More than nine times a year	15	4.2%

#### 4.2. Data Normality

After demographic classification, the initial analysis included tests for data normality and common method bias. The presence of outliers, normality, missing values, and multicollinearity was assessed in the initial part of the analysis. Table 2 provides the outcomes of the data normality test and descriptive statistics. The observed minimum and maximum values for each construct were the extreme points of the Likert scale included in the study, whereas the mean values indicated the average of the response given on the scale of 1 to 5. The standard deviation, kurtosis, and kurtosis of each latent construct of the study were found in-between the acceptable ranges of “−2 and +2”, “−3 and +3”, and “−1 and +1”, respectively. Therefore, these estimations (within their threshold limits) justify the normality of each construct included in the conceptualized model of the study. Thus, the assumption of data normality for structural equation modeling is empirically reinforced [9,72,74].

**Table 2.** Descriptive Statistics and data normality (N = 356).

Variables	N	Min	Mean	Max	SD	Skewness		Kurtosis	
	Stats	Stats	Stats	Stats	Stats	Stats	Std. Error	Stats	Std. Error
VGOAT	356	1.00	4.0253	5.00	0.61773	−0.690	0.129	1.464	0.258
TFOMO	356	1.00	3.3904	5.00	0.78974	0.648	0.129	0.486	0.258
EPF	356	1.00	3.7360	5.00	0.64118	−0.736	0.129	1.742	0.258
DCM	356	1.00	3.5983	5.00	0.75442	−0.412	0.129	0.288	0.258

Harman’s single factor test [75], i.e., a widely employed test for assessing common method bias (CMB), was conducted after ensuring the normal distribution of the study data (N = 356). The extraction method used in this analysis was the principal component analysis (PCF). The PCF evaluation of all the latent constructs revealed that the maximum variance extracted was around 33%, which is well below the upper threshold limit of 50%. The extracted variance lies within the acceptable range; hence, CMB-related issues or

concerns are deemed non-existent in the present study [72]. Table 3 provides the summary of Harman's single factor test outcomes.

**Table 3.** Common Method Bias (N = 356).

Component	Initial Eigenvalues			Extraction Sums of Squared Loadings		
	Total	% of Variance	Cumulative %	Total	% of Variance	Cumulative %
1	10.817	32.779	32.779	10.817	32.779	32.779
2	5.399	16.359	49.139			
3	3.041	9.217	58.355			
4	2.551	7.729	66.085			
5	0.941	2.852	68.936			
6	0.923	2.796	71.732			
7	0.821	2.489	74.221			
8	0.791	2.398	76.618			
9	0.767	2.323	78.941			
10	0.650	1.969	80.910			
11	0.615	1.864	82.774			
12	0.607	1.839	84.614			
13	0.485	1.471	86.084			
14	0.469	1.420	87.504			
15	0.420	1.272	88.777			
16	0.399	1.209	89.985			
17	0.381	1.154	91.139			
18	0.369	1.119	92.258			
19	0.329	0.998	93.256			
20	0.272	0.826	94.081			
21	0.267	0.809	94.890			
22	0.258	0.782	95.672			
23	0.224	0.680	96.352			
24	0.204	0.619	96.971			
25	0.172	0.521	97.492			
26	0.150	0.456	97.948			
27	0.131	0.396	98.344			
28	0.125	0.380	98.724			
29	0.106	0.322	99.046			
30	0.092	0.279	99.325			
31	0.084	0.255	99.580			
32	0.079	0.240	99.820			
33	0.059	0.180	100.000			

Note: Extraction Method—Principal Component Analysis.

#### 4.3. Measurement Model

After assessing the data normality, the evaluation further proceeded to exploratory factor analysis (EFA). The EFA was conducted for all variables, and consequently, each item of the included constructs yielded sufficient factor loadings ( $\rho > 0.40$ ). Similarly, in confirmatory factor analysis (CFA) graphically presented as Figure 2, the items of each construct yielded sufficient standardized factor loading ( $\lambda > 0.30$ , as the cut-off value and/or recommended threshold). The findings from EFA and CFA indicate that the observed data and the theoretical model of the study were a good fit for each other. To assess the internal reliability of the constructs, Cronbach's alpha, average variance extracted (AVE), and composite reliability (CR) values for each latent construct were calculated. The observed AVE, CR, and Cronbach's alpha values, as reported in Table 4, surpassed the cut-off values for each construct, thus confirming the internal/convergent reliability [76]. Table 4 further presents the summary of goodness of fit indices ( $\chi^2 = 1008.437$ ,  $df = 483$ ,  $p = 0.01$ ,  $\chi^2/df = 2.088$ ,  $SRMR = 0.035$ ,  $RMSEA = 0.055$ ), which assures a very good fit between the study data and measurement model and thus justifies the findings of EFA and CFA. Moreover, the study data were also subjected to multicollinearity and discriminant validity tests. As mentioned in previous studies, the absence of multicollinearity across

constructs is thought to be crucial for SEM outcomes to be accurate [9,74,77]. Therefore, the square root of AVE values was matched with the inter-correlation values between each construct, as shown in Table 5. Greater AVE square root values indicated the presence of adequate discriminant validities (and the absence of multicollinearity issues) in the measurement model [4].

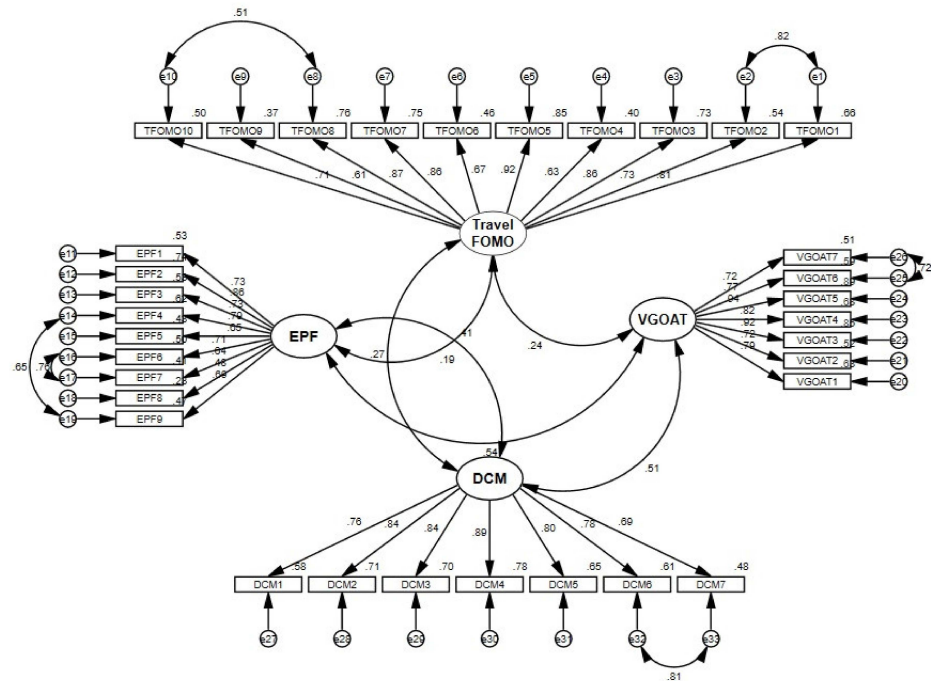

Figure 2. CFA Model of Expats' Vaxication Intention for GOAT.

4.4. Structural Model

In the final step of the analysis, the path coefficients (with t-statistics) were assessed to test the hypothesized relationships, as the data normality, goodness of fit indices, convergent and discriminant validities, and non-existent multicollinearity were well established. The structural model assessment included conventional statistics (beta-coefficients, t-statistics, and p-values), as reported in previous studies [4,9,74,77]. The outcomes of t-stats, p-values, and path coefficient tests are summarized in Table 6 and graphically presented in Figure 3. The positive values of inter-construct correlations (reported in Table 5) confirm the positive association between expat's pandemic fatigue and vaxication intention for GOAT. Moreover, the positive value of the path coefficient ( $\beta = 0.487$ ) reinforces this evidence. The higher values of t-stats ( $t = 12.81$ ) and lesser p-value ( $p < 0.01$ ) confirmed the statistically significant and positive influence of expat's pandemic fatigue on vaxication intention for GOAT. Consequently, hypothesis 1 (H1) is accepted. In contrast, hypothesis 2 (H2), which tested the moderating influence of travel FOMO (on the relationship between expat's pandemic fatigue and vaxication intention for GOAT), is also accepted due to the positive and statistically significant interaction ( $\beta = 0.383$ ,  $t = 9.119$ , and  $p < 0.01$ ). Likewise, hypothesis 3 which theorized the moderating influence of destination crisis marketing on the relationship between expat's pandemic fatigue and vaxication intention for GOAT is also accepted on similar grounds ( $\beta = 0.560$ ,  $t = 16.47$ , and  $p < 0.01$ ). In summary, all the three hypotheses offered in the conceptual model are accepted based on empirical evidence. This implies that the pandemic fatigue in expats fosters their intentions to go on vacations (after receiving mandatory vaccination shots), whereas their fear of missing out on travel opportunities and the effective destination crisis marketing campaigns can significantly reinforce their vaxication intention.

Table 4. Measurement Model (N = 356).

Constructs and Items	Label	$\rho$	$\lambda$
<b>Expats' Pandemic Fatigue (EPF)</b> ( $CR = 0.899$ ; $AVE = 0.594$ ; $Cronbach's\ Alpha = 0.897$ )			
I worry a lot about my personal and family's safety during this pandemic.	EPF1	0.714	0.727
I have felt sad and depressed as a result of the pandemic.	EPF2	0.802	0.858
I am tired of all the COVID-19 discussions in TV shows, newspapers, and radio programs, etc.	EPF3	0.731	0.727
I am sick of hearing about COVID-19.	EPF4	0.855	0.789
When friends or family members talk about COVID-19, I try to change the subject because I do not want to talk about it anymore.	EPF5	0.530	0.653
I feel strained from following all of the behavioral regulations and recommendations around COVID-19.	EPF6	0.741	0.707
I am tired of restraining myself from saving those who are most vulnerable to COVID-19.	EPF7	0.695	0.637
I am losing my spirit to fight against COVID-19.	EPF8	0.511	0.476
I have thoughts that this pandemic will never end soon.	EPF9	0.774	0.685
<b>Traveler's Fear of Missing Out (FOMO)</b> ( $CR = 0.937$ ; $AVE = 0.601$ ; $Cronbach's\ Alpha = 0.931$ )			
I fear others have more rewarding travel experiences than me.	TFOMO1	0.836	0.810
I fear my friends have more rewarding travel experiences than me.	TFOMO 2	0.774	0.733
I get worried when I find out my friends are having fun traveling without me.	TFOMO 3	0.866	0.857
I get anxious when I do not know about my friends' travel plans and/or travel activities.	TFOMO 4	0.636	0.632
It is important that I know where my friends are traveling.	TFOMO 5	0.910	0.924
Sometimes, I wonder if I spend too much time keeping up with my friends' travel plans and/or travel activities.	TFOMO 6	0.661	0.675
It bothers me when I miss an opportunity to travel with friends.	TFOMO 7	0.848	0.865
Whenever I have a good travel experience, it is important for me to share details online (e.g., updating status on social media).	TFOMO 8	0.881	0.869
Whenever I miss out on planned travel, it bothers me.	TFOMO 9	0.609	0.610
Whenever I cannot travel, I continue to keep track of my friends, whether they are traveling or staying at home.	TFOMO 10	0.751	0.706
<b>Destination Crisis Marketing (DCM)</b> ( $CR = 0.926$ ; $AVE = 0.644$ ; $Cronbach's\ Alpha = 0.920$ )			
<i>At times of crisis (e.g., COVID-19 pandemic) . . .</i>			
I prefer to choose a tourism destination that conveys <i>authenticity</i> .	DCM1	0.619	0.760
I prefer to choose a tourism destination that ensures <i>honesty</i> and <i>transparency</i> .	DCM2	0.768	0.844
I prefer to choose a tourism destination that <i>communicates with empathy</i> .	DCM3	0.707	0.838
I prefer to choose a tourism destination that reflects <i>optimism</i> (e.g., staying positive and hopeful).	DCM4	0.792	0.885
I prefer to choose a tourism destination that offers <i>supportiveness</i> .	DCM5	0.867	0.803
I prefer to choose a tourism destination that displays <i>humility</i> .	DCM6	0.932	0.784
I prefer to choose a tourism destination that displays a spirit of <i>creativity</i> .	DCM7	0.864	0.689
<b>Vaxication Intention for GOAT</b> ( $CR = 0.932$ ; $AVE = 0.665$ ; $Cronbach's\ Alpha = 0.928$ )			
<i>As I am fully vaccinated for COVID-19, I plan to go on a special trip . . .</i>			
To prioritize my enjoyment and experiences.	VGOAT1	0.778	0.793
To immerse myself in new experiences that are completely different from the past.	VGOAT2	0.653	0.721
To fully embrace the freedom to do whatever I want.	VGOAT3	0.903	0.919
To somewhere new with a flexible schedule.	VGOAT4	0.881	0.823
To treat myself even if it is over my budget.	VGOAT5	0.928	0.941
To seek out excitement with no regrets.	VGOAT6	0.817	0.766
To experience the "greatest of all trips" that I completely deserve.	VGOAT7	0.792	0.717
Measurement model fit statistics:			
a. <i>Absolute fit indices</i>			
$\chi^2 = 1008.437$ , $df = 483$ , $p < 0.001$ , $\chi^2/df = 2.088$ , $SRMR = 0.035$ , $RMSEA = 0.055$			
b. <i>Incremental fit indices</i>			
TLI = 0.943, and CFI = 0.948			

Notes;  $\rho$  = Factor loadings at  $\geq 0.40$  using EFA;  $\lambda$  = Standardized factors loadings using CFA; CR = Composite Reliability; AVE = Average variance extracted.

**Table 5.** Multicollinearity and Discriminant Validity (N = 356).

	TFO	EPF	VGOAT	DCM
TFOMO	<b>0.775</b>			
EPF	0.193	<b>0.703</b>		
VGOAT	0.241	0.538	<b>0.816</b>	
DCM	0.272	0.409	0.507	<b>0.803</b>

Notes: **Bold** characters represent the square root of AVE scores for each construct. The number below the *diagonals* are the values for measurement adjusted inter-construct correlations.

**Table 6.** Results of study hypotheses (N = 356).

Hypotheses	Relationships	Path Coefficients	Standard Error (S.E)	t-Stats	p-Values	Outcomes
H1	EPF → VGOAT	0.487 **	0.038	12.81	<0.01	Accepted
H2	EPF* TFOMO → VGOAT	0.383 **	0.042	9.119	<0.01	Accepted
H3	EPF* DCM → VGOAT	0.560 **	0.034	16.47	<0.01	Accepted

Notes: \*\*  $p < 0.01$ , EPF = Expats Pandemic Fatigues, TFOMO = Traveler's Fear of Missing Out, DCM = Destination Crisis Marketing, VGOAT = Vaxication Intention for Greatest of All Trips.

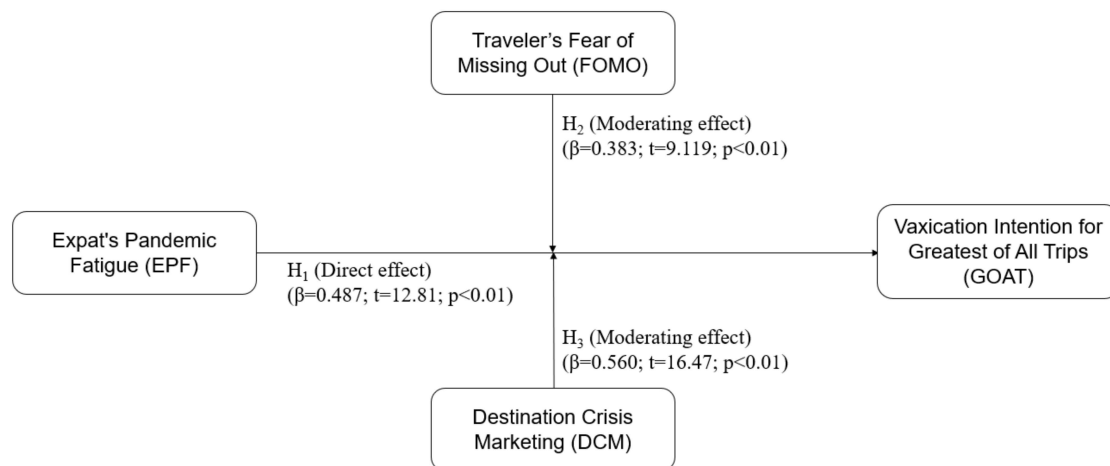
**Figure 3.** Structural Model.

## 5. Discussion

Reopening global tourism requires bouncing forward by adopting new business models (e.g., regenerative travel) instead of bouncing backward to old patterns of pre-pandemic tourism [4,9,11]. Human behavior, according to the theory of planned behavior [38], is heavily influenced by beliefs. Employing it to the post-pandemic tourism context, the utmost desire of staying safe (yet compensating for the time and traveling opportunities lost during lockdowns and travel bans) drives the traveler's actions and decision-making process. Thus, by getting fully vaccinated against COVID-19, travelers become eligible to travel and then plan for their desired vacation. The present study postulates a novel framework by conceptualizing relationships between expats' pandemic fatigue and vaxication intention for GOAT, as well as the moderating effects of travel FOMO and destination crisis marketing on this relationship. Supported by underpinning theories and empirical evidence on these untested relationships, the present study validated the significant positive influence of expats' pandemic fatigue on vaxication intention for GOAT. Pandemic fatigue has already been discussed in the tourism context in recent studies [4,78]. However, the present study provides empirical evidence in support of pandemic fatigue fostering the urge to travel after relaxation of bans (e.g., revenge travel) and optimism for vacation travel after vaccination (i.e., vaxication). Travelers with revenge travel motives are also inclined to get fully vaccinated in order to become eligible to travel again. Therefore, the current study

is in line with observations of recent studies that highlighted the influence of pandemic fatigue on travel intentions [4]. Chua et al. [78] found that people's intentions to travel in the post-pandemic world are heavily influenced by their degree of feeling safe from COVID-19. Moreover, the healthcare and safety concerns also dictate their travel intentions.

The present study also investigated the moderating influence of travel FOMO on the relationship between expats' pandemic fatigue and vaxication intention for GOAT. The empirical evidence validated that travel FOMO can significantly increase (through its positive moderation) the impact of expats' pandemic fatigue on vaxication intention for GOAT. Surprisingly, FOMO has not been empirically examined in previous research in the travel and tourism industry. Existent literature has linked FOMO with opportunities for recreation, such as using social media [14,16–18], video gaming [79], and sporting activities [80]. Although previous studies have largely ignored the implications of travel FOMO, the FOMO concept has been linked with an individual's recreational drive. Supported by the self-determination theory [45], the present study's finding on travel FOMO reinforces the scholarly knowledge on vaxication intention of travelers troubled with pandemic fatigue. Last but not least, the present study accords that destination crisis marketing has a significant moderating influence on the relationship between expats' pandemic fatigue and vaxication intention for GOAT.

Recent studies in management and marketing research have focused on the identification of new and effective strategies for destination marketing and image creation in the COVID crisis scenario, aimed at prospective growth in post-pandemic tourism [11,46–48,81]. Glyptou [46] emphasized that positive image creation of a destination during times of a prolonged crisis, such as COVID-19, acts as a predictor of tourist intentions for visiting destinations. Ahmad et al. [47] also argued that the destination image has a significant effect on the travel intentions of tourists. Moreover, the physical factors of the destinations were found to be more influential. Similarly, Singh et al. [48] identified marketing methods that can help destinations and tourism businesses to sustain and stand out during a crisis, such as COVID-19. The authors suggested COVID-related marketing attributes for opening destinations after the pandemic, vaccinated staff, open and outdoor spaces, and other information to increase traveler's engagement and confidence that would consequently affect their visit intentions. Hence, these aforementioned studies provide sufficient scholarly evidence in support of the outcomes of the current study.

### 5.1. Theoretical Implications

With the arrival of the COVID-19 pandemic, the world has seen the emergence of new concepts and their integration across academic disciplines. Widespread mental distress and anxiety during the pandemic have led to the birth of the pandemic fatigue concept first in psychology [3,4,6,30], which was subsequently adopted by tourism and hospitality management literature [82–86]. The present study developed and validated a comprehensive model that examined the influence of pandemic fatigue on vaxication intention for GOAT for the first time in tourism literature. To do so, new scales were developed and statistically validated to measure expats' pandemic fatigue and vaxication intention for GOAT (i.e., a concept that refers to the first mega-trip after complete vaccination). As the vaxication concept is still in its infancy [9,12,23,87–90], the present study extends scholarly knowledge of vaxication by empirically validating its relationship with expat's pandemic fatigue. This outcome can be interpreted through the theory of planned behavior. As having been psychologically harmed (by curfews and prolonged lockdowns), the fact that restrictions were subsequently relaxed and large-scale vaccination campaigns were implemented. Consequently, the expats display signs of optimism and developed a positive attitude towards traveling [4,9,11]. Additionally, expats could feel more power and behavioral control over their traveling decisions [42]. Based on the protection motivation theory, vaccines could enhance one's perception of self-coping abilities while reducing perceived health threats posed by the pandemic [40].



The novel framework offered in the present study also integrates the fear of missing out (FOMO) concept into tourism. Having developed and validated a novel scale to measure travel FOMO, the present study put forwards empirical evidence for the moderating role of travel FOMO on the relationship between expats' pandemic fatigue and vaxication intention for GOAT. As posited in the self-determination theory, individuals with low self-determination are likely to have greater FOMO than those capable of self-determination. Therefore, the present study contributes to the recent and expanding literature on FOMO in relationship with self-determination theory by depicting expats with higher travel FOMO tend to display higher intentions for vaxication for GOAT [45]. Moreover, this study found the moderating effect of destination crisis marketing on the aforementioned relationship between expat's pandemic fatigue and vaxication intentions, which is in line with the recent literature highlighting that COVID-branded destination safety (CBDS) is the predictor of vaxication intention [9]. The present study offers a novel and interdisciplinary conceptual model that unfolds the underlying relationships between these potential constructs (i.e., pandemic fatigue in expats, vaxication intentions for GOAT, travel FOMO, and destination crisis marketing) and paves ways for future investigations to delineate post-pandemic tourism.

### 5.2. Managerial Implications

The present study has several implications for the decision-making processes of tourism marketers and practitioners. First and foremost, tourism marketers should be aware that expat residents in regions under strict lockdowns and pandemic conditions are likely to experience more severe pandemic fatigue. In particular, as depicted by Zaman et al. [4], expats experiencing intense pandemic fatigue have stronger motivations to engage in revenge travel to avenge their lost time due to the pandemic. Therefore, based on the present study findings, tourism marketers are advised to concentrate on locations that were worse hit by the pandemic to revive tourism demand in the post-pandemic world. Furthermore, complete vaccination has already become mandatory for traveling; therefore, tourism authorities should also work in collaboration with the health care industry to support mass vaccination campaigns to boost future tourism demand. For instance, travel companies and agencies can introduce special offers and discounts for travelers who are getting vaccinated to be eligible to set out on their first trip.

Secondly, the present study empirically illustrated that travel FOMO strengthens the impact of expat's pandemic fatigue on vaxication intention. In this regard, tourism marketers are advised to tap into the emotions of prospective visitors by illustrating that safe and joyful traveling is possible during the pandemic. Destinations can utilize celebrity endorsements and seek cooperation with social media influencers to ensure that traveling is not dangerous anymore, thus provoking fear of missing out to draw tourism demand. Finally, the present study also found that destination crisis marketing reinforces the impact of expat's pandemic fatigue on vaxication intention. In this respect, tourism marketers are advised to focus on offsetting the damage of the COVID-19 pandemic on tourism (by engaging fully vaccinated travelers) with effective destination crisis marketing communications (e.g., ensuring authenticity, transparency, empathy, humility, creativity, and optimism), instead of just competing for tourists and tourist dollars. To do so, tourism marketers should give priority to promoting destinations as safe and COVID-free in their marketing campaigns [46–48]. Moreover, transformative ways of destination crisis marketing, with coordinated and timely response to online user-generated content (e.g., avoid alienating prospective travelers by not being insensitive to the crisis), are deemed useful to rebuild destination trust (with good rapport) and increase individuals' vaxication intention [9,11,91].

### 5.3. Limitations and Future Work

This survey-based research gathered information from international expatriates residing in the United Arab Emirates. In contrast to local residents, the expatriates are more

prone to travel often, at minimum for individual purposes, to meet their family, friends, and acquaintances in their home country [92]. As a result, travel bans and pandemic-induced restrictions may relatively exert a greater influence on expats' mental health. Expatriates may also have challenges adjusting to the indigenous lifestyle, such as communication and language issues [93], which might increase the pandemic's negative impact. As a consequence, expatriates may be more stressed to exhibit pandemic fatigue at a larger scale than the locals. The present study's initial limitation is the choice of expatriates to examine the research hypotheses. To circumvent this constraint, future studies should include local residents and communities to examine any underlying differences in post-pandemic touristic behavior between expatriates (including their different nationalities) and native individuals. Future studies must also look at additional elements that might change the relationship between pandemic fatigue and vaccination intention for GOAT. For example, expats' nationalities, lockdown severity and duration, as well as COVID-19 diagnosis in close family, friends, and relatives. In addition, future studies can also examine traveling and vaccination behavior in correlation with soothing techniques, personal-safety motives, and risk-taking attitudes across traveler's age groups [94,95].

## 6. Conclusions

The revival of pre-pandemic tourism seems to be psychologically clouded, owing to the planned choices of travelers based on health and safety concerns [96]. Hence, tourism businesses and destinations are inclined to attract travelers who are fully vaccinated [97] to serve as an icebreaker for post-COVID tourism [4]. The present study proposed and validated a conceptual model for post-COVID tourism based on relevant underpinning theories (e.g., theory of planned behavior, self-determination theory and protection motivation theory). Using data of international expats in the UAE, the present study highlighted that expats' pandemic fatigue has a significant positive effect on vaccination intention for GOAT. Hence, individuals in locations experiencing more rigid restrictions (i.e., prolonged curfews and lockdowns) could jumpstart tourism demand based on rising vaccination rates and subsequent vaccination demand. Another interesting finding in the present study highlighted that travel FOMO significantly moderates the relationship between expats' pandemic fatigue and vaccination intention for GOAT. Thus, tourism marketers can better benefit from celebrity endorsements and social media influencers to promote destinations as safe and reliable, which will eventually incite people's fear of missing out on travel opportunities during (and after) the pandemic. Importantly, destinations that leverage crisis marketing strategies can minimize their loss (and damage) during and after the COVID-19 pandemic. Hence, destinations should equally emphasize all forms of crisis marketing channels and communications to overcome the adversities of the pandemic. For instance, better coordination of destination-owned media, as well as timely responses to online user-generated content, could contribute to rebuilding destination trust and mobilizing individuals' vaccination intention for the greatest of all trips [9,11,91].

**Author Contributions:** Conceptualization, U.Z.; methodology, U.Z.; software, M.G.K.; validation, M.G.K.; formal analysis, M.G.K.; investigation, U.Z., M.A. (Mahwish Anjam) and M.G.K.; resources, U.Z., S.J.B., M.A. (Mahwish Anjam), S.A. and M.G.K.; data curation, U.Z. and M.G.K.; writing—original draft preparation, U.Z., S.J.B., S.A., M.A. (Mahwish Anjam), M.G.K. and M.A. (Murat Aktan); writing—review and editing, U.Z., S.J.B., S.A., M.A. (Mahwish Anjam), M.G.K. and M.A. (Murat Aktan); visualization, M.G.K.; supervision, U.Z. and S.J.B.; project administration, U.Z. and S.J.B. All authors have read and agreed to the published version of the manuscript.

**Funding:** This research received no external funding.

**Informed Consent Statement:** Informed consent was initially obtained from all participants who had volunteered to participate in this study.

**Data Availability Statement:** The study data are available on special request from the corresponding author.

**Conflicts of Interest:** The authors declare no conflict of interest.

## References

1. UNWorld Tourism Organization. 2020: Worst Year in Tourism History with 1 Billion Fewer International Arrivals. UNWTO. 2021. Available online: <https://www.unwto.org/news/2020-worst-year-in-tourism-history-with-1-billion-fewer-international-arrivals> (accessed on 23 December 2021).
2. Van Mulukom, V.; Muzzulini, B.; Rutjens, B.T.; van Lissa, C.J.; Farias, M. The psychological impact of threat and lockdowns during the COVID-19 pandemic: Exacerbating factors and mitigating actions. *Transl. Behav. Med.* **2021**, *11*, 1318–1329. [CrossRef]
3. Meichtry, B.S.; Sugden, J.; Barnett, A. Pandemic Fatigue Is Real—And It’s Spreading. *Wall Str. J.* **2020**, 1–9. Available online: <https://jmss.vic.edu.au/wp-content/uploads/2020/12/Pandemic-Fatigue-Is-Real.pdf> (accessed on 14 February 2022).
4. Zaman, U.; Raza, S.H.; Abbasi, S.; Aktan, M.; Fariás, P. Sustainable or a Butterfly Effect in Global Tourism? Nexus of Pandemic Fatigue, COVID-19-Branded Destination Safety, Travel Stimulus Incentives, and Post-Pandemic Revenge Travel. *Sustainability* **2021**, *13*, 12834. [CrossRef]
5. Zerbe, K.J. Pandemic Fatigue: Facing the Body’s Inexorable Demands in the Time of COVID-19. *J. Am. Psychoanal. Assoc.* **2020**, *68*, 475–478. [CrossRef]
6. Reicher, S.; Drury, J. Pandemic fatigue? How adherence to COVID-19 regulations has been misrepresented and why it matters. *BMJ* **2021**, *372*, n137. [CrossRef]
7. Wilson, M.D.; Chen, L.H. Re-starting travel in the era of COVID-19: Preparing anew. *J. Travel Med.* **2020**, *27*, taaa108. [CrossRef]
8. Gössling, S.; Scott, D.; Hall, C.M. Pandemics, tourism and global change: A rapid assessment of COVID-19. *J. Sustain. Tour.* **2021**, *29*, 1–20. [CrossRef]
9. Zaman, U.; Aktan, M.; Anjam, M.; Agrusa, J.; Khwaja, M.G.; Far, P. Can Post-Vaccine ‘Vaxication’ Rejuvenate Global Tourism? Nexus between COVID-19 Branded Destination Safety, Travel Shaming, Incentives and the Rise of Vaxication Travel. *Sustainability* **2021**, *13*, 14043. [CrossRef]
10. Reid, C. Travel in 2021 Will Be Better and Worse than You Think. MMYG Global. 2020. Available online: <https://www.mmygglobal.com/news/travel-in-2021-will-be-better-and-worse-than-you-think/> (accessed on 25 December 2021).
11. Aktan, M.; Zaman, U.; Fariás, P.; Raza, S.H.; Ogadimma, E.C. Real Bounce Forward: Experimental Evidence on Destination Crisis Marketing, Destination Trust, e-WOM and Global Expat’s Willingness to Travel during and after COVID-19. *Sustainability* **2022**, *14*, 1111. [CrossRef]
12. Phelan, A.L. COVID-19 immunity passports and vaccination certificates: Scientific, equitable, and legal challenges. *Lancet* **2020**, *395*, 1595–1598. [CrossRef]
13. Murphy, J. *Celebratory ‘Vaxications’ Are Giving the Travel Industry a Boost*; Bloomberg: New York, NY, USA, 2021.
14. Przybylski, A.K.; Murayama, K.; DeHaan, C.R.; Gladwell, V. Motivational, emotional, and behavioral correlates of fear of missing out. *Comput. Hum. Behav.* **2013**, *29*, 1841–1848. [CrossRef]
15. Wang, P.; Xie, X.; Wang, X.; Wang, X.; Zhao, F.; Chu, X.; Nie, J.; Lei, L. The need to belong and adolescent authentic self-presentation on SNSs: A moderated mediation model involving FoMO and perceived social support. *Pers. Individ. Differ.* **2018**, *128*, 133–138. [CrossRef]
16. Yin, L.; Wang, P.; Nie, J.; Guo, J.; Feng, J.; Lei, L. Social networking sites addiction and FoMO: The mediating role of envy and the moderating role of need to belong. *Curr. Psychol.* **2019**, *40*, 3879–3887. [CrossRef]
17. Bright, L.F.; Logan, K. Is my fear of missing out (FoMO) causing fatigue? Advertising, social media fatigue, and the implications for consumers and brands. *Internet Res.* **2018**, *28*, 1213–1227. [CrossRef]
18. Sekścińska, K.; Jaworska, D. Who felt blue when Facebook went down?—The role of self-esteem and FoMO in explaining people’s mood in reaction to social media outage. *Pers. Individ. Differ.* **2021**, *188*, 111460. [CrossRef]
19. Alt, D. College students’ academic motivation, media engagement and fear of missing out. *Comput. Hum. Behav.* **2015**, *49*, 111–119. [CrossRef]
20. Alt, D.; Boniel-Nissim, M. Links between Adolescents’ Deep and Surface Learning Approaches, Problematic Internet Use, and Fear of Missing Out (FoMO). *Internet Interv.* **2018**, *13*, 30–39. [CrossRef]
21. Satish, K.; Venkatesh, A.; Manivannan, A.S.R. COVID-19 is driving fear and greed in consumer behaviour and purchase pattern. *South Asian J. Mark.* **2021**. *ahead-of-publish*. [CrossRef]
22. Rasoolimanesh, S.; Seyfi, S.; Rastegar, R.; Hall, C. Destination image during the COVID-19 pandemic and future travel behavior: The moderating role of past experience. *J. Destin. Mark. Manag.* **2021**, *21*, 100620. [CrossRef]
23. Rastegar, R.; Seyfi, S.; Rasoolimanesh, S.M. How COVID-19 case fatality rates have shaped perceptions and travel intention? *J. Hosp. Tour. Manag.* **2021**, *47*, 353–364. [CrossRef]
24. Valek, N.S. The role of expats, local residents and tourists in defining a destination: A branding case study for Abu Dhabi tourism. *Int. J. Sustain. Soc.* **2017**, *9*, 76. [CrossRef]
25. Valek, N.S.; Fotiadis, A. Is tourism really an escape from everyday life? Everyday leisure activities vs leisure travel activities of expats and emirati nationals living in the UAE. *Int. J. Cult. Tour. Hosp. Res.* **2018**, *12*, 238–254. [CrossRef]
26. Aktan, M.; Zaman, U.; Nawaz, S. Examining destinations’ personality and brand equity through the lens of expats: Moderating role of expat’s cultural intelligence. *Asia Pac. J. Tour. Res.* **2021**, *26*, 849–865. [CrossRef]

27. Nadeem, M.A.; Liu, Z.; Xu, Y.; Nawaz, K.; Malik, M.Y.; Younis, A. Impacts of terrorism, governance structure, military expenditures and infrastructures upon tourism: Empirical evidence from an emerging economy. *Eurasian Bus. Rev.* **2020**, *10*, 185–206. [CrossRef]
28. Alvarez, M.D.; Campo, S. The influence of political conflicts on country image and intention to visit: A study of Israel's image. *Tour. Manag.* **2014**, *40*, 70–78. [CrossRef]
29. World Health Organization. Pandemic Fatigue: Reinvigorating the Public to Prevent COVID-19: Policy Framework for Supporting Pandemic Prevention and Management: Revised Version November. (No. WHO/EURO: 2020-1573-41324-56242) Regional Office for Europe. 2020. Available online: <https://apps.who.int/iris/handle/10665/337574> (accessed on 30 November 2021).
30. MacIntyre, C.R.; Nguyen, P.-Y.; Chughtai, A.A.; Trent, M.; Gerber, B.; Steinhofel, K.; Seale, H. Mask use, risk-mitigation behaviours and pandemic fatigue during the COVID-19 pandemic in five cities in Australia, the UK and USA: A cross-sectional survey. *Int. J. Infect. Dis.* **2021**, *106*, 199–207. [CrossRef]
31. De Smet, A.; Tegelberg, L.; Theunissen, R.; Vogel, T. *Overcoming Pandemic Fatigue: How to Reenergize Organizations for the Long Run*; McKinsey Co.: Atlanta, GA, USA, 2020.
32. Anastasiadou, E.; Anestis, M.C.; Karantz, I.; Vlachakis, S. The coronavirus' effects on consumer behavior and supermarket activities: Insights from Greece and Sweden. *Int. J. Sociol. Soc. Policy* **2020**, *40*, 893–907. [CrossRef]
33. Jiaming, F.; Kulbo, N.B.; Liangqiang, L. Coronavirus: Fear appeal favoring purchase behavior towards personal protective equipment. *Serv. Ind. J.* **2020**, *40*, 417–490.
34. Ranasinghe, R.; Herath, J.; Nawarathna, D.; Gangananda, N.; Bandara, A.; Pattiyagedara, S. Lockdown Pressure of Corona Pandemic, Tourism Industry Pull, and Individual Travel Push: A Critical Review. 2021. Available online: [https://papers.ssrn.com/sol3/papers.cfm?abstract\\_id=3856755](https://papers.ssrn.com/sol3/papers.cfm?abstract_id=3856755) (accessed on 30 November 2021).
35. Seraphin, H.; Dosquet, F. Mountain tourism and second home tourism as post COVID-19 lockdown placebo? *Worldw. Hosp. Tour. Themes* **2020**, *12*, 485–500. [CrossRef]
36. Sweller, J. *Cognitive Load Theory*; Elsevier Inc.: Amsterdam, The Netherlands, 2011; Volume 55.
37. Expedia. The GOAT Mindset: Expedia Reveals 2022's Biggest Travel Trends. Available online: <https://newsroom.expedia.com/2021-11-30-The-GOAT-mindset-Expedia-reveals-2022s-biggest-travel-trend/> (accessed on 30 November 2021).
38. Ajzen, I. The Theory of Planned Behavior. *Organ. Behav. Hum. Perform.* **1991**, *50*, 179–211. [CrossRef]
39. Han, H.; Al-Ansi, A.; Chua, B.-L.; Tariq, B.; Radic, A.; Park, S.-H. The Post-Coronavirus World in the International Tourism Industry: Application of the Theory of Planned Behavior to Safer Destination Choices in the Case of US Outbound Tourism. *Int. J. Environ. Res. Public Health* **2020**, *17*, 6485. [CrossRef] [PubMed]
40. Rogers, R.W.; Prentice-Dunn, S. Protection motivation theory. In *Handbook of Health Behavior Research: Personal and Social Determinants*; Goch, D.S., Ed.; Plenum Press: New York, NY, USA, 1997; pp. 113–132.
41. Wang, J.; Liu-Lastres, B.; Ritchie, B.W.; Mills, D.J. Travellers' self-protections against health risks: An application of the full Protection Motivation Theory. *Ann. Tour. Res.* **2019**, *78*, 102743. [CrossRef]
42. Fishbein, M. A theory of reasoned action: Some applications and implications. In *Nebraska Symposium on Motivation*; University of Nebraska Press: Lincoln, NE, USA, 1979; pp. 27–65.
43. Abel, J.P.; Buff, C.L.; Burr, S.A. Social Media and the Fear of Missing Out: Scale Development and Assessment. *J. Bus. Econ. Res. JBER* **2016**, *14*, 33–44. [CrossRef]
44. Hodgkinson, C. 'Fear of Missing Out' (FOMO) marketing appeals: A conceptual model. *J. Mark. Commun.* **2016**, *25*, 65–88. [CrossRef]
45. Deci, E.L.; Ryan, R.M. Self-determination theory. In *Handbook of Theories of Social Psychology*; Sage Publications, Inc.: Newbury Park, CA, USA, 2012; pp. 416–436.
46. Glyptou, K. Destination Image Co-creation in Times of Sustained Crisis. *Tour. Plan. Dev.* **2020**, *18*, 1–23. [CrossRef]
47. Ahmad, A.; Jamaludin, A.; Zuraimi, N.S.M.; Valeri, M. Visit intention and destination image in post-COVID-19 crisis recovery. *Curr. Issues Tour.* **2020**, *24*, 2392–2397. [CrossRef]
48. Singh, S.; Nicely, A.; Day, J.; Cai, L.A. Marketing messages for post-pandemic destination recovery—A Delphi study. *J. Destin. Mark. Manag.* **2021**, *23*, 100676. [CrossRef]
49. Snepenger, D.; King, J.; Marshall, E.; Uysal, M. Modeling Iso-Ahola's Motivation Theory in the Tourism Context. *J. Travel Res.* **2006**, *45*, 140–149. [CrossRef]
50. Ajzen, I.; Fishbein, M. A Bayesian analysis of attribution processes. *Psychol. Bull.* **1975**, *82*, 261–277. [CrossRef]
51. Abdullah, M.N.A. Revenge tourism: Trend or impact post-pandemic COVID-19. In *Promoting Creative Tourism: Current Issues in Tourism Research*, 1st ed.; Routledge: Oxfordshire, UK, 2021; pp. 623–627.
52. Woodworth, R. *Psychology (Revised Edition)*, 2nd ed.; Henry Holt: New York, NY, USA, 1929.
53. Yan, Q.; Wang, L.; Chen, W.; Cho, J. Study on the influencing factors of unplanned consumption in a large online promotion activity. *Electron. Commer. Res.* **2016**, *16*, 453–477. [CrossRef]
54. Brehm, S.S.; Brehm, J.W. *Psychological Reactance: A Theory of Freedom and Control*; Academic Press, Inc.: Cambridge, MA, USA, 1981.
55. Tang, J.; Zhang, P.; Wu, P.F. Categorizing consumer behavioral responses and artifact design features: The case of online advertising. *Inf. Syst. Front.* **2014**, *17*, 513–532. [CrossRef]
56. Pfalz, L. New Report Predicts 2022's Biggest Travel Trends. Travel Pulse. 2021. Available online: <https://www.travelpulse.com/news/features/new-report-predicts-2022s-biggest-travel-trends.html> (accessed on 1 December 2021).

57. Ang, S.H. Crisis Marketing. In *Wiley Encyclopedia of Management*; John Wiley & Sons, Inc.: Hoboken, NJ, USA, 2015; Volume 9, pp. 1–2.
58. Ang, S.H. Crisis marketing: A comparison across economic scenarios. *Int. Bus. Rev.* **2001**, *10*, 263–284. [CrossRef]
59. Ang, S.H.; Leong, S.M.; Kotler, P. The Asian Apocalypse: Crisis Marketing for Consumers and Businesses. *Long Range Plan.* **2000**, *33*, 97–119. [CrossRef]
60. Alduais, K.M. *Marketing of Tourism Destinations During a Crisis: The Case of Yemen*; Wageningen University: Wageningen, The Netherlands, 2015.
61. Marconi, J. *Crisis Marketing: When Bad Things Happen to Good Companies*; NTC Business Books: Lincolnwood, IL, USA, 1997.
62. Beirman, D. *Restoring Tourism Destinations in Crisis: A Strategic Marketing Approach*; Routledge: England, UK, 2020.
63. Lies, J. Crisis Marketing 4.0: Crisis as Marketing. *Int. J. Econ. Manag. Stud.* **2021**, *8*, 1–6. [CrossRef]
64. Mitran, P.C.; Bebeselea, M. About the crisis marketing and the crisis of marketing. *Econ. Manag. Financ. Mark.* **2012**, *7*, 660.
65. Pacheco, B.G.; Lewis-Cameron, A. Weathering the Storm—Crisis Marketing for Small Island Tourist Destinations. In *Marketing Island Destinations*; Elsevier Inc.: London, UK; New York, NY, USA, 2010; pp. 149–164. [CrossRef]
66. Pappas, N. Marketing Hospitality Industry in an Era of Crisis. *Tour. Plan. Dev.* **2014**, *12*, 333–349. [CrossRef]
67. Shipley, K.; Loar, A. Crisis Marketing: How Brands Are Addressing the Coronavirus. Think with Google. 2020. Available online: <https://www.thinkwithgoogle.com/intl/en-apac/future-of-marketing/digital-transformation/coronavirus-crisis-marketing-examples/> (accessed on 13 December 2020).
68. Avraham, E.; Ketter, E. *Media Strategies for Marketing Places in Crisis*; Routledge: England, UK, 2012. [CrossRef]
69. Zaman, U.; Florez-Perez, L.; Khwaja, M.G.; Abbasi, S.; Qureshi, M.G. Exploring the critical nexus between authoritarian leadership, project team member’s silence and multi-dimensional success in a state-owned mega construction project. *Int. J. Proj. Manag.* **2021**, *39*, 873–886. [CrossRef]
70. Hair, J.F., Jr.; Matthews, L.M.; Matthews, R.L.; Sarstedt, M. PLS-SEM or CB-SEM: Updated guidelines on which method to use. *Int. J. Multivar. Data Anal.* **2017**, *1*, 107–123. [CrossRef]
71. Rigdon, E.E.; Sarstedt, M.; Ringle, C.M. On Comparing Results from CB-SEM and PLS-SEM: Five Perspectives and Five Recommendations. *Mark. ZFP* **2017**, *39*, 4–16. [CrossRef]
72. Wang, J.; Wang, X. *Structural Equation Modeling: Applications Using Mplus*, 2nd ed.; Standards Information Network: Tokyo, Japan, 2019.
73. Global Media Insight. United Arab Emirates Population Statistics 2022. GMI Blogger: Infographics. 2022. Available online: <https://www.globalmediainsight.com/blog/uae-population-statistics/> (accessed on 10 January 2022).
74. Khwaja, M.; Zaman, U. Configuring the Evolving Role of eWOM on the Consumers Information Adoption. *J. Open Innov. Technol. Mark. Complex.* **2020**, *6*, 125. [CrossRef]
75. Chang, S.-J.; Van Witteloostuijn, A.; Eden, L. From the Editors: Common method variance in international business research. *J. Int. Bus. Stud.* **2010**, *41*, 178–184. [CrossRef]
76. Cronbach, L.J. Coefficient alpha and the internal structure of tests. *Psychometrika* **1951**, *16*, 297–334. [CrossRef]
77. Zaman, U.; Florez-Perez, L.; Abbasi, S.; Nawaz, S.; Farias, P.; Pradana, M. A Stitch in Time Saves Nine: Nexus between Critical Delay Factors, Leadership Self-Efficacy, and Transnational Mega Construction Project Success. *Sustainability* **2022**, *14*, 2091. [CrossRef]
78. Chua, B.-L.; Al-Ansi, A.; Lee, M.J.; Han, H. Tourists’ outbound travel behavior in the aftermath of the COVID-19: Role of corporate social responsibility, response effort, and health prevention. *J. Sustain. Tour.* **2020**, *29*, 879–906. [CrossRef]
79. Przybylski, A.K.; Weinstein, N.; Ryan, R.M.; Rigby, C.S. Having to versus Wanting to Play: Background and Consequences of Harmonious versus Obsessive Engagement in Video Games. *CyberPsychology Behav.* **2009**, *12*, 485–492. [CrossRef]
80. Hagger, M.S.; Chatzisarantis, N.L. *Hagge Intrinsic Motivation and Self-Determination in Exercise and Sport*; Human Kinetics: Champaign, IL, USA, 2007.
81. Thirumaran, K.; Mohammadi, Z.; Pourabedin, Z.; Azzali, S.; Sim, M.K.S. COVID-19 in Singapore and New Zealand: Newspaper portrayal, crisis management. *Tour. Manag. Perspect.* **2021**, *38*, 100812. [CrossRef]
82. Morgul, E.; Bener, A.; Atak, M.; Akyel, S.; Aktaş, S.; Bhugra, D.; Ventriglio, A.; Jordan, T.R. COVID-19 pandemic and psychological fatigue in Turkey. *Int. J. Soc. Psychiatry* **2020**, *67*, 128–135. [CrossRef]
83. Al-Tammemi, A.B.; Tarhini, Z.; Akour, A. A swaying between successive pandemic waves and pandemic fatigue: Where does Jordan stand? *Ann. Med. Surg.* **2021**, *65*, 102298. [CrossRef]
84. Sudjana, A.A.; Aini, S.N.; Nizar, H.K. Revenge Tourism: Analysis of Tourist Interest Post-COVID-19 Pandemic. *Pringgitan* **2021**, *2*, 6. [CrossRef]
85. Wassler, P.; Fan, D.X. A tale of four futures: Tourism academia and COVID-19. *Tour. Manag. Perspect.* **2021**, *38*, 100818. [CrossRef]
86. Wang, J.; Xia, L. Revenge travel: Nostalgia and desire for leisure travel post COVID-19. *J. Travel Tour. Mark.* **2021**, *38*, 935–955. [CrossRef]
87. Wang, M.; Kunasekaran, P.; Rasoolimanesh, S.M. What influences people’s willingness to receive the COVID-19 vaccine for international travel? *Curr. Issues Tour.* **2021**, *25*, 192–197. [CrossRef]
88. Lee, S.T. Vaccine diplomacy: Nation branding and China’s COVID-19 soft power play. *Place Brand. Public Dipl.* **2021**, 1–15. [CrossRef]

89. Patwardhan, V.; Ribeiro, M.A.; Payini, V.; Woosnam, K.M.; Mallya, J.; Gopalakrishnan, P. Visitors' Place Attachment and Destination Loyalty: Examining the Roles of Emotional Solidarity and Perceived Safety. *J. Travel Res.* **2019**, *59*, 3–21. [CrossRef]
90. Atsa'Am, D.D.; Wario, R. Association rules on the COVID-19 variants of concern to guide choices of tourism destinations. *Curr. Issues Tour.* **2021**, 1–5. [CrossRef]
91. Sönmez, S.F.; Apostolopoulos, Y.; Tarlow, P. Tourism in Crisis: Managing the Effects of Terrorism. *J. Travel Res.* **1999**, *38*, 13–18. [CrossRef]
92. Cai, X.; Su, X. Dwelling-in-Travelling: Western expats and the making of temporary home in Guangzhou, China. *J. Ethn. Migr. Stud.* **2020**, *47*, 2815–2832. [CrossRef]
93. Ullah, A.A.; Nawaz, F.; Chatteraj, D. Locked up under lockdown: The COVID-19 pandemic and the migrant population. *Soc. Sci. Humanit. Open* **2021**, *3*, 100126. [CrossRef]
94. Zheng, D.; Luo, Q.; Ritchie, B.W. Afraid to travel after COVID-19? Self-protection, coping and resilience against pandemic 'travel fear'. *Tour. Manag.* **2020**, *83*, 104261. [CrossRef]
95. Parady, G.; Taniguchi, A.; Takami, K. Travel behavior changes during the COVID-19 pandemic in Japan: Analyzing the effects of risk perception and social influence on going-out self-restriction. *Transp. Res. Interdiscip. Perspect.* **2020**, *7*, 100181. [CrossRef]
96. Li, F.; Zhang, L. The Influence of COVID-19 on Vocational Hospitality and Tourism Students' Career Choices. *J. China Tour. Res.* **2022**, 1–18. [CrossRef]
97. Shin, H.; Nicolau, J.L.; Kang, J.; Sharma, A.; Lee, H. Travel decision determinants during and after COVID-19: The role of tourist trust, travel constraints, and attitudinal factors. *Tour. Manag.* **2021**, *88*, 104428. [CrossRef] [PubMed]

MDPI  
St. Alban-Anlage 66  
4052 Basel  
Switzerland  
[www.mdpi.com](http://www.mdpi.com)

*Sustainability* Editorial Office  
E-mail: [sustainability@mdpi.com](mailto:sustainability@mdpi.com)  
[www.mdpi.com/journal/sustainability](http://www.mdpi.com/journal/sustainability)



Disclaimer/Publisher's Note: The statements, opinions and data contained in all publications are solely those of the individual author(s) and contributor(s) and not of MDPI and/or the editor(s). MDPI and/or the editor(s) disclaim responsibility for any injury to people or property resulting from any ideas, methods, instructions or products referred to in the content.







Academic Open  
Access Publishing

[mdpi.com](http://mdpi.com)

ISBN 978-3-0365-9490-3