

Adamopoulos, Antonios; Vazakidis, Athanasios

Article

A system equation model a comparative study for G-7 countries

SPOUDAI - Journal of Economics and Business

Provided in Cooperation with:

University of Piraeus

Suggested Citation: Adamopoulos, Antonios; Vazakidis, Athanasios (2019) : A system equation model a comparative study for G-7 countries, SPOUDAI - Journal of Economics and Business, ISSN 2241-424X, University of Piraeus, Piraeus, Vol. 69, Iss. 4, pp. 74-109

This Version is available at:

<https://hdl.handle.net/10419/283653>

Standard-Nutzungsbedingungen:

Die Dokumente auf EconStor dürfen zu eigenen wissenschaftlichen Zwecken und zum Privatgebrauch gespeichert und kopiert werden.

Sie dürfen die Dokumente nicht für öffentliche oder kommerzielle Zwecke vervielfältigen, öffentlich ausstellen, öffentlich zugänglich machen, vertreiben oder anderweitig nutzen.

Sofern die Verfasser die Dokumente unter Open-Content-Lizenzen (insbesondere CC-Lizenzen) zur Verfügung gestellt haben sollten, gelten abweichend von diesen Nutzungsbedingungen die in der dort genannten Lizenz gewährten Nutzungsrechte.

Terms of use:

Documents in EconStor may be saved and copied for your personal and scholarly purposes.

You are not to copy documents for public or commercial purposes, to exhibit the documents publicly, to make them publicly available on the internet, or to distribute or otherwise use the documents in public.

If the documents have been made available under an Open Content Licence (especially Creative Commons Licences), you may exercise further usage rights as specified in the indicated licence.



A System Equation Model A Comparative Study for G-7 Countries

Antonios Adamopoulos^a, Athanasios Vazakidis^b

^a*Hellenic Open University and
University of Western Macedonia, Thessaloniki, Greece
Email: adamant@uom.gr*

^b*Professor, Department of Applied Informatics
University of Macedonia, Thessaloniki, Greece
Email: vasak@uom.gr*

Abstract

This paper investigates the relationship among investments, exports and economic growth for G-7 countries for the period 1975-2017, except for Germany (1991-2017), estimating a simultaneous system equations model. The Group of Seven countries (G7) is a group consisting of Canada, France, Germany, Italy, Japan, United Kingdom, and USA regarded as the most advanced countries worldly, representing 58% of the global net wealth. The purpose of this paper is to examine the long-run relationship between the examined variables applying the two-stage least squared method. Finally, a system equation model is estimated for G7 countries applying a Monte Carlo simulation method, in order to find out the predictive ability of the equation model. The results of this paper indicated that there is a positive relationship between investments, exports and economic growth taking into account the negative indirect effect of inflation rate and positive indirect effect of industrial production index on economic growth. Furthermore, the model is very well simulated, since the simulated values are close to actual values of examined variables.

Keywords: economic growth, exports, investments, simulation, G7 countries

JEL: O11, C22

1. Introduction

The theoretical ambiguity on the positive effect of exports and investments on economic growth is reflected in the modern empirical literature. Some researchers point out the positive effect of exports on economic growth (Grossman and Helpman, 1991, Chang et al 2009). They are keenly supporters of the export-led growth hypothesis identifying the significant relationship between exports and economic growth (Lucas, 1988, Romer, 1990). The increase of investments causes a relative increase of economic growth taking into account the lower inflation rate in most developed countries. The increase of entrepreneurship and innovation

promotes economic growth through investments growth and increase of consumptive demand. Entrepreneurship facilitates the increase of demand of goods and services and promotes economic growth through new investments in internal market.

King and Levine (1993b) studied an endogenous growth model analyzing the role of mediators in financial markets. The mediators acquire information about consumptive goods which are not available to private investors and public markets. The advantage of direct information enables them to invest in innovative products enhancing economic growth (De La Fuente and Marin, 1996).

The recent revival of interest in the relationship between exports, investments and economic growth examines the insights and techniques of endogenous growth models. Economic theory suggests that export expansion is believed to promote economic growth via two paths: by improving efficiency in the allocation of productive resources and by increasing the volume of productive resources through capital accumulation (Dritsaki and Adamopoulos, 2003). Exports expansion leads to foreign exchange profits, funding capital goods and imports of intermediaries, increasing their production (Bhagwati, 1978, Krueger, 1978). Export expansion can increase productivity offering greater economies of scale by improving of distribution resources and by increasing the rate of capital formation and technological change (Balassa, 1978, Dritsaki et al, 2004).

There are at least three arguments that can be used for providing theoretical rationale adopting the hypothesis that exports and economic growth are interrelated. First, up to Keynesian theory, exports expansion leads through the trade multiplier to economic growth promotion. Second, exports increase the national exchange that can be used for importing capital products resulting to economic growth promotion. The competition leads to scales economies development and technology acceleration to production, two important sources of economy growth (Dritsaki and Adamopoulos, 2003).

The basic a priori argument is that exports expansion contributes to economic growth increasing the percentage of gross fixed capital formation and productivity factor. If there are incentives for investments growth and technology advance the marginal productivities factors are expected to be higher in exporting sector than the remain economic ones (Dritsaki, et al, 2004). Trade openness functionally is the impetus of economic growth imposing the domestic resources redistribution and the essential exports differentiations related to domestic demand (Serletis et al, 2004)

Since the previous literature has largely ignored the dynamic interactions between exports and other variables, such as investment, it could be noted that the incorporation of this variable is a very important element of this approach. Consequently, exports can affect economic growth directly or indirectly through their effects on investment. Theoretically, the gross capital formation affects the economic growth either increasing the physical capital stock in domestic economy directly, Plossner (1992) or promoting the technology indirectly, Levine and Renelt (1992). The effect of foreign direct investment on economic growth is dependent on the level of technological advance of a host economy, the economic stability, the state investment policy and the degree of openness (Dritsakis, et al, 2006).

According to Adam Smith's analysis of market specialization, trade openness promotes the efficient allocation of resources through comparative advantage, allows the dissemination of knowledge and technological progress, (Chang et al 2009). Furthermore, trade openness encourages competition in domestic and international markets increasing returns to scale (Grossman and Helpman, 1991). However, if market or institutional imperfections exist, trade openness can lead to under-utilization of human and capital resources and concentration in

extractive economic activities, leading specialization not to technologically advanced and increasing-return sectors (Chang et al 2009).

Furthermore, technological progress and innovation facilitate investments growth, increase the entrepreneurship and consequently lead to productivity growth. The increase of products demand causes an increase of consumption of goods and services based on consumptive preferences and selections. Endogenous growth theory predicts that trade liberalization promotes economic growth facilitating the transactions of goods and services, the efficiency of investments and causing positive externalities for firms (Rivera-Batiz and Romer, 1991). Technological relegation and the industrialization failure lead to the reduction of productivity and also increase the production cost and products prices causing intense inflationary pressures. Inflation erodes taxation reductions and increases the constant capital value causing a rapid decrease in capital accumulation and productivity labour (Dritsakis et al, 2006). However, higher productivity leads to lower per unit production cost facilitating exports growth (Kaldor, 1967). Producers may sell their products in international markets, only if domestic production is larger than domestic demand (Sharma and Dhakal, 1994).

New growth theories including technological advance stress the importance of investment, human and physical capital in the long-run economic growth. The policies, which affect the level of growth and the investment efficiency, determine the long-run economic growth.

2. Literature Review

The recent revival of interest in the relationship between trade of openness and economic growth examines the insights and techniques of endogenous growth models. Endogenous growth theory also predicts that trade liberalization promotes economic growth facilitating the transactions of goods and services, the efficiency of investments and causing positive externalities for firms (Rivera-Batiz and Romer, 1991). The model hypothesis predicts that investments, exports and consumption promote economic growth taking into account the negative effect of inflation rate and positive effect of industrial production index and trade of openness. De Mello (1997) supported that geographical position in conjunction with infrastructure of a developed country and also scales of economies determine the rate of investments growth. In less developing countries the technological gap is larger than the developed ones, so the investment incentives for transmission of a new technology in these countries are more intense. A healthy competitive environment which ensures the domestic investment growth, consists the main precondition for foreign direct investment growth in a domestic economy.

Dutt and Ghosh (1994) examined the long-run relationship between exports and economic growth for 26 industrialized countries of lower, mediate and higher income. Augmented Dickey-Fuller, Phillips-Perron (1988) and Kwiatkowski Phillips Schmidt Shin (1992) unit roots tests were used for stationarity tests of time series. Phillips and Ouliaris (1990) cointegration test was used in order to find out the cointegration relationships between the examined variables based on fully modified ordinary least squared method of Phillips-Hansen. Phillips and Hansen (1990) selected the simulation method in order to prove the accuracy of this method in estimation results for cointegration test. Dutt and Ghosh (1994) found that all variables are cointegrated in 19 countries, so there is a long- run relationship between exports and economic growth in these countries.

Bahmani-Oskooee and Nirromand (1999) investigated the relationship between economic growth and trade of openness for 1960 to 1992 for 59 developed and less developing countries using Johansen cointegration method. Bahmani-Oskooee and Nirromand (1999)

found that there is one cointegrated vector between economic growth and trade of openness, so there is a positive long-run equilibrium relationship in 19 developed countries. Ghirmay, Grabowski and Sharma (2001) highlighted that there is a long-run relationship between exports, foreign direct investments and economic growth, for 19 less developed countries. Augmented Dickey-Fuller and Phillips-Perron test were used for stationarity test of time series. The results of Johansen cointegration tests indicated that 13 countries have two cointegrated vectors, while 2 countries have one cointegrated vector and 4 countries haven't any cointegrated vectors.

Liu, Burrige and Singlair (2002) followed up on the causal relationship between economic growth, foreign direct investments and trade for China. They estimated an empirical model including seasonal dummies in order to find out the exogeneity rank of time series. The empirical results of Johansen cointegration tests indicated that there are two cointegrated vectors, so the time series are cointegrated. Granger causality tests indicated that there is a bilateral causality between foreign direct investment and economic growth, also a bilateral causality between exports and economic growth.

Krishna, J., Ozyildirim and Swanson (2003) examined the relationship between domestic investments, trade and economic growth for 39 developing countries for time period 1960-1998 estimating a prediction model for each country. A business cycle index is constructed in order to calculate the predictive ability of higher rates of economic growth of developing countries. Granger causality and cointegration tests indicated that exports, imports and investments have a positive effect on economic growth. The best predictive model including the business cycle index was selected for prediction of economic growth rate in 9 developing countries.

Balaguer and Jorda (2004) studied whether economic growth fosters a general increase of exports or an increase of distribution of resources derived from less effective exporting sectors. Balaguer and Jorda (2004) concluded that exports promote economic growth and inversely economic growth enhances exports for Spain for the time period 1961-2000. In cases where exports remained stable, the distribution of resources in more competitive sectors may cause more important economic growth rates. However, the trade growth is highly characterized by industrial policy which facilitates resources movement in more efficient exporting sectors.

Makki and Somwaru (2004) analyzed the effect of foreign direct investments and trade on economic growth for 66 developing countries using cross-sectional data. Foreign direct investments and trade promote economic growth according to endogenous growth theory. Makki and Somwaru (2004) found that there is a positive interrelation between foreign direct investment and trade, while the lower inflationary levels, the decrease of taxable tariffs and the increase of domestic investments affect directly economic growth of developing countries. Two stage least squares method (TSLS) provided accurate and reliable empirical results similar to seemingly unrelated regression (SUR) method.

This empirical study has the following objectives:

- To examine the interrelation among economic growth, exports, investments and consumption
- To make simulations by estimating a system equation model with Monte Carlo simulations method.

The remainder of the paper proceeds as follows: Section 3 describes the methodology of empirical study, while section 4 analyses the empirical results. Finally, section 5 provides the conclusions of this paper.

3. Methodology and data analysis

In order to test the long-run relationships, the following simultaneous equations system model is estimated by the *two-stage least squared* method.

$$\text{Economic growth Function: } GDP_t = a_0 + a_1 X_{t-i} + a_2 I_{t-i} + a_3 CS_{t-i} + u_{1t} \quad (1)$$

$$\text{Exports Function: } X_t = b_0 + b_1 GDP_{t-i} + b_2 IND_{t-i} + b_3 X_{t-i} + u_{2t} \quad (2)$$

$$\text{Investments Function: } I_t = c_0 + c_1 GDP_{t-i} + c_2 IND_{t-i} + c_3 I_{t-i} + u_{3t} \quad (3)$$

$$\text{Consumption Function: } CS_t = d_0 + d_1 GDP_{t-i} + d_2 CPI_{t-i} + c_3 CS_{t-i} + u_{4t} \quad (4)$$

where *GDP* is the gross domestic product, *X* are exports, *I* are investments, *CS* is the consumption, *CPI* is the consumer price index, *IND* is the industrial production index, *OP* is the trade of openness, a_0, b_0, c_0, d_0 , are constants terms, $u_{1t}, u_{2t}, u_{3t}, u_{4t}$, are the disturbance terms and $a_1, a_2, a_3, b_1, b_2, b_3, c_1, c_2, c_3, c_4, d_1, d_2, d_3, d_4$ are the estimated coefficients, t is the time period, i is the number of lags and $t-i$ are the time lags.

Specifically, Gross Domestic Product (GDP) measures the value of economic activity in a country, namely represents the monetary value of all goods and services produced within a nation's geographic borders over a specific time period, investments are gross fixed capital formation as a percentage of GDP, while consumption is referred to the final consumption of goods and services, consumer price index is a measure of inflation, industrial production index measures the production of products and services of industrial enterprises and organizations and finally trade of openness is the total sum of imports and exports to GDP. Trade of openness facilitates trade exchanges avoiding trade tariffs and taxes between transactors in a free open market.

The data that are used in this analysis are annual covering the period 1975-2017 for G-7 countries except for Germany (1991-2017), regarding 2010 as a base year. All time series data are expressed in their levels and are obtained from *AMECO Statistical Database of European Union*. AMECO is the annual macro-economic database of the European Commission's Directorate General for Economic and Financial Affairs (AMECO, 2018, <https://ec.europa.eu>).

The system equation model is estimated by the *two-stage least squared* method in order to obtain more reliable empirical results comparing with other possible estimation methods. Since all variables are examined for stationarity and cointegration, the *two-stage least squared* method is selected as more eligible method in order to find out the interrelation between the dependent variables with independent ones. The difference with other estimated methods as threshold model, polynomial or smoothing coefficient model is that in this study the main goal is to estimate a system equation model consisted by four equation simultaneously and not only one equation separately in order to make predictions policies and sensitivity analysis by using Monte Carlo simulation method.

Two-stage least squared method is preferable for estimation of a simultaneous linear system equation model than other econometric methods. For instance, Granger causality method is

used to define the direction of causality between the examined variables of a simple linear or exponential model but not in a system equation model. Simultaneous system equation models are estimated by the *two-stage least squared* method in order to avoid nonlinearity and endogeneity problem and simultaneity bias. These problems are usually appeared in cross-sectional studies. The advantage of two-stage least squared method is that it investigates the direct and indirect effects of independent variables on dependent variables, while causality method can not define the indirect effects between the examined variables.

Based on the empirical studies of Adamopoulos (2019), Katos et al (1996), Katsouli (2003, 2006) and Vazakidis (2006), the basic hypotheses of the estimated system equations model are the following:

Hypothesis H₁: Investments, exports development and consumption have a positive effect on economic growth for G7 countries.

Hypothesis H₂: Economic growth and industrial production have a positive effect on exports, for G7 countries.

Hypothesis H₃: Economic growth and industrial production have a positive effect on investments, for G7 countries.

Hypothesis H₄: Economic growth has a positive effect on consumption while inflation rate has a negative effect on consumption for G7 countries.

Therefore, the main purpose of this study is to investigate the direct effect of investments, exports and consumption on economic growth taking into account the indirect effect of consumer price index and industrial production on it. The interrelations between the examined variables of the system model are presented in the following diagram in accordance with the basic hypotheses.

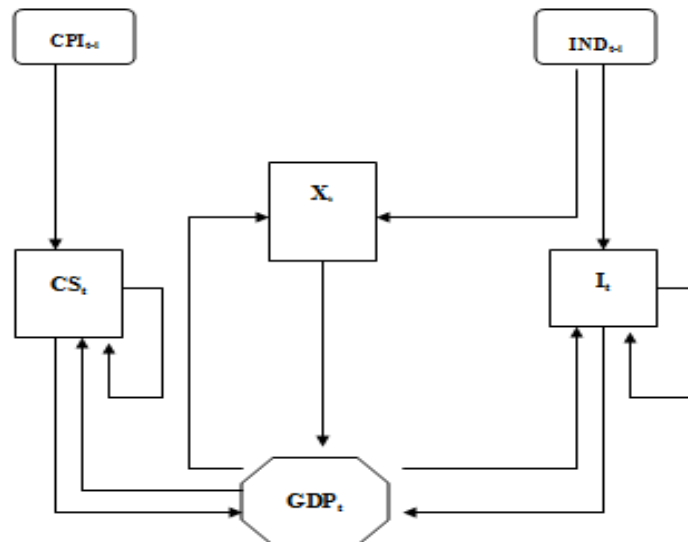

The structural system equation model is consisted by four equations. The dependent variables are (GDP_t, I, X_t, CS_t) and the independent variables are (GDP_{t-1}, X_{t-1}, I_{t-1}, CPI_{t-1}, IND_{t-1}, CS_{t-1}). Each equation is examined for statistical significance based on the statistical diagnostic tests

such as possible existence of autocorrelation problem. The Eviews 9.0 (2015) software package is used to conduct these tests.

3.1 Unit roots theory

According to Choi (1992), the Phillips-Perron test appears to be more powerful than the Augmented Dickey-Fuller test (Dickey and Fuller, 1979) for the aggregate data. Phillips-Perron (1988) unit root test can be used for stationarity testing for the existence of autocorrelated and heteroscedastic residuals as follows:

$$\ln(1+r) = a + b\left(\frac{t-T}{2}\right) + d\ln(1+r_{t-1}) + e_t \quad (5)$$

for $t = 1, 2, \dots, T$ where r_t denotes interest rate at time t , $(t-T/2)$ is a time trend and T is the sample size (Laopodis and Sawhney 2007).

Equation 5 examines three hypotheses: The first hypothesis supposes that the time series contains a unit root either with a drift or both with a drift and a time trend: $H_0^1: d=1$. The second hypothesis suggests that the time series contains a unit root without a time trend: $H_0^2: b=0, d=1$. The third hypothesis defines that the time series contains a unit root without a drift or a time trend: $H_0^3: a=0, b=0, d=1$. The statistics tests that are used to examine each hypothesis separately are $z(t_d)$, $z(f_2)$, $z(f_3)$, respectively and are presented in the following equations:

$$z(t_d) = \left(\frac{s_0}{s_T}\right) t_s - \left(\frac{T^3}{3^{1/2} 4 D_{xx}^{1/2}}\right) (s_T^2 - s_0^2) \quad (5a)$$

$$z(f_3) = \left(\frac{s_0^2}{s_T^2}\right) f_3 - \left(\frac{1}{2s_T^2}\right) (s_T^2 - s_0^2) \times \left[T(d-1) - \left(\frac{T^6}{48D_{xx}}\right) (s_T^2 - s_0^2) \right] \quad (5b)$$

$$z(f_2) = \left(\frac{s_0^2}{s_T^2}\right) f_2 - \left(\frac{1}{3s_T^2}\right) (s_T^2 - s_0^2) \times \left[T(d-1) - \left(\frac{T^6}{48D_{xx}}\right) (s_T^2 - s_0^2) \right] \quad (5c)$$

where:

$$f_3 = \frac{T(s_0^2 - (\bar{r} - \bar{r}_{t-1})^2 - s^2)}{2s^2} \quad (5d)$$

$$f_2 = \frac{T(s_0^2 - s^2)}{3s^2} \quad (5e)$$

s^2 is the residual variance, s_0^2 is the variance under the specific hypothesis for the standard critical t-test for $d = 1$. D_{xx} is the determinant of the $(x'x)$, where x is the T_3 matrix of independent variables in equations 5a, 5b, 5c (Laopodis and Sawhney 2007).

Following the study of Chang and Caudill (2005), Johansen (1988) and Osterwald-Lenum (1992) propose two test statistics in order to find out the number of co-integrated vectors: The trace (λ_{trace}) and the maximum eigenvalue (λ_{max}) tests statistics.

The Likelihood Ratio statistic (LR) for the trace test (λ_{trace}) as proposed by Johansen (1988) has the following form:

$$\lambda_{\text{trace}}(r) = -T \sum_{i=r+1}^p \ln(1 - \hat{\lambda}_i) \quad (6)$$

where:

$\hat{\lambda}_i$ = the largest estimated value of eigenvalue obtained from the estimated Π matrix

$r = 0, 1, 2, \dots, p-1$

T = the total number of observations of the examined sample

The λ_{trace} statistic tests the null hypothesis that the number of distinct characteristic roots is less than or equal to r , (where r is 0, 1, 2 or 3) against the general alternative. The value of λ_{trace} will be smaller when the related values of the characteristic roots are very close to zero.

Alternatively, the maximum eigenvalue (λ_{max}) statistic as suggested by Johansen (1988) has the general form:

$$\lambda_{\text{max}}(r, r+1) = -T \ln(1 - \hat{\lambda}_{r+1}) \quad (7)$$

The λ_{max} statistic examines the null hypothesis which defines that the number of co-integrated vectors is r against the alternative of $(r+1)$ co-integrated vectors. Therefore, the null hypothesis $r = 0$ is tested against the alternative $r = 1$, then $r = 1$ against the alternative $r = 2$, and finally $r = 2$ against the alternative $r = 3$ and so on. If the estimated value of the characteristic root is very close to zero, then the λ_{max} will be smaller respectively.

Specifically, Johansen's co-integration tests are very sensitive to the final selection of lag length. The VAR model is fitted to the time series data in order to define an appropriate lag number. The Schwarz Criterion (SC) (1978) is selected as the best statistical criterion in order to find out the eligible number of lags in the co-integration analysis. Table 3 indicates the estimated results from the Johansen co-integration test.

3.2. Two-stage least squares method

Initially, two-stage least squares method is applied to estimate a linear regression model for statistical significance. This method defines that the regression line is fitted to the estimated values by minimizing the sum of squared residuals which indicates the sum of the vertical distances among each point and the relative point on the regression line. The smallest distances the better regression line is fitted. A regression model has a general form as follows:

$$Y_t = a + bX_t \quad (8)$$

Estimating a regression model with two-stage least squares method, mainly we have to find the estimations of constant term (\hat{a}) and the slope of equation model (\hat{b}), namely to solve the following patterns (Seddighi et al, 2000, Katos, 2004)

$$\hat{b} = \frac{n \sum X_t Y_t - \sum X_t \sum Y_t}{n \sum X_t^2 - (\sum X_t)^2} \quad \text{and} \quad \hat{a} = \bar{Y}_t - \hat{b} \bar{X}_t, \quad (9)$$

where \bar{Y}_t is average of values of Y (dependent variable) and \bar{X}_t average of values of X (independent variable). The final estimated model has the general form as follows

$$\hat{Y}_t = \hat{a} + \hat{b}X_t \quad (10)$$

In order to correct the existence of autocorrelation, we can use the first order autoregression model. The autoregressive coefficient defines that each disturbance equals to a portion of a preceding disturbance plus a random effect expressed by v_t namely

$$u_t = \rho u_{t-1} + v_t \quad |\rho| < 1, \text{ where } \rho \text{ is the autoregressive coefficient (Katos, 2004)}$$

3.3 Sensitivity analysis

In order to *make simulation policies* we have to estimate the inequalities ratios indices of Theil. The best predictive ability of the system equation model is achieved by estimating the inequalities ratios indices of Theil as follows:

$$U = \frac{\sqrt{\frac{1}{T} \sum (x_t^{sim} - x_t)^2}}{\sqrt{\frac{1}{T} \sum (x_t^{sim})^2 + \frac{1}{T} \sum (x_t)^2}} \quad \text{Theil index} \quad (11)$$

The smaller dynamic multipliers and inequalities ratios indices, the better predictive ability of the system equation model (Katos, 2004).

4. The empirical results

The basic statistical measures analyzing the descriptive structure of examined variables as average, mean, standard deviation and coefficients of skewness and asymmetries are presented in this study for each country respectively in Table 1. In order to examine the stationarity test of examined variables, Phillips-Perron (1988) unit root test is applied based on Augmented Dickey-Fuller test (ADF) (Dickey and Fuller, 1979). All data variables are stationary in their first differences, so they can be characterized as stationary and integrated of first order according to the unit roots theory in all examined countries (Table 2). Then Johansen and Juselius (1990) cointegration tests are applied in order to find out the existence of cointegrated relations between the examined variables. Table 3 indicates that the fitted number of cointegrated vectors is selected every time comparing the relative eigenvalues to the trace test statistics for each country respectively. Since all variables are tested for stationarity and cointegration existence, then a simultaneous system equation model is estimated for making simulation policies.

The significance of the empirical results is dependent on the variables under estimation. The number of fitted time lags and the usage of first order autoregressive term were selected for the best estimations results and for existence of statistical significance in each equation model. Based on Vazakidis (2006) and Adamopoulos (2019) studies, the model of economic growth is mainly characterized by the direct effect of exports, investments and consumption, while there is an indirect effect of inflation rate and industrial production index.

Tables (4.1-4.4) report the empirical results for the simultaneous equations system model estimated by the *two-stage least squared* method for G7 countries, where AR(1) is an autoregressive term, DW is the Durbin-Watson test statistic for auto-correlation and R^2 is the determination coefficient. Estimating the system equation model with two-stage least squared method we can infer that there is statistical significance in coefficients of independent variables based on probabilities and t-student distribution test statistics. Their estimated values have the expected statistical sign based on economic theory. The coefficient of determination in each equation is very high (0,99) and is close to unity, so the model is very well adjusted

The same conclusion is easily confirmed by studying probabilities and test statistics. All probabilities values are lower than 10% and estimated coefficients are statistically significant. Durbin Watson test statistic indicates that there is a possible problem of autocorrelation, while there is a possible existence of multicollinearity problem due to the highest values of coefficients of determination. Examining the economic interrelation between dependent and independent variables we can infer that investments, exports and consumption have a positive effect on economic growth (equation 1), economic growth has a positive effect on exports (equation 2), on investments (equation 3), and on consumption (equation 4), while inflation rate has a negative effect on consumption (equation 4), and finally industrial production has a positive effect on exports (equation 2), and on investments (equation 3).

Specifically, examining Johansen and Juselius cointegration tests for all data variables for each country, we find out that there is one cointegrated vector in Canada, three cointegrated vectors in France, Germany and United Kingdom, four in United States and five cointegrated vectors in Japan.

Estimating the system equation model with two-stage least squared method we can see that there is statistical significance in coefficients of independent variables based on probabilities and t-student distribution test statistics. Their estimated values have the expected statistical sign based on economic theory. All probabilities values are lower than 5% level of significance. Durbin Watson test statistics indicates that there is a possible problem of autocorrelation which is corrected by using the autoregressive error term of first class AR(1) as we can see in Tables 4.1-4.4.

The simultaneous system equations model is adapted to each country in a general specific form taking into account the specification test. An appropriate number of time lags of the examined variables is selected in order to determine the endogenous variables of the system equations model and to achieve the best identification of it.

The interrelation between the examined variables of estimated equation model for G7 countries is described in Figure 1 respectively. As we can see from the graphs of system equation models, the direct and indirect relations between the examined variables are distinctly based on theoretical economic hypotheses of estimated system equation model for G7 countries.

The simultaneous system equation model is estimated by using two-stage least squares method in order to discriminate the direct and indirect effects of independent variables on dependent ones. The following figures illustrate the direction of direct and indirect effect of main determinants of economic growth on it for each examined country.

The direct effect of investments, exports and consumption on economic growth taking into account the indirect effect of consumer price index and industrial production on economic growth is depicted apparently in all estimated system equation models.

Theoretical conclusions of empirical analysis of estimated model for each country are presented analytical in Tables 4.5-4.8. As we can see the theoretical hypotheses of estimated system equation model for G7 countries are completely verified, based on economic theory.

Table 1
Summary Descriptive statistics

CANADA	GDP	X	I	CS	CPI	IND
Mean	0.604291	0.674133	0.570140	0.592509	0.737958	0.884421
Median	0.515600	0.658200	0.413700	0.509900	0.763100	0.888600
Std. Dev.	0.357153	0.422794	0.365520	0.357093	0.253980	0.202504
Skewness	0.381830	0.079183	0.612592	0.421933	-0.349626	-0.189244
Kurtosis	1.888828	1.474456	2.013564	1.989593	2.076936	1.533200

FRANCE	GDP	X	I	CS	CPI	IND	OP
Mean	0.646681	0.629277	0.640835	0.638865	0.754198	1.007170	1.907603
Median	0.627600	0.540200	0.572100	0.625000	0.810100	1.009000	1.974356
Std. Dev.	0.315555	0.375830	0.313978	0.308288	0.246270	0.099984	0.254630
Skewness	-0.059616	0.248474	0.078863	-0.068097	-0.646126	-0.403101	-0.109114
Kurtosis	1.789015	1.782410	1.772818	1.819298	2.388397	2.159028	1.749841

GERMANY	GDP	CS	CPI	IND	I	X
Mean	0.907926	0.906163	0.917778	0.940956	0.979726	0.786037
Median	0.880100	0.901000	0.910200	0.900000	0.942300	0.738400
Std. Dev.	0.178422	0.158261	0.112663	0.118912	0.140768	0.349794
Skewness	0.338744	0.045252	-0.070644	0.082558	0.947658	0.236376
Kurtosis	2.232702	2.087255	1.916740	1.564246	2.970930	1.733805

ITALY	GDP	CS	CPI	I	IND	X
Mean	0.610656	0.638865	0.673919	0.610060	0.985791	0.603212
Median	0.650100	0.625000	0.744000	0.617300	0.984100	0.613300
Std. Dev.	0.349227	0.308288	0.312697	0.327967	0.127958	0.408939
Skewness	-0.214007	-0.068097	-0.366945	-0.210582	-0.132793	0.150797
Kurtosis	1.588395	1.819298	1.881021	1.677825	2.108938	1.614573

JAPAN	GDP	CS	CPI	IND	I	X	OP
Mean	0.863958	8.183649	0.933304	0.911307	1.104714	0.734009	1.646515
Median	0.992600	9.690300	1.000260	0.974100	1.174000	0.662500	1.541990
Std. Dev.	0.243834	2.458238	0.126827	0.160241	0.278746	0.283978	0.362428
Skewness	-0.993666	-0.888021	-1.463561	-1.008029	-0.545855	0.386080	0.657754
Kurtosis	2.479192	2.303057	4.153366	2.965327	2.390975	2.218199	2.172765

UK	GDP	X	I	CS	CPI	IND
Mean	0.605798	0.554042	0.690323	0.577509	0.711958	0.987035
Median	0.571600	0.521900	0.673100	0.480300	0.769900	0.998000
Std. Dev.	0.367113	0.381255	0.376265	0.320494	0.274389	0.092080
Skewness	0.213051	0.512879	0.078455	0.237184	-0.314354	-0.382875
Kurtosis	1.800711	2.014310	1.984950	1.581491	2.077169	2.017300

USA	GDP	CS	CPI	IND	I	X
Mean	0.607272	0.592693	0.709481	0.820442	0.698542	0.539033
Median	0.538500	0.514900	0.718800	0.822400	0.624500	0.469900
Maximum	1.299700	1.307800	1.124100	1.117100	1.446100	1.284200
Minimum	0.112400	0.101200	0.246500	0.447800	0.126200	0.075100
Std. Dev.	0.359492	0.366907	0.263390	0.223563	0.391566	0.393788
Skewness	0.341963	0.368734	-0.097022	-0.104150	0.256094	0.626079
Kurtosis	1.842640	1.839551	1.872721	1.425679	1.764625	2.076879

Table 2
Tests of unit roots hypothesis

CANADA	Phillips-Perron		
	PP_ test stat		
	t_n	t_c	t_t
GDP	8.75 (p=2)	3.77(p=5)	-0.88(p=2)
X	2.75(p=1)	0.003(p=1)	-2.34(p=2)
I	4.74(p=3)	1.65(p=5)	-1.29(p=4)
CS	11.69(p=4)	7.29(p=2)	0.70(p=2)
CPI	3.98(p=5)	-2.92(p=2)*	-1.67(p=1)
IND	2.21(p=0)	-1.05(p=0)	-1.91(p=1)
ΔGDP	-2.24(p=4)	-5.63(p=2)	-7.01(p=5)
ΔX	-5.35(p=4)	-6.50(p=1)	-6.44(p=1)
ΔI	-3.87(p=2)	-5.63(p=2)	-6.03(p=6)
ΔCS	-0.14(p=1)	-2.85(p=4)*	-5.53(p=2)
ΔCPI	-1.13(p=1)	-3.22(p=1)	-3.95(p=1)
ΔIND	-4.77(p=1)	-5.24(p=2)	-5.16(p=2)

FRANCE	Phillips-Perron		
	PP_ test stat		
	t_n	t_c	t_t
GDP	4.46(p=5)	-0.68(p=2)	-1.95(p=1)
X	4.39(p=1)	0.72(p=1)	-2.70(p=1)
I	3.75(p=3)	-0.11(p=3)	-2.44(p=2)
CS	6.49(p=1)	-0.99(p=1)	-1.43(p=1)
CPI	4.33(p=1)	-1.08(p=1)	-1.55(p=1)
IND	0.83(p=2)	-2.56(p=1)	-1.90(p=2)
OP	-0.22(p=4)	-1.20(p=1)	-2.17(p=1)
ΔGDP	-1.20(p=3)	-5.07(p=3)	-5.04(p=3)
ΔX	-4.53(p=1)	-6.80(p=1)	-6.88(p=1)
ΔI	-2.97(p=2)	-4.47(p=3)	-4.61(p=1)
ΔCS	-1.03(p=3)*	-4.37(p=2)	-4.44(p=1)
ΔCPI	-1.14(p=3)	-1.84(p=3)	-2.91(p=0)
ΔIND	-5.89(p=1)	-5.92(p=5)	-5.99(p=1)
ΔOP	-4.75(p=1)	-4.79(p=3)	-5.77(p=2)

GERMANY	Phillips-Perron		
	PP_ test stat		
	t_n	t_c	t_t
GDP	7.17(p=0)	1.18(p=0)	-0.42(p=0)
X	4.56(p=2)	1.02(p=2)	-3.43(p=1)*
I	2.78(p=3)	1.31(p=5)	-0.78(p=2)
CS	8.68(p=2)	-0.13(p=1)	-2.41(p=2)
CPI	6.38(p=2)	-1.91(p=1)	-3.70(p=3)*
IND	1.52(p=2)	-0.28(p=2)	-4.02(p=1)*
ΔGDP	-2.04(p=1)	-4.25(p=1)	-4.63(p=1)
ΔX	-3.52(p=0)	-6.02(p=5)	-5.35(p=1)
ΔI	-3.58(p=3)	-4.07(p=4)	-4.51(p=2)
ΔCS	-1.35(p=1)	-4.03(p=2)	-3.89(p=2)
ΔCPI	-1.93(p=1)*	-3.64(p=1)	-3.30(p=1)*
ΔIND	-5.24(p=1)	-5.51(p=1)	-5.44(p=1)

ITALY	Phillips-Perron		
	PP_ test stat		
	t_n	t_c	t_t
GDP	3.66(p=2)	-1.26(p=4)	-0.19(p=3)
X	4.03(p=3)	0.81(p=3)	-3.03(p=3)
I	1.36(p=4)	-1.44(p=3)	-0.82(p=3)
CS	4.16(p=5)	-0.92(p=3)	-1.70(p=3)
CPI	2.93(p=5)	-3.39(p=2)	1.15(p=0)
IND	0.54(p=1)	-2.41(p=1)	-1.56(p=1)
ΔGDP	-1.62(p=1)	-3.74(p=1)	-4.00(p=1)
ΔX	-4.84(p=1)	-6.64(p=3)	-6.71(p=3)

ΔI	-3.11(p=0)	-3.87(p=1)	-3.92(p=2)
ΔCS	-1.03(p=3)*	-4.37(p=2)	-4.44(p=1)
ΔCPI	-1.04(p=0)*	-2.51(p=2)	-3.72(p=0)
ΔIND	-6.20(p=1)	-6.16(p=1)	-6.50(p=3)

JAPAN	Phillips-Perron		
	PP_ test stat		
	t_n	t_c	t_t
GDP	1.54(p=5)	-3.20(p=4)*	-1.38(p=3)
X	1.73(p=3)	-0.57(p=4)	-3.30(p=1)
I	0.60(p=4)	-2.24(p=3)	-1.59(p=2)
CS	1.83(p=5)	-4.43(p=3)	-0.94(p=3)
CPI	1.81(p=4)	-7.27(p=3)	-4.12(p=3)*
OP	0.92(p=3)	-0.02(p=2)	-1.64(p=5)
IND	1.09(p=2)	-2.87(p=3)	-2.08(p=3)
ΔGDP	-2.31(p=1)	-2.936(p=3)	-3.63(p=2)
ΔX	-6.33(p=1)	-6.71(p=0)	-6.63(p=0)
ΔI	-2.66(p=3)	-2.77(p=3)*	-2.90(p=3)
ΔCS	-1.59(p=5)	-2.20(p=2)	-3.38(p=1)*
ΔCPI	-2.98(p=3)	-3.07(p=3)	-3.51(p=2)*
ΔOP	-6.11(p=1)	-6.14(p=2)	-6.74(p=3)
ΔIND	-6.76(p=1)	-7.04(p=3)	-7.56(p=3)

UK	Phillips-Perron		
	PP_ test stat		
	t_n	t_c	t_t
GDP	7.09(p=4)	2.89(p=1)	-1.57(p=1)
X	6.96(p=3)	3.10(p=3)	-0.48(p=3)
I	3.93(p=1)	0.51(p=3)	-2.37(p=1)
CS	3.26(p=4)	-0.12(p=4)	-1.85(p=4)
CPI	2.06(p=4)	-2.58(p=2)	-0.54(p=2)
IND	0.50(p=2)	-1.57(p=2)	-1.25(p=2)
ΔGDP	-0.77(p=2)*	-3.95(p=1)	-4.69(p=2)
ΔX	-3.79(p=3)	-5.96(p=3)	-7.10(p=3)
ΔI	-2.99(p=1)	-4.17(p=3)	-4.28(p=2)
ΔCS	-2.73(p=0)	-4.63(p=3)	-4.57(p=3)
ΔCPI	0.75(p=2)*	0.61(p=2)*	-0.38(p=2)*
ΔIND	-4.67(p=4)	-4.62(p=5)	-4.73(p=3)

USA	Phillips-Perron		
	PP_ test stat		
	t_n	t_c	t_t
GDP	9.44(p=3)	3.84(p=3)	-0.80(p=5)
X	3.70(p=2)	1.13(p=3)	-1.82(p=1)
I	3.61(p=3)	0.68(p=4)	-2.21(p=3)
CS	9.39(p=4)	4.64(p=1)	-0.89(p=3)
CPI	5.45(p=4)	-1.44(p=3)	-2.07(p=2)
IND	2.33(p=2)	-1.12(p=3)	-1.76(p=1)
ΔGDP	-0.49(p=3)	-3.17(p=3)	-4.20(p=3)
ΔX	-4.65(p=3)	-5.92(p=0)	-6.18(p=4)
ΔI	-2.35(p=5)*	-3.57(p=3)	-3.64(p=0)*
ΔCS	-0.07(p=3)*	-2.66(p=4)*	-4.10(p=3)*
ΔCPI	-1.04(p=3)	-4.32(p=2)	-4.37(p=4)
ΔIND	-4.32(p=0)	-4.82(p=5)	-4.77(p=5)

The critical values for the Phillips-Perron unit root tests are obtained from Dickey-Fuller (1981), t_n , t_c and t_t are the PP statistics for testing the null hypothesis the series are not I(0) when the residuals are computed from a regression equation without an intercept and time trend, with only an intercept, and with both intercept and time trend, respectively. The critical values at 1%, 5% and 10% are -2.62, -1.94, -1.61, for t_n , -3.59, -2.93, -2.60 for t_c , and for -4.19, -3.52, -3.19 for t_t , respectively.

k= bandwidth length: Newey-West using Bartlett kernel

***, **, * indicate that those values are not consistent with relative hypotheses at the 1%, 5% and 10% levels of significance relatively.

Table 3
Johansen and Juselius Cointegration Tests

CANADA

Testing Hypothesis	Johansen Test Statistics			
	Eigenvalue	Trace statistic	Critical values 5%	Prob
$H_0: r = 0$ and $r=1$	0.6591	110.3842	95.7536	0.0034
$H_0: r \leq 1$ and $r=2$	0.4687	66.2575	69.8188	0.0930
$H_0: r \leq 2$ and $r=3$	0.3472	40.3269	47.8561	0.2110

Trace test indicates 1 cointegrating eqn(s) at the 0.05 level

FRANCE

Testing Hypothesis	Johansen Test Statistics			
	Eigenvalue	Trace statistic	Critical values 5%	Prob
$H_0: r = 0$ and $r=1$	0.7100	177.5494	125.615	0.0000
$H_0: r \leq 1$ and $r=2$	0.6622	126.7876	95.7536	0.0001
$H_0: r \leq 2$ and $r=3$	0.5815	82.2829	69.8188	0.0037
$H_0: r \leq 3$ and $r=4$	0.3655	46.5610	47.8561	0.0658
$H_0: r \leq 4$ and $r=5$	0.3224	27.9054	29.7970	0.0814

Trace test indicates 3 cointegrating eqn(s) at the 0.05 level

GERMANY

Testing Hypothesis	Johansen Test Statistics			
	Eigenvalue	Trace statistic	Critical values 5%	Prob
$H_0: r = 0$ and $r=1$	0.9124	163.9883	95.7536	0.0000
$H_0: r \leq 1$ and $r=2$	0.8864	103.1090	69.8188	0.0004
$H_0: r \leq 2$ and $r=3$	0.6019	48.7235	47.8561	0.0056
$H_0: r \leq 3$ and $r=4$	0.4512	25.6964	29.7970	0.0145

Trace test indicates 3 cointegrating eqn(s) at the 0.05 level

ITALY

Testing Hypothesis	Johansen Test Statistics			
	Eigenvalue	Trace statistic	Critical values 5%	Prob
$H_0: r = 0$ and $r=1$	0.6666	136.0774	95.7536	.0000
$H_0: r \leq 1$ and $r=2$	0.5644	91.0399	69.8188	0.0004
$H_0: r \leq 2$ and $r=3$	0.4255	56.9584	47.8561	0.0056
$H_0: r \leq 3$ and $r=4$	0.3341	34.2278	29.7970	0.0145
$H_0: r \leq 4$ and $r=5$	0.3335	17.5523	15.4947	.0242

Trace test indicates 5 cointegrating eqn(s) at the 0.05 level

JAPAN

Testing Hypothesis	Johansen Test Statistics			
	Eigenvalue	Trace statistic	Critical values 5%	Prob
$H_0: r = 0$ and $r=1$	0.733875	183.7098	125.6154	0.0000
$H_0: r \leq 1$ and $r=2$	0.635149	129.4345	95.75366	0.0000
$H_0: r \leq 2$ and $r=3$	0.509006	88.09563	69.81889	0.0009
$H_0: r \leq 3$ and $r=4$	0.489684	58.93141	47.85613	0.0033
$H_0: r \leq 4$ and $r=5$	0.335676	31.34967	29.79707	0.0329

Trace test indicates 5 cointegrating eqn(s) at the 0.05 level

UK

Testing Hypothesis	Johansen Test Statistics			
	Eigenvalue	Trace statistic	Critical values 5%	Prob
$H_0: r = 0$ and $r=1$	0.6481	122.8969	95.7536	0.0002
$H_0: r \leq 1$ and $r=2$	0.5268	80.0680	69.8188	0.0061
$H_0: r \leq 2$ and $r=3$	0.4296	49.3888	47.8561	0.0356
$H_0: r \leq 3$ and $r=4$	0.3271	26.3677	29.7970	0.1181

Trace test indicates 3 cointegrating eqn(s) at the 0.05 level

USA

Testing Hypothesis	Johansen Test Statistics			
	Eigenvalue	Trace statistic	Critical Values 5%	Prob
$H_0: r = 0$ and $r=1$	0.7114	174.4127	117.7082	0.0000
$H_0: r \leq 1$ and $r=2$	0.6526	123.4547	88.8038	0.0000
$H_0: r \leq 2$ and $r=3$	0.5279	80.0957	63.8761	0.0012
$H_0: r \leq 3$ and $r=4$	0.4661	49.3216	42.9152	0.0101
$H_0: r \leq 4$ and $r=5$	0.2777	23.5919	25.8721	0.0936
$H_0: r \leq 5$ and $r=6$	0.2212	10.2509	12.5179	0.1162

Trace test indicates 4 cointegrating eqn(s) at the 0.05 level

* denotes rejection of the hypothesis at the 0.05 level

**MacKinnon-Haug-Michelis (1999) p-values

Table 4.1: Regression results for Equation (1) with 2-SLS

	Canada	France	Germany	Italy	Japan	United Kingdom	USA
Constant	0.0260 (0.0103)	0.0568 (0.0000)	0.1491 (0.1121)	-0.0402 (0.1351)	0.0370 (0.0090)	-0.0206 (0.0158)	0.0374 (0.0000)
X_t X_{t-i}	0.1393 (0.0000) _t	0.1168 (0.0045) _t	0.2691 (0.0001) _t	0.1918 (0.0099) _t	0.0738 (0.0064) _t	0.3286 (0.0000) _t	0.0419 (0.0001) _{t-2}
I_t I_{t-i}	0.2239 (0.0001) _t	0.2413 (0.0075) _t	0.2853 (0.0000) _{t-1}	0.4835 (0.0000) _t	0.2632 (0.0045) _{t-1}	0.4889 (0.0000) _t	0.0918 (0.0000) _t
CS_t CS_{t-i}	0.6051 (0.0000) _t	0.6168 (0.0000) _{t-2}	0.3107 (0.0821) _{t-1}	0.3763 (0.0005) _t	0.0609 (0.0000) _{t-1}	0.1924 (0.0036) _{t-1}	0.8283 (0.0000) _t
AR(1)	0.8024 (0.0000)						0.8099 (0.0000)
R²	0.9997	0.9982	0.9929	0.9934	0.9935	0.9974	0.9999
DW	1.5809	0.3020	1.1375	0.4265	0.8823	0.6784	2.1581

Table 4.2: Regression results for Equation (1) with 2-SLS

	Canada	France	Germany	Italy	Japan	United Kingdom	USA
Constant	-0.4758 (0.0000)	-0.0685 (0.0893)	-1.1177 (0.0000)	-0.0810 (0.2901)	0.0740 (0.6766)	-0.0029 (0.8152)	-0.7703 (0.0139)
GDP_t GDP_{t-i}	0.3423 (0.0000) _t	0.6087 (0.0012) _t	0.8473 (0.0000) _t	0.6053 (0.0008) _{t-6}	0.5712 (0.0669) _t	0.1782 (0.0652) _t	0.7186 (0.0014) _{t-1}
IND_t IND_{t-i}	0.8096 (0.0000) _t		0.9952 (0.0000) _t	0.1421 (0.0709) _t	0.6000 (0.1828) _{t-1}		0.9874 (0.0000) _t
X_t X_{t-i}	0.3491 (0.0002) _{t-1}	0.5222 (0.0007) _{t-2}	0.2626 (0.0011) _{t-1}	0.4536 (0.0045) _{t-1}		0.8575 (0.0000) _{t-1}	
AR(1)							0.9258 (0.0000)
R²	0.9920	0.9819	0.9959	0.9846	0.7113	0.9923	0.9907
DW	1.1292	1.0074	1.4124	1.5388	0.1107	2.0545	1.2611

Table 4.3: Regression results for Equation (1) with 2-SLS

	Canada	France	Germany	Italy	Japan	United Kingdom	USA
Constant	-0.0066 (0.5631)	-0.4263 (0.0127)	-0.5746 (0.0558)	-0.3455 (0.0000)	-0.7813 (0.0000)	-0.2713 (0.0046)	-0.1469 (0.0013)
GDP_t	0.3040 (0.0018) _t			0.7924 (0.0000) _t			
GDP_{t-i}		0.6610 (0.0000) _{t-2}	0.8051 (0.0002) _{t-1}		0.2439 (0.0267) _{t-1}	0.9717 (0.0000) _{t-1}	0.1970 (0.0729) _{t-2}
IND_t			0.7677 (0.0000) _t		0.4492 (0.0003) _t	0.4060 (0.0001) _t	0.3908 (0.0001) _t
IND_{t-i}		0.1926 (0.1184*) _{t-1}		0.4801 (0.0000) _{t-2}			
I_t							
I_{t-i}	0.7225 (0.0000) _{t-1}						0.6227 (0.0000) _{t-1}
OP_t		0.2810 (0.0001) _t			0.5606 (0.0000) _t		
AR(1)		0.8235 (0.0000)	0.8917 (0.0000)		0.7244 (0.0000)		
R²	0.9932	0.9920	0.9769	0.9761	0.9886	0.9828	0.9920
DW	1.7194	1.2323	1.3279	0.6607	1.5699	0.4570	0.7151

Table 4.4: Regression results for Equation (1) with 2-SLS

	Canada	France	Germany	Italy	Japan	United Kingdom	USA
Constant	0.0146 (0.0057)	0.0565 (0.0013)	0.0353 (0.4459)	1.7156 (0.1844)	0.7390 (0.0001)	3.1129 (0.3315)	-0.0060 (0.5329)
GDP_t	0.4910 (0.0000) _t	0.9403 (0.0000) _t		0.4522 (0.0002) _t			0.8751 (0.0000) _t
GDP_{t-i}			0.1643 (0.0712) _{t-4}		0.9339 (0.3137*) _{t-2}	0.3808 (0.1233*) _{t-2}	
CPI_t							-0.0553 (0.0733) _t
CPI_{t-i}	-0.0233 (0.0953) _{t-1}	-0.1027 (0.0263) _{t-4}	-0.1351 (0.3674*) _{t-1}	-0.3374 (0.0652) _{t-2}		-0.5687 (0.0358) _{t-2}	
CS_{t-i}	0.5550 (0.0000) _{t-2}	0.0942 (0.1053*) _{t-5}	0.9025 (0.0000) _{t-1}	0.3086 (0.0208) _{t-2}	0.8372 (0.0000) _{t-1}		0.1882 (0.0146) _{t-1}
IND_{t-i}			0.0634 (0.1259*) _t				
AR(1)		0.8218 (0.0000)		0.9895 (0.0000)	0.5724 (0.0001)	0.9894 (0.0000)	0.5191 (0.0005)
R²		0.9997	0.9973	0.9991	0.9975	0.9966	0.9999
DW		1.9031	1.2796	1.2790	2.0177	1.4976	1.7099

Figure 1
Graph of system equation model

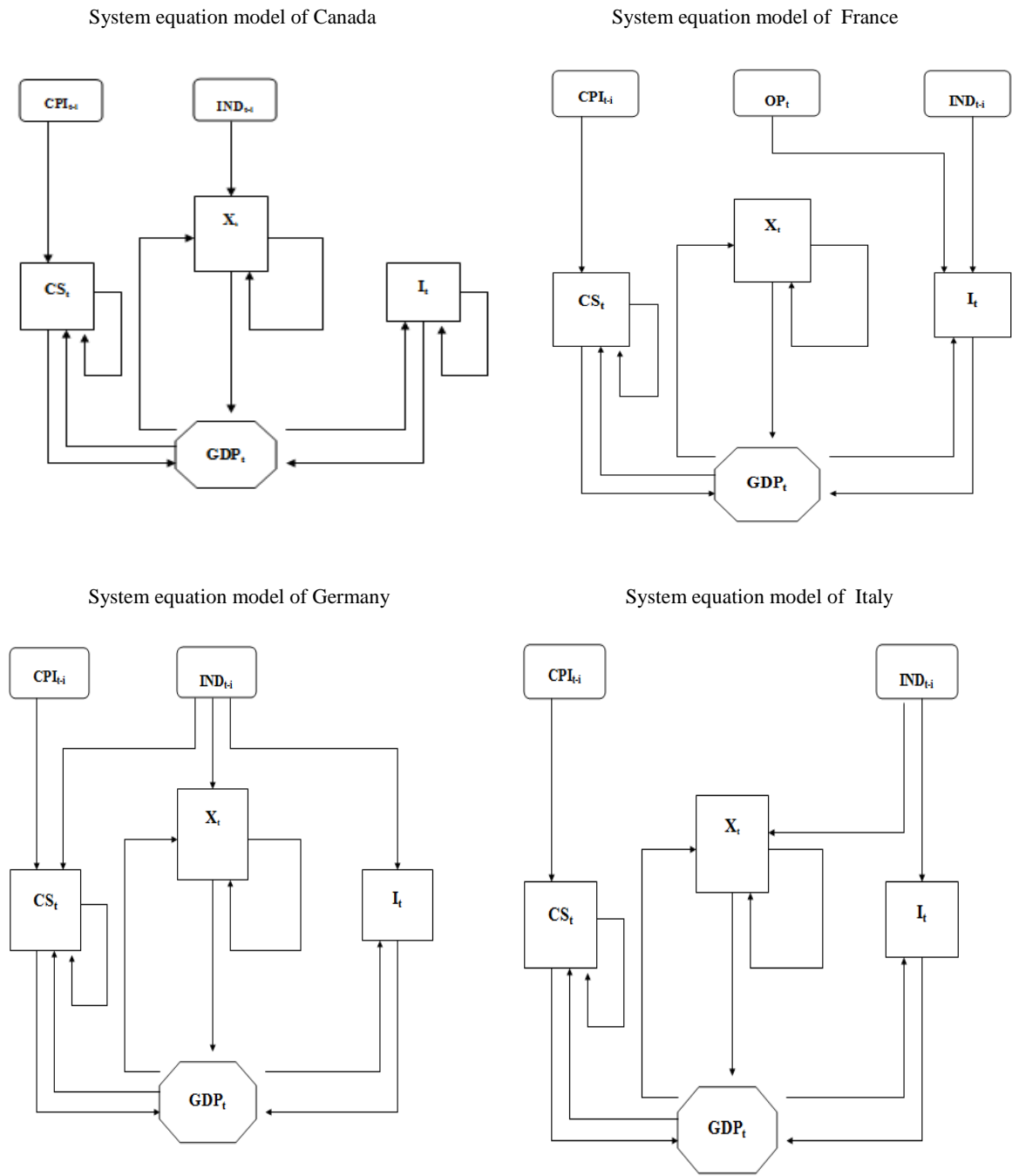

System equation model of Japan

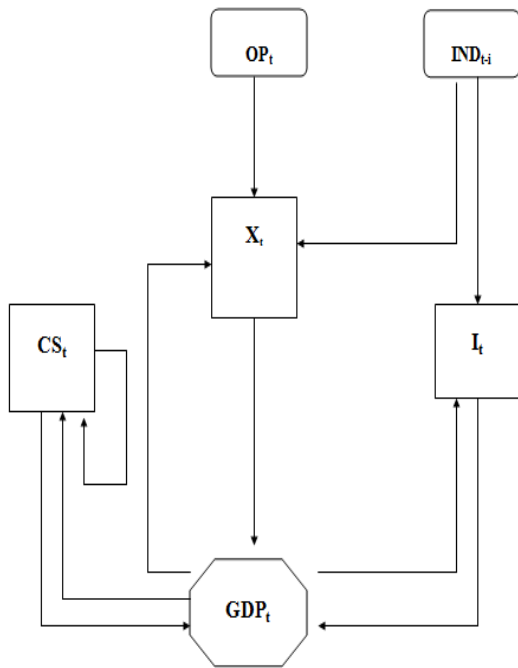

System equation model of United Kingdom

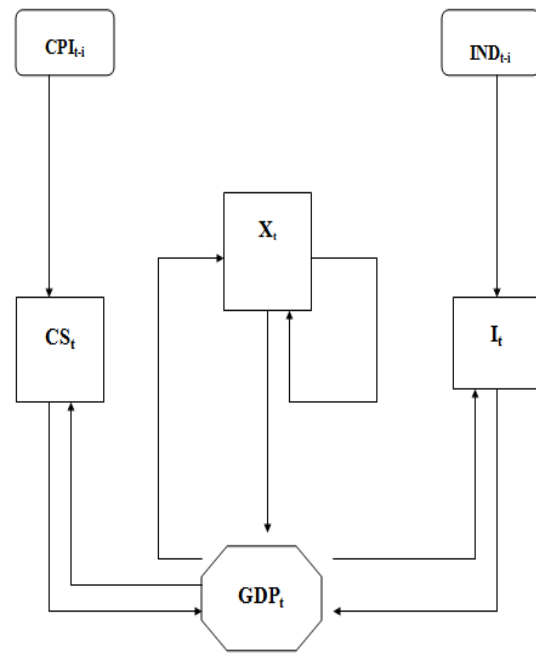

System equation model of USA

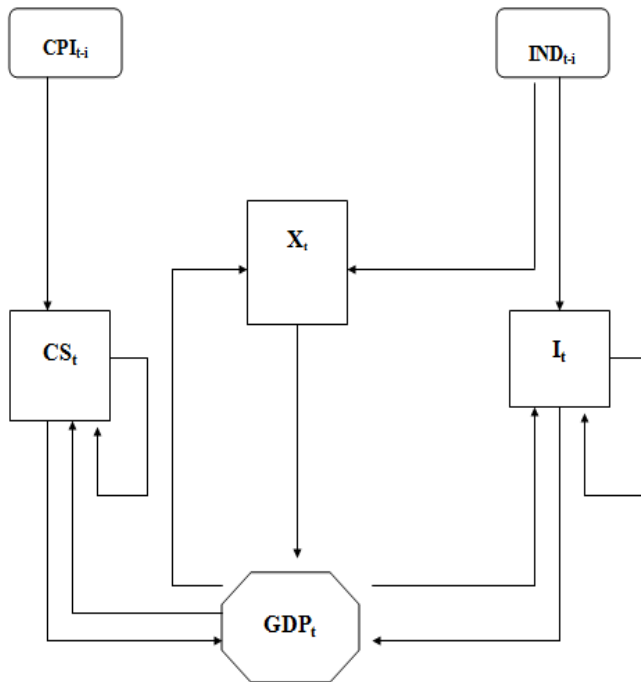

Table 4.5

Theoretical conclusions of empirical analysis for G-7 countries
for Economic Growth Function

G7 countries	Theoretical conclusions of empirical analysis	Functional Relations
CANADA	<i>The increase of exports (X), investments (I) and consumption (CS) cause increase of economic growth (GDP)</i>	$\uparrow X \Rightarrow \uparrow GDP$ $\uparrow I \Rightarrow \uparrow GDP$ $\uparrow CS \Rightarrow \uparrow GDP$ $\uparrow X \Rightarrow \uparrow I \Rightarrow \uparrow CS \Rightarrow \uparrow GDP$
FRANCE	<i>The increase of exports (X), investments (I) and consumption (CS) cause increase of economic growth (GDP)</i>	$\uparrow X \Rightarrow \uparrow GDP$ $\uparrow I \Rightarrow \uparrow GDP$ $\uparrow CS \Rightarrow \uparrow GDP$ $\uparrow X \Rightarrow \uparrow I \Rightarrow \uparrow CS \Rightarrow \uparrow GDP$
GERMANY	<i>The increase of exports (X), investments (I) and consumption (CS) cause increase of economic growth (GDP)</i>	$\uparrow X \Rightarrow \uparrow GDP$ $\uparrow I \Rightarrow \uparrow GDP$ $\uparrow CS \Rightarrow \uparrow GDP$ $\uparrow X \Rightarrow \uparrow I \Rightarrow \uparrow CS \Rightarrow \uparrow GDP$
ITALY	<i>The increase of exports (X), investments (I) and consumption (CS) cause increase of economic growth (GDP)</i>	$\uparrow X \Rightarrow \uparrow GDP$ $\uparrow I \Rightarrow \uparrow GDP$ $\uparrow CS \Rightarrow \uparrow GDP$ $\uparrow X \Rightarrow \uparrow I \Rightarrow \uparrow CS \Rightarrow \uparrow GDP$
JAPAN	<i>The increase of exports (X), investments (I) and consumption (CS) cause increase of economic growth (GDP)</i>	$\uparrow X \Rightarrow \uparrow GDP$ $\uparrow I \Rightarrow \uparrow GDP$ $\uparrow CS \Rightarrow \uparrow GDP$ $\uparrow X \Rightarrow \uparrow I \Rightarrow \uparrow CS \Rightarrow \uparrow GDP$
UNITED KINGDOM	<i>The increase of exports (X), investments (I) and consumption (CS) cause increase of economic growth (GDP)</i>	$\uparrow X \Rightarrow \uparrow GDP$ $\uparrow I \Rightarrow \uparrow GDP$ $\uparrow CS \Rightarrow \uparrow GDP$ $\uparrow X \Rightarrow \uparrow I \Rightarrow \uparrow CS \Rightarrow \uparrow GDP$
USA	<i>The increase of exports (X), investments (I) and consumption (CS) cause increase of economic growth (GDP)</i>	$\uparrow X \Rightarrow \uparrow GDP$ $\uparrow I \Rightarrow \uparrow GDP$ $\uparrow CS \Rightarrow \uparrow GDP$ $\uparrow X \Rightarrow \uparrow I \Rightarrow \uparrow CS \Rightarrow \uparrow GDP$

Table 4.6

Theoretical conclusions of empirical analysis for G-7 countries
for Exports Function

G7 countries	Theoretical conclusions of empirical analysis	Functional Relations
CANADA	<i>The increase of economic growth (GDP) and industrial production (IND) cause increase of exports (X)</i>	$\uparrow GDP \Rightarrow \uparrow X$ $\uparrow IND \Rightarrow \uparrow X$ $\uparrow IND \Rightarrow \uparrow GDP \Rightarrow X$
FRANCE	<i>The increase of economic growth (GDP) causes increase of exports (X)</i>	$\uparrow GDP \Rightarrow \uparrow X$
GERMANY	<i>The increase of economic growth (GDP) and industrial production (IND) cause increase of exports (X)</i>	$\uparrow GDP \Rightarrow \uparrow X$ $\uparrow IND \Rightarrow \uparrow X$ $\uparrow IND \Rightarrow \uparrow GDP \Rightarrow X$
ITALY	<i>The increase of economic growth (GDP) and industrial production (IND) cause increase of exports (X)</i>	$\uparrow GDP \Rightarrow \uparrow X$ $\uparrow IND \Rightarrow \uparrow X$ $\uparrow IND \Rightarrow \uparrow GDP \Rightarrow X$
JAPAN	<i>The increase of economic growth (GDP) and industrial production (IND) cause increase of exports (X)</i>	$\uparrow GDP \Rightarrow \uparrow X$ $\uparrow IND \Rightarrow \uparrow X$ $\uparrow IND \Rightarrow \uparrow GDP \Rightarrow X$
UNITED KINGDOM	<i>The increase of economic growth (GDP) causes increase of exports (X)</i>	$\uparrow GDP \Rightarrow \uparrow X$
USA	<i>The increase of economic growth (GDP) and industrial production (IND) cause increase of exports (X)</i>	$\uparrow GDP \Rightarrow \uparrow X$ $\uparrow IND \Rightarrow \uparrow X$ $\uparrow IND \Rightarrow \uparrow GDP \Rightarrow X$

Table 4.7

Theoretical conclusions of empirical analysis for G-7 countries
for Investments Function

G7 countries	Theoretical conclusions of empirical analysis	Functional Relations
CANADA	<i>The increase of economic growth (GDP) causes increase of investments (I)</i>	$\uparrow GDP \Rightarrow \uparrow I$
FRANCE	<i>The increase of economic growth (GDP), industrial production (IND) and trade of openness (OP) cause increase of investments (I)</i>	$\uparrow GDP \Rightarrow \uparrow I$ $\uparrow IND \Rightarrow \uparrow I$ $\uparrow OP \Rightarrow \uparrow I$ $\uparrow OP \Rightarrow \uparrow IND \Rightarrow \uparrow GDP \Rightarrow \uparrow I$
GERMANY	<i>The increase of economic growth (GDP), and industrial production (IND) cause increase of investments (I)</i>	$\uparrow GDP \Rightarrow \uparrow I$ $\uparrow IND \Rightarrow \uparrow I$ $\uparrow IND \Rightarrow \uparrow GDP \Rightarrow \uparrow I$

ITALY	<i>The increase of economic growth (GDP), and industrial production (IND) cause increase of investments (I)</i>	$\uparrow GDP \Rightarrow \uparrow I$ $\uparrow IND \Rightarrow \uparrow I$ $\uparrow IND \Rightarrow \uparrow GDP \Rightarrow \uparrow I$
JAPAN	<i>The increase of economic growth (GDP), industrial production (IND) and trade of openness (OP) cause increase of investments (I)</i>	$\uparrow GDP \Rightarrow \uparrow I$ $\uparrow IND \Rightarrow \uparrow I$ $\uparrow OP \Rightarrow \uparrow I$ $\uparrow OP \Rightarrow \uparrow IND \Rightarrow \uparrow GDP \Rightarrow \uparrow I$
UNITED KINGDOM	<i>The increase of economic growth (GDP), and industrial production (IND) cause increase of investments (I)</i>	$\uparrow GDP \Rightarrow \uparrow I$ $\uparrow IND \Rightarrow \uparrow I$ $\uparrow IND \Rightarrow \uparrow GDP \Rightarrow \uparrow I$
USA	<i>The increase of economic growth (GDP), and industrial production (IND) cause increase of investments (I)</i>	$\uparrow GDP \Rightarrow \uparrow I$ $\uparrow IND \Rightarrow \uparrow I$ $\uparrow IND \Rightarrow \uparrow GDP \Rightarrow \uparrow I$

Table 4.8 Theoretical conclusions of empirical analysis for G-7 countries for Consumption Function

G7 countries	Theoretical conclusions of empirical analysis	Functional Relations
CANADA	<i>The decrease of consumer price index (CPI) causes increase of economic growth (GDP) and consumption (CS)</i>	$\uparrow GDP \Rightarrow \uparrow CS$ $\downarrow CPI \Rightarrow \uparrow CS$ $\downarrow CPI \Rightarrow \uparrow GDP \Rightarrow \uparrow CS$
FRANCE	<i>The decrease of consumer price index (CPI) causes increase of economic growth (GDP) and consumption (CS)</i>	$\uparrow GDP \Rightarrow \uparrow CS$ $\downarrow CPI \Rightarrow \uparrow CS$ $\downarrow CPI \Rightarrow \uparrow GDP \Rightarrow \uparrow CS$
GERMANY	<i>The decrease of consumer price index (CPI) causes increase of economic growth (GDP) and consumption (CS)</i>	$\uparrow GDP \Rightarrow \uparrow CS$ $\downarrow CPI \Rightarrow \uparrow CS$ $\downarrow CPI \Rightarrow \uparrow GDP \Rightarrow \uparrow CS$
ITALY	<i>The decrease of consumer price index (CPI) causes increase of economic growth (GDP) and consumption (CS)</i>	$\uparrow GDP \Rightarrow \uparrow CS$ $\downarrow CPI \Rightarrow \uparrow CS$ $\downarrow CPI \Rightarrow \uparrow GDP \Rightarrow \uparrow CS$
JAPAN	<i>The increase of economic growth (GDP) causes increase of consumption (CS)</i>	$\uparrow GDP \Rightarrow \uparrow CS$
UNITED KINGDOM	<i>The decrease of consumer price index (CPI) causes increase of economic growth (GDP) and consumption (CS)</i>	$\uparrow GDP \Rightarrow \uparrow CS$ $\downarrow CPI \Rightarrow \uparrow CS$ $\downarrow CPI \Rightarrow \uparrow GDP \Rightarrow \uparrow CS$
USA	<i>The decrease of consumer price index (CPI) causes increase of economic growth (GDP) and consumption (CS)</i>	$\uparrow GDP \Rightarrow \uparrow CS$ $\downarrow CPI \Rightarrow \uparrow CS$ $\downarrow CPI \Rightarrow \uparrow GDP \Rightarrow \uparrow CS$

Therefore, the results of estimated system equations model indicated that

- Exports and investments in conjunction with consumption have a positive direct effect on economic growth for G7 countries
- Industrial production has a positive indirect effect on economic growth in France, Italy, Japan, United Kingdom and USA through investments effect
- Industrial production has a positive indirect effect on economic growth in Canada, Germany, Italy, Japan and USA through exports effect
- Inflation has an indirect effect on economic growth in all G7 countries through consumption effect except for Japan
- Trade of openness has a positive indirect effect on economic growth in France through investments effect
- Trade of openness has a positive indirect effect on economic growth in Japan through exports effect
- Economic growth has a positive direct effect on exports, investments and consumption for G7 countries

4.1 Sensitivity analysis results

Estimating the system equation models with Monte Carlo simulation method we can infer that the estimated simulated values are very close to actual one, so the models are very well simulated (Figure 2).

Figure 2

Monte Carlo simulation models

CANADA

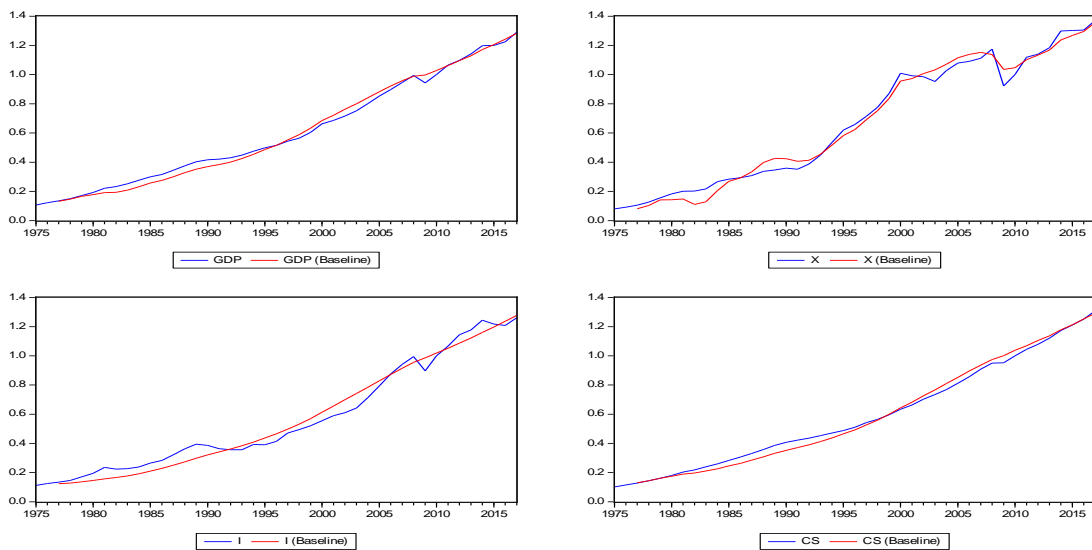

FRANCE

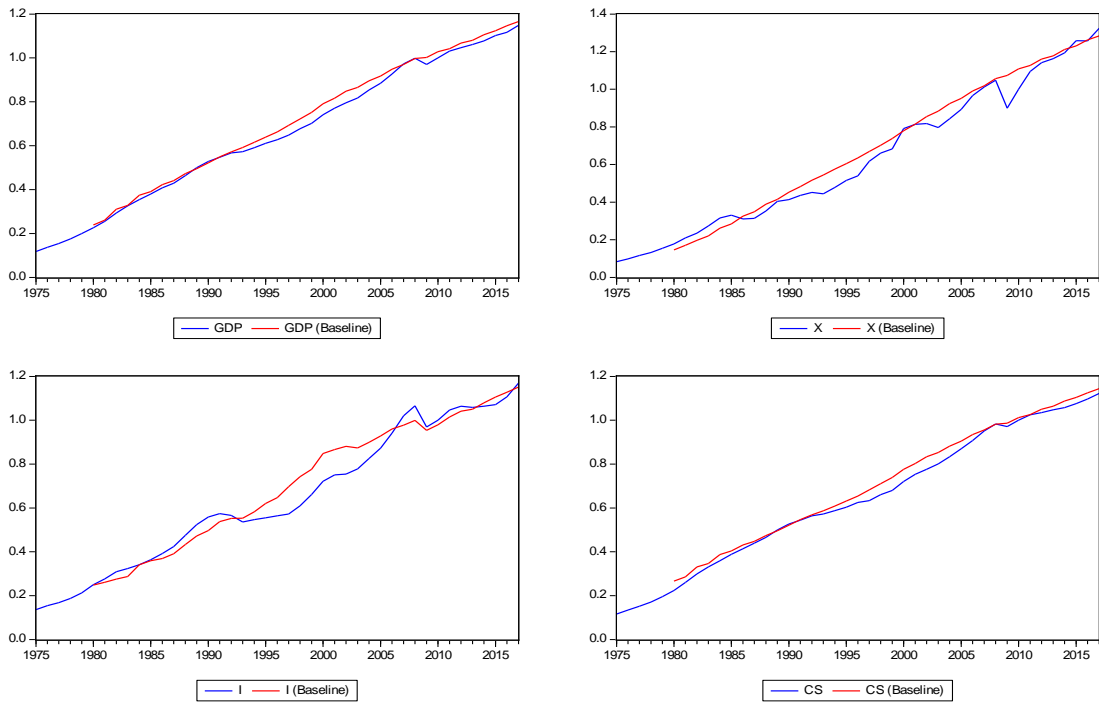

GERMANY

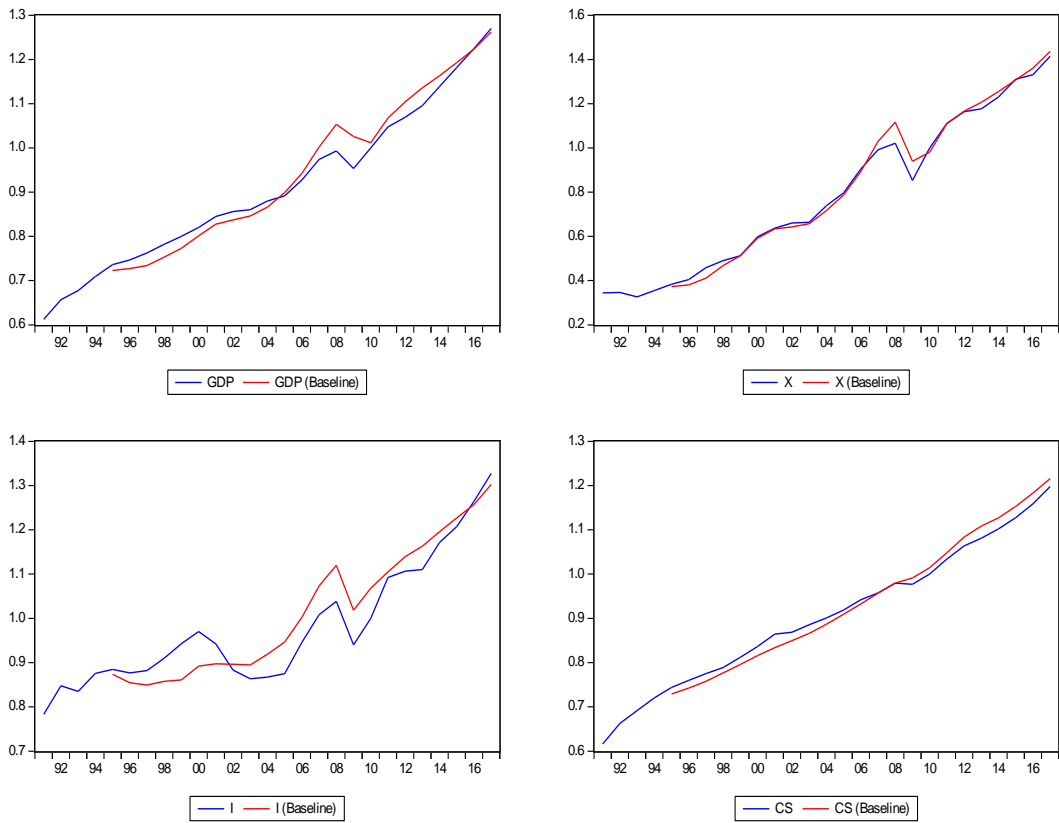

ITALY

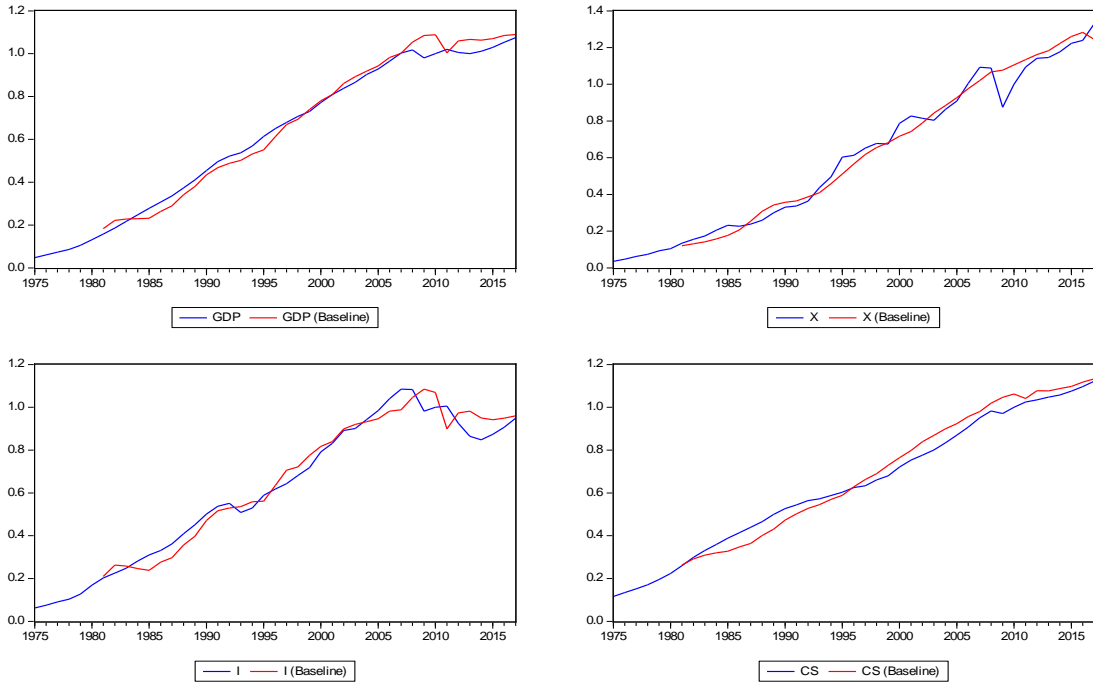

JAPAN

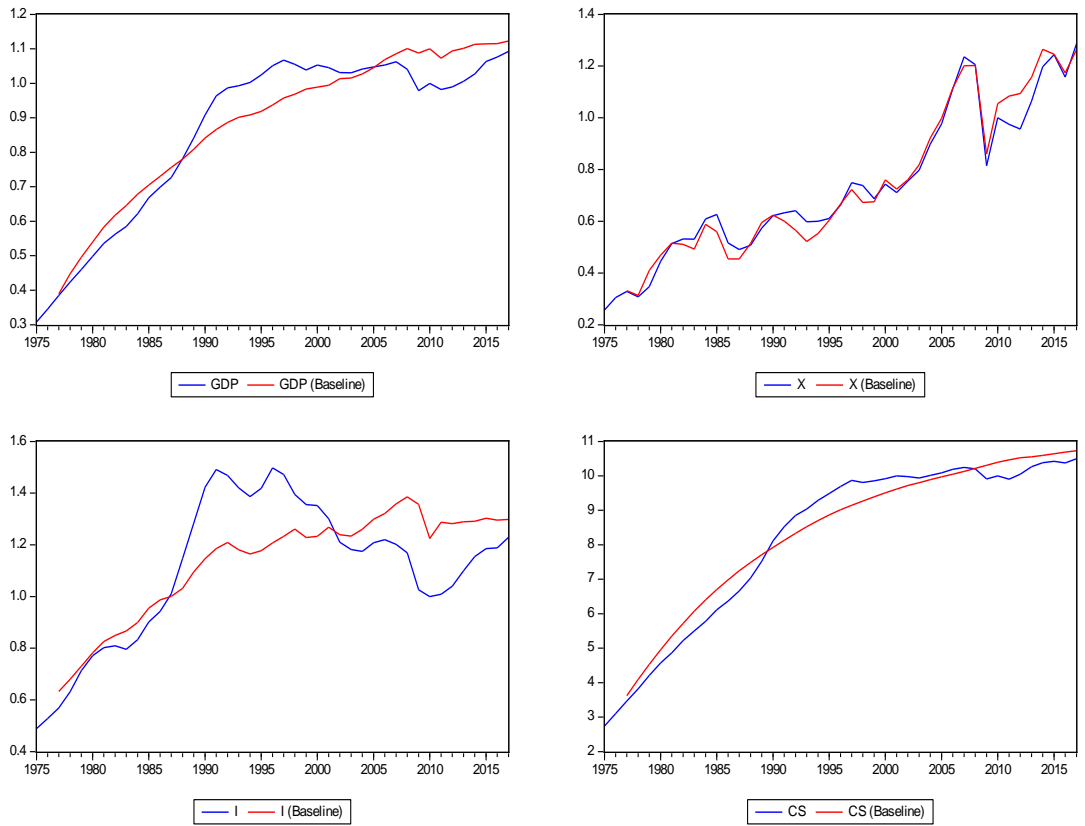

UNITED KINGDOM

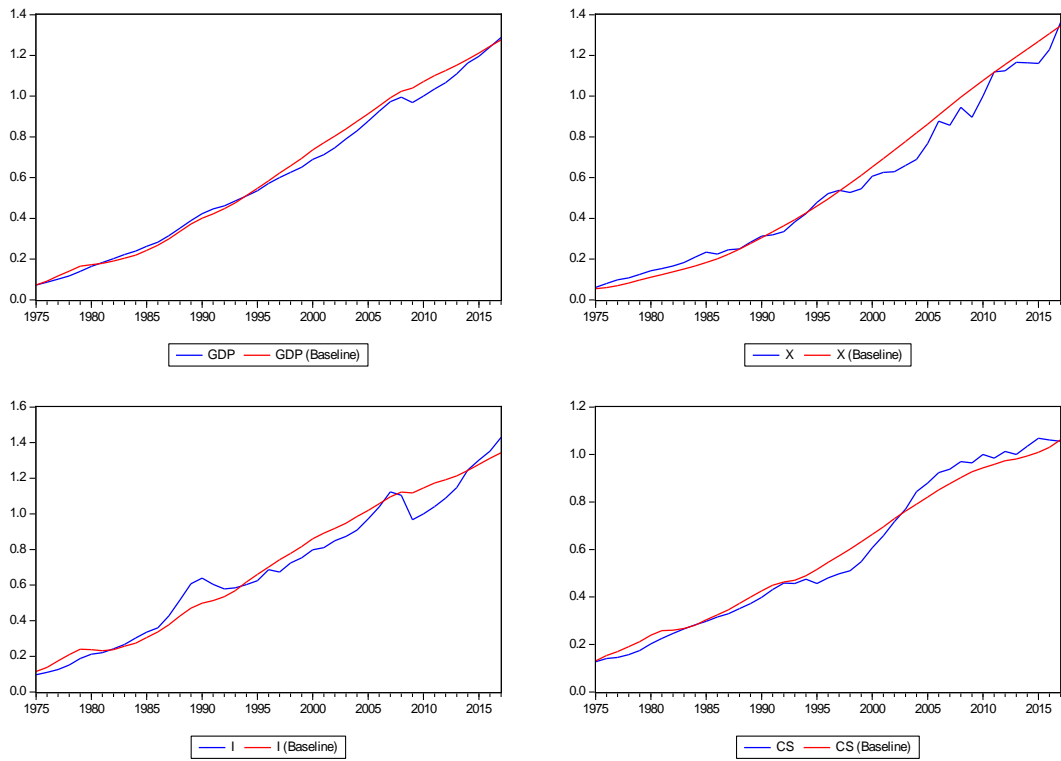

USA

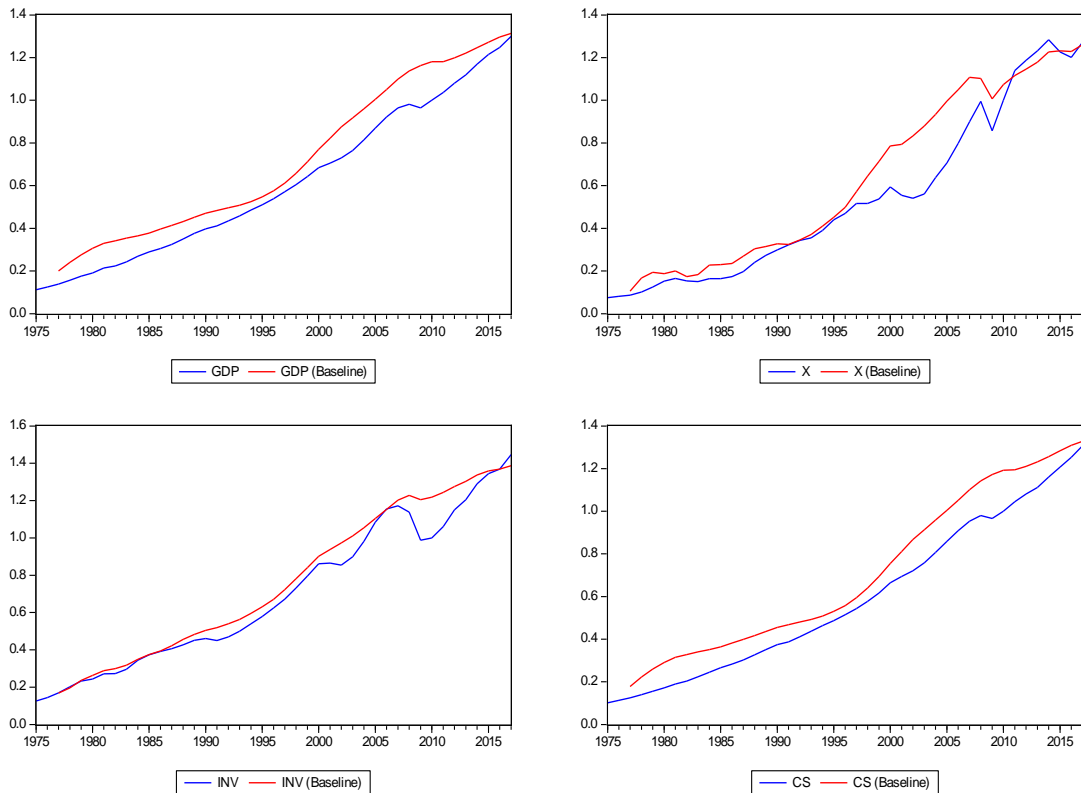

The results of estimated inequalities ratios indices of Theil, suggested that there is a good predictive ability of simulated system equation models (Table 5, Figure 3).

Table 5

Estimations of inequalities ratios indices for G7 countries (U-Theil index)

G7 countries	U-Theil _{GDP}	U-Theil _X	U-Theil _I	U-Theil _{CS}
CANADA (CAN)	0.0212	0.0285	0.0390	0.0217
FRANCE (FR)	0.0178	0.0372	0.0406	0.0200
GERMANY (GER)	0.0143	0.0179	0.0240	0.0093
ITALY (ITA)	0.0256	0.0360	0.0364	0.0291
JAPAN (JPN)	0.0363	0.0289	0.0721	0.0243
UNITED KINGDOM (UK)	0.0228	0.0414	0.0430	0.0320
USA (US)	0.0680	0.0907	0.0454	0.0730

Figure 3
Graph of U-Theil index

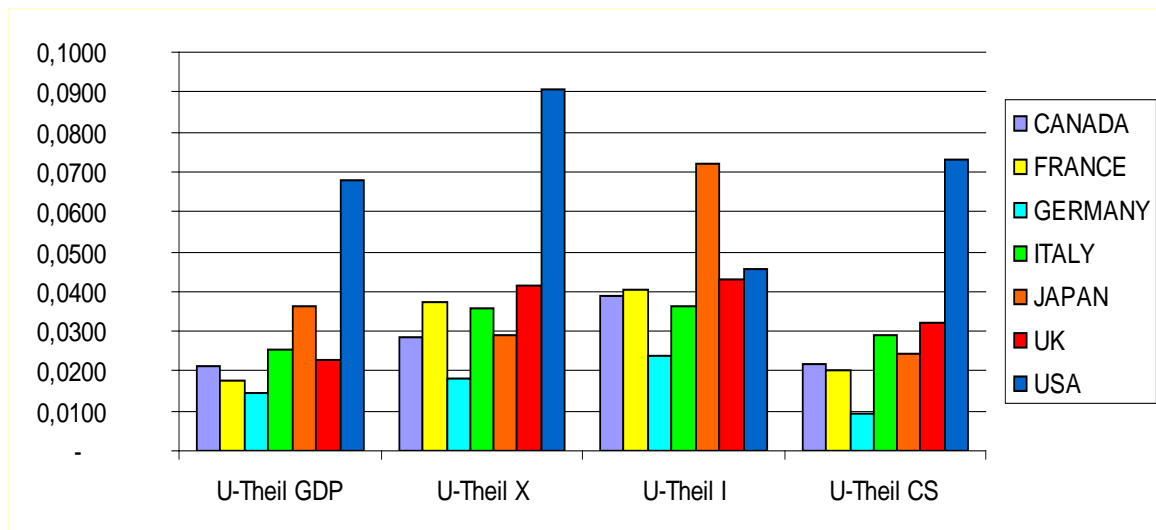

Based on U-Theil indices for each dependent variable of the estimated equation models, we can classify G7 countries as follows:

For U-Theil index of GDP_t

- 0.0143 < 0.0178 < 0.0212 < 0.0228 < 0.0256 < 0.0363 < 0.0680

(GER < FR < CAN < UK < IT < JPN < US)

For U-Theil index of X_t

- $0.0179 < 0.0285 < 0.0289 < 0.0360 < 0.0372 < 0.0414 < 0.0907$
(GER < CAN < JPN < IT < FR < UK < US)

For U-Theil index of I_t

- $0.0240 < 0.0364 < 0.0390 < 0.0406 < 0.0430 < 0.0454 < 0.0721$
(GER < IT < CAN < FR < UK < US < JPN)

For U-Theil index of CS_t

- $0.0093 < 0.0200 < 0.0217 < 0.0243 < 0.0291 < 0.0320 < 0.0730$
(GER < FR < CAN < JPN < IT < UK < US)

Comparing the values of U-Theil indices for all dependent variables, namely gross domestic product, exports, investments and consumption, we can infer that

- U-Theil index for gross domestic product, exports and consumption has the lower value in Germany, while in USA has the larger one
- U-Theil index for investments has the lower value in Germany while in Japan has the larger one
- The smaller inequalities ratios indices the better predictive ability of the system equation model.
- Germany has the best simulated equation model comparing the U-Theil indices for dependents variables in G7 countries

5. Policy implications

This study is mainly concentrated on analyzing some basic determinants of economic growth including consumption, investments and trade of openness, inflation and industrial production based on estimation of a classical Keynesian macroeconomic model. This model should include more macroeconomic variables as human capital savings, unemployment, banking sector, but the main objective of this study was to examine the direct effect of exports, consumption and investments on economic growth in order to make simulation policies and sensitivity analysis by using Monte Carlo simulation method. The estimations of inequalities ratios indices tended to be useful for important policy implications comparing the different values for each case. Based on U-Theil indices for each dependent variable of the estimated equation models, it was easier to classify the G7 countries and find out the best system equation models. The limitations of this study are referred to the main determinants of economic growth excluding the effect of other important factors as human capital or technology on economic growth. This limitation consist an important incentive for future empirical studies.

6. Conclusions

The purpose of this paper is to examine the relationship among exports, investments consumption and economic growth for all G7 countries for the period 1975-2017 except for Germany (1991-2017) estimating a simultaneous system equations model by the *two-stage least squared* method. This model is consisted by four linear equations which represent the effect of exports, investments and consumption on economic growth taking into account the

empirical studies of Rivera and Romer (1991), Katsouli (2006), Vazakidis (2006) and Adamopoulos (2019).

The Group of Seven countries (G7) is a group consisting of Canada, France, Germany, Italy, Japan, United Kingdom, and USA regarded as the most advanced countries worldly. Furthermore, a system equation model is estimated for G7 countries applying a Monte Carlo simulation method, in order to find out the predictive ability of the equation model.

The results of estimated system equations model indicated that exports and investments in conjunction with consumption have a positive direct effect on economic growth for G7 countries. Industrial production has a positive indirect effect on economic growth in France, Italy, Japan, United Kingdom and USA through investments effect, while in Canada, Germany, Italy, Japan and USA has a positive indirect effect on economic growth through exports effect. Finally, inflation has an indirect effect on economic growth in all G7 countries through consumption effect except for Japan.

Furthermore, the empirical results of the Monte Carlo simulation method indicated that the system equation models for all G7 countries are very well simulated, since the simulated values are close to actual values of examined variables.

Comparing the values of U-Theil indices for all dependent variables we can infer that Germany has the best simulated equation model. The smaller inequalities ratios indices the better predictive ability of the system equation model exists. Many empirical studies examining the main determinants of economic growth differ relatively to the sample period, the examined countries and the estimation methodology. The empirical results of this paper are agreed with the studies of Vazakidis (2006) and Adamopoulos (2019). However, more interest should be focused on the comparative analysis of empirical results for many other countries in future research.

References

- Adamopoulos, A. (2019) "An empirical analysis of simulated model of economic growth for United Kingdom", *Journal of Statistical and Econometric Methods*, 8(3), 1-19
- AMECO (2018). European Commission Statistical database, http://ec.europa.eu/economy_finance/ameco/user/serie/SelectSerie.cfm
- Bahmani-Oskooee, M., and Nirromand, F., (1999). Openness and economic growth: an empirical investigation, *Applied Economics Letters*, 6, 557-561.
- Balaguer, J., and Jorda, M., (2004). Structural change in exports and economic growth: Cointegration and causality analysis for Spain (1961-2000), *Applied Economics*, 36, 473-477.
- Balassa, B., (1978). Export and Economic Growth: Further Evidence, *Journal of Development Economics*, 5, 181-189.
- Bhagwati, J., (1978). *Foreign Exchange Regimes and Economic Development: Anatomy and Consequences of Exchange Control Regimes*, Ballinger, Cambridge.
- Chang, T., (2002) An econometric test of Wagner's law for six countries based on cointegration and error-correction modelling techniques, *Applied Economics*, 34(9), 1157-1169
- Chang, T., and Caudill, S., (2005) Financial development and economic growth: the case of Taiwan, *Applied Economics*, 37, 1329-1335
- Chang, R., Kaltani, L., and Loayza, N. (2009) "Openness can be good for growth: The role of policy complementarities", *Journal of Development Economics*, 90, 33-49.

- Choi, I. (1992). Effects of data aggregation on the power of the tests for a unit root, *Economics Letters*, 40, 397-401.
- De Mello, L., (1997). Foreign direct investment in developing countries and growth: A survey, *Journal of Development Studies*, 34, 1-34.-De la Fuente, A. and Marin, J. (1996) Innovation, Bank Monitoring, and Endogenous Financial Development, *Journal of Monetary Economics*, 38, 269-301.
- Dickey, D. and W. Fuller (1979). Distributions of the estimators for autoregressive time series with a unit root, *Journal of American Statistical Association*, 74, 427-431.
- Dritsaki, M. and Adamopoulos, A. (2003) Exports and Economic Growth in less Developing Countries of European Union, *Rivista Internazionale de Scienze Economiche e Commerciali*, 50(2), 249-257.
- Dritsaki, C., Vazakides, A. and Adamopoulos, A. (2004) Exports, investments and economic growth: An empirical investigation of the three Baltic countries, *Baltic Journal of Economics*, 4(2), 72-79.
- Dritsakis, N., Varelas, E. and Adamopoulos, A. (2006) The main determinants of economic growth: An empirical analysis for Greece with Granger causality analysis, *European Research Studies Journal*, IX(3-4), 47-58.
- Dutt, S., and Ghosh, D. (1994) An empirical investigation of the export growth-economic growth relationship, *Applied Economics Letters*, 1, 44-48.
- Eviews 9.0 (2015). *Quantitative Micro Software*, Irvine, California.
- Ghirmay, T., Grabowski, R., and Sharma, S., (2001). Exports, investment, efficiency and economic growth in LDC: An empirical investigation, *Applied Economics*, 33, 689-700.
- Grossman G and Helpman, E. (1991) *Innovation and growth in global economy*, Cambridge MIT Press.
- Johansen, S. (1988) Statistical analysis of co-integrated vectors. *Journal of Economics Dynamics Control*, 12, 231-254.
- Johansen, S and Juselius, K. (1990). Maximum Likelihood Estimation and Inference on Cointegration with Applications to the Demand for the Money, *Oxford Bulletin of Economics and Statistics*, 52, 169-210.
- Kaldor, N. (1967) *Strategic factors in economic development*, Cornell University, New York.
- Katos, A., (2004) *Econometrics: Theory and practice*, Thessaloniki: Zygos (eds).
- Katos, A. Pekos, G. Katsouli, E., and Batzios, C. (1996) Saving-Investment Equilibrium in the European Union: An Economic Policy Exercise, *RISEC*, 43(1), 81-107.
- Katsouli, E. (2006) Testing the surprise consumption function: A comparative study between 15 European Union member-states, *International Research Journal of Finance and Economics*, 1, 36-41.
- King, R. and Levine, R. (1993b) Finance Entrepreneurship and Growth, *Journal of Monetary Economics*, 32, 513-542.
- Kwiatkowski, D., Phillips, P.C., Schmidt, P., & Shin, Y. (1992): Testing the null hypothesis of stationarity against the alternative of a unit root. *Journal of Econometrics*, 54, 159 - 178.
- Krishna, J., Ozyildirim, A., and Swanson, N., (2003). Trade, investment and growth: nexus, analysis and prognosis, *Journal of Development Economics*, 70, 479-499.
- Krueger, A., (1978). *Foreign Trade Regimes and Economic Development: Liberalization attempts and consequences*, Ballinger, Cambridge.
- Laopodis, N. and Sawhney, B. (2007). Dynamic interactions between investment and the stock market evidence from cointegration and error correction models, *Applied Financial Economics*, 17, 257-269.
- Levine, R. and Renelt (1992). A sensitivity analysis of cross-country growth regressions, *American Economic Review*, 82, 942-963.

- Liu, X., Burridge, P., and Sinclair, P., (2002) Relationships between economic growth, foreign direct investment and trade: evidence from China, *Applied Economics*, 34, 1433-1440.
- Lucas, R., (1988). On the mechanics of economic development, *Journal of Development Economics*, 22, 3-42.
- Makki, S., and Somwaru, A., (2004). Impact of foreign direct investment and trade on economic growth: evidence from developing countries, *American Journal of Agricultural Economics*, 86(3), 795-801.
- Osterwald-Lenum, M., (1992). A Note with quantiles of the asymptotic distribution of the maximum likelihood cointegration rank test statistics, *Oxford Bulletin Economics and Statistics*, 54: 461-472.
- Phillips, P., and Hansen, B., (1990). Statistical inference in instrumental variables regression with I (1) processes. *The Review of Economic Studies*, 57(1), 99-125.
- Phillips, P. and Perron, P. (1988). Testing for a unit root in time series regression, *Biometrika*, 75, 335-346.
- Phillips, P. and Ouliaris, S., (1990). "Asymptotic Properties of Residual Based Tests for Cointegration", *Econometrica*, 58 (1): 165–193.
- Plossner, C., (1992). *The search for growth in policies for long-run economic growth*, Federal Reserve Bank of Kansas City, Kansas City, MO.
- Rivera-Batiz, L. and Romer, P. (1991). Economic Integration and Endogenous Growth, *Quarterly Journal of Economics*, 106, 531-55.
- Romer, P., (1990). Are non convexities important for understanding growth, *American Economic Review*, 80, 97-103.
- Seddighi, H., Lawler, K., and Katos, A., (2000). *Econometrics: A practical approach*, London: Routledge.
- Serletis, A., Afxentiou, P., and Yavari, K., (2004). External and domestic growth forces in the performance of European Union economies, *Economia Internazionale*, 57(1), 41-57.
- Sharma, S., and Dhakal, D., (1994). Causal analyses between exports and economic growth in developing countries, *Applied Economics*, 26, 1145-1157.
- Vazakidis, A. (2006) Testing simple versus Dimson market models: The case of Athens Stock Exchange, *International Research Journal of Finance and Economics*, 2, pp.26-34.

APPENDIX

Figure 1. Graphs of examined variables

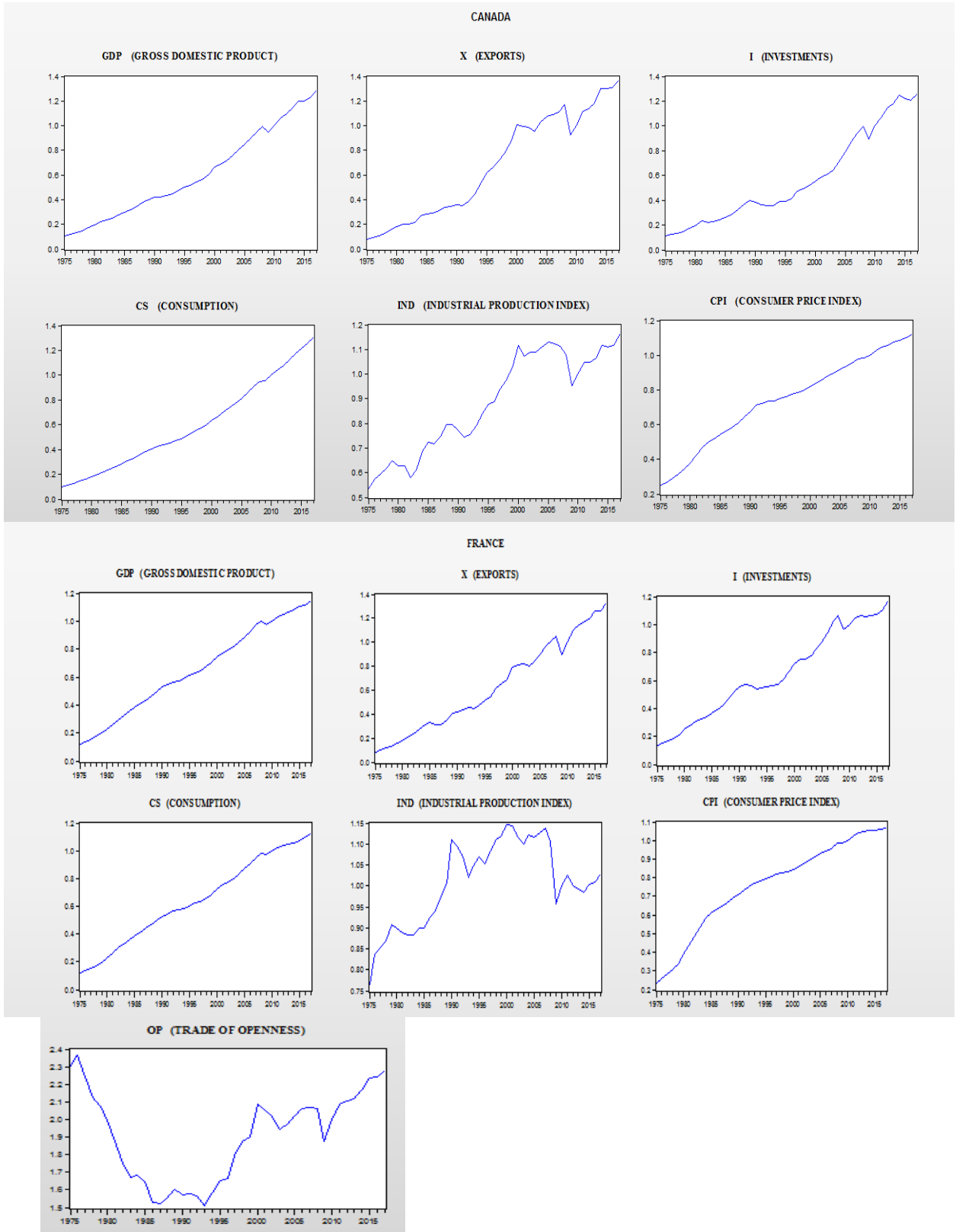

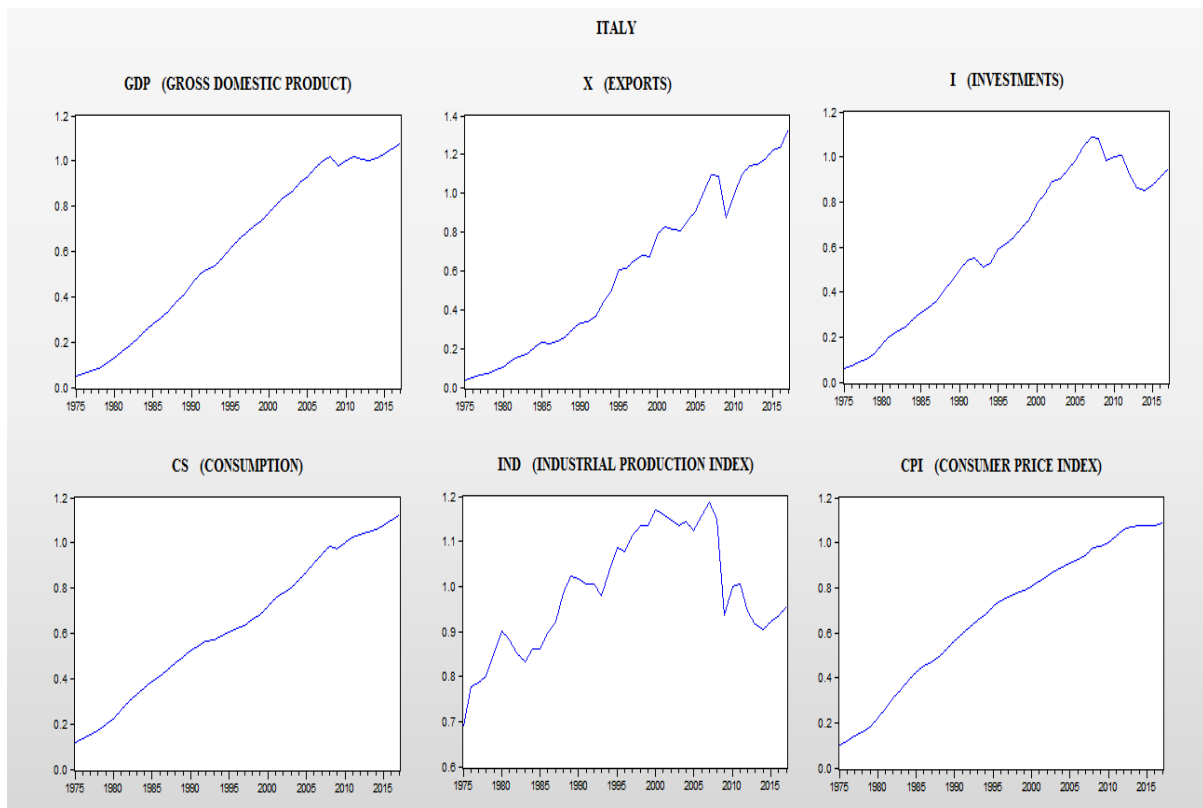
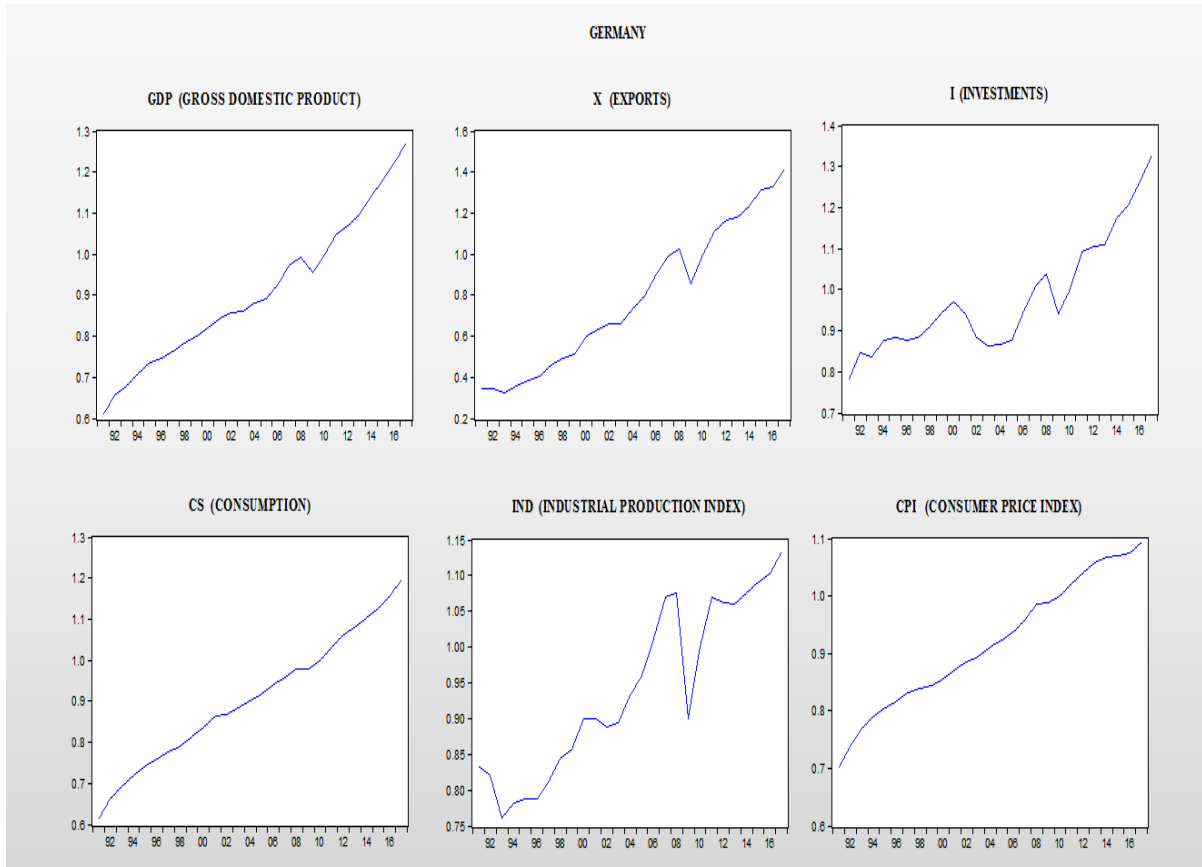

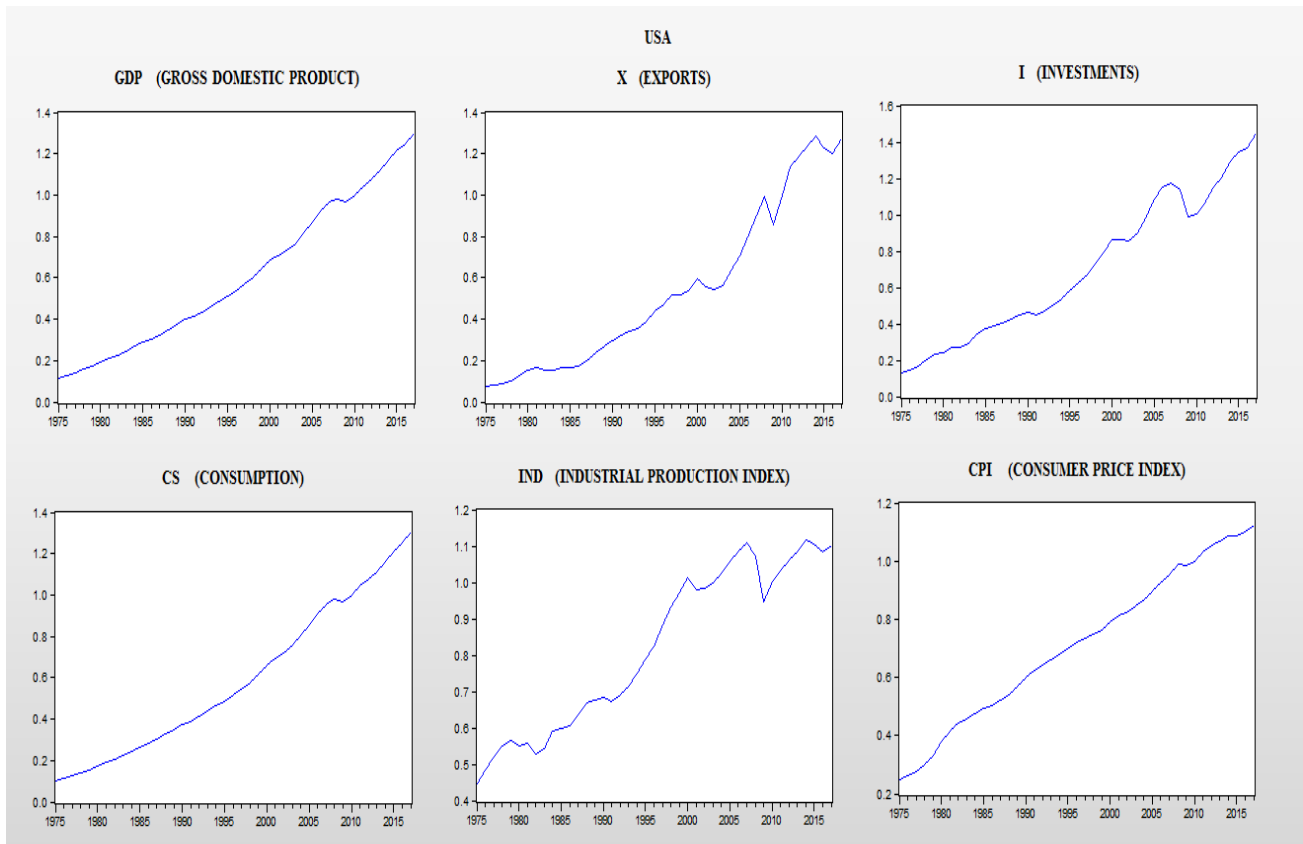
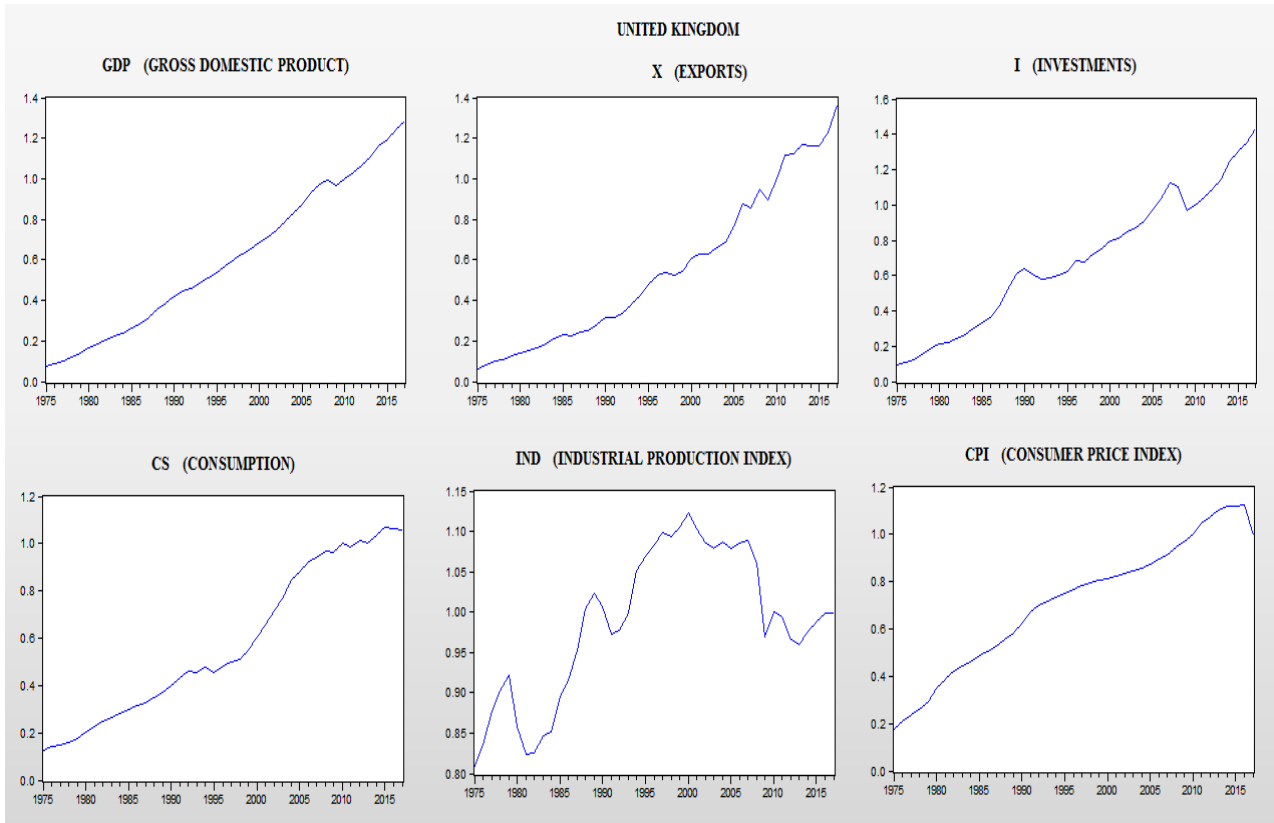

JAPAN

GDP (GROSS DOMESTIC PRODUCT)

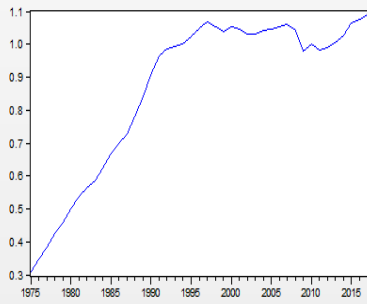

X (EXPORTS)

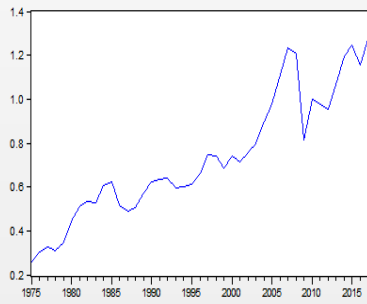

I (INVESTMENTS)

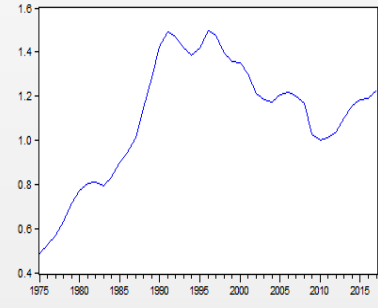

CS (CONSUMPTION)

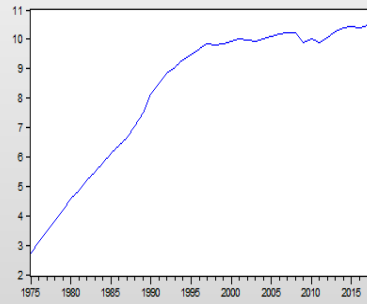

IND (INDUSTRIAL PRODUCTION INDEX)

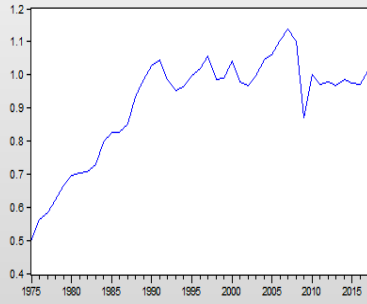

CPI (CONSUMER PRICE INDEX)

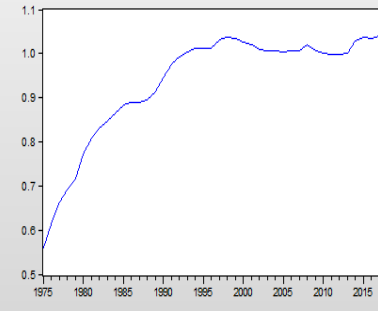

OP (TRADE OF OPENNESS)

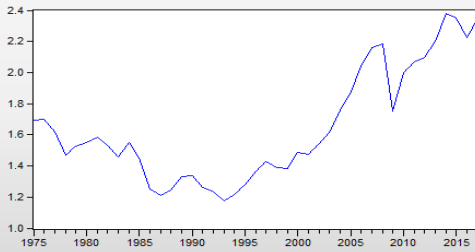

Table 6
Summarized empirical results of 2SLS method

Canada	
$GDP_t = 0.02 + 0.13X_t + 0.22I_t + 0.60 CS_t + [ar(1)=0.80] + u_{1t}$	(1a)
$X_t = -0.47 + 0.34 GDP_t + 0.80 IND_t + 0.34X_{t-1} + u_{2t}$	(2a)
$I_t = -0.006 + 0.30GDP_t + 0.72I_{t-1} + u_{3t}$	(3a)
$CS_t = 0.01 + 0.49GDP_t - 0.02 CPI_{t-1} + 0.55 CS_{t-2} + u_{4t}$	(4a)
France	
$GDP_t = 0.05 + 0.11X_t + 0.24I_t + 0.61 CS_{t-2} + u_{1t}$	(1b)
$X_t = -0.06 + 0.60 GDP_t + 0.52X_{t-2} + u_{2t}$	(2b)
$I_t = -0.42 + 0.66GDP_{t-2} + 0.19IND_{t-1} + 0.28OP_t + [ar(1)=0.82] + u_{3t}$	(3b)
$CS_t = 0.05 + 0.94GDP_t - 0.10 CPI_{t-4} + 0.09 CS_{t-5} + [ar(1)=0.82] + u_{4t}$	(4b)
Germany	
$GDP_t = 0.14 + 0.26X_t + 0.28I_{t-1} + 0.31 CS_{t-1} + u_{1t}$	(1c)
$X_t = -1.11 + 0.84GDP_t + 0.99IND_t + 0.26 X_{t-1} + u_{2t}$	(2c)
$I_t = -0.57 + 0.80GDP_{t-1} + 0.76IND_t + [ar(1)=0.89] + u_{3t}$	(3c)
$CS_t = 0.03 + 0.16GDP_{t-4} - 0.13 CPI_{t-1} + 0.90 CS_{t-1} + 0.06*IND_t + u_{4t}$	(4c)
Italy	
$GDP_t = -0.04 + 0.19X_t + 0.48I_t + 0.37 CS_t + u_{1t}$	(1d)
$X_t = -0.08 + 0.60GDP_{t-6} + 0.14IND_t + 0.45 X_{t-1} + u_{2t}$	(2d)
$I_t = -0.34 + 0.79GDP_{t-1} + 0.48IND_{t-2} + u_{3t}$	(3d)
$CS_t = 1.71 + 0.45GDP_t - 0.33 CPI_{t-2} + 0.30 CS_{t-2} + [ar(1)=0.98] + u_{4t}$	(4d)
Japan	
$GDP_t = 0.03 + 0.07X_t + 0.26I_{t-1} + 0.06 CS_{t-1} + u_{1t}$	(1e)
$X_t = 0.07 + 0.57GDP_t + 0.60IND_{t-1} + u_{2t}$	(2e)
$I_t = -0.78 + 0.24GDP_{t-1} + 0.44IND_t + 0.56 OP_t + [ar(1)=0.72] + u_{3t}$	(3e)
$CS_t = 0.73 + 0.93GDP_{t-2} + 0.83 CS_{t-1} + [ar(1)=0.57] + u_{4t}$	(4e)
United Kingdom	
$GDP_t = -0.02 + 0.32X_t + 0.48I_t + 0.19CS_{t-1} + u_{1t}$	(1f)
$X_t = -0.003 + 0.18GDP_t + 0.85X_{t-1} + u_{2t}$	(2f)
$I_t = -0.27 + 0.97GDP_{t-1} + 0.40IND_t + u_{3t}$	(3f)
$CS_t = 3.11 + 0.38GDP_{t-2} - 0.56 CPI_{t-2} + [ar(1)=0.98] + u_{4t}$	(4f)
USA	
$GDP_t = 0.03 + 0.04X_{t-2} + 0.09I_t + 0.82 CS_t + [ar(1)=0.80] + u_{1t}$	(1g)
$X_t = -0.77 + 0.71GDP_{t-1} + 0.98IND_t + [ar(1)=0.92] + u_{2t}$	(2g)
$I_t = -0.14 + 0.19GDP_{t-2} + 0.39IND_t + 0.62I_{t-1} + u_{3t}$	(3g)
$CS_t = -0.006 + 0.87GDP_t - 0.05 CPI_t + 0.18 CS_{t-1} + [ar(1)=0.51] + u_{4t}$	(4g)