

Kranich, Jan

Working Paper

Agglomeration, vertical specialization, and the strength of industrial linkages

Working Paper Series in Economics, No. 98

Provided in Cooperation with:

Institute of Economics, Leuphana Universität Lüneburg

Suggested Citation: Kranich, Jan (2008) : Agglomeration, vertical specialization, and the strength of industrial linkages, Working Paper Series in Economics, No. 98, Leuphana Universität Lüneburg, Institut für Volkswirtschaftslehre, Lüneburg

This Version is available at:

<https://hdl.handle.net/10419/28216>

Standard-Nutzungsbedingungen:

Die Dokumente auf EconStor dürfen zu eigenen wissenschaftlichen Zwecken und zum Privatgebrauch gespeichert und kopiert werden.

Sie dürfen die Dokumente nicht für öffentliche oder kommerzielle Zwecke vervielfältigen, öffentlich ausstellen, öffentlich zugänglich machen, vertreiben oder anderweitig nutzen.

Sofern die Verfasser die Dokumente unter Open-Content-Lizenzen (insbesondere CC-Lizenzen) zur Verfügung gestellt haben sollten, gelten abweichend von diesen Nutzungsbedingungen die in der dort genannten Lizenz gewährten Nutzungsrechte.

Terms of use:

Documents in EconStor may be saved and copied for your personal and scholarly purposes.

You are not to copy documents for public or commercial purposes, to exhibit the documents publicly, to make them publicly available on the internet, or to distribute or otherwise use the documents in public.

If the documents have been made available under an Open Content Licence (especially Creative Commons Licences), you may exercise further usage rights as specified in the indicated licence.

**Agglomeration, Vertical Specialization, and the
Strength of Industrial Linkages**

by
Jan Kranich

University of Lüneburg
Working Paper Series in Economics

No.98

September 2008

www.uni-lueneburg.de/vwl/papers

ISSN 1860 - 5508

Agglomeration, Vertical Specialization, and the Strength of Industrial Linkages

September 3, 2008

Abstract

This paper picks up the seminal model of Venables (1996) and provides a quantifying concept for the sectoral coherence in vertical-linkage models of the New Economic Geography. Based upon an alternative approach to solve the model and to determine critical trade cost values, this paper focuses on the interdependencies between agglomeration, specialization and the strength of vertical linkages. A central concern is the idea of an 'industrial base,' which is attracting linked industries but is persistent to relocation. As a main finding, the intermediate cost share and substitution elasticity basically determine the strength of linkages. Thus, these parameters affect how strong the industrial base responds to changes in trade costs, relative wages and market size.

Keywords: New Economic Geography, Vertical Linkages

JEL classifications: F12

1 Introduction

The *New Economic Geography* (NEG), initially introduced by Krugman (1991), provides explanations for industrial agglomeration based upon increasing returns and imperfect competition. Whereas international labor mobility initiates the central agglomeration mechanism in the core-periphery model, the observation that industrial clustering also is present in regions with relatively low migration has challenged the application of inter-industrial trade as an additional agglomeration force.

In their analysis of European industries, Midelfart-Knarvik et al. (2000) point out that vertical linkages have become increasingly significant since 1980. Hummels et al. (2001) estimate that about 30% of world exports account for inter-industrial trade.¹ This share has grown by 40% since 1970, which emphasizes the increasing role of what the authors call *vertical specialization*. These results are consistent with those of Yeats (1998), who considers the exports of the OECD countries within the classification group SITC-7 (key machinery and transportation equipment). In 1995, the share of components and parts was about 30%, which approximates \$132 billion (US). Characterizing the relevance of vertical linkages in expanding international trade, Hummels et al. (1998) come to the conclusion that the nature of international trade 'has changed to the point where countries increasingly specialize in producing particular stages of goods, rather than making a complete good from start to finish'.

Based upon the seminal works of Ethier (1982), Rivera-Batiz (1988) and Markusen (1989), Krugman and Venables (1995) implement vertical linkages into the *core-periphery model*, where the upstream industry provides differentiated intermediate products to the downstream industry that produces differentiated consumer goods. For simplification, both sectors are integrated into one so that the manufacturing firms produce their own intermediates. In contrast, Venables (1996) separates the sectoral structure and analyzes the particular spatial distribution of both upstream and downstream industries. A couple of additional publications picked up the vertical-linkage (VL) mechanism. Baldwin et al. (2003) classify these models into: i) CPVL models in the course of Krugman and Venables (1995); ii) FEVL models,

¹Estimation for 1995.

which are based upon the footloose-entrepreneur framework (Ottaviano (2002)); and iii) FCVL (footloose capital) models due to Robert-Nicoud (2002).

In the context of existing NEG literature considering vertical linkages, the dimension of industrial agglomeration depends upon four categories of factors: i) trade costs; ii) local production costs; iii) local market size; and iv) the strength of vertical linkages. The higher the trade costs, the stronger firms tend to locate at the larger market for reducing the costs of spatial transfers. In contrast, at low trade costs, local cost advantages become more important than local market size. Including inter-industrial trade, the allocation between upstream and downstream sectors is characterized by mutual interdependencies, which are also referred to as forward and backward linkages. The forward linkage describes the dependency of the upstream industry upon the downstream industry: the larger the downstream sector, the larger is the relevant market for the intermediate sector. The backward linkage results from the price-index effect: the more firms produce in the upstream sector, the higher is the competitive pressure implying decreasing intermediate prices, which finally decrease the procurement costs of the downstream industry. It is applied for both mechanisms: the larger one sector is, the larger is the other.

Although the strength of vertical linkages is attributed to be an important factor for industrial clustering, it only is discussed casually. For quantification, a frequently used reference is the share of downstream costs for intermediate products. This approach raises certain questions: Is the strength of linkages an endogenous or exogenous factor? What are the main factors controlling industrial interdependencies, and is the strength of linkages fixed or variable? Can the sectoral coherence be described as one measure, or does it require a separate analysis dealing with forward and backward linkages?

In comparison with the diversity of models considering vertical linkages, the Venables (1996) model shows a number of distinctive features. First, it is the only partial-analytical model, which describes agglomeration and the characteristic bifurcation pattern of NEG models. In this context, it allows to focus on industrial linkages without income and labor market effects. Second, due to the disaggregated sectoral set up, the Venables model gives insight into firm behavior in both upstream and downstream sectors, and thus, it opens the potential to reproduce vertical spe-

cialization. Third, it directly refers to the strength of inter-industrial linkages and its impact upon the spatial distribution of both sectors.

However, the model also features some difficulties. The modeling framework is comparatively complex including four boundary conditions and twofold price-index and home-market effects. Furthermore, the model results are only given in relative values rather than absolute firm numbers in both sectors. The paper also leaves some open questions regarding the sustain point, a more detailed description of the boundary and stability conditions, exogenous asymmetries between locations, and political implications.

Against this background, the objective of this paper is to suggest a concept for quantifying the strength of vertical linkages in NEG models. Further on, it explicitly considers the Venables model in terms of the absolute size of industries, and thus, it provides an alternative approach to determine the break and sustain point, as well as the specialization point where vertical specialization breaks off for decreasing trade costs. Moreover, Venables (1996) approaches the idea of an 'industrial base,' which describes a sufficient market size and presence of suppliers to attract and maintain additional firms in one particular location. This paper complements these considerations i) by the classification of industries by means of the strength of linkages; and ii) by quantifying the *inertia* of the downstream industry with respect to a relocation of the upstream industry. Finally, it considers exogenous asymmetries in terms of wage rate and market size and their impact upon agglomeration and specialization. In this context, it also includes a subsidization policy for compensating disadvantages in country size.

The paper is structured as follows. In the next section, we introduce the basic model of a closed economy to analyze vertical linkages and to develop a measuring concept of the linkage strength. In Section 3, we refer to the standard Venables model and consider equilibria, stability, critical trade costs values, and the impact of linkage strength. Section 4 focuses on the effects of exogenous asymmetries. The last section returns to the idea of an industrial base and draws the main conclusions based upon the modeling results.

2 Closed Economy

In this section, we consider a simple supply chain consisting of an upstream industry forwarding intermediate products to a downstream industry, which manufactures final products for private consumers. Both sectors are characterized by increasing returns and monopolistic competition.

Consumer Demand

Starting from consumer preferences, the private households face a linear-homogenous utility function in the form of:

$$(1) \quad U = M^\mu A^{1-\mu}, \quad 0 < \mu < 1,$$

where M represents a sub-utility from the consumption of manufactures, A is the quantity of a homogenous (outside) good, and μ the share in private expenditures for manufactures. The sub-utility, M , is given by:

$$(2) \quad M = \left[\sum_{i=1}^{n^d} (x_i^d)^{(\sigma-1)/\sigma} \right]^{\sigma/(\sigma-1)}, \quad \sigma > 1,$$

where x_i^d is the quantity of a particular variety, i , out of all varieties available, n^d , that are produced by the downstream industry (d is mnemonic for *downstream*). The preference parameter, σ , can be shown to be the constant elasticity of substitution; for concavity it is defined to be greater than 1.

The demand for manufactures can be derived by *two-stage budgeting*:

$$(3) \quad x^d = \mu Y (p^d)^{-\sigma} (P^d)^{\sigma-1},$$

where p^d denotes the downstream price, and μY the share in income of the private households spent on consumer goods. P^d is the consumer price index, defined as:

$$(4) \quad P^d \equiv \left[\sum_{i=1}^{n^d} (p_i^d)^{1-\sigma} \right]^{\frac{1}{1-\sigma}}.$$

Equation (4) reveals the price-index effect: an increase in product variety reduces the price index because a given level of subutility can be achieved with a lower

quantity of a particular product sort.

Downstream Industry

Based upon Ethier (1982), the technology for final good production is given by a implicit Cobb-Douglas type production function:

$$(5) \quad F^d + a^d x^d = Z (l^d)^{1-\alpha} I^\alpha.$$

The right hand side of equation (5) represents the input composite of labor and intermediates in order to produce one unit of downstream output, x^d , which involves a fixed cost, F^d , and a variable cost, a^d , on the left hand side. Z controls the output level, while α is the partial substitution elasticity of the intermediate aggregate, I , which is:

$$(6) \quad I = \left[\sum_{i=1}^{n^u} (x_i^u)^{(\varsigma-1)/\varsigma} \right]^{\varsigma/(\varsigma-1)},$$

where the superscript u denotes *upstream*.

Production function and intermediate aggregate are structurally the same as utility and sub-utility functions in which ς corresponds with σ . The common pattern involving downstream and consumer preferences implies a price index for intermediates that is similar to the one for consumer goods:

$$(7) \quad P^u \equiv \left[\sum_{i=1}^{n^u} (p_i^u)^{1-\varsigma} \right]^{1/(1-\varsigma)}.$$

By applying two-stage-budgeting again, we obtain the cost function of one downstream firm:

$$(8) \quad C^d = (F^d + a^d x^d) w^{1-\alpha} (P^u)^\alpha.$$

The downstream costs positively depend on the wage level, w , on the fixed and variable costs, F^d and a^d , as well as on the intermediate price index. The latter responds to changes in the number of upstream firms in the same way as the price index for consumer goods, implying that an increasing number of intermediate varieties cuts down the cost of the downstream industry, via a negative (intermediate)

price index effect. Furthermore, equation (8) reveals the cost rate of the downstream factor composite consisting of labor and intermediates: $w^{1-\alpha} (P^u)^\alpha$. From the cost function the demand for intermediates can be derived:

$$(9) \quad x^u = \alpha C^d (p^u)^{-\varsigma} (P^u)^{\varsigma-1}.$$

Summing up, the downstream profit function is given by:

$$(10) \quad \pi^d = p^d x^d - w^{1-\alpha} (P^u)^\alpha [F^d + a^d x^d].$$

Substituting consumer demand (3) and differentiation yield the profit maximizing downstream price:

$$(11) \quad (p^d)^* = w^{1-\alpha} (P^u)^\alpha a^d \left(\frac{\sigma}{\sigma - 1} \right).$$

Equation (11) represents monopolistic mark-up pricing on-top marginal costs. For analytical convenience, we normalize a^d by $(\sigma - 1) / \sigma$.

Using this simplification, the equilibrium output of a downstream firm following from zero-profits is:

$$(12) \quad (x^d)^* = \sigma F^d.$$

Upstream Industry

The upstream industry produces intermediates by use of a linear technology given by:

$$(13) \quad l^u = F^u + a^u x^u,$$

where l^u is the amount of labor required to produce one unit of upstream output.

The corresponding upstream profit function can be written as:

$$(14) \quad \pi^u = p^u x^u - w (F^u + a^u x^u).$$

The profit maximizing upstream price is by use of intermediate demand (9):

$$(15) \quad (p^u)^* = wa^u \left(\frac{\varsigma}{\varsigma - 1} \right).$$

Again, we use a standard normalization: $a^u = (\varsigma - 1)/\varsigma$, so that the equilibrium output of one upstream firm is:

$$(16) \quad (x^u)^* = \varsigma F^u.$$

Equilibrium Firm Number

Market clearing in both the upstream and downstream sectors requires total supply being equal to total demand. In terms of the upstream industry holds:

$$(17) \quad n^u p^u x^u = n^d \alpha C^d.$$

From (17) the number of upstream firms can be determined by substituting equations (8), (9), (15), and (16):

$$(18) \quad n^u = \left[\alpha \frac{\sigma F^d}{\varsigma F^u} n^d \right]^{\frac{1-\varsigma}{1-\varsigma-\alpha}} \equiv N^u.$$

Similarly, the downstream market clearing condition is:

$$(19) \quad n^d p^d x^d = \mu Y.$$

Accordingly, the downstream firm number is by use of (3), (11), and (12):

$$(20) \quad n^d = \frac{\mu Y}{w \sigma F^d} (n^u)^{\frac{\alpha}{\varsigma-1}} \equiv N^d.$$

Equations (18) and (20) describe the forward and backward linkages, meaning that the number of upstream firms depends positively upon the number of downstream firms and vice versa. The forward linkage acts upon a simple market size argument: the larger the number of firms in the downstream sector, the larger is the corresponding market size for intermediate suppliers leading to an entry of new upstream firms. The backward linkage is based upon the (intermediate) price index effect:

the more firms produce in the upstream industry, the lower is the corresponding price index. This implies lower procurement costs for the subsequent industry, thus increasing profits and market entries of new downstream firms. Setting (18) equal to (20) yields a unique and stable equilibrium at:²

$$(21) \quad (n^u)^* = \frac{\alpha\mu Y}{w\zeta F^u} \quad , \quad (n^d)^* = \frac{\zeta F^u}{\alpha\sigma F^d} \left(\frac{\alpha\mu Y}{\zeta w F^u} \right)^{\frac{1-\zeta-\alpha}{1-\zeta}} .$$

Figure 1 illustrates the equilibrium by means of equations (18) and (20).

[Insert Figure 1 about here.]

The curve progression of N^d critically depends upon the exponent of n^u . As long as $\alpha < (\zeta - 1)$ holds, the function is concave with respect to the upstream firm number. Otherwise, the price index effect escalates and the graph becomes convex. However, this case differentiation does not affect the existence and stability of the equilibrium at all, but has implications for the following subsection.

The Strength of Vertical Linkages

Considering the zero-profit isoclines, N^u and N^d , as forward and backward linkages, they provide information about the mutual coherence between the upstream and downstream sectors. The basic idea is that the slope of the isoclines represents the strength of the relative linkages. Assuming an infinitely fast adjustment process, the derivatives evaluated at the equilibrium are:

$$(22a) \quad \frac{\partial n^u}{\partial n^d} | (n^d)^* = \sigma F^d \left(\frac{1-\zeta}{1-\zeta-\alpha} \right) \left(\frac{\zeta F^u}{\alpha} \right)^{\frac{\alpha+1-\zeta}{\zeta-1}} \left(\frac{\mu Y}{w} \right)^{\frac{\alpha}{1-\zeta}}$$

$$(22b) \quad \frac{\partial N^d}{\partial n^u} | (n^u)^* = \frac{\left(\frac{\alpha\mu Y}{w} \right)^{\frac{\alpha}{\zeta-1}} (\zeta F^u)^{\frac{\alpha-\zeta+1}{1-\zeta}}}{(\zeta-1)\sigma F^d} .$$

The derivatives quantify the change in the number of firms in one sector, in response to changes in the quantity of firms in the other sector. If we choose the point elasticities based upon equations (22), we obtain:

$$(23a) \quad \varepsilon^u = \frac{1-\zeta}{1-\zeta-\alpha} \quad , \quad 0 < \varepsilon^u < 1$$

²See Appendix for a simple stability analysis.

$$(23b) \varepsilon^d = \frac{\alpha}{\varsigma - 1} \quad , \quad 0 < \varepsilon^d < 1 \quad \forall \quad \alpha < \varsigma - 1$$

These elasticities can be considered to be a measure for the strength of inter-sectoral linkages. The only parameters affecting sectoral coherence are the intermediate differentiation, ς , and the cost share for intermediates, α . The elasticities are positive, constant and independent from exogenous parameters as market size or technology, which can be attributed to the specific CES-typed functions. Furthermore, both values are within the same domain, where the border case, $\alpha > (\varsigma - 1)$, as discussed above, is excluded.

The strength of vertical linkages can be measured as the percentage change in the quantity of firms in one industry, due to a one percent change in the number of firms in the other industry. The major advantages of this approach are: i) the availability of the parameters from official statistics and econometric estimations; ii) the potential to compare industrial linkages beyond particular supply chains; iii) a dimensionless measure; and iv) nonetheless, an ultimately intuitive economic interpretation.

Figure 2 represents the graphs of equations (23a) and (23b). It is apparent that the forward linkage, which is the dependence of upstream firms upon the downstream industry, increases the lower the intermediate differentiation as well as the intermediate share in downstream costs. The backward linkage and, in this context, the dependence of downstream firms upon their suppliers, intensifies with increasing intermediate differentiation and expanding cost share.

[Insert Figure 2 about here.]

The isoclines for a given elasticity are linear, with the slope, $(1 - \bar{\varepsilon}^u) / \bar{\varepsilon}^u$, for the forward linkage and $\bar{\varepsilon}^d$ for the backward linkage. This implies that an increase in ς must go along with an increase in α to maintain a certain level of linkage strength. All in all, this measuring concept has a couple of implications:

- The sectoral coherence is a bi-directional relationship of forward and backward linkages, so that the strength of linkages is composed of two measurements.

- The strengths of both linkages are converse, which implies that the higher the strength of the forward linkage, the weaker is the backward linkage and vice versa. This constellation also excludes combination of mutual weak or strong linkages.
- The sum of both elasticities as a rough aggregate for the overall sectoral coherence is always larger than 1, increasing with α , and decreasing with ς .

All in all, the common approach used in the NEG literature to quantify the strength of linkages by the intermediate cost share is not sufficient to display the whole mechanism between vertically linked sectors, as this closed economy framework reveals.

3 Open Economy

For considering the impact of different linkage strengths, this section refers to the partial model introduced by Venables (1996). This model analyzes the supply chain described in the previous section within an open economy with two locations. While the workforce is immobile, the output of the upstream and downstream industries are internationally tradable, which causes Samuelson iceberg trade costs, $t > 1$. Preferences and technologies are the same across both locations, whereas market size and wages are allowed to differ.

In accordance with equations (4) and (7), the price indices are:

$$(24a) \quad (P_1^u)^{1-\varsigma} = (p_1^u)^{1-\varsigma} n_1^u + (p_2^u t)^{1-\varsigma} n_2^u$$

$$(24b) \quad (P_2^u)^{1-\varsigma} = (p_1^u t)^{1-\varsigma} n_1^u + (p_2^u)^{1-\varsigma} n_2^u$$

$$(25a) \quad (P_1^d)^{1-\sigma} = (p_1^d)^{1-\sigma} n_1^d + (p_2^d t)^{1-\sigma} n_2^d$$

$$(25b) \quad (P_2^d)^{1-\sigma} = (p_1^d t)^{1-\sigma} n_1^d + (p_2^d)^{1-\sigma} n_2^d,$$

where upstream and downstream prices depend upon local costs: $p_s^u = w_s$ and $p_s^d = w_s^{1-\alpha} (P_s^u)^\alpha$. Based upon equation (8), the downstream cost functions become:

$$(26a) \quad C_1^d = (F^d + a^d x_1^d) w_1^{1-\alpha} (P_1^u)^\alpha$$

$$(26b) \quad C_2^d = (F^d + a^d x_2^d) w_2^{1-\alpha} (P_2^u)^\alpha.$$

The upstream industry supplies downstream demand, whereas the proportion of intermediates, which are forwarded to the foreign location, has to be t times higher because this amount melts away en route.

$$(27a) \quad x_1^u = \alpha C_1^d (p_1^u)^{-\varsigma} (P_1^u)^{\varsigma-1} n_1^d + \alpha C_2^d (p_1^u t)^{-\varsigma} (P_2^u)^{\varsigma-1} n_2^d t$$

$$(27b) \quad x_2^u = \alpha C_1^d (p_2^u t)^{-\varsigma} (P_1^u)^{\varsigma-1} n_1^d t + \alpha C_2^d (p_2^u)^{-\varsigma} (P_2^u)^{\varsigma-1} n_2^d.$$

Downstream output follows equation (3):

$$(28a) \quad x_1^d = \mu Y_1 (p_1^d)^{-\sigma} (P_1^d)^{\sigma-1} + \mu Y_2 (p_1^d t)^{-\sigma} (P_2^d)^{\sigma-1} t$$

$$(28b) \quad x_2^d = \mu Y_1 (p_2^d t)^{-\sigma} (P_1^d)^{\sigma-1} t + \mu Y_2 (p_2^d)^{-\sigma} (P_2^d)^{\sigma-1}.$$

Because of zero-profits, both upstream and downstream output is fixed at ςF^u and σF^d , respectively, which implies the same fixed firm size in both locations.

Furthermore, we add two market clearing conditions for both sectors according to (17) and (19):

$$(29) \quad n_1^u p_1^u x_1^u + n_2^u p_2^u x_2^u = n_1^d \alpha C_1^d + n_2^d \alpha C_2^d$$

$$(30) \quad n_1^d p_1^d x_1^d + n_2^d p_2^d x_2^d = \mu Y_1 + \mu Y_2,$$

where the left-hand sides represent supply and the right-hand sides demand.

Overall, the equations (24) – (30) describe a system including a non-closed solution set for n_1^u , n_2^u , n_1^d , and n_2^d .

The location decision of manufacturing firms is due to the tension of local market size and production costs. Because of the sectoral linkages, the downstream firms do not only locate at the larger sales market, but also account for the presence of suppliers due to the (intermediate) price-index effect. In turn, the upstream industry locates not only in response to local labor costs, but also to the size of the local downstream industry. However, with decreasing trade costs, differences in labor costs become more and more relevant, which weakens the linkage to the relevant sales market. In extreme, it is possible that trade costs become so low that the whole industry locates in one location and exports to the other, which is also known as the core-periphery outcome. Also in the case of initially symmetric countries, the model generates a core-periphery constellation for sufficiently low trade costs.

Interior and Corner Solutions

Considering two locations, which are symmetric in terms of market size, consumer preferences, technology and labor costs, Figure 3 maps the equilibrium set of the downstream firm number with respect to trade costs.³ With regard to the characteristic pattern, these illustrations are also referred to as bifurcation or tomahawk diagrams, where solid lines represent stable and dashed lines unstable solutions.

[Insert Figure 3 about here.]

For high trade costs, $t > t^S$, the only stable equilibrium is symmetric dispersion, where both firm numbers are equal across both locations.⁴ For medium trade costs, $t^B < t < t^S$, two corner solutions additionally occur implying a (locally) stable symmetric equilibrium as well as a core-periphery constellation, which becomes the only stable solution for low trade costs, $t < t^B$. The peripheral upstream firm number is zero for all trade costs. In contrast, there exists a domain of trade costs, $t^C < t < t^S$, where still a non-zero downstream firm number produces in the periphery, although the upstream sector is totally relocated to the core. Henceforth, this is called the *specialization set*.

However, the set of corner solutions is defined by two non-zero conditions: First,

³Parameters: $\alpha = 0.5$, $\sigma = 3$, $\varsigma = 3$, $Y_1 = Y_2 = 1$, $w_1 = w_2 = 1$.

⁴See Appendix for a detailed derivation of symmetric and corner solutions.

the red dotted line illustrates the zero-profit firm number of downstream firms in the periphery. Second, the green dotted line represents the restriction given by zero upstream firms (expressed in terms of downstream firms).

The first restriction implies that as soon as this curve exceeds the lower corner solution, the firm number in the periphery decreases until the downstream profits are zero. Because firms leave the market, if profits become negative, the zero-profit restriction holds for positive firm numbers as being the peripheral corner solution.

The zero-profit restriction can be determined by equating (28). By use of equation (??) and the downstream price indices (25) follows:

$$(31) \quad \frac{t^{-\sigma\alpha} - t^{1-\sigma}}{\eta(1 - t^{1-\sigma-\sigma\alpha})} = \frac{t^{\alpha(1-\sigma)}\bar{n}^d + t^{1-\sigma}\underline{n}^d}{t^{\alpha(1-\sigma)+1-\sigma}\bar{n}^d + \underline{n}^d},$$

where η is defined to be: Y_2/Y_1 . A bar on top a variable represents the core and below the peripheral equilibrium state. In the next step, from the downstream market clearing condition (30) follows:

$$(32) \quad \underline{n}^d = \frac{\mu Y_1 + \mu Y_2}{\sigma F^d} \left[\frac{\alpha \mu (Y_1 + Y_2)}{\varsigma F^u} \right]^{\frac{\alpha}{\varsigma-1}} - \bar{n}^d t^\alpha.$$

Substituting this expression into equation (31) yields the zero-downstream profit restrictions:

$$(33) \quad \underline{n}^d (\pi^d = 0) = -\bar{n}^d \left[\frac{t^{1-\sigma-\alpha}}{t^{-\alpha\sigma} - t^{1-\sigma}} \right] \left[\frac{\eta(1 - t^{1-\sigma\alpha-\sigma}) - t^{\sigma-1-\sigma\alpha} + 1}{\eta(1 - t^{1-\sigma\alpha-\sigma}) - t^{1-\sigma-\sigma\alpha} + 1} \right] \equiv \Omega$$

For the upper bound holds:

$$(34) \quad \bar{n}^d (\pi^d = 0) = \bar{n}^d - \Omega t^\alpha.$$

The critical trade cost value, t^C , at which downstream specialization breaks off, can be determined by simply setting (33) equal to zero. The corresponding value solves:

$$(35) \quad t^C \rightarrow \eta(1 - t^{1-\sigma\alpha-\sigma}) - t^{\sigma-1-\sigma\alpha} + 1 = 0.$$

The second restriction (green dotted line) can be determined by equating (27), which implies zero upstream profits. Solving for the peripheral downstream firm number yields:

$$(36) \quad \underline{n}^d = \bar{n}^d t^{\varsigma-1+\alpha}.$$

Substituting this expression into (32) again leads to the lower bound:

$$(37) \quad \underline{n}^d (\underline{n}^u = 0) = \frac{\bar{n}^d}{t^\alpha (1 + t^{\zeta-1})}.$$

In consequence, the upper bound is:

$$(38) \quad \bar{n}^d (n^u = \bar{n}^u) = \bar{n}^d \left[\frac{t^{\zeta-1}}{1 + t^{\zeta-1}} \right].$$

Furthermore, at the sustain point, t^S , at which the corner solutions become stable, two conditions must be fulfilled: i) The zero-downstream profit restriction holds (profits in the core turn from negative to positive); and ii) the upstream firm number in the periphery becomes zero so that the second restriction holds. Thus, the sustain point occurs, where the red curves intersect the green curves, and accordingly equation (33) is equal to (37). The corresponding trade cost value solves:

$$(39) \quad t^S \rightarrow \frac{t^{-\sigma\alpha} - t^{1-\sigma}}{\eta(1 - t^{1-\sigma-\sigma\alpha})} - \frac{t^{-\sigma\alpha} + t^{\zeta-\sigma}}{t^{1-\sigma\alpha-\sigma} + t^{\zeta-1}} = 0.$$

Stability Analysis

The stability of equilibria is ascertained by firm profits again, as assumed in the previous section and equation (47) in the Appendix, respectively. Positive profits imply an increasing firm number either by international relocation or a market entry of new firms.

In this context, Figure 4 shows the downstream profits with respect to the downstream firm number in the corresponding location. In order to analyze the impact of integration, the function is plotted for a couple of trade costs ranging from high values ($t = 5$) until low values ($t = 2$), which includes the critical values, t^B , t^C , and t^S .⁵

[Insert Figure 4 about here.]

Though the function is non-closed, some general attributes can be derived. First, the function is a non-symmetric polynomial, whereat one root is always constant:

⁵The figures are plotted for the same parameter values as in Figure 3.

the symmetric equilibrium, n_s^d . Second, the function is implicitly restricted by four bounds: i) non-negativity of the downstream firm number, $n^d \rightarrow [0, \bar{n}^d]$; ii) non-negativity of the upstream firm number, $n^u \rightarrow [0, \bar{n}^u]$, which is again represented by the green curve; and iii) zero-downstream profits (red curve), $n^d \rightarrow [n^d(\bar{\pi}^d = 0), n^d(\bar{\pi}^d)]$.

With regard to stability, an equilibrium is assumed to be stable (unstable), if the marginal profit is negative (positive). In terms of the symmetric equilibrium, the stability alternates from stable to unstable if the slope of the profit function becomes zero, which is denoted as the break point. By totally differentiating the equation system at this point, the break point level of trade costs can be determined:⁶

$$(40) \quad t^B \rightarrow \frac{\alpha\sigma}{\alpha\sigma + \varsigma - 1} - \left[\frac{1 - t^{1-\sigma}}{1 + t^{1-\sigma}} \right]^2 = 0.$$

Moreover, Figure 4 shows the behavior of the corner solutions with respect to the variability of non-negativity conditions. For decreasing trade costs, the zero-upstream firm number restriction moves inwards, while the zero-downstream profit restriction moves outwards. At the sustain point level, t^S , both bounds superpose. For trade costs between break and sustain points, $t^B < t < t^S$, multiple equilibria occur, whereas the symmetric and corner solutions are stable, indicated by a filled dot, and the equilibria in between are unstable, indicated by a non-filled dot. Furthermore, for trade costs lower than the sustain point level, the zero-upstream firm number restriction holds, and the corresponding corner solution implies a positive downstream firm number with non-zero profits. In the case of the lower bound, for instance, the corner solution would imply negative profits in the downstream sector. This leads to market exits of firms until: i) the zero-downstream profit restriction (red dotted curve) is reached for $t^C < t < t^S$; or ii) the downstream firm number in the periphery becomes zero for $t < t^C$. For illustration, the directional arrows in Figure 4 represent the respective alternation of corner solutions.

Comparing break, sustain, and specialization points, all three critical trade cost values are implicitly defined. Numerical investigation reveals that the sustain point occurs first for increasing trade integration, whereas the ranking of break and spe-

⁶See Appendix for a detailed derivation.

cialization points varies: $t^B, t^C < t^S$.⁷

[Insert Table 1 about here.]

Table 1 shows the comparative statics of all three critical trade cost values with respect to changes in the parameters controlling the linkage strength: the intermediate cost share, α , and the intermediate substitution elasticity, ς (standard parameter constellation: $\sigma = 3, F = 1$). As the numerical example reveals, the break point generally increases in α and decreases with ς . In this context, equation (40) shows a linear relationship between cost share and substitution elasticity for a constant break point. This implies that an increase in the cost share can be compensated by a decrease in the substitution elasticity so that the break point remains unchanged. Furthermore, the specialization point, t^C increases with α , but is independent from ς , as equation (35) clarifies. The sustain point, t^S , is positively correlated with α and negatively with ς .

In summary, all three critical trade cost values increase as the strength of the backward linkage (BL) increases. This implies the stronger the dependency of the downstream industry upon the upstream industry, the sooner agglomeration occurs. In turn, this same holds for a weaker forward linkage (FL) because both forces are opponent.

The Inertia of the Downstream Industry

For quantifying the "*inertia*" of the downstream industry, the area between zero-downstream profit restriction and the lower bound provides information about how many downstream firms remain in the periphery since the agglomeration process has started. The *inertia*, Θ , is defined to be the integral of equation (33) between the sustain and specialization points:

$$(41) \quad \Theta = \int_{t^C}^{t^S} \underline{n}^d (\pi^d = 0) dt$$

Table 1 shows the corresponding values for the numerical example. In addition, Figure 5 plots the Θ -values based upon the calibration results of Table 1 with respect

⁷Due to non-closeness of corresponding equations, a general proof according to Baldwin et al. (2003), p.49, is not possible.

to both parameters, α and ς .

[Insert Figure 5 about here.]

Based upon these results, we can state the following propositions: 1) For very high values for ς , the inertia, Θ , tends to zero because sustain and specialization points converge. This implies that as the downstream sector becomes footloose, the intermediates are more homogenous. 2) The inertia tends to infinity for very low α - and ς -values. This results from a parameter constellation very close to a black-hole economy, $t^S \rightarrow \infty$. Because the backward linkage escalates ($\varepsilon^d > 1$), this case is excluded in Figure 5. 3) The graph is non-monotonous with respect to α (and for ς , not displayed). For low α - and ς -values, the inertia increases with an increase in both parameters, whereas for higher values the correlation is negative. The strength of linkages discussed in the preceding section provides an explanation for these non-monotonicities. According to equation (23b), an increase in α and a decrease in ς implies an increasing backward linkage (BL), which leads to an increase in all three critical trade cost values. Thereby, the distance between sustain and specialization points tends to expand, and thus to increase the inertia of the downstream industry due to a stronger dependency upon the upstream sector. However, the numerical calibration reveals that an increasing backward linkage also tends to decrease the zero-profit restriction at the sustain point, as indicated at the Ω -values in Table 1. All in all, a rise in the backward linkage strength increases the interval $[t^S, t^C]$ but decreases the height of the integral Θ . Finally, the interaction between these effects produces the shape as well as the non-monotonicities of the graph in Figure 5.

4 Comparative Advantage vs. Market Size

Deviating from the assumption of symmetric locations, this part considers the impact of differences in local wages and country sizes. Having a look at Figure 4 again, a decrease in the local wage rate leads to a shifting of the corresponding profit function downwards, while an increase in local income shifts the function upwards.

Figure 6 illustrates the downstream firm number in both locations for the case that the wage rate in location 1 is lower than in location 2 ($w_1 = 0.95$, $w_2 = 1$).

[Insert Figure 6 about here.]

As both diagrams reveal, the bifurcation pattern becomes more complex compared with the symmetric case. The boundary conditions shift, especially the curve for the zero-upstream firm number is distorted towards the upper and lower bounds. Furthermore, the number of sustain points may vary. In this context, the subscripts denote the location where the industry agglomerates, and the superscripts denote the sustain point, S , and the corresponding numbering. In the lower diagram of Figure 6, for instance, two sustain points of agglomeration in location 2 and one sustain point for agglomeration in location 1 occur. The ascription as to which location becomes the core and which one becomes the periphery is still ambiguous. However, the initially symmetric stable path is bent towards the location with the comparative advantage so that it increasingly benefits from trade integration. For trade costs lower than the break point level, location 1 tends to be the industrialized core region. The sustain points can be computed by the same approach discussed above:⁸

$$(42) \quad t_1^{S1} \rightarrow \frac{\omega^{\sigma\alpha-\sigma} t^{-\sigma\alpha} - t^{\sigma-1}}{\eta(1 - \omega^{\sigma\alpha-\sigma} t^{\sigma-1-\sigma\alpha})} - \frac{1 + \omega^{\sigma\alpha-\sigma} t^{2-\sigma-\sigma\alpha} \left(\frac{1-\omega^{-\zeta} t^{1-\zeta}}{\omega^{-\zeta} - t^{1-\zeta}} \right)}{t^{1-\sigma} + \omega^{\sigma\alpha-\sigma} t^{1-\zeta-\sigma\alpha} \left(\frac{1-\omega^{-\zeta} t^{1-\zeta}}{\omega^{-\zeta} - t^{1-\zeta}} \right)} = 0$$

$$(43) \quad t_2^{S1} \rightarrow \frac{t^{-\sigma\alpha} - \omega^{\sigma\alpha-\sigma} t^{1-\sigma}}{\eta(\omega^{\sigma\alpha-\sigma} - t^{1-\sigma-\sigma\alpha})} - \frac{t^{-\sigma\alpha} + \omega^{\sigma\alpha-\sigma} t^{\zeta-\sigma} \left(\frac{1-\omega^{-\zeta} t^{1-\zeta}}{\omega^{-\zeta} - t^{1-\zeta}} \right)}{t^{1-\sigma-\sigma\alpha} + \omega^{\sigma\alpha-\sigma} t^{\zeta-1} \left(\frac{1-\omega^{-\zeta} t^{1-\zeta}}{\omega^{-\zeta} - t^{1-\zeta}} \right)} = 0.$$

Equations (42) and (43) represent the intersection of zero-profit and zero-upstream firm restrictions. Thus, they provide the sustain points as long as: $n_1^d(t_1^S) \leq \bar{n}_1^d$ and $n_2^d(t_2^S) \leq \bar{n}_2^d$, respectively. This implies that the intersection must be in between the upper and lower bounds. In the upper diagram of Figure 6, the sustain point, t_1^{S1} , (location 1 is the core) occurs for a downstream firm number higher than the upper bound so that the intersection of the unstable interior solution becomes the sustain point as indicated by the left arrow. The sustain points t_1^{S2} and t_2^{S2} are identical and occur at the trade cost level, at which the zero-upstream firm restriction intersects the lower and the upper bound, respectively:

$$(44) \quad t_1^{S2} = t_2^{S2} = \omega^{\frac{\zeta}{\zeta-1}}.$$

⁸The parameter ω denotes relative wages, w_2/w_1 .

Moreover, the specialization points, t_1^C and t_2^C , differ, and can be determined by solving:

$$(45) \quad t_1^C \rightarrow \eta (1 - \omega^{\sigma\alpha-\sigma} t^{\sigma-1-\sigma\alpha}) - \omega^{\sigma\alpha-\sigma} t^{1-\sigma-\sigma\alpha} + 1 = 0$$

$$(46) \quad t_2^C \rightarrow \eta (\omega^{\sigma\alpha-\sigma} - t^{1-\sigma\alpha-\sigma}) - t^{\sigma-1-\sigma\alpha} + \omega^{\sigma\alpha-\sigma} = 0.$$

Based upon these outcomes, the same implications hold for the case that one country is larger than its neighbor. The home-country and price index effect produce a relocation tendency towards the location with the larger market size. This implies an upward shift of the profit function in Figure 4. Hence, there exists a wage differential which totally compensates the effect of a difference in country sizes (for small deviations from symmetry).

Considering this situation from the viewpoint of the smaller country, it might be a political option to subsidize the local industry for initiating a relocation process due to a comparative cost advantage. In this context, Figure 7 shows the required wage rate in the smaller location (here, location 1) by means of the standard numerical example ($Y_2 = 1.1$).

[Insert Figure 7 about here.]

As apparent, symmetry between locations in terms of firm number, and thus of the total industrial output, is only realizable either in the upstream sector or in the downstream sector. For low trade costs (to the left of the intersection), the wage rate is higher, and thus the subsidy lower, for achieving downstream symmetry compared with the wage rate required to generate upstream symmetry. For high trade costs (to the right of the intersection), the situation is reversed. The trade cost value, where both curves intersect, converges to the break point level for a decreasing size asymmetry.

If we consider a situation of $t = 4$, for instance, a wage rate given on the upstream-symmetry curve produces an intermediate output, which is identical in both locations, but the downstream sector still shows a relocation tendency towards the

larger country. If we further decrease the wage rate until the downstream-symmetry curve is reached, the upstream sector agglomerates in the smaller locations, whereas the downstream sector is equalized. For $t = 1.5$, for instance, a wage rate set on the upstream-symmetry level initiates a downstream agglomeration for the smaller country, while the upstream industry is evenly distributed. A wage rate below both curves implies agglomeration of upstream and downstream sectors in the smaller location.

Alternatively, it might be a political objective to equalize the total amount of manufactures as an aggregate; thus, to equalize the industrial employment in both countries: $n_1^u x_1^u + n_1^d x_1^d = n_2^u x_2^u + n_2^d x_2^d$. In the case of the standard example, the firm size can be neglected because it is the same in both locations and sectors. As a result of this policy, the upstream firm number in the smaller location is higher and the downstream firm number is lower than in the larger country. All in all, we face a situation of a relative upstream specialization in location 1, and a relative downstream specialization in location 2.

5 Concluding Remarks

As the Venables model reveals, vertical specialization only occurs in terms of a total specialization of the periphery in downstream activities. Thus, vertical specialization is a result of a successive relocation first of the upstream industry, thereafter of the downstream industry for decreasing trade costs. The inertia discussed in this paper quantifies this specialization effect, which is primarily controlled by the backward linkage. A perfect vertical specialization where one location focuses on upstream and the other location on downstream production is excluded.

If we return to the initial question of an industrial base and summarizing the main results, the strength of linkages quantified by the approach discussed in this paper differs from the existing literature. First, we obtain two values for the sectoral coherence with respect to forward and backward linkage, whereas the stronger one linkage, the weaker is the antagonistic one. Second, beside the commonly used parameter cost share, α , to quantify the linkage strength, we included the intermediate substitution elasticity, ζ , as a further determinant.

The inertia of the downstream industry suggests itself for a criterion to identify industries being part of the industrial base. But as Section 3 revealed, the relationship is quite complex. As we have seen, a low break point does not unnecessarily imply a high inertia and vice versa. In fact, if we choose a high- α and a low ς -industry, for instance, the break point occurs for high trade cost values indicating an early agglomeration process. In contrast, the inertia also takes high values, which implies that the downstream industry slowly detaches from the periphery. Considering industries featuring a substitution elasticity even closer to the edge of the domain, the inertia may decrease again. Overall, a general attribution of industries to the industrial base critically depends upon the parameter constellation also in regard to the consumer substitution elasticity, fixed costs, and potential country size or wage rate asymmetries.

Having a comparative advantage either due to lower wages or higher labor productivity (lower production coefficient, a) does not inevitably mean agglomeration in the corresponding location, if the relative market size is too low. In consequence, low-cost locations do not benefit if the wage rate is above the curves exemplarily plotted in Figure 7. From the viewpoint of a larger country, this implies that as long as the wage rate in the smaller country is above both curves, the location with the larger market attracts the upstream and downstream sectors. For a wage rate in between the US- and DS-symmetry curves, the larger country releases the upstream sector for trade costs on the right of the intersection. On the left-hand side, where trade costs to the larger sales market become less relevant, the downstream industry becomes footloose and relocates before the upstream industry does.

6 Technical Appendix

Stability Analysis (Closed Economy)

As apparent in Figure 1 and provable by differentiating equations (17) and (19) at the equilibrium, the graph of N^d intersects N^u always from above, which confirms the global stability.

However, to prove the stability analytically, we assume an out-of-equilibrium ad-

justment process with the following characteristics:⁹

$$(47) \quad \begin{aligned} \dot{n}^u &= f(\pi^u) , \quad \partial f / \partial \pi^u > 0 \\ \dot{n}^d &= f(\pi^d) , \quad \partial f / \partial \pi^d > 0 , \quad f(0) = 0. \end{aligned}$$

By substitution, the relative profit functions subject to the number of upstream and downstream firms can be expressed as:

$$(48a) \quad \pi^u = \alpha w F^d \frac{\sigma}{\varsigma} (n^u)^{\frac{\alpha+\varsigma-1}{1-\varsigma}} n^d - w F^u \equiv K_1 (n^u)^{\frac{\alpha+\varsigma-1}{1-\varsigma}} n^d - w F^u$$

$$(48b) \quad \pi^d = \frac{\mu Y}{\sigma n^d} - w F^d (n^u)^{\frac{\alpha}{1-\varsigma}} \equiv K_2 (n^d)^{-1} - K_3 (n^u)^{\frac{\alpha}{1-\varsigma}} ,$$

where K_1, K_2 and $K_3 > 0$. Totally differentiating the profit functions (48) yields:

$$(49a) \quad d\pi^u = \underbrace{\left[\left(\frac{\alpha + \varsigma - 1}{1 - \varsigma} \right) K_1 (n^u)^{\frac{\alpha+\varsigma-1}{1-\varsigma}-1} n^d \right]}_{<0} dn^u + \underbrace{\left[K_1 (n^u)^{\frac{\alpha+\varsigma-1}{1-\varsigma}} \right]}_{>0} dn^d$$

$$(49b) \quad d\pi^d = \underbrace{\left[-K_2 (n^d)^{-2} \right]}_{<0} dn^d + \underbrace{\left[\left(\frac{\alpha}{\varsigma - 1} \right) K_3 (n^u)^{\frac{\alpha}{1-\varsigma}-1} \right]}_{>0} dn^u .$$

As apparent as the sign of the partial derivative in (49a), an increase in the number of upstream firms out of the zero-profit isocline, N^u , generates losses in this industry caused by the intermediate price index effect. Via the assumed adjustment process given by (47), the number of upstream firms decreases again, until they break even. A secondary effect works in the downstream sector. The decreasing intermediate price index reduces procurement cost for downstream firms, and makes them realize profits, which, in turn, attracts more downstream firms. The entry of new firms into the downstream market reduces their profits again via the price index effect (see equation (49b)), which retracts the number of downstream firms back to the zero-profit isocline (19). The overall result is a globally stable equilibrium indicated by the directional arrows in Figure 1.

⁹Based upon Neary (2001) for the standard Dixit-Stiglitz model.

Specified Equation System

For analytical traceability, the equation system is fully specified as follows:

$$(50) \quad n_1^d w_1^{1-\alpha} (P_1^u)^{\zeta-1+\alpha} (w_1^{-\zeta} - w_2^{-\zeta} t^{1-\zeta}) = n_2^d w_2^{1-\alpha} (P_2^u)^{\zeta-1+\alpha} (w_2^{-\zeta} - w_1^{-\zeta} t^{1-\zeta})$$

$$(51) \quad \begin{aligned} & \mu Y_1 w_1^{\sigma(\alpha-1)} (P_1^u)^{\sigma-1} (P_1^d)^{\sigma-1} + \mu Y_2 w_1^{\sigma(\alpha-1)} (P_1^u)^{\sigma-1} (P_2^d)^{\sigma-1} t^{1-\sigma} \\ & = \mu Y_1 w_2^{\sigma(\alpha-1)} (P_2^u)^{\sigma-1} (P_1^d)^{\sigma-1} t^{1-\sigma} + \mu Y_2 w_2^{\sigma(\alpha-1)} (P_2^u)^{\sigma-1} (P_2^d)^{\sigma-1} \end{aligned}$$

$$(52a) \quad (P_1^u)^{1-\zeta} = w_1^{1-\zeta} n_1^u + (w_2 t)^{1-\zeta} n_2^u$$

$$(52b) \quad (P_2^u)^{1-\zeta} = (w_1 t)^{1-\zeta} n_1^u + w_2^{1-\zeta} n_2^u$$

$$(53a) \quad (P_1^d)^{1-\sigma} = w_1^{(1-\alpha)(1-\sigma)} (P_1^u)^{\alpha(1-\sigma)} n_1^d + w_2^{(1-\alpha)(1-\sigma)} (P_2^u)^{\alpha(1-\sigma)} t^{1-\sigma} n_2^d$$

$$(53b) \quad (P_2^d)^{1-\sigma} = w_1^{(1-\alpha)(1-\sigma)} (P_1^u)^{\alpha(1-\sigma)} t^{1-\sigma} n_1^d + w_2^{(1-\alpha)(1-\sigma)} (P_2^u)^{\alpha(1-\sigma)} n_2^d$$

$$(54) \quad \alpha \frac{\sigma F^d}{\zeta F^u} [n_1^d w_1^{1-\alpha} (P_1^u)^\alpha + n_2^d w_2^{1-\alpha} (P_2^u)^\alpha] = n_1^u w_1 + n_2^u w_2$$

$$(55) \quad \frac{\mu (Y_1 + Y_2)}{\sigma F^d} = n_1^d w_1^{1-\alpha} (P_1^u)^\alpha + n_2^d w_2^{1-\alpha} (P_2^u)^\alpha$$

Equation (51) is the upstream outputs, where zero-profits implies a fixed firm size in both locations. Similarly, equation (51) holds for the downstream industry. Equations (52) – (55) are the price indices; equations (56) and (57) are the market clearing conditions for the upstream and downstream sectors, respectively.

Symmetric Solution

From equating upstream and downstream firm numbers in both locations, the symmetric solution set can be found ($w_1 = w_2 = 1$, $F^u = F^d$):

$$(56) \quad n_s^u = \frac{\alpha \mu (Y_1 + Y_2)}{2 \zeta F}$$

$$(57) \quad n_s^d = \frac{1}{\sigma} \left[\frac{\mu(Y_1 + Y_2)}{2F} \right]^{\frac{\alpha+\zeta-1}{\zeta-1}} \left[\frac{\alpha}{\zeta} (1 + t^{1-\zeta}) \right]^{\frac{\alpha}{\zeta-1}}$$

$$(58) \quad (P_s^u)^{1-\zeta} = (1 + t^{1-\zeta}) n_s^u$$

$$(59) \quad (P_s^d)^{1-\sigma} = (1 + t^{1-\sigma}) (P_s^u)^{\alpha(1-\sigma)} n_s^d$$

Corner Solutions

Due to variability of the corner solutions with respect to trade costs, we need to distinguish between two cases: i) $t < t^c$, and ii) $t > t^c$.

Setting peripheral firm numbers equal to zero, $\underline{n}^u = \underline{n}^d = 0$, yields:

$$(60) \quad \bar{n}^u = \frac{\alpha\mu(Y_1 + Y_2)}{\zeta F}$$

$$(61) \quad \bar{n}^d = \left[\frac{\mu(Y_1 + Y_2)}{\sigma F} \right] (\bar{n}^u)^{\frac{\alpha}{\zeta-1}}$$

$$(62) \quad (\bar{P}^u)^{1-\zeta} = \bar{n}^u$$

$$(63) \quad \underline{P}^u = \bar{P}^u t$$

$$(64) \quad (\bar{P}^d)^{1-\sigma} = (\bar{P}^u)^{\alpha-\alpha\sigma} \bar{n}^d$$

$$(65) \quad \underline{P}^d = \bar{P}^d t$$

The Break Point

Totally differentiating the equation system (50) – (55) at the symmetric equilibrium yields:

$$(66) \quad \frac{dn_s^d}{n_s^d} = (1 - \zeta - \alpha) \frac{dP_s^u}{P_s^u}$$

$$(67) \quad \frac{dP_s^d}{P_s^d} = \left[\frac{\sigma\alpha}{\sigma-1} \right] \left[\frac{1+t^{1-\sigma}}{1-t^{1-\sigma}} \right] \frac{dP_s^u}{P_s^u}$$

$$(68) \quad \frac{dP_s^u}{P_s^u} = \left[\frac{1 - \varsigma}{1 - \varsigma - \alpha} \right] \frac{(P_s^u)^{\varsigma-1}}{1 - t^{\varsigma-1}} dn_s^u$$

$$(69) \quad \frac{dP_s^d}{P_s^d} = (1 - t^{1-\sigma}) n_s^d (P_s^u)^{\alpha(1-\sigma)} (P_s^d)^{\sigma-1} \left\{ \alpha \frac{dP_s^u}{P_s^u} + \left(\frac{1}{1 - \sigma} \right) \frac{dn_s^d}{n_s^d} \right\}.$$

The downstream profit function can be expressed as:

$$(70) \quad \pi_1^d = (P_1^u)^\alpha = \left[\frac{x_1^d}{\sigma} - F \right].$$

After substituting downstream demand (28a) and totally differentiating again, we obtain:

$$(71) \quad d\pi_s^d = \left(\frac{1 - \sigma}{\sigma} \right) (P_s^d)^{\sigma-1} (P_s^u)^{\alpha(1-\sigma)} \left\{ \alpha \mu (Y_1 + Y_2 t^{1-\sigma}) \frac{dP_s^u}{P_s^u} - \mu (Y_1 - Y_2 t^{1-\sigma}) \frac{dP_s^d}{P_s^d} \right\} - \alpha F (P_s^u)^\alpha \frac{dP_s^u}{P_s^u}$$

In the next step, we combine equations (66)–(69) and substitute them in (71). Now we rearrange the profit differential in such a way that $d\pi_s^d/dn_s^d$ results, which is the slope at n_s^d in Figure 4. Setting this expression equal to zero yields the break point condition (40).

References

- Baldwin, R., Forslid, R., Martin, P., Ottaviano, G. and Robert-Nicoud, F.: 2003, *Economic Geography and Public Policy*, Princeton University Press, Princeton.
- Ethier, W.: 1982, National and international returns to scale in the modern theory of international trade, *American Economic Review* **72**, 389–405.
- Hummels, D., Ishii, J. and Yi, K.: 2001, The nature and growth of vertical specialization in world trade, *Journal of International Economics* **54**(1), 75–96.
- Hummels, D., Rapoport, D. and Yi, K.: 1998, Vertical specialization and the changing nature of world trade, *Economic Policy Review* **4**(2), 79–99.
- Krugman, P.: 1991, Increasing returns and economic geography, *Journal of Political Economy* **99**, 483–499.
- Krugman, P. and Venables, A. J.: 1995, Globalization and the inequality of nations, *The Quarterly Journal of Economics* **110**, 857–880.
- Markusen, J.: 1989, Trade in producer services and other specialized intermediate inputs, *American Economic Review* **79**, 85–95.
- Midelfart-Knarvik, K., Overman, H., Redding, S. and Venables, A.: 2000, The location of European industry, *Economic Papers* **142**, European Commission.
- Neary, P. J.: 2001, Of hype and hyperbolas: Introducing the new economic geography, *Journal of Economic Literature* **39**, 536–561.
- Ottaviano, G.: 2002, Regional policy in the global economy: Insights from the new economic geography, *HWWA discussion paper No. 211*, Hamburgisches Welt-Wirtschafts-Archiv, Hamburg.
- Rivera-Batiz, F.: 1988, Increasing returns, monopolistic competition and agglomeration economies in consumption and production, *Regional Science and Urban Economics* **18**, 125–153.

- Robert-Nicoud, F.: 2002, A simple model of agglomeration with vertical linkages and perfect capital mobility. Chapter 1 in *New Economic Geography: Welfare, Multiple Equilibria and Political Economy*. *PhD Thesis*, London School of Economics.
- Venables, A.: 1996, Equilibrium locations of vertically linked industries, *International Economic Review* **37**, 341–359.
- Yeats, A.: 1998, Just how big is global production sharing?, *Working Paper 1871*, World Bank Policy Research.

7 Figures and Tables

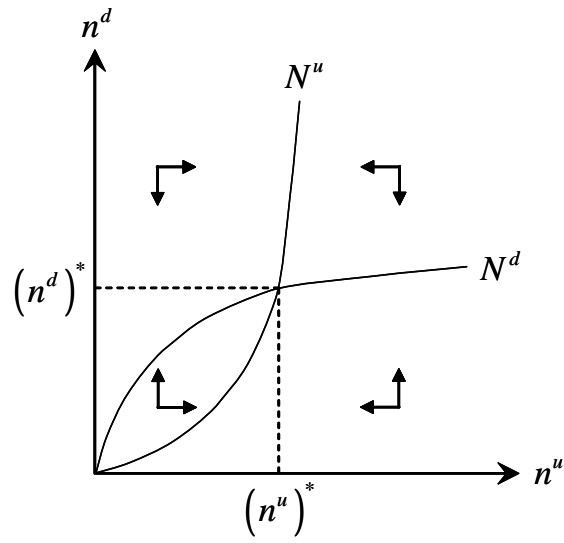

Figure 1: Equilibrium Number of Upstream and Downstream Firms

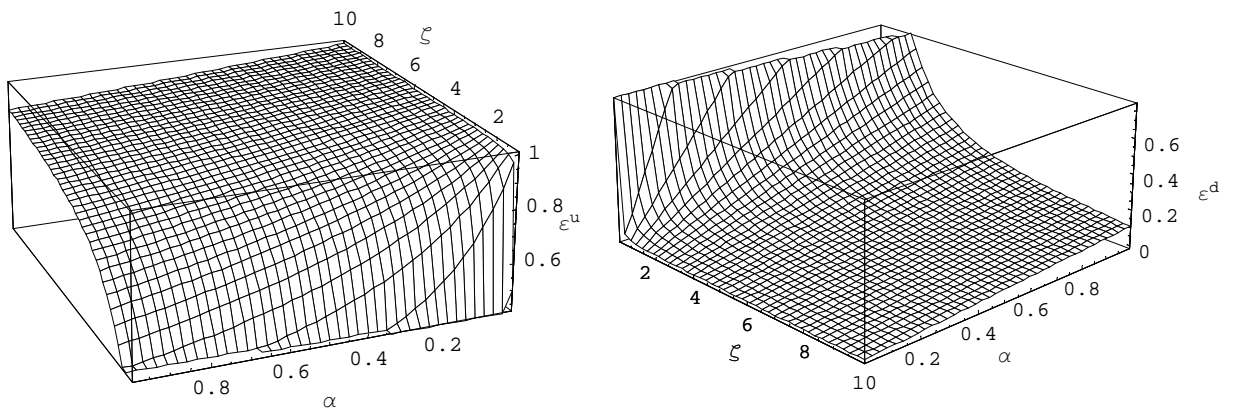

Figure 2: Strength of Forward and Backward Linkage

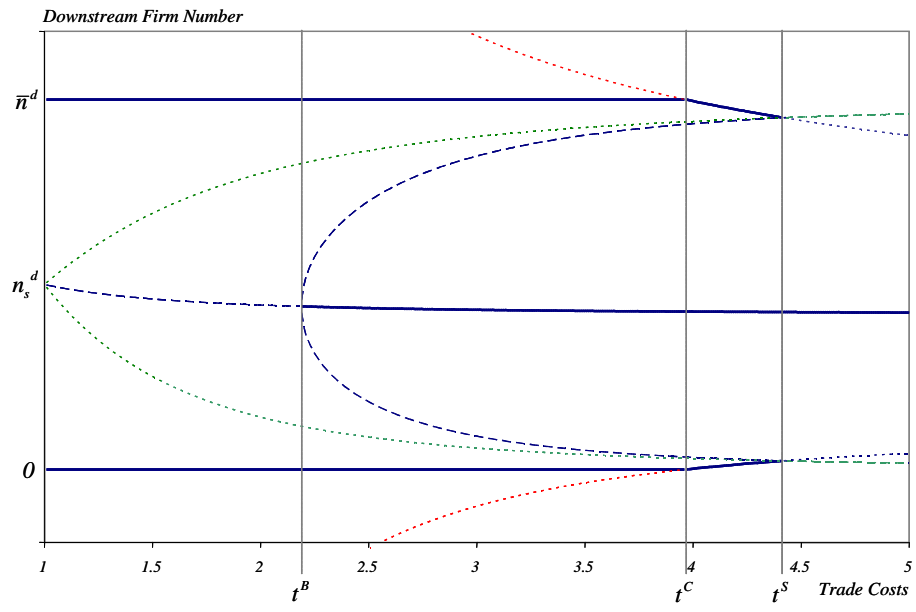

Figure 3: Bifurcation Diagram Downstream

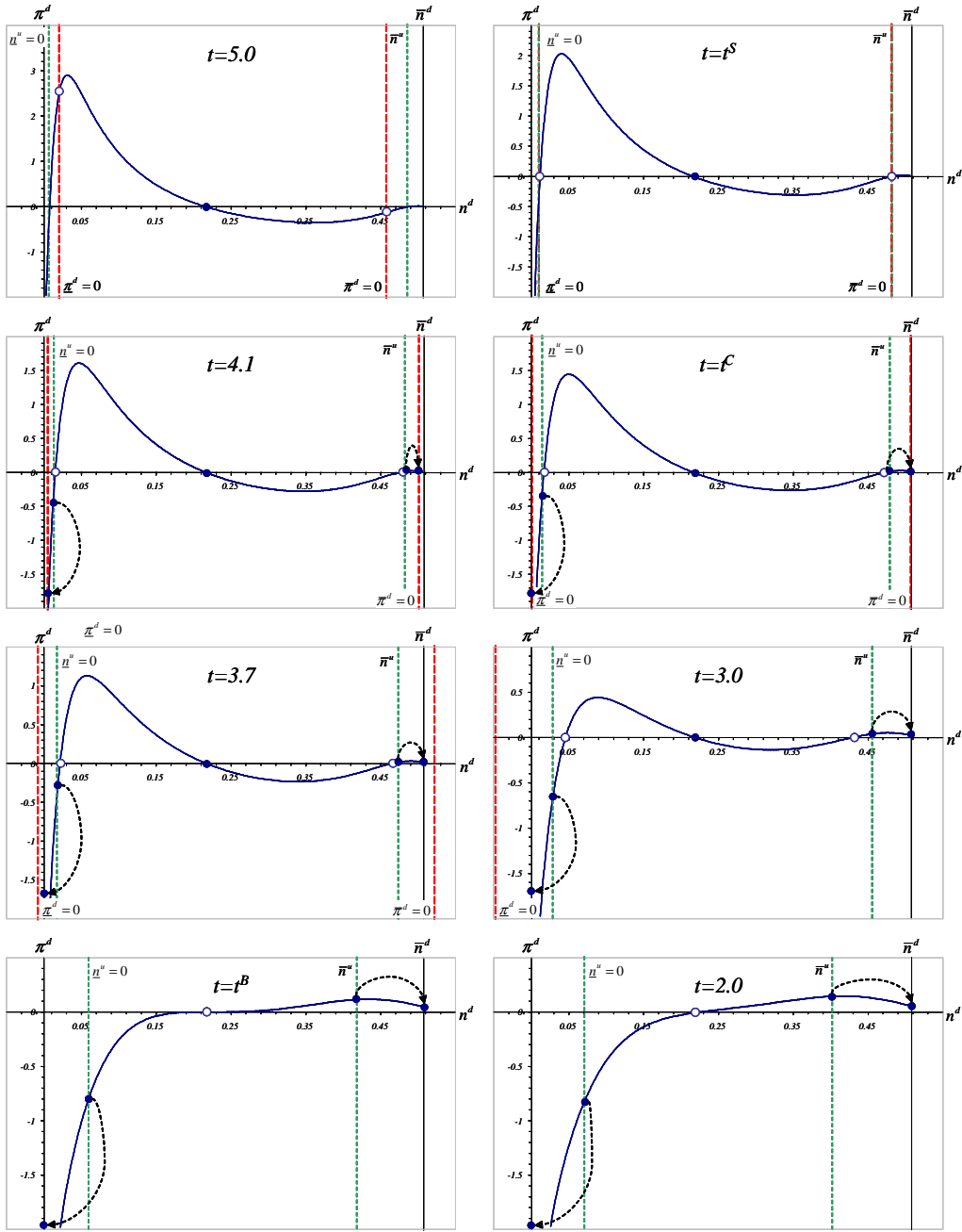

Figure 4: Downstream Profit Function

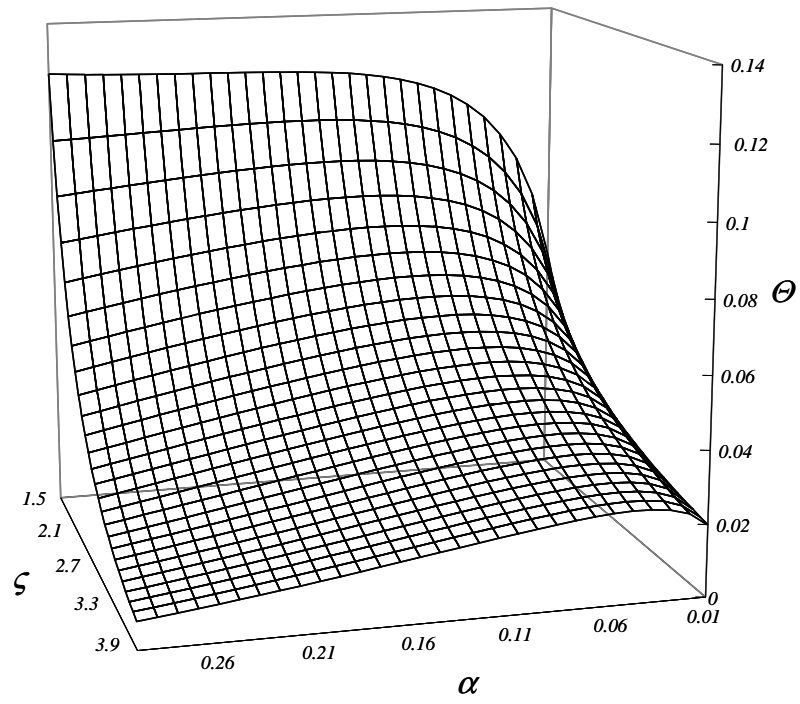

Figure 5: Inertia of the Downstream Industry

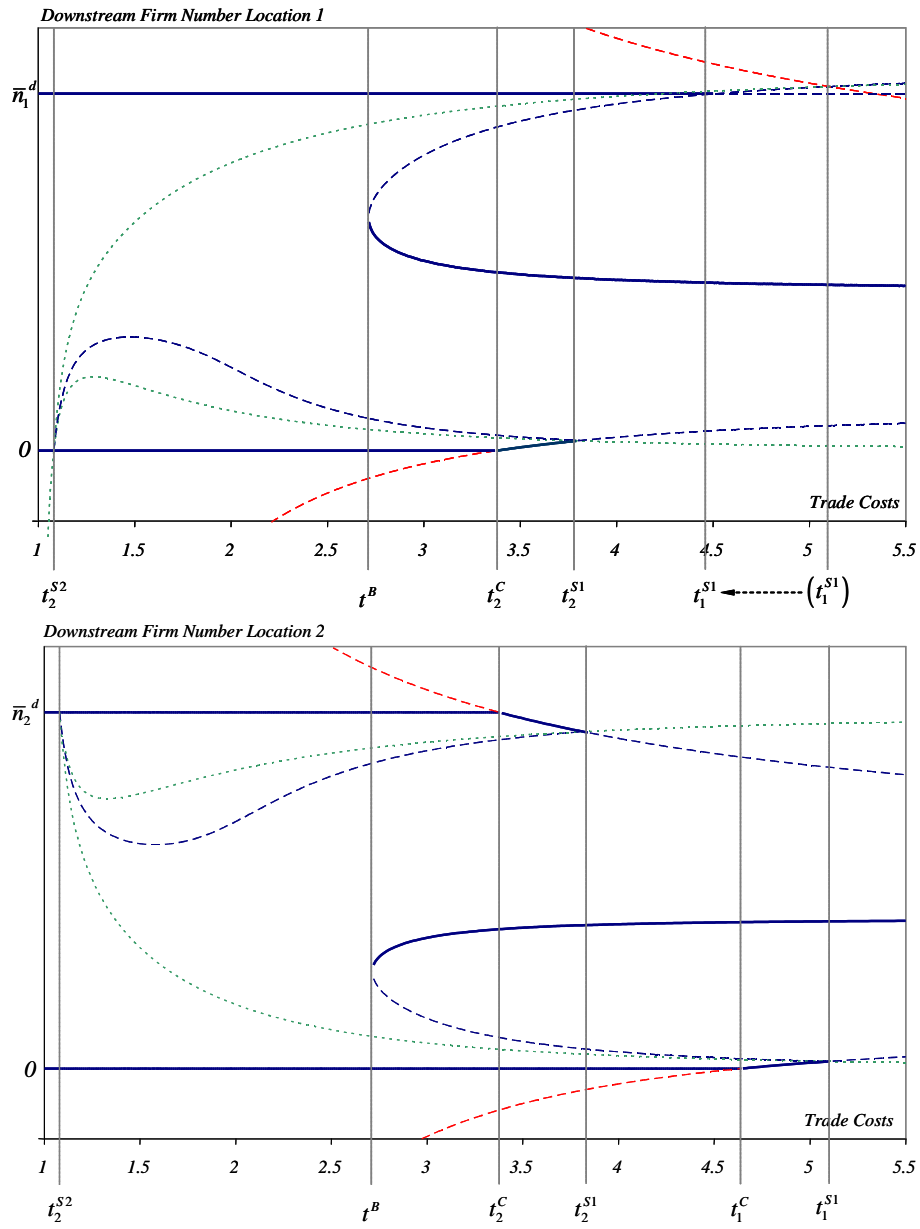

Figure 6: Asymmetries: Downstream Bifurcation Diagrams

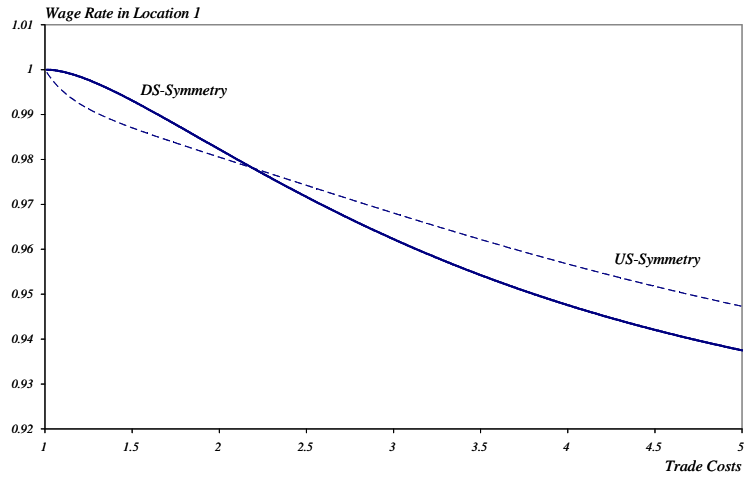

Figure 7: Country Size Compensating Wage Rate

Table 1: Comparative Statics of Critical Trade Cost Values

ζ	α											
	0.01		0.05		0.1		0.2		0.5		0.6	
1.2	t^B	1.4597	t^B	2.1889	t^B	2.8059	t^B	3.7321	t^B	5.6541	t^B	6.1623
	t^C	1.0151	t^C	1.0782	t^C	1.1645	t^C	1.3767	t^C	3.9679	t^C	31.9998
	t^S	1.4599	t^S	2.1954	t^S	2.8455	t^S	4.0264	t^S	19.7892	t^S	243.0000
	FL	0.9524	FL	0.8000	FL	0.6667	FL	0.5000	FL	0.2857	FL	0.2500
	BL	0.0500	BL	0.2500	BL	0.5000	BL	1.0000	BL	2.5000	BL	3.0000
1.5	Ω	0.2604	Ω	0.1587	Ω	0.1098	Ω	0.0725	Ω	0.0337	Ω	0.0062
	Θ	0.1059	Θ	0.1545	Θ	0.1577	Θ	0.1627	Θ	0.5127	Θ	1.3448
	t^B	1.2745	t^B	1.6879	t^B	2.0395	t^B	2.5787	t^B	3.7321	t^B	4.0421
	t^C	1.0151	t^C	1.0782	t^C	1.1645	t^C	1.3767	t^C	3.9679	t^C	31.9998
	t^S	1.2747	t^S	1.6928	t^S	2.0635	t^S	2.7278	t^S	8.9927	t^S	62.8108
1.5	FL	0.9804	FL	0.9091	FL	0.8333	FL	0.7143	FL	0.5000	FL	0.4545
	BL	0.0200	BL	0.1000	BL	0.2000	BL	0.4000	BL	1.0000	BL	1.2000
	Ω	0.2865	Ω	0.2152	Ω	0.1701	Ω	0.1212	Ω	0.0371	Ω	0.0048
	Θ	0.0655	Θ	0.1081	Θ	0.1204	Θ	0.1242	Θ	0.1372	Θ	0.0979
	t^B	1.1881	t^B	1.4597	t^B	1.6879	t^B	2.0395	t^B	2.8059	t^B	3.0150
2.0	t^C	1.0151	t^C	1.0782	t^C	1.1645	t^C	1.3767	t^C	3.9679	t^C	31.9998
	t^S	1.1884	t^S	1.4644	t^S	1.7079	t^S	2.1448	t^S	5.8140	t^S	36.7350
	FL	0.9901	FL	0.9524	FL	0.9091	FL	0.8333	FL	0.6667	FL	0.6250
	BL	0.0100	BL	0.0500	BL	0.1000	BL	0.2000	BL	0.5000	BL	0.6000
	Ω	0.2904	Ω	0.2285	Ω	0.1854	Ω	0.1319	Ω	0.0287	Ω	0.0015
3.0	Θ	0.0427	Θ	0.0680	Θ	0.0737	Θ	0.0699	Θ	0.0323	Θ	0.0038
	t^B	1.1300	t^B	1.3107	t^B	1.4597	t^B	1.6879	t^B	2.1889	t^B	2.3271
	t^C	1.0151	t^C	1.0782	t^C	1.1645	t^C	1.3767	t^C	3.9679	t^C	31.9998
	t^S	1.1303	t^S	1.3160	t^S	1.4795	t^S	1.7776	t^S	4.4156	t^S	32.1550
	FL	0.9950	FL	0.9756	FL	0.9524	FL	0.9091	FL	0.8000	FL	0.7692
5.0	BL	0.0050	BL	0.0250	BL	0.0500	BL	0.1000	BL	0.2500	BL	0.3000
	Ω	0.2851	Ω	0.2211	Ω	0.1756	Ω	0.1168	Ω	0.0118	Ω	0.0001
	Θ	0.0267	Θ	0.0378	Θ	0.0373	Θ	0.0292	Θ	0.0028	Θ	0.0000
	t^B	1.0904	t^B	1.2122	t^B	1.3107	t^B	1.4597	t^B	1.7850	t^B	1.8750
	t^C	1.0151	t^C	1.0782	t^C	1.1645	t^C	1.3767	t^C	3.9679	t^C	31.9998
7.0	t^S	1.0908	t^S	1.2188	t^S	1.3333	t^S	1.5530	t^S	3.9996	t^S	32.0000
	FL	0.9975	FL	0.9877	FL	0.9756	FL	0.9524	FL	0.8889	FL	0.8696
	BL	0.0025	BL	0.0125	BL	0.0250	BL	0.0500	BL	0.1250	BL	0.1500
	Ω	0.2719	Ω	0.1960	Ω	0.1437	Ω	0.0789	Ω	0.0011	Ω	0.0000
	Θ	0.0159	Θ	0.0184	Θ	0.0150	Θ	0.0079	Θ	0.0000	Θ	0.0000
9.0	t^B	1.0732	t^B	1.1705	t^B	1.2483	t^B	1.3650	t^B	1.6180	t^B	1.6879
	t^C	1.0151	t^C	1.0782	t^C	1.1645	t^C	1.3767	t^C	3.9679	t^C	31.9998
	t^S	1.0738	t^S	1.1782	t^S	1.2742	t^S	1.4694	t^S	3.9700	t^S	31.9998
	FL	0.9983	FL	0.9917	FL	0.9836	FL	0.9677	FL	0.9231	FL	0.9091
	BL	0.0017	BL	0.0083	BL	0.0167	BL	0.0333	BL	0.0833	BL	0.1000
9.0	Ω	0.2605	Ω	0.1737	Ω	0.1161	Ω	0.0507	Ω	0.0001	Ω	0.0000
	Θ	0.0114	Θ	0.0110	Θ	0.0075	Θ	0.0025	Θ	0.0000	Θ	0.0000
	t^B	1.0631	t^B	1.1463	t^B	1.2122	t^B	1.3107	t^B	1.5227	t^B	1.5811
	t^C	1.0151	t^C	1.0782	t^C	1.1645	t^C	1.3767	t^C	3.9679	t^C	31.9998
	t^S	1.0638	t^S	1.1550	t^S	1.2414	t^S	1.4280	t^S	3.9681	t^S	31.9998
FL	0.9988	FL	0.9938	FL	0.9877	FL	0.9756	FL	0.9412	FL	0.9302	
BL	0.0013	BL	0.0063	BL	0.0125	BL	0.0250	BL	0.0625	BL	0.0750	
Ω	0.2505	Ω	0.1545	Ω	0.0937	Ω	0.0314	Ω	0.0000	Ω	0.0000	
Θ	0.0088	Θ	0.0073	Θ	0.0041	Θ	0.0008	Θ	0.0000	Θ	0.0000	

Working Paper Series in Economics

(see www.leuphana.de/vwl/papers for a complete list)

- No.97: *Joachim Wagner*: Exports and firm characteristics - First evidence from Fractional Probit Panel Estimates, August 2008
- No.96: *Nils Braakmann*: The smoking wage penalty in the United Kingdom: Regression and matching evidence from the British Household Panel Survey, August 2008
- No.95: *Joachim Wagner*: Exportaktivitäten und Rendite in niedersächsischen Industrieunternehmen, August 2008
[forthcoming in: Jahrbücher für Nationalökonomie und Statistik]
- No.94: *Joachim Wagner*: Wirken sich Exportaktivitäten positiv auf die Rendite von deutschen Industrieunternehmen aus?, August 2008
[erscheint in: Wirtschaftsdienst]
- No.93: *Claus Schnabel & Joachim Wagner*: The aging of the unions in West Germany, 1980-2006, August 2008
[erscheint in: Statistische Monatshefte Niedersachsen]
- No.92: *Alexander Vogel and Stefan Dittrich*: The German turnover tax statistics panels, August 2008
[forthcoming in: Schmollers Jahrbuch 128 (2008)]
- No.91: *Nils Braakmann*: Crime does pay (at least when it's violent!) – On the compensating wage differentials of high regional crime levels, July 2008
- No.90: *Nils Braakmann*: Fields of training, plant characteristics and the gender wage gap in entry wages among skilled workers – Evidence from German administrative data, July 2008
- No.89: *Alexander Vogel*: Exports productivity in the German business services sector: First evidence from the Turnover Tax Statistics panel, July 2008
- No.88: *Joachim Wagner*: Improvements and future challenges for the research infrastructure in the field *Firm Level Data*, June 2008
- No.87: *Markus Groth*: A review of the German mandatory deposit for one-way drinks packaging and drinks packaging taxes in Europe, June 2008
- No.86: *Heike Wetzel*: European railway deregulation. The influence of regulatory and environmental conditions on efficiency, May 2008
- No.85: *Nils Braakmann*: Non scholae, sed vitae discimus! - The importance of fields of study for the gender wage gap among German university graduates during market entry and the first years of their careers, May 2008
- No.84: *Markus Groth*: Private ex-ante transaction costs for repeated biodiversity conservation auctions: A case study, May 2008
- No.83: *Jan Kranich*: R&D and the agglomeration of industries, April 2008
- No.82: *Alexander Vogel*: Zur Exporttätigkeit unternehmensnaher Dienstleister in Niedersachsen - Erste Ergebnisse zu Export und Produktivität auf Basis des Umsatzsteuerstatistikpanels, April 2008
- No.81: *Joachim Wagner*: Exporte und Firmenerfolg: Welche Firmen profitieren wie vom internationalen Handel?, März 2008

- No.80: *Stefan Baumgärtner*: Managing increasing environmental risks through agro-biodiversity and agri-environmental policies, March 2008
- No.79: *Thomas Huth*: Die Quantitätstheorie des Geldes – Eine keynesianische Reformulierung, März 2008
- No.78: *Markus Groth*: An empirical examination of repeated auctions for biodiversity conservation contracts, March 2008
- No.77: *Nils Braakmann*: Intra-firm wage inequality and firm performance – First evidence from German linked employer-employee-data, February 2008
- No.76: *Markus Groth*: Perspektiven der Nutzung von Methanhydraten als Energieträger – Eine Bestandsaufnahme, Februar 2008
- No.75: *Stefan Baumgärtner, Christian Becker, Karin Frank, Birgit Müller & Christian Quaas*: Relating the philosophy and practice of ecological economics. The role of concepts, models, and case studies in inter- and transdisciplinary sustainability research, January 2008
[forthcoming in: Ecological Economics]
- No.74: *Thorsten Schank, Claus Schnabel & Joachim Wagner*: Higher wages in exporting firms: Self-selection, export effect, or both? First evidence from German linked employer-employee data, January 2008
- No.73: *Institut für Volkswirtschaftslehre*: Forschungsbericht 2007, Januar 2008
- No.72: *Christian Growitsch and Heike Wetzel*: Testing for economies of scope in European railways: An efficiency analysis, December 2007
[revised version of Working Paper No. 29, forthcoming in: Journal of Transport Economics and Policy]
- No.71: *Joachim Wagner, Lena Koller and Claus Schnabel*: Sind mittelständische Betriebe der Jobmotor der deutschen Wirtschaft?, Dezember 2007
[publiziert in: Wirtschaftsdienst 88 (2008), 2, 130-135]
- No.70: *Nils Braakmann*: Islamistic terror, the war on Iraq and the job prospects of Arab men in Britain: Does a country's direct involvement matter?, December 2007
- No.69: *Maik Heinemann*: E-stability and stability learning in models with asymmetric information, December 2007
- No.68: *Joachim Wagner*: Exporte und Produktivität in Industriebetrieben – Niedersachsen im interregionalen und internationalen Vergleich, Dezember 2007
- No.67: *Stefan Baumgärtner and Martin F. Quaas*: Ecological-economic viability as a criterion of strong sustainability under uncertainty, November 2007
- No.66: *Kathrin Michael*: Überbrückungsgeld und Existenzgründungszuschuss – Ergebnisse einer schriftlichen Befragung drei Jahre nach Gründungsbeginn, November 2007
- No.65: *The International Study Group on Export and Productivity*: Exports and Productivity – Comparable Evidence for 14 Countries, November 2007
- No.64: *Lena Koller, Claus Schnabel und Joachim Wagner*: Freistellung von Betriebsräten – Eine Beschäftigungsbremse?, November 2007
[erscheint in: Zeitschrift für Arbeitsmarktforschung, Heft 2/3 2008]
- No.63: *Anne-Kathrin Last*: The Monetary Value of Cultural Goods: A Contingent Valuation Study of the Municipal Supply of Cultural Goods in Lueneburg, Germany, October 2007

- No.62: *Thomas Wein und Heike Wetzel*: The Difficulty to Behave as a (regulated) Natural Monopolist – The Dynamics of Electricity Network Access Charges in Germany 2002 to 2005, September 2007
- No.61: *Stefan Baumgärtner und Martin F. Quaas*: Agro-biodiversity as natural insurance and the development of financial insurance markets, September 2007
[published in: A. Kontoleon, U. Pascual and M. Smale (eds.): Agrobiodiversity, conservation and economic development, Routledge, London, 293-317]
- No.60: *Stefan Bender, Joachim Wagner, Markus Zwick*: KombiFiD - Kombinierte Firmendaten für Deutschland, September 2007
- No.59: *Jan Kranich*: Too much R&D? - Vertical differentiation in a model of monopolistic competition, August 2007
- No.58: *Christian Papilloud und Ingrid Ott*: Convergence or mediation? Experts of vulnerability and the vulnerability of experts' discourses on nanotechnologies – a case study, July 2007
[published in: European Journal of Social Science Research 21 (2008), 1, 41-64]
- No.57: *Ingrid Ott und Susanne Soretz*: Governmental activity, integration and agglomeration, July 2007
[published in: ICFAI Journal of Managerial Economics 5 (2008), 2, 28-47]
- No.56: *Nils Braakmann*: Struktur und Erfolg von Ich-AG-Gründungen: Ergebnisse einer Umfrage im Arbeitsagenturbezirk Lüneburg, Juli 2007
[revidierte Fassung erscheint in: Richter, J., Schöning, S. & Wetzel, H., Mittelstand 2008. Aktuelle Forschungsbeiträge zu gesellschaftlichen und finanzwirtschaftlichen Herausforderungen, Frankfurt am Main: Peter Lang, 2008]
- No.55: *Nils Braakmann*: Differences in the earnings distribution of self- and dependent employed German men – evidence from a quantile regression decomposition analysis, July 2007
- No.54: *Joachim Waagner*: Export entry, export exit, and productivity in German Manufacturing Industries, June 2007
[published in: International Journal of the Economics of Business 15 (2008), 2, 169-180]
- No.53: *Nils Braakmann*: Wirkungen der Beschäftigungspflicht schwerbehinderter Arbeitnehmer – Erkenntnisse aus der Einführung des „Gesetzes zur Bekämpfung der Arbeitslosigkeit Schwerbehinderter“, Juni 2007
[revidierte Fassung erscheint in: Zeitschrift für Arbeitsmarktforschung/ Journal for Labour Market Research 41 (2008),1]
- No.52: *Jan Kranich und Ingrid Ott*: Regionale Spitzentechnologie auf internationalen Märkten, Juni 2007
[erscheint in: Merz, J. und Schulte, R. (Hrsg.): Neue Ansätze der MittelstandsForschung, Münster, 2007]
- No.51: *Joachim Wagner*: Die Forschungspotenziale der Betriebspaneldaten des Monatsberichts im Verarbeitenden Gewerbe, Mai 2007
[erscheint in: AStA – Wirtschafts- und Sozialwirtschaftliches Archiv]
- No.50: *Stefan Baumgärtner, Frank Jöst und Ralph Winkler*: Optimal dynamic scale and structure of a multi-pollution economy, May 2007
[forthcoming in: Ecological Economics]

- No.49: *Helmut Fryges und Joachim Wagner*: Exports and productivity growth – First evidence from a continuous treatment approach, May 2007
[forthcoming in: Review of World Economics]
- No.48: *Ulrich Kaiser und Joachim Wagner*: Neue Möglichkeiten zur Nutzung vertraulicher amtlicher Personen- und Firmendaten, April 2007
[publiziert in: Perspektiven der Wirtschaftspolitik 9 (2008), 3, 329-349]
- No.47: *Joachim Wagner*: Jobmotor Mittelstand? Arbeitsplatzdynamik und Betriebsgröße in der westdeutschen Industrie, April 2007
[publiziert in: Vierteljahrshefte zur Wirtschaftsforschung, 76 (2007), 3, 76-87]
- No.46: *Christiane Clemens und Maik Heinemann*: Credit Constraints, Idiosyncratic Risks, and the Wealth Distribution in a Heterogenous Agent Model, March 2007
- No.45: *Jan Kranich*: Biotechnologie und Internationalisierung. Ergebnisse der Online-Befragung, März 2007
- No.44: *Joachim Wagner*: Entry, exit and productivity. Empirical results for German manufacturing industries, March 2007
[forthcoming in: German Economic Review]
- No.43: *Joachim Wagner*: Productivity and Size of the Export Market Evidence for West and East German Plants, 2004, March 2007
[publiziert in: Jahrbücher für Nationalökonomie und Statistik, 227 (2007), 4, 403-408]
- No.42: *Joachim Wagner*: Why more West than East German firms export, March 2007
- No.41: *Joachim Wagner*: Exports and Productivity in Germany, March 2007
[publiziert in: Applied Economics Quarterly 53 (2007), 4, 353-373]
- No.40: *Lena Koller, Klaus Schnabel und Joachim Wagner*: Schwellenwerte im Arbeitsrecht. Höhere Transparenz und Effizienz durch Vereinheitlichung, Februar 2007
[publiziert in: Perspektiven der Wirtschaftspolitik, 8 (2007), 3, 242-255]
- No.39: *Thomas Wein und Wiebke B. Röber*: Sind ausbildende Handwerksbetriebe erfolgreicher?, Januar 2007
- No.38: *Institut für Volkswirtschaft*: Forschungsbericht 2006, Januar 2007
- No.37: *Nils Braakmann*: The impact of September 11th, 2001 on the job prospects of foreigners with Arab background – Evidence from German labor market data, January 2007
- No.36: *Jens Korunig*: Regulierung des Netzmonopolisten durch Peak-load Pricing?, Dezember 2006
- No.35: *Nils Braakmann*: Die Einführung der fachkundigen Stellungnahme bei der Ich-AG, November 2006
[erscheint in: Schulte, Reinhard: Neue Ansätze der MittelstandsForschung, Münster etc.: Lit, 2008]
- No.34: *Martin F. Quaas and Stefan Baumgärtner*: Natural vs. financial insurance in the management of public-good ecosystems, October 2006
[published in: Ecological Economics 65 (2008), 2, 397-406]
- No.33: *Stefan Baumgärtner and Martin F. Quaas*: The Private and Public Insurance Value of Conservative Biodiversity Management, October 2006
- No.32: *Ingrid Ott and Christian Papilloud*: Converging institutions. Shaping the relationships between nanotechnologies, economy and society, October 2006
[published in: Bulletin of Science, Technology & Society 2007 (27), 4, 455-466]

- No.31: *Claus Schnabel and Joachim Wagner*: The persistent decline in unionization in western and eastern Germany, 1980-2004: What can we learn from a decomposition analysis?, October 2006
[published in: Industrielle Beziehungen/The German Journal of Industrial Relations 14 (2007), 118-132]
- No.30: *Ingrid Ott and Susanne Soretz*: Regional growth strategies: fiscal versus institutional governmental policies, September 2006
[published in: Economic Modelling 25 (1008), 605-622]
- No.29: *Christian Growitsch and Heike Wetzel*: Economies of Scope in European Railways: An Efficiency Analysis, July 2006
- No.28: *Thorsten Schank, Claus Schnabel and Joachim Wagner*: Do exporters really pay higher wages? First evidence from German linked employer-employee data, June 2006
[published in in: Journal of International Economics 72 (2007), 1, 52-74]
- No.27: *Joachim Wagner*: Markteintritte, Marktaustritte und Produktivität
Empirische Befunde zur Dynamik in der Industrie, März 2006
[publiziert in: AStA – Wirtschafts- und Sozialwirtschaftliches Archiv 1 (2007), 3, 193-203]
- No.26: *Ingrid Ott and Susanne Soretz*: Governmental activity and private capital adjustment, March 2006
[forthcoming in: Icfai Journal of Managerial Economics]
- No.25: *Joachim Wagner*: International Firm Activities and Innovation: Evidence from Knowledge Production Functions for German Firms, March 2006
[published in: The Icfai Journal of Knowledge Management VI (2008), 2, 47-62]
- No.24: *Ingrid Ott und Susanne Soretz*: Nachhaltige Entwicklung durch endogene Umweltwahrnehmung, März 2006
publiziert in: Clemens, C., Heinemann, M. & Soretz, S., Auf allen Märkten zu Hause (Gedenkschrift für Franz Haslinger), Marburg: Metropolis, 2006, 233-256
- No.23: *John T. Addison, Claus Schnabel, and Joachim Wagner*: The (Parlous) State of German Unions, February 2006
[published in: Journal of Labor Research 28 (2007), 3-18]
- No.22: *Joachim Wagner, Thorsten Schank, Claus Schnabel, and John T. Addison*: Works Councils, Labor Productivity and Plant Heterogeneity: First Evidence from Quantile Regressions, February 2006
[published in: Jahrbücher für Nationalökonomie und Statistik 226 (2006), 505 - 518]
- No.21: *Corinna Bunk*: Betriebliche Mitbestimmung vier Jahre nach der Reform des BetrVG: Ergebnisse der 2. Befragung der Mitglieder des Arbeitgeberverbandes Lüneburg Nordostniedersachsen, Februar 2006
- No.20: *Jan Kranich*: The Strength of Vertical Linkages, July 2006
- No.19: *Jan Kranich und Ingrid Ott*: Geographische Restrukturierung internationaler Wertschöpfungsketten – Standortentscheidungen von KMU aus regionalökonomischer Perspektive, Februar 2006
[publiziert in: Merz, J. und Schulte, R. (Hrsg.): Fortschritte in der MittelstandsForschung, Münster, 2006, 113-129]
- No.18: *Thomas Wein und Wiebke B. Röber*: Handwerksreform 2004 – Rückwirkungen auf das Ausbildungsverhalten Lüneburger Handwerksbetriebe?, Februar 2006

- No.17: *Wiebke B. Röber und Thomas Wein*: Mehr Wettbewerb im Handwerk durch die Handwerksreform?, Februar 2006
- No.16: *Joachim Wagner*: Politikrelevante Folgerungen aus Analysen mit wirtschaftsstatistischen Einzeldaten der Amtlichen Statistik, Februar 2006
[publiziert in: Schmollers Jahrbuch 126 (2006) 359-374]
- No.15: *Joachim Wagner*: Firmenalter und Firmenperformance
Empirische Befunde zu Unterschieden zwischen jungen und alten Firmen in Deutschland, September 2005
[publiziert in: Lutz Bellmann und Joachim Wagner (Hrsg.), Betriebsdemographie (Beiträge zur Arbeitsmarkt- und Berufsforschung, Band 305), Nürnberg: IAB der BA, 83-111]
- No.14: *Joachim Wagner*: German Works Councils and Productivity: First Evidence from a Nonparametric Test, September 2005
[published in: Applied Economics Letters 15 (2008), 727-730]
- No.13: *Lena Koller, Claus Schnabel und Joachim Wagner*: Arbeitsrechtliche Schwellenwerte und betriebliche Arbeitsplatzdynamik: Eine empirische Untersuchung am Beispiel des Schwerbehindertengesetzes, August 2005
[publiziert in: Zeitschrift für ArbeitsmarktForschung/ Journal for Labour Market Research 39 (2006), 181-199]
- No.12: *Claus Schnabel and Joachim Wagner*: Who are the workers who never joined a union? Empirical evidence from Germany, July 2005
[published in: Industrielle Beziehungen/ The German Journal of Industrial Relations 13 (2006), 118-131]
- No.11: *Joachim Wagner*: Exporte und Produktivität in mittelständischen Betrieben
Befunde aus der niedersächsischen Industrie (1995 – 2004), June 2005
[publiziert in: Niedersächsisches Landesamt für Statistik, Statistische Berichte Niedersachsen, Sonderausgabe: Tagung der NLS am 9. März 2006, Globalisierung und regionale Wirtschaftsentwicklung - Datenlage und Datenbedarf in Niedersachsen. Hannover, Niedersächsisches Landesamt für Statistik, Juli 2006, 18 – 29]
- No.10: *Joachim Wagner*: Der Noth gehorchend, nicht dem eignen Trieb.
Nascent Necessity and Opportunity Entrepreneurs in Germany.
Evidence from the Regional Entrepreneurship Monitor (REM), May 2005
[published in: RWI: Mitteilungen. Quarterly 54/ 55 (2003/04), 287-303
{published June 2006}]
- No. 9: *Gabriel Desgranges and Maik Heinemann*: Strongly Rational Expectations Equilibria with Endogenous Acquisition of Information, March 2005
- No. 8: *Joachim Wagner*: Exports, Foreign Direct Investment, and Productivity: Evidence from German Firm Level Data, March 2005
[published in: Applied Economics Letters 13 (2006), 347-349]
- No. 7: *Thomas Wein*: Associations' Agreement and the Interest of the Network Suppliers – The Strategic Use of Structural Features, March 2005
- No. 6: *Christiane Clemens and Maik Heinemann*: On the Effects of Redistribution on Growth and Entrepreneurial Risk-Taking, March 2005

- No. 5: *Christiane Clemens and Maik Heinemann: Endogenous Redistributive Cycles – An overlapping Generations Approach to Social Conflict and Cyclical Growth*, March 2005
- No. 4: *Joachim Wagner: Exports and Productivity: A Survey of the Evidence from Firm Level Data*, March 2005
[published in: *The World Economy* 30 (2007), 1, 60-82]
- No. 3: *Thomas Wein and Reimund Schwarze: Is the Market Classification of Risk Always Efficient? - Evidence from German Third Party Motor Insurance*, March 2005
- No. 2: *Ingrid Ott and Stephen J. Turnovsky: Excludable and Non-Excludable Public Inputs: Consequences for Economic Growth*, June 2005 (Revised version)
[published in: *Economica* 73 (2006), 292, 725-742
also published as CESifo Working Paper 1423]
- No. 1: *Joachim Wagner: Nascent and Infant Entrepreneurs in Germany. Evidence from the Regional Entrepreneurship Monitor (REM)*, March 2005
[erschienen in: Joachim Merz, Reinhard Schulte (Hrsg.), *Neue Ansätze der Mittelstandsforschung*, Berlin: Lit Verlag 2008, S.395-411]

Leuphana Universität Lüneburg
Institut für Volkswirtschaftslehre
Postfach 2440
D-21314 Lüneburg
Tel.: ++49 4131 677 2321
email: brodt@leuphana.de
www.leuphana.de/vwl/papers