

Verhoeven, Peter

Book

Management model for social and environmental impact in logistics through blockchain technologies

Schriftenreihe Logistik der Technischen Universität Berlin, No. 45

Provided in Cooperation with:

Universitätsverlag der TU Berlin, Technische Universität Berlin

Suggested Citation: Verhoeven, Peter (2022) : Management model for social and environmental impact in logistics through blockchain technologies, Schriftenreihe Logistik der Technischen Universität Berlin, No. 45, ISBN 978-3-7983-3251-5, Universitätsverlag der TU Berlin, Berlin, <https://doi.org/10.14279/depositonce-14806>

This Version is available at:

<https://hdl.handle.net/10419/280163>

Standard-Nutzungsbedingungen:

Die Dokumente auf EconStor dürfen zu eigenen wissenschaftlichen Zwecken und zum Privatgebrauch gespeichert und kopiert werden.

Sie dürfen die Dokumente nicht für öffentliche oder kommerzielle Zwecke vervielfältigen, öffentlich ausstellen, öffentlich zugänglich machen, vertreiben oder anderweitig nutzen.

Sofern die Verfasser die Dokumente unter Open-Content-Lizenzen (insbesondere CC-Lizenzen) zur Verfügung gestellt haben sollten, gelten abweichend von diesen Nutzungsbedingungen die in der dort genannten Lizenz gewährten Nutzungsrechte.

Terms of use:

Documents in EconStor may be saved and copied for your personal and scholarly purposes.

You are not to copy documents for public or commercial purposes, to exhibit the documents publicly, to make them publicly available on the internet, or to distribute or otherwise use the documents in public.

If the documents have been made available under an Open Content Licence (especially Creative Commons Licences), you may exercise further usage rights as specified in the indicated licence.



<https://creativecommons.org/licenses/by/4.0/>

Hrsg. Frank Straube, Helmut Baumgarten

Peter Verhoeven

Management model for social and environmental impact in logistics through blockchain technologies

Peter Verhoeven

**Management model for social and environmental impact in logistics through
blockchain technologies**

Die *Schriftenreihe Logistik der Technischen Universität Berlin* wird herausgegeben von:
Prof. Dr.-Ing. Frank Straube,
Prof. Dr.-Ing. Raimund Klinkner,
Prof. Dr.-Ing. Dr. rer. pol. h.c. Helmut Baumgarten

Peter Verhoeven

**Management model for social and environmental impact in logistics through
blockchain technologies**

Bibliographic information published by the Deutsche Nationalbibliothek

The Deutsche Nationalbibliothek lists this publication in the Deutsche Nationalbibliografie; detailed bibliographic data are available on the Internet at <http://dnb.dnb.de>.

Universitätsverlag der TU Berlin, 2022

<https://verlag.tu-berlin.de>

Fasanenstr. 88, 10623 Berlin

Tel.: +49 (0)30 314 76131 / Fax: -76133

E-Mail: publikationen@ub.tu-berlin.de

Zugl.: Berlin, Techn. Univ., Diss., 2021

Gutachter: Prof. Dr.-Ing. Frank Straube

Gutachter: Prof. Dr.-Ing. André Ludwig [Kühne Logistics University]

Die Arbeit wurde am 15. Dezember 2021 an der Fakultät VII unter Vorsitz

von Prof. Dr.-Ing. Rüdiger Zarnekow erfolgreich verteidigt.

Unless otherwise indicated, this work is licensed under a Creative Commons License Attribution 4.0 International.

This does not apply to quoted content and works based on other permissions. To view a copy of this license visit:

<https://creativecommons.org/licenses/by/4.0>

Print: docupoint GmbH

Layout/Typesetting: Peter Verhoeven

ORCID iD Peter Verhoeven: 0000-0001-8432-574X

<https://orcid.org/0000-0001-8432-574X>

ISBN 978-3-7983-3250-8 (print)

ISBN 978-3-7983-3251-5 (online)

ISSN 1865-3170 (print)

ISSN 2197-0564 (online)

Published online on the institutional Repository of the Technische Universität Berlin:

DOI 10.14279/depositonce-14806

<http://dx.doi.org/10.14279/depositonce-14806>

List of contents

List of contents	I
List of figures	IV
List of tables	VI
List of abbreviations	VIII
Abstract	IX
Kurzfassung	X
1 Introduction	1
1.1 Motivation and background	1
1.2 Research objective, approach and thesis outline	2
1.3 Delimitation of the thesis	6
1.4 Management theories in the context of technology adoption	8
2 Theoretical Background	13
2.1 International logistics networks.....	13
2.1.1 Tasks and objectives of logistics	13
2.1.2 Current trends and challenges in international logistics networks	14
2.2 Technological background of blockchain technologies	20
2.2.1 Definition and conceptual foundations of the technology	22
2.2.1.1 Technical functioning of blockchain technologies	22
2.2.1.2 Typology of blockchain technologies	26
2.2.1.3 Other architectures of distributed ledger technologies	28
2.2.2 Functionalities of blockchain technologies	31
2.3 Sustainability and logistics.....	33
2.3.1 Definition of sustainability	33
2.3.2 Dimensions of sustainability	34
2.3.3 Sustainability in the context of logistics	38
2.3.4 Sustainability and digitalization in logistics	48

3	Overview of the methodological approach.....	51
3.1	Systematic literature review.....	51
3.2	Workshops and group surveys	55
3.3	Case study exploration.....	60
4	Development of the management model for social and environmental impact in logistics through blockchain technologies.....	63
4.1	Conceptual design of the management model.....	63
4.2	Phase 1 and 2: mindful adoption and application areas of blockchain technologies in logistics	67
4.2.1	Application areas of blockchain technologies in logistics	67
4.2.2	Current challenges for the implementation of blockchain technologies..	74
4.2.3	Evaluation of application areas of blockchain technologies in logistics..	79
4.2.4	Applicability limitations of blockchain technologies in logistics.....	84
4.2.5	Mindful technology adoption of blockchain technologies in logistics	87
4.2.6	Interim conclusion on blockchain technologies in logistics.....	91
4.3	Phase 3: sustainability impact model for blockchain technologies in logistics.....	93
4.3.1	Stakeholders and sustainability impact dimensions of blockchain technologies in logistics.....	93
4.3.2	Development of the sustainability impact model for blockchain technologies in logistics.....	97
4.4	Phase 4: implementation of blockchain technologies in logistics	104
4.4.1	Case study description and analysis	104
4.4.1.1	Case study A: fair operations in the coffee industry.....	104
4.4.1.2	Case study B: ethical mineral supply in the automotive industry...	109
4.4.1.3	Case study C: digital and efficient load carrier exchange	114
4.4.2	Development of the management areas for the implementation.....	119
4.4.2.1	Management area I: strategy and goals	120
4.4.2.2	Management area II: internal organization	126

4.4.2.3	Management area III: external collaboration.....	130
4.4.2.4	Management area IV: technology.....	135
4.4.2.5	Management area V: implementation.....	141
4.4.2.6	Summary of management areas	145
4.5	Synthesis of the management model	147
4.6	Exemplary application of the management model to case study B	151
5	Vision of future logistics networks and the role of blockchain technologies	157
5.1	Blockchain technologies as a communication infrastructure	158
5.2	Structural changes in logistics through blockchain technologies.....	161
5.3	Blockchain technologies in interplay with other technologies.....	167
5.3.1	Blockchain technologies in interplay with the Internet of things	167
5.3.2	Blockchain technologies in interplay with artificial intelligence	168
5.3.3	Blockchain technologies in interplay with digital twins	171
6	Conclusion and outlook.....	173
6.1	Summary.....	173
6.2	Scientific contribution	180
6.3	Managerial contribution	182
6.4	Limitations of the thesis and future research	183
	Appendix.....	XI
	References.....	XII

List of figures

Figure 1: Thesis outline	5
Figure 2: Methodology and data of the thesis	6
Figure 3: Delimitations of the thesis	7
Figure 4: Interrelation of management theories and thesis	12
Figure 5: Customer order process	14
Figure 6: Digital signatures	23
Figure 7: Simplified mechanism for BCT	24
Figure 8: Structural differences between BCT and DAG	29
Figure 9: Triple bottom line	35
Figure 10: Relevant literature by year	54
Figure 11: Nominal group technique methodology	56
Figure 12: Conceptual design of the management model	65
Figure 13: Framework for application areas of BCT in logistics	67
Figure 14: Challenges for BCT implementations in logistics	74
Figure 15: Assessment of challenges for the implementation of BCT in logistics	78
Figure 16: Application area evaluation for tracking and tracing	79
Figure 17: Application area evaluation for financial operations	80
Figure 18: Application area evaluation for verification and certification	81
Figure 19: Application area evaluation for planning and network	82
Figure 20: Application area evaluation for automation and IoT	83
Figure 21: Mindful adoption model for BCT in logistics	89
Figure 22: Assumed network structure	94
Figure 23: Sustainability impact dimensions	96
Figure 24: Sustainability impact model for BCT in logistics	98
Figure 25: Logistics network for coffee in case study A	106
Figure 26: Logistics network for minerals in case study B	110

Figure 27: Protocol design for case study B	113
Figure 28: Exemplary logistics network in case study C	115
Figure 29: Project phases in case study C.....	117
Figure 30: Overview of management areas	119
Figure 31: Management area I: strategy	120
Figure 32: KANO model	124
Figure 33: Management area II: internal organization.....	126
Figure 34: Kotter´s 8-step process for leading change.....	127
Figure 35: Management area III: external collaboration	130
Figure 36: Balanced scorecard.....	133
Figure 37: Management area IV: technology	135
Figure 38: Technology attractiveness and resource power	137
Figure 39: Technology-portfolio analysis	138
Figure 40: Scenario analysis	138
Figure 41: Management area V: implementation	141
Figure 42: Implementation approach for BCT systems	145
Figure 43: Management model for social and environmental impact in logistics through BCT.....	148
Figure 44: Observation levels of the vision of future logistics networks.....	157
Figure 45: Evaluation framework for the structural changes in logistics through BCT.....	161

List of tables

Table 1: Relevant theories.....	9
Table 2: Logistics trends in literature	15
Table 3: Megatrends in logistics	16
Table 4: Typology of BCT.....	27
Table 5: BCT platforms for creating BCT applications	28
Table 6: Comparison of BCT and DAG.....	30
Table 7: Functionalities of BCT	33
Table 8: Sustainable Development Goals (SDG).....	37
Table 9: Definitions of sustainable logistics management.....	39
Table 10: Stakeholder groups and requirements	41
Table 11: Goals of sustainable corporate development	41
Table 12: Comparison of standards and accounting levels	43
Table 13: Overview of social sustainability reporting standards	45
Table 14: Extracted core criteria from social and environmental standards	47
Table 15: Excerpt of impacts of digitalization in logistics on sustainability	49
Table 16: SLR developed by Durach (2016).....	52
Table 17: Inclusion criteria.....	53
Table 18: Search string for SLR	53
Table 19: Sample demographics of the first workshop	55
Table 20: Items for application area evaluation	57
Table 21: Sample demographics of the second workshop.....	58
Table 22: Use case overview.....	59
Table 23: Selection criteria for the case studies	60
Table 24: Sample demographics of the case study interviewees.....	61
Table 25: Four phases of the management model.....	66
Table 26: Overview of application areas of BCT in logistics	68

Table 27: Mindful adoption principles	90
Table 28: Identified stakeholders	95
Table 29: Sustainability impact for manufacturers	99
Table 30: Sustainability impact for suppliers	101
Table 31: Sustainability impact for customers	102
Table 32: Sustainability impact for LSP	103
Table 33: Sustainability impact for governments and society	103
Table 34: SWOT analysis for BCT in logistics	123
Table 35: Strategies for managing stakeholders based on organizational positions .	132
Table 36: Twelve principles behind the agile manifesto	142
Table 37: Expected changes on the communication level	160
Table 38: Expected changes on the strategical level	163
Table 39: Expected changes on the tactical level	165
Table 40: Expected changes on the operational level.....	166
Table 41: Benefits of using BCT for IoT	168
Table 42: Integration of AI and BCT	169
Table 43: Benefits of using BCT for digital twins.....	172
Table 44: Questions for case study expert interviews	XI

List of abbreviations

AI	Artificial intelligence
BCT	Blockchain technologies
CSR	Corporate social responsibility
DAG	Directed acyclic graph
DLT	Distributed ledger technologies
DoS	Denial of service
ECX	Ethiopian Commodity Exchange
EDP	Electronic data processing
ETH	Ether
EU	European Union
GDPR	General Data Protection Regulation
GHG	Greenhouse Gas Protocol
ILO	International Labor Organization
IoT	Internet of things
KPI	Key performance indicator
LSP	Logistics service provider
LTC	Litecoin
M2M	Machine-to-machine
NGO	Non-governmental organization
OECD	Organization for Economic Cooperation and Development
OEM	Original equipment manufacturer
P2P	Peer-to-peer
POS	Proof of stake
POW	Proof of work
SA	Social accountability
SAI	Social Accountability International
SDG	Sustainable Development Goals
SME	Small and medium-sized enterprises
SLR	Systematic literature review
TBL	Triple bottom line
TEU	Twenty-foot equivalent unit

Abstract

In the context of the advancing digitalization of logistics processes, blockchain technologies are gaining in importance. Within the scope of sustainable logistics networks, they contribute to cross-stakeholder transparency and support the tracking and verification of products and processes to improve social and environmental parameters. The goal of this work is to develop a holistic management model to help users understand blockchain technologies in the context of their logistics network and to assess the mindful adoption of these technologies to specific problems. In addition, the model should enable the conclusion of expected impacts on participating actors within the logistics network with regard to social and environmental sustainability and, in a further step, provide a holistic approach to the implementation of blockchain technologies. Methodologically, a systematic literature analysis, two workshops and a case study exploration will be conducted for this purpose. Within the systematic literature analysis, 285 articles are evaluated and 53 relevant articles are synthesized. Based on the Nominal Group Technique, a first workshop with 30 experts from manufacturing companies, logistics service providers, technology companies and universities will be conducted and supplemented by a subsequent survey. In a second workshop, three use cases of blockchain technologies are analyzed with 24 experts in open and moderated group discussions. Finally, three exemplary case studies and eight expert interviews are conducted and systematically evaluated with respect to cross-case findings. The result of this thesis is a four-phase management model that guides users through the process of evaluating and implementing blockchain technologies in the context of sustainable logistics. While the first phase assesses requirements of the logistics network for general applicability of blockchain technologies, the second phase includes a model for the mindful adoption of blockchain technologies. Based on this, phase three provides a sustainability impact model to explain social and environmental impacts of individual actors involved in the logistics network. The fourth phase ultimately represents the implementation of blockchain technologies in logistics and is based on five management areas in which specific design recommendations, methods and tools are provided to enable a successful implementation. Finally, the thesis provides an outlook on a future vision and shows which changes in logistics networks can be expected due to blockchain technologies.

Kurzfassung

Im Rahmen der voranschreitenden Digitalisierung von Logistikprozessen gewinnen Blockchain-Technologien zunehmend an Bedeutung. Sie leisten im Kontext nachhaltiger Logistiknetzwerke einen Beitrag zur akteursübergreifenden Transparenz und unterstützen die Nachverfolgung und Verifizierung von Produkten und Prozessen zur Verbesserung sozialer und ökologischer Parameter. Ziel dieser Arbeit ist es, ein ganzheitliches Management Modell zu entwickeln, das Anwender dabei unterstützt, Blockchain-Technologien im Kontext ihres Logistiknetzwerks zu verstehen und die achtsame Anwendbarkeit dieser Technologien für spezifische Problemstellungen zu prüfen. Zudem soll das Modell eine Ableitung der zu erwartenden Effekte auf beteiligte Akteure innerhalb des Logistiknetzwerkes hinsichtlich der sozialen und ökologischen Nachhaltigkeit ermöglichen und in einem weiteren Schritt einen ganzheitlichen Ansatz zur Implementierung von Blockchain-Technologien bereitstellen. Methodisch werden dafür eine systematische Literaturanalyse, zwei Workshops sowie eine Fallstudienuntersuchung durchgeführt. Im Rahmen der systematischen Literaturanalyse werden 285 Artikel ausgewertet und 53 relevante Artikel synthetisiert. Basierend auf der Nominal Group Technique wird ein erster Workshop mit 30 Experten von Fertigungsunternehmen, Logistikdienstleistern, Technologieunternehmen und Hochschulen durchgeführt und durch eine anschließende Befragung ergänzt. Im Rahmen eines zweiten Workshops werden drei Anwendungsfälle von Blockchain-Technologien mit 24 Experten in offenen und moderierten Gruppendiskussionen analysiert. Abschließend werden drei exemplarische Fallstudien sowie acht Experteninterviews durchgeführt und systematisch hinsichtlich fall-übergreifender Erkenntnisse ausgewertet. Das Ergebnis dieser Arbeit ist ein vierphasiges Management Modell, dass den Anwender durch den Prozess der Bewertung und Implementierung von Blockchain-Technologien im Kontext nachhaltiger Logistik führt. Während in der ersten Phase Anforderungen des Logistiknetzwerks auf generelle Eignung für Blockchain-Technologien geprüft werden, umfasst die zweite Phase ein Modell für die achtsame Adoption. Darauf aufbauend wird in Phase drei ein Modell zur Erklärung sozialer und ökologischer Effekte einzelner beteiligter Akteure des Logistiknetzwerks bereitgestellt. Die vierte Phase repräsentiert letztlich die Implementierung von Blockchain-Technologien in der Logistik und basiert auf fünf Managementbereichen, in denen gezielt Handlungsempfehlungen, Methoden und Werkzeuge bereitgestellt werden, um eine erfolgreiche Umsetzung zu ermöglichen. Abschließend gibt die Arbeit einen Ausblick auf eine zukünftige Vision und zeigt auf, welche Veränderungen in Logistiknetzwerken durch Blockchain-Technologien zu erwarten sind.

1 Introduction

This introduction chapter deals with the motivation and approach, the theoretical background and the thesis outline, the corresponding delimitation of this dissertation with the title “Management model for social and environmental impact in logistics through blockchain technologies” as well as the theoretical classification and management theory contribution of this thesis.

1.1 Motivation and background

Current initiatives in the field of logistics are shaped by the digitalization and automation of business processes. They are characterized by a consistent alignment of processes to customer requirements and an improvement in environmental and social sustainability. As the complexity of international logistics networks increases, companies are facing new challenges in terms of their ability to integrate, cooperate and communicate. End-to-end transparency from the raw material supplier to the end customer is one of the key challenges here, whereby the necessary data availability and integration have to be ensured. As one of logistics recent topics in the last years, blockchain technologies (BCT) gained interest in research and practice. BCT offer a variety of benefits that stem from one of the technology’s basic principles: decentralization, which is enabling a set of advantages¹. While BCT promise significant impact on and enormous potential for logistics, the anticipated benefits have yet to materialize. Despite the large number of possible applications, companies currently face the challenge of deriving potential for themselves and advancing concrete implementations. In recent years, the development of use cases and the adoption of BCT have been driven by overly positive reporting about the theoretical potentials and the hype of technology instead of a justified evaluation with practical business value in mind². Providing increased efficiency, transparency and enabling integration throughout networks, BCT are expected to have far-reaching implications for international logistics networks³. While the financial sector is leading the development of use cases and business models⁴ for BCT, many other fields are catching up. Promising industries include transportation and shipping, logistics management, healthcare, manufacturing, public transport, resource sharing and energy⁵. In the context of logistics, BCT have attracted attention for quite some time. With an accelerated interest in the last years, the technology is one of the main trends to transform logistics networks next to artificial intelligence

¹ Cf. Sharma (2018).

² Cf. Verhoeven et al. (2018) p. 1.

³ Cf. World Economic Forum (2019).

⁴ Cf. Beck et al. (2017) p. 381.

⁵ Cf. Beck et al. (2017) p. 381; Underwood (2016) p. 16.

and the Internet of things.⁶ While BCT can help to increase end-to-end transparency along global networks and to provide tamper-proof data, this not only leads to greater security and efficiency, but also opens up new ways of designing sustainable logistics networks in terms of social or environmental aspects. The possibilities and application scenarios are manifold and range from improving working conditions at suppliers, fighting corruption in developing countries to new ways of decentral planning to avoid non-essential trips in order to save CO2 emissions.⁷ In this respect, sustainability is one of the currently prominent areas of science in relation to BCT and should be elaborated further in research and practice.⁸ It can furthermore be assumed that BCT have the potential to improve the sustainability performance of logistics network in the future.⁹ This thesis aims to examine how BCT can contribute to more sustainable logistics networks with regard to social and environmental sustainability. It will explain the direct and indirect social and environmental impact BCT can have on stakeholders in logistics networks and how they can be adopted and implemented mindfully to create more transparent and sustainable logistics networks.

1.2 Research objective, approach and thesis outline

In the context of the theoretical background of the dissertation it is first examined which trends are currently impacting international logistics networks, which functionalities BCT provide and how digitization can influence sustainability in logistics. Drawing on this theoretical understanding, the main part of the thesis is to develop a management model for social and environmental impact in logistics through BCT. Therefore, in a first step, the state of development and application of BCT in logistics networks, the challenges that need to be overcome for a successful deployment as well as the mindful adoption of BCT is considered. Mindfulness in this context means basing decisions on the use of technology on the specific problem and weighing up organizational and process requirements as well as technological functionalities in terms of their task-technology fit, which is especially important in the case of BCT. Subsequently, implications from a sustainability perspective for the individual actors of international logistics networks are examined and to what extent they are impacted by BCT. The final step for the model is the development of an implementation approach including management areas and design recommendations for logistics. These results climax in the envisaged management model, which enables companies to understand and use BCT to create socially and environmentally more sustainable logistics networks. Ultimately, it is

⁶ Cf. Pettey (2019).

⁷ Cf. Upadhyaya et al. (2021) pp. 1–7.

⁸ Cf. Moosavi et al. (2021) pp. 8–13; Rejeb et al. (2021) p. 17.

⁹ Cf. Park/Li (2021) p. 1.

elaborated how BCT integrate into the vision of future logistics networks and what changes could result. Therefore, the following research questions will be answered in this thesis:

- I. *What are current trends and challenges in international logistics networks? How important is environmental and social sustainability in the context of logistics? How can digitalization impact environmental and social sustainability?*
- II. *What are functionalities and architectures of BCT?*
- III. *How does a management model for social and environmental impact in logistics through BCT look like?*
 - a. *What is the status quo of BCT in logistics in research and practice? What are challenges and relevant application areas of BCT and how can a mindful adoption of BCT be ensured?*
 - b. *What is the social and environmental impact of BCT for stakeholders of logistics networks?*
 - c. *How can BCT be implemented in logistics networks? What are management areas and design recommendations?*
- IV. *How do BCT integrate into the vision of future logistics networks?*

To answer the research questions above, this thesis is structured in six chapters. This results in the thesis outline as shown in Figure 1. In *chapter 1*, the motivation of the thesis is explained and its relevance from both a practical and a scientific-theoretical point of view is presented. The objectives of the thesis, the research questions to be answered and the research design as well as delimitations of the thesis are likewise described. Furthermore, the chapter focusses on management theories and their relationship to the research within this thesis as these theories explain certain actions and decisions when dealing with BCT and furthermore fundamental assumptions of individual theories can be shifted by these technologies. Following this, *chapter 2* introduces the reader into the theoretical background of the thesis. This includes fundamentals of international logistics and sustainability as understood in the framework of this thesis as well as the technological introduction to BCT. By answering research question I, current trends and challenges in international logistics networks are identified and the importance of sustainability in the context of logistics as well as the impact of digitalization on sustainability is examined. Furthermore, research question II will be answered in this chapter by elaborating functionalities and different architectures of BCT based on a literature research. Thus, a basic understanding is provided of the technologies that are the subject of research for the further thesis. Following this theoretical foundation, *chapter 3* outlines the methodological approach of the empirical research. Therefore, the research methods systematic literature review, workshops, group surveys as well as case study exploration are described in detail as conducted within this thesis. Main part of the thesis is

chapter 4 which deals with research question III and therefore with the development of the management model, which consists of four phases. Research question IIIa will be answered in *chapter 4.2* by conducting a systematic literature review with a description of the status quo and a framework of application areas of BCT in logistics as a result. The systematic literature review is based on 53 relevant publication and the results are further analyzed by using Q-methodology. Furthermore, to answer research question IIIa, relevant application areas and implementation challenges are discussed and evaluated in *chapter 4.2* utilizing a nominal group technique workshop with 30 professionals as well as a group survey among the participants. Another key element of this chapter is the discussion of applicability limitations as well as the mindful adoption of BCT in logistics. To approach and answer research question IIIb, in *chapter 4.3* a second (online) workshop with 24 professionals, based on the first, is utilized to determine the social and environmental impact of BCT in different international logistics networks by discussing three exemplary case studies. The results are utilized to develop the sustainability impact model for BCT in logistics. To answer research question IIIc in *chapter 4.4*, three case studies including eight expert interviews are conducted in order to develop the implementation approach of the envisaged management model for social and environmental impact in logistics through BCT and to validate the model with regard to its suitability and applicability. The results are then summarized in the final management model in *chapter 4.5* and an exemplary application of the model is given in *chapter 4.6*. The management model is developed to be a guiding instrument for managers seeking to explore the potentials of BCT in logistics. The reader is therefore lead through four phases that contain descriptive, explanatory as well as design elements. By applying the management model, managers can understand how BCT works and whether it is applicable for their situation. Furthermore, it can be deduced how different stakeholders of the logistics network will be impacted by a decentralization process through BCT with regard to sustainability. Eventually, the model enables companies to carry out a successful implementation by providing necessary management tools and instruments and discussing success factors of individual management areas. Ultimately, *chapter 5* outlines a vision of future logistics networks and discusses to what extent BCT as examined in this thesis fit into this vision and how they shape future logistics networks. The methodological approach in this chapter is conceptual and incorporates previous results of the work, which are additionally enriched with insights from literature and practice. The thesis ends with *chapter 6*, which summarizes the results of the work, critically reflects the procedure in terms of content and methodology and derives further research needs.

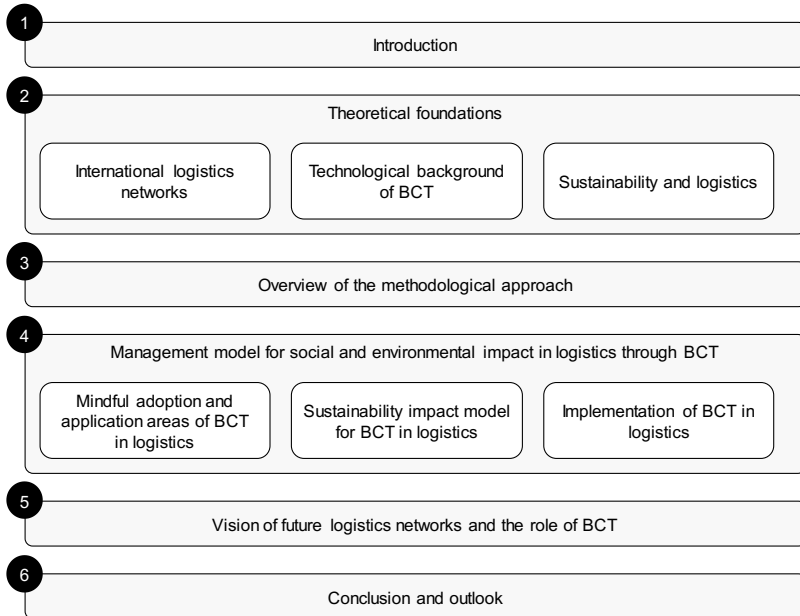

Figure 1: Thesis outline¹⁰

Therefore, the four main building blocks and research objectives of this thesis as shown in Figure 1 are:

- mindful adoption and application areas of BCT in logistics
- sustainability impact model for BCT in logistics
- management model for social and environmental impact in logistics through BCT
- vision of future logistics networks and the role of BCT.

A summary of the building blocks of the thesis and the methodologies as described above is shown in Figure 2.

¹⁰ Own representation

Research objectives	Methodology	Data
Mindful adoption and application areas of BCT in logistics	Systematic literature review, Q-methodology, nominal group technique workshop, survey	53 relevant articles, 1 workshop with 30 practitioners
Sustainability impact model for BCT	Online-workshop	1 workshop on 3 case studies with 24 practitioners
Management model for social and environmental impact through BCT	Case studies, expert interviews	3 case studies including 8 expert interviews and 1 validation interview
Vision of future logistics networks and the role of BCT	Conceptual	Incorporating previous results of the thesis and new insights from literature and practice

Figure 2: Methodology and data of the thesis¹¹

1.3 Delimitation of the thesis

In the following the delimitations of the thesis are explained and thus the object of investigation is defined in more detail. The first delimitation is the level of analysis, which, within this thesis, is the network since BCT always deal with topics that require a consideration on the network level. Therefore, the entire network from raw material supplier to customer is the object of investigation of this thesis with respect to the stakeholder dimensions. This in turn requires a consideration of all actors in the international logistics network. Another delimitation can be drawn based on the triple bottom line and the three dimensions of sustainability - social, environmental and economic sustainability. The research of this thesis will primarily focus on the environmental and social dimensions. However, the economic dimension can only be excluded to a limited extent in the corporate context and is therefore included as a subordinate level of consideration. From a technology perspective, it can be differentiated between the two architectures blockchain and directed acyclic graphs (DAG) within the technological scope of the of technology family distributed ledger technologies (DLT). However, since both architectures have highly promising applications, which differ mainly in the economic dimension, but not in the social or environmental dimension, this thesis does not exclude one of the two sub-areas. However, the focus is on blockchain due to the further development status and occurrence in research and practice. As explained further in chapter 2.2, in the remainder of the thesis, it will be assumed that the relevant properties of these technologies

¹¹ Own representation

differ only in the details and *BCT* will be used in this thesis accordingly as an overarching term. The envisaged management model and the further results of the thesis will continue to support the strategic orientation of companies and international logistics networks towards socially and environmentally sustainable processes and networks. Therefore, the scope of this thesis is highly strategic and operational or tactical aspects are delimited from the focus of the research. Ultimately, the last delimitation concerns the target audience. The most important target group of the thesis are companies, which represent the primary focus of the research, but the results can also be applied by secondary focus target groups such as governments, NGO and other associations, which can use the research insights to support the transformation of future sustainable logistics networks via *BCT*. Figure 3 summarizes the delimitations of the thesis.

Within logistics, no sector boundaries are drawn that would result in the exclusion of individual companies. Likewise, the size of the company is not an exclusion criterion for the initial consideration.

Category	Delimitations				
Level of analysis	Function	Company	Dyad	Chain	Network
Stakeholders	Raw material supplier	Manufacturer	Retailer	LSP	Others
Sustainability dimensions	Environmental sustainability		Social sustainability		Economical sustainability
Technology focus	DAG			Blockchain	
Management level	Operational		Tactical		Strategical
Target audience	Companies	Government	NGO	Associations	Other
Legend					
Primary Focus		Secondary Focus	No Focus		

Figure 3: Delimitations of the thesis¹²

The scope of the results of this thesis thus has a clear tailoring and focuses on sub-areas while others are excluded. The delimitations provide the framework, while further limitations of the work result from the research design. The results of chapters 2 to 4.2 are initially generally valid in the context of *BCT* and logistics and are based on broad, cross-industry studies (literature research, systematic literature review, workshop and questionnaire). In the course of the thesis, the scope is then tailored based on the delimitations described above. In

¹² Own representation

particular, the sustainability impact model in chapter 4.3, the implementation approach in chapter 4.4 and the management model in chapter 4.5 are based on industry-specific workshops and case studies. From a sustainability point of view, the thesis is limited to the social and environmental dimension as described above, which is why economic aspects are only considered peripherally, and a detailed analysis of the cost structure for the development of systems based on BCT in logistics is not part of this thesis.

1.4 Management theories in the context of technology adoption

In this thesis, the application of BCT in the context of logistics to achieve sustainability impacts is investigated. Thus, two interdisciplinary fields of research are brought together and the thesis is located at the intersection of economics science and engineering science. This chapter will give an overview of the relevant management theories as the management-theoretical frame of reference and their relationship to the research within this thesis. Table 1 shows the theories of the theoretical frame of reference that guide the research:

- transaction cost theory
- principal-agent theory
- network theory
- task–technology fit and mindful innovation.

It is explained why these theories are important in the context of the thesis and what contribution they make in the context of the latter. Therefore, these theories are first briefly described before their contribution and implications for the thesis and its building blocks is explained, which justifies the selection of these theories.

Theory	Short description
Transaction cost theory	The transaction cost theory assumes that the decision for the most efficient organizational frameworks is based on production and transaction costs (ex ante costs for search and information and ex post costs for monitoring and adjustment). ¹³
Principal-agent theory	The principal-agent theory describes problems that exist between the principal and his agent due to information asymmetry leading to agency cost due to monitoring, supervising and controlling activities of the principal to ensure the desired behavior of the agent. ¹⁴
Network theory	The network theory explains that a company's corporate performance depends on their efficient cooperation with direct and indirect network partners as an important factor in the development of new resources, since relationships can combine the resources of both partners and achieve greater benefits together than by each acting alone. ¹⁵
Task–technology fit and mindful innovation	The task-technology fit states that the fit between technology and task characteristics is important for a positive performance impact of a newly implemented technology and thus serves as a diagnostic instrument to evaluate whether implemented technologies fulfill user requirements. ¹⁶ The theory of mindful innovation enables companies to base their IT innovations on their own organizational facts and specifics and to avoid bandwagon effects. This enables a justified decision for adoption or non-adoption. ¹⁷

Table 1: Relevant theories¹⁸

¹³ Cf. Coase (1937) pp. 386–405; Treiblmaier (2018) p. 548.

¹⁴ Cf. Fayezi et al. (2012) pp. 556–570; Treiblmaier (2018) p. 548.

¹⁵ Cf. Halldorsson et al. (2007) p. 287; Treiblmaier (2018) p. 548.

¹⁶ Cf. Goodhue/Thompson (1995) p. 213.

¹⁷ Cf. Swanson/Ramiller (2004) pp. 553–577.

¹⁸ Own representation

The theories presented above all interact with BCT and play an important role in the theoretical framework of this thesis. Firstly, the theories explain certain actions and decisions when dealing with these new technologies. Furthermore, BCT can shift fundamental assumptions of individual theories.

From the interaction of the five management theories presented above, the following implications for the thesis can be derived.

- 1) Organizational form and governance mechanisms of a logistics network follow from the most efficient inter- and intra-organizational solution with lowest transaction costs.
- 2) Information asymmetry leads to agency monitoring, supervising and controlling activities and corresponding costs and needs to be minimized.
- 3) Performance and technology utilization of a company depend on the cooperation with direct and indirect network partners to achieve efficiency gains.
- 4) Logistics performance is indirectly influenced by the degree to which technology and task characteristics are aligned with each other
- 5) Mindfulness and the critical analysis of the validity of the innovation's benefits in the local context of their environment are the fundament for successful innovation in logistics networks.

Thus, the selected management theories form the theoretical basis for the building blocks of this thesis. The building blocks result from the previously defined research questions and include:

- mindful adoption and application areas of BCT in logistics
- sustainability impact model for BCT in logistics
- management model for social and environmental impact in logistics through BCT
- vision of future logistics networks and the role of BCT.

The theory of mindful innovation is cross-block guiding for all areas of the thesis. A well-thought-out application of technologies based on analyses of local conditions is necessary not only for the identification of application areas but also for the explanation and design of BCT in logistics (sustainability impact model and management model) as well as for the definition of the vision of the future of logistics networks. The task-technology fit theory describes the importance of aligning the requirements of the processes with the functionalities of the technology when identifying and evaluating application areas for BCT in logistics. It is shown that BCT has inherent unique functionalities that offer potential for more efficient logistics processes. However, the limitations of these functionalities should not be neglected. Matching the characteristics of these functionalities with those of the processes to be optimized is a central element of the task-technology fit and thus contributes to a better understanding of the

opportunities and strengths of the technology. The principal-agent theory contributes to both the application areas and the sustainability impact model by describing the relationships between the various actors of the logistics network and how information asymmetry can be resolved to create trust within the network. Especially to create socially and environmentally focused impacts it will be of great importance to create transparency decentrally in order to resolve information barriers between stakeholders and to achieve overarching benefits. Taking a closer look at the network theory it is the management theoretical basis for both models to be developed during this thesis. Stating that individual performance of a company depends on the cooperation with direct and indirect network partners to achieve efficiency gains, it is especially important when developing systems based on BCT, which are fundamentally changing the way network partners might communicate and interact. The benefits defined in the sustainability impact model at stakeholder level, which explain the social and environmental impact, are always based on the assumption that BCT projects are approached and implemented in the network. An implementation of these technologies at the company level is not very promising. Accordingly, the network theory also forms the decisive basis for the final management model and describes that the success of the BCT system for individual companies depends on the cooperation and collaboration of the entire logistics network. Finally, the transaction cost theory explains the economic view of the management model. Thus, the orientation of BCT systems and the resulting organizational forms and governance mechanisms of the logistics network result from the most efficient inter- and intra-organizational structure. Therefore, it is necessary to take production and transaction costs into account as the comparison between central and decentralized solutions is an important. Transactions costs in this sense include costs for transactions, information gathering, coordination and decision making. A further consideration on how those transaction cost might alter or be shifted is done when defining the vision of future logistics networks and the role of BCT. A visualization of the discussed relationships between the management theories presented and the building blocks of this thesis is shown in Figure 4.

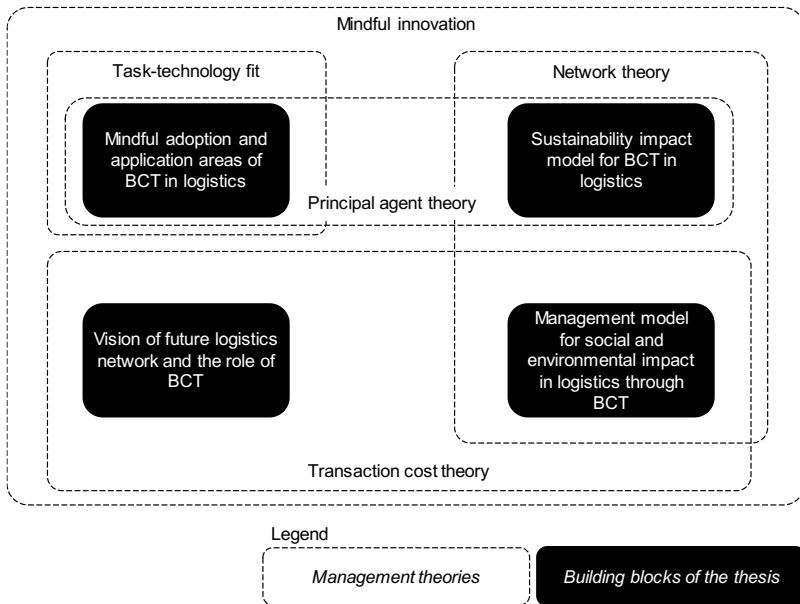

Figure 4: Interrelation of management theories and thesis¹⁹

¹⁹ Own representation

2 Theoretical Background

This chapter provides the theoretical foundations of the thesis. First, chapter 2.1 describes the tasks and objectives of logistics and identifies and explains current trends in logistics. In chapter 2.2 the technological basics of BCT are elaborated. This includes the basic technical principle, a typology, an overview of different architectures as well as the identification of functionalities. Finally, chapter 2.3 describes the importance of sustainability for logistics and the significance of digitization for sustainability.

2.1 International logistics networks

The following explanations on logistics and international logistics networks specifically serve as a definitional framework for the present thesis. First of all, the understanding of logistics in this thesis is examined in more detail and the corresponding tasks and objectives are considered. The second step focuses trends in trends logistics before examining the specific challenges of international logistics networks and how they relate to BCT.

2.1.1 Tasks and objectives of logistics

In the following section, the comprehension of logistics in the sense of this thesis will be explained first. This is followed by the corresponding tasks and objectives of this interdisciplinary field of research.

Developed since the 1950s as an independent research discipline, logistics has changed constantly over the decades. Starting with the optimization of material and goods flow-oriented processes (transport, handling, storage), it was eventually established as a cross-functional discipline, thus linking company divisions across departments and aligning all processes to the customer. Starting in the 1990s, logistics as a management function increasingly took on coordination tasks along the entire value chain across company boundaries. A holistic and flow-oriented view of processes, accelerated by simplified handling and coordination of processes through EDP, was introduced²⁰.

In the context of this thesis logistics is understood according to the definitions of Baumgarten and Straube. Baumgarten (2004) defines it as the holistic planning, management, execution and control of all internal and external flows of goods and information. Logistics thus provides customer- and process-oriented solutions for complete and subsystems in companies,

²⁰ Cf. Straube (2004) pp. 28–29.

corporations, networks and virtual enterprises.²¹ Straube (2004) further adds that logistics encompasses all phases of business and service processes of companies and thus fulfils its role as a service function, which brings isolated views of company functions into an integrative, cross-company context and generates logistically optimal overall solutions²². Accordingly, logistics is an instrument for strategic and operative corporate management, which enables the handling of the continuously growing complexity caused by rising customer requirements, increasing dynamics and volatility as well as interconnectivity through digitalization and processes within logistics networks. Figure 5 shows the customer order process as defined by Straube as the core construct of logistics. Therefore, all process within the logistics network are aligned to the customer. The development process is the first step, followed by the necessary supply processes such as demand planning and purchasing. The main customer order process deals with order processing from production planning through production and distribution to after-sales services. In addition, a disposal process downstream of utilization ensures that materials are returned to the production process.

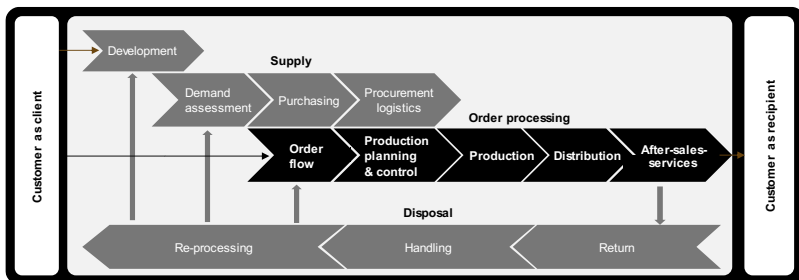

Figure 5: Customer order process²³

2.1.2 Current trends and challenges in international logistics networks

Logistics is an essential factor in business relationships and, as a cross-sectional function, exposed to a variety of trends. These can originate from the economy itself or from the basic social structure and influence the development of logistics and impose new requirements on future logistics networks. It is essential to recognize these developments in order to be able to act accordingly and to adapt processes continuously and holistically. The aim of this chapter is to provide a structured overview of trends in logistics and their descriptions and interrelationships. A number of trends can be found in the literature in this regard, some of

²¹ Cf. Baumgarten (2004) p. 2.

²² Cf. Straube (2004) p. 1.

²³ Cf. Straube (2004) p. 6.

which overlap and complement each other. Table 2 shows the main trends in logistics that have been identified.²⁴

Authors	Year	Trends
Straube and Cetinkaya ²⁵	2009	<ul style="list-style-type: none"> • Globalization • Security • Compliance/ regulations • Social responsibility • Sustainability • Technology innovations • Demographic change
Fontius ²⁶	2013	<ul style="list-style-type: none"> • Globalization • Innovation • Demand behavior • Sustainability
Lehmacher ²⁷	2015	<ul style="list-style-type: none"> • Digitalization • E-commerce • Climate change • Mobile world • Security • Urbanization
Rodenhäuser and Rauch ²⁸	2015	<ul style="list-style-type: none"> • Globalization • Individualization • Connectivity • Mobility • Neo-Ecology
Kersten et al. ²⁹	2017	<ul style="list-style-type: none"> • Automation • Business analytics • Decentralization • Digitalization • Individualization • Complexity • Cost Pressure • Customer behavior • Demand volatility • Sustainability • Risks und interruptions • Transparency • Networking and Collaboration • Compliance and legal requirements
Junge et al. ³⁰	2019	<ul style="list-style-type: none"> • Technologies and platforms • Data-driven services • New organization forms • Open Innovation

Table 2: Logistics trends in literature³¹

It emerges that many of the trends mentioned in the papers overlap in terms of content or are synonymous terms for developments of the same direction or appear on different levels and

²⁴ Cf. Straube/Cetinkaya (2009) p. 135.

²⁵ Cf. Straube/Cetinkaya (2009) p. 136.

²⁶ Cf. Fontius (2013) p. 26.

²⁷ Cf. Lehmacher (2015) pp. 9–15.

²⁸ Cf. Rodenhäuser/Rauch (2015) pp. 4–5.

²⁹ Cf. Kersten et al. (2017) pp. 14–17.

³⁰ Cf. Junge et al. (2019) pp. 35–45.

³¹ Own representation

therefore be seen as subordinate aspects or concomitants of overarching megatrends. In order to bring the results together, trend categories are formed in the next step, to which the individual trends are assigned according to their impact on international logistics networks. Therefore, seven megatrends dominate international logistics, which are illustrated in Table 3 and explained in detail below.

International megatrends	Sub-trends
Sustainability	Sustainability, neo-ecology, climate change, environmental and resource protection, social responsibility
Digitalization	Digitalization, business analytics, e-commerce, mobile world, innovation, technology innovations, technologies and platforms, new organization forms, automation
Connectivity and transparency	Transparency, networking, collaboration, connectivity, open innovation
Decentralization	Decentralization
Resilience	Security, risks, interruptions, compliance and legal requirements
Globalization	Globalization, complexity, cost pressure
Customer orientation	Customer behavior, individualization, demand behavior, demand volatility, data-driven services

Table 3: Megatrends in logistics³²

The importance of *sustainability* is increasing in all stakeholder groups. Environmentally and socially sound products are becoming increasingly important for customers and society as well as for companies themselves. Sustainability can therefore be a key driver of change in existing logistics networks. Many customers attach importance to environmental awareness and sustainable consumption and adapt their purchasing decisions and use of services accordingly. In addition to the environmental orientation of consumer behavior, the primary drivers of the sustainability trend are tighter global regulations, the worldwide scarcity of resources, louder social demands for ethical and sustainable corporate behavior, and the intrinsic quest for improved network efficiency. A change in the significance of sustainability in the corporate context can therefore be observed. For many years, little importance was attached to sustainability and a conflict of objectives between economic and social or

³² Own representation

environmental goals was assumed within logistics. Due to the external influences of customers and society described above, as well as the reinforcement by legal regulations, sustainable action in the corporate context is becoming increasingly important. Thus, from an economic perspective, innovative sustainable processes are often not only more efficient, but they can above all be used as a competitive differentiating factor to attract and retain customers. From a social perspective, compliance with standards and human rights is becoming increasingly important in order to be able to ensure good working conditions in the own logistics network. The environmental perspective is primarily devoted to the efficient use of resources or the creation of closed cycles. Transparency is of central importance here and requires cooperation at all levels and, if possible, the use of innovative solutions.³³ The social and environmental dimensions of sustainability will be of central importance in the further course of the thesis. A separate chapter will be devoted to the topic of sustainability in the further course of the thesis in chapter 2.3, in order to go into detail on the content, goals and influence on logistics.

Digitalization encompasses topics such as technology innovation and new forms of collaboration. It is a key driver of the transformation towards industry 4.0 to be observed in logistics networks. In logistics, digitalization is the fundament of data exchange between all actors of the network and describes the evolution from classic supply networks to fully integrated end-to-end logistics processes involving all stakeholders of the network. As a part of this transformation process, the information flow and data processing systems as well as algorithms are essential for digital business processes. Important features of the development are also the application of technology innovations such as artificial intelligence, cloud computing, BCT, robotics and the Internet of things (IoT). This results in more efficient, flexible and cost-optimized value networks that can adapt more quickly to changing market and competitive conditions. In addition, it seems likely that a large proportion of logistics services will be offered digitally via platforms in the future and that automation and cognitive intelligence technologies will be responsible for executing logistics processes at the tactical level. New organizational forms such as swarm organization and entrepreneurial freedom are just as much a part of digitized companies as open innovation.³⁴

Parallel to digitalization, a central trend is the *connectivity and transparency* of processes and between players in the logistics network. Due to complex networks and the processes and interdependencies between the players within them, problems can often not be solved within one instance or level and collaboration is required. Networks with a high level of connectivity

³³ Cf. Fontius (2013) pp. 49–50; Kersten et al. (2017) pp. 16–34; Lehmacher (2015) pp. 10–11; Rodenhäuser/Rauch (2015) pp. 4–12; Straube/Cetinkaya (2009) pp. 136–137.

³⁴ Cf. Junge et al. (2019) pp. 35–45; Kersten et al. (2017) p. 17; Lehmacher (2015) pp. 12–13; Rodenhäuser/Rauch (2015) pp. 15–18; Siegmann et al. (2013) pp. 6–9.

across company boundaries can react flexibly to dynamic changes and thus maintain their competitive edge. On an informational level, the connection and evaluation of data is thus becoming increasingly important. This provides the basis for transparent processes and end-to-end integration.³⁵ This transparency and end-to-end integration is one of the main goals of a holistic logistics network. Driven by digitalization, new opportunities are emerging to enable this transparency in all areas. The exchange of data between the players involved (in real time) thus continues to represent high optimization potential.³⁶

The connectivity in the network described above leads to a high level of complexity both physically and in terms of information and, associated with this, to a high level of effort in terms of planning and control. One trend that offers potential solutions here is the *decentralization* of physical assets and data in logistics. With increasing complexity, decentralized processes can react more dynamically to changes and are thus in certain cases both more robust and more efficient than centrally controlled processes. For example, the failure of components can be compensated for and does not lead to the failure of the entire system. Decentralization also supports the idea of more autonomy and self-organization in the network if decentralized assets have intelligent cognitive decision-making mechanisms. A decentralized data structure can solve problems of data sovereignty and trust across all actors.³⁷

Logistics networks are continuously influenced by external factors beyond their control. These include risks, interruptions, compliance and legal requirements. However, companies can prepare themselves. Their ability to cope with these unpredictable factors is called *resilience*. Due to globally dispersed networks, the requirements are constantly increasing. International production and supply networks are increasingly susceptible to production downtimes or delivery delays due to the reasons mentioned above. High customer demands regarding reliability require a high degree of resilience. Resilient logistics networks can react flexibly to dynamics and risks in the network and thus avoid total failure.³⁸

For many years, *globalization* has been a major trend in logistics worldwide, thus intensifying the competitive environment presenting new challenges for the logistics industry in particular. On the one hand, companies are offered new production and sales markets, which is also reinforced by the elimination of trade barriers. However, there are also a large number of factors that increase complexity. These include long distances combined with a high number

³⁵ Cf. Heistermann et al. (2017) pp. 6–21; Kersten et al. (2017) pp. 17–33; Rodenhäuser/Rauch (2015) p. 4; Ruile (2019) pp. 154–155; Straube/Cetinkaya (2009) pp. 138–140.

³⁶ Cf. Kersten et al. (2017) p. 17.

³⁷ Cf. Delfmann et al. (2017) pp. 4–12; Kersten et al. (2017) p. 17; Rodenhäuser/Rauch (2015) pp. 17–34.

³⁸ Cf. Heistermann et al. (2017) p. 18; Kersten et al. (2017) p. 16; Lehmacher (2015) pp. 9–10; Straube/Cetinkaya (2009) pp. 137–138.

of exports or the more intense competitive environment, which can be more strongly established internationally than locally. Efficient international logistics structures are therefore the key to successful participation in global trade by companies and countries.³⁹

Another trend that logistics networks are encountering with increasing dynamism and complexity is changing *customer behavior*. The task of logistics is always to adapt to these customer requirements, which is an important driver for technology or process innovations. Increasing online ordering behavior or the desire for more sustainability and reliability or the individualization of products and services are core elements of dynamic customer requirements. Logistics processes are thus becoming more diversified and complex. In addition, expectations regarding the speed of logistics processes are also becoming ever higher, and in the consumer goods sector, delivery times of one day or even shorter are now a reality and often a prerequisite. It is therefore important to predict customer expectations and demand as accurately as possible in order to be able to act proactively. In close connection with the trend of digitalization, customer requirements are also changing with regard to the provision of data-driven services, which can be used to offer new services and increase customer satisfaction by improving service levels.⁴⁰

These trends influence logistics networks internationally and create a variety of challenges for the players involved. Since the focus of this thesis is on the sustainability of international logistics networks, some of the characteristics and challenges of these international networks will be discussed in the following. An in-depth overview of the future of logistics including the role of BCT will be given in the last chapter of this thesis.

Among others, many international logistics networks are characterized by a high degree of dynamics, which is mainly reflected in volatile (fluctuating) processes on the supply and demand side and interruption risks within the network. Due to a multitude of internal and external influencing factors, these fluctuations and risks in the logistics network must be managed efficiently and effectively in order to ensure the material, information and financial flows between the actors involved and to the customer. With increasing globalization and the associated internationalization of logistics networks, the degree of complexity and integration and also the number of actors within these networks is constantly increasing. This complexity imposes high demands on stakeholder cooperation. Communication and process-related coordination are of enormous importance in order to ensure a seamless process flow. These

³⁹ Cf. Ehm/Lachner (2019) p. 404; Fontius (2013) pp. 38–39; Göpfert (2019) p. 53; Göpfert/Seeßle (2019) p. 255; Göpfert/Wellbrock (2019) p. 505; Kersten et al. (2017) p. 16; Rodenhäuser/Rauch (2015) p. 4; Straube/Cetinkaya (2009) pp. 135–136.

⁴⁰ Cf. Fontius (2013) pp. 43–44; Junge et al. (2019) pp. 39–40; Kersten et al. (2017) p. 16; Rodenhäuser/Rauch (2015) pp. 5–44.

challenges are increasingly being addressed with digitalization, which, however, not only provides a solution, but also brings with it its own inherent challenges. Above all, topics such as data exchange, coordinated technologies and the willingness to cooperate in a more networked environment are key success factors in the digitalization of corporate and network processes. Creating transparency, especially end-to-end transparency, in logistics networks is one of the main challenges companies are facing in both developed and developing countries, particularly in view of data security, trade confidentiality and diverse business models based on intransparency. The emergence of new technologies such as BCT could soon provide a better response to this problem. Another trend leading to more challenges are autonomous business processes. In contrast to purely automated processes, autonomous processes enable more self-determination of the systems, self-administration and ultimately freedom of decision and action. In logistics, this is supported by the application of artificial intelligence methods such as machine learning. The urge for more autonomy is inherently linked to the decentralization of processes, decisions and data. In addition to aspects of data trust, decentralization can create more efficient processes without intermediaries, eliminate interim stages and enable peer-to-peer connections. A core technology, which also forms the essence of this thesis and are BCT. The collaboration and digitalization of logistics networks presents all companies with a central challenge: the development of standards and ensuring interoperability. A large number of legacy systems and newly added technological systems must work seamlessly with each other to avoid system discontinuity and to cope with the increasing data exchange. Due to the high degree of networking and the large number of countries involved in many international logistics networks, topics such as regulation must also be considered. Bureaucratic processes and corruption, especially in developing countries, present challenges for logistics managers worldwide in their networks. Here, too, technologies can be beneficial. Finally, a comprehensive challenge for all companies is sustainability, which, driven by the trend of the same name, harbors both great opportunities and risks. It is a central issue of this thesis and will be described in detail in chapter 2.3.

2.2 Technological background of blockchain technologies

Before diving deeper into the application potential of BCT in logistics in chapter 4, this sub-chapter will introduce the technological concepts and the capabilities of BCT. BCT have gained popularity since Bitcoin, a cryptocurrency based on BCT, skyrocketed in the late 2010s⁴¹. With the publication of his white paper "Bitcoin: A Peer-to-Peer Electronic Cash System" in 2008, Satoshi Nakamoto created the conceptual foundations for the Bitcoin system and its underlying

⁴¹ Cf. Francisco/Swanson (2018) p. 1.

technology, the BCT.⁴² Bitcoin is the first purely virtual currency without a central controlling authority. The system is based on a distributed peer-to-peer network of networked computers. The basis of the network is a decentralized database that records all transactions chronologically and immutable and is managed jointly by all network participants.⁴³ Confirmed transactions are grouped into blocks and successively written to the network. The resulting database system of a chain of transaction blocks gives the technology its name: blockchain.⁴⁴ This technological principle enables new forms of decentralized organization of processes. Data can be exchanged peer-to-peer within a network and efficiency gains can be achieved. Cryptographically very secure storage of data and greater transparency with regard to past transactions are further advantages of this decentralized technology. Taking a look at Gartner's HypeCycle, BCT are now in the phase of disillusionment meaning they have passed the peak of inflated expectations and are now ready for more mature implementations.⁴⁵ While numerous pilot projects in various industries and initial productive implementations demonstrate the interest in the technology and the belief in its disruptive potential, critical voices are also increasing with regard to the significance of BCT for practical application scenarios.⁴⁶ The following chapter therefore examines the technical concepts underlying the technology.

Before diving deeper into the topic, it is important to understand that in addition to BCT, there is another relevant architecture of distributed ledger technologies (DLT), the overarching technology family. Directed acyclic graphs (DAG) are still in development and could solve inherent problems of the BCT architecture in the foreseeable future. These include slow consensus algorithms or energy consumption. Both architectures are considered in the course of this chapter and their differences are discussed.⁴⁷ In the remainder of the thesis, it will be assumed that the relevant properties of these technologies differ only in the details and the term *BCT* will be used in this thesis accordingly as DAG only plays a subordinate role in current research and practice. This considers both the overarching term *DLT* and the term *blockchain*, which is used more frequently in the scientific literature and in practical implementations.

⁴² Cf. Nakamoto (2008) p. 1.

⁴³ Cf. Franco (2015a) p. 107.

⁴⁴ Cf. Zohar (2015) p. 107.

⁴⁵ Cf. Panetta (2018); Seebacher/Schüritz (2017) p. 12.

⁴⁶ Cf. Wittenberg (2020) p. 10.

⁴⁷ Cf. Pervez et al. (2018) pp. 27–29.

2.2.1 Definition and conceptual foundations of the technology

This chapter provides an overview of the technical functionality of BCT and a typology. In the further course, another prominent representative of DLT will be discussed and the directed acyclic graph, a further development of BCT, will be presented.

2.2.1.1 Technical functioning of blockchain technologies

In the following, the basic cryptographic principles of the BCT are explained on the basis of Bitcoin. Cryptographies are a very deep topic. The interested reader is referred to Paar and Pelzl (2010) for a more detailed description of cryptographic basics as this chapter will only cover the basics needed to understand the underlying mechanisms of BCT.⁴⁸ Accordingly, BCT are based on two cryptographic fundamentals. In addition to digital signatures, which are an application of public key cryptography, this includes hash functions. Digital signatures fulfill three properties. They can be used to ensure that a message was sent and signed by a specific actor. In addition, it can be ensured that the content of the message has not been manipulated or changed, and the signature is incontestable and thus non-repudiable. In practice, this works as follows. The signer uses a key generation algorithm to create a public-private key pair. The public key is sent through the communication channel to the receiver of the message. Then the signer uses the private key to digitally sign the message without making the private key public or available for others to access. The message is not encrypted, but only authenticated. The recipient of the message can now use the previously received public key to verify whether the message was sent by the corresponding sender and whether the content was manipulated. Accordingly, the message can be classified as valid or invalid.⁴⁹ The schematic process for digital signatures is shown in Figure 6.

The Bitcoin blockchain protocol uses this mechanism to sign transactions and then broadcast them to the network. All other participants in the blockchain network can then verify the transaction using the public key and the verification algorithm.⁵⁰

⁴⁸ Cf. Franco (2015b) p. 51; Paar/Pelzl (2010).

⁴⁹ Cf. Franco (2015b) p. 57.

⁵⁰ Cf. Badev/Chen (2014) pp. 8–9.

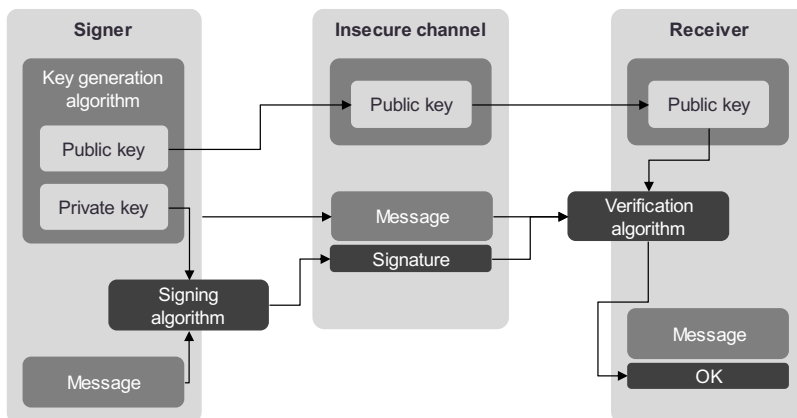

Figure 6: Digital signatures⁵¹

In addition to digital signatures, hash functions are an important component of BCT cryptography. Hash functions are cryptographic algorithms that compute a new string with a fixed length from a string of arbitrary length. This new value is called a hash value.⁵² The hash function is always deterministic, which means that the same input of data always leads to the same output (to the same hash value). On the other hand, it is not possible to derive the content of the message from the hash value and the output of the hash function is highly unlikely to be predictable. Furthermore, even the smallest changes in the message have a fundamental effect on the hash value, making manipulations detectable.⁵³ These properties are used in the context of BCT to cryptographically link the individual blocks. The exact functioning of transactions via BCT will be explained in the following.

The transaction process using BCT is presented below. In the first step, a transaction is requested. This can be, for example, the transfer of money or the exchange of goods and information. This transaction is then broadcast to the distributed network of nodes. Based on a consensus mechanism the transaction is validated. An overview of consensus mechanisms is given below. Validated transactions are grouped into blocks with multiple transactions and then added to the blockchain and distributed in the network.⁵⁴ This distributed database means that each node or user stores a full database/ledger including the complete transaction history and there is no central authority that regulates the process and the data. Thus, every user can

⁵¹ Own representation based on Franco (2015b) p. 57.

⁵² Cf. Franco (2015b) p. 95.

⁵³ Cf. Badev/Chen (2014) p. 9.

⁵⁴ Cf. Anderberg et al. (2019) pp. 13–14.

verify the transaction record without an intermediary.⁵⁵ A block consists of the transactions themselves and a header. The hash value of the previous block is stored in this header. In this way, all blocks of the blockchain are connected with each other (see Figure 7). If one of these blocks is manipulated, the hash value of this block changes and the manipulation can be detected by comparison with the hash value stored in the following block. Figure 7 shows a simplified mechanism for BCT.

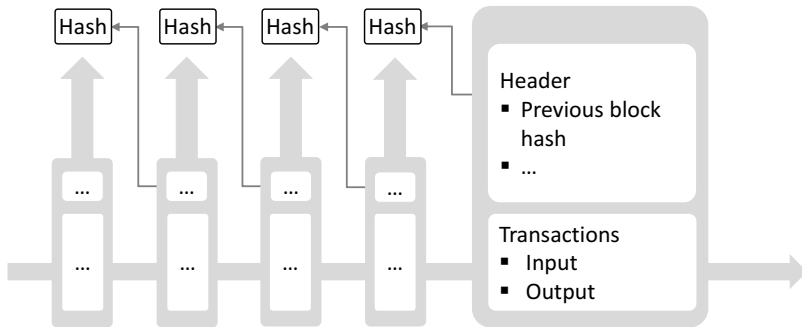

Figure 7: Simplified mechanism for BCT⁵⁶

Different consensus mechanisms are used to validate the transactions. Although these algorithmic procedures differ in their underlying transaction validation process, they are characterized by a common feature. All data changes in the blockchain must be approved by a group of key actors in a collective agreement to ensure valid data.⁵⁷ Two main consensus mechanisms are presented below: *proof of work* and *proof of stake*.

To validate transactions, so-called mining nodes must solve a cryptographic task as part of *proof of work*. This task consists of finding a hash value under the given target. This performance to be achieved is intentionally resource-intensive in order to keep the block creation process constant and prevent possible attackers of the network from tampering. The proof of performance is then verified and validated by other users. The validating node receives transaction fees for the computational effort. In the context of proof of work, the probability that a user finds the correct solution is proportional to the computational capacity it uses. Thus, energy resources are used to solve a cryptographic task, which is a frequent criticism of this consensus mechanism. After the appropriate solution has been found and verified, the block

⁵⁵ Cf. Pervez et al. (2018) p. 27.

⁵⁶ Own representation based on Bitcoin.org (2019).

⁵⁷ Cf. Verhoeven et al. (2018) pp. 2–3.

is distributed to all users according to the transaction process.⁵⁸ Since, due to the nature of proof of stake, several miners work simultaneously on the solution of the cryptographic task, it can now happen that several users arrive at a correct solution in parallel. The result is a fork in the BCT with multiple valid blockchains at that point. To solve this problem, the corresponding users continue to work based on their valid version until they are notified about a longer version of the blockchain. In each case, the longest blockchain is considered valid. Thus, it may happen that already confirmed transactions have to be deleted and validated again.⁵⁹

Proof of stake attempts to address some of the drawbacks of proof of work. While the probability of a transaction being validated in proof of work is determined by the computing power used, in proof of stake it depends on the stake of the user in the network. The term mining is no longer used, but rather minting. The probability to mint a block is therefore dependent on their holding, e.g. the amount of funds. This has a number of advantages. First, proof of stake is far less resource-intensive, since it does not require large computational capacities. Furthermore, it is less centralized, since all nodes can now mint blocks and not just a few miners with a lot of computing capacity. An attacker of the network would now have to have a large share in the network, which reduces the probability of an attack, since the incentive for an attack on a network in which the attacker has a high own share is low. In addition, transaction fees are lower since less infrastructure is needed for minting. Solving blockchain forks, on the other hand, is more complicated with proof of stake, since in the case of a fork, the user could have stakes in multiple branches and thus an incentive to work in both branches in parallel.⁶⁰ In summary, the basic idea of proof of stake is to ensure that the blockchain is updated primarily by those network nodes that hold a large share of the values in the BCT network, which should incentivize proper maintenance of the system.⁶¹

Other possible consensus mechanisms, which will not be discussed further in this thesis, are *proof of authority*, *proof of bandwidth*, *proof of storage*, *proof of resource*, *proof of burn* or *proof of activity*.⁶²

⁵⁸ Cf. Meinel et al. (2018) pp. 40–47.

⁵⁹ Cf. Schlatt et al. (2016) pp. 13–14.

⁶⁰ Cf. Franco (2015b) pp. 234–235.

⁶¹ Cf. Schlatt et al. (2016) p. 15.

⁶² Cf. Franco (2015b) p. 234.

2.2.1.2 Typology of blockchain technologies

BCT can be classified into different types based on their functionalities and architectures, which determine the user's read, execution and validation rights. The first distinction is between an open blockchain (also called public blockchain) and a closed blockchain (also called private blockchain). While everyone has access to a public blockchain, only authorized entities can access a private blockchain. Another typology criterion is the categorization into permissioned blockchain and permissionless blockchain. This distinction governs who can send and validate transactions. Accordingly, BCT are called permissionless if anyone can send and validate transactions and permissioned if this is reserved for authorized entities only. Accordingly, the combination of these two criteria results in four types of BCT, which are compared in Table 4: Public permissionless blockchain, public permissioned blockchain, private permissioned blockchain and private permissionless blockchain. To understand the visualization in Table 4 it is important to know that black dots represent validating nodes that can participate in the consensus mechanism and light grey dots represents participants of the network that can perform transactions, but have no participation in the validation process. The circle represents networks where only nodes within the circle can see the transaction history.⁶³

⁶³ Cf. Anderberg et al. (2019) pp. 14–15.



BCT type	Explanation	Visualization
Public permissionless blockchain	Every user with an Internet connection can send transaction and see the transaction history. Also, every user of the network can participate in the consensus algorithm.	
Public permissioned blockchain	Every user with an Internet connection can send transaction and see the transaction history. In contrast to public permissionless, only authorized users can participate in the consensus algorithm.	
Private permissioned blockchain	This is the most restricted type of BCT. The ability to send transaction and see the transaction history is only possible for participating nodes and the owner of the system can control who participates in the BCT system and the consensus mechanism.	
Private permissionless blockchain	In these BCT system everyone can participate in the consensus mechanism, but transactions and the transaction history are restricted.	

Table 4: Typology of BCT⁶⁴

Considering the typology criteria and the consensus mechanisms presented above, Table 5 presents an overview and a comparison of BCT platforms currently relevant in the industry. These platforms can be used as a basis for own BCT projects. The platforms Ethereum and Hyperledger, which are very widespread across industries, should be highlighted at this point. Ethereum enables transactions in a public permission-based BCT between users of the network with no trust between each other. The intrinsic cryptocurrency to motivate miners for the proof of work consensus mechanism is called Ether. Ethereum furthermore was one of the

⁶⁴ Own representation based on Anderberg et al. (2019) p. 15.

first platform introducing smart contracts and is the most popular platform for the development of BCT applications. Hyperledger fabric was developed to address issues regarding performance and reliability of BCT systems. It enables users to set up private and permission-based ledgers after registering through a membership service provider. Depending on the requirements of the private network and the applications a consensus mechanism can be chosen. There is no cryptocurrency on Hyperledger Fabric.⁶⁵

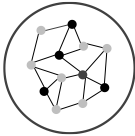
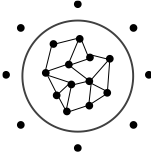
Platform	BCT type	Crypto currency	Smart contracts
Ethereum	Public and permission-based	Ether (ETH)	Yes
Hyperledger Fabric	Permission-based	None	Yes
Multichain	Permission-based	Multi-Currency	Yes
Litecoin	Public	Litecoin (LTC)	Yes
Lisk	Public and permission-based	LSK	Yes
Quorum	Permission-based	ETH	Yes
HDAC	Permission-based	Multiasset	Yes

Table 5: BCT platforms for creating BCT applications⁶⁶

2.2.1.3 Other architectures of distributed ledger technologies

As described at the beginning, BCT are part of the distributed ledger technologies family. This chapter introduces another prominent representative of DLT. Directed acyclic graphs (DAG) are a further development of BCT and promise to solve some of the inherent problems of BCT.

These inherent problems include a lack of scalability. The sequential structure of BCT and the required consensus mechanisms such as proof of work or proof of stake create a bottleneck with regard to the throughput of transactions. In addition, there are transaction costs for the validation of transactions. The distributed data structure and storage of all transactions also leads to high costs and high redundancies. The design of DAG attempts to solve these

⁶⁵ Cf. Reyna et al. (2018) p. 183; Saraf/Sabadra (2018) pp. 1–3.

⁶⁶ Cf. Reyna et al. (2018) p. 184.

problems. The basic principle is initially similar to BCT and is based on a network with nodes that can validate transactions. Each transaction that is executed requires the validation of at least two previous transactions before it can be distributed in the network. Thus, when new transactions are initiated, more transactions are validated and authorized at the same time. Unlike BCT, however, DAG does not require miners, as two parent transactions each confirm the validity of a subsequent transaction. This approach leads to significantly faster development, as transactions can be validated directly. In addition, transaction fees to the miners are eliminated. DAG technology can thus be used to realize use cases such as energy trading that require high scalability and micro transaction processing. Furthermore, unlike BCT, however, DAG does not group transactions into blocks. Instead, each node contains only a single transaction.⁶⁷ Due to the chained structure of BCT, only one chain of transaction blocks can exist in the entire network. Branching problems are resolved by the integrated consensus mechanism. In contrast to linear BCT, DAG allow simultaneous processing of transactions on multilinear, unidirectional paths.⁶⁸ Figure 8 shows the structural differences between BCT and DAG.

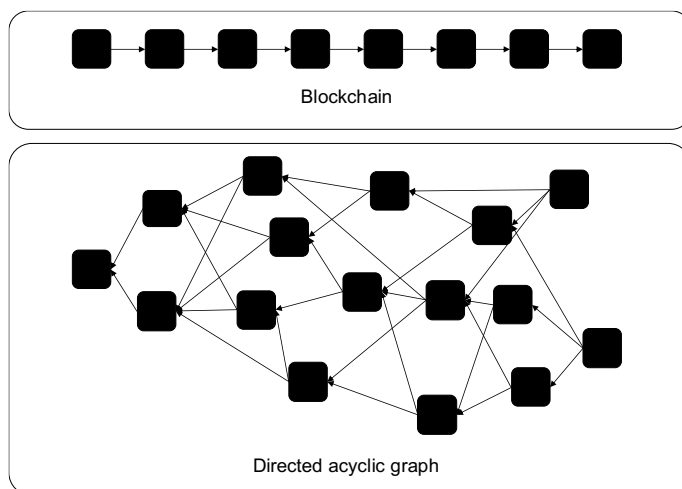

Figure 8: Structural differences between BCT and DAG⁶⁹

⁶⁷ Cf. Pervez et al. (2018) pp. 28–29.

⁶⁸ Cf. Lee (2018) p. 1.

⁶⁹ Own representation based on Pervez et al. (2018) pp. 29–32.

As described above, DAG are an interesting evolution of the technology underlying BCT. Table 6 compares BCT and DAG based on relevant criteria.

Aspect	BCT	Directed acyclic graph
Consensus	Proof of work, proof of stake	No leader election, network users conduct proof of work for their own transactions
Block creation	Main bottleneck of BCT regarding speed	No block creation because of individual transaction attachment to DAG
Fast transaction	Difficult due to proof of work / proof of stake	Fast (theoretically immediate) transactions
Mining	Miners necessary and need to be compensated	No (compensation for) miners as network members conduct proof of work
Quantum resistance	Theoretically vulnerable to brute force attacks by Quantum Computer	Uses quantum resistant cryptographic algorithms immune to brute force attacks
Scalability	Not scalable (throughput does not increase with network)	Scalable (throughput grows with network)
Improving scalability	Increase block size, off-chain channels, hierarchical chains	Coupling network usage and transaction verification
Transaction fees	Fees increase with growing network	No transaction fees

Table 6: Comparison of BCT and DAG⁷⁰

While BCT require a consensus mechanism such as proof of work or proof of stake among the validating users, transactions in the DAG are validated by the users themselves. Individual transactions in DAG are attached individually as described and not combined into blocks as in

⁷⁰ Own representation based on Pervez et al. (2018) p. 29.

BCT. This leads to almost immediately validations and a DAG is therefore significantly faster than BCT while at the same time eliminating transaction costs. The system becomes much more scalable with DAG as the throughput grows with the size of the network and no miners are needed. In terms of security, BCT is theoretically vulnerable to attack by a quantum computer. DAG, on the other hand, are immune to brute force attacks initiated by quantum computers. It is important to note that DAG are still in development and the further emergence of this technology remains to be seen. Nevertheless, some structural advantages over BCT emerge as explained above that could make DAG interesting for logistics as well.⁷¹

2.2.2 Functionalities of blockchain technologies

Based on the technical structure of DLT in general and BCT and DAG in particular described so far, this chapter explains the core functionalities of the technology. This is an essential basis for the application of the BCT in international logistics networks in the following (sub-) chapters. Table 7 presents an overview before explaining the functionalities in detail below.

The fact that BCT are distributed networks means that intermediaries or central authorities can be replaced to some extent. The trust that was previously placed in those same central bodies is now based on rules and consensus mechanisms that provide an agreed process for verification, validation and execution of transactions. This *decentralization* creates strong resilience as there can be no central point of failure and BCT are difficult to attack as data is stored in a redundant and distributed manner.⁷²

The second core functionality of BCT is *immutable* storage of the *data*. Unintentional manipulation of the data is hardly possible and only theoretically possible over 51 % of the computing capacity (proof of work) or 51 % of the shares (proof of stake). Some therefore speak only of tamper-proof and not of immutable data. Due to the distributed storage, changes are traceable for every user. Cryptographic digital signatures additionally guarantee the integrity of the transmitted data.⁷³

The ledger and thus the transaction history of BCT can be viewed by all users. This *transparency* and visibility increase trust and verifiability of data across the network. Depending on the use case, it may be important not to share sensitive information transparently across the network. Private networks or certain architectures can help address these issues, for example, proving only that the transaction took place without disclosing the content or participants and storing sensitive data off-chain. Thus, even larger amounts of data could be

⁷¹ Cf. Pervez et al. (2018) p. 29.

⁷² Cf. Anderberg et al. (2019) p. 16.

⁷³ Cf. Anderberg et al. (2019) pp. 16–17.

stored outside the ledger and linked via a hash reference or pointer. In private networks, access can also be restricted to specific users. Furthermore, there is the possibility to guarantee additional encryption via cryptographic protocols like zero-knowledge proofs and to hide certain details of transactions. Thus, decentralized, transparent and privacy-friendly solutions can be implemented.⁷⁴

BCT are based on public-private key cryptography and hash functions and thus guarantee the authenticity and integrity of the exchanged data and transactions and therefore a high degree of *security*. While public keys are shared in the network, verification of transactions is only possible via encryption algorithms and secret private keys. In addition, transactions are time-stamped and an immutable transaction history is available to all (see immutable data). Theoretically, however, brute force attacks on BCT via quantum computers are possible, although this has not happened yet. Nevertheless, it is important to further develop BCT systems and make them quantum resistant. All in all, BCT represent a high level of data security compared to other centralized data storages.⁷⁵

The last core functionality of BCT are *smart contracts*. Decentralized services can be implemented and used on the blockchain. Thus, the unique properties of the technology in terms of trust, transparency and security can be used for a variety of processes. One of the most important implementations in this context are smart contracts, data-driven computer programs that can trigger previously agreed actions without human intervention. Mostly, these are if-then conditions that are implemented on the blockchain and automatically execute transactions when certain events or conditions occur. Thus, based on trust in the algorithms, two or more users can automatically perform transactions without an intermediary.⁷⁶

These five core functionalities are the main reasons for the success of the technology and the potential it can offer in the context of international logistics networks. Before in chapter 4.2, based on the functionalities, possible application areas of BCT in international logistics networks and their implementation status in the industry will be examined. However, prior to further elaborations on BCT, the topic of sustainability in logistics as well as the role of digitalization will be discussed in detail in order to create the third basis of the theoretical framework.

⁷⁴ Cf. Anderberg et al. (2019) pp. 17–18.

⁷⁵ Cf. Anderberg et al. (2019) pp. 18–19.

⁷⁶ Cf. Anderberg et al. (2019) pp. 19–20.

Functionality	Explanation
Decentralization	Data based on BCT is stored in distributed networks. There is no central authority and no intermediaries for data management.
Immutable data	Stored data or transactions are immutable and tamper-proof and can therefore hardly be manipulated.
Transparency	The entire transaction history is visible and thus traceable, which results in more trust in the network.
Security	Public key cryptography and hash functions ensure the authenticity and integrity of the data.
Smart contracts	Decentralized services can be implemented on the BCT. Smart contracts can trigger data-driven transactions.

*Table 7: Functionalities of BCT*⁷⁷

2.3 Sustainability and logistics

The chapter explains the construct of sustainability and specifies the dimensions in which it can have an effect. In the further course of this chapter, both logistics and sustainability are brought together and it is explained to what extent different drivers in logistics networks influence sustainable development and how this can ultimately be measured and assessed.

2.3.1 Definition of sustainability

Despite a historical development and a high frequency of use in business, politics and society, there is no binding and all-encompassing definition of sustainability.⁷⁸ The term sustainability has developed steadily from its origins to the way it is understood today. The historical origin of the term was established in the 18th century by Carl von Carlowitz in a forestry context. The Saxon mountain governor appealed for a “sustainable use” of wood, of which no more should

⁷⁷ Own representation based on Anderberg et al. (2019) pp. 16–20.

⁷⁸ Cf. Grober (2013) p. 20.

be felled in a certain period of time than can grow again.⁷⁹ Sustainability is therefore in its origin a resource-economic principle for the permanent and profitable use of a resource.⁸⁰

One of the most widespread and frequently cited definitions of sustainability comes from "Our Common Future", better known today as the Brundtland Report of the World Commission on Environment and Development of 1987⁸¹, which describes sustainable development as development that fulfils the needs of the present generation without compromising the ability of future generations to fulfil their own needs.⁸² This definition puts human needs first. Furthermore, the Brundtland Report bundles the global problems and challenges into four central problem areas: overexploitation of natural resources, growing inequality in income and wealth distribution, increasing numbers of people living in absolute poverty, and threats to peace and security.⁸³ The concept of sustainability is thus associated with preserving the environment, establishing social justice and ensuring political participation. The UN Conference on Environment and Development, which met in Rio in 1992, formulated a program of action in which everything revolved around sustainability. This conference represented the most important milestone to date in the political anchoring of the sustainability aspect. About 180 states committed themselves to developing sustainability strategies that were to include social and economic aspects in addition to environmental ones.⁸⁴ From that time on, the term sustainability has included three dimensions to this day, namely economic, environmental and social sustainability.

2.3.2 Dimensions of sustainability

Environmental sustainability is primarily aimed at the preservation or protection of nature. Natural resources should be used efficiently, emissions and waste should also be avoided as far as possible along the value chain or at least reduced to a minimum. Social sustainability puts people at the center of attention. It includes the observance of human rights and the implementation of good working conditions. Exploitation as well as child and forced labor are therefore at odds with social sustainability. Economic sustainability requires good management. A company should do business in a way that ensures its future success. The use of renewable raw materials, recycling, forward-looking investments and the promotion of research and development all play an important role.⁸⁵ Later, Elkington introduced the concept

⁷⁹ Cf. Grober (2013) p. 21.

⁸⁰ Cf. Pufé (2014) p. 36.

⁸¹ Cf. Grober (2013) p. 21; Pufé (2014) p. 65.

⁸² Cf. WCED (1987) p. 16.

⁸³ Cf. Hauff (1987) p. 36.

⁸⁴ Cf. Bundesministerium für wirtschaftliche Zusammenarbeit und Entwicklung (2020) p. 1.

⁸⁵ Cf. Zeschmar-Lahl (2015) p. 1.

of the Triple Bottom Line (TBL), which integrates the three dimensions of sustainability presented in one concept. This states that it is not possible to achieve a desired level of environmental, social or economic sustainability (separately) without achieving at least a basic level of all three forms of sustainability at the same time.⁸⁶ As shown in Figure 9, sustainability prevails where all three dimensions overlap.

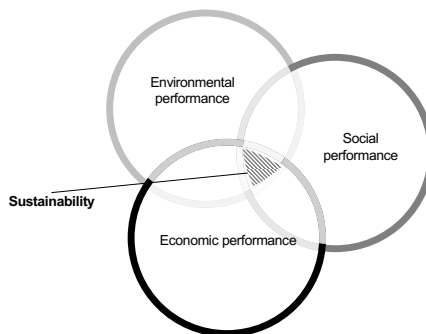

Figure 9: Triple bottom line⁸⁷

The practical implementation of the sustainability principle is visible in companies worldwide. More than two-thirds of companies have introduced sustainability permanently into their corporate policy and now consider it necessary to maintain their own competitiveness.⁸⁸ In this context, sustainability can be understood as the maintenance and expansion of economic growth, shareholder value, reputation, customer relations, and product and service quality. It also encompasses the adoption and pursuit of ethical business practices and the creation of sustainable jobs.⁸⁹ Potential benefits include the reduction of long-term risks, e.g. resource depletion, fluctuations in energy costs, product liability and pollution.⁹⁰ Although the principle of sustainability requires a basic level of all three dimensions, as explained above, the economic aspect of sustainability seems to be crucial. This is also reflected in the literature, where a large number of articles focus on the economic dimension (87.2 %). However, in the last 20 years, the largest focus has been on the environmental dimension (94.6 %). The social dimension is less pronounced in this sample (34.9 %), but it has gained more attention in

⁸⁶ Cf. Elkington (1999) p. 75.

⁸⁷ Cf. Carter/Rogers (2008) p. 365.

⁸⁸ Cf. Kiron (2012) p. 70.

⁸⁹ Cf. Székely/Knirsch (2005) p. 628.

⁹⁰ Cf. Shrivastava (1995) p. 955.

recent years.⁹¹ This thesis therefore aims to contribute particularly to the dimensions of social and environmental sustainability, which have received less prominent attention to date.

By agreeing on the 2030 Agenda for Sustainable Development in 2015, an important cornerstone was laid for the international responsibility of all states with regard to sustainability. The Agenda applies to industrialized countries as well as emerging and developing countries. At the core of the 2030 Agenda are 17 goals, the so-called Sustainable Development Goals (SDG), which encompass all three dimensions of sustainability - social, environmental and economic - in equal measure. In addition to these goals, five core messages are defined and summarized under the 5Ps: people, planet, prosperity, peace and partnership. The overarching goal is to pursue these SDG through global partnerships and to report progress internationally.⁹²

Table 8 gives an overview of the 17 SDG as declared by the United Nations.

⁹¹ Cf. Beske-Janssen et al. (2015) pp. 665–678.

⁹² Cf. Bundesministerium für wirtschaftliche Zusammenarbeit und Entwicklung (2017) p. 7; United Nations (2015) pp. 1–35.

#	Goals
1	“End poverty in all its forms everywhere.”
2	“End hunger, achieve food security and improved nutrition and promote sustainable agriculture.”
3	“Ensure healthy lives and promote well-being for all at all ages.”
4	“Ensure inclusive and equitable quality education and promote lifelong learning opportunities for all.”
5	“Achieve gender equality and empower all women and girls.”
6	“Ensure availability and sustainable management of water and sanitation for all.”
7	“Ensure access to affordable, reliable, sustainable and modern energy for all.”
8	“Promote sustained, inclusive and sustainable economic growth, full and productive employment and decent work for all.”
9	“Build resilient infrastructure, promote inclusive and sustainable industrialization and foster innovation.”
10	“Reduce inequality within and among countries.”
11	“Make cities and human settlements inclusive, safe, resilient and sustainable.”
12	“Ensure sustainable consumption and production patterns.”
13	“Take urgent action to combat climate change and its impacts.”
14	“Conserve and sustainably use the oceans, seas and marine resources for sustainable development.”
15	“Protect, restore and promote sustainable use of terrestrial ecosystems, sustainably manage forests, combat desertification, and halt and reverse land degradation and halt biodiversity loss.”
16	“Promote peaceful and inclusive societies for sustainable development, provide access to justice for all and build effective, accountable and inclusive institutions at all levels.”
17	“Strengthen the means of implementation and revitalize the Global Partnership for Sustainable Development.”

Table 8: Sustainable Development Goals (SDG)⁹³

⁹³ United Nations (2015) p. 14.

The five core messages derive directly from these goals. Regarding people, the principle of the entire 2030 Agenda is to leave no one behind. Hunger and poverty must be actively combated and gender equality must be ensured. To this end, disadvantaged and discriminated population groups must be reached in order to enable all people globally to live in dignity. A concrete example of Germany's commitment in this context is the establishment of green innovation centers to support smallholder farms and the associated improvement in the regional supply of food. Equally important is the issue of planet. To ensure an intact environment, existing ecosystems must be preserved and climate change, which threatens the future prospects of all countries, must be combated. An area of tension between protecting the environment and climate and increasing access to energy worldwide must be resolved. One example of this is the German support in more than 50 countries for the construction of geothermal plants as well as solar and wind power plants. Furthermore, equal opportunities with regard to economic, social and technical progress must be ensured in the sense of prosperity. Particular attention is paid to sustainable economic growth and humane working conditions. An important practical example is compliance with environmental and social standards in logistics networks. The fourth core message peace describes peace and stability as important prerequisites for sustainable development. Human rights, good governance and the corresponding institutions must be promoted and crisis regions stabilized. One example of this is combating the causes of flight, which is a high priority for Germany. Finally, partnership describes the joint approach to achieving the goals of the 2030 Agenda, which can only be achieved through international cooperation and global partnerships.⁹⁴

2.3.3 Sustainability in the context of logistics

This chapter examines the impact of sustainability on logistics networks and logistics management. Besides the definition of sustainable logistics management, the thesis in this chapter deals with the drivers of sustainable logistics and the social and environmental sustainability standards for measuring and reporting sustainability indicators and initiatives.

This section first defines the extent to which logistics management can be defined as sustainable. Therefore, the definitions according to Carter and Rogers (2008) and Seuring and Müller (2008) are used (see Table 9). Carter and Rogers' definition does not place sufficient emphasis on the logistics aspect. Therefore, the definition according to Seuring and Müller is followed for the purposes of this thesis. However, Carter and Rogers present four additional supporting instruments for sustainable logistics management (risk management, transparency,

⁹⁴ Cf. Bundesministerium für wirtschaftliche Zusammenarbeit und Entwicklung (2017) pp. 14–23.

strategy, culture) that can positively influence the success of sustainability across the three dimensions. These instruments are described in detail below and are connected to the triple bottom line. While it could be claimed that other instruments play a role, those four constructs are the most characteristic and consistent in the literature on sustainable logistics.⁹⁵

Authors	Definition of sustainable logistics management
Carter / Rogers (2008)	“[...] the strategic, transparent integration and achievement of an organization’s social, environmental, and economic goals in the systemic coordination of key inter-organizational business processes for improving the long-term economic performance of the individual company and its supply chains” ⁹⁶
Seuring / Müller (2008)	“[...] the management of material, information and capital flows as well as cooperation among companies along the supply chain while taking goals from all three dimensions of sustainable development, i.e., economic, environmental and social, into account which are derived from customer and stakeholder requirements. In sustainable supply chains, environmental and social criteria need to be fulfilled by the members to remain within the supply chain, while it is expected that competitiveness would be maintained through meeting customer needs and related economic criteria.” ⁹⁷

Table 9: Definitions of sustainable logistics management⁹⁸

A recurring theme in the literature on sustainability is risk management. Sustainable logistics therefor has to include contingency planning as well as the consideration and management of future network disruptions. These include supply bottlenecks, changing energy costs and the reduction of environmental and health risks.⁹⁹

Transparency within the logistics network and to the outside environment (e.g. towards the customer) contributes to the sustainable development of the logistics network. In recent years, this development has been driven by an increasing interconnectedness of actors through the

⁹⁵ Cf. Carter/Rogers (2008) p. 365.

⁹⁶ Carter/Rogers (2008) p. 368.

⁹⁷ Seuring/Müller (2008) p. 1700.

⁹⁸ Own representation

⁹⁹ Cf. Carter/Rogers (2008) pp. 365–366.

Internet and other communication technologies as well as interoperable software and the globalization of logistics networks, which complicates the concealment of corporate wrongdoings. Transparency not only includes reporting to network partners, but also the active involvement of stakeholders to improve logistics processes. The increase of transparency is possible both vertically within a logistics value chain and horizontally within the network.¹⁰⁰

The sustainability initiatives of companies should be closely linked to the overall corporate strategy. This enables the entire organization to focus on sustainability aspects and ensures a cross-dimensional sustainability target vision for all corporate divisions.¹⁰¹

The creation of an organizational culture in line with sustainability requirements should be pursued. This includes the establishment of high ethical standards and the integration of stakeholder expectations with social and environmental responsibility along the logistics network.¹⁰²

After defining sustainable logistics management as described above for the further course of the thesis, the following section discusses the influence of different stakeholder groups on sustainability initiatives as sustainable development within logistics networks is driven primarily by the demands of various stakeholder groups.¹⁰³ In addition to (end) customers, these include the state or legislative institutions as well as actors in the market and competitive environment. Table 10 gives an overview of important requirements of the main stakeholder groups.

These stakeholder group requirements result in logistical goals in all three dimensions of sustainability. A selection of the most important goals is shown in Table 11. While all three dimensions are of direct relevance for this thesis, the focus with regard to the impact by BCT will be mainly on the environmental and social objectives. Together, the following goals cover the spectrum of sustainable logistics management in the dimensions of environmental, social and economic sustainability. In addition to economic perspectives such as orientation towards long-term business value through competitiveness and profit, these include various aspects of resource-conserving corporate management and production, compliance with standards and social justice.

¹⁰⁰ Cf. Carter/Rogers (2008) p. 367.

¹⁰¹ Cf. Carter/Rogers (2008) p. 367.

¹⁰² Cf. Carter/Rogers (2008) p. 368.

¹⁰³ Cf. Elbert/Borkowski (2010) p. 33; Onkila (2010) pp. 379-380.

Stakeholder group	Essential requirements
Costumers	<ul style="list-style-type: none"> • Sustainability-pull through demands of customers
State / government	<ul style="list-style-type: none"> • Stricter environmental legislation, definition of emission reduction targets • Increasing regulatory requirements for emissions reporting and –reduction as well as CSR
Market / competition	<ul style="list-style-type: none"> • Rising costs of fossil fuels • Sustainability as a differentiation and competitive factor • Required transparency regarding environmental and social impact of companies by capital investors

Table 10: Stakeholder groups and requirements¹⁰⁴

Environmental	Social	Economic
<ul style="list-style-type: none"> • Minimization of resource consumption and material turnover • Creation of material cycles at the highest possible level • Minimization of substance releases into nature • Efficient use of renewable resources 	<ul style="list-style-type: none"> • Social security • Integration and communication • High social and qualification standards 	<ul style="list-style-type: none"> • Appropriate profit • Permanent assurance of competitiveness

Table 11: Goals of sustainable corporate development¹⁰⁵

This thesis will focus on the social and environmental dimensions of sustainability, which is why economic aspects are only considered peripherally, for example in the context of

¹⁰⁴ Own representation based on Wutke (2016) p. 65.

¹⁰⁵ Own representation based on Rogall (2000) p. 33.

measuring the success of the project or the project resources. Therefore, the remaining chapter will bring social and environmental aspects and criteria into the focus. Following this basic understanding of sustainability in the context of logistics, the following section will elaborate on environmental and social standards as the basis for measuring and reporting sustainability. The measurement and reporting of these environmental and social standards can be performed at different levels. A distinction can be made between the meso, macro and micro levels, depending on the viewpoint.¹⁰⁶ In the following, common standards in logistics are presented for both environmental and social sustainability.

Standards for environmental sustainability

There are standards and norms for measuring and presenting the environmental effects of corporate processes at various reporting levels, which are explained in more detail below.

The *ISO 14000 series* is a collection of voluntary standards and guidelines for companies that want to identify and minimize their environmental impact. Within the series, only the ISO 14001 standard can be certified.¹⁰⁷ It describes the structure of an environmental reporting system. Above all, it offers companies the opportunity to demonstrate the implementation of an environmental reporting system, but does not mean that certified companies are particularly environmentally sustainable.¹⁰⁸ However, due to the learning effects of implementing an environmental management system, it is implicitly assumed that companies that implement ISO 14000 achieve higher reductions than other companies.¹⁰⁹

Another important standard for the environmental sustainability of companies is *EMAS (Eco-Management and Audit Scheme)*. EMAS and ISO certification differ mainly in the form of certification. While ISO is carried out by the private sector, EMAS certification is carried out under state control. The requirements of the two standards are comparable. In contrast to ISO, however, EMAS can only be used in Europe and not worldwide.¹¹⁰

The *Greenhouse Gas Protocol (GHG) Corporate Accounting and Reporting Standard* was first introduced in 2001 and has since been supported and applied by a large number of organizations.¹¹¹ Especially the combination of the content categories of the GHG and the processual standards of the ISO norm has gained high importance for the measurement and reduction of emissions in the corporate context. The GHG defines the basic principles of

¹⁰⁶ Cf. Wutke (2016) p. 72.

¹⁰⁷ Cf. Cullinane/Edwards (2011) p. 42.

¹⁰⁸ Cf. Delmas/Montiel (2009) pp. 175–176.

¹⁰⁹ Cf. Coglianese/Nash (2001) p. 11.

¹¹⁰ Cf. Ciliberti et al. (2008) p. 93; Wutke (2016) p. 74.

¹¹¹ Cf. Greenhouse Gas Protocol (2020) p. 3.

relevance, completeness, consistency, transparency and accuracy and is based on principles of financial accounting. Furthermore, the GHG defines rules for the organizational and operational delimitation of a greenhouse gas balance.¹¹²

ISO 14067 specifies requirements for the quantitative determination of the carbon footprint of products in order to simplify and standardize the determination of greenhouse gas emissions at product level. The entire product life cycle is to be covered, including raw material extraction, production, use and disposal.¹¹³

The European standard *DIN EN 16258* describes a method for energy and emission balancing of transport services. It specifies a uniform methodology, system boundaries and procedures for allocating emissions to individual customers and data sources. The standard has no legal character, its application is voluntary. By taking all modes of transport into account, it is designed for a broad field of application. In the level of detail of the specifications, the standard represents a compromise between maximum precision and applicability by different user groups.¹¹⁴ Table 12 compares the standards for environmental sustainability in logistics described above.

	Company balance sheets	Product balance sheets	Transport balance sheets
Standards	ISO 14001, ISO 14064, EMAS, GHG Protocol (GHG)	GHG Protocol (GHG), ISO 14067, PAS 2050	DIN EN 16258, DIN SPEC 91224
System borders	Own activities, involvement of subcontractors is voluntary	Entire value chain	Entire transport chain including subcontractors
Environmental parameter	All greenhouse gases (as CO ₂ equivalents)	All greenhouse gases (as CO ₂ equivalents)	All greenhouse gases (as CO ₂ equivalents) + energy use

Table 12: Comparison of standards and accounting levels¹¹⁵

¹¹² Cf. Wutke (2016) p. 74.

¹¹³ Cf. DIN (2019) p. 21; Wutke (2016) p. 75.

¹¹⁴ Cf. DIN (2013) p. 5; Wutke (2016) p. 76.

¹¹⁵ Own representation based on DSLV Deutscher Speditions- und Logistikverband e. V. (2013) p. 20; Wutke (2016) p. 73.

Standards for social sustainability

Even though the social dimension of sustainability often plays a subordinate role in research and practice, it often has a higher share in reporting than environmental factors.¹¹⁶ Significant standards for social sustainability are described in more detail below.

The *Global Reporting Initiative* was founded in 1997 and uses a participatory process to develop guidelines for the preparation of sustainability reports by large corporations, small and medium-sized enterprises (SME), governments and NGO. For external reporting in particular, it is advisable to use the guidelines and indicators of the GRI. These have established themselves internationally as the standard for sustainability reporting and are continuously developed further in a cooperation of hundreds of companies, investors, rating agencies, auditors, associations, unions, NGO and scientists. The goal is the standardized, comparable presentation of the economic, environmental, social and societal performance of the respective reporting entity for a wide range of stakeholders.¹¹⁷

In 2010, *ISO 26000* was established as a standard for the social and corporate responsibility of companies and organizations. However, ISO 26000 is not a management system standard and, unlike the environmental management standard ISO 14001, it is not intended or suitable for certification. However, ISO 26000 can be interpreted as one of the frameworks that companies can use promote a common understanding of social responsibility and to complement other tools and standards in order to support their CSR reporting obligations.¹¹⁸

The *OECD Guidelines* for multinational enterprises are regarded worldwide as one of the most important instruments for promoting responsible corporate governance. The 34 member states of the Organization for Economic Cooperation and Development (OECD) and eight other countries have signed the guidelines. They commit themselves to encourage all companies operating in their territory to comply with the guidelines in their value chains. The guidelines set a standard for companies, but are not legally binding.¹¹⁹

Companies with a focus on social responsibility can be aligned and monitored according to the SA 8000 (Social Accountability 8000) management and certification system. This social standard was developed in 1997/98 by the U.S. NGO Social Accountability International (SAI) on the basis of the international convention on human rights and the recommendations of the International Labor Organization (ILO). It is an internationally accepted certification norm with a number of strict standards, including the introduction of humane working conditions, freedom

¹¹⁶ Cf. Wutke (2016) p. 78.

¹¹⁷ Cf. Aachener Stiftung Kathy Beys (2015a); Wutke (2016) p. 80.

¹¹⁸ Cf. ISO (2018).

¹¹⁹ Cf. Aachener Stiftung Kathy Beys (2015b).

of association and the prohibition of child labor and discrimination. SA 8000 monitors compliance with minimum social standards in manufacturing companies and is responsible for the certification of factories worldwide, which is carried out by independent certification organizations. SA 8000 is comparable in structure with the environmental management standard ISO 14001 and the quality management standard ISO 9000:2000 and is fully compatible with them.¹²⁰

Table 13 compares the standards for social sustainability in logistics described above.

Standard	Type	Core topics
Global Reporting Initiative	Guidelines for the preparation of sustainability reports	List of criteria to increase the transparency of reporting and assistance in its preparation
ISO 26000	Voluntary guidelines for organizations, not certifiable	Standard on the social and societal responsibility of companies and organizations (e.g. on leadership, human rights, environment)
OECD Guidelines	International guidelines with a recommendatory character	Code of conduct for the relationship between companies and employees
SA8000	Internationally valid standard, auditable and certifiable	Improvement of working conditions for employees, minimum requirements for social and labor standards

Table 13: Overview of social sustainability reporting standards¹²¹

From the presented ecological and social standards, criteria can be derived that are relevant for the further course of the thesis, especially for the selection of the case studies and the evaluation of the sustainability impact on international logistics networks. An overview of the extracted criteria is given in Table 14. Therefore, seven core criteria can be derived from environmental and social sustainability standards in logistics:

¹²⁰ Cf. Aachener Stiftung Kathy Beys (2015c); SAI (2021).

¹²¹ Own representation based on Wutke (2016) p. 79.

- resource and energy consumption
- impact on the environment through products or services
- labor conditions
- human rights
- society and fair business
- product responsibility and consumer issues
- sustainable management system

Starting with *resource and energy consumption*, companies need to pay attention to generation and supply of consumed direct and indirect energy forms, products and services. Required energy and resources should be minimized as far as possible. Furthermore, the *impact on the environment through products or services* should be considered. This not only includes cross-company accounting of transport-related emissions of all scopes, but also the general prevention of pollution of the environment as well as the development of mitigation strategies for climate change on all levels. With regard to *labor conditions*, the focus is on the relationship between employee and employer. Therefore, health and safety should be guaranteed as well as suitable opportunities for training and education. Especially in global logistics networks, the compliance with *human rights* is of tremendous importance. Companies should make sure, that in their own logistics network, all suppliers and partners comply with agreed regulations and standards. Therefore, child and forced labor must be avoided, and the rights of the indigenous population must be guaranteed and supported. In this context, due diligence, meaning a careful assessment, should be carried out for materials, products or regions that are subject to conflict. With regard to *society and fair business*, fair competition should be ensured and corruption and bribery be fought. Employees are entitled to freedom of association and the right to collective bargaining. In addition, social and environmental responsibility should be promoted throughout the logistics network. Another criterion relates to *product responsibility and consumer issues* to be borne by the company. In this sense, attention must be paid to the health and safety of customers when using products or services. At the same time, privacy should be guaranteed and only unbiased information communicated. Ultimately, a *sustainable management system* is an important criterion to be derived from the standards. Sustainable goals should be formulated and initiatives planned. Continuous monitoring, review and improvement of these goals and measures ensures a long-term focus on socially and environmentally sustainable value creation.

Core criteria	Standards	Description
Resource and energy consumption	GRI, ISO 14001, ISO 14064	<ul style="list-style-type: none"> • Generation and supply of consumed of direct and indirect energy forms, products and services
Impact on the environment through products or services	GRI, GHG Protocol, ISO 26000, DIN SPEC 91224, DIN EN 16258	<ul style="list-style-type: none"> • Cross-company accounting of transport-related emissions, • Prevention of pollution • Climate change mitigation
Labor conditions	GRI, ISO 26000, SA8000	<ul style="list-style-type: none"> • Health and safety • Training and education • Employment relationships
Human rights	GRI, ISO 26000, SA8000	<ul style="list-style-type: none"> • No child labor or forced labor • Indigenous rights • Due diligence
Society and fair business	GRI, ISO 26000, SA8000	<ul style="list-style-type: none"> • Political support • Fair competition and combating bribery and corruption • Promoting social responsibility • Freedom of association & right to collective bargaining
Product responsibility and consumer issues	GRI, ISO 26000	<ul style="list-style-type: none"> • Customer health and safety • Privacy protection • Unbiased information
Sustainable management system	ISO 14001, SA8000	<ul style="list-style-type: none"> • Development, monitoring and review of sustainable objectives • Continuous improvement

Table 14: Extracted core criteria from social and environmental standards¹²²

¹²² Own representation based on DIN (2013); DIN (2017); GRI Standards (2020); ISO (2018); ISO (2019); SAI (2021); Umweltbundesamt (2020); WBCSD/WRI (2004).

2.3.4 Sustainability and digitalization in logistics

Digital Technologies can influence all three dimensions of sustainability and are therefore important levers in logistics sustainability management. To address this issue, an overview of the potential sustainability impact of technologies and the corresponding digital characteristics is provided (see Table 15). According to Kayikci (2018) digitalization in logistics is shaped by five characteristics: cooperation, connectivity, adaptiveness, integration, autonomous control and cognition. Cooperative behavior within digitalization enables logistics processes to be handled more efficiently and reliably. This is accompanied by new requirements for data exchange and data integration at the informational level as well as the sharing of logistics assets at the physical level, e.g. the joint use of storage or transport capacities. Connectivity ensures that digital resources within a network are connected to each other via interfaces. This is an important enabler for vertical end-to-end integration and visibility from the supplier to the end customer. Examples are machine-to-machine communication and big data analytics to exchange and evaluate data or cloud computing. The logistics network can become more efficient and intelligent through more connectivity. In order to prepare the logistics network for changes caused by individual events from outside or over time, digitized logistics systems are characterized by adaptiveness. It is important here that it is both adaptable (can be changed by external actors) and self-adaptive and can therefore change itself in response to altered conditions. One example is the ability to exchange sensors in smart containers. Integration is characterized by a real-time exchange of data and processes and the connection and integration of data from multiple actors. In this process, several computing systems are physically or functionally connected to each other and an interaction of the systems is enabled. Examples of this are end-to-end platforms in logistics that enable several network partners to exchange products and services with each other. Autonomous control and cognition ultimately describe decentralized, autonomous decision-making made possible by digitalization, which is characterized by independent interaction without external interference. One example of this is the forecast of the estimated time of arrival in the transport of goods, considering a large number of variables such as weather and infrastructure utilization and the use of artificial intelligence algorithms.¹²³ In the impact matrix, this is contrasted with the criteria of sustainable logistics. While the economic criteria are characterized by logistics costs, delivery time or flexibility, among other things, the environmental criteria include resource efficiency, emissions and waste, and the social criteria include development benefits, health and acceptance.¹²⁴

¹²³ Cf. Kayikci (2018) p. 785.

¹²⁴ Cf. Kayikci (2018) p. 787.

Sustainability criteria		Digitalization characteristics of logistics					
Sustainability dimensions	Sustainability criteria	Cooperation	Connectivity	Adaptiveness	Integration	Autonomous control	Cognition
Economic	Logistics cost	+++	+++	++	+++	+	+
	Delivery time	+++	++	++	++	+++	++
	Inventory reduction	++	++	+	+++	+++	+++
	Forecast accuracy	+++	+++	++	+	+++	++
	Reliability	+++	+	+	+++	+++	++
	Flexibility	+++	+++	++	+	+++	++
Environmental	Resource efficiency	+++	++	+	++	++	++
	Process energy	+	+	++	+++	++	+++
	Process emissions	+	++	+++	+++	+++	+++
	Waste	++	+++	+++	+++	++	+++
	Pollutions	++	+	+	++	+++	++
	Land use impact	+	+++	+	+	+	+
Social	Development benefits	+	++	+	+	++	++
	Impacts	++	+	+	++	+	++
	Health	++	+	++	++	++	++
	Safety	++	++	++	++	+++	++
	Labor patterns	+	+	+	+	-	-
	Acceptance	+	+	+	++	+	+

Relative impact: + less/poor ++ moderate +++ high/excellent, no impact, n/a

Table 15: Excerpt of impacts of digitalization in logistics on sustainability¹²⁵

¹²⁵ Cf. Kayikci (2018) p. 787.

The results show that the use of digital technologies in logistics networks can have a major positive impact on economic, environmental and social sustainability. Depending on the characteristics of the technology used, the influence is more or less pronounced in all areas of sustainability. The characteristics of the technologies on which this thesis is based, BCT, will be discussed in the upcoming chapters in order to subsequently analyze the influence of these technologies using selected logistics networks as examples.

When using digital technologies to improve sustainability in logistics, it is important to assess the resulting changes. According to the focus of this thesis, both the environmental and social dimensions of sustainability are referred to. Digital technologies can affect the sustainability of logistics networks in three different ways. In the context of sustainability, it is not only important to achieve direct improvements, but also to induce these improvements both indirectly and implicitly. Thus, in addition to improvement, aspects of measurement and reporting are also available for the assessment of sustainability through technologies. The assumption for the impact of technologies on sustainability is thus that technologies can be process-effective on three levels:

- measurement
- reporting
- improvement.

Therefore, technologies can be used to measure environmental sustainability (e.g. ability to track emissions or involvement of all stakeholders) and social sustainability (e.g. measurement of compliance with human rights or the awareness of working conditions within the network). Furthermore, the use of technologies can influence sustainability reporting, especially with regard to applied standards and norms. Finally, the technology itself can improve sustainability in logistics by enabling root cause analyses or by achieving direct changes through the technology (e.g. CO₂ reduction or avoidance through new technology). In parallel to these process-related impacts, the use of the technology itself can also have an influence on social or environmental parameters (e.g. energy consumption when using the technology).

3 Overview of the methodological approach

This chapter will explain the research methodology as utilized within this thesis. The research approach of this thesis consists of the following methods: systematic literature review followed by Q-methodology, workshops and group survey as well as case study explorations. The multi-method approach is in line with the building blocks of thesis as stated in chapter 1. Therefore, a systematic literature will be conducted to identify relevant use cases for BCT in logistics. These use cases will then be further clustered by applying Q-methodology to develop aggregated application areas for BCT in the context of logistics. To further enhance these results, a workshop will be conducted to identify challenges for the implementation of BCT followed by survey to evaluate these challenges and the previously developed application areas. These results will be part of phase one and two of the management model. To developed the third phase of the model, an online workshop will be conducted to discuss and assess three case studies with the goal to develop a sustainability impact model for BCT in logistics with stakeholder specific criteria. Following this, phase 4 of the management model is based on the detailed evaluation of three case studies in the context of BCT in logistics applying the approach by Kittel-Wegner and Meyer (2002) to develop the management areas for the implementation of the technology and to finalize the manage model for social and environmental impact of BCT in logistics. Ultimately, the previous results and findings of the thesis are consolidated with new insights from literature and practice to conceptualize a vision of future logistics networks and the role of BCT.

3.1 Systematic literature review

In order to identify relevant use cases for BCT the first step was conducting a systematic literature review (SLR) following the approach developed by Durach (2016) as depicted in Table 16. The selected data base for the literature search was Business Source Complete (via EBSCO) due to its considerable amount of business research literature and its frequent utilization in studies in the research field of logistics¹²⁶.

¹²⁶ Cf. Durach et al. (2015) p. 121; Wagner/Kemmerling (2010) p. 363.

#	Steps	Aspects to consider
1	Definition of analysis focus	<ul style="list-style-type: none"> • Significant research contribution • Stakeholder engagement
2	Preparation of the literature search	<ul style="list-style-type: none"> • Inclusion and exclusion criteria development • Ex-ante restrictions of the literature search
3	Literature search	<ul style="list-style-type: none"> • Selection of an appropriate method for literature search • Development of search strings for searching in electronic databases
4	Selection of relevant literature	<ul style="list-style-type: none"> • Application of inclusion and exclusion criteria for literature selection • Assessment of literature quality and validity
5	Analysis and synthesis of the literature	<ul style="list-style-type: none"> • Achieving a valid research contribution
6	Use of the research results	<ul style="list-style-type: none"> • Presentation of the researched literature and publication of the research results

Table 16: SLR developed by Durach (2016)¹²⁷

The inclusion criteria for the admission of articles to the closer selection is shown in Table 17.

¹²⁷ Cf. Durach (2016) pp. 28–29.

Inclusion criteria

- 1 The article must be written in English.
 - 2 In the summary, the abstract, in the keywords or in the title it must be recognizable that either DLT in general or BCT are the object of research.
 - 3 In the summary, abstract, keywords or title it must be recognizable that use cases, applications or the like are examined in relation to the object of research.
 - 4 In the summary, abstract, keywords or title it must be recognizable that the areas of logistics or supply chain management are concerned.
-

Table 17: Inclusion criteria¹²⁸

To develop the search string for the SLR, two additional researchers were asked for support in order to grasp a variety of studies and keywords. The final search string consists of different keywords and dimensions for *BCT*, *logistics*, and *use case* and can be found in Table 18.

Data base	Search string
Business Source Complete (via EBSCO)	(Blockchain* OR "Block Chain*" OR "Distributed ledger*") AND (Logistic* OR "Supply Chain*" OR SCM OR Transport OR Procurement OR Sourcing OR Production OR Warehous* OR "distribution*") AND (Use case* OR "Use-case*" OR Implement* OR Concept OR Application* OR Utili?ation OR "Case stud*")

Table 18: Search string for SLR¹²⁹

The search with Business Source Complete (via EBSCO) yielded in a result of 265 articles. To achieve a high number of relevant results the search was not only focused on academic peer-reviewed journal, but also included book chapters, magazines, non-peer-reviewed research

¹²⁸ Own representation

¹²⁹ Own representation

and reports. After the elimination of duplicates and articles that did not fulfill all inclusion criteria the synthesis sample included 53 relevant publications, which were then read and analyzed regarding application areas and use cases for BCT in logistics. Figure 10 gives an overview of the distribution over the years and shows a clear growth of interest into the topic from 2017 to 2020 (as the SLR was conducted in March 2020 the number of articles in 2020 was likely to rise until the end of the year).

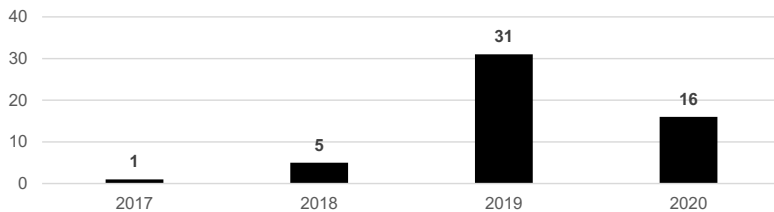

Figure 10: Relevant literature by year¹³⁰

The analysis of the 53 articles resulted in a total of 155 non-MECE (mutually exclusive and collectively exhaustive) use cases for BCT in logistics. To arrange these use cases in clusters and application areas the Q-methodology as utilized in Durach, Wieland, and Machuca (2015) was applied¹³¹. This methodology helps to reduce bias and to enhance objectivity. The 155 use cases were written on cards (Q-sample) and presented to two researchers together with the task to independently cluster the use cases in application areas and to put them into relation with each other. After this independent procedure the results were presented to each other, similarities were acknowledged and differences discussed to come up with a final result of application areas and designated use cases showing no overlap between the clusters. In a consecutive open discussion, a framework was created from the aggregated use cases. Use cases with at least five references in the literature were automatically adopted. If less than 5 references per use case were made, the respective theoretical and practical validity of the use case was discussed and analyzed on the basis of the corresponding studies. Only if the researchers agreed on the importance of the use case, it was adopted into the framework. This methodology lead to a total of five key application areas of BCT in logistics which will be described in further detail in chapter 4.2.1.

¹³⁰ Own representation

¹³¹ Cf. Durach et al. (2015) pp. 123–124.

3.2 Workshops and group surveys

The first workshop was conducted to identify challenges in the implementation of BCT in international logistics networks and was held with 30 professionals in February 2020. The intend was to bring expert from the fields of BCT and logistics together to discuss the challenges these topics pose to companies. Therefore, a heterogeneous group was invited to meet on-site in Berlin for the discussions. The demographics of the attendees of the workshop participants are shown in Table 19. They show that mainly manufacturers were part of the workshop, as well as LSP and technology providers. In addition, research institutions and associations were part of the workshop. The company size covers a wide spectrum, but is concentrated on very large companies above 10,000 employees and rather smaller companies with specific experience in BCT. The management level of the participants ranges from team member to general manager, but is mostly located in the upper management levels.

Industry	# of employees	Management level
Manufacturing (n=14)	Up to 100 (n=6)	General manager (n=10)
Logistics service provider (n=6)	100–500 (n=2)	Department manager (n=5)
Technology provider (n=6)	500–1,000 (n=1)	Team Leader (n=6)
Academia (n=3)	1,000–2,500 (n=2)	Team Member (n=6)
Associations (n=1)	2,500–10,000 (n=3)	Researcher (n=3)
	Above 10,000 (n=16)	

Table 19: Sample demographics of the first workshop¹³²

The driving principle of the workshop was the Nominal Group Technique. This method was first developed and conducted by Delbecq and VandeVen.¹³³ With the help of this method, an open question can be discussed and answered in small groups. The exact procedure is shown in Figure 11.

¹³² Own representation

¹³³ Cf. Delbecq/van de Ven (1971) pp. 469–489.

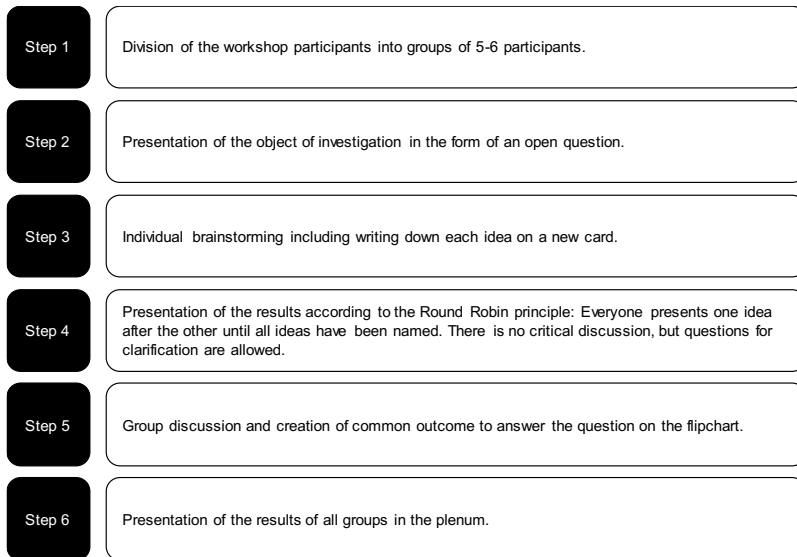

Figure 11: Nominal group technique methodology¹³⁴

With the help of this methodology, the dynamics that often arise in group discussions are prevented, that certain ideas are not elaborated for fear of criticism. Equal participation in the discussion is therefore guaranteed for all participants. Thus, the greatest possible number of possible solutions is worked out, which are then open for discussion. This first workshop was further complemented with a follow-up questionnaire. The questionnaire was sent to the participants after the workshop and a total of 20 responses could be obtained. The focus of this questionnaire was the evaluation of challenges and the application areas presented in chapter 4.2.2. The areas examined per application area were the following. The current application status of the application area was queried. The possible dimensions here were not planned, planned, the testing of a pilot or an implemented solution in live operation of the company. Within the implementation horizon, the time frame in which a marketability of the application area is conceivable was determined. In addition to these two dimensions, the BCT applicability, the maturity level, the complexity of the application area and the expected benefit for the company network were determined and compared in a spider diagram. An overview including description and scale of the dimensions examined is shown in Table 20.

¹³⁴ Own representation based on Delbecq/van de Ven (1971) pp. 469–489.

Item	Description	Scale
Application status	Assessment of the extent to which use cases in this application area have already been implemented or are planned in the respondent's company	Not planned, planned, pilot, implemented
Implementation horizon	Time frame within which a market maturity of the use cases in the application area is conceivable	2020, 2025, 2030, Later, Never
BCT applicability	Suitability of BCT for the respective application area	Likert Scale 1-5
Maturity	Assessment on how advanced the concepts and existing implementation of the application area already are	Likert Scale 1-5
Complexity	Complexity in the implementation of use cases of the respective application area in the network	Likert Scale 1-5
Benefit	The expected benefit of use cases coming with a successful implementation	Likert Scale 1-5

Table 20: Items for application area evaluation¹³⁵

To identify stakeholders and impact dimensions in chapter 4.3.1 a second workshop was conducted in September 2020 with 24 professionals. The professionals were invited to an online via video conference intending to discuss case studies of BCT in international logistics networks with a focus on sustainability with the aim of using the findings for the development of the sustainability impact model for BCT in logistics. The demographics of the attendees of the workshop participants are shown in Table 21. These reveal a broad field of participants with balanced proportions of manufacturers, LSPs and technology providers. Similar to the first workshop, mainly smaller specialized companies with a focus on BCT as well as large manufacturers and suppliers were brought together for the discussion. The management level shows a concentration on higher management levels, enriched by team members.

¹³⁵ Own representation

Industry	# of employees	Management level
Manufacturing (n=8)	Up to 100 (n=5)	General manager (n=10)
Logistics service provider (n=7)	100–500 (n=2)	Department manager (n=6)
Technology provider (n=8)	500–1,000 (n=1)	Team Leader (n=3)
Academia (n=1)	1,000–2,500 (n=0)	Team Member (n=4)
Associations (n=0)	2,500–10,000 (n=3)	Researcher (n=1)
	Above 10,000 (n=13)	

Table 21: Sample demographics of the second workshop¹³⁶

The driving principle of the workshop were open and moderated group discussions on different use cases of BCT with a focus on social and environmental sustainability. Table 22 gives an overview of the discussed use cases. Those three use cases were selected by conducting a pre-workshop survey among the registered participants.

The first use case considered deals with the Ethiopian coffee industry including distribution to and processing in Germany. The coffee is first harvested by Ethiopian coffee farmers and then processed in the country as part of post-harvest processes before being sold via auction centers for export and domestic consumption, depending on the quality. Processes to roast the coffee are carried out primarily in the destination countries. The second use case looks at the cobalt industry, which is gaining importance with the increased demand for electric mobility. The main mining area for the global markets in this case is the Democratic Republic of the Congo. The third use case looks at the possibilities for transparent tracking of emissions along the entire logistics network, considering all players and stages in the production process of a product.

¹³⁶ Own representation

Industry	Use case	Discussion
Food industry	Fair operations in the coffee industry	What are stakeholders in the coffee industry and how can BCT be applied to create more transparency and ensure fair operations?
Automotive industry	Ethical cobalt supply in the automotive industry	What are stakeholders in the cobalt logistics network for battery electric vehicles and how can BCT be applied to create more transparency and ensure an ethical supply of minerals?
Cross-industry	Track emissions along the entire logistics network	What are stakeholders in the field of emissions reporting and how can BCT help to measure, track and report emissions?

Table 22: Use case overview¹³⁷

Each use case was discussed in separated groups of 8 industry experts. The moderated group discussions aimed at identifying stakeholders and then discussing the expected impact with a focus on social and environmental sustainability per stakeholder, which could result from a possible application of BCT, including success factors and enablers. The discussion followed a three-step methodology. First, ten minutes were given for individual brainstorming / -writing, during which the participants were given time to think about and deal with the questions on their own. The subsequent moderated group discussion gave the opportunity to exchange ideas and challenge each other. Finally, the results were summarized in a framework and presented to all participants of the other groups. Following the workshop, the overarching workshop results were aggregated into the developed sustainability impact model as shown in chapter 4.3.2. The participants were given the opportunity to criticize the developed model and to suggest changes and extensions of the content by means of a follow-up questionnaire.

¹³⁷ Own representation

3.3 Case study exploration

The methodology explained in this chapter will follow the approach for explorative case studies by Kittel-Wegner and Meyer (2002) which already has been successfully applied in the research field of logistics.¹³⁸ The goal of the case study investigation is to develop the fourth phase of the management model, which will support the user in implementing BCT in logistics.

For the selection of companies/representatives and the corresponding case studies, in a first step selection criteria are defined. In total three case studies will be conducted. Table 23 shows the criteria used to select the case studies. These show that the selected case studies cover a wide range of industries and application areas of BCT in logistics. In chapter 4.2.1 the application areas *tracking and tracing*, *verification and certification* as well as *planning and network* are identified as suitable to achieve the desired sustainable impacts. Therefore, those three application areas are represented by the case studies. Also, the social and environmental dimensions of sustainability, which are the focus of this thesis, are considered. Additionally, according to the focus of the thesis all case studies refer to international logistics networks and will be described in detail in chapter 4.4.1.

Case study	Scope	Industry	Application area	Sustainability dimension
Case study A	International	Coffee	Tracking and tracing	Social
Case study B	International	Automotive	Tracking and tracing, verification and certification	Social
Case study C	International	LSP	Verification and certification, planning and network	Environmental / economic

Table 23: Selection criteria for the case studies¹³⁹

Methodically, in each case approximately 1.5-hour interviews with at least two company representatives from different stakeholders of the logistics networks of the case studies are

¹³⁸ Cf. Kittel-Wegner/Meyer (2002) p. 22; Roy (2017) p. 79.

¹³⁹ Own representation

combined with non-publicly and publicly available company material and integrated into the analysis and the description of the case studies. Combining different perspectives through the diversity in the selection of representative interview partners is to be seen as a prerequisite for the cross-company understanding of BCT in logistics. Table 43 (see appendix) shows the guiding questions for the semi-structured interviews for the case studies. For reasons of accuracy, the reports are discussed with the interviewees in a second step again and then cross-case conclusions are drawn that are incorporated into the implementation approach of the management model. Following the development of the management model, a validation interview is conducted in which the model was first presented and then discussed and validated. The demographics of the interviewees are shown in Table 21.

Interviewee	Management level	Case	Industry	# of employees
1	General Manager	A	Manufacturing	1,000–2,500
2	General Manager	A	Technology provider	Up to 100
3	General Manager	B	Manufacturing	100–500
4	General Manager	B	Technology Provider	Up to 100
5	Department Manager	B	Technology Provider	Up to 100
6	General Manager	C	Logistics service provider	Above 10,000
7	General Manager	C	Association	100–500
8	Team Member	C	Technology Provider	2,500–10,000

Table 24: Sample demographics of the case study interviewees¹⁴⁰

Concluding, for further consideration in the dissertation, three exemplary logistics networks will be examined in detail. Three use cases from three different industries for the application areas *tracking and tracing*, *verification and certification* as well as *planning and network* will be

¹⁴⁰ Own representation

considered. They will be used to demonstrate the sustainable social and environmental effects of BCT in international logistics networks and serve as a basis for the management model to be developed by extracting management best practices for implementations of BCT in logistics.

4 Development of the management model for social and environmental impact in logistics through blockchain technologies

The aim of this chapter is to develop a management model that enables companies to understand the potential of the technology in terms of sustainability and to implement it within their networks. Therefore chapter 4.1 will introduce the conceptual design of the management model, which is then developed in the following chapters. In chapter 4.2 possible application areas of BCT in logistics are identified and challenges and applicability limitations are discussed. Furthermore, the concept of a mindful adoption will be elaborated. Following this, in chapter 4.2, it will be investigated to what extent the individual actors of the logistics networks (focal company itself, suppliers, customers, logistics service providers) can improve their sustainability in the areas of social and environmental aspects through BCT yielding in a sustainability impact model for BCT in logistics. Furthermore, the model will prepare companies for the implementation process by using different management areas to compile design recommendations and management tools and instruments as well as to identify success factors for a prosperous implementation in chapter 4.4. A summary as well as an exemplary application of the management model follow in chapter 4.5, respectively chapter 4.6.

4.1 Conceptual design of the management model

The aim of the model is to bring together descriptive, explanatory and design elements in a management model that supports users from understanding their problem and the technological functionalities of BCT, to deriving potential sustainable impacts in the dimensions of both social and environmental, to ultimately implementing the technology and providing appropriate decision support and management tools. This results in four phases for the envisaged management model as described in more detail below. The first phase of the management model for social and environmental impact in logistics through BCT is descriptive and will be the starting point for companies on their journey to more sustainable logistics networks by understanding the technology, bringing it in context with the specific business processes and therefore, derive certain network-specific requirements for the upcoming implementation. Moreover, in phase one a first assessment regarding the general applicability of BCT for the elicited requirements will be conducted based on the applicability limitations elaborated in chapter 4.2.4 and the developed framework for application areas of BCT in logistics in chapter 4.2.1. Building on the identified requirements for the logistics network, in phase two the user will be presented with the mindful adoption model for BCT in logistics. Based on the five mindful adoption principles *engagement with technology*, *technological*

novelty seeking, awareness of local context, cognizance of alternative technologies as well as *anticipation of technology alteration*, users can analyze for specific scenarios whether they follow a mindful approach. The second phase is therefore explanatory and a result of chapter 4.2.5 of this thesis. After phase two, the further course of action is reviewed and the BCT solution may be discarded. The third phase of the management model is explanatory as well and will help the logistics network to determine the expected sustainability impact and the corresponding changes from introducing BCT to the network. This will be done in different dimensions, and individually for each stakeholder from raw material supplier to customers including logistics service providers. Meaning, implications from a sustainability perspective for the individual actors of international logistics networks are examined and to what extent they are influenced by BCT. This phase is a result from chapter 4.3 of this thesis. At the end of the third phase, the user knows the requirements, evaluated the mindful adoption of BCT and is aware of the expected sustainability impact within his network. Based on this, the further course of action is reviewed again and the BCT solution may be discarded after all. If not, the challenge is now to drive forward the implementation and realization. The fourth phase is the implementation phase of the management model and guides the user through the implementation process by focusing on five management areas which in combination are responsible for the success of the project. Besides *strategy and goals*, these are *internal organization, external collaboration, technology* and the *implementation* itself. Each of these management areas will help to overcome certain challenges along the implementation process by shining light on different success factors and design recommendations for logistics management. At the end of the fourth phase the implementation is completed. The following chapters will explain the development of the model in detail. Figure 12 shows the conceptual design of the management model for social and environmental impact in logistics through BCT.

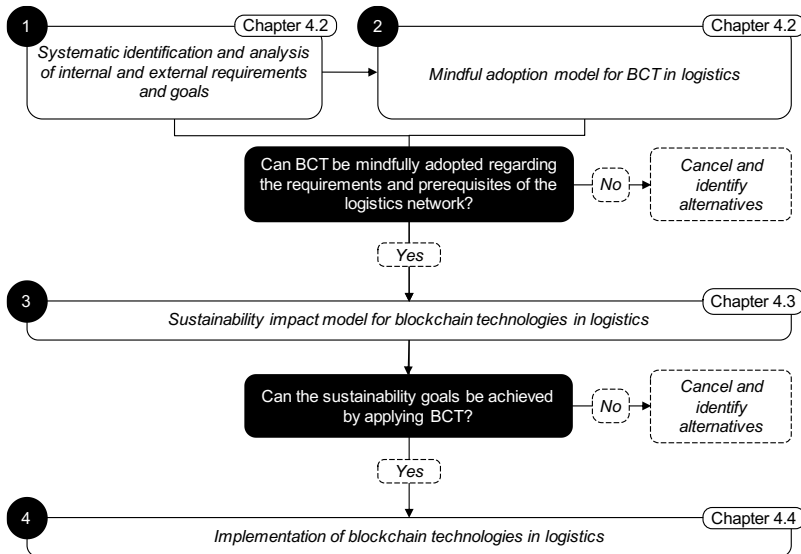

Figure 12: Conceptual design of the management model¹⁴¹

The four phases of the management model as described above are summarized in Table 25. The fundamentals of each phase will be developed in the coming chapters. While the foundations for phase one and phase two will be addressed in chapter 4.2 in detail, the sustainability impact model for phase three will be developed in chapter 4.3, and the implementation model for phase four will be developed in chapter 4.4. A summary of the model is given in chapter 4.5 before the management model is applied exemplarily in chapter 4.6.

¹⁴¹ Own representation

#	Phase	Chapter	Description
1	Requirements analysis	4.2	Analysis of internal and external requirements from a logistical and sustainability perspective with regard to all stakeholders involved to assess the general applicability of BCT
2	Mindful adoption model	4.2	Applying the developed model from chapter 4.2.5 to ensure that organizational and local requirements of the logistics network are covered by the technical functionalities of the technology
3	Sustainability impact analysis	4.3	Determination of the impact potential for increased social and environmental sustainability per stakeholder in various dimensions by applying the sustainability model developed in chapter 4.3.2
4	Implementation	4.4	Guiding the user through a successful implementation by means of the five management areas <i>strategy and goals</i> , <i>internal organization</i> , <i>external collaboration</i> , <i>technology</i> as well as <i>implementation</i> as developed in chapter 4.4.2.

Table 25: Four phases of the management model¹⁴²

¹⁴² Own representation

4.2 Phase 1 and 2: mindful adoption and application areas of blockchain technologies in logistics

This chapter will categorize application areas for BCT in logistics. Therefore, a systematic literature review (SLR) is conducted and evaluated. In total five key application areas are identified and further subdivided. Furthermore, the application areas are evaluated, challenges and applicability limits of BCT are discussed and the mindful adoption model for BCT in logistics is elaborated.

4.2.1 Application areas of blockchain technologies in logistics

Applying the systematic literature review and Q-methodology as mentioned in chapter 3.1, five key application areas were identified and adopted into a framework as depicted in Figure 13. Each of the five application areas (*tracking and tracing*, *financial operations*, *verification and certification*, *planning and network* as well as *automation and IoT*) consists of a variety of subordinated use case clusters. The entirety of application areas is mutually exclusive and collectively exhaustive and therefore, shows no overlap between each other, although real-life implementations are often a combination of the herein named application areas and/or use case clusters.

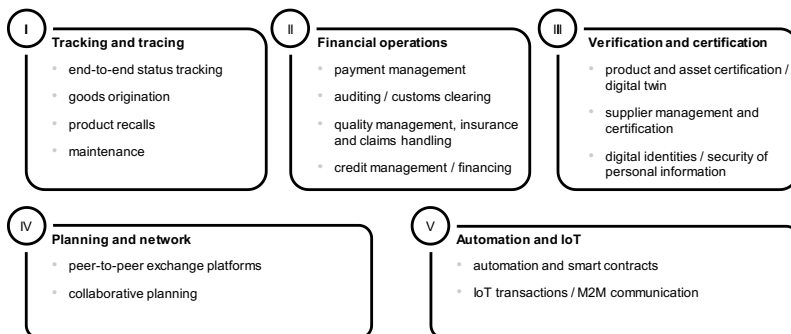

Figure 13: Framework for application areas of BCT in logistics¹⁴³

A brief description of each application areas can be found in Table 26, while a detailed description will follow in the subsequently chapters.

¹⁴³ Own representation

Application area	Description
Tracking and tracing	<p>Due to the immutability of the data and the resulting increased transparency, use cases are available which prove the product origin or enable process steps along the entire logistics network to be displayed end-to-end.</p>
Financial operations	<p>BCT enable a variety of more efficient and cost-effective financial operations. These include topics such as financial transactions between companies without intermediaries such as banks and payment administrators or activities such as customs clearing and audits.</p>
Verification and certification	<p>Increased transparency and data reliability of BCT make the technology suitable for verification and certification. This can play a decisive role in the context of supplier management, but also in the verification of products and assets up to digital identity of network participants.</p>
Planning and network	<p>Various forms of new collaborative planning and network control are possible. Besides topics such as integrative capacity planning, this includes (P2P) platforms. These enable an exchange of goods and services without intermediaries and thus more efficient and cost-effective processes.</p>
Automation and IoT	<p>Automation is implemented on BCT using smart contracts, which are data-based decision models that autonomously trigger transactions as soon as defined events are fulfilled. Especially for IoT, DAG are conceivable, which enable transfers of small data points with no transaction costs.</p>

Table 26: Overview of application areas of BCT in logistics ¹⁴⁴

¹⁴⁴ Own representation

With a total of 56 mentions in the SLR results, *tracking and tracing* use cases are the most common application area. BCT-based applications offer increased transparency and visibility along the entire logistics network. This enables a multitude of application possibilities. The four important use case clusters within tracking and tracing are:

- end-to-end status tracking
- goods origination
- product recalls
- maintenance.

One of the most prominent applications of BCT, especially in logistics, is the tracking of process steps along the value chain. Due to the ever-increasing interconnection of procurement and sales markets, companies are continuously forced to enhance communication networks and thus optimize their logistics processes. The background to this is the constantly growing demand for information flows, such as the location and condition of goods as well as data for the real-time control of production assets and the material flow itself. By linking a large number of actors, coupled with high transparency and immutability of the data, the technology enables complete traceability for all parties involved. It guarantees that verified information about the traceability of the entire logistics network is possible and thus manipulations can be excluded. This information can be tracked over the entire product life cycle¹⁴⁵. The transparency and above all the immutability of the data achieved by BCT allows both companies and customers not only to trace individual process steps along the logistics network, but ultimately to trace the product back to its origin. This origin is often located at the beginning of raw material chains and represents an important adjustment screw in the logistics network from the perspective of sustainability. Knowledge about the origin of the product can thus contribute not only to more efficient logistics solutions but also to socially and environmentally sustainable ones¹⁴⁶. In the context of product recalls, with BCT a faster procedure is possible to trace production processes and all transactions back to the final products in a transparent and traceable manner. Product recalls due to quality defects can quickly lead to considerable, also economic, consequences. Examples include Maradol-brand papayas, which caused hundreds of people to fall ill in 2017 due to salmonella, or the E. coli outbreak within Chipotle Mexican Grill outlets in 2015. These outbreaks are associated with enormous health consequences for customers and damage to the company's image. For example, the Chipotle share fell by 42 %. The reasons for the failure in the recall were lack of transparency and accountability in the logistics

¹⁴⁵ Cf. Bumblauskas et al. (2020) pp. 2–9; George et al. (2019) pp. 3–7; Meiriño et al. (2019) p. 678.

¹⁴⁶ Cf. Di Vaio/Varriale (2020) p. 1; Saberi et al. (2019) p. 2130; van Hoek (2019) p. 842.

network and offer starting points for BCT to solve these problems¹⁴⁷. Other possible applications include supporting the operative areas in the maintenance of assets. BCT enable cross-process and continuous monitoring of machines and systems and can thus provide a reliable data basis for predictive maintenance work¹⁴⁸.

34 mentions in the literature show a significant importance of *financial operations* for applications of BCT in logistics. For financial operations as a primary source of mainstream applications of BCT like Bitcoin, the conclusions of the literature review result in the following use case cluster:

- payment management
- auditing / customs clearing
- quality management, insurance and claims handling
- credit management / financing.

BCT enable the decentralized processing of payments within logistics networks. Due to the high traceability of transactions and transparency within the network, payments can be processed peer to peer, and therefore directly, without intermediaries such as banks and payment service providers. This not only increases efficiency, but also helps to minimize costs, since the fees of the intermediaries are eliminated without substitution (except for marginal transaction costs depending on the BCT solution)¹⁴⁹. Although the execution of financial and currency transactions is the core use case cluster in the area of financial operations, there are other clusters. BCT offer the chance for a paradigm shift for audits and the way the transfer of values and rights will be organized in the future. For example, transparent registers of ownership structures are conceivable. However, the audit-related issues necessary from an accounting point of view will remain valid. With BCT, however, it will be possible in the course of the audit to trace all of the decentralized ownership relationships and changes of ownership during the audit period under consideration¹⁵⁰. In the context of quality management, claims handling and possible insurance claims due to non-performance or reduced performance by logistics partners can be processed decentrally and bilaterally (peer-to-peer) by BCT, thus enabling a transparent allocation of ownership and compensation obligations and rights. This makes the process faster and the transaction record more reliable and resilient¹⁵¹. Other financial services and support operations include the evaluation and provision of credits to

¹⁴⁷ Cf. Saberi et al. (2019) pp. 2117–2123; van Hoek (2019) p. 842.

¹⁴⁸ Cf. Di Vaio/Varriale (2020) p. 7; Mahamuni (2019) pp. 23–24.

¹⁴⁹ Cf. Angeles (2018) p. 54; Mahamuni (2019) p. 23; Tönnissen/Teuteberg (2020) pp. 2–3.

¹⁵⁰ Cf. Deloitte (2020); Min (2019) p. 43; Yang (2019) p. 115.

¹⁵¹ Cf. Cole et al. (2019) pp. 474–475; Dorri et al. (2017) p. 122; Helo/Hao (2019) p. 245.

finance value-added structures and to support trading. These can be organized decentrally using BCT and do not require a central authority like banks¹⁵².

With 17 mentions, the topics of *verification and certification* resemble also a broadly investigated field. In addition to products, assets and suppliers as well as the associated processes, this also includes digital identities and the preservation of the security of personal information:

- product and asset verification / digital twin
- supplier management and certification
- digital identities and security of personal information.

The immutable transaction history through BCT enables the verification of products and assets. These can be, for example, counterfeit-proof parts in the context of spare parts logistics or a traceable originality of the end products for the customer. Another possible application in this context is the creation of digital twins of assets such as machines or equipment. This digital twin can be seen as a kind of CV of the tracked asset and presents the asset history transparently and immutable to be able to draw evidence-based conclusions (e.g. for maintenance intervals)¹⁵³. Supplier certifications can be presented transparently for companies along the logistics network, but also for consumers or end customers. This aspect is closely linked to the goods origination described under tracking and tracing. Furthermore, decentralized processes for supplier management within the logistics network are possible with BCT¹⁵⁴. A final aspect for verifications and certifications is the creation of digital identities. These can, for example, enable members of the logistics network to participate in global financial and goods flows even without a bank identity. Above all, however, they enable decentralization and thus make personal accounts independent of individual providers. Such a digital identity can be administered by citizens/customers themselves and can enable access to a wide range of services provided by various companies and institutions. The use of products and services will thus become more efficient and barriers for customers and partners in the logistics network will decrease. Furthermore, BCT provide the necessary encryption and decentralized transaction history, which ensures reliable and secure storage of personal information¹⁵⁵.

¹⁵² Cf. Angeles (2018) p. 52; Bürer et al. (2019) p. 4; Chaudhary et al. (2019) p. 289.

¹⁵³ Cf. Angeles (2018) pp. 51–52; Huang et al. (2020) pp. 361–370; Mandolla et al. (2019) pp. 134–150.

¹⁵⁴ Cf. Saberi et al. (2019) pp. 2117–2123.

¹⁵⁵ Cf. Dorri et al. (2017) p. 122; Fosso Wamba et al. (2020) pp. 115–137; Queiroz et al. (2019) p. 247.

An application area represented in the literature review with 9 mentions is *planning and network*. This relatively less researched application area of BCT enables new collaborative formats of decentralized cooperation. In the context of use cases these include

- peer-to-peer exchange platforms
- collaborative planning.

Platform applications in logistics are usually hosted by central providers or central consortia or institutions. Examples of such platforms are sourcing platforms for the exchange of supply and demand as well as the development of supplier relationships or freight forwarding platforms for brokering transport capacities. Centralization is always accompanied by relatively high brokerage and transaction fees, both for customers and suppliers. A decentralized peer-to-peer exchange platform based on BCT can contribute to a more efficient matching of supply and demand by connecting users directly with each other, concluding and processing peer-to-peer contracts and thus making a neutral entity, an intermediary, superfluous. The process becomes not only more cost-effective, but also more efficient¹⁵⁶. In the case of non-collaborative logistics networks without exchanged information, each value chain member carries out its own planning based on the available information. Transparency, security and trust using BCT can form the basis for a successful and long-term exchange of information, which is necessary for planning in the logistics network. Collaborative planning activities, which can be mapped decentrally using BCT, include, among others, demand forecasting or capacity management¹⁵⁷.

With 38 mentions in the literature review the second most frequent application area, *automation and IoT*, presents two large use case clusters for BCT in logistics. They are strongly related to automation and IoT in particular and the digitalization of logistics networks in general:

- automation / smart contracts
- IoT transactions / M2M communication.

BCT enable the automation of transactions using smart contracts. These are data-driven, rule-based and event-based algorithms. When previously defined events are reached, such as the arrival of goods or quality inspection after supplier deliveries, these algorithms trigger previously defined transactions. This in turn can be the payment for the goods received. A smart contract therefore supports the automation of many of today's manual processes and enables the management of events in a network with many players. Efficiency gains and cost

¹⁵⁶ Cf. Gurtu/Johny (2019) pp. 883–890; Tönnissen/Teuteberg (2020) p. 5; Wang et al. (2019a) pp. 1–11.

¹⁵⁷ Cf. Blossey et al. (2019) p. 6887.

savings are the result. Smart contracts are one of the basic functionalities of BCT¹⁵⁸ (see chapter 2.2.2). Furthermore, BCT are suitable for use as a basis for data to be processed within IoT due to their architecture. The decentralized structure reduces the probability of failure, since there is no single point of failure. The security is also ensured by the technology's encryption algorithms. Last but not least, BCT as decentralized technologies can contribute to supporting standards and making sensitive data available to network partners. A combination with smart contracts (see above) supports the IoT enforced automation and enables autonomous decisions. Due to the high amount of data points with low value this is a use case cluster that is highly suitable to be addressed by DAG¹⁵⁹ (see chapter 2.2.1.3).

Bringing these five application areas in relation to the previously defined core criteria derived from the social and environmental standards in chapter 2.3.3 (*resource and energy consumption, impact on the environment through products or services, labor conditions, human rights, society and fair business, product responsibility and consumer issues as well as sustainable management system*) shows that some application areas are more purposeful to pursue socially and environmentally more sustainable logistics networks. Especially *tracking and tracing, verification & certification* as well as *planning and network* use cases can be combined to achieve the desired sustainable impacts. Conceivable scenarios in this context deal with the transparent tracing and verification of products and processes along the logistics network. In this way, the involvement of (sub)suppliers with good working conditions and compliance with human rights can be guaranteed and companies can thus fulfill their product responsibility. Furthermore, on an ecological level, emissions can be recorded decentrally and standardized across all stakeholders and used as a basis for emission reductions. Decentralized, cross-company planning and control processes made possible by BCT can additionally enable better capacity utilization and thus lead directly to an improvement in the environmental footprint of logistics networks. In particular, chapters 4.3.2 and 4.4.2 examine in detail the application of these scenarios in practice by evaluating workshop discussions and conducting case studies.¹⁶⁰

¹⁵⁸ Cf. Angeles (2018) pp. 51–52; Gurtu/Johnny (2019) pp. 884–892; Hasan et al. (2019) pp. 149–159.

¹⁵⁹ Cf. Chanson et al. (2019) pp. 1–65; Mazzei et al. (2020) pp. 432–445; Moin et al. (2019) pp. 325–340.

¹⁶⁰ Cf. Park/Li (2021) pp. 6–9; Upadhyaya et al. (2021) p. 6.

4.2.2 Current challenges for the implementation of blockchain technologies

In this chapter challenges for the implementation of BCT in logistics are discussed and evaluated. The challenges identified in the workshop and evaluated in the follow-up survey in terms of complexity and impact are explained in more detail below. The 14 challenges identified can be assigned to five dimensions:

- strategy
- internal organization
- collaboration
- technology
- governance.

An overview of the challenges is given in Figure 14.

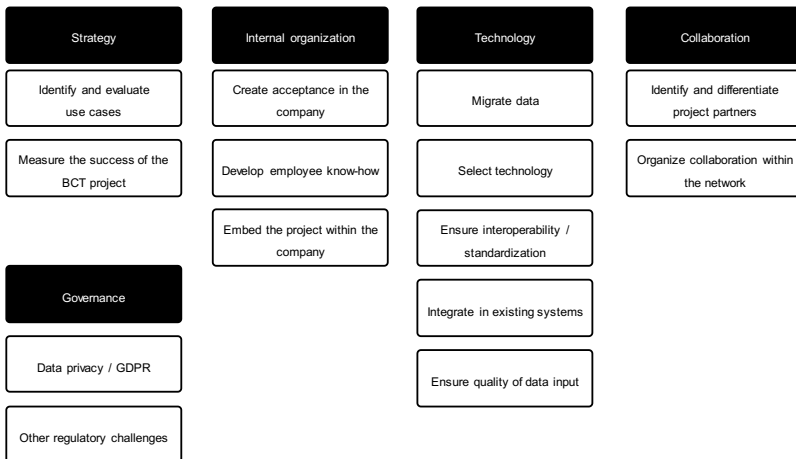

Figure 14: Challenges for BCT implementations in logistics¹⁶¹

In the following, the challenges identified are first described before a ranking in terms of complexity and impact is made.

The first challenge dimension is *strategy*. The *identification and evaluation of application areas and corresponding use cases* is the first challenge for companies interested in BCT. It is important to think in a problem-oriented way (technology pull) and not to try to create a suitable problem for the existing technology (technology push). This means that an existing problem in

¹⁶¹ Own representation

the company's logistics is identified and BCT can contribute to its solution. Thus, a mindful technology use is important. As with other business management projects and initiatives, it is important to define criteria from the outset to be able to assess *the success of the BCT project*. This initially presents companies with the challenge of defining the target size. The actual state must be recorded as accurately as possible in order to be able to compare it with the target state later. The costs of decentralization in the network have to be determined and compared to the potential benefit of more efficiency or new business models.

Internal organization is the second dimension of strategies. The challenge of *creating acceptance in the company* must not be neglected when it comes to BCT. The fundamental changes in business processes and collaboration in the logistics network require an acceptance of this technology and the associated changes at all business levels. Both operational staff and middle to upper management must support this decision. While, from the management's point of view, it is primarily the strategic positioning in the logistics network and the associated business opportunities that are changing and arising, for the operative employees, it is major changes, up to and including the discontinuation of operative processes, that are changing their daily work. For a successful implementation of BCT projects in logistic networks it is important to *develop the corresponding know-how* internally or to bring it into the organization from outside. First of all, it is important to develop the right mindset in the management level to create an understanding of the technology and thus identify application potentials in the network-internal processes and to push forward corresponding decisions to pursue individual use cases. The next step is to gain essential knowledge of the technology from an information technology point of view in order to be able to implement and code the project. In the final step, the new or changed processes that may result from this must be taught to the operative employees. The *embedding of the project in the logistics network* presents the participating companies with a non-trivial challenge. First of all, it must be clarified which company will take over the central responsibility and control of the project, or to what extent this process can be decentralized. Subsequently, further participations must be clarified and which stakeholders provide which information at which points. This embedding is also very important for the rollout of the final BCT solution. Contact persons must be defined in the individual companies, who report both company and network internally and thus serve as a cross-sectional function between individual companies and the consortium.

Following this, the third challenge dimension is *technology*. *Data migration* is a particular challenge for companies when introducing BCT. Existing data must be consolidated, stored and transferred to the new system before the processes are adapted. In addition, this legacy data must be checked for completeness and possibly updated. This process of data migration is essential for every BCT implementation and should be as automated as possible due to the

large amounts of data that can be expected in the context of logistics. There are several points to consider when *selecting the system* on which the BCT application is based. First of all, an architecture must be selected (see chapter 2.2.1.3). Based on this, possible configurations can be decided upon, which can further limit the choice of the specific platform. Possible configurations include the choice of an open or closed solution or the needed performance / number of expected transactions. Furthermore, additional functionalities such as smart contracts can be used to decide which additional functions the platform service provider will provide, whereby these decisions are to be made depending on budget, schedule and project goals. A desirable target vision of the BCT logistics landscape would be a *standardized solution* for the majority of companies operating in the market. One example, detached from the IT world, is the euro-pallet and the twenty-foot equivalent unit (TEU). With the significantly more complex IT problems, finding a uniform solution is more difficult if not impossible. Due to a multitude of consortia that are currently researching and developing use cases on the basis of different BCT platforms, many different solutions are emerging. A concentration on a uniform solution is not foreseeable. Therefore, it is important to make sure that the own solution always builds upon standards and allows *interoperability* with other BCT solutions, ERP systems and other network-related IT infrastructure. This avoids situations in which, for example, a supplier has to operate several disjunctive BCT solutions because he supplies a large number of OEM. Closely related to the points of data migration and interoperability as well as standardization is the *integration into existing systems*. A large number of legacy systems in the business context of logistics networks make it necessary to integrate the BCT solution into these existing systems and to guarantee a seamless operation in the cooperation of the IT systems. Furthermore, the problem of the quality of data input, known as the *oracle problem*, must be considered from the outset. Although BCT provide a traceable and immutable database of the data stored within the ledger. However, the first step is to verify this data before it is stored in the ledger. In practice, this presents companies with non-trivial problems, which can often only be solved by intensive sensor technology usage and effective consensus algorithms. Furthermore, *collaboration* is an important challenge dimension. As a technology that, in the logistics context, almost always supports use cases of the network and rarely internal company applications, it is essential in this environment to *identify and differentiate the necessary project partners* along the value chain. These can be suppliers and service providers associated with the individual company in the traditional sense. But also, customers can be included as buyers and beneficiaries of transparency gains. In connection with the previously described interoperability and standardization demands of BCT implementations in logistics, it is furthermore of enormous importance to collaborate horizontally with competitors, which initially presents companies with unfamiliar challenges, but in the long run ensures more mature and market-penetrating solutions from which all players can benefit collectively. As described

above, *collaboration with competitors* is of great importance for the success of BCT solutions in the logistics context. Organizing them presents new challenges, especially for traditional companies. Not only the organizational and geographical distance, but also the field of tension of competition requires new forms of organization for a successful project. Clearly defined responsibilities and claims to possible data sovereignty must be clarified, as well as logistical targets that are to be improved with BCT. All partners must be aware of the various possible consequences of a more transparent logistics network and be prepared to adapt operative business processes as well as strategic orientations and business models to the possibly changing framework conditions.

Ultimately, the last challenge dimension is *governance*. Despite all the transparency and traceability of data and transactions in the logistics network, *data privacy and compliance* with existing data protection principles (in the EU, for example, the General Data Protection Regulation GDPR) must not be neglected. Compliance with these must always be observed within the company, between companies and also in the direction of the customer and should be considered from the outset. *Other regulatory challenges* discussed were summarized under this point, as they do not have a major influence on future developments from the point of view of the workshop participants individually and solutions will certainly be found in time, although they are anchored outside corporate responsibility and require political action.

By applying a questionnaire, the challenges identified and clustered in the workshop were subsequently evaluated in terms of complexity during implementation and the expected impact on the success of the project. The challenges with the greatest impact are thus to *create acceptance in the company* and the *technical standardization and interoperability*. Furthermore, as complex assessed is the *identification and evaluation of use cases* as well as the *definition of suitable methods to measure the project success*. The *development of employee know-how* and the *cooperation within the network* are also important pillars for a successful BCT project. The picture of complexity is mixed. While some pressing challenges seem to be relatively easy to solve, the technical challenges, especially *standardization and interoperability*, *integration into existing IT systems* and the *oracle problem* (valid data input), are highly complex to implement. An overview of all challenges and their impact and complexity can be found in Figure 15.

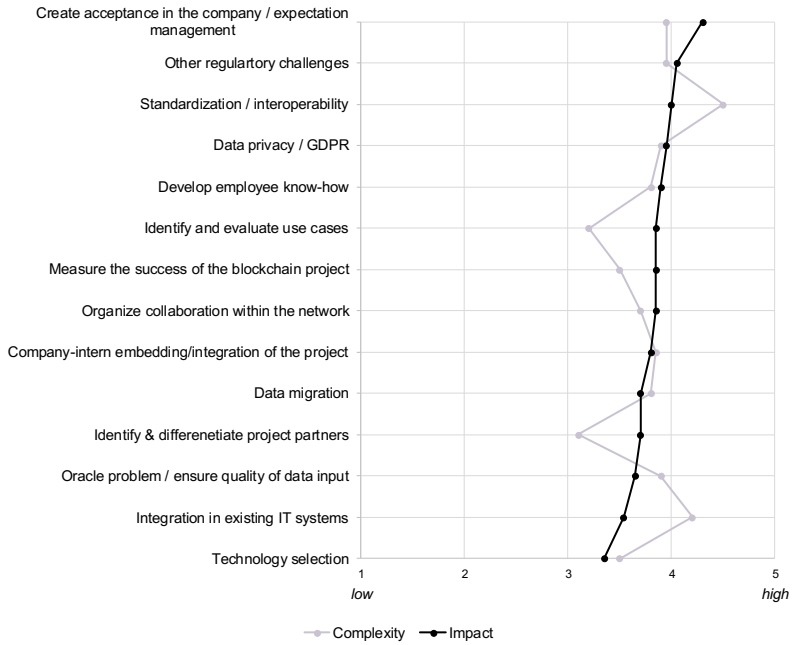

Figure 15: Assessment of challenges for the implementation of BCT in logistics¹⁶²

¹⁶² Own representation

4.2.3 Evaluation of application areas of blockchain technologies in logistics

This section deals with the evaluation of the questionnaire, which was answered by the participants from the industry during the workshop.

Tracking and tracing use cases are characterized by a high suitability for BCT. Here too, it is clear that tracking and tracing is one of the most promising application areas. 40 % of the interviewees indicate that they can imagine a realization of a finished implementation by the end of 2020. Another 45 % expect implementation by 2025. Only 10 % of the participants believe that those use cases will be implemented after 2030 or possibly never. The application status makes it clear that the majority of companies are already working on or planning pilots, but ready implementations are still the exception. Despite this, companies still see a need in the maturity of the use cases and assume a high degree of complexity with 4.20 out of 5.00 on the Likert scale in the implementation due to the network character. The benefit of the application area in the survey results in an average value of 4.00 of a possible 5.00 points on the Likert scale and thus represents the upper reference point in comparison to the other application areas. A summary of the results for the application area tracking and tracing is shown in Figure 16.

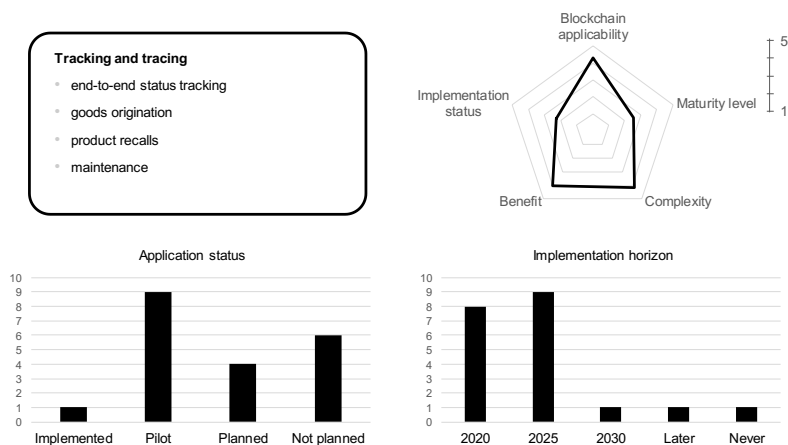

Figure 16: Application area evaluation for tracking and tracing¹⁶³

With an average rating of 4.00 for complexity and an average rating of the expected benefit of 3.65, the application area for *financial operations* is in the middle of the range of applications

¹⁶³ Own representation

examined. There are no final implemented solutions in the group of participants. Only 10 % of the respondents stated that they are working on pilots, while 35 % of the participants have planned corresponding projects. However, the relative majority (55 %) of this workshop stated that they have not planned any BCT projects related to financial operations. In the survey, the implementation horizon for market-ready solutions is concentrated on the years 2025 and 2030. 80 % of the participants can imagine an implementation by 2030 or earlier, while 10 % each assume a later implementation or generally doubt a market-readiness and thus a reasonable BCT applicability. Nevertheless, the BCT applicability is rated with 3.90 of a possible 5.00 points on the Likert scale. This is still a very high value, although the median value in relative comparison with the other application areas. A summary of the results for the application area financial operations is shown in Figure 17.

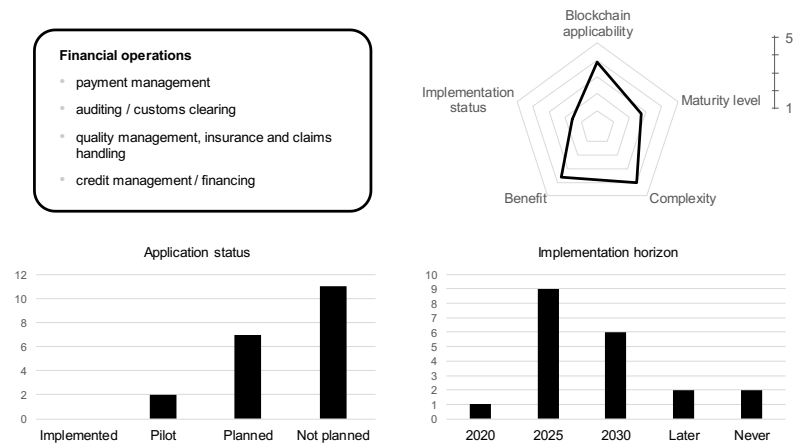

Figure 17: Application area evaluation for financial operations¹⁶⁴

¹⁶⁴ Own representation

The application area *verification and certification* stands out due to its relatively high maturity level of 2.80. In comparison to other application areas, this puts it in first place. The participants of the workshop further rated the expected benefit with 3.95. This is the second highest value after tracking and tracing. With an average complexity rating of 3.70, these application areas seem to be the ones with the lowest implementation hurdles. The BCT applicability of 4.30 also speaks for the implementation of this application area in the context of logistics. This is also reflected in the survey results for the application status. 55 % of the respondents state that they are already working on pilots or have planned corresponding BCT projects in their logistics. Among the participants there was also an indication of one already implemented project. Correspondingly, the implementation horizon shows that implementation is expected to be completed in the near future. 10 % of the respondents stated that implementation will be ready for the market in 2020. A further 65 % expect it to be implemented by 2025, and another 15 % expect it to be implemented by 2030 at the latest. Only 10 % assume that corresponding use cases will only reach market maturity later or never. A summary of the results for the application area *verification and certification* is shown in Figure 18.

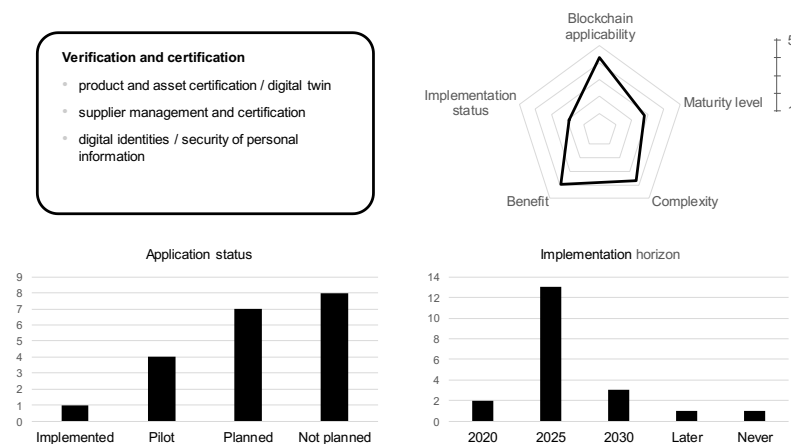

Figure 18: Application area evaluation for verification and certification¹⁶⁵

¹⁶⁵ Own representation

The relatively low diversity of use cases in the application area *planning and network* is reflected in the average maturity level stated in the survey. With a value of 2.10 on the Likert scale, this is the lowest among the application areas examined. BCT applicability and expected benefit are high values of 3.55 and 3.35 on their own, but they are at the bottom of the relative comparison within the survey. The evaluated degree of complexity is high with 4.10 of a possible 5.00 points on the Likert scale. The application status is comparatively restrained. Only 20 % of the companies stated that they were already working on pilots. Another 10 % have planned activities in this direction. However, the majority of respondents (70 %) stated that they had not planned any BCT projects related to planning and network. This trend is reflected in the implementation horizon. Although 45 % of the respondents expect the implementation of corresponding use cases by 2025, the majority of companies expect implementation until 2030, later, or in some cases never. A summary of the results for the application area planning and network is shown in Figure 19.

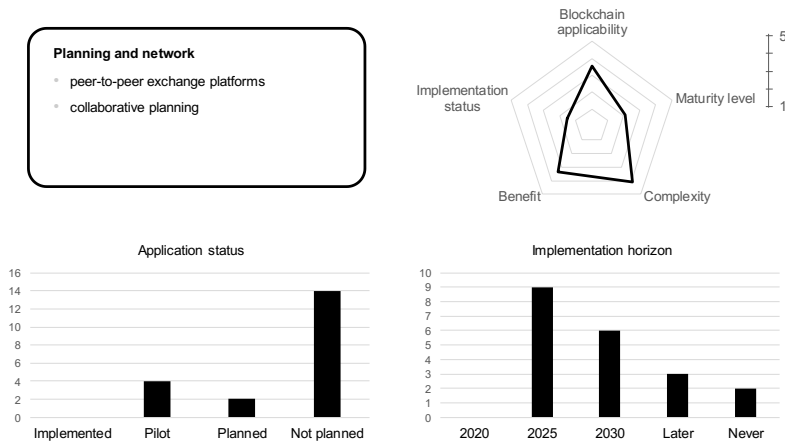

Figure 19: Application area evaluation for planning and network¹⁶⁶

¹⁶⁶ Own representation

With a BCT applicability of 3.85, the application area *automation and IoT* is also characterized as relatively suitable for the application of the technology although this is the second lowest value. The maturity level corresponding to this can be rated as average with 2.45 of a possible 5.00 points on the Likert scale. The respondent participants continue to estimate a rather high expected benefit of 3.60 out of 5.00. The application area has some implementation hurdles and the complexity was rated relatively high with an average of 4.20. Interestingly, however, 25 % of the companies state that they have already developed pilots. Another 25 % have planned corresponding BCT projects with a focus on automation or IoT. The other half of the respondents have no plans to do so at this time. The implementation horizon shows an expected rapid implementation. 70 % of those surveyed expect it to be implemented by 2025, 15 % by 2030, and the remaining 15 % expect it to be implemented after 2030 or never. Nobody expects market maturity by 2020. A summary of the results for the application area automation and IoT is shown in Figure 20.

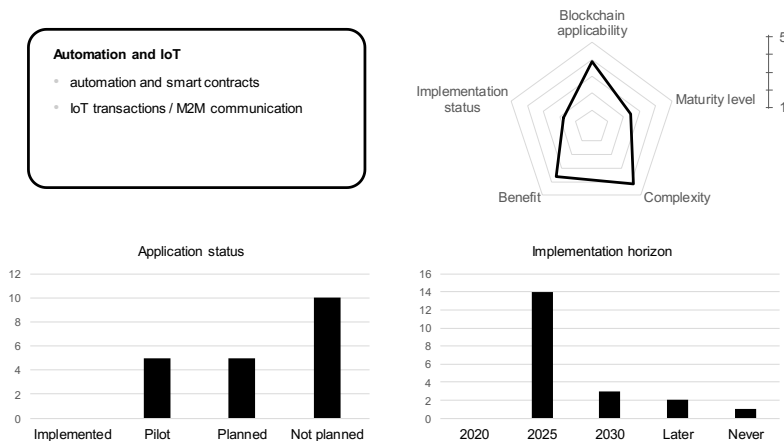

Figure 20: Application area evaluation for automation and IoT¹⁶⁷

¹⁶⁷ Own representation

4.2.4 Applicability limitations of blockchain technologies in logistics

Despite the large potential BCT offers for international logistics networks, the technology has limitations that hamper possible implementations in an industrial context or leave the technology unsuitable for the respective purpose. In the following, both technological and organizational limitations and boundaries of BCT are discussed in the context of logistics. These limitations are often the reason why companies are hesitant to venture BCT implementations or abandon them after pilot developments and consider them inadequate for their own logistics network. The results from this chapter will later be incorporated in the first phase of the management model in chapter 4.5.

Unlike for instance ERP systems, BCT systems do not currently technologically enable cross-platform compatibility and standardization due to different BCT types and mechanisms. The build-up of data silos and insufficient integration capability of different individual BCT networks are the result of this lack of interoperability and thus restrict communication across system boundaries.¹⁶⁸ Because BCT are often used across organizations as a common data structure, the technology serves as a single-point-of-truth about states and ownership. Implemented as a stand-alone application, interfaces to other enterprise applications are often not yet possible. The consequences are increased costs for developing customized interfaces and the organizational challenge of potentially multiple parallel BCT within an enterprise, each with its own standards, logic and interface requirements. However, associations and enterprises are working to develop appropriate standards for improved interoperability between BCT themselves and to other systems.¹⁶⁹ Another limitation is the lack of scalability, which is why the number of concurrent transactions is limited. Classic proof of work consensus mechanisms are time consuming. For example, with Ethereum, it is possible to store a new block of 50-150 transactions every 15 seconds. Accordingly, the transaction speed on Ethereum is 15 transactions per second. Thus, it takes several seconds to minutes (in rare extreme cases, the latency can be several hours) until a transaction is stored in the blockchain. As the number of users increases, the system thus becomes slower and can only be scaled to a limited extent. Real-time applications are therefore hampered and the number of transactions to be processed per unit of time is limited. Thus, when developing prototypical applications, the future solution and the corresponding requirements in terms of the number of users and transactions should already be considered.¹⁷⁰ While developments such as DAG promise more scalable solutions in the field of DLT, the practical applicability of these has not yet been proven

¹⁶⁸ Cf. Iredale (2020) p. 1.

¹⁶⁹ Cf. Wittenberg (2020) pp. 114–115.

¹⁷⁰ Cf. Wittenberg (2020) pp. 110–111.

in a real-world scenario.¹⁷¹ The often cited high energy consumption of inefficient consensus mechanisms such as proof of work in Bitcoin, on the other hand, can be solved by permissioned or private networks as well as more efficient consensus mechanisms.¹⁷² Although BCT are technologically very secure and difficult to attack, some unlikely scenarios exist that can compromise the security of the network. These include 51 % attacks, where a potential attacker combines more than 50 % of the network's computing capacity. Furthermore, denial of service attacks are conceivable due to a large number of waste transactions, which can reduce the transaction speed or bring the system to a halt. However, cracking the cryptographic algorithms of the BCT itself does not seem to be possible at this point of time (the interested reader is referred to Malik et al. (2019) for a more detailed description of the possible attacks on a BCT network).¹⁷³ In contrast to conventional software systems, BCT do not have a central authority responsible for operation, which means that there is only limited support and a low update capability. Where maintenance contracts from the provider would otherwise apply, majority decisions are required to change the software code in BCT systems and the new code must then be rolled out to all participants, which can take a lot of time until the update is finally completed. However, not only security vulnerabilities, but also the implementation of new functionalities requires the described procedure, which leads to long development times until implementation. From a company perspective, this can be solved by central operation of BCT, but this in turn entails other disadvantages of central systems.¹⁷⁴ In addition, BCT systems can only be implemented in logistics networks that already fulfill a certain degree of digitalization. The interface to the physical world must first exist or the physical world itself must be digitized before reasonable BCT solutions can be implemented.¹⁷⁵

BCT also pose a number of organizational challenges for companies and have some limitations in terms of their requirements and applicability. For example, implementing BCT within corporate boundaries is not reasonable and storing transactions within a company without external stakeholder participation in the BCT is an excessive effort. Promising use cases therefore involve a large number of stakeholders, which in many cases requires a decentralized governance to coordinate the development and operation of BCT.¹⁷⁶ The absence of central instances as an important feature of BCT is often cited as an advantage. However, in addition to efficiency gains, this may also lead to a lack of responsibilities that must be in place according to existing national or international legislation. For example, based

¹⁷¹ Cf. Vieira et al. (2020) p. 1566.

¹⁷² Cf. Iredale (2020) p. 1.

¹⁷³ Cf. Malik et al. (2019) p. 1102.

¹⁷⁴ Cf. Wittenberg (2020) pp. 115–116.

¹⁷⁵ Cf. Twenhöven/Petersen (2019) p. 462.

¹⁷⁶ Cf. Ludwig/Stróżyńska (2020) p. 452; van Rijmenam (2019) p. 1.

on EU law, German legislators, among others, require a responsible entity when processing personal data as well as a data protection officer. In private blockchains, this is usually not a problem. A public blockchain, however, makes it difficult to identify such a responsible entity. When using the Ethereum blockchain, for instance, the necessary technical means and sanctioning options to prevent the (permanent) storage or deletion of personal data within the network are not available for companies.¹⁷⁷ Therefore it can be challenging to apply BCT in highly regulated industries as it is difficult to customize the technological solution to the existing regulatory infrastructure.¹⁷⁸ The decentralized nature of BCT requires private keys for individual users, for which they are subsequently responsible. This distributed responsibility is a major risk and represents a disadvantage of BCT. While a centralized authority can be created as a workaround, this again weakens the decentralized character of the BCT system.¹⁷⁹ Thus, if business-critical data is encrypted using private keys, the lack of key recovery in the event of a possible loss must be considered. In enterprise BCT systems, this problem has been partially solved by assigning identities and keys via special nodes (e.g. Membership Service Provider when using Hyperledger Fabric). However, as described, this is at the expense of security and decentralization.¹⁸⁰ The functionality of data immutability, which is also described as an advantage, can also be a disadvantage when it comes to the immutability of incorrect data. For example, incorrect transactions can neither be deleted nor modified after they have been saved. Therefore, a new transaction must be executed in the opposite direction to correct the data. In practice, problems arise here particularly with the storage of personal data and the right to be forgotten that applies in the EU, and thus the deletion of this data.¹⁸¹ From an economic perspective, the development and operation of BCT leads to costs. Redundant infrastructure initially results in increased acquisition costs. However, the operating costs for running consensus mechanisms, power and maintenance also multiply with the number of nodes in the network. In addition, transaction fees are charged in many systems for the purpose of generating new blocks, which may, however, be eliminated in private enterprise blockchains.¹⁸² Nevertheless, logistics costs on the operational and tactical level might decrease due to efficiency improvements through BCT (see chapter 5.2). In order to assess the economic viability of BCT systems, the costs incurred have to be compared with the benefits achieved in each individual case. On the cost side, there are one-time costs (including those for the development and procurement of hardware and software),

¹⁷⁷ Cf. Wittenberg (2020) p. 113.

¹⁷⁸ Cf. Witt (2019) p. 1.

¹⁷⁹ Cf. Iredale (2020) p. 1.

¹⁸⁰ Cf. Wittenberg (2020) pp. 113–114.

¹⁸¹ Cf. Wittenberg (2020) p. 112.

¹⁸² Cf. Wittenberg (2020) pp. 111–112.

as well as ongoing costs for maintenance and operation (including the operation of nodes, transaction costs, support and service, training of employees as well as modification and update development). In addition, in the sense of considering the entire life cycle, costs may possibly be incurred for a rollback in order to back up data and migrate it to possibly new systems. Benefits, in contrast, can exist on the one hand through direct revenues such as transaction fees, licenses and fees for new members. Furthermore, there are monetary benefits (e.g. reduction of process times through automation via BCT) as well as non-monetary benefits (e.g. increased transparency and customer confidence). In a utility analysis approach, BCT systems can thus be compared and evaluated with each other and in contrast to other solutions.¹⁸³ Transparency regarding transactions and their content is a basic principle and part of the security concept of public BCT. This can be a problem for companies when confidential operational information is exchanged. Even though plain names are not usually stored in the BCT, in the event of a leak or data analysis, all of a company's transactions could be mapped and thus information on suppliers, purchase prices or the like could become public. By now, however, publicly available content can be distinguished from confidential content in permissioned BCT, or procedures such as zero-knowledge-proof can be introduced, in which the respective actors involved in a transaction have the possibility to prove certain facts without viewing the content of the transaction.¹⁸⁴ Ultimately, BCT present companies with the challenge of deriving potential for themselves from the unique properties of the technology. The existing uncertainties regarding the technical functionalities and organizational requirements for successful BCT implementations often lead to an ill-considered adaptation of the technology and thus to unsuitable use cases. Other alternative (centralized) implementation options are thereby neglected and false expectations, lack of technological knowledge and uncertainties regarding the application potential lead to misguided adoption decisions when often centralized actors could take over the trust and transparency function and thus a more efficient and cost effective solution would be possible when decentralized solutions are not necessary.¹⁸⁵ This topic of mindful technology adoption will be considered in detail in the upcoming chapter.

4.2.5 Mindful technology adoption of blockchain technologies in logistics

Especially the application of new technologies in logistics requires a high degree of mindfulness and a balancing of business requirements with technological features (in this case

¹⁸³ Cf. Wittenberg (2020) pp. 137–146.

¹⁸⁴ Cf. Wittenberg (2020) pp. 116–117.

¹⁸⁵ Cf. Verhoeven et al. (2018) p. 1.

BCT). This chapter describes a model for evaluating the mindful use of BCT in logistics based on previous research published in Verhoeven et al (2018).¹⁸⁶ The model described later within this chapter was developed from literature in the aforementioned paper and will be incorporated into the results of this thesis.

In the context of technology implementation, especially at the beginning of the exploration of a new technology and its potentials for different application areas, excessive expectations and overestimated benefits and attributes have to be avoided. These expectations, coupled with rash, inappropriate implementations for problems that do not fit the technology, inevitably lead to avoidable costs and efforts. Therefore, in the context of technology implementations, it is important to proceed mindfully and first understand the problem and the unique features of the technologies under consideration in order to derive an effective and cost-efficient decision.¹⁸⁷ In the case of BCT, unique features of the technology result from the decentralization itself. These include, among others, increased transparency in the logistics network, data privacy and security, immutability and better traceability through the transaction history. Mindfulness, on the other hand, is based on various factors that can be used to assess whether a technology adoption is objectively reasonable and appropriate. For this, it is necessary to evaluate information regarding the technology and, above all, to know and compare alternatives. The term mindfulness originated in psychology and refers to the ability of an individual to process information and to be aware of his or her decisions and different perspectives. Furthermore, mindfulness influences performance during a task and is at the same time dependent on the environment of the task and the expertise of the individual. This concept can of course also be applied to organizations. Thus, it can be stated that mindfulness is of high importance in avoiding mistakes. In contrast to this is mindlessness, which can be observed in organizations that do not pay much attention to developments in the field of information technology and do not value IT as a distinctive competence. In practice, this often leads to vanilla versions of the technology being implemented without considering individual requirements or the context.¹⁸⁸

The authors propose a model to evaluate the mindful use of BCT use cases in logistics as shown in Figure 21.

¹⁸⁶ Cf. Verhoeven et al. (2018) p. 1.

¹⁸⁷ Cf. Verhoeven et al. (2018) p. 1.

¹⁸⁸ Cf. Verhoeven et al. (2018) pp. 2–4.

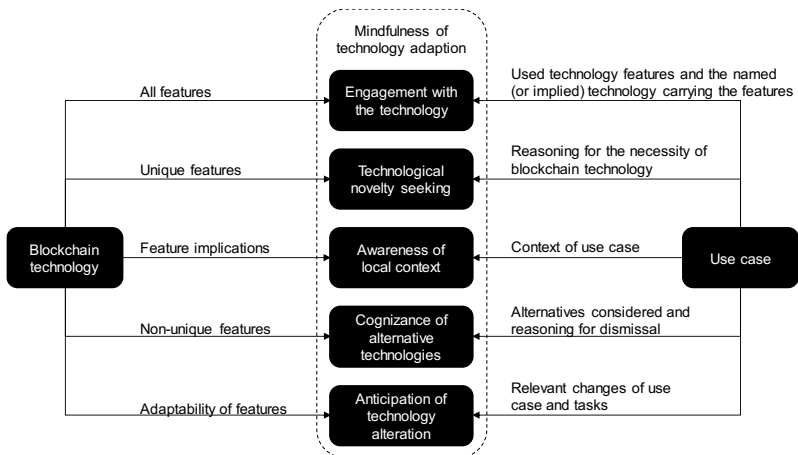

Figure 21: Mindful adoption model for BCT in logistics¹⁸⁹

The five mindful adoption principles used in the model are explained in Table 27 (the interested reader is referred to Verhoeven et al. (2018) for a more detailed description of the principles and the development of the model).

¹⁸⁹ Cf. Verhoeven et al. (2018) p. 6.

Mindful adoption principles	Explanation
Engagement with the technology	Due to information gathering and the exploration of details, functionalities and feature of the technology should be known thoroughly following a comprehensive technology understanding.
Technological novelty seeking	The technology should be compared to other competing technologies in order to identify the unique feature this technology has to offer for the use case.
Awareness of local context	The technical environment, the local specifics (e.g. local needs, learning abilities, technical support, compatibility with implemented technologies and possible reactions of different stakeholder to the novel technology) should be considered as well as the corresponding consequences of the new technology.
Cognizance of alternative technologies	The new technology should be compared to other existing technologies and the advantages and disadvantages should be elaborated. Realistic expectations and critical conclusions should be drawn from the results
Anticipation of technology alteration	There should be awareness for possible changes of the task, for which the technology is utilized for and how the technology can or cannot be adapted to those changes.

Table 27: Mindful adoption principles¹⁹⁰

Both primary and secondary sources can be used to evaluate these principles. The authors recommend a joint discussion of the use cases and sources by at least three researchers so that the use cases can then be qualitatively examined for mindful use of BCT using the criteria described above.

¹⁹⁰ Cf. Verhoeven et al. (2018) pp. 4–5.

The case discussion of five exemplary use cases conducted in the paper leads to the conclusion that there are large differences in the implementation of BCT use cases in international logistics networks. While in some cases, based on the secondary literature, it can be assumed that BCT were applied according to the five principles mindful, some cases show considerable gaps and suggest that only the hype of technology was pursued instead of using the rationally more appropriate classical technology. The BCT offers great potential for more transparency, trust and sustainability in international logistics networks. Nevertheless, a mindful use of this technology is of great importance. The results show the partly big differences in the approach to the implementation of BCT use cases. Even if it seems tempting to apply the hyped BCT to all problems at first, it is of great importance for a successful project to first fully understand the problem in order to then find the right and appropriate technology to solve it.

In summary, the fit between task and technology is of great importance for the success of relevant implementations of BCT in logistics and promised potentials of these technologies can only be realized if they are applied to suitable problems, which use and leverage the features of the technology appropriately. The mindful adoption model for BCT in logistics described here will be applied later in the thesis as part of phase two of the management model in chapter 4.5.

4.2.6 Interim conclusion on blockchain technologies in logistics

This chapter has focused on the current scientific and practical findings on BCT in logistics. The literature-based analysis of possible applications of BCT in logistics yielded in five application areas (*tracking & tracing, financial operations, verification & certification, planning & network* as well as *automation & IoT*) after conducting the Q-methodology to cluster the results, whose potential and status-quo were evaluated through a survey. It is apparent that implementations have already been carried out or pilot applications are being tested with pilot applications, particularly in the areas of *tracking and tracing* and *verification and certification*. In addition, according to the assessment of the participants, these two application areas are especially applicable for the development of BCT systems and are characterized by a high degree of maturity of the respective applications. The challenges identified in the workshop and subsequently assessed through a survey can be assigned to five dimensions (*strategy, internal organization, collaboration, technology* as well as *governance*). Based on these results, it is initially a challenge to identify potential use cases and to make the project success measurable and establish acceptance in the organization. Further challenges in the implementation of BC solutions lie in the lack of cross-platform compatibility and

standardization of current systems as well as the integration of these into existing IT systems. The integrity of the interface to the physical world must also be ensured in order to solve the problem that data to be stored must first be validated and checked for consistency (oracle problem). In organizational terms, the technology presents logistics networks with the challenge of involving a large number of players for meaningful use cases, which in many cases requires decentralized governance. These dimensions, with the exception of the governance/regulatory dimension, will be the basis for the management areas, which are part of phase four of the overarching management model for social and environmental impact in logistics through BCT to be developed in chapter 4.4.2. Apart from the large number of possible applications and implementation challenges of BCT in logistics, companies are also confronted with technological and organizational limitations of the technology. In addition to the low level of standardization and interoperability, difficulties with scaling, a lack of responsibility due to decentralization, and data protection problems are hurdles for companies on the path to successful BCT implementations. Ultimately, the studies on mindfulness show the importance of the task-technology fit, as companies are faced with the challenge of deriving potential for themselves and driving forward concrete implementations despite the large number of possible applications. On the one hand, there are major uncertainties regarding the technical functionalities and organizational prerequisites for successful BCT implementations, which in technology-driven markets lead to the rash adaptation of the technology and thus to unsuitable use cases.

Now that a basic understanding of the technology has been established and the challenges and potential areas of application of BCT in international logistics networks have been discussed, the following chapter examines the social and environmental impacts that can be achieved by this technology among various stakeholders. As described earlier, the sustainable focus here is on the social and environmental dimensions as key drivers for the future development of international logistics networks.

4.3 Phase 3: sustainability impact model for blockchain technologies in logistics

After discussing the technological basics, relevant functionalities and possible areas of application in logistics in the previous chapter, this chapter is dedicated to the development of the proposed sustainability impact model for BCT in logistics. Therefore, a follow-up workshop with industry experts was held to discuss sustainability potentials in three different logistics networks as described in chapter 3.2. The results from this workshop are enriched with literature-based insights and used to develop the impact model in the further course of this chapter. This impact model is intended to support managers in identifying and actively managing potential sustainable changes within logistics networks. On the level of individual stakeholders from raw material suppliers to end customers, potentials are identified and the impact direction for the future design of sustainable international logistics networks using BCT is given. The sustainability impact model will further play a key role in phase three of the management model for social and environmental impact in logistics through BCT. From this point of the thesis, the consideration of BCT applications focuses on application areas related to environmental or social sustainability (see chapter 4.2.1). For this purpose, various logistics networks and related use cases with sustainability relevance will first be discussed in a workshop as described above. In the following chapter, these findings will be complemented by case studies in the same subject domain.

4.3.1 Stakeholders and sustainability impact dimensions of blockchain technologies in logistics

This chapter summarizes the results of the second workshop (see chapter 3.2). Initially, a division into stakeholder and impact dimensions is made. In the following, the results are summarized, further differentiated and finally the sustainability impact model for BCT in logistics is developed.

The identified stakeholders of the three representative and discussed use cases were systematized according to their arrangement within their logistics networks in order to identify a general overview of involved actors of the different networks that are influenced in their sustainability by a BCT implementation. This results in the stages of the logistics network and the corresponding exemplary stakeholders shown in Table 28. In each case, an assumed network structure, as abstractly represented in Figure 22, is the foundation.

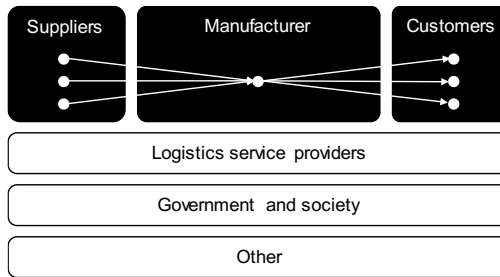

Figure 22: Assumed network structure¹⁹¹

The stakeholders identified in the workshop and affected by a BCT implementation cover the entire international logistics network. The focus is on the manufacturer, which is supplied by one or more suppliers. These suppliers can either be the manufacturer's component suppliers directly or they can affect further network levels below. Besides the raw materials suppliers (e.g. coffee farmers or mineral miners), these include processing companies. The manufacturing companies and suppliers are supported by logistics service providers, which cover a wide range of services in international logistics networks. These include transporters, distributors, recyclers and technology providers. An important role in BCT implementations is played by the customers, for whom the benefits achieved are directly visible and should serve as a competitive advantage. Also relevant for success and indispensable as stakeholders are public institutions, i.e. government and society. These include public authorities and NGO as well as auditors. In addition, other actors play an important role, such as academia and consulting.

¹⁹¹ Own representation

Stage	Exemplary stakeholders
Manufacturer	OEM, producers
Supplier	Raw material suppliers, processors, component suppliers
Logistics service provider	Transporters, distributors, recyclers, technology providers
Customer	End-customers, wholesale, retailers
Government and society	Public authorities, NGO, auditors

Table 28: Identified stakeholders¹⁹²

Each of the stakeholders described above can be impacted in different ways by BCT in terms of social and environmental sustainability. The three main dimensions are shown in Figure 23.

Therefore, it can be distinguished between:

- private vs. public initiator
- direct vs. indirect sustainability impact
- improvement of existing process vs. new processes and business models

¹⁹² Own representation

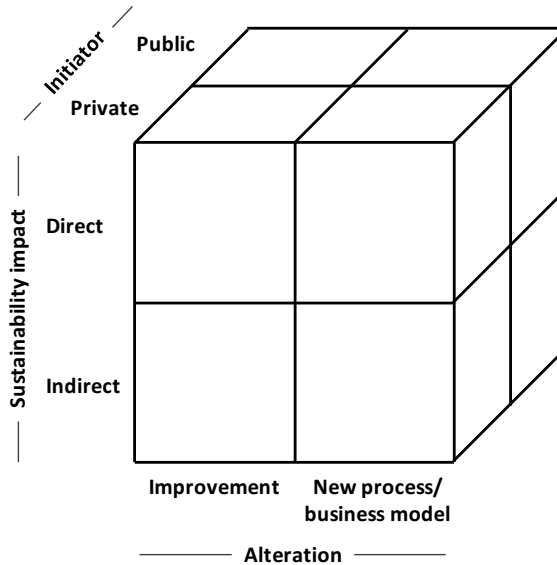

Figure 23: Sustainability impact dimensions¹⁹³

First, it can be distinguished whether the initiative to implement BCT for specific networks or processes comes from the private sector or the public sector. Public initiatives are usually initiated by governments and other public institutions to shape public processes that may affect businesses and citizens (customers). These include fighting corruption, creating digital identities or improving the efficiency of administrative processes. Furthermore, BCT projects initiated by public initiators can also intervene directly in company or network internal processes to regulate them. In contrast, privately initiated BCT initiatives include all company-relevant projects that take place within the logistics network and therefore only affect internal stakeholders. Examples are the tracking and tracing of products in the network or the certification of suppliers.

The second dimension distinguishes whether the impact on the sustainability of the logistics network is direct or indirect. A direct impact is understood to imply that the sustainability (social or environmental) is immediately affected. With regard to the social dimension, this could mean that working conditions at raw material suppliers in developing countries improve, with regard to the environmental dimension, a direct impact would be the reduction of greenhouse gases

¹⁹³ Own representation

on the transport routes between the network actors. An indirect impact on the sustainability of a company or a network exists if it is only mediately influenced by the BCT implementation. This, in turn, can mean that the technology makes it possible, for example, to make processes more transparent in order to uncover and, on this basis, improve deficiencies or to compile, measure and report key sustainability indicators.

The third dimension of the model ultimately differentiates whether the transformation through BCT is (merely) an improvement of an existing process or a completely new process or even a business model, which is only made possible through the use of the decentralized BCT. The former could be, for example, an improved payment processing to raw material suppliers, where traditional payment providers and intermediaries are no longer needed and fair payment to suppliers can be processed transparently. A new business model in this context could be understood as a supplier or product certification that is only possible through BCT.

This results in the model as shown in Figure 23 (see above), exemplarily shown as a three-dimensional cube. In any case, all three dimensions have an effect on the stakeholders and must be considered as a whole.

4.3.2 Development of the sustainability impact model for blockchain technologies in logistics

The two previously identified constructs stakeholders and impact dimensions will now be merged and supplemented by further findings from the workshop.

These contain deeper insights into the expected impacts at stakeholder level in the dimensions of environmental and social sustainability. The basic structure of the sustainability impact model for BCT in international logistics networks is shown in Figure 24 and complemented by the content shown in Table 29, Table 30, Table 31, Table 32 and Table 33. It shows the interrelation of all three dimensions of the impact layer (see chapter 4.3.1) on the stakeholder layer which contains all relevant stakeholders identified in the workshop of the network (see chapter 4.3.1). It is important to note that although changes are discussed individually at stakeholder level, the impact achieved can only be realized if BCT projects are planned and implemented across all actors and end-to-end. The impact is further supported by a set of enablers that are inherent to BCT. The top five technology enablers based on the BCT functionalities with an impact on social and environmental sustainability are *decentralization*, *immutable data*, *transparency*, *security* as well as *smart contracts*.

For reasons of presentation and clarity, the model is divided into figures and tables. The tables for the individual stakeholders are presented below. For each stakeholder, in addition to the expected social and environmental impact by BCT, success factors and enablers were

developed, which are necessary to successfully achieve the respective impact at stakeholder level. The possibilities for social and environmental impact at stakeholder level described in the tables are to be understood as qualitative parameters against which the expected impact can be estimated and the sustainability goals achieved can be measured at a subsequent stage.

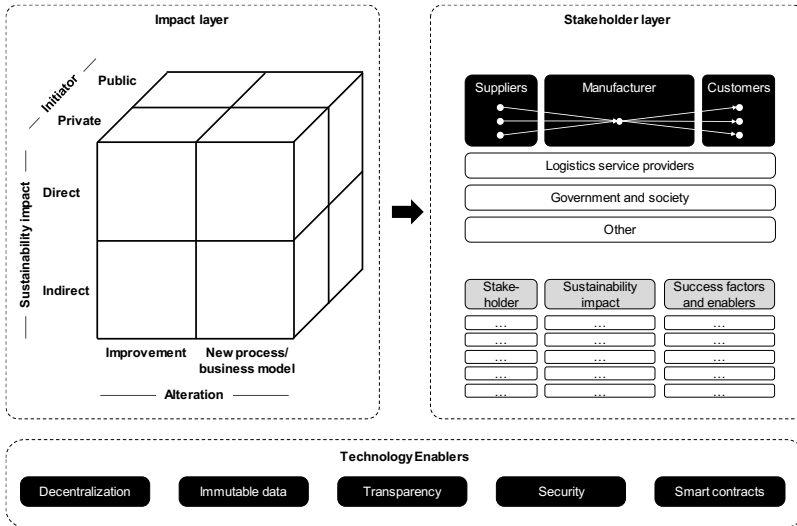

Figure 24: Sustainability impact model for BCT in logistics¹⁹⁴

For *manufacturers*, the main impact can be described as ensuring the code of conduct within the entire logistics network. Thus, through the use of BCT, values and behaviors agreed upon in the network and often communicated by the producer to the customer can be guaranteed. As a responsible manufacturer applying BCT, human rights violation in the own logistics network, especially in developing countries, can therefore be ruled out due to the enhanced transparency regarding the origin o received goods and services and the corresponding working conditions.¹⁹⁵ Other points include insights into the behavior of suppliers and service providers as manufacturers as well as other stakeholders profit from more transparency throughout the network. Furthermore, the compliance with guidelines, regulations and standards can be ensured by proving the necessary data tracked along the entire logistics network that is needed to comply with the OECD, emission guidelines or other regulations with

¹⁹⁴ Own representation

¹⁹⁵ Cf. Kshetri (2021) p. 11.

regard to the import of conflict materials. In the environmental context BCT enable manufacturers to track the amount and source of emissions, waste and other toxic pollutants from the raw-material supplier until the end customer in order to take the necessary steps to avoid these.¹⁹⁶ Ultimately, BCT can be used to transparently collect and secure information about a product along its entire lifecycle. This product-related information can be used by the manufacturer in the after-market to offer further customer-specific services. For a successful achievement of this impact for manufacturers, customer acceptance is of great of great importance. In this context, it is up to the producer to provide the customer with an awareness of the advantages of the technology and the associated benefits in relation to more ecological or social products. Considering the fact that sustainability is a major trend in many markets and customer demand for more sustainable products and services should be met accordingly, it is an important enabler if BCT can be used to give logistics networks a demonstrably more sustainable competitive advantage. In addition, public pressure from customers and governments, as well as corresponding regulations and guidelines, support the implementation of BCT by manufacturers. The social and environmental impact as well as success factors and enablers as derived from the workshop for *manufacturers* are shown in Table 29.

Manufacturers	
Social and environmental impact	Success factors and enablers
<ul style="list-style-type: none"> • Ensure that code of conduct is passed down the logistics network and complied with when sourcing new partners • Ensure and track compliance with OECD and emission guidelines and legal requirements (e.g. EU regulation with regard to conflict materials) • No human rights violations within own logistics network • Get insights on the behavior of suppliers and service providers • Utilize information on assets in the after-market 	<ul style="list-style-type: none"> • Acceptance by end customer / market • Competitive advantage • Public pressure • Regulations and governmental strategic guidelines and initiatives

Table 29: Sustainability impact for manufacturers¹⁹⁷

¹⁹⁶ Cf. Park/Li (2021) p. 7.

¹⁹⁷ Own representation

The next stakeholder category that was considered is *suppliers*. This includes raw material suppliers as well as subsequent tiers that ultimately supply the manufacturer. The most important impact here is the compliance with human rights and an improved work environment as transparency throughout the logistics network to the end customer, motivates manufacturers to buy from more sustainable suppliers with more socially responsible working conditions.¹⁹⁸ This results in more qualified jobs in the local companies and a fair and stable payment can be guaranteed. By removing intermediaries through BCT, higher margins are also possible for suppliers (e.g. margins for payment providers might no longer be necessary as financial transaction can be processed P2P). The transparency and data quality also give suppliers the opportunity to substantiate arguments in the direction of other stakeholders with the help of data and to use them as a competitive advantage. BCT furthermore enable an informed decision making based on accurate and trustworthy data in the entire logistics network. This again results in forecast and efficiency improvements as not only data from direct peers can be viewed in the ledger, but also across stages within the network (depending on the BCT setup). Taking a look at success factors and enablers, local education programs are of great importance to create an awareness and understanding of BCT at the supplier side. As especially raw materials suppliers are often located in developing countries (e.g. coffee in Ethiopia, tin in Rwanda or cobalt in the Democratic Republic of Congo) stable stakeholder relations with manufacturers in developed countries and the sharing and implementation of best practices are needed to achieve successful implementations of BCT. This also includes explaining the benefits of the technology in order to create acceptance and, if necessary, providing financial support for the procurement of hardware and software. Together with governmental support those stakeholder relations help suppliers to manage the complexity when adopting BCT. The social and environmental impact as well as success factors and enablers as derived from the workshop for stakeholder level *supplier* are shown in Table 30.

¹⁹⁸ Cf. Park/Li (2021) p. 8.

Suppliers

Social and environmental impact	Success factors and enablers
<ul style="list-style-type: none"> • Compliance with human rights (e.g. no child labor) • Better work environment • New and higher educated jobs • Stable and fair payment as well as higher margin by removing intermediaries • Awareness about product quality and therefore better arguments towards other stakeholders • Governance competence • Forecast and efficiency improvements • Social and environmentally friendly products as competitive advantage • Enabling informed decision making 	<ul style="list-style-type: none"> • Local education programs • Stable stakeholder relations • Have to see the benefit • Governmental support • Validity and quality of data • Quick adoption to standards • Share and implement best practices • Management of complexity • Financial support • Hardware infrastructure

Table 30: Sustainability impact for suppliers¹⁹⁹

For BCT implementations, the *customer* as an important stakeholder must not be disregarded. By increasing transparency and trust in the data, customers get the possibility of sustainable consumption.²⁰⁰ Transparent tracking provides end customers with insights into product origins as well as information about the social and environmental footprint of the product on offer. BCT also increase the trust in labels that assure sustainable product origin or production as data can hardly be manipulated due to the distributed and transparent nature of the technology. While this customer perspective has no direct impact on the social or environmental sustainability of logistics networks, it can be seen as an extrinsic motivation for manufactures to guarantee a high level of sustainability through BCT in order to gain market shares for sustainable products and services in case customers of the logistics network are traceability aware and demand transparency on products and services.²⁰¹ To achieve this, it is necessary that the customer, in addition to the basic willingness to consume sustainable products and

¹⁹⁹ Own representation

²⁰⁰ Cf. Kshetri (2021) p. 11.

²⁰¹ Cf. Fan et al. (2020) p. 17.

services, has trust in the technology itself and is provided with user-friendly interfaces to access the information. The social and environmental impact as well as success factors and enablers as derived from the workshop for stakeholder level *customer* are shown in Table 31.

Customers	
Social and environmental impact	Success factors and enablers
<ul style="list-style-type: none"> • Ability to reliably consume sustainable products and services • Gain trust in packaging and logistics labels (e.g. product origin or CO2 foot print) • Transparency regarding the consumed products 	<ul style="list-style-type: none"> • Trust in technology • Convenient interface to access product information • Motivation to consume sustainable

Table 31: Sustainability impact for customers²⁰²

In addition to suppliers and manufacturers themselves, *LSP* play a key role in the international logistics network and guarantee the flow of materials, information and finance. Through BCT, they have the opportunity to gain transparency and the associated efficiency and to make more accurate forecasts, which means that capacities can be better utilized. These better utilized capacities can not only lead to economic benefits, but also enable more environmentally friendly logistics services as a higher capacity load leads to fewer trips and therefore a smaller emission footprint. Furthermore, circular production loops and economies are conceivable with higher recycling rates through more product and historical information.²⁰³ Similar to manufacturers, after-market services based on data stored in the blockchain thus become possible. A closer look at success factors and enablers reveals that in the *LSP* industry it is particularly important to collaborate with competitors in order to achieve a high market penetration and to implement relevant application scenarios. Furthermore, complexity needs to be managed (see stakeholder level supplier above) and quick adoption standards within the network enable a successful implementation of BCT. The social and environmental impact as well as success factors and enablers as derived from the workshop for stakeholder level *LSP* are shown in Table 32.

²⁰² Own representation

²⁰³ Cf. Khanfar et al. (2021) p. 11; Upadhyaya et al. (2021) pp. 4–6.

Logistics service providers

Social and environmental impact	Success factors and enablers
<ul style="list-style-type: none"> • Growing circular loops and economies • Transparency of goods increases forecasting quality and leads to efficiency gains • Increased recycling rates • Improve lead times in cross-border business 	<ul style="list-style-type: none"> • Collaboration with competitors • Quick adoption standards • Management of complexity

Table 32: Sustainability impact for LSP²⁰⁴

Finally, *governments and society* have been considered as stakeholders. They can ensure compliance with their own guidelines and regulations and to achieve transparency gains by pushing companies to more sustainable practices. In addition, the technologies can be used to achieve a higher degree of transparency, trust and efficiency in taxation processes and other governmental tools. Important success factors here are the support of companies and institutions in the development of standards and the cooperation with the industries in the creation of new laws and guidelines. The social and environmental impact as well as success factors and enabler as derived from the workshop for the stakeholder level *government and society* are shown in Table 33.

Governments and society

Social and environmental impact	Success factors and enablers
<ul style="list-style-type: none"> • Ensure that goals of own guidelines and regulation are met • Push all stakeholders • Gain transparency • Utilize technology for taxation and other governmental tools 	<ul style="list-style-type: none"> • Support further development of practical standards • Budgets for the development of use cases • Cooperation with industry for the creation of new guidelines

Table 33: Sustainability impact for governments and society²⁰⁵

²⁰⁴ Own representation

²⁰⁵ Own representation

4.4 Phase 4: implementation of blockchain technologies in logistics

After explaining the possible impact on different stakeholders in terms of social and environmental sustainability in the previous chapters, this chapter develops an implementation approach based on five management areas to support companies in implementing BCT in logistics. These results are part of phase four of the management model. For the development of the management areas, three case studies are conducted and evaluated. As described in chapter 3.3, cross case implications are derived from these and corresponding design recommendations, management instruments and tools as well as success factors are derived for each management area.

4.4.1 Case study description and analysis

This sub-chapter aims to use the method of exploratory case study analysis as described in chapter 3.3 to lay the empirical foundation for the design of the management model in the following chapter. To this end, the methodology will first be explained and the case studies investigated will then be described and the case study-specific findings presented before they are incorporated into cross-case study findings. The structure of the interviews and the case studies is already based on the conceptual design established in the previous chapter and the five management areas strategy and goals, internal organization, external collaboration, technology and implementation.

4.4.1.1 Case study A: fair operations in the coffee industry

From a global perspective, Europe and North America are among the most important markets for the coffee industry. However, coffee is mainly grown in South America and African countries. Therefore, the raw material coffee is cultivated and harvested in developing countries before it is shipped to Western countries for further processing and consumption. With increasing consumer awareness and demands for more sustainable products from end customers, this industry (traders and producers) faces the challenge of ensuring that, in addition to environmental requirements, social dimensions of sustainability are also considered and standards regarding labor and human rights are met. However, child labor, inhumane working conditions and unfair payments to farmers are often found in these logistics networks. Conscious producers therefore try to source coffee from environmentally and socially sound sources. Certifications and labels are used in an attempt to build transparency and trust in the

logistics network, but these are increasingly failing due to a deficit of traceability, manipulation and a lack of trust among customers.

The considered case study deals with the logistics network of Ethiopian coffee to German consumers. It is investigated how BCT contribute to more transparency between all actors from raw material suppliers (farmers) and processors to customers. Potential for more social and environmental sustainability lies in fair payment of coffee farmers and proof of origin of the coffee. Further topics in this context are proof of certification, eco-labels and fair-trade certificates. The examined case study deals with a BCT solution for coffee produced in Ethiopia, which is processed on site in Ethiopia (including roasting) and then exported to Germany. By applying a QR code to each packaging, the origin of the coffee and each step along the logistics network can be traced by all actors including the customer. The use case will be used to investigate the extent to which BCT can be used to achieve more transparent and fairer operations in the coffee industry. The logistics network in this case study includes a various number of globally dispersed actors. This results in the exemplary logistics network shown in Figure 25. As mentioned before, the coffee is harvested in Ethiopia. Coffee farmers account for 95 % of the nationwide production. Another 5 % is produced by plantation state farms and private investors. Basically, there are two different kind of beans (red and dry cherry), which are then processed individually in a set of post-harvesting processes. Depending on the cherry this includes for example washing, hulling and drying. The beans are then sold and transported to the roasters. This can be done either directly or through the Ethiopian Commodity Exchange (ECX), which allows sellers to centrally offer their products to a wider range of customers. This coffee exchange was manifested in 2008 to protect buyers and sellers. Initially, traceability was lost, but in the meantime the problem has been solved in such a way that traders have to register and information regarding the seller, origin and quality has to be provided when selling. In the case of the case study under review, however, coffee is sourced directly from farmers rather than through the exchange for extended transparency and transactional reasons. Roasting often does not take place in the farming countries, but in the particular case of the case study, the coffee is roasted locally in Ethiopia, allowing local companies a higher value-added share of the final product. The coffee is then exported to Germany and made available to end customers here via direct distribution over the Internet or various retailers.

The specific use case was selected by the producer based on assumptions and experience that customers and the target groups of the market place great value on transparency regarding the origin of purchased food. Fair trade labels had already been used before, but this did not guarantee complete certainty. The use of supporting technologies was therefore examined. In addition to BCT, centralized solutions were also considered. Due to the

supporting decentralized governance idea, BCT was finally implemented. The overarching goal is to provide customers with detailed information about the origin of their coffee and to obtain internal certainty about good working conditions within the company's own logistics network, thus fulfilling the requirements of a sustainably operating company.

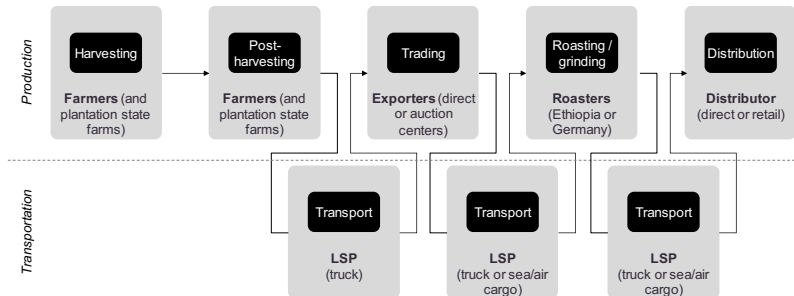

Figure 25: Logistics network for coffee in case study A ²⁰⁶

In order to measure the success of the project, in addition to social and environmental factors, about which there is now certainty and which can be communicated, economic key figures were also used above all. This manifests itself in two key metrics. The first is revenue. Since the introduction of BCT and the offer to (potential) customers of outstanding transparency as a differentiating factor from competitors, sales have increased by a factor of 2.7. Another important key figure regarding the success of the project is the usage behavior related to the retrieval of information by the customer. Of the approximately 30,000 packages sold per month, 30 % are accessed by the customer for information on origin, payment and quality, which can be considered comparatively high.

The project was initiated by the executive committee and thus had the necessary top management support. Responsibility during the project was taken by the logistics department, which, in addition to operational tasks, is also responsible for strategic functions and supplier management. The implementation of the project itself was carried out in close cooperation with a technology service provider. The development of own BCT competencies within the companies of the logistics network was not necessary for this. Since the BCT could be docked onto the existing shop system, internal processes of the producer and of the suppliers had to be adapted only slightly. The processes are still centrally organized and the BCT acts as a decentralized data storage and governance tool.

²⁰⁶ Own representation

Acceptance on the part of the coffee farmers was ensured through the perspective of long-term partnerships and, through transparency to the end customer, the guarantee of good and fair working conditions. Simple handling of the newly added operational processes avoids additional hurdles that could stand in the way of acceptance. Various functions, such as communication between customers and farmers, which are possible via “likes” and in the future also via tips, i.e. additional compensation of the farmers directly by the customer, strengthen the trust in the technology and the acceptance of all stakeholders.

In the coffee producer's logistics network, approximately 500 coffee farmers from three coffee cooperatives were integrated into the BCT network. An app is used to collaborate and maintain information. For this purpose, it was important to clarify in advance who is responsible for the corresponding data maintenance with regard to production and post-processing and how it can be ensured that qualified data is generated locally. To this end, locally trained workplaces were created to promote further training. These new instances and persons take over these tasks and are the contact persons for software and hardware as well as process-related questions. In addition to the transparency effects from the entire logistics network, this also creates better-trained jobs on a local level.

Technologically, the BCT implementation of the coffee network is based on Hyperledger. However, it was initially launched with Ethereum in 2016 before switching two years later. For storage, a public key is whitelisted with the BCT provider. It can be controlled who has read and write permissions. Private, encrypted data is possible via a shared key.

Input data is validated to reduce the oracle problem as much as possible. Data that comes in automatically (via IoT sensors, for example) is weighted higher than manual input from users. Additionally, plausibility checks are performed. In this context, it is checked, for example, whether lead times, timestamp and time frame or quantity are plausible. Complete and unchangeable documentation of all entries and transactions reduces incentives for fraud and misstatements, as there is a very high personal risk here in the event of verification and detection of fraud.

Due to a very lean app, which has both low memory and data consumption and can also handle short internet interruptions (this is especially important considering the application in developing countries), it is no problem to enable people on site to enter data. For the end customer, a QR code was used to create an interface to a web application where all information regarding the origin, process and quality of the coffee beans can be viewed.

External expertise was primarily used for the implementation. Due to the low complexity of the network, the entire process from farmer to end customer was mapped on the BCT. In order to further reduce complexity, the focus at the beginning of the project was on large packaging

sizes, before gradually adding further product portfolios and equipping them with QR codes. The operational handling could be implemented via the previous web shop concept and the BCT could be used as a decentralized data basis.

The case study of the international logistics network of Ethiopian coffee to German end customers shows the benefits that BCT can offer in order to track products and certify their origin over several stages. The solution enables end customers via QR code insights into the history of the products and ensures fair treatment of all network partners. In addition to proving compliance with standards, higher skilled jobs are created in Ethiopia. BCT serves not only as a technological enabler here, but also as a decentralized governance tool. Due to the low complexity of the use case, structured collaboration of all stakeholders involved and external technological know-how, an efficient infrastructure could be developed.

4.4.1.2 Case study B: ethical mineral supply in the automotive industry

The demand for raw materials continues to rise globally. In addition to the food industry, minerals, i.e. mining products from mines, are of particular importance for the production of industrial goods. For example, with the increasing expansion of electro mobility and the associated rise in the production of battery cells, materials such as cobalt are moving into the focus of sustainability initiatives by automotive manufacturers. These are often mined and processed in disregard of ethical working conditions. Due to the deep and broad supplier networks in the automotive industry, it is currently almost impossible to control all sub-suppliers and to pay attention to the compliance with labor rights in developing countries. There is simply a lack of the necessary transparency. With the help of BCT, this urgently needed transparency can be created. The case study under consideration is representative of many mineral export products from developing countries to industrialized countries, including cobalt and other metals and mining products used in the automotive industry. In the case of cobalt for example, the Democratic Republic of Congo plays a central role. The Democratic Republic of Congo is responsible for the mining of more than 50 % of the cobalt used worldwide and it has major problems in terms of human rights violations, and in particular the use of child labor by artisanal miners. These problems require a solution for tracking and sourcing ethically mined minerals.

According to OECD guidelines and EU and US legislation, due diligence for so-called conflict materials in logistics networks is becoming increasingly important. In the past, this has led to either responsible companies trying to avoid sourcing materials from conflict areas, leaving non-responsible actors active and hardly fixing the problem or due diligence costs being passed on to the miners themselves. The problem with previous (BCT) solutions for greater transparency, especially in the metals industry, has been that commodity fungibles are not uniquely identifiable. There are also major data privacy concerns, as full transparency (for competitors) is not wanted. In addition, systems should also be able to be implemented for artisanal and small-scale mines, because the abuses and human rights violations mentioned above often occur here and not in the large-scale mines.

The case study under consideration deals with the implementation of BCT in logistics networks, starting with the mining of metals from conflict regions. In the following, the approach is described in more detail and technological and organizational specifics are addressed. The underlying international logistics network of the case study includes the mine itself, transporters and other LSP, smelters, and the manufacturer as well as the customer. Other actors (e.g. module suppliers) can also be added to the system as needed. This results in the exemplary logistics network shown in Figure 26. After the mining of the metal by either large-scale or artisanal and small-scale mines it's transported by an LSP (usually truck or train cargo) to the smelter. The mining and the smelting process take place in the developing country itself.

The smelter is refining the product before it is then transported again (usually air or sea freight) to the manufacturer located in an industrialized country.

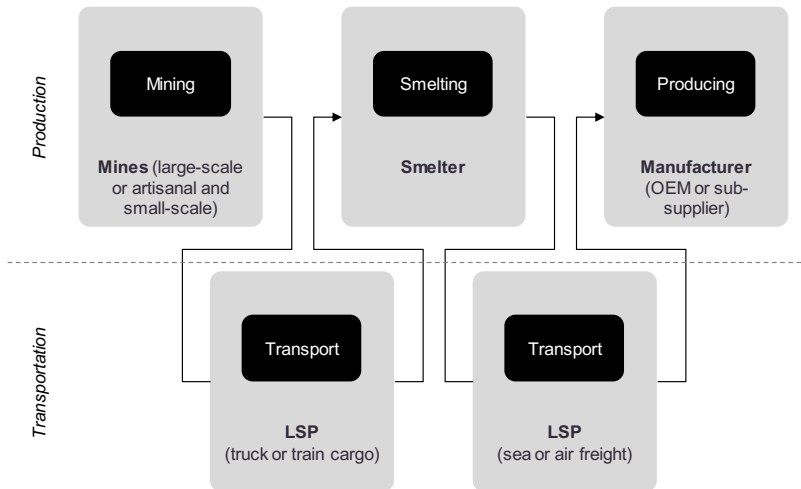

Figure 26: Logistics network for minerals in case study B²⁰⁷

In addition to new legal frameworks that, among other things, regulate the import of conflict materials such as gold or tin in the EU, large companies have been striving for ethically sound logistics networks and (sub-) suppliers for some considerable time. Several options have therefore already been explored across industries. Among them mapping of the logistics network to find out which mines in a company's own logistics network supply raw materials. This has had little success in the details, since at a certain point, pretty much every smelter supplies at large producers. The traceability of raw materials of this type is also very complicated, as they can be transformed and mixed several times during their flow through the logistics network. This is also where a traditional approach that has been thought out fails: weighed and sealed containers only work from the mine to the first processing step because from there on the mixing of several batches is a processual given. Therefore, in this case study, the problem was solved with BCT. In contrast to previous BCT pilot projects in this area, which were usually private and permission-based, this case works with an open protocol. Multiple

²⁰⁷ Own representation

actors in the logistics network are given the opportunity to exchange trustworthy private and public data.

The success of the project and the measurement of it lies above all in the feasibility of the implemented use case, which could not be mapped with this accuracy and efficiency before. In addition, the new EU regulations in 2021 can be complied with regarding the import of conflict materials.

Initial collaboration took place in small teams with personal interest in BCT. It is important to have a project champion and simultaneous top management support. Compliance with new EU standards was as important in the argumentation as a direct benefit for the companies involved that could be achieved with the project. On the part of the suppliers, in this case mines and smelters, acceptance for the BCT implementation was created on the one hand through more efficient processes (e.g. fewer audits necessary) and a stronger external perception with regard to certifications of social and environmental standards. Economically, audits are a high cost for mines and BCT implementation is therefore profitable in retrospect. Expectation management also plays a key role across all stakeholders when it comes to ensuring acceptance in the long term. The issue of data visibility and privacy was in the interest of all parties involved. Due to the competitive environment between manufacturers as well as mines and smelters, it is important that bilateral business relationships and details about them cannot be seen by third parties. Despite the (previously formulated) idea of the open architecture of the BCT protocol, a solution was implemented that allows P2P encrypted data (private data) to be stored as well as publicly viewable data (up-chain data) across multiple delivery stages.

With the support of appropriate technology service providers, know-how was sourced externally and did not have to be built up within the companies. The technological support of the BCT solution is also managed externally, since a connection to existing ERP has not (yet) been made.

In the first step, a logistics network mapping helped to get an overview of all network partners involved. First, all known up- and down-stream actors were outlined, to which additional partners could be added step by step. Then, based on this complete network, a project team was put together. The cooperation in the network is largely unchanged by the implementation on the operational level. Mines as well as smelters, transporters and producers can enter product and process data into the blockchain. As mentioned above, in this particular case, much emphasis has been placed on data self-sovereignty within the targeted open BCT solution.

Technically, the implemented BCT solution is based on the Ethereum blockchain. Due to the robustness and reliability of this platform, it represents a good starting point for the

implementation. In the long term, however, the solution is designed to be flexible and the transfer to other BCT is conceivable. The protocol used is thus blockchain agnostic. Previous pilots have relied on private or permission-based blockchains. In the long run, this can lead to the emergence of a large number of different BCT systems throughout the industry, each of which must then be used by the suppliers. An open solution, on the other hand, is in conflict between data privacy and data transparency. It must therefore be ensured that private logistics data cannot be viewed by unauthorized third parties. As described above, the special feature of this solution is that this data self-sovereignty can be ensured. To achieve this, data is stored in three segments: key with the permissions of the respective entity, data segment with publicly viewable data for all partners of the logistics network, and data segment with private data that can only be viewed by the respective subsequent network partner. The operational design of the protocol consists of two layers, the BCT layer, on which the amount and owner of ethically sourced raw materials are stored, and the certificate layer, on which certification scans, production limits of individual mines and smelters or authorizations are stored (see Figure 27 for details). When purchasing certified material, the buyer can view its history via a web application.

Those buyers of the certificates need appropriate assurance regarding the credibility of the data stored in the BCT. A veritable input is therefore essential to solve the oracle problem. For this purpose, appropriate frameworks have been developed together with partners such as the Responsible Minerals Initiative. A risk assessment supports additional processes such as audits and additional checks for compliance with standards in order to deploy working capacity in a targeted manner here.

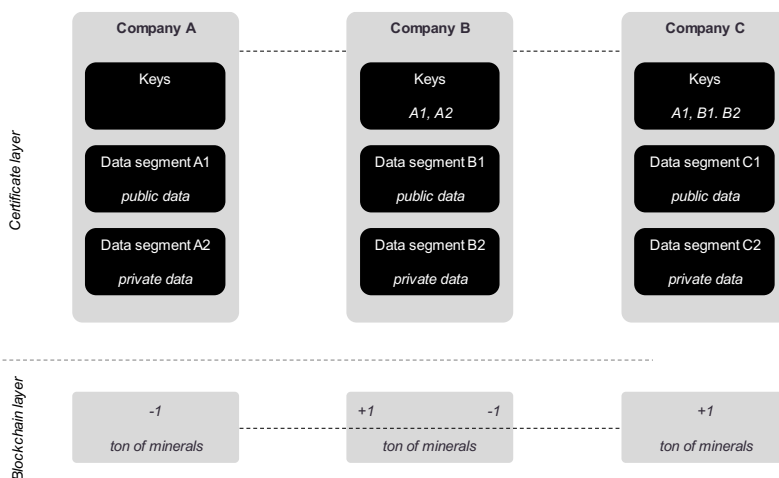

Figure 27: Protocol design for case study B²⁰⁸

Using the mapping of the logistics network described above, a consortium was selected for piloting based on this comprehensive network. This pilot was implemented in close cooperation with a technology provider. Care was taken to test the minimum viable product in a small environment first. Afterwards, it can be rolled out company-wide or network-wide and successively supplemented by further technologies. The next steps on the implementation horizon are the connection with artificial intelligence in order to be able to identify deviations in the data more quickly and in a more targeted manner, to include IoT sensor data or to clearly identify the operator during data entry using biometric scans. In addition, the copy of the blockchain is initially only stored on one node at a cloud service provider. If individual participants are interested, this can also be extended to other nodes and additional copies.

The presented case study deals with the development of a BCT network for tracking and certification of ethically sourced raw materials from different metal industries. Companies pursue internal requirements for sustainability and compliance with US and EU regulations. Unlike previous solutions, the approach is not only decentralized, but also open and non-permission-based to avoid data silos and parallel implementations. At the same time, the two-layer protocol design ensures data self-sovereignty. During the implementation and also when working together in the network, attention was paid from the beginning to the right expectation management, an attempt was made to establish acceptance at an early stage by showing

²⁰⁸ Own representation based on whitepaper of the case study partner

which and whose problems were being solved, and low hanging fruits were initially gathered as early achievements with a pilot implementation.

4.4.1.3 Case study C: digital and efficient load carrier exchange

Globally, it is common in logistics to transport products using load carriers. At the sender, products are packed on this load carrier, such as a euro-pallet. This is handed over to the logistics service provider, who then transports the products to the receiver and hands them over to them. In most cases, the pallet remains on site with the recipient of the goods. This means that after use, sale or onward transport of the goods, the recipient would have empty pallets with no intended use, while the original sender would not have a new pallet to send further goods. For this reason, there are cross-company exchange processes of the load carriers between trade, industry and logistics in the industry, which are usually handled by the logistics service providers.

The most important documentation medium is still the pallet bill, which documents all pallet transactions. There is a large number of different pallet bills. These bills are to be understood as receipts on which it is noted how many units have been received and often also an assurance that the agreed number will be returned at a later date. Problems currently exist, among other things, in the lack of a contractual relationship between the recipient and the service provider if the latter was commissioned by the sender or, conversely, no contractual relationship between the sender and the service provider if the latter was commissioned by the recipient. If this process is unclear, the service provider often lacks legal certainty and contractual flexibility. This leads to an increase in economically and environmentally questionable additional and even empty trips. The pallet bill therefore has great potential for optimization in logistics.

In this case study, the pallet bill is organized in a decentralized manner using BCT. Participants in the logistics network, who do not necessarily know each other, have no contractual relationships, and have had to act without an intermediary up to now, are thus given the opportunity for a peer-to-peer exchange of information and load carriers. At the same time, the pallet bill is henceforth implemented as a digital medium. In addition to more efficient processing within the context of operational logistics processes, this also leads to a standardization of the previously company-dependent pallet bills. Accordingly, the players in this network are a large number of shippers on the one hand and a large number of recipients on the other. In between, several independent logistics service providers and pallet service providers operate. This results in the exemplary logistics network shown in Figure 31. The multitude of players involved supports the idea of uninterrupted end-to-end logistics. All

companies besides the service providers (logistics and technology) operate either as producers or retailers in the German food industry. In the large field of players, there are thus also competitors on both sides who cooperate with the aim of developing a cross-industry solution.

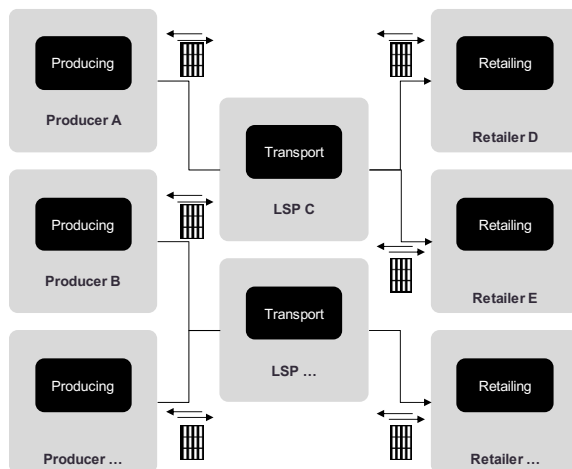

Figure 28: Exemplary logistics network in case study C²⁰⁹

The use case implemented with BCT was selected in joint consultation with more than 30 partners of a logistics network consisting of retail, industry and logistics service providers. The pallet exchange process is a process with many peer-to-peer relationships and no intermediary controlling the entire process. The decentralized nature of these processes is therefore ideally suited for an implementation of BCT to address previous inefficiencies and lack of legal clarity. Parallel to the development of the BCT solution, a standardization project of the pallet bill was initiated.

The objectives of the project were defined primarily in qualitative terms. The main objective was the digitalization of the pallet bill and thus more efficient handling of the processes in order to avoid empty runs or additional runs by the logistics service providers with a significant impact on environmental sustainability, in addition to better utilization of personnel capacities. Several secondary project goals were defined for this purpose. For example, the necessary technical requirements were to be validated in order to test the new technology and subsequently to be

²⁰⁹ Own representation

able to conduct a qualitative value assessment of BCT and to achieve a gain in knowledge and a transfer of knowledge among all partners.

The decentralization associated with BCT creates new organizational structures and process flows. For this reason, care was taken from the very beginning to include employees involved in the pallet processes in order to create acceptance for the solution at an early stage. It was also important to work openly throughout the entire project and to communicate (preliminary) results transparently. All the companies involved had dedicated project teams that were responsible for implementing the respective work packages. Technological know-how was mainly provided by external technology service providers.

When identifying partners, it is important to achieve a critical number of market participants who will cooperate to implement the system. Since pallets are usually exchanged industry-wide, a high share is essential for success. During acquisition and implementation, an independent third-party intermediary can be helpful to build trust. This sounds contrary to one of the basic ideas of BCT, to replace intermediaries, but in this specific case it could help to acquire a large field of participants. The strengths of this neutral entity were particularly evident in the development of governance structures and the management of negotiation and coordination processes between the participants.

In operational cooperation, a mobile application based on the decentralized database was made available to employees at the loading ramp or the truck driver. Employees in the back office can also use a pallet portal to view pallet inventories and track their own transactions. All transactions are encrypted and stored decentrally. In the case study under consideration, pallet exchange would also be possible on a technical level without BCT. However, the technology helps to reduce barriers regarding data transparency and privacy on a political/organizational level.

The most important criteria were data availability and data quality, which forms an essential basis for all technological implementations and is crucial for the success of the project. Contrary to initial concerns, the storage space required for the BCT is manageable. For example, about 10 MB of storage space is required for 1000 exchanges of pallets, which can also be implemented in the long term. However, it is important to remember that due to the nature of the BCT, all historical transactions will be stored. The performance of the system was tested in a load test and a peak of 3,600 exchanges per hour was possible, which corresponds to approximately 90,000 exchanges per day and can therefore be implemented industry-wide.

As described above, a mobile application and a web interface were programmed for the user, with which both operational employees in logistics (e.g. at incoming and outgoing goods or

truck drivers) can confirm entries and transactions, and employees in the back office can view transactions.

An important finding of the consortium was that the process could have been solved technologically in theory even without BCT, and that the advantages here were played out primarily in the decentralized management of governance.

During development, a two-stage pilot development was carried out with the option for new partners to join in the second phase of the project. This enabled the consortium to be enlarged once again and better market penetration to be achieved. Each of these developments consisted of six project phases, which are illustrated in Figure 29.

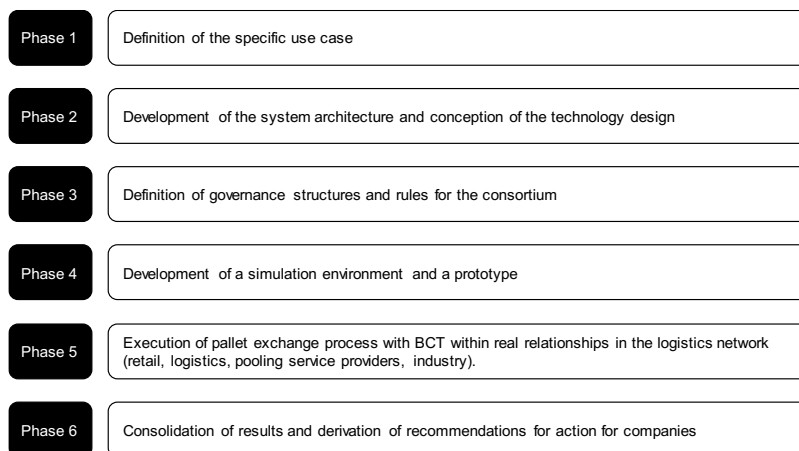

Figure 29: Project phases in case study C²¹⁰

In the first step, the exact process-related boundaries of the implementation were defined and a precise use case was established. Then, with the support of technology service providers, the system architecture and technology design were defined and developed. Based on this, governance structures and thus rules for the consortium could be negotiated during and after the project. In the fourth phase, a prototype was developed and tested in a simulation environment before the BCT solution was introduced in the real process. In this process, more than 15 participants with a total of 20 warehouse locations worked together and 600 real pallet transactions were processed via the BCT. Afterwards, the results of all participants were consolidated and recommendations for further action were developed.

²¹⁰ Own representation based on whitepaper of the case study partner

The case study described here uses the example of the pallet exchange process to show how BCT can be implemented in the area of operational logistics to avoid additional runs and thus generate environmental and economic benefits. In addition to the decentralized nature of the data, BCT help to develop governance structures and overcome hurdles in terms of negotiation and coordination problems. The solution can be used industry-wide, has the necessary performance and does not require a lot of storage space. Thus, BCT could be used to standardize an outdated process and make it more efficient regarding economic and environmental sustainability.

4.4.2 Development of the management areas for the implementation

Based on the case studies and the insights gained from them regarding strategic decisions, internal organization, external collaboration, technology management and the implementation of BCT, the results are summarized in this chapter. The presentation of results is based on the previously conceptualized management areas. The core of each management area are the design recommendations that are recommended for the use of BCT in logistics networks. These design recommendations are supported by success factors as well as management instruments and tools. Figure 30 shows the relationship between the five management areas of phase four of the management model.

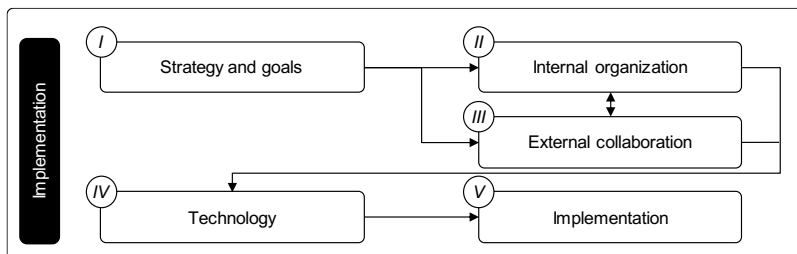

Figure 30: Overview of management areas²¹¹

In the following chapters, each management area is defined in detail. Relevant management tools and instruments are explained, design recommendations for the use of BCT are made, and success factors related to the management area are defined. In addition to the case studies, the results also include previous findings of this thesis from the systematic literature review and the workshops conducted. After the definition of the individual management areas, all results are consolidated in a structured way.

²¹¹ Own representation

4.4.2.1 Management area I: strategy and goals

The management area *strategy and goals* supports the definition of a strategy and requirements. Opportunities and risks of the project must be weighed and appropriate metrics for measuring changes and ultimately the success of the project must be created. It is also important to refine the selected use case. Figure 31 provides a structured overview of identified success factors, relevant management tools and instruments, as well as design recommendations for the use of BCT in international logistics networks. These are explained in more detail below.

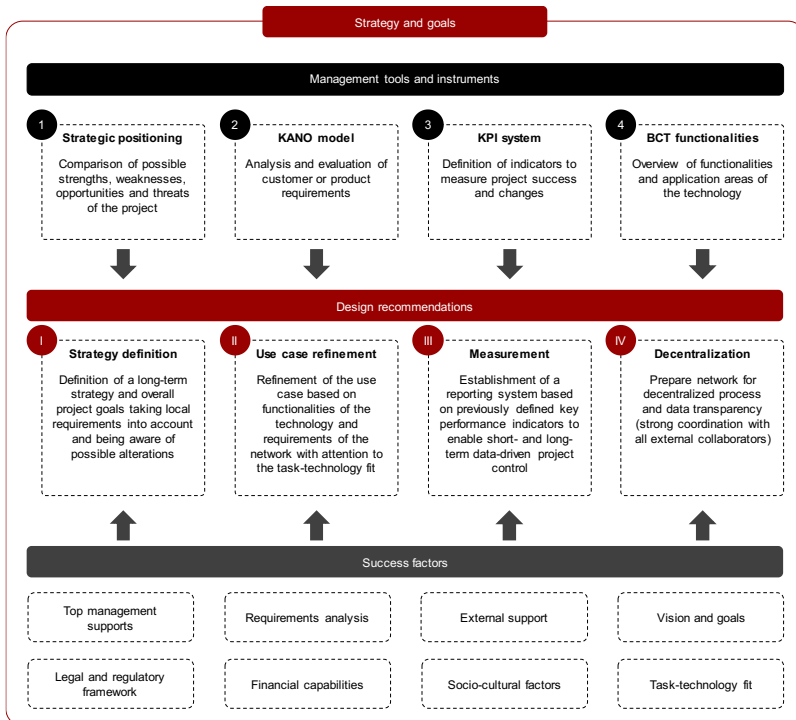

Figure 31: Management area I: strategy²¹²

As design recommendations strategy definition, use case refinement, measurement of project success and decentralization are considered as the main aspects. The first step in this process should be the definition of a long-term *strategy* and corresponding goal formulations that are

²¹² Own representation

based on the requirements of the logistics network and allow flexible adjustments to changes. This strategy and long-term goals can then be broken down into task packages for different stakeholders, which can then all be aligned with the common strategy. These goals can be based on all three dimensions of sustainability and thus have economic, environmental and social orientations. The second important recommendation is the *use case refinement*. It is crucial for the success and significance of the project in the logistics network. In international logistics networks, there is a wide range of possible use cases for improving sustainability with BCT. An overview of this was given in previous chapters and can be consulted for this purpose. Again, it is important to consider the individual requirements in order to find the best possible combination of use cases. When setting up the goals and deciding on a use case, it is important to define at an early stage how the *success of the project* can be measured. An appropriate reporting system thus supports a data-driven strategy in the short and long term and enables flexible control of activities to deploy BCT and improve sustainability in international logistics networks. Just like strategy and goals, the key performance indicators contained therein must be oriented towards the framework conditions of the network. Conceivable examples include measuring process efficiency or reviewing the effectiveness of measures in terms of sustainable parameters. Finally, it is important to prepare the *decentralization* of the network in the context of strategy and goals. This means that close collaboration with other stakeholders must be initiated from the very beginning (see management area external collaboration in chapter 4.4.2.3). In addition to the decentralization of data, this can also include processes and areas of responsibility, which are henceforth either decentralized or no longer required, since central intermediaries are no longer needed. In addition, issues of data privacy and data transparency must be considered in advance (see management area technology in chapter 4.4.2.4).

Within the case studies, eight key *success factors* for the management area strategy and goals could be identified. Those success factors and their relation to the BCT strategy as well as the corresponding goals will be explained in detail in the following. As with any major (IT) project, *top management support* is a critical success factor for implementing BCT for greater sustainability. Top management should be willing to be involved in the implementation process, providing legitimacy for the project and communicating content and strategy between departments and beyond company boundaries between stakeholders. The in-depth *requirements analysis* of the specifications of the network as a whole and the respective stakeholders involved provides the basis for further important strategic decisions. It is thus a driver of the development process and directly specifies the requirements for the BCT solution to be developed. In addition to identifying the requirements, structuring, evaluating and prioritizing them are also important components. From the beginning of the project, the scope

of the required *external support* should be considered. Often, the necessary skills in terms of BCT are not yet sufficiently available within the network and external support can significantly reduce initial difficulties. The scope and type of external consulting services depends on the internal know-how that can be provided by the network itself. The use of external support is possible in different phases, from conception to implementation and rollout. From the strategy, top management must link a *vision and goals* to the implementation of the BCT system. For this purpose, it is necessary to determine not only the possible benefits from the implementation, but also the opportunities and threads, expected costs and required resources in order to justify investments and to define the vision and goals precisely in terms of the economic, environmental and social requirements. The *legal and regulatory framework* is another important *success factor* when it comes to strategy and goals. It indicates the basic scope for action and thus decisively defines the success of the BCT implementation. On the one hand, the regulatory framework must be known and applied, and on the other hand, in the emerging field of BCT, political involvement in shaping guidelines can have a significant impact on the future design of international logistics networks with BCT. The *financial capacities* of the stakeholders in the logistics network are also of crucial importance in terms of access to capital, investment strength and the financial resources required for the implementation and the transaction costs that may be incurred after implementation. So, in addition to the social and environmental dimensions, this is an important success factor that sheds light on the economic dimension in a crucial way. *Socio-cultural factors* include topics that describe the technology awareness and acceptance of stakeholders with regard to BCT. These are determined by the motivation to transform to more sustainable logistics networks through BCT. The organizational culture is also a significant influencing factor (see management area internal organization in chapter 4.4.2.2). The last success factor in the management area strategy and goals is the *task-technology fit*. As early as the strategic orientation of the project, aligning the process-related challenges to be addressed with the inherent characteristics of the technology is of utmost importance for the success of the implementation (see management area technology in chapter 4.4.2.4).

In addition, the user is supported by four *management tools and instruments* within the context of the management area strategy and goals. Strategy development always takes place in the context of tension between technological progress, increasing customer requirements and needs, and a complex competitive environment. The *strategic positioning* with the SWOT analysis developed in the 1950s helps to develop competitive strategies in this environment. It is one of the most frequently used analysis tools in the context of entrepreneurial activity. The internal and external environment of the network with all market players is analyzed. Internal strengths are identified in order to use external opportunities and to avoid external threads. At

the same time, the focus is on addressing the company's own weaknesses. These four variables - strengths, weaknesses, opportunities and threads - are based on the simplification of complex interrelationships, but despite the resulting limitations they represent an important basis and a valuable tool in the decision-making and strategy-finding process. An overview of exemplary entries in the SWOT analysis is shown in Table 34. The entries are based on the results of the previous research of this thesis on the fundamentals of the technology as well as the empirical investigations of the workshops and case studies. These entries therefore only represent a general overview of the SWOT Analysis for BCT and must be expanded context-specifically with additional variables to enable an analysis of one's own logistics network.²¹³

<p>Strength</p> <ul style="list-style-type: none"> • Transparency and privacy • Data integrity and quality • High-end cryptography • Automation potential • Decentralization and traceability 	<p>Weaknesses</p> <ul style="list-style-type: none"> • Complex technology • Lack of standardization • Transaction capacity (BCT) • Irreversibility vs. data protection / correction
<p>Opportunities</p> <ul style="list-style-type: none"> • Increasing network sustainability • Integration with other technologies • Improving collaboration and trust • Process automation and efficiency improvements 	<p>Threads</p> <ul style="list-style-type: none"> • Input data manipulation • Lack of technology understanding • Excessive expectations due to technology hype • Quantum computer attacks

Table 34: SWOT analysis for BCT in logistics

The second recommended management tool is the *KANO model*. In the context of successful strategic differentiation, services must be identified that create added value for a customer and set the company apart from the competition. In the context of quality planning, the KANO model first helps to obtain an overview of which product features are feasible and which are required or desired by customers. To do this, it classifies customer requirements into basic needs, performance needs and delighters. Basic needs are defined as must-have requirements and must be ensured by every provider. In contrast, performance needs are requirements that are used by customers to compare products and services. Enthusiasm requirements are ultimately

²¹³ Cf. Glaister/Falshaw (1999) p. 107; Panagiotou (2003) p. 8.

new product features that are not yet known to potential customers.²¹⁴ Figure 32 shows the relationship between these requirements and the degree of performance fulfillment and customer satisfaction.

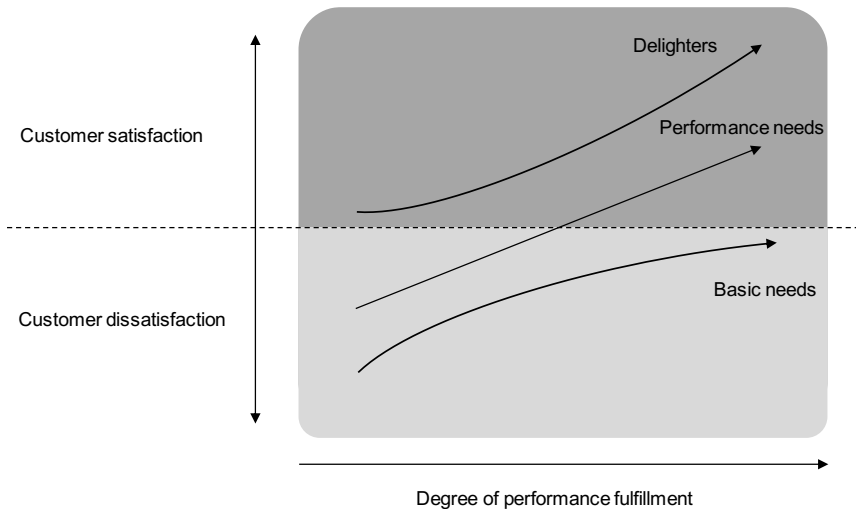

Figure 32: KANO model²¹⁵

The fulfillment of basic needs is a necessary but not sufficient condition for customer satisfaction - while fulfillment does not lead to customer satisfaction, non-fulfillment leads to customer dissatisfaction. These requirements are not explicitly specified, but must be fulfilled for the success of the BCT implementation and represent an indispensable part of the strategy. Performance needs, on the other hand, ensure (more) customer satisfaction with a higher degree of fulfillment. In this context, it is important to weigh the improvement of performance characteristics against the associated cost increases and to form an optimal relationship between customer benefits and costs. Delighters are initially neither desired nor expected by customers, and demand is only created by the corresponding offer. While performance needs may be associated with high manufacturing costs, delighters can be used to achieve a high level of customer satisfaction with comparatively low resource investment.²¹⁶ To link strategic and operational system goals, it is necessary to operationalize the logistics goals by means of a key performance indicator (KPI) reporting system. For the development of a KPI system, a

²¹⁴ Cf. Benz (2008) pp. 35–43.

²¹⁵ Own representation based on Benz (2008) p. 37.

²¹⁶ Cf. Benz (2008) pp. 36–43.

common understanding of logistics objectives and their weighting is required. This is followed by the derivation of logistics KPI from logistics objectives for planning, management and control purposes. It helps to increase transparency about the flow of information and materials in order to meet logistics requirements. For the above recommended design of a reporting system for measuring project and success key figures, these key figures must first be defined and described and then made visible to all participants in a decentralized manner. It is also important to create a common understanding on how to interpret these metrics.²¹⁷ In addition to operational key performance indicators, the case studies examined also collected key performance indicators on the general feasibility of the project. An overview of *BCT functionalities* and possible application areas in logistics helps to refine the concrete use case and the corresponding strategy. This overview has been compiled in chapter 2.2.2 and 4.2.1 in the course of the thesis so far. In general, implementations of BCT in logistics are possible in five application areas: tracking and tracing, financial operations, verification and certification, planning and network, automation and IoT. Sustainable use cases can also be classified into these five application areas or be implemented as a combination of them although tracking and tracing, verification and certification as well as planning and network seem to be the most promising areas. The key functionalities to understand the technology were also elaborated in chapter 2.2.2. Accordingly, the most important properties to be aware of in the strategy development process are decentralization, immutable data, transparency, security and smart contracts. The case studies examined make use of all the functionalities and can be categorized in the application areas as shown in Table 23.

²¹⁷ Cf. Roy (2017) p. 144.

4.4.2.2 Management area II: internal organization

The management area *internal organization* supports the building of internal capabilities and skills ensured for implementation. In addition to knowledge management, this also includes change management and creating acceptance and preparation for new processes as well as embedding the project in the organization. Figure 33 provides a structured overview of identified success factors, relevant management tools and instruments, as well as design recommendations for the use of BCT in international logistics networks. These are explained in more detail below.

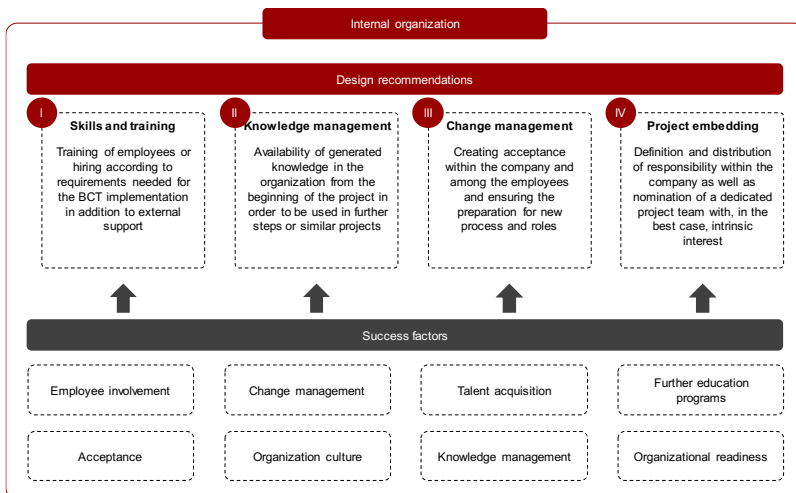

Figure 33: Management area II: internal organization²¹⁸

The four key *design recommendations* for the management area internal strategy are *skills and training*, *knowledge management*, *change management* and *project embedding*. Accordingly, it is important to identify and train the required *skills* within the company or to hire them externally. In addition to the external support that may be required, this represents an important basis for the success of the BCT implementation. In addition to technologically trained employees in the area of BCT, it is also important to create an understanding of the decentralized characteristics of the technology and the future processes among management and operational employees. *Knowledge management* must be ensured at all stages of the implementation process and beyond. Before the start of the project, existing knowledge within

²¹⁸ Own representation

the organizations should be identified and made available. This knowledge can then be used in later steps and provide the necessary understanding of interrelationships. During implementation, lessons learned should also be continuously collected and evaluated in order to be able to use them for future projects. In addition, knowledge management across company boundaries is necessary (see management area external collaboration in chapter 4.4.2.4). The implementation of the new strategies, the planned changes to the processes and also the BCT implementation project itself must be prepared within the company by means of targeted *change management*. For this purpose, it is necessary to involve employees in the processes and to incorporate the corresponding requirements into the design. Companies can use Kotter's 8-Step process for leading change as an example. This process is illustrated in Figure 34.

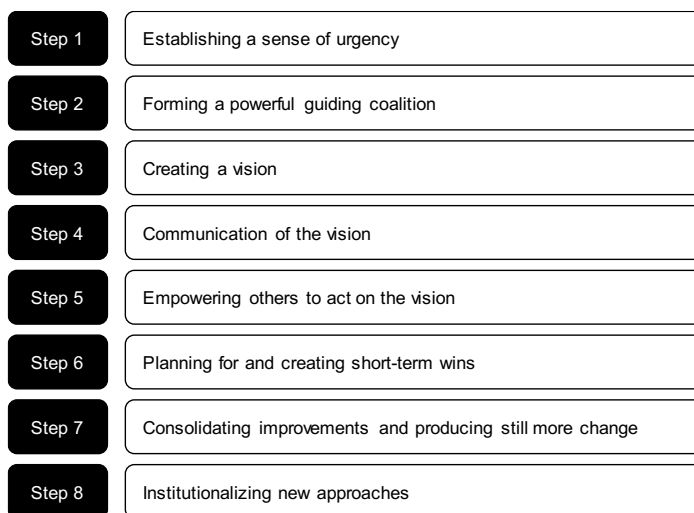

Figure 34: Kotter's 8-step process for leading change²¹⁹

The first step involves analyzing the competitive environment and identifying and discussing potential challenges and opportunities. In the second step, a team to lead the change is set up. Then, in the third step, a vision and strategies are defined (see management area strategy in chapter 4.4.2.1). Eventually, step four involves communicating the vision using all possible channels and teaching new behavior. Step five includes activities to remove obstacles and change systems and structures to support the vision. Risk taking and unconventional ideas

²¹⁹ Own representation based on Kotter (1995) p. 61.

and activities are encouraged. In step six, visible performance improvements are created and involved employees are rewarded. The seventh step involves changing systems, structures and policies using the increased credibility. This involves hiring, promoting and developing employees who can implement the previously defined vision. Finally, the eighth step involves articulating the relationships between new behaviors and the company's success.²²⁰ The fourth design recommendation is *project embedding*. In each of the companies involved in the logistics network, responsibilities must be defined and distributed. This results in the composition of a project team. Ideally, this project team consists of employees from the departments involved with an interest in the topic of BCT and thus an intrinsic motivation for the success of the implementation. Governance and the distribution of responsibilities among the actors involved is addressed in the management area external collaboration in chapter 4.4.2.3.

The analysis of the case studies led to the identification of eight *success factors* for the management area internal organization. These success factors will be explained in detail in the following. *Involving employees* in the project from start to completion is one of the most important internal success factors and is of similarly crucial importance as the support of top management (see management area strategy in chapter 4.4.2.1) for a successful implementation. It ensures that the requirements of the users of the BCT system are better captured and implemented, and thus also that the quality of the system is increased, the user-friendliness is enhanced and the implementation is accepted by the workforce. To achieve this, the user must perceive the portal as important and necessary for their work. Involving users in the process thus helps to draw a realistic picture of expectations, reduce potential for conflict during design and implementation, and improve system performance. In addition to the design recommendation *change management*, this also represents an important success factor for the other goals of the internal organization. As described above, this includes preparing the organization for expected changes. *Team acquisition* and thus the composition of the project team is crucial as another success factor. The implementation of BCT requires a balanced team composition in terms of competencies and stakeholder representatives. For example, technical and business experts as well as end users of the portal (employees and suppliers) must be involved. If skilled employees or team members are not available, external support must be used or appropriate training and further education programs must be initiated. These *further education programs* can help to build up previously unavailable competencies and skills in the company. This not only helps with the implementation of BCT itself, but can also be useful in the long term for dealing with this technology. This success factor is supported by

²²⁰ Cf. Kotter (1995) p. 61.

knowledge management. Just like change management, this is design recommendation and success factor at the same time, as it supports other internal (and external) goals by making knowledge available. Equally important for the success of the BCT implementation is the *acceptance* of all stakeholders. The goal must be that the BCT solution is accepted by users in the company as well as by suppliers and service providers and is used on this basis. To achieve this, it is important to organize an appropriate environment and to motivate or incentivize those involved to use it. Acceptance is therefore an important success factor not only internally, but also throughout the network (see management area external collaboration in chapter 4.4.2.3). The success factor *organizational culture* describes how the company is organized and managed and thus determines the success of a BCT implementation project. The open-mindedness towards new things or the avoidance of uncertainties contributes significantly to the acceptance and application of the BCT solution. The approach to BCT implementation must therefore be adapted to the culture. Closely related to this is *organizational readiness*. This success factor combines aspects of the organization's ability to change, engagement with the technology, the availability of a BCT talent pool, and an understanding of the technology landscape. Thus, the organizational structures must be ready for the implementation and the associated change to decentralized data. The success factor therefore describes the organizational readiness to implement novel technologies such as BCT. In the area of tension between organizations, people, technology and environment, the effective synchronization and coordination of corporate resources is decisive for a successful technology adoption.

4.4.2.3 Management area III: external collaboration

The management area *external collaboration* supports the organization of collaboration between stakeholders in the logistics network. BCT implementations require joint handling of organizational and technological challenges. For this, stakeholders have to be identified, changes for the individual actors have to be predicted and activities have to be aligned. Figure 35 provides a structured overview of identified success factors, relevant management tools and instruments, as well as design recommendations for the use of BCT in international logistics networks. These are explained in more detail below.

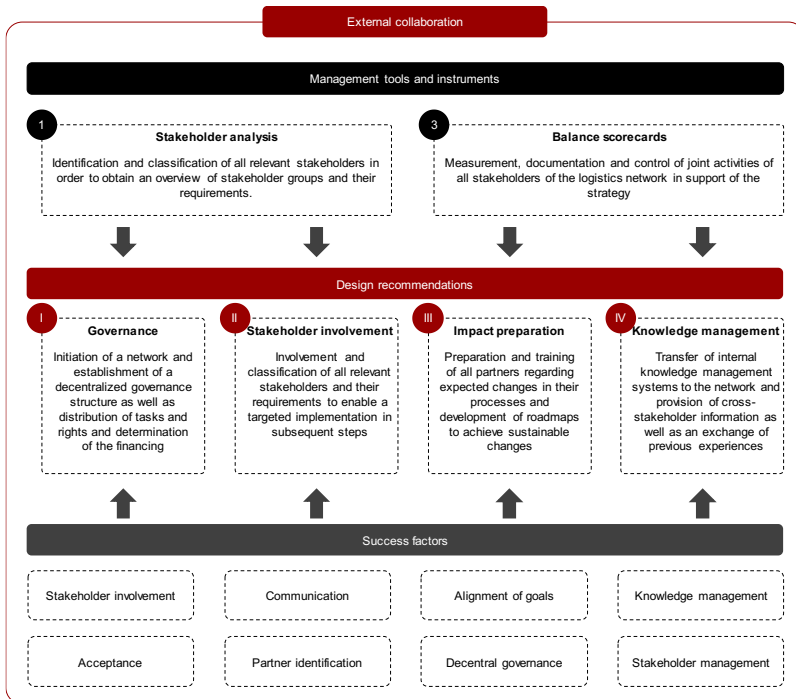

Figure 35: Management area III: external collaboration²²¹

For the management area external collaboration, four *design recommendations* can be derived from the case studies conducted. These include *governance*, *stakeholder involvement*, *impact preparation* and *knowledge management*. Since BCT implementations often involve a large

²²¹ Own representation

number of stakeholders, possibly dispersed globally, an efficient *governance* structure is necessary. Within the framework of governance, tasks, rights and obligations are distributed and the financing of the project is clarified. In the case studies examined, a decentralized governance structure proved to be helpful. It can provide important learnings with regard to the decentralization of the technology right from the start. Another design recommendation is *stakeholder involvement*. Especially in network-wide logistics projects, it is important to identify the requirements of all stakeholders and to include them in the design process. In addition to identifying the necessary and sufficient stakeholders of the project, they should be involved in the planning and design throughout the project. In a further step, stakeholder *impact preparation* is an important feature of successful BCT projects. Based on economic, environmental or social parameters, change dimensions and potentials can be identified and prepared in advance. The results from phase three of the management model can support this step. This measure contributes significantly to the acceptance of the project and a smoother adoption of the technology. The fourth design recommendation is ultimately external *knowledge management*. Similar to internal knowledge management (see management area internal organization in chapter 4.4.2.2), it is important to first identify existing knowledge of all stakeholders relevant to the project and make it available in the network. This knowledge must be continuously reflected in the progress of the project. Knowledge management can also be used in the follow-up to future projects.

In addition to these design recommendations, two *management tools and instruments* were identified to support external collaboration during a BCT implementation. In addition to a *stakeholder analysis*, this also includes *balanced scorecards*. A *stakeholder analysis* supports the identification, analysis and classification of relevant stakeholders within the logistics network. This is an important tool to gain an overview of the stakeholders and their requirements for the BCT project. Besides the preparation and the composition of an analysis team, the necessary steps are the identification and approaching of stakeholders, the data collection, organizing and analyzing of data as well as the compilation of the results. A variety of matrices, graphs or maps can be used to present the results. An example is the matrix shown in Table 35.²²²

²²² Cf. Varvasovszky/Brugha (2000) pp. 340–345.

Strategies positions	Involve	Collaborate	Defend	Monitor
Supportive	Optimal fit	Missed opportunities	Missed opportunities	Missed opportunities
Mixed	Risk	Optimal fit	Missed opportunities	Missed opportunities and Risk
Non-supportive	Risk	Risk	Optimal fit	Risk
Marginal	Resource waste	Resource waste	Resource waste	Optimal fit

Table 35: Strategies for managing stakeholders based on organizational positions²²³

The white boxes indicate an optimal fit between the identified stakeholder position and the planned strategy. Dark gray boxes, on the other hand, are a suboptimal fit and lead to missed opportunities for gaining stakeholder support. Light gray boxes, however, mean resource waste and thus a suboptimal fit due to too much attention to low potential stakeholders. The shaded areas eventually represent risk categories for the project or the network.²²⁴ Furthermore, as a second management tool in the management area external collaboration *balanced scorecards* can be used to support the design recommendations. Balanced scorecards support the anchoring of defined strategies and goals in the network. In addition to considering financial aspects, these can be related to customer satisfaction measures, internal processes of the organizations and innovation and improvement measures, thus allowing a holistic approach to implementing strategies and achieving goals. The structure of a balanced scorecard is shown in Figure 36.²²⁵

²²³ Own representation based on Varvasovszky/Brugha (2000) p. 344.

²²⁴ Cf. Varvasovszky/Brugha (2000) p. 344.

²²⁵ Cf. Kaplan/Norton, David, P. (2005) pp. 1–8.

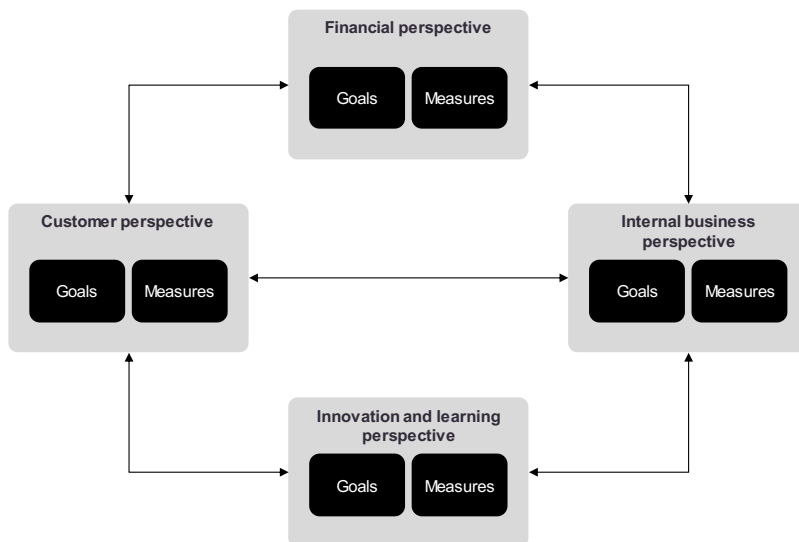

Figure 36: Balanced scorecard²²⁶

The financial perspective can be, among other things, the economic viability of the sustainable BCT solution. This can result in further financial goals and measures such as increasing market share and revenue growth. Closely related to this is the customer perspective. Here, goals and measures must be aligned to meet customer requirements with the implementation and to communicate the unique features of the proprietary products and services to ultimately satisfy customers. An example of this is the increased transparency through BCT and thus the traceability of sustainable logistics networks for customers. The internal business perspective, in turn, focuses on the process environment within the companies themselves in terms of technology capabilities, process excellence and productivity. Finally, it is important to implement measures and goals within the framework of the innovation and learning perspective that continuously generate efficiencies and value for all stakeholders.²²⁷

As in the previous management dimensions, a variety of *success factors* for external collaboration was identified on the basis of the case studies. In the following, these are explained in more detail. *Stakeholder involvement* is of particular importance for the implementation of BCT solutions. These are usually cross-company activities and must be

²²⁶ Own representation based on Kaplan/Norton, David, P. (2005) p. 3.

²²⁷ Cf. Kaplan/Norton, David, P. (2005) p. 4.

implemented jointly accordingly. Unilateral efforts or the attempt of a strong player to force this solution onto the market are not promising. Accordingly, the requirements of all stakeholders must be considered in order to ensure the involvement of all parties. Closely related to this is the *alignment of goals*. Based on the requirements of the respective stakeholders and the associated goals, it is important to coordinate these, to combine them into overarching goals and to derive joint measures and activities from these. Another important success factor of external collaboration is *communication*. In addition to internal communication, external communication includes information flows to stakeholders outside the company. In the context of BCT implementations, these include all players in the logistics network as well as any service providers who support the implementation. Similar to the internal perspective (see management area internal organization in chapter 4.4.2.2), knowledge management and acceptance are important success factors for external collaboration. Above all, the *acceptance* of all stakeholders leads to an adoption environment with a high innovation rate in the long term. *Knowledge management* is important within the network during planning and implementation of BCT solutions. This includes to make existing knowledge available in the logistics network. Furthermore, if possible, the knowledge of external IT service providers and BCT specialists should be passed on in the network in order to anchor this in the network's own capabilities in the long term and to enable the autonomous design of future BCT solutions. Furthermore, *partner identification* is an important step in stakeholder analysis and aims to identify suitable actors for the implementation of BCT (pilot) projects. Ideally, these are important stakeholders of the logistics network in high numbers to ensure a high adoption rate from the beginning. According to the own capabilities and resources, external support has to be resorted to if necessary. In all case studies, the implementation was supported and driven by experienced IT and BCT-specialized service providers. In addition to the identification of partners, *stakeholder management* is of great importance and includes the continuous monitoring, planning and design of requirements, goals and measures of all stakeholders involved. Ultimately, *decentral governance* as a success factor supports the distribution of tasks as well as rights and duties and thus the implementation of BCT solutions in international logistics networks.

4.4.2.4 Management area IV: technology

The management area *technology* supports the technology selection, considering mindful technology adoption and future developments. Figure 37 provides a structured overview of identified success factors, relevant management tools and instruments, as well as design recommendations for the use of BCT in international logistics networks. These are explained in more detail below.

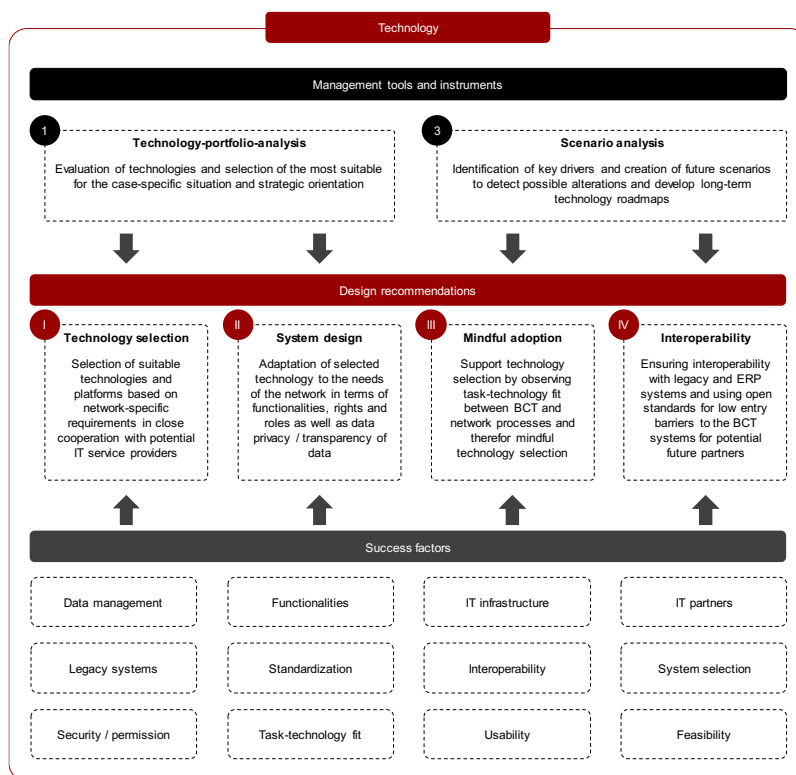

Figure 37: Management area IV: technology²²⁸

Based on the stakeholder requirements identified and analyzed in previous management areas, four *design recommendations* are given in the management area technology. First, *technology selection* must be considered. Based on network-specific requirements, the

²²⁸ Own representation

underlying BCT platform and corresponding possible extensions must be selected. In the case studies examined, two different platforms were used. Hyperledger Fabric and Ethereum therefore seem to be suitable starting points for implementations in international logistics networks. However, it is important to pay attention to develop as blockchain agnostic as possible to enable a move to other BCT. In addition to the choice of platform, decisions must also be made with regard to functionalities such as smart contracts and tokens or with regard to further supporting technologies such as apps for the user or, for example, IoT sensors for capturing raw data. This is followed by the *system design*, which is an essential aspect. Building on the selection of technologies, these should now be adapted in detail to the logistics network, the processes and the use case to be implemented. The most important issues to be considered include the definition of the type of BCT (public permissionless BCT, public permissioned BCT, private permissioned BCT, and private permissionless BCT), the consensus algorithm, the IT environment and the handling of transparency. In case study B of the case studies examined, a method was developed to enable both transparent data along the entire logistics network and private bilateral data between individual players. After already, applied in the second phase of the management model, *mindful adoption* should play a central role again in the closer examination of relevant technologies. After an understanding of the requirements of all stakeholders and possible impacts on sustainability parameters have been analyzed in the management areas regarding strategy, internal organization and external collaboration, one of the most important questions for the success of the implementation is whether BCT represent the best technologies to solve the identified problems. For this, it is necessary to know the unique feature of the technologies, compare them with other existing therapies and relate them to local conditions in order to achieve an optimal task-technology fit. The mindful technology adoption model provides support in this regard. Since a BCT implementation never stands alone, but is always embedded in an environment of existing IT systems, *interoperability* is of great importance in the design of these systems. Interfaces to legacy and, above all, ERP systems must be developed in order to keep process-related hurdles to a minimum. It should also be possible to connect new partners quickly and easily in order to enable the system to be scaled throughout the entire logistics network. Industry standards and open solutions can help accomplish this.

To support these design recommendations two *management tools and instruments* have been identified, which will be examined in detail in the following. The first proposed management instrument is the *technology portfolio analysis*. In contrast to other portfolio analyses, the focus here is on technologies. It covers the entire spectrum of observation, emergence, market and disposal cycles and thus has a long-term time horizon in order to be able to analyze trends and trend discontinuities of all technologies relevant in the network. The strategic portfolio is

based on the dimensions of technology attractiveness and resource power, each of which can be derived from three individual indicators, as shown in Figure 38. Technology attractiveness is the sum of all technical and economic advantages and is defined by further development potential, application range and compatibility. Resource power is described as a measure of the economic and technical strength or weakness of a company and is defined by the indicators technical-qualitative control level, potentials and (re-)action speed. Depending on the application, it may be useful to complement this minimum structure of indicators. An example of this would be the indicator of acceptance in the context of technology attractiveness.²²⁹

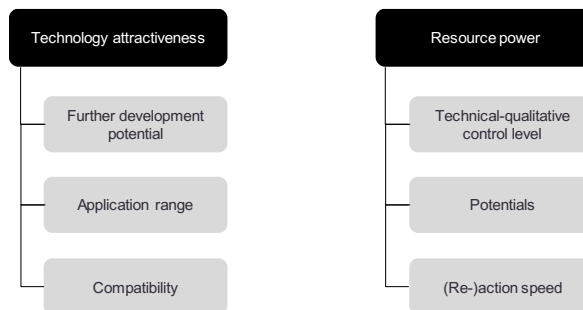

Figure 38: Technology attractiveness and resource power²³⁰

In order to carry out the technology portfolio analysis, after an analysis of the environment, product and process technologies relevant to the analysis are first identified so that the relevance of these technologies for the logistics network can be assessed in the next step. The second step therefore involves evaluating the matrix dimensions of technology attractiveness and resource power using the indicators described above. The aim of this assessment is to determine the relevance of individual technologies for the logistics network and to propose appropriate measures based on the strengths and weaknesses of the network. The dimensions range from low to high. Low technology attractiveness means that the technology in question is mature, while high refers to technologies with high potential for new applications. High attractiveness is therefore assigned to dynamic technologies. After the evaluation, the current state is transformed to a future scenario in order to create a relationship to competing technologies in the future and to make the analysis more dynamic. Depending on the position

²²⁹ Cf. Pfeiffer/Dögl (1990) pp. 258–260.

²³⁰ Own representation based on Pfeiffer/Dögl (1990) p. 259.

in the matrix, strategic decisions can be made with regard to investing, selecting and disinvesting as shown in Figure 39.²³¹

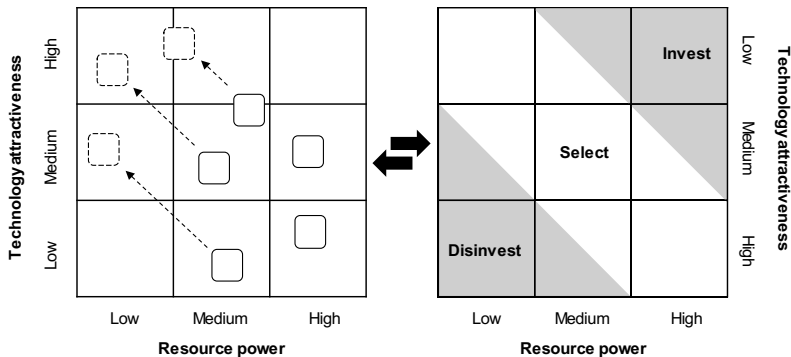

Figure 39: Technology-portfolio analysis²³²

As the second instrument, a *scenario analysis* can fulfill several functions. These typically include the four dimensions of explorative function or knowledge function, communication function, goal concretization and goal formation function, and decision-making and strategy formation function.²³³ The analysis supports the identification of key drivers and creation of future scenarios to detect possible alterations and develop long-term technology roadmaps.

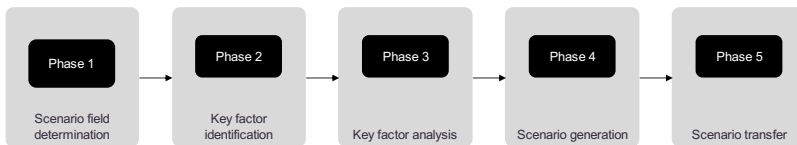

Figure 40: Scenario analysis²³⁴

In the first phase, the object of investigation and the corresponding boundaries of the scenario analysis are defined. In addition, content-thematic restrictions and definition of scenario focal points can be made. In the second phase, the scenario field is described via key factors. These are central variables that have an effect on the scenario field or on the outside via the field. They are thus variables, parameters and developments that are of central importance in the

²³¹ Cf. Pfeiffer/Dögl (1990) pp. 261–272.

²³² Own representation based on Pfeiffer/Dögl (1990) pp. 266–270.

²³³ Cf. Kosow/Gaßner (2008) p. 14.

²³⁴ Cf. Kosow/Gaßner (2008) p. 20.

further course of the process. For this, knowledge about the scenario field and the effective relationships between the various key factors is necessary. In the third phase, possible future characteristics are analyzed for the individual key factors. Each key factor thus spans a future funnel and influences the generation of scenarios in phase 4. Here, individual scenarios are now defined from the totality of the projected key factors by consistent factor bundling. This scenario definition can be done according to narrative-literary to formalized-mathematical procedures. The final fifth phase describes the further use of the created scenarios. For example, impact analyses or methods of strategy evaluation and development can be applied.²³⁵ In the context of BCT implementations, a scenario analysis can be applied at various points. On the one hand, it is important to observe and analyze future developments of the technologies themselves in order to make the right decisions regarding technology selection and design. Furthermore, process-related changes and changes in the network itself should be examined separately from the technology to be implemented in order to ensure that BCT are also the right choice in the long term in the event of possible alterations to the framework conditions.

Based on the case studies examined and the design recommendations and management tools identified, twelve *success factors* for the management area technology were identified and are described in more detail below. In the context of technology, *data management* is a key success factor. This includes the data quality and accuracy of the input data. A critical point of many BCT implementations is the so-called oracle problem and the lack of validation of input data. This problem can be solved by plausibility checks and cross-checks. Furthermore, data security and data integration for subsequent utilization are of crucial importance for success. The *functionalities* of the selected platform and other supporting technologies continue to contribute significantly to the success of the project. It is important that the technologies can cover all defined system requirements. Like any IT project, BCT projects are also significantly dependent on the existing *IT infrastructure*. Especially for international logistics networks with partly small partners and raw material suppliers in developing countries, non-existing infrastructure has to be built up, which is necessary for the final system. This can include end devices for the execution of apps and the connection to the Internet. For this, an analysis of the existing IT architectures and IT capabilities is first necessary. It is also important to consider *legacy systems*, historically grown IT systems in companies, which must be considered when implementing BCT systems, as they could otherwise represent an obstacle. Accordingly, an evaluation and integration of legacy systems has a positive effect on the success of the project. Care should be taken to keep these systems simple and standardized in order to avoid

²³⁵ Cf. Kosow/Gaßner (2008) pp. 20–23.

complex, cross-platform business processes. Under certain circumstances, legacy systems can also become obsolete through the use of decentralized technologies such as BCT. The case studies have shown that in many cases it is advisable to work together with *IT partners* and thus incorporate external knowledge into the implementation. They are familiar with the technologies and can provide support in adapting to network-specific requirements. In such an environment, collaboration with IT partners is a key success factor. Accordingly, the *system selection* and thus the selection of platforms and any other technologies is also a success factor, and all decisions should be made with regard to the requirements and goals of the BCT system. Based on this, *standardization* is a key success factor and driver of future scaling of BCT systems. Standardization avoids the creation of new data silos within and between international logistics networks and at the same time ensures low barriers to entry in order to be able to integrate new partners into the BCT ecosystem. Closely related to this is the *interoperability* and thus the connection to existing IT infrastructure. The integration of other BCT systems should also be considered and enabled in advance, as suppliers are often part of different logistics networks and completely open industry standards are not yet foreseeable. Due to the decentralization and the associated transparency in logistics networks, the aspect of *security and permissions* is of particular importance as a success factor. In accordance with the requirements and objectives, a balance must be struck between data transparency and privacy for the data stored on the BCT in order to ensure sufficient data security. The appropriate *task-technology-fit* supports a targeted mindful adoption of the technology. A technology that is adapted and selected to the processes and problems to be solved thus has a positive effect on the success of the project. It is important to search for a technological solution based on a problem (technology pull) and not for problems to be solved based on a technology (technology push). The success of the BCT solution also depends on the *usability* and *feasibility* of the system. Usability refers to the inherent characteristics of the technology and its application in the specific case. These include among others decentralization, transparency, traceability and trust. Feasibility, on the other hand, is the technological realizability of the BCT system, on which the success of the project is largely dependent.

4.4.2.5 Management area V: implementation

The management area *implementation* describes the execution of the implementation of the BCT system. It assists with the process of the development of agile, incremental, and prototype-oriented BCT systems. This also requires continuous project monitoring as well as sufficient documentation. Figure 41 provides a structured overview of identified success factors, relevant management tools and instruments, as well as design recommendations for the use of BCT in international logistics networks. These are explained in more detail below.

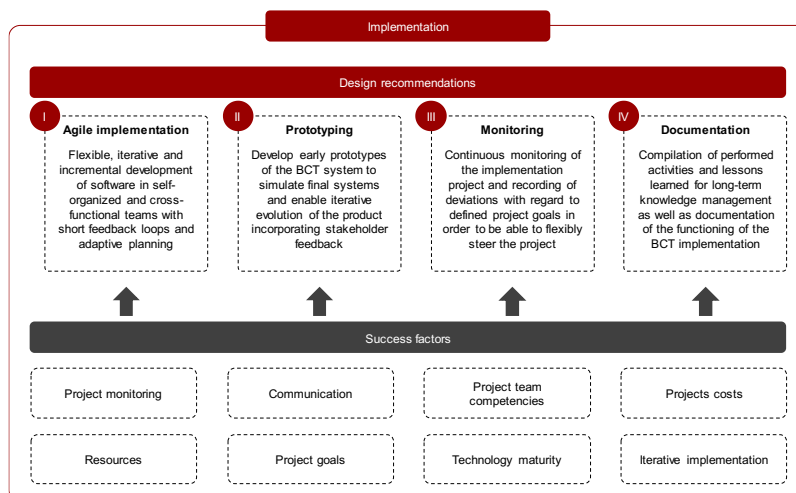

Figure 41: Management area V: implementation²³⁶

In this final management area four *design recommendations* could be derived from the examined case studies, which will be explained in detail below. The first recommendation is an *agile implementation* to enable flexible development of the BCT system through an iterative and incremental approach. Another characteristic of agile implementations are self-organized, decentralized teams that are cross-functional and contribute to agility by means of short feedback loops and adaptive planning. Closely related to this design recommendation is the establishment of decentralized governance structures in the management area external collaboration. The Manifesto for Agile Software Development defines four guidelines for agile software development: “individuals and interactions over processes and tools, working software over comprehensive documentation, customer collaboration over contract

²³⁶ Own representation

negotiation, responding to change over following a plan"²³⁷ These guidelines are reflected in the twelve principles behind the agile manifesto, which are shown in Table 36.

"Our highest priority is to satisfy the customer through early and continuous delivery of valuable software."	"Business people and developers must work together daily throughout the project."
"Deliver working software frequently, from a couple of weeks to a couple of months, with a preference to the shorter timescale."	"Welcome changing requirements, even late in development. Agile processes harness change for the customer's competitive advantage."
"Build projects around motivated individuals. Give them the environment and support they need, and trust them to get the job done."	"The most efficient and effective method of conveying information to and within a development team is face-to-face conversation."
"Working software is the primary measure of progress."	"Simplicity - the art of maximizing the amount of work not done - is essential."
"Continuous attention to technical excellence and good design enhances agility."	"The best architectures, requirements, and designs emerge from self-organizing teams."
"Agile processes promote sustainable development. The sponsors, developers, and users should be able to maintain a constant pace indefinitely. "	"At regular intervals, the team reflects on how to become more effective, then tunes and adjusts its behavior accordingly."

Table 36: Twelve principles behind the agile manifesto²³⁸

Prior to the final implementation, *prototyping* should be carried out to simulate the final results and to incorporate stakeholder feedback. A prototype can be understood as an operational model that already implements certain applications of the future system. It thus provides a basis for discussion between developers, users and management and supports the identification and solution of challenges with regard to the system design. The iterative procedure defines each prototype as a basis for a subsequent prototype up to the final system. Within the software development process, a rough decision can be made between three

²³⁷ Beck et al. (2001) p. 1.

²³⁸ Beck et al. (2001) p. 2.

phases. After the initiation of the project the analysis of the requirements follows and finally the design and the implementation of the software. For the support of these phases it can be differentiated between different kinds of prototypes. For the initiation of the project “presentation prototypes” can be used, in order to show the feasibility and the fulfillment of customer requirements of the software system. They thus give the stakeholders involved a first impression of the future solution. A provisional operational software system, on the other hand, is called a “prototype proper”. These prototypes can represent specific aspects of the user interface or functionalities of the final system and thus support the clarification of problems. A prototype that has the purpose of clarifying constructed-related issues within the developer team is called a “breadboard”. Prototypes that go beyond experimental testing and are employed in the core of the application are ultimately referred to as “pilot systems”. The goals of prototyping can be of explorative, experimental or evolutionary nature.²³⁹ The third design recommendation from the case studies is *monitoring*. Continuous monitoring and control of the progress of development and implementation is an important control mechanism in the introduction of BCT in logistics networks. Furthermore, it makes sense to create key performance indicators that measure the progress and success of the project and can be published regularly in the company's weekly and monthly reports and communicated to stakeholders. Monitoring not only covers the process of development and implementation itself, but can also make an important contribution to the final operation of the BCT or BCT solution. Ultimately, documentation is central to successful BCT projects in logistics and closely linked to the design recommendations of knowledge management (see management areas internal organization in chapter 4.4.2.2 and external collaboration in chapter 4.4.2.3). Continuous *documentation* of project progress and associated lessons learned help in subsequent iterative development phases and support a dynamic implementation based on project findings. Through knowledge management within and between the organizations, documented knowledge can also be used in subsequent projects and for the operation of the BCT solution.

In support of these design recommendations, the case studies identified eight *success factors* for the implementation of BCT in international logistics networks, which are described in more detail below. First of all, there are the *project team competencies*. Here, care should be taken to ensure that internal capabilities are supplemented by external support in order to cover the entire spectrum of required skills and knowledge. The internal project team should be composed of employees from all areas involved, since in addition to IT know-how for changing and decentralizing processes, know-how from operational logistics processes and

²³⁹ Cf. Budde et al. (1990) pp. 90–93.

management is also required. The *definition of project goals* is another success factor. Defined goals should be based on logistical parameters on the one hand and on the improvement of sustainable aspects on the other. Project goals should be specific, measurable, accepted, realistic and scheduled, and in some cases defined in a cross-stakeholder perspective. Active and continuous *project monitoring* supports all identified design recommendations and the project success by creating a basis for operational and strategic decisions. It is the constant monitoring of the project progress, which is necessary to achieve the completion of the project and the associated sub-goals as envisaged in the project plan. In addition to monitoring, *effective communication* is required at all levels for a successful implementation. In the context of the management area implementation, communication includes coordination within the teams as well as the communication of results and intermediate statuses to the stakeholders involved and the management. Even in projects that serve to promote social and environmental objectives, the economic situation must not be neglected in the context of sustainable logistics networks. This is represented by the success factor *project costs*, which describes compliance with the budget provided by the management for the introduction of BCT in the logistics network as an important driver of successful BCT systems in logistics. In addition to monetary *resources*, other resources such as employee skills, external support or IT infrastructure are just as important for the success of the project in this phase of the implementation as the *technology maturity* of the platforms used and supplementary technologies such as IoT in the context of the planned BCT system. Finally, an *iterative implementation* is a success factor that supports incremental improvement by means of prototypes and promotes a dynamic approach to the introduction of BCT in international logistics networks.

4.4.2.6 Summary of management areas

The findings of the five management areas *strategy and goals*, *internal organization*, *external collaboration*, *technology* and *implementation* result in the implementation approach in phase four of the management model, whose approach is shown in Figure 42. The user is thus guided from the definition of *strategies and goals*, through the preparation of the *internal organization* and *external collaboration*, to the management of *technology* and finally to the successful *implementation* of BCT systems. Each management area is thereby defined by recommendations for action. The user is supported by the area-specific provision of appropriate management tools and instruments as well as the definition of success factors.

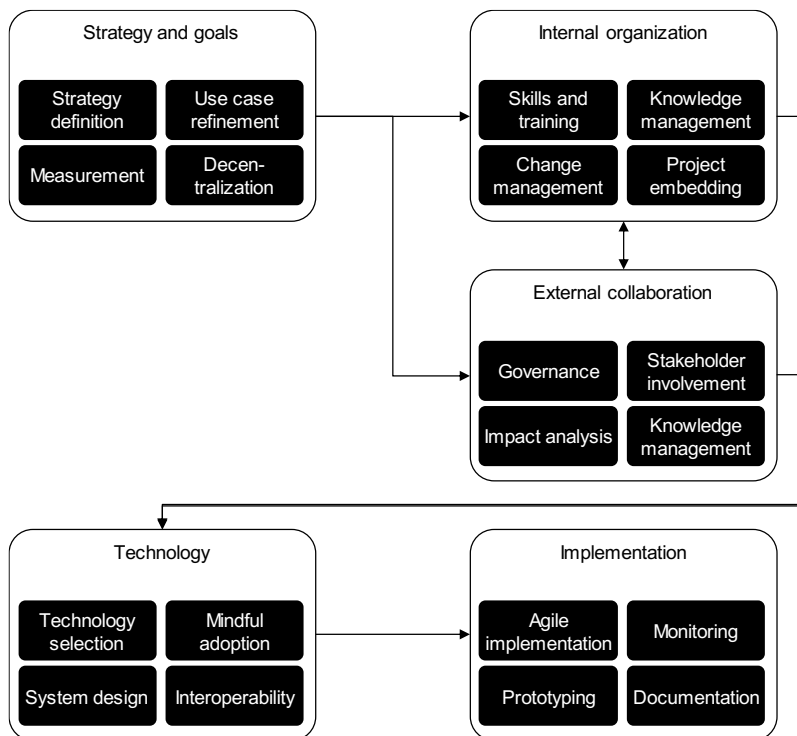

Figure 42: Implementation approach for BCT systems²⁴⁰

²⁴⁰ Own representation

The implementation phase of the management model was developed to support companies and logistics networks in the development of BCT systems as part of the fourth phase of the management model for social and environmental impact in logistics through BCT in order to plan, steer and control the design and development process. Starting with *strategy and goals*, the first management area supports the definition of a strategy and requirements. Opportunities and risks of the project must be weighed and appropriate metrics for measuring changes and ultimately the success of the project must be created. It is also important to refine the use case that fits the technology and the companies own processes while already preparing the partners for the upcoming decentralization not only during the project, but also as the underlying principle for future collaboration and data exchange. The first management area thus lays the strategic foundation for the further development of the BCT system. Following *strategy and goals*, *internal organization* and *external collaboration* are two parallel management areas which are also co-dependent. *Internal organization* supports the building of internal capabilities and skills in each company for the BCT implementation. In addition to knowledge management, this also includes change management and creating acceptance and preparation for new processes as well as embedding the project in the organization. The management area internal organization is thus a company-specific preparation for needed capabilities and organizational requirements for the development of BCT systems. *External collaboration* on the other hand supports the organization of cooperation between partners and competitors in the logistics network. BCT implementations require joint handling of organizational and technological challenges. For this, relevant stakeholders have to be identified, changes for the individual actors have to be predicted and activities have to be aligned for a successful BCT system. This management area is particularly important in the context of BCT, as systems of this kind often involve a large number of actors and cannot be carried out within closed corporate boundaries like many other IT implementations. The management area *technology* guides companies through the selection of suitable technologies and platforms, considering a mindful technology adoption and future developments. Furthermore, the focus is on the design of the technological solution with a focus on functionalities, interoperability and standardization. Ultimately, the final management area *implementation* describes the execution of the implementation of the BCT system. It assists with the process of the development itself and provides recommendations for action regarding agile, incremental, and prototype-oriented development of software systems. This requires continuous project monitoring as well as sufficient documentation. The developed implementation phase of the management model for social and environmental impact in logistics through BCT is thus a holistic management approach that reveals companies five necessary management areas for the development of BCT systems and also provides supporting management instruments and tools as well as success factors in each area.

4.5 Synthesis of the management model

This chapter gives an overview of the thematic focal points of this thesis and concludes with the envisaged management model for social and environmental impact in logistics through BCT, the structure of which has already been explained in chapter 4.1.

The term “management model” was chosen because the four phases of the model are not purely descriptive, exploratory or purely of design in nature, but contain all elements to support the decision-making process as well the development and implementation of BCT in international logistics networks. Accordingly, the management model consists of four phases, each of which is described below. The final model is shown in Figure 43.

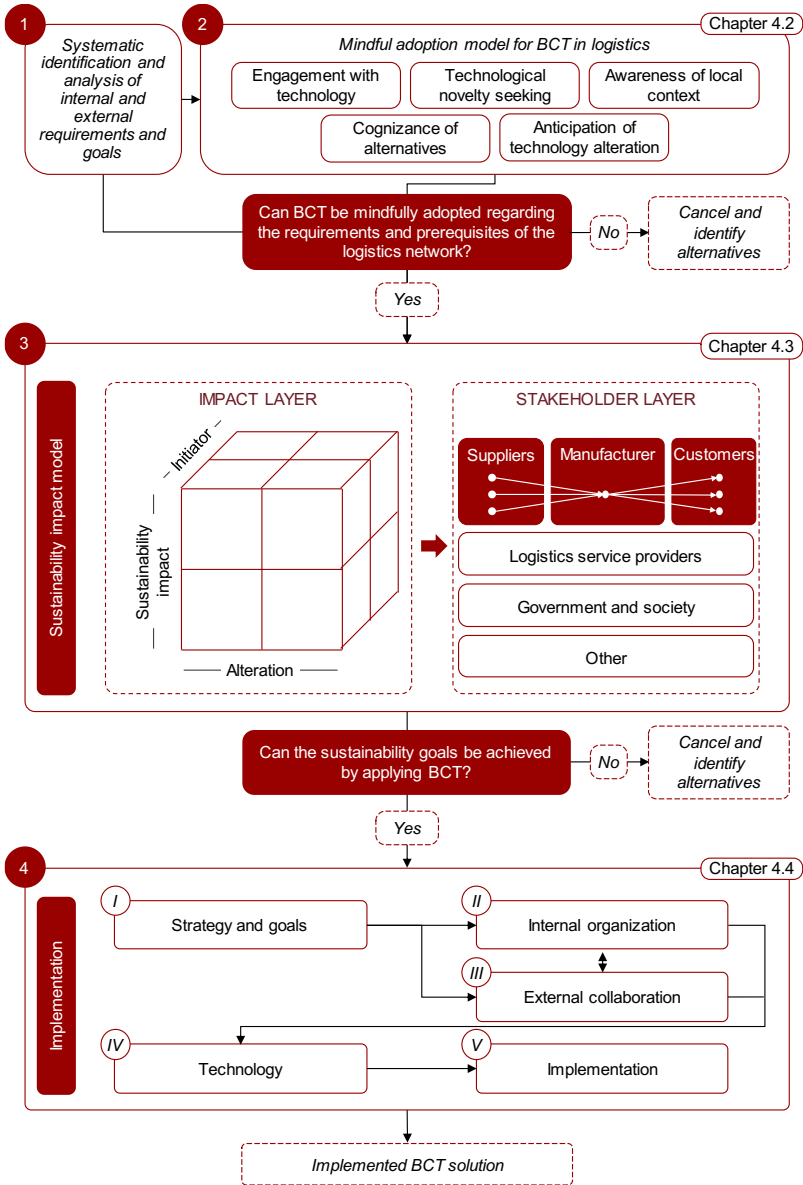

Figure 43: Management model for social and environmental impact in logistics through BCT²⁴¹

²⁴¹ Own representation

Phase one comprises a requirements analysis regarding the problem to be solved within the logistics network. This first step represents an essential step in terms of a technology pull to avoid searching for a suitable problem for a technology. Instead, organizational and technical solutions should be sought starting from the problem and development should only continue in the case of the general suitability of BCT. Furthermore, in this context, the framework for application areas of BCT in logistics derived in chapter 4.2.1 and the applicability limitations derived in chapter 4.2.4 should be considered to evaluate the general applicability of BCT based on organizational and technological criteria. This assessment assumes that the user is familiar with the organizational and technological details of the use case derived from the initial requirements analysis as well as the technological basics as described in the previous chapters. The procedure provides a basis for analyzing the requirements of a network and an initial assessment of the applicability of BCT in the logistics network. This first phase is thus of crucial importance for the further procedure. It is namely the basis for the evaluation of a mindful technology adoption that follows in phase two.

The *second phase* is explanatory and utilizes the mindful adoption model for BCT in logistics by Verhoeven et al. (2018), which has already been presented in chapter 4.2.5 of this thesis. Based on the five mindful adoption principles engagement with technology, technological novelty seeking, awareness of local context, cognizance of alternative technologies as well as anticipation of technology alteration, users can analyze for specific use cases whether they follow a mindful approach.²⁴² The first two phases are therefore the starting point to assess whether BCT can be mindfully adopted regarding the requirements and prerequisites of the logistics network. In the event that this assessment is negative, the BCT implementation should be discarded and alternatives for the implementation should be sought. In the event of a positive assessment, the process will proceed to phase three. Following this, the interdependencies between the technology and sustainable aspects of the logistics network is the subject of phase three of the management model.

Therefore, following phase one and two, *phase three* starts, an additional explanatory phase of the model. Here, an impact analysis is used to evaluate the expected changes with regard to sustainability parameters at network level that may result from the use of BCT. These changes differ depending on the stakeholder and can have an impact in various dimensions. This phase is based on the findings of chapter 4.3.2 of this thesis. The considered stakeholders of the logistics networks are suppliers, manufacturers, customers, logistics service providers and government and society. Promising use cases focus on increasing sustainability throughout the entire network, from raw material suppliers to end customers, and enable end-

²⁴² Cf. Verhoeven et al. (2018) p. 6.

to-end transparency while taking data privacy and data security into account. The sustainability impact per stakeholder can be mapped in different dimensions. The main focus is on the distinction between direct and indirect impact on sustainability. As already explained in chapter 2.3.4, technology can contribute to increasing transparency by enabling measurement, reporting or improvement of sustainable parameters. BCT are particularly strong in the areas of measurement and reporting and can leverage the transparency factor for the benefit of all network participants, thus verifying social and environmental aspects of the network. For a detailed analysis of the implications for different stakeholders, see the overviews in chapter 4.3.2. Following phase three, another assessment is conducted to detect whether the sustainability goals be achieved by applying BCT. In the event that this assessment is negative, the BCT implementation should be discarded and alternatives for the implementation should be sought. In the event of a positive assessment, the user will proceed to phase four.

The *fourth and final phase* of the management model is the implementation phase for the development of BCT systems in logistics as elaborated in chapter 4.4.2. Based on the five management areas strategy and goals, internal organization, external collaboration, technology and implementation, design recommendations, management tools and instruments as well as success factors are outlined to support the successful development and implementation of these technologies. The starting point for the development is the definition of strategies and goals and the associated use case refinement, the definition of measurable parameters for evaluating the success of the BCT project, and the preparation for the expected decentralization. Subsequently, both internal company and network-wide preparations can be made. While internally the project has to be embedded in the organization, the company has to be prepared for the transformation by means of change management and employees with appropriate competencies and skills have to be trained or hired, external issues are mainly the establishment of a decentralized governance structure, the involvement of all stakeholders and a re-evaluation of the expected impact on sustainability parameters. Both internally and externally, knowledge management structures need to be established. The last management area before implementation deals with technology aspects. This includes the selection of the technology as well as the design of the system, considering mindful adoption and ensuring interoperability with legacy systems and other possible BCT systems. The project is implemented in the final management area implementation. The recommended procedure is based on an agile implementation and the development of prototypes while the entire process is continuously monitored and documented. At the end of phase four of the management model, the BCT system is fully implemented and ready for live network operation.

4.6 Exemplary application of the management model to case study B

In this chapter, the management model developed above is exemplarily applied to a case study to show how it would be applied in practice and what benefits it would bring to a specific case. This exemplary application is to be understood as part of the validation of the results of this thesis. The selected case study is case study B and therefore deals with the development of a BCT network for tracking and certification of ethically sourced raw materials from different metal industries.

Phase one: systematic identification and analysis of requirements and goals

The first phase of the developed management model for social and environmental impact in logistics through BCT is the systematic identification of internal and external requirements and goals including a first evaluation regarding the applicability of BCT in the logistics network for the specific problem by bringing together the framework of application areas as well as the applicability limitations of BCT. From an external perspective, there are two initial important requirements and goals. Legislation increasingly requires due diligence when importing raw materials from conflict regions into the EU. This requires that information about the origin of the product, the actors involved, and transparent evidence of the process steps along the entire logistics networks must be provided. However, certification of product origin and the materials used in the product is also becoming increasingly important from the (end) customer's perspective. Accordingly, transparent traceability of materials and processes as well as certification of products should be made possible as part of the project. First of all, from an internal perspective, compliance with the legal framework is important. There are also intrinsic efforts on the part of the manufacturers involved to operate logistics networks in an ethically sound manner and to maintain transparency about the network structure. The aim is thus to create a more efficient and trustworthy solution for passing on information across stakeholders and ruling out manipulation. From a technological point of view, real-time data gathering is desired, but transaction speeds in the millisecond range are not required. Currently, there is no central trust authority that is always available and can meet the requirements for transparent and trustworthy data storage, and all participants in the logistics network should be able to validate data and transactions. Interfaces to existing company systems are also expected to be developed in the future. Based on the aforementioned criteria, BCT is to be assessed as suitable from a technological perspective in order to enable the set requirements. In a subsequent step, the mindful adoption of the technology for the specific case is examined in the second phase of the management model.

Phase two: mindful adoption model for BCT in logistics

For phase two of the management model the five mindful adoption principles are assessed. Based on the developed model in chapter 4.2.5, five principles are relevant: *engagement with the technology*, *technological novelty seeking*, *awareness of local context*, *cognizance of alternative technologies* as well as *anticipation of technology alteration*. The first principle *engagement with the technology* requires that functionalities and features of the technology should be known thoroughly following a comprehensive technology understanding. For the case study under review, the technology was intensively studied and external partners with a great amount of expertise in the field of BCT were brought in. The partners were aware of possible entry barriers and aim to develop an in-house BCT solution in case public platforms like Ethereum or Hyperledger Fabric do not fulfill the long-term requirements. *Technological novelty seeking* requires that unique features of BCT are used to justify a mindful use. In case study B, this is the trust function, which in the present case enables traceable transactions in a trustworthy manner. The decentralized transparency can also be used to certify raw materials processed in batches. A prerequisite for this, however, is trust in the interface between the physical and digital world, which is covered by *awareness of local context*. This involves paying attention to local specifics and the corresponding effects of the technology including local needs, learning abilities, technical support, compatibility with implemented technologies and possible reactions of different stakeholders to the novel technology. A reaction to BCT in the first stages of the network could be a manipulation of the data input. Although the data is stored in a tamper-proof way, the success of the BCT solution stands and falls with an initial valid data input. This means it must be ensured that only certified mines can write to the blockchain and that only certified quantities are entered. In this case, therefore, cooperation with certification organizations takes place to initially qualify mines for the network. Subsequently, continuous plausibility checks of the certified quantities are carried out, for example, by comparing them with production capacities in order to prevent greenwashing of non-certified raw materials. Furthermore, a simple interface with low data consumption was created, considering local specifics, which also guarantees easy access in developing countries, and a qualification and training program for the use of BCT was established. In the context of *cognizance of alternative technologies*, the advantages and disadvantages of BCT should be compared with other alternative technologies in order to be able to make a realistic assessment of the benefits of BCT. In the present case, a deep examination of the problem and traditional approaches to solving it becomes apparent. The central problem is that full transparency is often not desired. BCT enable logistics networks to create transparency and privacy concurrently as well as ensure data self-sovereignty. Another problem is that commodity fungibles are not uniquely identifiable and the system has to be used by very small players

(artisanal and small-scale mines). Here, BCT offer the possibility to add new participants to the BCT system very quickly without much implementation effort. The need for a decentralized solution using BCT is therefore demonstrated in the case. The last mindful adoption principle is *anticipation of technology alteration*, which considers possible changes of the task for which the technology is utilized for and how the technology can or cannot be adapted to those changes. In the context of this, it is not currently apparent that the solution developed could be obstructed by a public system from the government side, as this is a cross-country problem. A central solution, for example developed by the OEM, also does not seem conceivable due to the obstacles described above. Changes in the process could instead be changes in the supplier network, which can be carried out efficiently and cost-effectively at the digital level as described using BCT. Furthermore, legal or internal requirements for the data collected and to be transmitted could change. These new data sets could also be enabled by small adjustments. Based on the analysis of the five mindful adoption principles described above in phase two and the initial assessment of technological and organizational applicability of BCT with respect to defined requirements in phase one, the case at hand can be assessed as very suitable for the use of BCT. Accordingly, in the third phase, an assessment of the social and environmental impact is made before the BCT solution is ultimately developed and implemented in the fourth and final phase of the management model.

Phase three: sustainability impact model for BCT in logistics

In phase three of the management model for social and environmental impact in logistics through BCT, the expected impact in the dimensions of social and environmental sustainability is assessed at stakeholder level. In this case, the relevant stakeholders are *governments, manufacturers, suppliers, LSP* as well as *end customers*. Taking a look at the impact dimensions it appears that the initiator here is public as it is driven by external legislation as well as private as it is also motivated by internal requirements to improve the social and working conditions within the logistics network. Depending on stakeholder (following below), the sustainability impact can be direct or indirect. While a direct impact in this case means an improvement of parameters of social sustainability, an indirect impact can be an improvement of the measurement or the reporting of social parameters. Within the dimension of alteration, it can be defined as an improvement of existing logistics process and not a fundamentally new business model. On stakeholder level different sustainable impact parameters can be evaluated to estimate the impact before pursuing the implementation in phase four. The first stakeholder group under considerations are *governments*. In this case they can ensure that the goals of their own guidelines and regulations with regard to a necessary due diligence for conflict materials are met. Furthermore, they can push stakeholders to gain the desired

transparency with regard to the origin of the goods imported and processed. The impact for governments is therefore indirect and leads to increased transparency for reporting issues. *Manufacturers* on the other side can first of all comply with existing regulation and improve their measurement and reporting of social sustainability in their supplier network with BCT. They can furthermore ensure that the code of conduct as agreed upon in the logistics network is passed down supplier stages. Responsible manufacturers can therefore rule out human rights violation by utilizing the enhanced transparency due to BCT on the origin of received goods and services and the corresponding working conditions. The information tracked and collected along the entire logistics networks could also potentially be used to inform customers about the socially responsible business politics of the companies taking part in the case study. *Suppliers*, especially in the early stages of the logistics network, can achieve a direct impact with regard to social sustainability. As only mines that are certified and prove their socially sound working conditions, can participate in the network, BCT creates motivation to comply with social standards in order to still be able to participate in global networks. Furthermore, the jobs get more qualified and a fair and stable payment can be guaranteed. Ultimately the increased transparency across stages within the network can be leveraged as competitive factor to substantiate arguments in the direction of other stakeholders or to achieve forecast and decision-making efficiency based on accurate and trustworthy data with BCT. In this case, *LSP* do not have direct improvements in their social or environmental sustainability, however, like manufacturers or suppliers, they can benefit from better reporting capabilities or utilize the increased transparency for improvements in forecasting processes to gain efficiencies in their processes and capacities, which could have an indirect impact on environmental factors by, for example, avoiding empty runs. The last stakeholder group that should be considered in the context of the sustainability impact model for BCT are *customers*. For customers, BCT create the possibility of sustainable consumption. The transparency of the technology increases the trust of customers in sustainable labels and certifications. The behavior of the customer has no direct impact on the social conditions in the logistics network, but as an external motivation for companies it is a driver of sustainable logistics networks that should not be neglected. Based on the assessment of the possible sustainable impact in phase three of the management model that can be achieved by the implementation of BCT as well as the initially defined requirements (see phase one), the sustainable problem with regard to transparency can be solved in the present case by means of BCT. Therefore, the fourth phase of the management model will be pursued, which includes the implementation of BCT in logistics.

Phase four: implementation of BCT in logistics

The fourth phase of the management model for social and environmental impact in logistics through BCT contains five management areas that guide the user through the implementation process: *strategy and goals*, *internal organization*, *external collaboration*, *technology* as well as the *implementation* itself. Depending on the management area, the user is provided with management tools and instruments, design recommendations and success factors to support companies in the implementation of BCT. The procedure as conducted in case study B shows an orientation on the five suggested management areas and can serve as an example on how to pursue BCT projects. Since the management model is a cross-case result, not all elements of the model were used in the specific implementation of case study B. Therefore, the main aspects of the individual management areas are highlighted in the following. In the management area *strategy and goals*, an overarching strategy as well as goals should first be agreed upon with the stakeholders. In the case of the raw material logistics network, this includes the improvement of working conditions in the mines and at the smelters in developing countries as well as the establishment of a reporting system in order to certify imported materials and to be able to prove their origin in accordance with existing regulations. The specific use case to be implemented results directly from these objectives and can be classified according to the application areas developed in chapter 4.2.1 under tracking and tracing as well as verification and certification. Furthermore, a measurement system has to be developed to measure the success of the project. Since the BCT project is intended to create cross-stakeholder transparency in a logistics network that includes raw materials processed in batches, the project's success is initially characterized by the feasibility of the planned project. In the further course, social parameters regarding health and safety of the employees, training and further education opportunities on site as well as compliance with applicable labor laws can be measured. In the second management area *internal organization* each of the involved companies has to ensure the necessary competencies, initiate the change management as well as embed the project within their organization. In the case study under consideration the required know-how was sourced externally by a technology provider to dedicatedly supported each of the involved parties with the planning and implementation process. To support the change management process, direct benefits were communicated to the operational personnel, that include more efficient processes as fewer audits are necessary (high cost for mines and smelters) and a more sustainable external perception with regard to working standards. Furthermore, a project champion and top management support were ensured to embed the project in the companies. The third management area *external collaboration* is of crucial importance for BCT projects as it is a cross-company technology implementation affecting central business processes. In this context, a governance structure for the project

and the operation of the BCT system as well as an efficient knowledge management system between the stakeholders should be established. Furthermore, it needs to be ensured that all stakeholders are involved and managed. The role of the knowledge management system to exchange information and experiences between the companies involved was taken by the external technology provider who will also ensure the governance of the system together with selected partners in a proof of authority consensus mechanism. To manage all stakeholders, a supply chain mapping was conducted to identify and evaluate all relevant stakeholders in the process from the mine to the customer. Since only small organizational changes occur, partners were prepared mainly for the technological changes. Thus, in the specific case, paper forms are omitted and instead digital inputs are used, the transaction of which is stored by using BCT. Before the implementation is pursued, *technology* is the fourth management area of the developed model. This involves the selection of the specific technology, the system design and ensuring interoperability. In case study B, Ethereum was initially selected as the BCT platform, but in the long term the solution should be blockchain agnostic and be able to run flexibly on other or the consortiums own platforms. As an important requirement, self-sovereignty was also included in the system design to avoid the conflict between data privacy and data transparency. It can thus be decided which data is private, shared only with direct partners, or shared with the entire network. Furthermore, it was decided to develop a web user interface to which all participants have transparent access. Ultimately, the last management area is the *implementation* itself, emphasizing an agile implementation, the use of prototyping as well as continuous monitoring and documentation of the project progress and results. While monitoring and documentation activities were mainly handled by the technology provider, a first prototype was jointly developed in an iterative approach and within a small environment involving key stakeholders before rolling it out network-wide as the final BCT implementation.

Concluding, the exemplary application of the developed management model for social and environmental impact in logistics through BCT as described in this chapter shows the validity of the model and gives an overview on how the model could be applied by professionals in practice. While the first three phases enable a profound evaluation and assessment of a BCT case in logistics with regard to organizational and technological capabilities (phase one), a mindful adoption (phase two) and possible sustainable impact (phase three), the fourth phase can be understood as a guideline for practitioners to pursue the implementation of BCT. Due to the diversity of application possibilities and constraints, this implementation phase is not a precise step-by-step procedure, but provides possible design recommendations, management tools and success factors that support the implementation in dedicated management areas.

5 Vision of future logistics networks and the role of blockchain technologies

This chapter provides an outlook on the future design of international logistics networks and the role of BCT in this context. To this end, it first explains the extent to which BCT can serve as a basis for communication infrastructure and as a decentral data basis. In a decentralized BCT logistics network, transactions are stored in a distributed ledger, which creates the possibility to merge data transparency and data privacy. Furthermore, the structural changes that could arise in logistics networks as a result of decentralization are presented. These changes are examined at the strategic, tactical and operational levels. The final part of the vision of future logistics networks and the role of BCT is an analysis of potential synergies between BCT and other digital technologies such as IoT, artificial intelligence or digital twins. The vision of future logistics networks and the role of BCT is therefore explained on three levels: *BCT as a communication infrastructure and data basis*, *structural changes in logistics networks through BCT* and *BCT in interplay with other technologies* as shown in Figure 44. The three different levels will be further explained in the upcoming chapters.

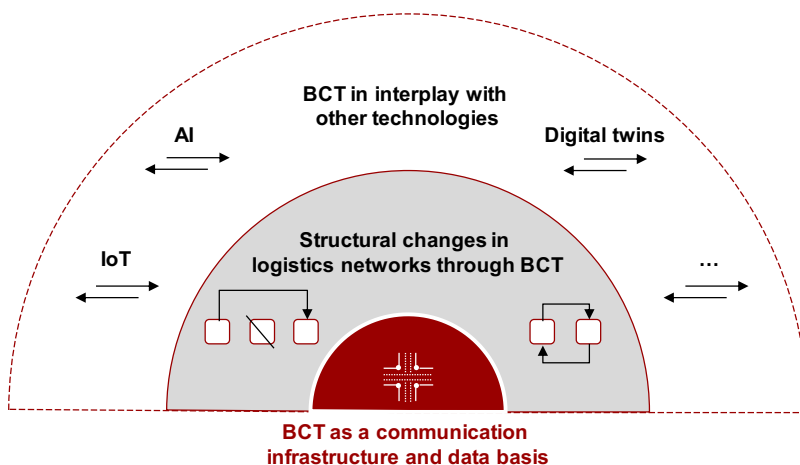

Figure 44: Observation levels of the vision of future logistics networks²⁴³

²⁴³ Own representation

The future structural changes in logistics networks by using BCT for decentralized data management as anticipated in this chapter are developed conceptually based on the research methods conducted in the thesis. The management model for social and environmental impact in logistics through BCT developed in chapter 4 can be understood as a guide for companies for the transition from traditional logistics to decentralized logistics using BCT. The anticipated changes are not considered an end in themselves and it must be decided in the future for each use case whether the use of BCT is mindful. Here, the mindful adoption model for BCT in logistics included in the management model provides support. The proposed five principles enable companies to critically reflect on whether, in a specific case, organizational and process requirements match technological functionalities, conditions in the logistics network have been considered, and whether the use of alternative technologies (also in the event of possible future changes) is to be preferred under certain circumstances. While the focus of this chapter on developing the vision of future logistics networks and the role of BCT will be broader and no longer limited to social and environmental sustainability, the sustainability impact model can also be used by companies to better understand the sustainability topics only briefly touched upon in chapter 5.2 and to draw implications and conclusions for their own company or network on the potential for sustainability improvements using BCT. Ultimately, the fourth phase of the model, as described in chapter 4.4, supports companies in the implementation of BCT in logistics and is thus a basis for implementing the aforementioned technological changes from data structures in logistics networks to a decentralized, distributed governance. Thus, the developed management model for social and environmental impact in logistics through BCT is to be understood as a holistic decision support and implementation planning tool to achieve the expected paradigm shifts described in this chapter through the use of BCT in logistics networks.

5.1 Blockchain technologies as a communication infrastructure

BCT can represent an important component of decentralized communication infrastructure in future logistics networks and serve as a distributed data basis.

Transactions carried out in the network can be stored in distributed ledgers in a tamper-proof and traceable manner. It enables end-to-end transparency while ensuring data privacy by providing private or viewable up-chain data encrypted with public and private keys. Data based on BCT is stored decentrally in distributed networks. As there is no central authority and no intermediaries for data management, processes could become a lot more efficient through peer-to-peer transactions. Every transaction by one of the participants is validated with the BCT mechanisms and afterwards distributed across the network to each copy of the ledger.

Furthermore, each participating actor in the international logistics network can decide whether to additionally host its own node of the BCT. By means of these distributed copies of the BCT, a valid database can still be found via majorities in the event of manipulation of individual data sets. Stored data or transactions are immutable and tamper-proof and can therefore hardly be manipulated. The entire transaction history is visible and thus traceable, which results in more transparency and trust in the network. Public key cryptography and hash functions ensure the authenticity and integrity of the data and guarantee a high level of security. The BCT thus offers the possibility of a very secure, decentralized and traceable data basis for logistics. BCT enable direct peer-to-peer communication between individual actors without the need for intermediaries and, in addition, on-chain decentralized applications can be implemented which can be used decentrally among the participants. For example, real-time decisions can be made via smart contracts, which can be executed automatically on the basis of transactions. This decentralized data basis is supported by additional off-chain confirmation data that can be recorded for example via IoT sensors.

This embedding of logistics networks in distributed ledgers changes the communication between the stakeholders of the network. While visibility in traditional logistics networks often cannot be fully replicated, distributed ledgers enable more transparency and traceability of logistics decisions and thus end-to-end visibility. Furthermore, communication in logistics networks often takes place via intermediaries, central entities that mediate between two parties. Due to the decentralized nature of BCT, all communication can be mapped directly peer-to-peer, thus enabling more efficient and effective communication. Documents are also an essential part of communication in logistics. With the help of BCT, these can be digitized in a decentralized manner, which leads to more efficient and transparent processes during handling. In addition, BCT enable the integration of data stored across different storages and the assurance of data integrity. This enables the utmost openness while preserving data control and privacy. The expected changes on the communication level are shown in Table 37.

Criteria	Traditional logistics	Decentral logistics and BCT	Implication for logistics networks
Visibility	Often limited to direct business contacts due to information barriers	Enables end-to-end visibility through access to distributed ledger	End-to-end visibility enables more transparency and traceability of logistical decisions
Intermediation	Intermediaries necessary to connect stakeholders	Direct peer-to-peer communication without intermediaries	More efficient and effective communication through direct connection
Documents	Documents often have to be physically transported with the goods	Support the decentral digitalization of documents	Digitalization of documents increases efficiency and transparency regarding accountabilities
Connectivity	Seamless communication across company borders difficult due to system discontinuities	Integrate data stored across different storages and ensure data integrity	Integration paired with peer-to-peer communication enables the utmost openness while preserving data control and privacy

Table 37: Expected changes on the communication level²⁴⁴

²⁴⁴ Own representation

5.2 Structural changes in logistics through blockchain technologies

BCT will change future logistics networks. The inherent functionalities such as decentralization, immutable data storage, transparency, security and smart contracts will influence operational as well as tactical and strategic processes and the nature of cooperation in networks. New forms of cooperation are emerging, previous structures are dissolving, new ones are forming and the foundations are being laid to pave the way for decentralized logistics networks of the future. In the following, a vision of future decentralized logistics networks with BCT is sketched on the basis of the changes to be expected at the strategic, tactical and operational levels when comparing traditional logistics networks with decentralized networks through BCT.

Figure 45 shows the evaluation framework for the structural changes in logistics networks through BCT. In the following, the strategic, tactical and operational levels are considered in more detail.

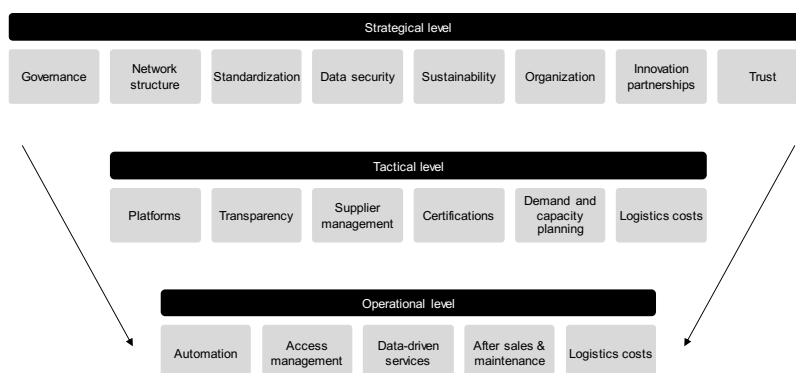

Figure 45: Evaluation framework for the structural changes in logistics through BCT²⁴⁵

At the *strategic level*, the management and control of the network will shift in decentralized logistics networks. In the future, these mechanisms could be distributed within the network and thus enable self-control and autonomy. While previous logistics networks rely heavily on intermediaries and brokers to organize their processes, these can be abolished without substitution in decentralized structures with peer-to-peer relationships. This primarily affects the networks' financial and information flows. For example, distributed structures leave financial service providers or central platform providers redundant. BCT continue to help in the future design of standardized solutions and industry-wide interoperable systems. Thus,

²⁴⁵ Own representation

previous system bridges can be overcome and a valid data basis for further services can be created. In the area of data security, the technology supports the protection of data against unauthorized access and also against manipulation through traceable transaction histories. Sustainability initiatives can gain the necessary transparency through the technology, whereby sustainable effects on a social, environmental and economic level can be measured and reported in a traceable manner. Network partners and end customers can thus be given insights into sustainable logistics networks without having to disclose business secrets. The organization itself can also be set up in a decentralized and autonomous manner based on decentralized technologies. Innovation partnerships can be promoted through the decentralization of data by making proprietary data available to on-chain services and thus monetizing it in a traceable manner. In the future, this possibility will make it more attractive for companies to exchange data across company boundaries. Finally, the role of trust in logistics networks is changing at the strategic level. Whereas in traditional networks this is sometimes necessary to establish business relationships, BCT assume this role in decentralized networks by means of consensus mechanisms, an unchangeable transaction history and rules agreed upon, such as smart contracts.

The expected changes on the strategic level are summarized in Table 38.

Criteria	Traditional logistics	Decentral logistics and BCT	Implication for logistics networks
Governance	Steering through a strong central actor	Power and steering distributed in the network	Redistribution of market power possible
Network structure	Networks heavily rely on intermediaries and central processes	No intermediaries required through peer-to-peer connections	More efficient business relationships are feasible
Standardization	Limited standardization, media discontinuity and scattered data	Consistent standardization and compatible database across companies	Dependent on the development of standardized BCT guidelines
Data security	Susceptible to manipulation and cyber attacks	Data immutability and high encryption standards	Data security will be enhanced through BCT
Sustainability	Sustainability efforts often fail due to lack of transparency	End-to-end transparency and proof of sustainability	Improving sustainability and transparent measuring and reporting
Organization	Centrally controlled organizations	Decentralized autonomous organization	High degree of flexibility and agility, but difficult performance measurement
Innovation partnerships	Open innovation poses challenges, especially in the competitive environment	Clear data ownership incentivizes open innovation and provision of own data	Better data basis and possibility of higher innovation capability
Trust	Trust or control required for business relationships	No trust required and decentralized control mechanisms	Trust in technology is a prerequisite for trustless processes

Table 38: Expected changes on the strategical level²⁴⁶

Taking a glance at the *tactical level* reveals that BCT will lead to paradigm shifts here as well. While platforms have recently become more popular in logistics, they are usually centrally organized and operated by a neutral authority to establish trust and provide the marketplace. BCT enable peer-to-peer platforms to be organized without intermediaries, making them much more efficient and cost-effective, and enabling direct exchange of products, services, and financial assets. In terms of transparency, BCT manage to break with a paradigm that presumes to have to choose between data transparency and data privacy. BCT enable logistics networks to create transparency and privacy concurrently as well as ensure data self-sovereignty. In traditional logistics networks, companies face the challenge of highly distributed and deep supplier networks in the context of supplier management, which often makes insights into sub-suppliers impossible or untrustworthy. Decentralization helps to break through these information barriers and enables traceability and insight into the entire logistics network to support supplier management and gather the relevant data from all actors needed. Certificates are an important part of logistics networks for proving origin and standards in a logistics network. Traditionally, labels are used for this purpose, which are neither comprehensible nor understandable for everyone. Often, these certificates are also subject to manipulation. BCT enable traceable and trustless solutions that can be implemented end-to-end in the logistics network and can be verified from the raw material to the end customer without the possibility of manipulation. Demand and capacity planning is an important part of any logistics networks. Both in the medium term and on a daily basis, it is essential to exchange information across company boundaries in order to design production programs in accordance with demand and supply. While in traditional logistics networks information barriers obstruct collaborative planning, BCT and a distributed database can enable secure information sharing (see also resolution of the conflict of the objectives data transparency and data privacy above). Furthermore, in traditional logistics networks high costs incur for information gathering, coordination and decision making. Due to the decentralization and transparency of data when using a distributed ledger such as BCT, the costs for this are significantly lower in decentralized logistics networks as a higher level of integration can be achieved. Nevertheless, development and implementation costs incur, which have to be compared on a case-by-case basis with decreasing costs at the operational and tactical level as well as benefits that can be monetized and those that cannot (see also chapter 4.2.4).

The expected changes on the tactical level are summarized in Table 39.

Criteria	Traditional logistics	Decentral logistics and BCT	Implication for logistics networks
Platforms	Central platforms with neutral authority create trust	Decentralized platforms without intermediaries	Enables efficient peer-to-peer exchange of products and services
Transparency	Decision between data transparency or data privacy	Enables transparency and privacy concurrently as well as data self-sovereignty	Increased transparency may not be welcomed by all actors
Supplier management	Communication with and transparency in sub-supplier difficult due to information barriers	Enables traceability and insight into the entire network to support supplier management	Overcoming information barriers and stimulating cooperation
Certifications	Certifications require trust in labels and are not comprehensible	Traceable and trustless certifications possible	Initial higher effort, but higher transparency for customers and partners
Demand and capacity planning	Information barriers obstruct collaborative planning	Secure information sharing supports collaborative planning	Ways to monetize planning data must be discovered
Logistics costs	High costs for information gathering, coordination and decision making	Less costs for information gathering, coordination and decision making	Medium-term logistics costs will decrease

Table 39: Expected changes on the tactical level²⁴⁷

Ultimately, decentralized structures also change the *operational level*. With regard to automation, BCT also makes cross-company solutions more conceivable. For example, smart contracts enable the data-driven automatic execution of transactions based on events. Access management can also be mapped decentrally and thus supports single sign on across service boundaries. In addition, data-driven services are enabled in BCT solutions because, compared to traditional logistics networks, data sharing is encouraged by opportunities to monetize one's

²⁴⁷ Own representation

own data while still being in control of it, thus overcoming hurdles in data exchange. Furthermore, after sales, maintenance and recycling also benefit from decentralization on an operational level by leveraging the transparency in terms of product and material history provided by BCT. Ultimately, similar to the tactical level, the structure of logistics costs alters. While traditional logistics networks incur costs for the services of intermediaries, these can be eliminated in BCT systems and replaced by peer-to-peer relationships. However, it should be noted that depending on the platform and blockchain type used, transaction costs may incur, especially in open BCT solutions.

The expected changes on the operational level are summarized in Table 40.

Criteria	Traditional logistics	Decentral logistics and BCT	Implication for logistics networks
Automation	Automation of processes within company borders	Automation between companies	Trans-company automation through smart contracts possible
Access management	Centralized access management requires new registration for new services	Decentralized access management supports single sign-on solutions	Access to services is simplified, but requires collaboration at master data level
Data-driven services	Hurdles in data exchange due to lack of incentives	Data sharing is encouraged by opportunities to monetize own data	Data sharing while still being in control of own data feasible
After-sales and maintenance	Knowledge of product history often incomplete and not known across all stages	Knowledge of product history simplifies after sales, maintenance and recycling	Increases efficiency and safety of products
Logistics costs	Additional costs for services from intermediaries	Elimination of costs for intermediaries, but additional costs for BCT transactions	Short-term logistics costs can decrease or increase based on the system

Table 40: Expected changes on the operational level²⁴⁸

²⁴⁸ Own representation

5.3 Blockchain technologies in interplay with other technologies

In the following, the interaction of BCT with three promising, disruptive technologies in logistics networks is explained using the Internet of things, artificial intelligence and digital twins as examples.

5.3.1 Blockchain technologies in interplay with the Internet of things

The Internet of things (IoT) describes a system of physical devices with network and connectivity functions and computers that communicate with each other. Driven by rapid developments in software and hardware, IoT applications have gained in importance in recent years. The areas of application range from industrial to private and public sectors.²⁴⁹ They can be classified into four dimensions: transportation and logistics, healthcare, smart environment (e.g. smart home), as well as personal and social applications. IoT networks are often heterogeneous systems with different end devices and protocols. This results in the following IoT-specific characteristics. On the one hand, the networks consist of a large number of nodes (which are tending to increase) and big data. As a result, the demands on the infrastructure with regard to the collection and analysis of data are also growing. Due to the heterogeneous and distributed nature of IoT networks, they are characterized by decentralization. This decentralization is necessary to evaluate the multitude of existing nodes simultaneously and decentralized algorithms support the improvement of capacity and scalability of these networks. Furthermore, IoT networks are characterized by unstable and unpredictable connections due to sleep / idle mode of the devices as well as unreliable wireless links and the network may have disconnected partitions at times. However, a look at the security of IoT networks reveals some vulnerabilities. These include attacks to end devices, communication channels or network protocols. Sensor data and software can also be the target of attacks, as well as denial of service (DoS) attacks. BCT can contribute to the security of these networks due to inherent properties such as decentralization, integrity and anonymity.²⁵⁰ A comparison of the two architectures BCT and DAG shows clear advantages for DAG in the context of IoT, as they are more scalable and can enable faster transactions. This is of immense importance given the large number of transactions in IoT networks. In addition, there are no transaction costs and the algorithms are resistant to brute force attacks.²⁵¹

²⁴⁹ Cf. Lao et al. (2020) pp. 4–5.

²⁵⁰ Cf. Wang et al. (2019b) pp. 11–13.

²⁵¹ Cf. Pervez et al. (2018) p. 29; cf. Zhao/Yu (2019) p. 507.

Table 41 summarizes the requirements of the IoT and outlines how BCT and specifically DAG can support.

Requirements of the Internet of things	Functionalities of BCT and DAG
Scalable and fast transactions	<ul style="list-style-type: none"> • DAG are highly scalable (throughput grows with network) and enable faster transactions
Security of sensor data and software	<ul style="list-style-type: none"> • Cryptographic hashing and encryption functions • Provenance and auditability of data
High requirements on infrastructure with regard to the collection and analysis of data	<ul style="list-style-type: none"> • Multiple participants to write, read and control data • Database accessible from multiple locations

Table 41: Benefits of using BCT for IoT²⁵²

Technologically, a five-layer architecture for an IoT BCT is conceivable. Which combines features of existing IoT as well as BCT systems. The physical layer consists of various IoT devices such as mobile phones, sensors or RFID tags. The network layer is similar to traditional BCT systems and is responsible for routing protocols, internetworking and multicasting between the various IoT devices. The BCT layer in turn provides functionalities of the BCT. These include decentralized consensus, data storage and data sharing. The middleware layer is different from conventional IoT systems. In this context, it is responsible for security services, BCT management and BCT service integration. The last layer is the application layer. It enables user interactions via application interfaces and is thus similar to traditional IoT or BCT architectures.²⁵³

5.3.2 Blockchain technologies in interplay with artificial intelligence

Artificial intelligence (AI) refers to programs or machines that perform tasks that require intelligence. This often relates to human-like intelligent behavior such as planning, learning, and problem solving, as well as creative and social tasks. Especially machine learning and

²⁵² Own representation

²⁵³ Cf. Lao et al. (2020) pp. 11–12.

deep learning have gained popularity in recent years due to new dimensions of data availability enabling effective learning of algorithms.²⁵⁴

BCT and artificial intelligence are two key drivers of innovation in logistics and a combination of these two disruptive technologies promises great potential. The combination of this technology can go in two directions: AI for BCT or BCT for AI. The respective conceivable application scenarios are shown in Table 42 and are explained in more detail below.²⁵⁵

BCT for AI opportunities	AI for BCT opportunities
<ul style="list-style-type: none"> • Secure data sharing and marketplace for AI • Decentralized computing for AI • Explainable AI • Coordinating untrusting devices 	<ul style="list-style-type: none"> • Secure and scalable BCT • Privacy-preserving personalization • Automated referee and governance

Table 42: Integration of AI and BCT²⁵⁶

The integration of these technologies attempts to address the inherent problems of each technology alone and to complement each other. While BCT main problems are security, scalability, and efficiency, AI has weaknesses in trustworthiness, explainability, and privacy. Thus, BCT can support AI systems through trustlessness, privacy, and explainability, and BCT systems can become more secure, scalable, and effective in terms of services and governance through AI and machine learning algorithms.²⁵⁷ BCT for AI is described by four possible integration scenarios, which are explained below.

Big amounts of data play a major role in the context of successful AI systems. However, access to this data and privacy can present challenges for some companies and networks. BCT can enable *secure data sharing* by ensuring transparency and accountability regarding the use of data. It is therefore traceable who has used whose data for what. This puts control of one's own data back into the hands of the user and thus creates trust with regard to data sharing. In

²⁵⁴ Cf. Dinh/Thai (2018) p. 32.

²⁵⁵ Cf. Corea (2019) pp. 21–25; Dinh/Thai (2018) p. 32.

²⁵⁶ Own representation based on Dinh/Thai (2018) p. 33.

²⁵⁷ Cf. Dinh/Thai (2018) p. 34.

addition, smart contracts implemented on the BCT could be used to organize not only the controlling and sharing of one's own data, but also the sale of this data in a decentralized manner. This would enable data marketplaces without intermediaries and lower entry barriers for smaller companies. In addition, the data could be used without disclosing details of the data or the owners of the data. Another possibility of combining BCT and AI is the sale of *computing power via decentralized marketplaces*, thus BCT-based cloud computing. Developers of AI systems can draw on the computing power of multiple users who provide it via AI smart contracts. While previous solutions without BCT, such as grid computing, had limitations and were not suitable for the mass market, this seems to be a promising scenario for AI-supported cloud computing. Moreover, BCT could support *explainable AI* algorithms. Machine learning algorithms enable autonomous systems with the ability to self-learn, and it is becoming increasingly difficult to understand the resulting black boxes. These unexplainable decisions can thus not be verified and trusted, which often leads to AI systems not being used. There are major concerns, especially in the context of medical technology and finance. BCT enables an immutable trail regarding the data flow and could thus explain the behavior of machine learning systems by tracking every step in the data processing and decision-making chain. This creates trust in the decision-making of these systems and makes individual decisions verifiable and justifiable. BCT could further help in the *coordination of untrusting services*. In scenarios where swarm robotics, Internet of Thing devices, or cell phones make shared, decentralized decisions, BCT can serve as a secure coordination platform. Traditional platforms offer a single point of failure and are therefore highly vulnerable to network attacks (e.g. commands for botnets and malware programs). BCT, on the other hand, enables consensus building via majorities and thus provides a secure alternative.²⁵⁸

In turn, existing BCT systems can also benefit from the use of AI. Three conceivable scenarios are explained in more detail below. BCT are very secure systems and not very susceptible to hacks. Nevertheless, applications and functionalities implemented on the BCT are not quite as secure. In the past, there have been cases of major damage caused by attacks on BCT systems. AI and machine learning algorithms can therefore support *security and scalability* by detecting attacks and automatically activating appropriate defense mechanisms. Furthermore, detected vulnerable components of the BCT network could be isolated. Another use case regarding scalability is the detection of high transaction numbers and the adjustment of the block creation rate. This leads to a higher throughput of transactions with a longer confirmation time. Another scenario for BCT for AI is *privacy and personalization*. BCT enable control over personal data in decentralized networks. However, this gain in privacy comes at the cost of

²⁵⁸ Cf. Dinh/Thai (2018) pp. 34–35.

reduced personalization, as the data is not stored centrally with providers and companies and is not visible. By using AI, both privacy and personalization could be achieved. Machine learning programs that run decentrally on the user's side and thus personalize without having to store data centrally are conceivable. The entire computing performance is thus provided locally and user data does not have to be collected centrally. AI decisions are therefore subject to a pull principle and no longer to a push principle. These pulling-based models guarantee both privacy and personalization. Finally, the use of AI in BCT systems opens up the possibility of *automated governance*. Previous smart contracts are based on simple decision rules and represent contracts that are characterized by little complexity. The ongoing development of AI and machine learning in particular is able to provide governance for more complex problems. Thus, problems could be solved faster and autonomously both on-chain and off-chain. Exemplarily, machine learning algorithms could perform unbiased and tamper-resistant reviews after providing documents and make decisions automatically. These data-driven decisions would be consistent and comprehensible to all users. AI can thus support BCT, which are characterized by a variety of parameters and tradeoffs between security, performance, decentralization, and others, by assisting in decision-making, automation, and optimization, enabling better performance and governance, as well as ensuring user confidentiality and privacy.²⁵⁹

5.3.3 Blockchain technologies in interplay with digital twins

The term *digital twins* is applied to digital replicas of processes, products, assets or entire systems, which thus represent a digital simulation and an image of physical reality. Digital twins can be used to manage devices and assets in logistics networks or to carry out simulations and assess effects in advance. It is essential to ensure transparency, trust and security of these digital twins.²⁶⁰ In the following, the extent to which BCT can support this is explained. Table 43 summarizes the data requirements of digital twins and the corresponding technical functionalities provided by BCT.

By storing data on distributed ledgers and cryptographic hashing, the platform and the data of the digital twin itself can be protected. The immutability of data on BCT and BCT enables a traceable transaction history and trust as well as integrity of the data. BCT can also serve as an anti-theft mechanism and provide digital certificates for assets. Thus, among other things, it could be possible to trace where products were manufactured and what the ownership structure is. Thus, proof of legitimacy and identity of digital twins is created. The

²⁵⁹ Cf. Dinh/Thai (2018) pp. 35–36.

²⁶⁰ Cf. Yaqoob et al. (2020) p. 290.

implementation of BCT for digital twins and the accompanying distributed database can enable the identification of assets and global tracking from origin to current time. While traditional access controls are also vulnerable to attack, BCT eliminate these risks that can lead to unauthorized access or tampering. Communication with IoT devices, which is often important for digital twins, can also be handled securely via BCT (see chapter 5.3.1 on BCT in interplay with the Internet of things). Finally, BCT can ensure transparency and accountability of the digital twins through encryption and control mechanisms such as smart contracts and chaincode.²⁶¹

Requirements of digital twins	Technical functionalities of BCT
Decentralized and immutable data transactions of digital twins	<ul style="list-style-type: none"> • Cryptographic hashing • Distributed ledger
Digital twin's identity and legitimacy	<ul style="list-style-type: none"> • Digital certificate of each asset • Anti-theft mechanisms
Trusted digital twin data coordination	<ul style="list-style-type: none"> • Multiple participants to control data • Consensus mechanisms
Access privilege of digital twins	<ul style="list-style-type: none"> • Distributed access control lists
Transparency and accountability for digital twin's data	<ul style="list-style-type: none"> • Encryption • Control mechanisms
Global tracking of digital twins with high accuracy	<ul style="list-style-type: none"> • Accessible database from multiple locations • Provenance and auditability

Table 43: Benefits of using BCT for digital twins²⁶²

²⁶¹ Cf. Yaqoob et al. (2020) pp. 291–292.

²⁶² Own representation based on Yaqoob et al. (2020) p. 291.

6 Conclusion and outlook

This chapter is the final chapter of this thesis and provides a concluding summary of the topic under consideration as well as an outlook. For this purpose, the central results of the thesis are summarized first. Afterwards, the scientific as well as the managerial contributions of these results are discussed. Subsequently, the thesis and the methodological approach as well as the results are critically evaluated and finally an outlook regarding future research and practical developments is given.

6.1 Summary

The summary of this thesis is based on the four primary and three secondary research questions stated at the beginning in chapter 1.2 on research objectives, approach and thesis outline.

1. *What are current trends and challenges in international logistics networks? How important is environmental and social sustainability in the context of logistics? How can digitalization impact environmental and social sustainability?*

International logistics networks are currently influenced by seven global mega trends. These are sustainability, digitalization, connectivity and transparency, decentralization, resilience, globalization and customer orientation. This in turn leads to a number of challenges in international logistics networks. Complex networks with many players are characterized by high dynamics and a large number of internal and external influencing factors. Increasingly, digitalization is advancing and with-it requirements for transparency, interoperability and automation. An important cross-cutting issue here is sustainability as a central subject of this time. It can be defined in three dimensions: economic, environmental and social, whereby the focus in this thesis is on the environmental and social dimension. Sustainable goals in logistics include the minimization of resource consumption and material turnover, the creation of material cycles at the highest possible level, compliance with social standards and an economic profit. Digital technologies are of particular importance in this context. They can contribute to more sustainability by directly affecting improvements or indirectly enabling measurement and reporting of sustainable aspects and thus contributing to transparency. These research questions and the research conducted to answer them support the relevance of the subject of this thesis, which aims to investigate the environmental and social impact of BCT in international logistics networks. Accordingly, this thesis assumes that future networks can only be successful if a sustainable approach to business is at the forefront and that BCT play a major role in achieving a higher degree of sustainability in international logistics

networks. The focus was placed on the environmental and social dimensions of sustainability, with the economic dimension being included where necessary.

II. What are functionalities and architectures of BCT?

The technology underlying this thesis is BCT and the technology family distributed ledger technologies (DLT). In order to further understand the interdependencies between BCT, international logistics networks and environmental and social sustainability, it was initially necessary to analyze functionalities and architectures. Based on the literature, the technological functionalities and architectures were explained accordingly and a typology of different BCT was identified. DLT refer to technologies that do not store transactions centrally in one entity, but store copies of the ledger in a decentralized manner in a network of several entities. New transactions are stored in all copies of the ledger. The best-known and most widespread representatives of these technologies are BCT, but directed acyclic graphs (DAG) can also play an important role in the context of logistics, which is why both technologies were examined in this thesis. The main differences between these architectures lie in the transaction speed, cost and scalability of the decentralized systems. The functionalities of BCT can be described on the basis of five characteristics: decentralization, immutable data, transparency, security, smart contracts. Data based on BCT is stored in decentral and distributed networks. There is no central authority and no intermediaries for data management. Stored data or transactions are immutable and tamper-proof and can therefore hardly be manipulated. The entire transaction history is visible and thus traceable, which results in more trust in the network. Public key cryptography and hash functions ensure the authenticity and integrity of the data and lead to a high level of security. Furthermore, decentralized services can be implemented on BCT as smart contracts can trigger data-driven transactions. BCT thus offer great potential to solve some of the previously described problems in international logistics networks with regard to sustainability, transparency and trust. Furthermore, it is possible to differentiate BCT between private and public as well as between permissionless and permission-based systems, which offers the possibility to control the degree of transparency and access depending on the application. The spectrum and evaluation of application areas of BCT in logistics as well as related implementation challenges were the subject of the following research question.

III. How does a management model for social and environmental impact in logistics through BCT look like?

- a. What is the status quo of BCT in logistics in research and practice? What are challenges and relevant application areas of BCT and how can a mindful adoption of BCT be ensured?

Due to its functionalities, BCT offer a wide range of applications in logistics. In this thesis, five application areas were identified by conducting a systematic literature review with 53 relevant publications followed by Q-methodology: *tracking and tracing*, *financial operations*, *verification and certification*, *planning and network* as well as *automation and IoT*. *Tracking and tracing* use cases especially rely onto the immutability of the data and the resulting increased transparency, which BCT enable. Related applications provide the functionalities to prove the product origin or enable an end-to-end visibility for all stakeholders across the entire logistics network. BCT furthermore enable a variety of *financial operations* that can be carried out more efficiently and cost-effectively. The application in this field is the execution of financial transactions between companies without intermediaries such as banks and payment administrators, but also includes the support of activities such as customs clearing and audits. The increased transparency and data reliability that comes with the implementation of BCT enable more trustworthy processes of *verification and certification*. Exemplary applications include the verification of products and assets, digital identity of costumers and other network participants as well as supportive functions in the supplier management. In the context of *planning and network*, through a close interlocking of the actors, new forms of collaborative planning and network control are possible with BCT. This not only includes integrative capacity planning approaches, but also peer-to-peer (P2P) platforms, which provide a more efficient and cost-effective exchange of goods, services or information without intermediaries. Ultimately, *automation and IoT* represent one of the most promising application areas of BCT by combining the technologies with IoT devices or other automation software and hardware. In addition, smart contracts, which are data-based decision models that autonomously trigger transactions as soon as defined events are fulfilled, can be implemented on BCT. Especially for IoT, DAG are conceivable, which enable transfers of small data points with little or no value by means no transactions costs. In addition to identifying these application areas, the status quo in logistics was surveyed. Along with the application status and the implementation horizon, the BCT applicability for this application area, the maturity of the application as well as the expected benefit and complexity related to the implementation were evaluated. The results show that especially the application areas of *tracking and tracing* and *verification and certification* stand out in terms of implementations and pilot applications that have already been adopted. According to the survey that was conducted among 20 industry and technology experts, these application areas also have the highest degree of applicability for BCT and are

characterized by a high degree of application maturity. Following the identification and evaluation of application areas, the core challenges for the implementation of BCT systems were identified in a nominal group technique workshop with managers from manufacturing industries, logistics service providers as well as technology providers. Those challenges can be defined on the basis of five key topics: *strategy*, *internal organization*, *technology*, *collaboration* and *governance*. The results show that initial challenges include the identification of use cases and the embedding of the project in the organization to create acceptance as well as to make the project success measurable. Furthermore, the selection of technologies and ensuring cross-platform interoperability and standardization as well as the integration of these into existing IT systems are major challenges for BCT systems in logistics. From an organizational perspective, BCT require the involvement of a large number of players for meaningful use cases, which in many cases requires decentralized governance to organize the collaboration in the network. Other challenges include regulatory obstacles such as data privacy and the compliance with existing legislation. Furthermore, technological and organizational applicability limitations of BCT were considered. These include, among others, the lack of scalability, the limited application to cross-company problems, the possible lack of responsibility due to the absence of central instances, and cost dimensions in the implementation and operation of BCT. Ultimately, the developed mindful adoption model for BCT in logistics was introduced which enables the evaluation of specific use cases based on the five mindful adoption principles *engagement with technology*, *technological novelty seeking*, *awareness of local context*, *cognizance of alternative technologies* as well as *anticipation of technology alteration*. It highlights the importance of the fit between task and technology for the success of BCT in logistics as the promised potentials of these technologies only materialize if their features are applied appropriately to suitable problems.

III. *How does a management model for social and environmental impact in logistics through BCT look like?*

b. *What is the social and environmental impact of BCT for stakeholders of logistics networks?*

Based on application areas and functionalities of BCT, it was investigated to what extent different stakeholders in international logistics networks are affected by the use of BCT in environmental and social parameters and what impact can be expected. Methodologically, this research is based on another workshop that was conducted online with representatives of different industries. The core of the workshop was the discussion of three different international logistics networks and the expected changes per stakeholder through BCT. Exemplary stakeholders were identified on the basis of three logistics networks, which can be condensed

into five relevant stakeholder levels: *manufacturer*, *supplier*, *logistics service provider*, *customer* as well as *government and society*. The impact can initially be described in abstract terms in three dimensions. In addition to the initiator (public or private), a distinction is made between a direct or indirect sustainability impact and the alteration, i.e. whether it is an improvement of existing processes or the enablement of new processes or even business models. The results lead to the sustainability impact model for BCT in logistics, which describes the social and environmental impact per stakeholder and defines success factors and enablers per stakeholder. *Manufacturers* can ensure that the code of conduct is passed down the logistics network and be compliant with OECD and emission guidelines as well as legal requirements (e.g. EU regulation with regard to conflict materials). Therefore, through the use of BCT, they can be assured that no human rights violations happen within their own logistics network and furthermore get insights on the behavior of suppliers and service providers. The main impact for *suppliers* lies in the compliance with human rights (e.g. no child labor) and a better work environment. New and higher educated jobs can be created especially at the stage of raw material suppliers and a stable and fair payment as well as higher margin by removing intermediaries can be guaranteed. Social and environmentally friendly products can be leveraged as competitive advantage. In logistics networks that involve end *customers* those can benefit from the utilization of BCT by getting the ability to reliably consume sustainable products and services as well as gaining trust in packaging and logistics labels (e.g. product origin or CO2 foot print) and an overall transparency regarding the consumed products. *Logistics service provider* on the other hand profit by the transparency of goods that leads to increasing forecasting quality and efficiency gains that can also directly impact environmental variables. Furthermore, they are enabled to increase recycling rates and grow circular loops and economies. Finally, *government and society* can leverage BCT to ensure that goals of own guidelines and regulation are met and to push all stakeholders in the direction of more socially and environmentally friendly logistics networks by gaining transparency. Furthermore, they can utilize the technology for taxation and other governmental tools for efficiency and transparency gains. Therefore, the sustainability impact model and the insights gained from it are an important element for understanding the impact of BCT with regard to social and environmental sustainability in international logistics networks. For each stage of the logistics network, based on the representative studies of use cases, the impact model can be used to assess the implications for each stakeholder in advance of an implementation and to track the sustainability impact during and after the implementation in a structured way. The results are thus also an essential component of the management model for social and environmental impact through BCT in logistics and can be found in phase three therein.

III. *How does a management model for social and environmental impact in logistics through BCT look like?*

c. *How can BCT be implemented in logistics networks? What are management areas and design recommendations?*

The developed management model for social and environmental impact in logistics through BCT is the key result of this thesis. It consists of four phases with descriptive, explanatory and design elements and builds on previous findings of the thesis. Furthermore, case studies from different industries were conducted to further enhance the results with a focus on various management areas. As the phases consist of explanatory and design elements, the model allows the user to develop a BCT system, from the definition of a strategy to the final implementation. The first phase consists of a requirements analysis to gather the requirements of the logistics network and to clarify the initial applicability of the technology. In this phase, a structured and transparent evaluation of the applicability of BCT is carried out based on organizational and technological criteria. These include, among others, the requirements regarding traceability and trust, and the role of intermediaries in the network. But also, the number of participants as well as issues of transaction performance, verification, data security and interface requirements play an important role. In addition, the foundation is provided for a mindful adoption of BCT. Therefore, in phase two of the management model the mindful adoption model for BCT containing five mindful adoption principles (*engagement with technology, technological novelty seeking, awareness of local context, cognizance of alternative technologies* as well as *anticipation of technology alteration*) is applied for this purpose. Following phase one, which can be defined as descriptive and phase two, which can be defined as explanatory, phase three introduces another explanatory element to the management model. Before starting phase three an assessment based on the previous results is done whether BCT can be mindfully adopted regarding the requirements and prerequisites of the logistics network. In the event that this assessment is negative, the BCT implementation should be discarded and alternatives for the implementation should be sought. In the event of a positive assessment, the process will proceed to phase three. This third phase then includes an analysis of all stakeholders regarding expected changes in sustainable parameters due to the implementation of BCT. Those results are based on the previously developed sustainability impact model. Among the considered stakeholders are suppliers, manufacturers, customers, logistics service providers as well as government and society. To enhance sustainability, outstanding use cases focus on increasing sustainability from raw material suppliers to end customers, and therefore enable end-to-end transparency throughout the entire network, while taking data privacy and data security into account. While the sustainability impact per stakeholder can be mapped in different dimensions, the main aspect is on the distinction between direct and indirect impact on sustainability. In this context, BCT especially contribute

to the measurement and reporting of sustainable parameters by increasing transparency and by leveraging the enhanced transparency factor for the benefit of all network participants, thus verifying social and environmental aspects of the network. Following phase three, another assessment is conducted to detect whether the sustainability goals be achieved by applying BCT. In the event that this assessment is negative, the BCT implementation should be discarded and alternatives for the implementation should be sought. In the event of a positive assessment, the process will proceed to phase four. The fourth phase represents the core of the management model and contains the implementation approach for the development of BCT systems in which design recommendations are made to the logistics management on the basis of five management areas. In addition, area-specific success factors and relevant management instruments and tools are identified. The management areas developed for the implementation in phase four are *strategy and goals*, *internal organization*, *external collaboration*, *technology* and *implementation*. The first management area covers the definition of *strategies and goals* and the associated use case refinement, the definition of measurable parameters for evaluating the success of the BCT project, and the preparation for the expected decentralization. Subsequently, preparations for both, the *internal organization* as well as the *external collaboration*, can be made. The internal aspects focus on embedding the project in the organization. The company furthermore has to be prepared for the transformation by means of change management and the needed competencies and skills have to be trained or hired. Externally, a decentralized governance structure needs to establish and, in an iterative reference to phase three of the management model, the expected impact on sustainability parameters for all involved stakeholders needs to be re-evaluated. Additionally, both internally and externally, knowledge management structures need to be established to ensure a successful implementation. Then, before starting with the system implementation, technology aspects have to be considered by the consortium. Among others, it is important to select the *technology* as well as design the system by including the mindful adoption principles and ensuring interoperability with legacy systems and other possible BCT systems. Ultimately, the final *implementation* management area proposes a procedure based on an agile implementation and the development of prototypes while the entire process is continuously monitored and documented. This management area results in the final BCT system achieving the envisaged outcomes regarding social and environmental sustainability within the international logistics network.

IV. *How do BCT integrate into the vision of future logistics networks?*

To conclude the discussions on BCT in international logistics networks within this thesis, a future vision of decentralized logistics and the role of BCT in it was outlined on the basis of three levels. The first observational level showed that distributed ledgers can act as a decentralized database in logistics networks and thus enable better networking of all network participants at the data level. Expected changes in communication were evaluated using four criteria: *visibility*, *intermediation*, *documents*, and *connectivity*. Regarding *visibility*, BCT enable end-to-end visibility through more transparency and traceability of logistics decisions. Furthermore, due to the decentralized nature of BCT, a more efficient and effective communication is enabled by peer-to-peer connections between all users, eliminating inefficient *intermediation*. As the third criteria to be evaluated with regard to communication, *documents*, being an essential part of communication in logistics, can be digitized in a decentralized manner through BCT. This will lead to more efficient and transparent processes during handling. Ultimately, BCT enable the utmost openness while preserving data control and privacy through *connectivity* by the integration of data stored across different storages and the assurance of data integrity. On the next level, this results in structural changes. On the *strategic level*, a paradigm shift can be observed, which is primarily characterized by decentralized governance and network structures as well as a higher degree of standardization, data security and sustainability without the need for trust between the partners. Changes on a *tactical level*, on the other hand, are characterized by a change in logistics costs, the possibility of decentralized peer-to-peer platforms, and a higher degree of transparency, which in turn enables more efficient collaboration in the context of supplier management or capacity planning. *Operationally*, logistics costs are also changing. In addition, automation, access management and data-driven services become possible across company boundaries. Finally, the interaction of BCT with other technologies of the future was considered. Thus, potentials do not only result from BCT alone, but especially in combination with IoT sensor technology, artificial intelligence or digital twins by generating synergies and mutually bridging technology inherent weak spots.

6.2 Scientific contribution

The scientific contribution of this thesis consists of four pillars, which are described in more detail below. First, BCT are considered in the context of logistics and a definitional framework regarding the functionalities is set in order to develop a framework for BCT application areas in logistics, which shows the entirety of the possible applications of BCT in logistics networks. This framework contains five application areas (*tracking and tracing*, *financial operation*,

verification and certification, planning and network, automation and IoT). It thus covers the spectrum of possibilities and provides a basis for further application-specific research. The evaluations in terms of implementation status, BCT applicability, maturity and complexity serve as an initial indication of the viability of pursuing individual application areas. Furthermore, besides possible applications, technological and organizational limits of the technology are discussed. Moreover, the importance of a mindful technology adoption was stressed. Therefore, the task-technology fit is of great importance for the success of the adoption of BCT in logistics as the full potential of these technologies can only be materialized if they are applied to suitable problems appropriately leveraging the inherent features of the technology.

The thesis furthermore proposes a sustainability impact model for BCT, which describes possible impacts on environmental and social sustainability through BCT in international logistics networks. The model is a holistic, systematic breakdown of environmental and social implications at stakeholder level that arise in logistics through the use of technologies for *manufacturers, suppliers, customers, logistics service providers* as well as *governments and society*. The model illustrates the positive impact that can be achieved using BCT in terms of sustainable parameters. Especially increased transparency as well as traceability and trust in existing data enable an improvement of measurement and reporting of sustainable criteria in international logistics networks, which indirectly create incentives for extrinsically and intrinsically sustainable networks.

The third result is an implementation approach to support and guide the development of BCT systems in logistics networks. Together with previous results, the implementation approach is summarized in the management model for social and environmental impact in logistics through BCT. The model contains four phases (*requirements analysis, mindful adoption model, sustainability impact model, and implementation*) and five management areas (*strategy and goals, internal organization, external collaboration, technology, and implementation*). For researchers, the model provides a holistic approach to plan and develop BCT systems in international logistics networks with the overarching goal to improve social or environmental sustainability, which can be the foundation for further research.

The final scientific contribution of this thesis is an outlook on the future design of international logistics networks and the possible role of BCT in it. It is outlined to what extent distributed data structures using BCT can change the principles of communication between companies. The resulting structural changes are discussed on a strategic, tactical and operational level. In addition, the interaction with other future technologies is examined in more detail. For researchers, this study on the future developments logistics networks are facing with the advancement of BCT gives a conceptual basis for continuative research.

6.3 Managerial contribution

Managers and decision makers in the field of logistics can benefit from the results of this thesis in numerous ways. On the one hand, the thesis provides a practice-oriented explanation of the basic functionalities and architectures of BCT. This establishes an awareness of BCT for interested managers and thus prepares them for more in-depth topics. Following this, the developed framework of possible application areas of BCT logistics gives an exhaustive overview of associated potential use cases. The evaluation of specific application areas and potentials conducted as part of this thesis can support managers in assessing their own company and offers them the opportunity to reflect on their own initiatives and to prioritize them accordingly. Likewise, the mindful adoption model for BCT can be applied to avoid the adoption of unsuitable use cases, which are often implemented due to uncertainties regarding technical functionalities and organizational requirements. A focus on mindfulness and the associated task-technology fit, on the other hand, ensures a promising implementation of suitable use cases by leveraging unique technology properties for specific problems in logistics networks. The discussed technological and organizational limitations of BCT support managers in positioning their problems in the solution spectrum of these technologies and in the subsequent evaluation of the technology's suitability for the specific application.

In addition, an analysis of the expected impact on sustainable parameters of all stakeholders involved is made possible. Moreover, the potential of environmental and social changes by means of BCT is illustrated by means of tangible case studies. Managers thus have the opportunity to draw conclusions for their own companies regarding the sustainable potential of BCT. The sustainability impact model thereby serves as a basis for decision-making for or against the implementation of distributed data structures using BCT with the goal of enhancing sustainability within the logistics network.

On this basis, the further results and the implementation approach in phase four of the management model aim to provide managers with targeted support for the development and implementation. The five management areas developed enable a purposeful and mindful adoption of BCT. Specific design recommendations for logistics management are given and supporting success factors as well as management tools and instruments are identified to support the managers. The management model is thus a precise guideline that leads managers through the process, starting with the definition and analysis of requirements, through the mindful selection of the use case and the evaluation of its sustainability impact potential, up to the implementation of the solution itself.

Ultimately, the research regarding the vision of future logistics and the role of BCT give managers the opportunity to take insights into future design opportunities. Based on those

findings, managers can anticipate changes early, make informed technology adoption decisions, and prepare organizations for a paradigm shift.

BCT promise to make logistics networks more transparent and efficient. However, it is not the solution to all problems and a deep understanding of technology is important to use the technology in the right application areas. This thesis highlights opportunities to promote social and environmental sustainability in logistics networks, while respecting the existing limitations of applicability as discussed. BCT create transparency across stakeholders, if desired, and thus contribute to sustainable logistics networks. While networks with deep supplier structures and previously untraceable problems of a social and environmental nature are suitable for the use of BCT, operational scenarios in an internal context argue against the adoption of the technology. But even in networks, instead of decentralized technology, a central actor can often be found to take on the trust and transparency role to avoid the complex implementation of BCT. In addition, scenarios in logistics that require a very high transaction speed are dependent on further technological development (e.g. DAG).

6.4 Limitations of the thesis and future research

In the following, the inherent limitations of this scientific study in terms of methodology and data basis are discussed, which occur despite the scientific and managerial contributions elaborated above. In addition, further possible aspects of future research are proposed and discussed.

The systematic literature review conducted and the associated framework for application areas of BCT in logistics is limited by the selection of the database (Business Source Complete via EBSCO) and the language included (English). Thus, despite the fact that all types of publications were included, application areas might not have been covered, which could, however, be relevant for the application of BCT in logistics. The evaluation of application areas is based on the opinion of 20 managers. This is a relatively small number and further quantitative testing of those propositions could be beneficial.

The workshops conducted as part of this thesis took place with different panels and a balanced ratio between manufacturers, suppliers and service providers. Nevertheless, the validation of the management model is based on one expert and the exemplary application to case study B and the results should therefore also be tested in other environments. The results of the workshops with regard to challenges of BCT implementations in the first workshop and the social and environmental impact through BCT on international logistics networks in phase three of the management model in the second workshop can be interpreted as cross-industry due to the variety of participants. To further enhance the results, industry-specific empirical

research would be necessary. The results for the implementation approach in phase four of the management model are based on three case studies. The representative selection of these case studies was explained in this thesis. Nevertheless, the results could be further differentiated by examining additional case studies and, under certain circumstances, a differentiation by industry could be elaborated in this context as well. It should also be noted that the case studies refer to the application areas tracking and tracing, verification and certification as well as planning and network, and the validity of the management model is therefore limited to these application areas from a methodological point of view. Further research is necessary to explain a universal valid model.

On the technology side, the focus was on BCT and other architectures in superordinate technology group DLT were considered only peripherally. In view of further developments, e.g. in the context of DAG, a separate consideration may be necessary and thus a differentiation between the design of BCT and DAG systems may be suggested.

This thesis focused on the social and environmental dimensions of sustainability, which is why economic aspects are only considered marginally, for example in the context of measuring the success of the project or the project resources. A more detailed investigation of the cost structure for the development of BCT systems in logistics as well as the proportion of possible transaction costs may be relevant in the future.

Ultimately, the thesis provides a foundation for application-oriented research on BCT in the context of international logistics networks. It can be understood as a call for further qualitative and quantitative research on the effects of decentral technologies on sustainability. While some results need further testing as elaborated above, the thesis provides managers with insightful frameworks on the effects of BCT on sustainability in international logistics networks. The results can serve as a management model to guide those who seek to advance the implementation of these technologies in their networks with the vision to enhance sustainability.

Appendix

Section	Questions
Introduction	<ul style="list-style-type: none"> • What is your industry focus, number of employees, position, years of experience with BCT, years of experience with logistics?
Logistics network	<ul style="list-style-type: none"> • What is the use case description you're implementing with BCT? • Which goals do you pursue by implementing BCT that cannot be solved without this technology? • What is the network structure and what are involved stakeholders? • How are sustainability parameters of the individual stakeholders affected?
Strategy level	<ul style="list-style-type: none"> • How do you identify and evaluate use cases? • How do you measure the success of a BCT project?
Internal level	<ul style="list-style-type: none"> • How do you create acceptance within the companies involved? • How do you develop employee know how? • How do you embed the project company-intern?
Network level	<ul style="list-style-type: none"> • How do you identify and differentiate project partners? • How do you organize collaboration in the network?
Technology level	<ul style="list-style-type: none"> • How do you select the specific technology applied? • How do you manage standardization / interoperability and integration in existing IT system? • How do you ensure the quality of data input (oracle problem)?
Outlook	<ul style="list-style-type: none"> • How will BCT shape/transform future logistics networks? • What will be its role?

Table 44: Questions for case study expert interviews²⁶³

²⁶³ Own representation

References

- Aachener Stiftung Kathy Beys (2015a): Global Reporting Initiative, retrieved from https://www.nachhaltigkeit.info/artikel/gri_global_reporting_initiative_960.htm, accessed September 7, 2020
- Aachener Stiftung Kathy Beys (2015b): OECD Leitsätze für multinationale Unternehmen, retrieved from https://www.nachhaltigkeit.info/artikel/oecd_leitsaetze_fuer_multinationale_unternehmen_1017.htm, accessed September 7, 2020
- Aachener Stiftung Kathy Beys (2015c): Sozialstandards: SA 8000, retrieved from https://www.nachhaltigkeit.info/artikel/sozialstandards_sa_8000_1564.htm, accessed September 7, 2020
- Anderberg, A. / Andonova, E. / Bellia, M. / Calès, L. / Inamorato dos Santos, A. / Kounelis, I. / Nai Fovino, I. / Petracco Giudici, M. / Papanagiotou, E. / Sobolewski, M. / Rossetti, F. / Spirito, L. (2019): Blockchain now and tomorrow. Assessing multidimensional impacts of distributed ledger technologies, EUR, vol. 29813, Luxembourg: Publications Office of the European Union
- Angeles, R. (2018): Blockchain-Based Healthcare: Three Successful Proof-of-Concept Pilots Worth Considering, in: *Journal of International Technology and Information Management*, 2018, pp. 47–83
- Badev, A. / Chen, M. (2014): Bitcoin: Technical Background and Data Analysis, in: *SSRN Electronic Journal*, 27, p. 2014
- Baumgarten, H. (2004): Trends in der Logistik, in: Baumgarten, H. / Darkow, I.-L. / Zadek, H. (Hrsg.): *Supply Chain Steuerung und Services*, Berlin, Heidelberg: Springer Berlin Heidelberg, pp. 1–11
- Beck, K. / Beedle, M. / van Bennekum, A. / Cockburn, A. / Cunningham, W. / Fowler, M. / Grenning, J. / Highsmith, J. / Hunt, A. / Jeffries, R. / Kern, J. / Marick, B. / Martin, R. / Mellor, S. / Schwaber, K. / Sutherland, J. / Thomas, D. (2001): *Manifesto for Agile Software Development*, retrieved from <https://agilemanifesto.org/>, accessed February 9, 2021
- Beck, R. / Avital, M. / Rossi, M. / Thatcher, J. (2017): Blockchain Technology in Business and Information Systems Research, in: *Business & Information Systems Engineering*, 59/6, pp. 381–384

-
- Benz, C. (2008): Qualitätsplanung. Operative Umsetzung strategischer Ziele, München: Hanser Verlag, retrieved from <http://www.hanser-elibrary.com/action/showBook?doi=10.3139/9783446419216>
- Beske-Janssen, P. / Johnson, M. / Schaltegger, S. (2015): 20 years of performance measurement in sustainable supply chain management – what has been achieved?, in: Supply Chain Management: An International Journal, 20/6, pp. 664–680
- Bitcoin.org (2019): Blockchain Guide, retrieved from <https://bitcoin.org/en/blockchain-guide#introduction>, accessed February 7, 2020
- Blossey, G. / Eisenhardt, J. / Hahn, G. (2019): Blockchain Technology in Supply Chain Management: An Application Perspective, in: Bui, T. (Hrsg.): Proceedings of the 52nd Hawaii International Conference on System Sciences, Hawaii International Conference on System Sciences, pp. 6885–6893
- Budde, R. / Kautz, K. / Kuhlenkamp, K. / Züllighoven, H. (1990): What is prototyping?, in: Information Technology & People, 6/2/3, pp. 89–95
- Bumblauskas, D. / Mann, A. / Dugan, B. / Rittmer, J. (2020): A blockchain use case in food distribution: Do you know where your food has been?, in: International Journal of Information Management, 52, p. 102008
- Bundesministerium für wirtschaftliche Zusammenarbeit und Entwicklung (2017): Der Zukunftsvertrag für die Welt, Die Agenda 2030 für nachhaltige Entwicklung, retrieved from https://www.bmz.de/de/mediathek/publikationen/reihen/infobroschueren_flyer/infobroschueren/Materiale270_zukunftsvertrag.pdf, accessed January 6, 2021
- Bundesministerium für wirtschaftliche Zusammenarbeit und Entwicklung (2020): Die Rio-Konferenz 1992, retrieved from https://www.bmz.de/de/themen/2030_agenda/historie/rio_plus20/umweltgipfel/index.html, accessed June 17, 2020
- Bürer, M. / Lapparent, M. de / Pallotta, V. / Capezzali, M. / Carpita, M. (2019): Use cases for Blockchain in the Energy Industry Opportunities of emerging business models and related risks, in: Computers & Industrial Engineering, 137, p. 106002
- Carter, C. / Rogers, D. (2008): A framework of sustainable supply chain management: moving toward new theory, in: International Journal of Physical Distribution & Logistics Management, 38/5, pp. 360–387
- Chanson, M. / Bogner, A. / Bilgeri, D. / Fleisch, E. / Wortmann, F. (2019): Blockchain for the IoT: Privacy-Preserving Protection of Sensor Data, in: Journal of the Association for Information Systems, pp. 1–75

- Chaudhary, R. / Jindal, A. / Aujla, G. / Aggarwal, S. / Kumar, N. / Choo, K.-K. (2019): BEST: Blockchain-based secure energy trading in SDN-enabled intelligent transportation system, in: *Computers & Security*, 85, pp. 288–299
- Ciliberti, F. / Pontrandolfo, P. / Scozzi, B. (2008): Logistics social responsibility: Standard adoption and practices in Italian companies, in: *International Journal of Production Economics*, 113/1, pp. 88–106
- Coase, R. (1937): The Nature of the Firm, in: *Economica*, 4/16, pp. 386–405
- Coglianesi, C. / Nash, J. (2001): *Regulating from the Inside: Can Environmental Management Systems Achieve Policy Goals?*, Washinton, DC: Resources for the Future
- Cole, R. / Stevenson, M. / Aitken, J. (2019): Blockchain technology: implications for operations and supply chain management, in: *Supply Chain Management: An International Journal*, 24/4, pp. 469–483
- Corea, F. (2019): *Applied Artificial Intelligence: Where AI Can Be Used In Business, Understanding Complex Systems*, Cham: Springer International Publishing; Imprint Springer
- Cullinane, S. / Edwards, J. (2011): Assessing the environmental impacts of freight transport, in: McKinnon, A. (Hrsg.): *Green logistics. Improving the environmental sustainability of logistics*, London: Kogan Page, pp. 31–48
- Delbecq, A. / van de Ven, A. (1971): A Group Process Model for Problem Identification and Program Planning, in: *The Journal of Applied Behavioral Science*, 7/4, pp. 466–492
- Delfmann, W. / Kersten, W. / Stölzle, W. / Hompel, M. ten / Schmidt, T. (2017): *Logistik als Wissenschaft - zentrale Forschungsfragen in Zeiten der vierten industriellen Revolution. Positionspapier des Wissenschaftlichen Beirats der Bundesvereinigung Logistik (BVL)*, Bremen: Bundesvereinigung Logistik (BVL) e. V.
- Delmas, M. / Montiel, I. (2009): Greening the Supply Chain: When Is Customer Pressure Effective?, in: *Journal of Economics & Management Strategy*, 18/1, pp. 171–201
- Deloitte (2020): *Blockchain – was heißt das für die Abschlussprüfung?*, retrieved from <https://www2.deloitte.com/de/de/pages/audit/articles/blockchain-abschlusspruefung.html>, accessed August 31, 2020
- Di Vaio, A. / Varriale, L. (2020): Blockchain technology in supply chain management for sustainable performance: Evidence from the airport industry, in: *International Journal of Information Management*, 52, pp. 1–16

-
- DIN (2013): DIN EN 16258. Methode zur Berechnung und Deklaration des Energieverbrauchs und der Treibhausgasemissionen bei Transportdienstleistungen (Güter- und Personenverkehr). Deutsche Fassung EN 16258:2012, Berlin: Beuth Verlag GmbH
- DIN (2017): DIN SPEC 91224. Unternehmensübergreifende Bilanzierung transportbedingter Emissionen – Erfassung und Übermittlung relevanter Daten, Berlin: Beuth Verlag GmbH
- DIN (2019): DIN EN ISO 14067. Treibhausgase - Carbon Footprint von Produkten - Anforderungen an und Leitlinien für Quantifizierung (ISO 14067:2018); Deutsche und Englische Fassung EN ISO 14067:2018, Berlin
- Dinh, T. / Thai, M. (2018): AI and Blockchain: A Disruptive Integration, in: *Computer*, 51/9, pp. 32–37
- Dorri, A. / Steger, M. / Kanhere, S. / Jurdak, R. (2017): BlockChain: A Distributed Solution to Automotive Security and Privacy, in: *IEEE Communications Magazine*, 55/12, pp. 119–125
- DSLV Deutscher Speditions- und Logistikverband e. V. (2013): Berechnung von Treibhausgasemissionen in Spedition und Logistik gemäß DIN EN 16258. Begriffe, Methoden, Beispiele, 2nd ed., Berlin
- Durach, C. (2016): A theoretical and practical contribution to supply chain robustness, Dissertation, Schriftenreihe Logistik der Technischen Universität Berlin, 33, Technische Universität Berlin, Berlin
- Durach, C. / Wieland, A. / Machuca, J. (2015): Antecedents and dimensions of supply chain robustness: a systematic literature review, in: *International Journal of Physical Distribution & Logistics Management*, 45/1/2, pp. 118–137
- Ehm, H. / Lachner, F. (2019): Realisierung von Flexibilität in komplexen Versorgungsnetzwerken am Beispiel der Infineon Technologies AG, in: Göpfert, I. (Hrsg.): *Logistik der Zukunft - Logistics for the Future*, Wiesbaden: Springer Fachmedien Wiesbaden, pp. 397–414
- Elbert, R. / Borkowski, S. (2010): Treiber und Anspruchsgruppen in der Logistik, in: Straube, F. / Nagel, A. (Hrsg.): *Global Logistics - Umweltschutz und Ressourceneffizienz*, Hamburg: DVV Media Group Dt. Verkehrs-Verl., pp. 32–58
- Elkington, J. (1999): *Cannibals with forks. The triple bottom line of 21st century business*, A Capstone paperback, Oxford: Capstone
- Fan, Z.-P. / Wu, X.-Y. / Cao, B.-B. (2020): Considering the traceability awareness of consumers: should the supply chain adopt the blockchain technology?, in: *Annals of Operations Research*

- Fayezi, S. / O'Loughlin, A. / Zutshi, A. (2012): Agency theory and supply chain management: a structured literature review, in: *Supply Chain Management: An International Journal*, 17/5, pp. 556–570
- Fontius, J. (2013): *Megatrends und ihre Implikationen für die Logistik. Ableitung von Wirkungszusammenhängen*, Dissertation, Schriftenreihe Logistik der Technischen Universität Berlin, 25, Technische Universität Berlin, Berlin
- Fosso Wamba, S. / Kala Kamdjoug, J. / Epie Bawack, R. / Keogh, J. (2020): Bitcoin, Blockchain and Fintech: a systematic review and case studies in the supply chain, in: *Production Planning & Control*, 31/2-3, pp. 115–142
- Francisco, K. / Swanson, D. (2018): The Supply Chain Has No Clothes: Technology Adoption of Blockchain for Supply Chain Transparency, in: *Logistics*, 2/1, pp. 1–13
- Franco, P. (2015a): *Understanding Bitcoin. Cryptography, engineering and economics*, Wiley finance series, Chichester, West Sussex, United Kingdom: Wiley, retrieved from <https://onlinelibrary.wiley.com/doi/book/10.1002/9781119019138>
- Franco, P. (2015b): *Understanding Bitcoin. Cryptography, Engineering and Economics*, Chichester, West Sussex: Wiley, retrieved from <https://onlinelibrary.wiley.com/doi/book/10.1002/9781119019138>
- George, R. / Harsh, H. / Ray, P. / Babu, A. (2019): Food quality traceability prototype for restaurants using blockchain and food quality data index, in: *Journal of Cleaner Production*, 240, p. 118021
- Glaister, K. / Falshaw, J. (1999): Strategic Planning: Still Going Strong?, in: *Long Range Planning*, 32/1, pp. 107–116
- Goodhue, D. / Thompson, R. (1995): Task-Technology Fit and Individual Performance, in: *MIS Quarterly*, 19/2, p. 213
- Göpfert, I. (2019): *Die Anwendung der Zukunftsforschung für die Logistik*, in: Göpfert, I. (Hrsg.): *Logistik der Zukunft - Logistics for the Future*, Wiesbaden: Springer Fachmedien Wiesbaden, pp. 39–99
- Göpfert, I. / Seeßle, P. (2019): Innovative Startups in der Logistikbranche – Eine Betrachtung der neuen Marktteilnehmer und empirische Erkenntnisse einer Fragebogenstudie, in: Göpfert, I. (Hrsg.): *Logistik der Zukunft - Logistics for the Future*, Wiesbaden: Springer Fachmedien Wiesbaden, pp. 253–280

-
- Göpfert, I. / Wellbrock, W. (2019): Ein Leitfaden für die Entwicklung innovativer Supply-Chain-Management-Konzepte, in: Göpfert, I. (Hrsg.): Logistik der Zukunft - Logistics for the Future, Wiesbaden: Springer Fachmedien Wiesbaden, pp. 473–516
- Greenhouse Gas Protocol (2020): A Corporate Accounting and Reporting Standard, retrieved from <https://ghgprotocol.org/sites/default/files/standards/ghg-protocol-revised.pdf>, accessed September 7, 2020
- GRI Standards (2020): CONSOLIDATED SET OF GRI SUSTAINABILITY REPORTING STANDARDS 2020, Amsterdam: GRI
- Grober, U. (2013): Die Entdeckung der Nachhaltigkeit. Kulturgeschichte eines Begriffs, München: Kunstmann
- Gurtu, A. / Johny, J. (2019): Potential of blockchain technology in supply chain management: a literature review, in: International Journal of Physical Distribution & Logistics Management, 49/9, pp. 881–900
- Halldorsson, A. / Kotzab, H. / Mikkola, J. / Skjøtt-Larsen, T. (2007): Complementary theories to supply chain management, in: Supply Chain Management: An International Journal, 12/4, pp. 284–296
- Hasan, H. / AlHadhrami, E. / AlDhaheeri, A. / Salah, K. / Jayaraman, R. (2019): Smart contract-based approach for efficient shipment management, in: Computers & Industrial Engineering, 136, pp. 149–159
- Hauff, V. (1987): Unsere gemeinsame Zukunft, Greven [Federal Republic of Germany]: Eggenkamp Verlag
- Heistermann, F. / Mallée, T. / Hompel, M. ten (2017): Digitisation in Logistics. Answers to questions that concern companies, Bremen: Bundesvereinigung Logistik (BVL) e.V.
- Helo, P. / Hao, Y. (2019): Blockchains in operations and supply chains: A model and reference implementation, in: Computers & Industrial Engineering, 136, pp. 242–251
- Huang, S. / Wang, G. / Yan, Y. / Fang, X. (2020): Blockchain-based data management for digital twin of product, in: Journal of Manufacturing Systems, 54, pp. 361–371
- Iredale, G. (2020): Top Disadvantages Of Blockchain Technology, retrieved from <https://101blockchains.com/disadvantages-of-blockchain/>, accessed August 2, 2021
- ISO (2018): Discovering ISO 26000, Geneva: International Organization for Standardization
- ISO (2019): Climate change mitigation, Geneva: International Organization for Standardization

Junge, A. / Verhoeven, P. / Reipert, J. / Mansfeld, M. (2019): Trends and Strategies in Logistics. Pathway of Digital Transformation in Logistics Best Practice Concepts and Future Developments, in: Straube, F. (Hrsg.): Schriftenreihe Logistik der Technischen Universität Berlin. Sonderband, Berlin: Universitätsverlag der TU Berlin

Kaplan, R. / Norton, David, P. (2005): The Balanced Scorecard. Measures That Drive Performance, in: Harvard Business review, Reprint R0507Q, retrieved from https://www.orion2020.org/archivo/articulos/bsc_articulo.pdf, accessed February 4, 2021

Kayikci, Y. (2018): Sustainability impact of digitization in logistics, in: Procedia Manufacturing, 21, pp. 782–789

Kersten, W. / Seiter, M. / See, B. von / Hackius, N. / Maurer, T. (2017): Trends and Strategies in Logistics and Supply Chain Management – Digital Transformation Opportunities, Bremen: BVL International

Khanfar, A. / Iranmanesh, M. / Ghobakhloo, M. / Senali, M. / Fathi, M. (2021): Applications of Blockchain Technology in Sustainable Manufacturing and Supply Chain Management: A Systematic Review, in: Sustainability, 13/14, p. 7870

Kiron, D. (2012): Sustainability nears a tipping point, in: Strategic Direction, 28/7, pp. 69–74

Kittel-Wegner, E. / Meyer, J. (2002): Die Fallstudie in der betriebswirtschaftlichen Forschung und Praxis, in: Schriften zu Management und KMU 2002, 2002

Kosow, H. / Gaßner, R. (2008): Methoden der Zukunfts- und Szenarioanalyse. Überblick, Bewertung und Auswahlkriterien, Werkstattbericht / IZT, Institut für Zukunftsstudien und Technologiebewertung, vol. 103, Berlin: IZT, retrieved from https://www.izt.de/fileadmin/downloads/pdf/IZT_WB103.pdf, accessed February 8, 2021

Kotter, J. (1995): Leading Change: Why Transformation Efforts Fail, 2, Reprint 95204, pp. 59–67

Kshetri, N. (2021): Blockchain and sustainable supply chain management in developing countries, in: International Journal of Information Management, 60, p. 102376

Lao, L. / Li, Z. / Hou, S. / Xiao, B. / Guo, S. / Yang, Y. (2020): A Survey of IoT Applications in Blockchain Systems, in: ACM Computing Surveys, 53/1, pp. 1–32

Lee, S. (2018): Explaining Directed Acyclic Graph (DAG), The Real Blockchain 3.0, retrieved from <https://www.forbes.com/sites/shermanlee/2018/01/22/explaining-directed-acyclic-graph-dag-the-real-blockchain-3-0/?sh=3072c6ee180b>, accessed January 21, 2021

-
- Lehmacher, W. (2015): *Wirtschaft, Gesellschaft und Logistik 2050*, in: Voß, P. (Hrsg.): *Logistik – eine Industrie, die (sich) bewegt*, Wiesbaden: Springer Fachmedien Wiesbaden, pp. 1–17
- Ludwig, A. / Stróżyna, M. (2020): Interview with Martin Gnass and Martin Kolbe on “Challenges and Hot Topics in the Intermodal Logistics Industry”, in: *Business & Information Systems Engineering*, 62/5, pp. 451–453
- Mahamuni, A. (2019): How to Unleash Blockchain into Your SUPPLY CHAIN: Blockchain-based applications provide transparency and visibility throughout the entire supply chain, in: *MATERIAL HANDLING & LOGISTICS*, 2019, pp. 21–24
- Malik, A. / Gautam, S. / Abidin, S. / Bhushan, B. (2019): Blockchain Technology-Future Of IoT: Including Structure, Limitations And Various Possible Attacks, in: : 2019 2nd International Conference on Intelligent Computing, Instrumentation and Control Technologies (ICICICT), IEEE, pp. 1100–1104
- Mandolla, C. / Petruzzelli, A. / Percoco, G. / Urbinati, A. (2019): Building a digital twin for additive manufacturing through the exploitation of blockchain: A case analysis of the aircraft industry, in: *Computers in Industry*, 109, pp. 134–152
- Mazzei, D. / Baldi, G. / Fantoni, G. / Montelisciani, G. / Pitasi, A. / Ricci, L. / Rizzello, L. (2020): A Blockchain Tokenizer for Industrial IOT trustless applications, in: *Future Generation Computer Systems*, 105, pp. 432–445
- Meinel, C. / Gayvoronskaya, T. / Schnjakin, M. (2018): Blockchain. Hype oder Innovation, *Technische Berichte des Hasso-Plattner-Instituts für Softwaresystemtechnik an der Universität Potsdam*, vol. 113, Potsdam: Universitätsverlag Potsdam, retrieved from <http://nbn-resolving.de/urn:nbn:de:kobv:517-opus4-103141>, accessed January 21, 2021
- Meiriño, M. / Méxas, M. / Faria, A. / Méxas, R. / Meirelles, G. (2019): Blockchain technology applications: a literature review, in: *Brazilian Journal of Operations & Production Management*, 16/4, pp. 672–684
- Min, H. (2019): Blockchain technology for enhancing supply chain resilience, in: *Business Horizons*, 62/1, pp. 35–45
- Moin, S. / Karim, A. / Safdar, Z. / Safdar, K. / Ahmed, E. / Imran, M. (2019): Securing IoTs in distributed blockchain: Analysis, requirements and open issues, in: *Future Generation Computer Systems*, 100, pp. 325–343
- Moosavi, J. / Naeni, L. / Fathollahi-Fard, A. / Fiore, U. (2021): Blockchain in supply chain management: a review, bibliometric, and network analysis, in: *Environmental science and pollution research international*

- Nakamoto, S. (2008): Bitcoin: A Peer-to-Peer Electronic Cash System, retrieved from <https://bitcoin.org/bitcoin.pdf>, accessed January 20, 2021
- Onkila, T. (2010): Multiple forms of stakeholder interaction in environmental management: business arguments regarding differences in stakeholder relationships, in: *Business Strategy and the Environment*, 16/4
- Paar, C. / Pelzl, J. (2010): *Understanding Cryptography*, Berlin, Heidelberg: Springer Berlin Heidelberg
- Panagiotou, G. (2003): Bringing SWOT into Focus, in: *Business Strategy Review*, 14/2, pp. 8–10
- Panetta, K. (2018): 5 Trends Emerge in the Gartner Hype Cycle for Emerging Technologies, 2018, retrieved from <https://www.gartner.com/smarterwithgartner/5-trends-emerge-in-gartner-hype-cycle-for-emerging-technologies-2018/>, accessed February 4, 2020
- Park, A. / Li, H. (2021): The Effect of Blockchain Technology on Supply Chain Sustainability Performances, in: *Sustainability*, 13/4, p. 1726
- Pervez, H. / Muneeb, M. / Irfan, M. / Haq, I. (2018): A Comparative Analysis of DAG-Based Blockchain Architectures, in: : 2018 12th International Conference on Open Source Systems and Technologies (ICOSST), pp. 27–34
- Pettey, C. (2019): Gartner Top 8 Supply Chain Technology Trends for 2019, retrieved from <https://www.gartner.com/smarterwithgartner/gartner-top-8-supply-chain-technology-trends-for-2019/>, accessed January 31, 2020
- Pfeiffer, W. / Dögl, R. (1990): Das Technologie-Portfolio-Konzept zur Beherrschung der Schnittstelle Technik und Unternehmensstrategie, in: Hahn, D. (Hrsg.): *Strategische Unternehmensplanung - strategische Unternehmensführung. Stand und Entwicklungstendenzen*, 5th ed., Heidelberg: Physica-Verl., pp. 254–282
- Pufé, I. (2014): *Nachhaltigkeit*, 2nd ed., Stuttgart: UTB GmbH; UVK Lucius, retrieved from <http://www.utb-studi-e-book.de/9783838540542>, accessed September 7, 2020
- Queiroz, M. / Telles, R. / Bonilla, S. (2019): Blockchain and supply chain management integration: a systematic review of the literature, in: *Supply Chain Management: An International Journal*, 25/2, pp. 241–254
- Rejeb, A. / Rejeb, K. / Simske, S. / Treiblmaier, H. (2021): Blockchain Technologies in Logistics and Supply Chain Management: A Bibliometric Review, in: *Logistics*, 5/4, p. 72

-
- Reyna, A. / Martín, C. / Chen, J. / Soler, E. / Díaz, M. (2018): On blockchain and its integration with IoT. Challenges and opportunities, in: *Future Generation Computer Systems*, 88, pp. 173–190
- Rodenhäuser, B. / Rauch, C. (2015): *Supply Chain 2025. Eine Studie des Zukunftsinstituts für den Verband der Wellpappen-Industrie*, retrieved from https://www.wellpappen-industrie.de/data/04_Verband/05_Publikationen/06_zukunftsstudie/VDW_Zukunftsstudie-Supply-Chain-2025.pdf, accessed January 20, 2021
- Rogall, H. (2000): Von der globalen zur betrieblichen Leitidee der Nachhaltigkeit, in: Dybe, G. (Hrsg.): *Die ökonomische Säule der Nachhaltigkeit. Annäherungen aus gesamtwirtschaftlicher, regionaler und betrieblicher Perspektive*, Berlin: Ed. Sigma, pp. 21–43
- Roy, D. (2017): *Industrie 4.0 - Gestaltung cyber-physischer Logistiksysteme zur Unterstützung des Logistikmanagements in der Smart Factory*, Dissertation, Schriftenreihe Logistik der Technischen Universität Berlin, 38, Technische Universität Berlin, Berlin
- Ruile, H. (2019): Vom Internet der Dinge zum Geschäftsmodell, in: Göpfert, I. (Hrsg.): *Logistik der Zukunft - Logistics for the Future*, Wiesbaden: Springer Fachmedien Wiesbaden, pp. 139–155
- Saberi, S. / Kouhizadeh, M. / Sarkis, J. / Shen, L. (2019): Blockchain technology and its relationships to sustainable supply chain management, in: *International Journal of Production Research*, 57/7, pp. 2117–2135
- SAI (2021): SA8000 Standard, retrieved from <https://sa-intl.org/programs/sa8000/>, accessed August 24, 2021
- Saraf, C. / Sabadra, S. (2018): Blockchain platforms: A compendium, in: : 2018 IEEE International Conference on Innovative Research and Development (ICIRD), IEEE, pp. 1–6
- Schlatt, V. / Schweizer, A. / Urbach, N. / Fridgen, G. (2016): *Blockchain: Grundlagen, Anwendungen und Potenziale*, retrieved from <https://www.fim-rc.de/Paperbibliothek/Veroeffentlicht/642/wi-642.pdf>, accessed January 21, 2021
- Seebacher, S. / Schüritz, R. (2017): Blockchain Technology as an Enabler of Service Systems: A Structured Literature Review, in: Za, S. / Drăgoicea, M. / Cavallari, M. (Hrsg.): *Exploring Services Science*, Cham: Springer International Publishing, pp. 12–23
- Seuring, S. / Müller, M. (2008): From a literature review to a conceptual framework for sustainable supply chain management, in: *Journal of Cleaner Production*, 16/15, pp. 1699–1710

Sharma, T. (2018): 5 Critical Components of Blockchain Technology, retrieved from <https://www.blockchain-council.org/blockchain/5-critical-components-of-blockchain-technology/>, accessed January 31, 2020

Shrivastava, P. (1995): The Role of Corporations in Achieving Ecological Sustainability, in: *Academy of Management Review*, 20/4, pp. 936–960

Siegmann, J. / Spiegel, T. / Durach, C. / Elektricki, S. / Ouyeder, O. (2013): Technologie und Innovationen in der Logistik, in: Straube, F. (Hrsg.): *Schriftenreihe Logistik der Technischen Universität Berlin*, Berlin: Universitätsverlag der TU Berlin

Straube, F. (2004): *e-Logistik*, Berlin, Heidelberg: Springer Berlin Heidelberg

Straube, F. / Cetinkaya, B. (2009): Logistische Netzwerkreife im Kontext von Megatrends, in: Wolf-Kluthausen, H. (Hrsg.): *Jahrbuch der Logistik 2009*, Korschbroich: free beratung Gesellschaft für Kommunikation im Marketing mbH, pp. 135–140

Swanson / Ramiller (2004): Innovating Mindfully with Information Technology, in: *MIS Quarterly*, 28/4, p. 553

Székely, F. / Knirsch, M. (2005): Responsible Leadership and Corporate Social Responsibility, in: *European Management Journal*, 23/6, pp. 628–647

Tönnissen, S. / Teuteberg, F. (2020): Analysing the impact of blockchain-technology for operations and supply chain management: An explanatory model drawn from multiple case studies, in: *International Journal of Information Management*, 52, pp. 1–10

Treiblmaier, H. (2018): The impact of the blockchain on the supply chain: a theory-based research framework and a call for action, in: *Supply Chain Management: An International Journal*, 23/6, pp. 545–559

Twenhöven, T. / Petersen, M. (2019): Impact and beneficiaries of blockchain in logistics, 2019, Hamburg International Conference of Logistics (HICL) 2019

Umweltbundesamt (2020): ISO 14001 - Umweltmanagementsystemnorm, retrieved from <https://www.umweltbundesamt.de/themen/wirtschaft-konsum/wirtschaft-umwelt/umwelt-energiemanagement/iso-14001-umweltmanagementsystemnorm#inhalte-der-iso-14001>, accessed August 24, 2021

Underwood, S. (2016): Blockchain beyond bitcoin, in: *Communications of the ACM*, 59/11, pp. 15–17

United Nations (2015): *Transforming our world: the 2030 Agenda for Sustainable Development*, retrieved from https://www.un.org/ga/search/view_doc.asp?symbol=A/RES/70/1&Lang=E, accessed January 6, 2021

-
- Upadhyaya, A. / Mukhuty, S. / Kumar, V. / Kazancoglu, Y. (2021): Blockchain technology and the circular economy: Implications for sustainability and social responsibility, in: *Journal of Cleaner Production*, 293, pp. 1–7
- van Hoek, R. (2019): Exploring blockchain implementation in the supply chain, in: *International Journal of Operations & Production Management*, 39/6/7/8, pp. 829–859
- van Rijmenam, M. (2019): 3 Reasons Why You Should Not Use Blockchain In Your Organization, retrieved from <https://markvanrijmenam.medium.com/3-reasons-why-you-should-not-use-blockchain-in-your-organisation-56a8bbaef61e>, accessed August 2, 2021
- Varvasovszky, Z. / Brugha, R. (2000): A stakeholder analysis, in: *Health policy and planning*, 15/3, pp. 338–345
- Verhoeven, P. / Sinn, F. / Herden, T. (2018): Examples from Blockchain Implementations in Logistics and Supply Chain Management: Exploring the Mindful Use of a New Technology, in: *Logistics*, 2/3, p. 20
- Vieira, E. / Ferreira, J. / Bartolomeu, P. (2020): Blockchain Technologies for IoT Applications: Use-cases and Limitations, in: : 2020 25th IEEE International Conference on Emerging Technologies and Factory Automation (ETFA), IEEE, pp. 1560–1567
- Wagner, S. / Kemmerling, R. (2010): HANDLING NONRESPONSE IN LOGISTICS RESEARCH, in: *Journal of Business Logistics*, 31/2, pp. 357–381
- Wang, S. / Taha, A. / Wang, J. / Kvaternik, K. / Hahn, A. (2019a): Energy Crowdsourcing and Peer-to-Peer Energy Trading in Blockchain-Enabled Smart Grids, in: *IEEE Transactions on Systems, Man, and Cybernetics: Systems*, 49/8, pp. 1–12
- Wang, X. / Zha, X. / Ni, W. / Liu, R. / Guo, Y. / Niu, X. / Zheng, K. (2019b): Survey on blockchain for Internet of Things, in: *Computer Communications*, 136/7, pp. 10–29
- WBCSD / WRI (2004): The greenhouse gas protocol. A corporate accounting and reporting standard, Washington, DC/Conches-Geneva: World Resources Institute; World Business Council for Sustainable Development
- WCED (1987): Report of the World Commission on Environment and Development - Our Common Future, retrieved from <https://sustainabledevelopment.un.org/content/documents/5987our-common-future.pdf>, accessed January 20, 2020
- Witt, A. (2019): 5 Reasons You Should NOT Use Blockchain, retrieved from <https://alexlwitt.medium.com/5-reasons-you-should-not-use-blockchain-e1aab12f7976>, accessed August 2, 2021

Wittenberg, S. (2020): Blockchain für Unternehmen. Anwendungsfälle und Geschäftsmodelle für die Praxis, Stuttgart: Schäffer-Poeschel Verlag

World Economic Forum (2019): Inclusive Deployment of Blockchain for Supply Chains, in: World Economic Forum Whitepaper, pp. 1–26

Wutke, S. (2016): Entwicklung eines Gestaltungsmodells zur Berücksichtigung von Nachhaltigkeit bei der Ausschreibung und Vergabe logistischer Leistungen im Straßengüterverkehr, Dissertation, Schriftenreihe Logistik der Technischen Universität Berlin, 36, Technische Universität Berlin, Berlin

Yang, C.-S. (2019): Maritime shipping digitalization: Blockchain-based technology applications, future improvements, and intention to use, in: Transportation Research Part E: Logistics and Transportation Review, 131, pp. 108–117

Yaqoob, I. / Salah, K. / Uddin, M. / Jayaraman, R. / Omar, M. / Imran, M. (2020): Blockchain for Digital Twins: Recent Advances and Future Research Challenges, in: IEEE Network, 34/5, pp. 290–298

Zeschmar-Lahl, B. (2015): Drei Säulen Modell, retrieved from https://www.nachhaltigkeit.info/artikel/1_3_a_drei_saeulen_modell_1531.htm, accessed November 8, 2019

Zhao, L. / Yu, J. (2019): Evaluating DAG-Based Blockchains for IoT, in: 2019 18th IEEE International Conference On Trust, Security And Privacy In Computing And Communications/13th IEEE International Conference On Big Data Science And Engineering (TrustCom/BigDataSE), IEEE, pp. 507–513

Zohar, A. (2015): Bitcoin, in: Communications of the ACM, 58/9, pp. 104–113

Schriftenreihe Logistik der Technischen Universität Berlin

Hrsg.: Frank Straube, Raimund Klinkner, Helmut Baumgarten

ISSN 1865-3170 (print)

ISSN 2197-0564 (online)

01: Mayer, Axel: Modularisierung der Logistik.

Ein Gestaltungsmodell zum Management von Komplexität in der industriellen Logistik. - 2007. - XVIII, 264 S.

ISBN 978-3-7983-2054-3 vergriffen

02: Thom, Alexander: Entwicklung eines Gestaltungsmodells zum Management von Risiken in Produktionsnetzwerken.

Ein Beitrag zum Risikomanagement in der Logistik. - 2008. - XX, 239 S.

ISBN 978-3-7983-2975-8 EUR 5,00

03: Bogatu, Christian: Smartcontainer als Antwort auf logistische und sicherheitsrelevante Herausforderungen in der Lieferkette.

Auswirkungen und Handlungsempfehlungen für die Wertschöpfungskette der Logistik. - 2008. - XXIV, 286 S.

ISBN 978-3-7983-2074-1 EUR 5,00

04: Beckmann, Thomas: Emerging Market Sourcing.

Eine empirische Untersuchung zu Erfolgsfaktoren in der Beschaffung aus Wachstumsmärkten. - 2008. - XI, 221 S.

ISBN 978-3-7983-2096-3 EUR 5,00

05: Dietman, Nils von: Airport Performance Measurement.

Kennzahlensystem zur Analyse und Bewertung von Flughafenprozessen. - 2008. - XXI, 204 S.

ISBN 978-3-7983-2103-8 EUR 5,00

06: Hildebrand, Wolf-Christian: Management von Transportnetzwerken im containerisierten Seehafeninterlandverkehr.

- 2008. - XVI, 234 S.

ISBN 978-3-7983-2102-1 EUR 5,00

07: Wilmking, Niklas: Logistikmanagement in China.

Eine empirische Untersuchung zur Strategieentwicklung von Logistikdienstleistern. - 2009. - VIII, 247 S.

ISBN 978-3-7983-2130-4 EUR 5,00

08: Vogeler, Stefan: Entwicklung eines Vorgehensmodells zur Implementierung der RFID-Technologie in logistischen Systemen am Beispiel der Bekleidungsirtschaft.

- 2009. - XI, 227 S.

ISBN 978-3-7983-2156-4 EUR 5,00

09: Doch, Stefan Alexander: Logistische Leistungsdifferenzierung im Supply Chain Management.

Theoretische und empirische Entwicklung eines Gestaltungsansatzes für die Differenzierung der logistischen Leistungserstellung produzierender Unternehmen zur Erfüllung individueller Kundenwünsche. - 2009. - X, 271 S.

ISBN 978-3-7983-2157-1 vergriffen

10: Bensel, Philipp: Geschäftsmodelle von Logistikdienstleistern im Umfeld des Ubiquitous Computing.

- 2009. - XIV, 247 S.

ISBN 978-3-7983-2166-3 EUR 5,00

11: Bohn, Michael: Logistik im Kontext des ausländischen Markteintritts.

Entwicklung von Gestaltungsempfehlungen für den ausländischen Markteintritt unter besonderer Berücksichtigung der Erfolgskomponente Logistik. - 2009. - XVIII, 334 S.

ISBN 978-3-7983-2179-3 EUR 5,00

12: Sommer-Dittrich, Thomas: Wandlungsfähige Logistiksysteme in einer nachhaltigen Kreislaufwirtschaft.

- 2010. - 215 S.

ISBN 978-3-7983-2200-4 EUR 5,00

13: Kerner, Jürgen Andreas: Beschaffung im Eigenmarkengeschäft des Bekleidungshandels.

Ein theoretischer und fallstudienbasierter Beitrag zur Lösung ausgewählter Probleme der Prozessplanung. - 2010. - XX, 207 S.

ISBN 978-3-7983-2212-7 EUR 5,00

14: Fürstenberg, Frank: Der Beitrag serviceorientierter IT-Architekturen zu integrierten Kontraktlogistikdienstleistungen.

- 2010. - XVIII, 244 S.

ISBN 978-3-7983-2227-1 EUR 5,00

- 15: Fendt, Thomas: Introducing Electronic Supply Chain Collaboration in China – Evidence from Manufacturing Industries.** - 2010. - XII, 219, 53 S.
ISBN 978-3-7983-2243-1 EUR 5,00
- 16: Franke, Peter D.: Internationalisierung der Kontraktlogistik.** Entwicklung eines Instrumentariums zur Länderselektion. - 2011. - XV, 217 S.
ISBN 978-3-7983-2296-7 EUR 5,00
- 17: Tentrop, Friedrich: Entwicklung eines integrierten Gestaltungsansatzes der Produktionslogistik.** - 2011. - XV, 227 S.
ISBN 978-3-7983-2317-9 EUR 5,00
- 18: Nagel, Arnfried: Logistik im Kontext der Nachhaltigkeit.** Ökologische Nachhaltigkeit als Zielgröße bei der Gestaltung logistischer Netzwerke. - 2011. - XV, 228 S.
ISBN 978-3-7983-2383-4 EUR 5,00
- 19: Grig, Roman: Governance-Strukturen in der maritimen Transportkette.** Agentenbasierte Modellierung des Akteursverhaltens im Extended Gate. - 2012. - XVI, 373 S.
ISBN 978-3-7983-2384-1 EUR 5,00
- 20: Kefler, Martin: Gestaltung von Logistiknetzwerken für die humanitäre Versorgung in Entwicklungsländern Afrikas.** - 2012. - XIV, 355 S.
ISBN 978-3-7983-2426-8 (print) EUR 5,00
ISBN 978-3-7983-2427-5 (online)
- 21: Schwarz, Jennifer Rebecca: Humanitäre Logistik für die Versorgungsproblematik in Subsahara-Afrika.** Aufbau von Logistikkapazität durch Wissenstransfer. - 2012. - XVIII, 336 S.
ISBN 978-3-7983-2444-2 (print) EUR 5,00
ISBN 978-3-7983-2445-9 (online)
- 22: Rief, Daniel: Markteintritt in China.** Flexibilität und Integration als Erfolgsfaktoren in einer dynamischen und komplexen Marktumgebung. - 2013. - XIX, 235 S.
ISBN 978-3-7983-2482-4 (print) EUR 20,90
- 23: Richter, Markus: Nutzenoptimierter RFID-Einsatz in der Logistik.** Eine Handlungsempfehlung zur Lokalisierung und Bewertung der Nutzenpotenziale von RFID-Anwendungen. - 2013. - XIX, 235 S.
ISBN 978-3-7983-2523-4 (print) EUR 21,90
ISBN 978-3-7983-2524-1 (online)
- 24: Huynh, Thu Hang: Beitrag zur Systematisierung von Theorien in der Logistik.** - 2013. - XVII, 429 S.
ISBN 978-3-7983-2610-1 (print) EUR 21,90
ISBN 978-3-7983-2611-8 (online)
- 25: Fontius, Jörn: Megatrends und ihre Implikationen für die Logistik.** Ableitung von Wirkungszusammenhängen. - 2013. - XVII, 217 S.
ISBN 978-3-7983-2634-7 (print) EUR 12,50
ISBN 978-3-7983-2635-4 (online)
- 26: Ouyeder, Ouelid: Strategien für eine nachhaltige Lieferantenentwicklung für die Beschaffung aus Emerging Markets.** - 2013. - X, 279 S.
ISBN 978-3-7983-2658-3 EUR 21,50
- 27: Steffens, Anja: Logistische Wandlungsbefähiger.** Entwicklung eines kontextbasierten Gestaltungsmodells für die industrielle Logistik. - 2014. - XIII, 284 S.
ISBN 978-3-7983-2682-8 EUR 15,50
- 28: Siegmann, Julian B.: Prozessinnovationen bei Logistikdienstleistungsunternehmen.** - 2015. - xxxviii, 245 S.
ISBN 978-3-7983-2737-5 (print) EUR 15,50
ISBN 978-3-7983-2738-2 (online)
- 29: Keitel, Sebastian: Auswirkungen disaggregierter Regulierung auf die Kapazität von Verkehrssektoren.** Eine wettbewerbstheoretische und empirische Untersuchung am Beispiel des Luftverkehrssektors. - 2015. - IX, 252 S.
ISBN 978-3-7983-2749-8 (print) EUR 15,50
ISBN 978-3-7983-2750-4 (online)
- 30: Campos, Juliana Kucht: Integrated Framework for Managing Sustainable Supply Chain Practices.** - 2015. - xii, 121 S.
ISBN 978-3-7983-2783-2 (print) EUR 10,50
ISBN 978-3-7983-2784-9 (online)
- 31: Spiegel, Timo U.: Technologieorientiertes Service Engineering in der Kontraktlogistik.** Konzeption eines Gestaltungsmodells für die systematische Entwicklung technologiebasierter Logistikdienstleistungen. - 2016. - x, 295 S.
ISBN 978-3-7983-2807-5 (print) EUR 15,50
ISBN 978-3-7983-2808-2 (online)

- 32: Figiel, Anna: Transportmanagement in der schnelldrehenden Konsumgüterindustrie.** Entwicklung eines Gestaltungsansatzes zur Integration von Transport und Logistik. - 2016. - XVIII, 227 S.
ISBN 978-3-7983-2816-7 (print) EUR 14,50
ISBN 978-3-7983-2817-4 (online)
- 33: Durach, Christian F.: A Theoretical and Practical Contribution to Supply Chain Robustness.** Developing a Schema for Robustness in Dyads. - 2016. - viii, 183 S.
ISBN 978-3-7983-2812-9 (print) EUR 13,50
ISBN 978-3-7983-2813-6 (online)
- 34: Blome, Hendrik: Logistische Optionen für eine nachhaltige Versorgung von Subsahara Afrika.** Ein Beitrag zur Humanitären Logistik. - 2016. - XVII, 315 S.
ISBN 978-3-7983-2840-2 (print) EUR 16,50
ISBN 978-3-7983-2841-9 (online)
- 35: Kucht Campos, Juliana: A methodology for planning sustainable supply chain initiatives.** - 2016. - xviii, 326 S.
ISBN 978-3-7983-2860-0 (print) EUR 16,50
ISBN 978-3-7983-2861-7 (online)
- 36: Wutke, Sebastian: Entwicklung eines Gestaltungsmodells zur Berücksichtigung von Nachhaltigkeit bei der Ausschreibung und Vergabe logistischer Leistungen im Straßengüterverkehr.** - 2017. - X, 299 S.
ISBN 978-3-7983-2862-4 (print) EUR 15,50
ISBN 978-3-7983-2863-1 (online)
- 37: Schöder, Dustin: Technisch-wirtschaftliche Bewertung des Einsatzes von batterieelektrischen Nutzfahrzeugen in der Distribution von Konsumgütern.** - 2017. - XV, 287 S.
ISBN 978-3-7983-2920-1 (print) EUR 15,50
ISBN 978-3-7983-2921-8 (online)
- 38: Roy, Daniel Thomas: Industrie 4.0 – Gestaltung cyber-physischer Logistiksysteme zur Unterstützung des Logistikmanagements in der Smart Factory.** - 2017. - XVI, 204 S.
ISBN 978-3-7983-2944-7 (print) EUR 14,50
ISBN 978-3-7983-2945-4 (online)
- 39: Ding, Feng: Developing e-commerce logistics in cross-border relation.** - 2018. - XV, 186 S.
ISBN 978-3-7983-2972-0 (print) EUR 14,50
ISBN 978-3-7983-2973-7 (online)
- 40: Nitsche, Benjamin: Development of an assessment tool to control supply chain volatility.** - 2019. - VII, 161 S.
ISBN 978-3-7983-3054-2 (print) EUR 12,50
ISBN 978-3-7983-3055-9 (online)
- 41: Mittag, Peter: Entwicklung eines anwendungsorientierten Gestaltungsansatzes zur Geschäftsmodellinnovation mithilfe von smarten Produkt-Service-Systemen.** - 2019. - XXXIII, 201 S.
ISBN 978-3-7983-3048-1 (print) EUR 14,00
ISBN 978-3-7983-3049-8 (online)
- 42: Reipert, Jan: Open Innovation in der Logistik – Entwicklung eines Gestaltungsmodells zum Aufbau eines offenen Innovationsmanagements in logistischen Dienstleistungsunternehmen.** - 2019. - X, 206, XLVIII S.
ISBN 978-3-7983-3062-7 (print) EUR 10,50
ISBN 978-3-7983-3063-4 (online)
- 43: Junge, Anna Lisa: Conceptualizing and capturing digital transformation's customer value – a logistics and supply chain management perspective.** - 2020. - 214 S.
ISBN 978-3-7983-3177-8 (print) EUR 15,50
ISBN 978-3-7983-3178-5 (online)
- 44: Wiederer, Chistina: Overcoming logistics-related barriers to higher-value exports – A decision framework to identify policy measures.** - 2021. - XVI, 425 S.
ISBN 978-3-7983-3230-0 (print)
ISBN 978-3-7983-3231-7 (online)

Management model for social and environmental impact in logistics through blockchain technologies

In the context of the advancing digitalization of logistics processes, blockchain technologies are gaining in importance. Within the scope of sustainable logistics networks, they contribute to cross-stakeholder transparency and support the tracking and verification of products and processes to improve social and environmental parameters. The goal of this work is to develop a holistic management model to help users understand blockchain technologies in the context of their logistics network and to assess the mindful adoption of these technologies to specific problems. In addition, the model should enable the conclusion of expected impacts on participating actors within the logistics network with regard to social and environmental sustainability and, in a further step, provide a holistic approach to the implementation of blockchain technologies. Methodologically, a systematic literature analysis, two workshops and a case study exploration will be conducted for this purpose.

ISBN 978-3-7983-3250-8 (print)

ISBN 978-3-7983-3251-5 (online)



ISBN 978-3-7983-3250-8



<https://verlag.tu-berlin.de>