

Yildiz, Dilek; Wiśniewski, Arkadiusz; Brzozowska, Zuzanna; Durowaa-Boateng, Afua

Working Paper

A flexible model to reconstruct education-specific fertility rates: Sub-Saharan Africa case

Vienna Institute of Demography Working Papers, No. 02/2023

Provided in Cooperation with:

Vienna Institute of Demography (VID), Austrian Academy of Sciences

Suggested Citation: Yildiz, Dilek; Wiśniewski, Arkadiusz; Brzozowska, Zuzanna; Durowaa-Boateng, Afua (2023) : A flexible model to reconstruct education-specific fertility rates: Sub-Saharan Africa case, Vienna Institute of Demography Working Papers, No. 02/2023, Austrian Academy of Sciences (ÖAW), Vienna Institute of Demography (VID), Vienna, <https://doi.org/10.1553/0x003e65e0>

This Version is available at:

<https://hdl.handle.net/10419/278613>

Standard-Nutzungsbedingungen:

Die Dokumente auf EconStor dürfen zu eigenen wissenschaftlichen Zwecken und zum Privatgebrauch gespeichert und kopiert werden.

Sie dürfen die Dokumente nicht für öffentliche oder kommerzielle Zwecke vervielfältigen, öffentlich ausstellen, öffentlich zugänglich machen, vertreiben oder anderweitig nutzen.

Sofern die Verfasser die Dokumente unter Open-Content-Lizenzen (insbesondere CC-Lizenzen) zur Verfügung gestellt haben sollten, gelten abweichend von diesen Nutzungsbedingungen die in der dort genannten Lizenz gewährten Nutzungsrechte.

Terms of use:

Documents in EconStor may be saved and copied for your personal and scholarly purposes.

You are not to copy documents for public or commercial purposes, to exhibit the documents publicly, to make them publicly available on the internet, or to distribute or otherwise use the documents in public.

If the documents have been made available under an Open Content Licence (especially Creative Commons Licences), you may exercise further usage rights as specified in the indicated licence.

ÖAW

AUSTRIAN
ACADEMY OF
SCIENCES

VIENNA INSTITUTE OF DEMOGRAPHY

WORKING PAPERS

02/2023

A FLEXIBLE MODEL TO RECONSTRUCT EDUCATION-SPECIFIC FERTILITY RATES: SUB-SAHARAN AFRICA CASE

DILEK YILDIZ, ARKADIUSZ WIŚNIEWSKI, ZUZANNA BRZOWSKA
AND AFUA DUROWAA-BOATENG

Vienna Institute of Demography
Austrian Academy of Sciences
Dr. Ignaz-Seipel-Platz 2 1010 Vienna, Austria
vid@oeaw.ac.at | www.oeaw.ac.at/vid



ABSTRACT

The future world population growth and size will be largely determined by the pace of fertility decline in sub-Saharan Africa. Correct estimates of education-specific fertility rates are crucial for projecting the future population. Yet, consistent cross-country, comparable estimates of education-specific fertility for sub-Saharan African countries are still lacking. We propose a flexible Bayesian hierarchical model that reconstructs education-specific fertility rates by combining the patchy Demographic and Health Surveys (DHS) data and the United Nations' (UN) reliable estimates of total fertility rates (TFR). Our model produces estimates that match the UN TFR to different extents (in other words, estimates of varying levels of consistency with the UN). We present three model specifications: Consistent but not identical with the UN; fully-consistent (nearly identical) with the UN, and consistent with the DHS. Further, we provide a full time series of education-specific TFR estimates covering five-year periods between 1980 and 2014 for 36 sub-Saharan African countries. The results show that the DHS-consistent estimates are usually higher than the UN-fully-consistent ones. The differences between the three model estimates vary substantially in size across countries, yielding 1980–2014 fertility trends that diverge from each other—mostly in level only, but also sometimes in direction.

KEYWORDS

Bayesian, Sub-Saharan Africa, Education-specific fertility rates, Demographic and Health Survey

AUTHORS

Dilek Yildiz, International Institute for Applied Systems Analysis, Vienna Institute of Demography (OeAW), Wittgenstein Centre for Demography and Global Human Capital (IIASA, OeAW, University of Vienna), E-mail: yildiz@iiasa.ac.at

Arkadiusz Wiśniowski, Social Statistics Department, University of Manchester, E-mail: a.wisniowski@manchester.ac.uk

Zuzanna Brzozowska, Austrian National Public Health Institute (GÖG), Vienna Institute of Demography (OeAW), Wittgenstein Centre for Demography and Global Human Capital (IIASA, OeAW, University of Vienna), E-mail: zuzanna.brzozowska@oeaw.ac.at

Afua Durowaa-Boateng, Vienna Institute of Demography (OeAW), Wittgenstein Centre for Demography and Global Human Capital (IIASA, OeAW, University of Vienna), E-Mail: afua.durowaa-boateng@oeaw.ac.at

ACKNOWLEDGEMENTS

The authors gratefully acknowledge funding from the Austrian Academy of Sciences' (ÖAW) "Innovation Fund Research, Science and Society" for the "Bayesian reconstruction of populations and vital rates by educational attainment" research project (IF_2019_29_BayesEdu).

1 INTRODUCTION

The future world population growth and size will be largely determined by the pace of fertility decline in sub-Saharan Africa (Bongaarts, 2006, 2008; Shapiro & Gebreselassie, 2008). A key factor will be women's educational attainment (Lutz et al., 2018), because global trends show that fertility has a strong and negative correlation with female education: Women with higher levels of education usually have fewer children than those with lower levels of education (Amin & Behrman, 2011; Bongaarts, 2010; Castro Martin, 1995; Gebreselassie & Shapiro, 2016).¹ This link is particularly strong in low-income and high-fertility regions such as sub-Saharan Africa (Skirbekk, 2008). Recently, Kebede et al. (2019) have shown that the fertility decline stalls observed in some sub-Saharan African countries during the late 1990s and early 2000s resulted, at least partly, from disruptions to female educational expansion in the 1980s.

The importance of education for fertility is also reflected in multi-state projections, for which education-specific fertility rates are among the key input data. Population projections that account for educational component have been shown to consistently result in lower future population counts than those excluding education (Gietel-Basten & Sobotka, 2021; Lutz & KC, 2011). Yet, consistent cross-country, comparable estimates of education-specific fertility—in particular total fertility rates (TFR) for sub-Saharan African countries—are still lacking.

The Demographic and Health Surveys (USAID, 2023), which were launched in 1984, are the main source of comparative demographic data about sub-Saharan Africa, and are a series of repeated cross-sectional representative surveys and conducted in over 90 low- and middle-income countries. The DHS data are usually collected in five-year intervals and provide detailed information about, among other things, respondents' socioeconomic characteristics, infant and child mortality, and women's birth histories. They are among the main data sources used in United Nations (UN) population projections for low- and middle-income countries (UN, 2022), and are the only data source that allows for comparative studies of the education-fertility relationship in these countries (Kebede et al., 2019; Schoumaker, 2008; Sneeringer, 2009).

As indispensable as the DHS data are for researchers, policy makers, planners, and international organisations, they display serious quality issues. First, most of the included African countries have only conducted a few nationally representative fertility surveys of varying quality since the 1980s, causing missingness and inconsistencies in the time series (Schoumaker, 2014). Thus, the surveys cover different periods in different countries, and the obtained data series have temporal gaps. Second, the data demonstrate the typical limitations of sample surveys: few observations for some population groups, measurement errors (e.g., misreporting), and sampling errors. For instance, the share of women with high education is so low in some low-income countries that the values obtained through surveys are insufficient for making reliable fertility rate estimations. Further, measurement errors may concern the reporting timing (e.g., heaping birthdates on years ending with 0 or 5; the Potter effect, which happens when the timing of distant births is reported as being closer to the survey date) and/or the number of events (i.e., omission of births), and typically increase in parallel with the timespan between the estimated period and the time of data collection (the DHS data on birth histories allow for estimating retrospective fertility rates up to 25 years prior to survey date). Sampling errors usually include the over- or under-sampling of certain population groups as well as selection bias caused by selective mortality and/or migration (Schoumaker, 2014).

These quality issues result in inconsistencies in estimates across sources, countries, and time (Al Zalak & Goujon, 2017; Schoumaker, 2014, 2011); in particular, in biased estimates of period fertility and mortality rates (Alkema et al., 2012; Rajaratnam et al., 2010; Schoumaker, 2013). Recently, it has been shown that the aforementioned stalls in fertility decline in sub-Saharan Africa may be much less spread than the published DHS data suggest (Schoumaker, 2019). Schoumaker observes that "taking published [DHS] fertility figures at face value could be risky in some contexts," whereby "[i]nferring fertility trends by comparing recently published [DHS] fertility data from successive surveys may lead to erroneous trend results" (Schoumaker, 2014, p. xi). Therefore, he corrected the reconstructed fertility rates from DHS birth histories by using a Poisson

¹ In some low-fertility countries, this relationship has recently changed into a positive one or an inverted U-shape pattern where women with medium education have higher fertility than their peers with highest and lowest levels of education (Jalovaara et al., 2019). However, the current paper focuses on high-fertility countries, where the association remains strictly negative.



regression (Schoumaker, 2013, 2010). Although, his model can be enhanced by education parameters to estimate fertility by the level of education, the resulting fertility estimates are higher than those published by the UN Population Division, the main provider of global population estimates and projections to the UN. This is because the fertility rates reported in DHS are often higher than the UN fertility rates.

The UN is aware of the DHS quality issues and therefore do not exclusively rely on it for producing the population estimates and projection datasets published in the World Population Prospects (WPP). Rather, the UN combines DHS data with other data sources and regularly updates its estimates of past fertility rates, along with other demographic rates and population counts. They use an iterative process to improve past estimates of fertility rates to ensure their consistency with other demographic components and over time. For example, Alkema et al. (2012) developed a probabilistic model to estimate the trends in TFR and their uncertainty for several West African countries by decomposing the measurement error into bias and variance. Those estimates, however, are only available for the overall fertility rates and not by the level of educational attainment.

This paper proposes a flexible Bayesian hierarchical model to reconstruct fertility rates for four educational categories using the full birth history module from the DHS and the UN's TFR estimates. Our resulting estimates cover five-year periods between 1980 and 2014 and fill the gap in the time series for 36 sub-Saharan African countries. Our model is flexible in the sense that it produces estimates of varying levels of consistency of the resulting TFR with the UN data. We provide results from three model specifications: (1) estimated TFR consistent but not identical with the TFR estimated by the UN (hereafter, "Main model (UN-consistent)"); (2) estimated TFR fully consistent (nearly identical) with the TFR estimated by the UN (hereafter, "UN-fully-consistent", and (3) estimated TFR consistent only with the TFR estimated by the DHS (hereafter, "DHS-consistent"). First, we assess the estimates from three models against the DHS and UN data; next, we evaluate the education-specific estimates of fertility trends between 1980 and 2014 generated by the models. We also provide detailed documentation of the proposed method so that it can be applied to other countries, regions, and time periods.

2 DATA AND METHODS

2.1 DATA

We use two sources of fertility data: the UN World Population Prospects (WPP, UN, 2022) and surveys conducted under the umbrella of the Demographic and Health Surveys (DHS). The UN WPP 2022 total fertility rates (hereafter, UN TFR) are estimates based on multiple data sources and estimation methods (UN, 2022). These UN TFR estimates, which we treat as data inputs, are rigorously checked for consistency within and across countries and they are consistent with the other UN WPP rates, population estimates, and projections. The UN TFR estimates are updated approximately every two years as new data sources become available. Although they might be subject to sampling and modelling errors as well as biases, we assume negligible deviations from the true TFR values.

The DHS survey data include 178 datasets from 36 sub-Saharan African countries, of which 134 were Standard DHS surveys, 30 were Malaria Indicator Surveys (MIS), 9 were Continuous DHS surveys, four were Standard AIDS Indicator Surveys (AIS) and one was an Interim DHS survey. These combined surveys yield a sample of 1,684,458 women, of whom 38% (640,462) had no education, whereas 33.2% (559,362), 25.4% (428,251), and 3.4% (56,383) had primary, secondary, and higher education, respectively. Each educational attainment level comprises 766 data points for different years spanning from 1980 to 2014, thus producing a total of 3,064 data points. All survey files were downloaded from the DHS Program website (USAID, 2023). Survey years and characteristics are available in Appendix A Figure A.1.

The retrospective estimates of five-year period TFRs and education-specific, five-year period TFRs (ESTFR) were calculated using Stata's *tfr2* module for five-year periods from 1980–1984 to 2010–2014 (Schoumaker, 2013). The estimated rates are based on the birth histories of female survey participants aged 15 to 49. Our framework uses estimates for periods 0–4 years, 5–9 years, 10–14 years, and 15–19 years prior to the survey. This ensures we have more data points than the fertility estimates at the time of the survey only. This retrospective information is especially useful for countries that have only conducted one or two DHS surveys. The TFR and ESTFR estimates concerning 0 to 4 years before the survey are denoted by TFR0 and ESTFR0; estimates concerning 5 to 9 years before the survey are denoted by TFR5 and ESTFR5, and so on. Countries that conducted more than one DHS survey between 1980 and 2014 generate multiple TFR and ESTFR estimates that refer to the same five-year period. These values form an input to the statistical model and are assumed to be subject to bias and missingness. The biases are composite measures of misreporting in a survey (e.g., due to long recollection periods), the idiosyncratic errors, and potential model misspecifications implemented in the *tfr2* Stata module. Our modelling framework accounts for biases for each recall period and quality group from the survey and aims to reduce the bias in our final estimates and thus produce consistent estimates over time.

2.2 METHODS: EDUCATION-SPECIFIC FERTILITY RATES RECONSTRUCTION MODEL

The five-year period total fertility rates by educational attainment were reconstructed from the 1980–1984 period to the 2010–2014 period by using a hierarchical time series Bayesian model. The modelling framework is depicted in Figure 1, while the model's three levels are explained below. The key output from the model are the estimated ESTFRs, alongside measures of uncertainty. These ESTFRs refer to the estimates that are corrected for data inadequacies (see Introduction) and are based on information from both the DHS and UN TFR.

The first level starts by calculating the country-specific TFRs for each five-year period as the weighted sum of ESTFRs (Equation 1). Calculating TFRs allows us to control the consistency of our ESTFR estimates with the UN TFR. Weights $w[c,e,y]$ for each education level are equal to the proportions of women aged between 15 to 49, with educational attainment level e for a given country c and year y derived from population sizes by age and educational attainment (WIC, 2018).

$$TFR[c,y] = \sum_{e=1}^4 w[c,e,y] ESTFR[c,e,y], y = 1980-1984, 1985-1989, \dots, 2010-2014. (1)$$

Next, our TFR estimates are adjusted to the 2022 UN TFR data, denoted by $TFR_{UN}[c,y]$, as shown in Equation 2:

$$TFR_{UN}[c,y] \sim Normal(TFR[c,y], \sigma_{UN}[c,y]). (2)$$

The parameter for standard deviation, $\sigma_{UN}[c,y]$, captures the uncertainty of the UN TFR. The specification of $\sigma_{UN}[c,y]$ is flexible in that it can either be set as a model parameter that is estimated from the data, or it can be fixed at a value that reflects the researcher's degree of belief in the UN TFR data. For example, setting $\sigma_{UN}[c,y] = 0.1$ would mean that the true TFR lies within $TFR_{UN} \pm 0.2$ interval with probability 0.95.

At level 2 (Figure 1), a hierarchical time series model is assumed for our key quantity of interest: a "true" and unobserved ESTFR. The time series model assumes that each country-specific ESTFR follows its own autoregressive process, as shown in Equation 3 and Equation 4:

$$ESTFR[c,e,y] \sim Normal(\beta_0[1,r,e], \sigma_0) \text{ where } y = 1980-1984, (3)$$

$$ESTFR[c,e,y] \sim Normal(\beta_1[1,r,e] + \beta_2[1,r,e] * ESTFR[c,e,y-5], \sigma_1), \text{ where } y = 1985-1989, 1990-1994, \dots, 2010-2014. (4)$$

The studied countries are divided into four UN subregions (subscript r): Eastern, Middle, Southern, and Western Africa (see Table A1). Countries in the same subregion r have the same prior distributions for β_0 and β_1 . This allows for the smoothing of subregional ESTFRs over time and borrowing information from countries with multiple observations and better-quality DHS estimates to countries with fewer observations and lower quality estimates within the subregions.

At level 3, a measurement error model corrects the biases in the country-specific ESTFRs estimated for different periods (up to 20 years preceding a survey) from the same DHS survey, denoted by $ESTFR0_{DHS}[c,e,y]$, $ESTFR5_{DHS}[c,e,y]$, and so on, as described in the Introduction and Data sections. Similar to Alkema et al. (2012), we use the UN TFR data as the unbiased reference for our TFR estimate. To our knowledge, there is no bias-corrected dataset that provides ESTFR values consistent with the UN TFR and that can be used as the ESTFR unbiased reference. Therefore, the prior distributions for the ESTFR biases reflect both the difference between country-specific DHS and UN TFRs and the quality of DHS surveys in each country and each five-year period. Specifically, the prior distributions of the bias parameters for each quality level q , as listed in Schoumaker (2014; see also Figure A1 in Appendix) ($bias0[q]$, $bias5[q]$, and so on), are centred at the difference between each repeated DHS-based TFR and the UN TFR, i.e., $TFR0[c,y]-TFR_{UN}[c,y]$, $TFR5[c,y]-TFR_{UN}[c,y]$, and so on. Each of the three described models include this bias correction by level of quality q via informative prior distributions based on the UN TFR data regardless of any adjustment to the UN TFR.

$$ESTFR0_{DHS}[c,e,y] \sim Normal(ESTFR[c,e,y] + bias0[q], \sigma_{DHS,0}). (5)$$

Because we use Bayesian inference, the model must be completed by specifying prior distributions (or priors) and their hyperparameters for all model parameters. Informative priors are assumed for the above-mentioned $bias$ parameters and—if such approach is desirable—the standard deviation of the UN TFR data, σ_{UN} . All other priors are weakly informative with low precisions that let the data shape the posterior distributions of the model parameters. The full specification of all priors is provided in Appendix B.

This paper discusses results obtained from three different models: The first is the UN-fully-consistent model where benchmarking to the UN is achieved by setting an informative σ_{UN} parameter. The second is the UN-consistent model, often referred to as the main model, where benchmarking to the UN data is data driven, with a weakly informative prior assumed for σ_{UN} . Finally, the third model is a DHS-consistent one that uses the UN data only for correcting the DHS biases (Equation 5) but not for benchmarking (Equation 2).

FIGURE 1. TOTAL FERTILITY BY EDUCATIONAL ATTAINMENT RECONSTRUCTION MODEL FRAMEWORK

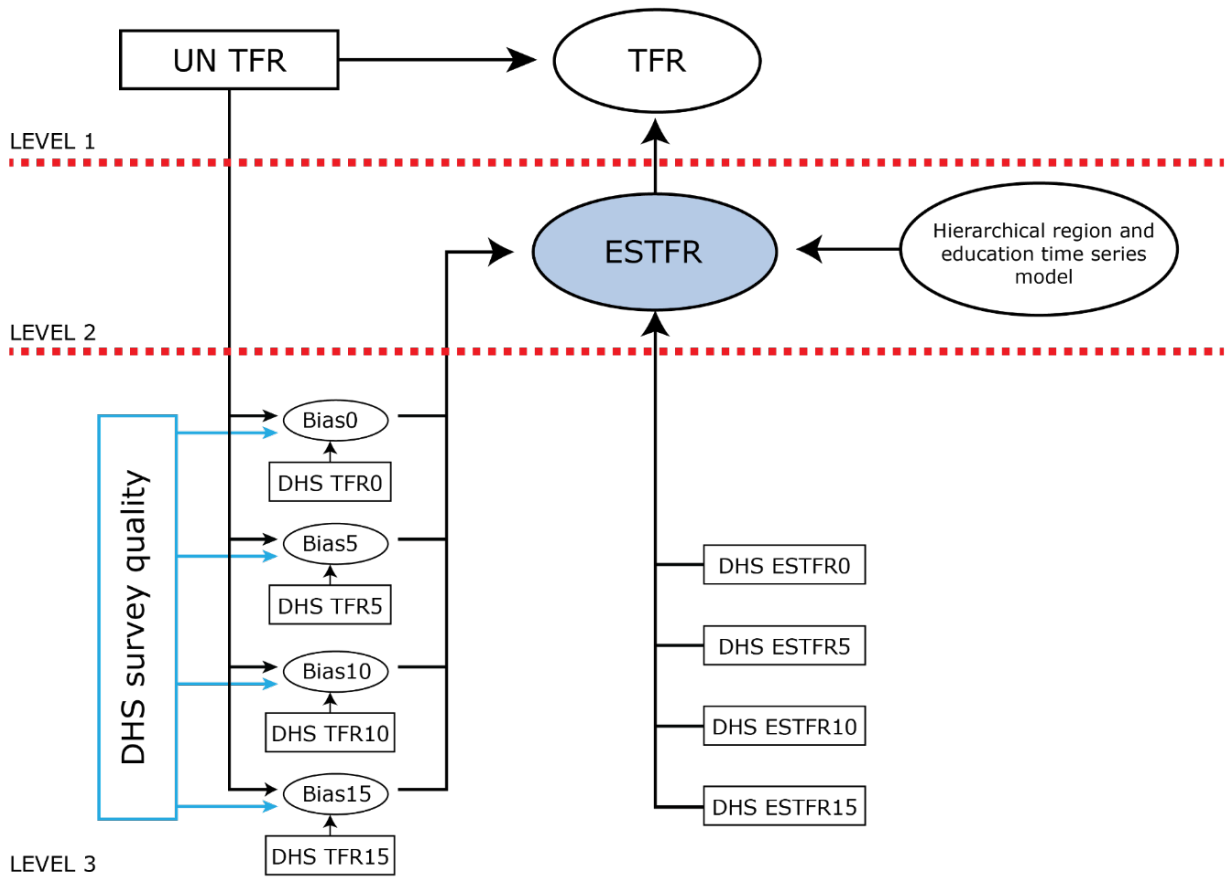

3 RESULTS

3.1 CONSISTENCY OF THE MODEL ESTIMATES WITH THE UN WPP 2022 AND DHS

To demonstrate the first step, Figure 2 shows the results for Kenya produced by the three models (estimates for all analysed countries are in the Appendix D). The red line and the dotted red lines represent the TFR estimated by our models and its 80% credible intervals,² respectively. The blue and green dots and the pink lines (which are only partly visible because of overlaps) depict TFRs estimated from the DHS using the *tfr2* Stata module (see Data section) and the UN data, respectively. In Figure 2, the left-hand panel shows the estimates from the UN-fully-consistent model that are perfectly aligned with the UN data (which explains the full overlap of the UN with the red line, which obscures the pink line). The very narrow credible interval (barely visible in the plot) is a direct result of the high precision assumed for the UN TFR ($\sigma_{UN}=1/\sqrt{1000}$ implies that the UN TFR is assumed to be within ± 0.06 interval around the estimated TFR value). In the middle panel, the UN-consistent model represents estimates from a model where benchmarking to the UN data is data driven, with a weakly informative prior assumed for parameter σ_{UN} . Finally, the right-hand panel shows estimates from the DHS-consistent model. Similar to the UN TFR, the TFR from in our three models tended to be consistently lower than the DHS TFR.

FIGURE 2. COMPARISON OF TFR ESTIMATES FOR KENYA

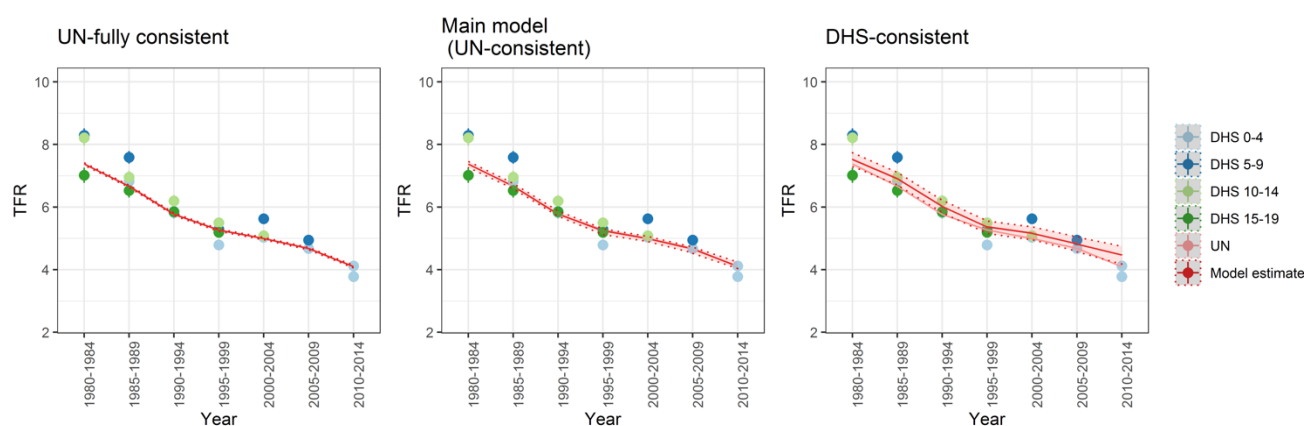

In the second step, we compared estimated fertility rates for all countries included in our study. For Kenya, the differences between the model estimates were modest, but this was not necessarily the case for other countries, as Figure 3 shows. On the one hand, it compares our three models and the UN TFR (upper panel), and the DHS TFR on the other hand (lower panel). The panels in Figure 3 appear in the same left-to-right order as Figure 2, where left-hand panel compares the estimated TFRs from the UN-fully-consistent model, the middle panel compares the estimated TFR from the Main model, and right-hand panel compares the estimated TFR from the DHS-consistent model. Similar to Figure 2, our estimates in the left-hand panel were nearly a perfect match with the UN TFR (upper panel), and were centred around the DHS estimates with different recall periods (lower panel). The estimates from the main model, as shown in the middle panel (data-driven benchmarking to the UN TFR),

² A credible interval is a counterpart of a confidence interval in frequentist inference. Both intervals measure the uncertainty around the “true” parameter value. Credible interval denotes a range in which the true parameter value lies with a given probability (80%—or 0.8, in our case).

aligned with the UN estimates but were slightly closer to the DHS estimates with a shorter recall period. Finally, the right-hand panel reveals that most of our estimated TFRs were higher than the UN TFRs an (upper panel). This is because the estimates were not benchmarked to the UN TFR and our estimates were closer to the TFRs derived from the DHS. Our estimates were also similar to the DHS data (lower-right panel) as in the main model, that is, they fit well to the short recall period DHS data. Some of our estimates deviated significantly from the DHS data. For example, UN-fully-consistent model estimated the TFR for Mozambique during the 1990–1994 period as 6.07, which is similar to the UN’s 6.09, while the DHS5 estimate for the same period was 3.08 (lower-left panel). Conversely, the same panel reveals a lower TFR estimate for Niger during the 2000–2004 period using the UN-fully-consistent model (7.7) than the DHS5 (9.9). The posterior distribution of bias parameters, which were the main drivers of the differences between our estimates and the DHS values, are available Appendix B Figure B1. As expected, the biases for poor-quality surveys and longer recall periods were estimated higher than biases for good-quality surveys and shorter recall periods.

FIGURE 3. ESTIMATED TFRs FOR ALL ANALYSED COUNTRIES: DHS AND UN ESTIMATES COMPARED TO ESTIMATES FROM THE THREE MODELS

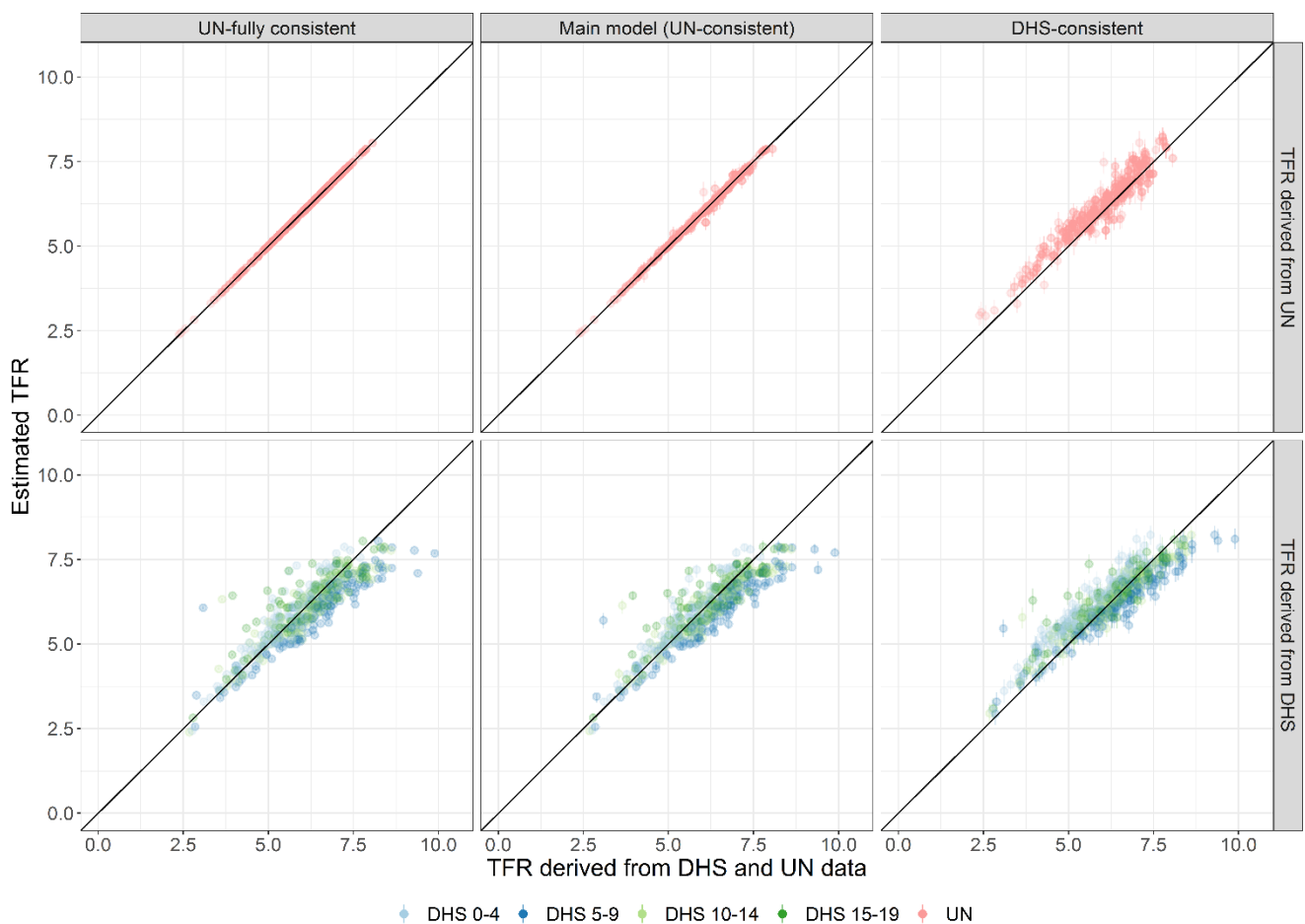

3.2 ESTIMATED FERTILITY RATES BY THE LEVEL OF EDUCATION

In the third step, we provided the estimated education-specific total fertility rates (ESTFRs) as population-weighted averages for four sub-Saharan African regions (thick lines) and the individual country values for their respective regions (thin lines) between 1985 and 2014 (Figure 4). The estimates were obtained from the main model that ensured data-driven consistency with the UN WPP 2022, but was not identical (UN-consistent, black lines) and from the model that was consistent with the DHS (DHS-consistent, red lines). The results from the UN-fully-consistent model are included in the Appendix (Figure C2).

Overall, the fertility estimates from both models followed similar trajectories, but those from the DHS-consistent model tended to be higher than those from the UN-consistent model. The differences were usually small, meaning both models' credible intervals overlapped greatly and the median values fell within the 80% credible interval of the other model. Nevertheless, there were some cases where the estimates differed substantially. For instance, in Middle Africa, the DHS-consistent model estimated an increase in the level of fertility among women with no and primary education and a plateau in fertility among women with secondary education in the 2000s and 2010s, whereas the UN-consistent model estimated a plateau (no and primary education) and a slight decrease (secondary education). In absolute values, the difference reached as much as one child per woman among women with no education in Middle Africa. Similarly, large differences were observed among women with primary and secondary education in Southern Africa, but they followed similar trends. Both models estimated stalls in fertility decline in all educational groups in Middle and Western Africa and among women with higher education in Southern and Eastern Africa.

FIGURE 4. TFR BETWEEN 1980–85 AND 2010–15 ESTIMATED BY TWO MODELS, BY COUNTRY AND REGION

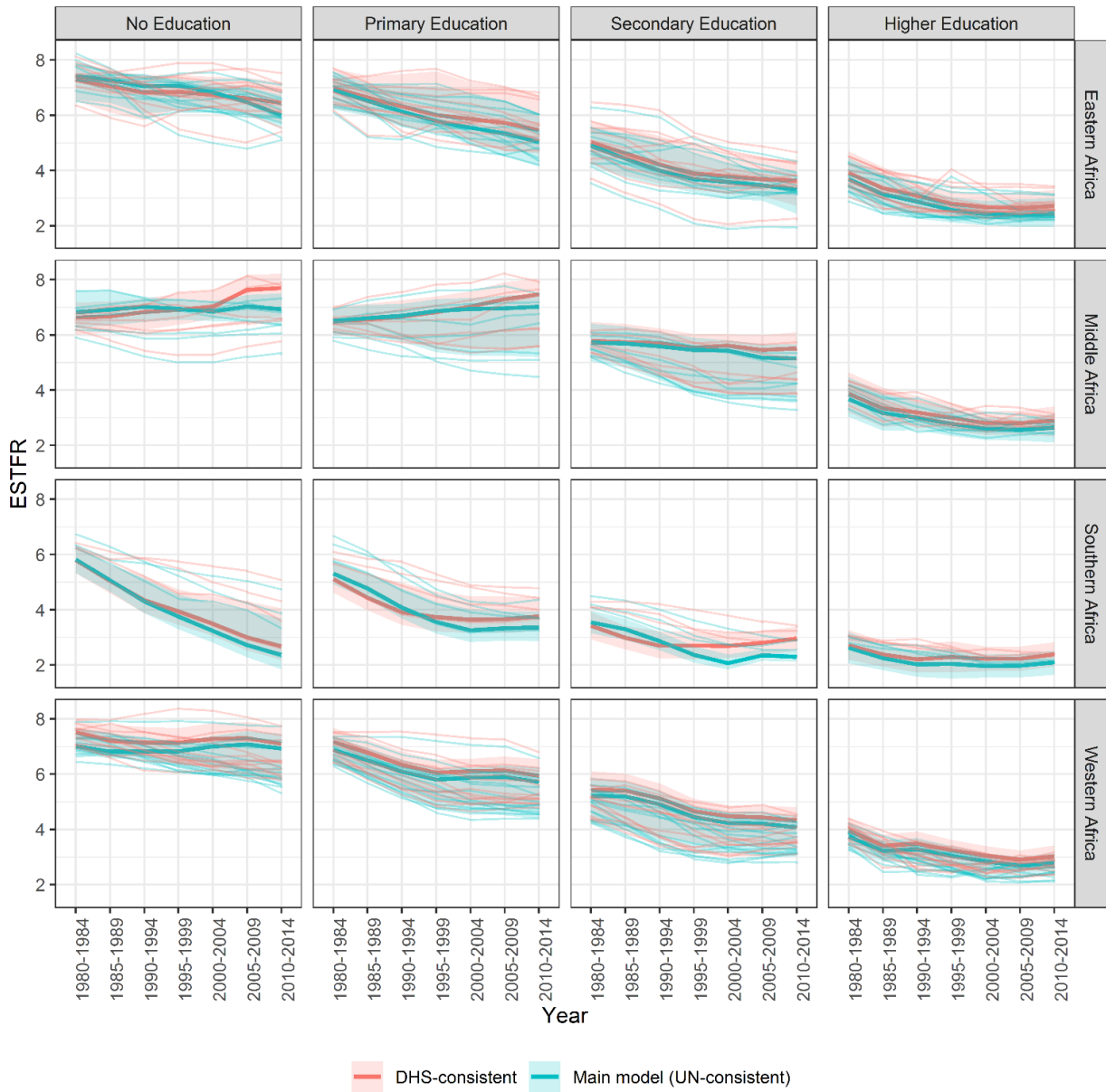

4 CONCLUSIONS AND DISCUSSION

Although there is extensive research about the fertility–education nexus in Africa, little attention has been given to the quality of its data sources, missingness, and the inconsistencies over time and across countries (Al Zalak & Goujon, 2017; Alkema et al., 2012; Schoumaker, 2014). Most of the work that systematically harmonises historical and current fertility data disaggregated by education level focuses on high-income countries (e.g., Human Fertility Database, Max Planck Institute for Demographic Research and Vienna Institute of Demography, 2023) where high-quality data are plentiful and stretch far back in time. However, comparable research on low-income countries has either focused on TFRs without an educational component, or employed household surveys that place little focus on the measurement errors, completeness, and consistency of the time series. These estimates also fail to match with the UN TFR. Furthermore, while population projections in the WIC Human Capital Data Explorer (WIC, 2018; Lutz & KC, 2011) include predicted future education-specific fertility rates, they do not provide ESTFRs for the past populations, which is vital for making reasonable predictions of future ESTFRs.

We propose a flexible Bayesian model to reconstruct education-specific total fertility rates (ESTFRs) from 1980–1984 to 2010–2014 in 36 sub-Saharan African countries. The proposed model combines data from two different yet imperfect sources of data: the UN and the DHS. The UN data are regarded as more reliable than the DHS but are not education-specific like the DHS. To demonstrate an approach that can overcome some of these data problems and create consistent and time series estimates, we developed three different model specifications. We presented three different model specifications that allow for varying levels of consistency with the UN estimates.

The DHS-consistent estimates were systematically higher than those consistent with the UN TFR. The three model estimates vary substantially in size across countries, yielding fertility trends that differ from each other—mostly in level only, sometimes in direction as well. To our knowledge, our estimates are the first education-specific fertility estimates that are consistent with the UN TFR and that fill the gaps in the time series that the DHS data suffer from.

Having access to good quality data on fertility, disaggregated by education, is essential to facilitate research about the impact of female education on fertility and to study how it differs among countries and evolves over time. Data for high-fertility countries, including those in sub-Saharan Africa, are of paramount importance, because these the future fertility rates from these countries are the largest source of uncertainty in the size of the future world population. A key contribution from this paper is that it departs from previous work, which only provided partial information about the education-specific fertility rates needed to study the impact of education on fertility systematically over time. Likewise, our methodology helps overcome data issues created by a lack of regular fertility surveys.

The quality issues arising from the existing fertility data have resulted in contradictory conclusions about fertility decline stalls in sub-Saharan Africa when using the same DHS data for the late 1990s and early 2000s (see Machiyama, 2010 for an overview and Schoumaker, 2019). While our study does not focus on the stalls, our UN-consistent estimates of fertility are systematically lower than estimates yielded by, or consistent with, the DHS. In many cases, like our example of Kenya, stalls that are reported by the DHS data—even when cleaned and smoothed as in the *tfr2* module (Schoumaker, 2013)—disappear upon applying our UN-consistent estimates. The difference between the DHS(-consistent) and the UN-consistent fertility estimates is particularly large for women with lower levels of education or no education at all.

There are several differences between our work and similar research by Alkema et al. (2012), which did not disaggregate the TFR by education. First, our work covered 36 countries in Africa, compared to seven in Alkema et al. (2012). Second, our model corrected country-specific biases in the DHS ESTFR by using UN TFR. While we achieved this correction via prior distributions that were constructed by pooling information over time, rather than by explicitly modelling bias with survey-based covariates, our approach arguably accomplished a comparable result. The results also included the uncertainty about the bias in the ESTFR estimates via the posterior distributions of the bias parameters. Finally, we relied on autoregressive rather than local smoothing over time.



Our model fit checks (Appendix C) show that the model fit the data well (Figure C1), with some underestimation of the observed UN TFR for earlier periods observed in, e.g., Angola, Cameroon, Ethiopia, Rwanda, and Namibia. Likewise, the model fit checks show an overestimation for the Central African Republic, Liberia, Madagascar, Congo, and Angola—especially in the later periods (2005 to 2014). We also observe that our model tends to underestimate TFRs that are larger than 6.00 and overestimate those that are lower. Our results from the main model are also robust after partially removing data from the DHS.

This research relies on several assumptions and is subject to limitations. First, we use the UN TFR data to correct the biases in DHS fertility rates, which may also be subject to bias themselves. Second, we have not explicitly accounted for the modelling error in the TFR estimates produced by the Stata *tfr2* module that are used as inputs to our Bayesian model. However, the latter source of bias is most likely captured in the composite measures of bias in Equation 5. Third, unlike Alkema et al. (2012), we do not take into account potential heteroskedasticity in the DHS measurements. Finally, the countries are grouped according to the quality of the DHS surveys as outlined in Schoumaker (2014) quality groups. When the most recent quality level from the DHS surveys is missing for a specific country, the country is assumed to be in the same quality group as in previous surveys.

Education-specific fertility rates are required to inform policymakers and reproductive health authorities both nationally and globally. While the DHS estimates are used for analysing fertility differentials by various sociodemographic characteristics, many population projections rely on the UN national-level demographic rates. In order to address the need to fill the gap in past fertility rates disaggregated by mother's educational attainment for different contexts and user requirements, we developed a flexible model. It allows for reconstructing the education-specific fertility rates with varying levels of consistency with the UN TFR. We found differences in past education-specific fertility rates when they are reconstructed by using three models that differ in the degree of consistency with the UN TFR. While the results from the DHS-consistent model show more frequent stalls in fertility rates for longer periods of time, the estimates from the UN-consistent model are often lower and with stalls, if present, starting later. Future users of our modelling framework and its resulting estimates can choose which set of ESTFR fits best to their specific needs.

REFERENCES

- Al Zalak, Z., & Goujon, A. (2017). Exploring the fertility trend in Egypt. *Demographic Research*, 37, 995–1030. <https://doi.org/10.4054/DemRes.2017.37.32>
- Alkema, L., Raftery, A., Gerland, P., Clark, S. J., & Pelletier, F. (2012). Estimating Trends in the Total Fertility Rate with Uncertainty Using Imperfect Data: Examples from West Africa. *Demographic Research*, 26, 331–362. <https://doi.org/10.4054/DemRes.2012.26.15>
- Amin, V., & Behrman, J. R. (2011). Do More-Schooled Women Have Fewer Children and Delay Childbearing? Evidence from a Sample of U.S. Twins. *SSRN Electronic Journal*. <https://doi.org/10.2139/ssrn.1968451>
- Bongaarts, J. (2006). The causes of stalling fertility transitions. *Studies in Family Planning*, 37(1), 1–16.
- Bongaarts, J. (2008). Fertility transitions in developing countries: Progress or stagnation? *Studies in Family Planning*, 39(2), 105–110. <https://doi.org/10.2307/20454448>
- Bongaarts, J. (2010). The causes of educational differences in fertility in Sub-Saharan Africa. *Vienna Yearbook of Population Research*, 8, 31–50.
- Castro Martin, T. (1995). Women's education and fertility: Results from 26 demographic and health surveys. *Studies in Family Planning*, 26(4), 187–202.
- Gebreselassie, T., & Shapiro, D. (2016). *Education and Fertility in Sub-Saharan Africa: What Do We Really Know?**. Population Association of America Annual Meeting, Washington D.C., US.
- Gietel-Basten, S., & Sobotka, T. (2021). Trends in population health and demography. *The Lancet*, 398(10300), 580–581. [https://doi.org/10.1016/S0140-6736\(21\)01051-5](https://doi.org/10.1016/S0140-6736(21)01051-5)
- Jalovaara, M., Neyer, G., Andersson, G., Dahlberg, J., Dommermuth, L., Fallesen, P., & Lappegård, T. (2019). Education, Gender, and Cohort Fertility in the Nordic Countries. *European Journal of Population*, 35(3), 563–586. <https://doi.org/10.1007/s10680-018-9492-2>
- Kebede, E., Goujon, A., & Lutz, W. (2019). Stalls in Africa's fertility decline partly result from disruptions in female education. *Proceedings of the National Academy of Sciences*, 116(8), 2891–2896. <https://doi.org/10.1073/pnas.1717288116>
- Lutz, W., Goujon, A., KC, S., Stonawski, M., & Stilianakis, N. (2018, April 12). *Demographic and Human Capital Scenarios for the 21st Century: 2018 assessment for 201 countries* [Text]. EU Science Hub - European Commission. <https://ec.europa.eu/jrc/en/publication/demographic-and-human-capital-scenarios-21st-century-2018-assessment-201-countries>
- Lutz, W., & KC, S. (2011). Global human capital: Integrating education and population. *Science*, 333(6042), 587–592. <https://doi.org/10.1126/science.1206964>
- Machiyama, K. (2010). *A re-examination of recent fertility declines in sub-Saharan Africa* (DHS Working Papers No. 68). ICF Macro. <http://www.measuredhs.com/pubs/pdf/WP68/WP68.pdf>
- Max Planck Institute for Demographic Research (Germany) and Vienna Institute of Demography (Austria). (2023). *Human Fertility Database* [Data set]. www.humanfertility.org

- Rajaratnam, J. K., Marcus, J. R., Flaxman, A. D., Wang, H., Levin-Rector, A., Dwyer, L., Costa, M., Lopez, A. D., & Murray, C. J. (2010). Neonatal, postneonatal, childhood, and under-5 mortality for 187 countries, 1970–2010: A systematic analysis of progress towards Millennium Development Goal 4. *The Lancet*, 375(9730), 1988–2008. [https://doi.org/10.1016/S0140-6736\(10\)60703-9](https://doi.org/10.1016/S0140-6736(10)60703-9)
- Schoumaker, B. (2013). A Stata module for computing fertility rates and TFRs from birth histories: Tfr2. *Demographic Research*, 28.
- Schoumaker, B. (2014). *Quality and consistency of DHS fertility estimates, 1990 to 2012* (DHS Methodological Reports No. 12). ICF International.
- Schoumaker, B. (2019). Stalls in Fertility Transitions in sub-Saharan Africa: Revisiting the Evidence. *Studies in Family Planning*, 50(3), 257–278. <https://doi.org/10.1111/sifp.12098>
- Schoumaker, B. (2008). *Stalls and reversals in fertility transitions in sub-Saharan Africa: Real or spurious? Human Fertility in Africa: Trends in the Last Decade and Prospects for Change.*, Cape Coast, Ghana.
- Schoumaker, B. (2010). Reconstructing fertility trends in sub-Saharan Africa by combining multiple surveys affected by data quality problems. *Proceedings of the 2010 Annual Meeting of the Population Association of America*.
- Schoumaker, B. (2011). Omissions of births in DHS birth histories in sub-Saharan Africa: Measurement and determinants. *Proceedings of the 2011 Annual Meeting of the Population Association of America*.
- Shapiro, D., & Gebreselassie, T. (2008). Fertility transition in sub-Saharan Africa: Falling and stalling. *African Population Studies*, 23, 3–23.
- Skirbekk, V. (2008). Fertility trends by social status. *Demographic Research*, 18, 145–180. <https://doi.org/10.4054/DemRes.2008.18.5>
- Sneeringer, S. E. (2009). *Fertility Transition in Sub-Saharan Africa: A Comparative Analysis of Cohort Trends in 30 Countries* (No. 23; DHS Comparative Reports). DHS comparative reports.
- United Nations. (2022). *World Population Prospects: The 2022 Revision*. Department of Economic and Social Affairs, Population Division. <http://esa.un.org/unpd/wpp/>
- USAID. (2023). *The DHS Program: Demographic and Health Surveys*. ICF International. <https://dhsprogram.com/>
- WIC - Wittgenstein Centre for Demography and Global Human Capital. (2018). Wittgenstein Centre Data Explorer Version 2.0. Available at: <http://www.wittgensteincentre.org/dataexplorer>

APPENDIX

APPENDIX A – DHS SURVEYS AND THEIR CHARACTERISTICS

FIGURE A1. TYPES OF SURVEY USED IN THE RESEARCH AND THEIR CHARACTERISTICS

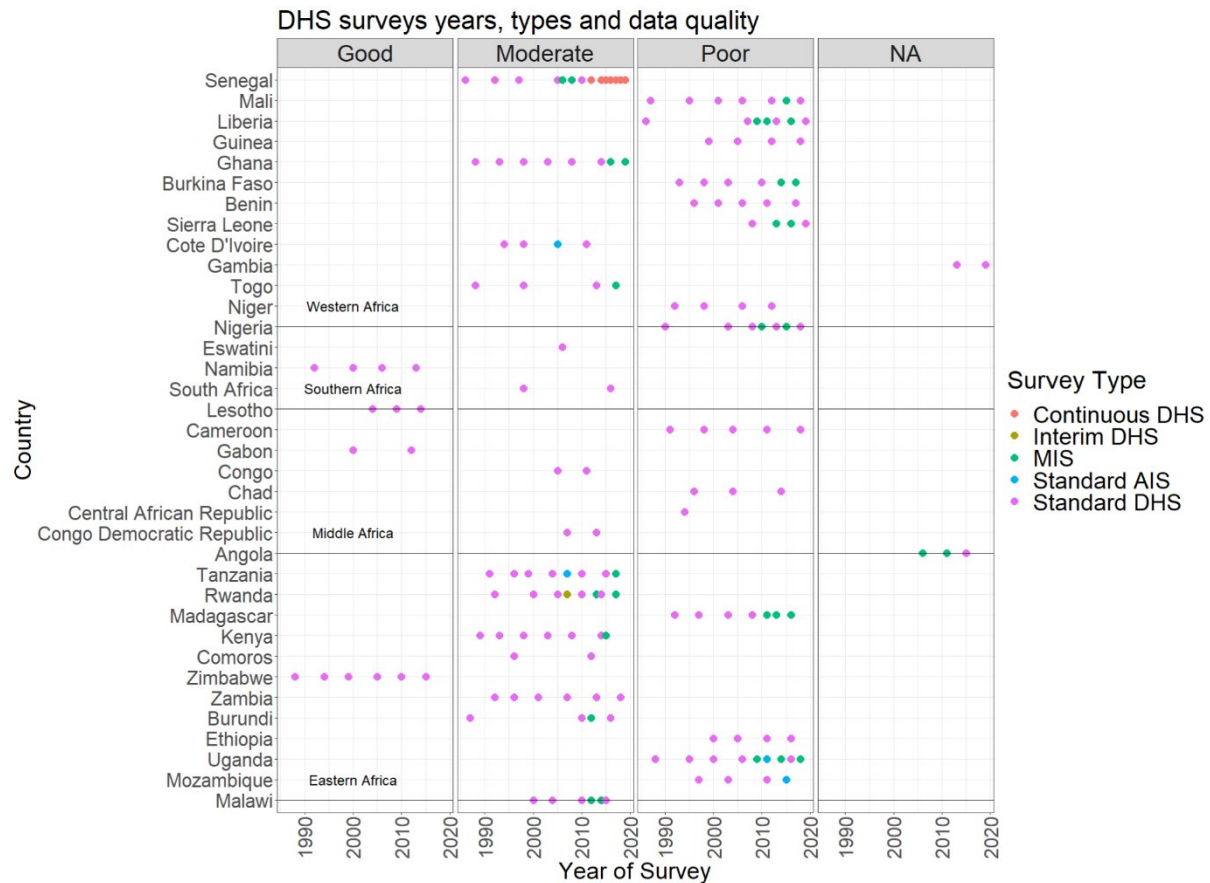

Source: The quality assessment of the DHS surveys is based on Schoumaker (2014).

APPENDIX B – PRIOR DISTRIBUTIONS FOR MODEL PARAMETERS

Prior distributions (or priors)³ for the autoregressive model parameters, β_0 and β_1 , are centred at the observed mean of the DHS ESTFR values for the period 1980–1984 and the remaining periods after 1980–1984, respectively (denoted below by b_0 and b_1). These values are displayed in Table B1. We also assume that the time series autoregressive models are stationary (parameter β_2 is within (0,1) interval with a weakly informative prior):

$$\begin{aligned}\beta_0[1, r, e] &\sim \text{Normal}(b_0, \tau_{b_0}) \\ \beta_1[1, r, e] &\sim \text{Normal}(b_1, \tau_{b_1}) \\ \beta_2[1, r, e] &\sim \text{Normal}(0.5, 1), \quad \beta_2[1, r, e] \in (0, 1)\end{aligned}$$

The JAGS software, which was used for the Bayesian hierarchical model, requires precision parameters instead of standard deviation as an input. Hence, we use τ for the precision and σ for the standard deviation in the specifications for the priors shown below.

$$\begin{aligned}\tau_{b_0} &= 1/\sigma_{b_0}^2 \\ \tau_{b_1} &= 1/\sigma_{b_1}^2 \\ \sigma_{b_0} &\sim \text{Normal}(1.365, b_{0_{prec}}) \\ \sigma_{b_1} &\sim \text{Normal}(1.543, b_{0_{prec}})\end{aligned}$$

The observed standard deviations in DHS ESTFR for the period 1980–1984 and the remaining periods after 1980–1984 were 1.365 and 1.543, respectively.

Where precision (inverse variance) is

$$b_{0_{prec}} \sim \text{Uniform}(0, 1)$$

$$1/\sigma_{10}^2 \sim \text{Normal}_+(5, 10)$$

$$1/\sigma_{11}^2 \sim \text{Normal}_+(5, 10),$$

where Normal_+ denotes a positive, half-normal distribution. In the main model, $\sigma_{UN}[c, y]$ follows a country- and year-specific half-normal distribution with a mean equal to 1% of the TFR[c, y].

$$\sigma_{UN}[c, y,] \sim \text{Normal}_+(TFR * 0.01, 100).$$

This prior provides sufficient range for the variability of the UN TFR without causing numerical instability and is, practically, very weakly informative. The range of posterior distribution of $1/(\sigma_{UN}[c, y])^2$ is contained within 0.0 and 0.4.

The prior for $\sigma_{UN}[c, y]$ is not specified in the model without UN data; it is fixed at $\sigma_{UN} = 0.03$ in the UN-fully-consistent model.

$$1/(\sigma_{DHS, x})^2 \sim \text{Normal}(1/(d_x)^2, d_{prec})$$

$$d_{prec} \sim \text{Uniform}(0, 1).$$

The expected value for the precision of the DHS data on ESTFR (d_x) is sourced directly from the relevant DHS data. The values used in the estimation are available in Table B2.

³ In Bayesian inference, each estimable parameter requires a distribution that reflects the modeller's knowledge of it before seeing the data. Often, we use weakly informative priors that are convenient for the numerical stability of the estimation algorithms and "let the data speak for themselves," i.e., give a strong preference to the signal in the data rather than prior itself.

TABLE B1. PRIOR VALUES FOR HYPERPARAMETERS b_0 AND b_1

Subregion	Education	Year	b_0	b_1
Eastern Africa	No Education	1980–1984	7.32	6.99
	Primary Education	1980–1984	6.99	6.37
	Secondary Education	1980–1984	5.40	4.27
	Higher Education	1980–1984	4.19	3.04
Middle Africa	No Education	1980–1984	6.89	6.79
	Primary Education	1980–1984	6.64	6.32
	Secondary Education	1980–1984	5.69	4.95
	Higher Education	1980–1984	4.32	3.30
Southern Africa	No Education	1980–1984	6.21	4.61
	Primary Education	1980–1984	5.63	4.47
	Secondary Education	1980–1984	3.84	3.16
	Higher Education	1980–1984	3.05	2.60
Western Africa	No Education	1980–1984	7.42	7.26
	Primary Education	1980–1984	7.06	6.12
	Secondary Education	1980–1984	5.13	4.58
	Higher Education	1980–1984	4.57	3.70

Source: Authors' own calculation using ESTFR estimated by the tfr2 module

TABLE B2. PRIOR VALUES FOR HYPERPARAMETER d_x (ROUNDED)

Period	d_x
0	1.631
5	1.948
10	1.720
15	1.529

Source: Authors' own calculation using ESTFR estimated by the tfr2 module

Priors for the period- and quality-group-specific bias parameters and associated precisions are calculated by subtracting the UN TFR from the DHS TFR estimated by the tfr2 module for different recall periods.

$$bias[q, p] \sim Normal(biasmean[q, p], biasprec[q, p])$$

TABLE B3. PRIORS FOR THE MEAN AND THE PRECISION FOR THE BIAS PARAMETERS

Period	Quality	Mean (biasmean)	Precision (biasprec)
0	Poor	0.364	4.291
0	Moderate	0.223	9.746
0	Good	0.218	12.019
5	Poor	0.723	2.233
5	Moderate	0.449	8.874
5	Good	0.241	9.860
10	Poor	0.393	3.156
10	Moderate	0.291	8.548
10	Good	0.277	7.492
15	Poor	0.523	1.981
15	Moderate	0.329	4.338
15	Good	0.308	4.382

Source: Authors' own calculation using ESTFR estimated by the tfr2 module and the UN TFR

FIGURE B1. PRIOR AND POSTERIOR DISTRIBUTIONS OF BIAS PARAMETERS BASED ON YEARS BEFORE THE SURVEY AND THE QUALITY OF DHS SURVEY.

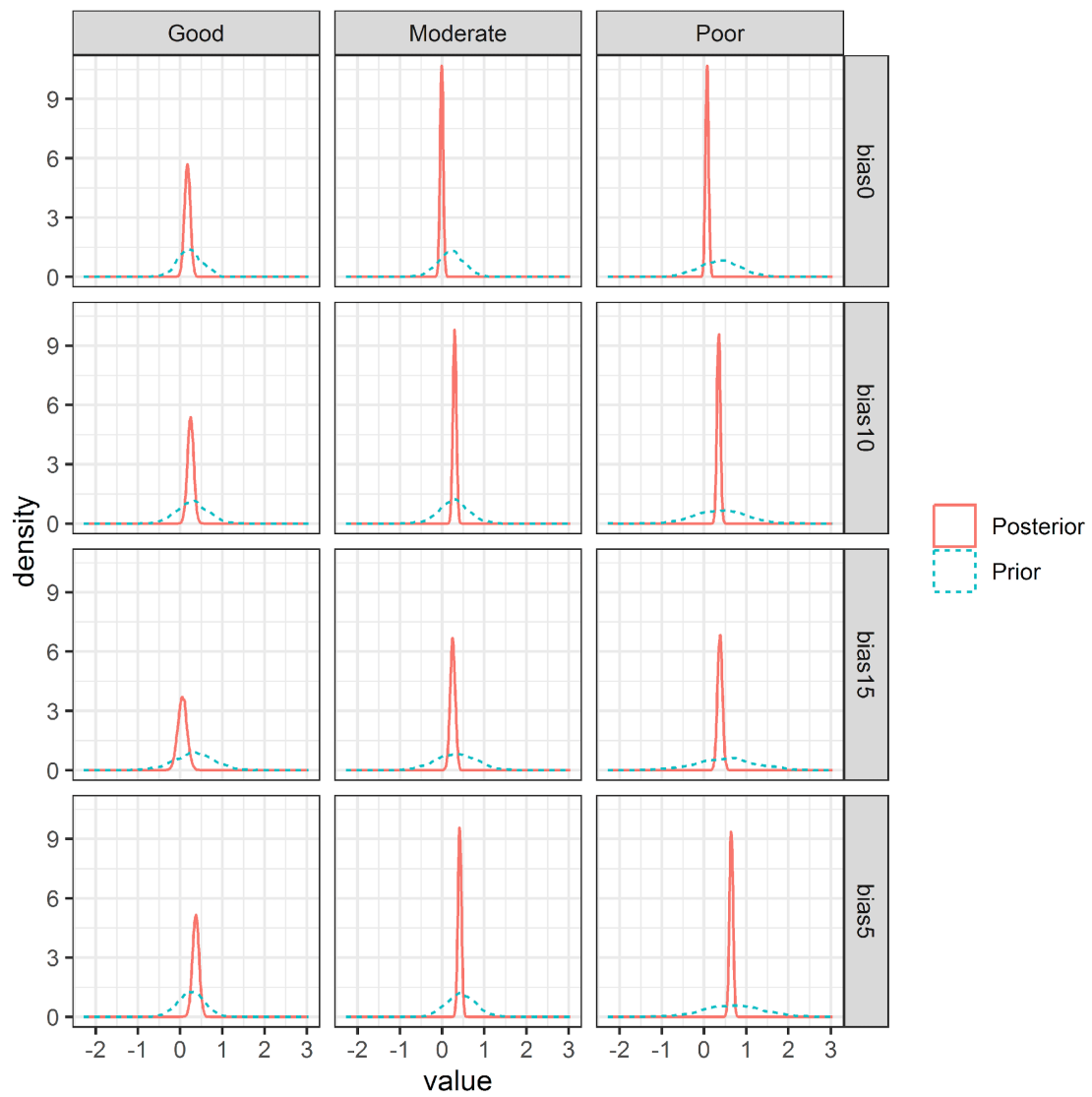

APPENDIX C - POSTERIOR PREDICTIVE CHECKS

We predicted the UN TFR using the main model (UN-consistent) as shown in Figure C1, which shows a comparison between predicted UN TFRs and actual UN TFRs by country and year. These are based on the posterior predictive distribution of the UN TFR data used as input to the model. We observe that the model generally predicts the patterns correctly. Notable exceptions include underestimation for Namibia (1985–1989), Mozambique (1985–1994), and Rwanda (1980–1989), although predictive intervals contain the data points. The model overestimates the UN TFR (again, predictive intervals contain data) for Angola (2005–2014) and Uganda (1995–1999).

FIGURE C1. COMPARISON OF PREDICTED UN TFR AND UN TFR.

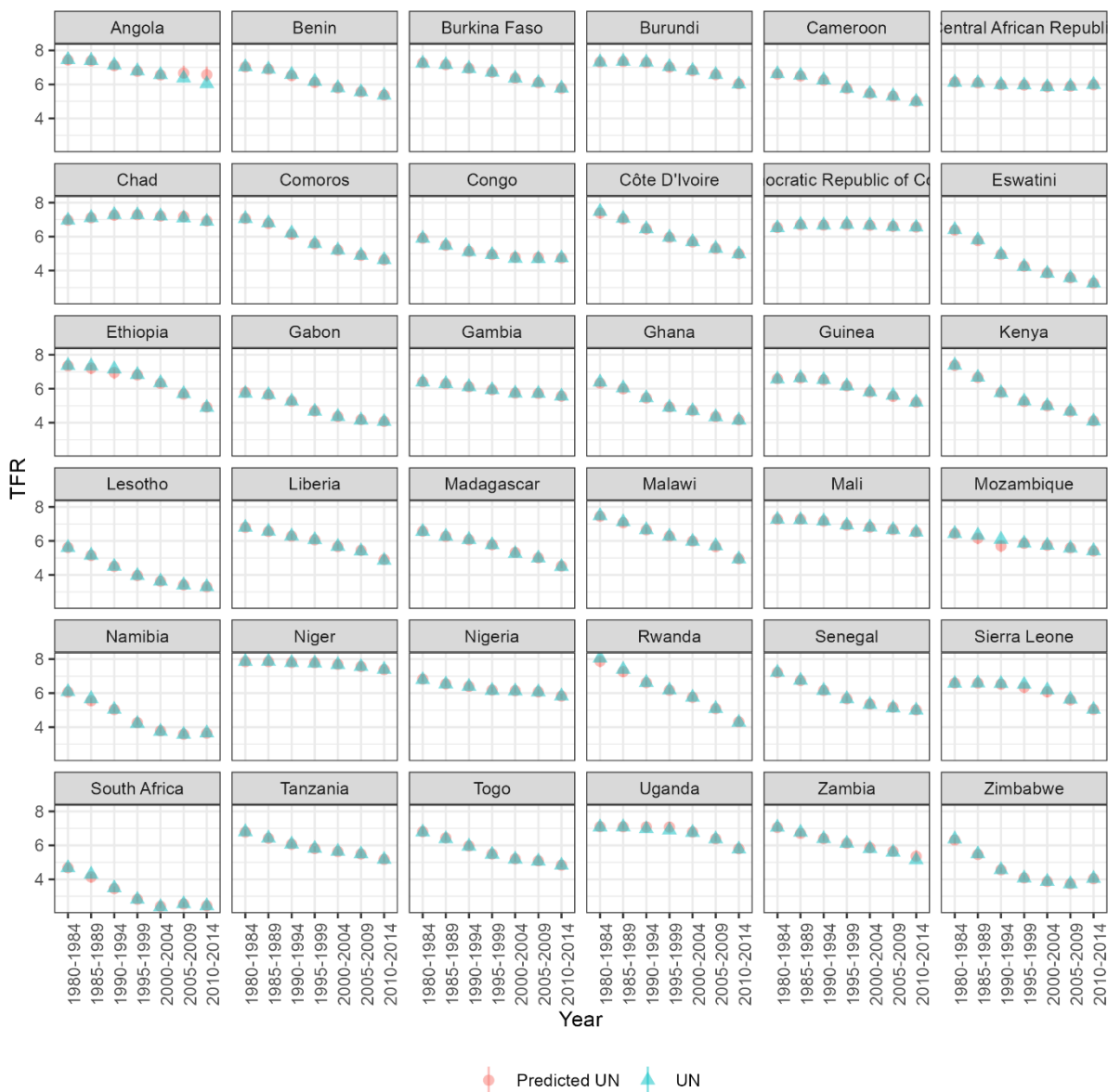

We also estimated ESTFRs by separately removing ESTFR0, ESTFR5, ESTFR10, and ESTFR15 from the inputs and compared the resulting ESTFRs to those from the main model (UN-consistent).

FIGURE C2. COMPARISON OF THE RESULTS OF THE MAIN MODEL (UN-CONSISTENT) WITH PARTIALLY REMOVED DATA ALONG WITH THEIR 80% CONFIDENCE INTERVALS.

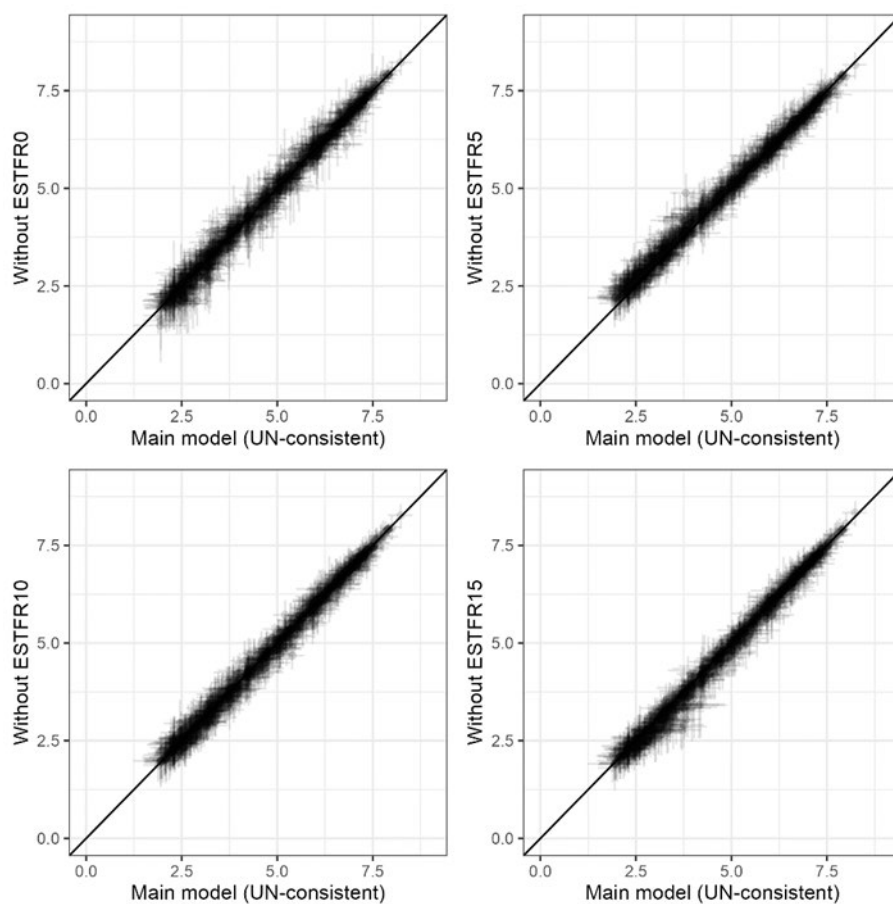

REFERENCES

Schoumaker, B. (2014). Quality and consistency of DHS fertility estimates, 1990 to 2012. ICF International Rockville, Maryland



Wittgenstein Centre

FOR DEMOGRAPHY AND
GLOBAL HUMAN CAPITAL



universität
wien

The Wittgenstein Centre is a collaboration among the Austrian Academy of Sciences (ÖAW), the International Institute for Applied Systems Analysis (IIASA) and the University of Vienna.

www.wittgensteincentre.org