

Milligan, Robert A.; Hutt, Guy K.

**Working Paper**

## A Conceptual and Operational Framework for Teaching Management to Farm Managers

Staff Paper, No. SP 89-27

**Provided in Cooperation with:**

Charles H. Dyson School of Applied Economics and Management, Cornell University

*Suggested Citation:* Milligan, Robert A.; Hutt, Guy K. (1989) : A Conceptual and Operational Framework for Teaching Management to Farm Managers, Staff Paper, No. SP 89-27, Cornell University, Charles H. Dyson School of Applied Economics and Management, Ithaca, NY, <https://doi.org/10.22004/ag.econ.197581>

This Version is available at:

<https://hdl.handle.net/10419/276799>

**Standard-Nutzungsbedingungen:**

Die Dokumente auf EconStor dürfen zu eigenen wissenschaftlichen Zwecken und zum Privatgebrauch gespeichert und kopiert werden.

Sie dürfen die Dokumente nicht für öffentliche oder kommerzielle Zwecke vervielfältigen, öffentlich ausstellen, öffentlich zugänglich machen, vertreiben oder anderweitig nutzen.

Sofern die Verfasser die Dokumente unter Open-Content-Lizenzen (insbesondere CC-Lizenzen) zur Verfügung gestellt haben sollten, gelten abweichend von diesen Nutzungsbedingungen die in der dort genannten Lizenz gewährten Nutzungsrechte.

**Terms of use:**

*Documents in EconStor may be saved and copied for your personal and scholarly purposes.*

*You are not to copy documents for public or commercial purposes, to exhibit the documents publicly, to make them publicly available on the internet, or to distribute or otherwise use the documents in public.*

*If the documents have been made available under an Open Content Licence (especially Creative Commons Licences), you may exercise further usage rights as specified in the indicated licence.*

CORNELL

Staff pap. no. 89-27

GIANNINI FOUNDATION OF  
AGRICULTURAL ECONOMICS  
LIBRARY

JAN 5 1990

CORNELL

AGRICULTURAL ECONOMICS

STAFF PAPER

**A Conceptual and Operational Framework for  
Teaching Management to Farm Managers**

**Robert A. Milligan  
Guy K. Hutt**

**Staff Paper No. 89-27**

**Aug. 1989**

Department of Agricultural Economics  
Cornell University Agricultural Experiment Station  
New York State College of Agriculture and Life Sciences  
A Statutory College of the State University  
Cornell University, Ithaca, New York, 14853

It is the policy of Cornell University actively to support equality of educational and employment opportunity. No person shall be denied admission to any educational program or activity or be denied employment on the basis of any legally prohibited discrimination involving, but not limited to, such factors as race, color, creed, religion, national or ethnic origin, sex, age or handicap. The University is committed to the maintenance of affirmative action programs which will assure the continuation of such equality of opportunity.

## **A CONCEPTUAL AND OPERATIONAL FRAMEWORK FOR TEACHING MANAGEMENT TO FARM MANAGERS**

As extension personnel, we have always said that management is important. Up until now, however, we had not developed a conceptual framework of management and approached management as a teachable subject matter, such as we have for nutrition, soil fertility, and marketing. This paper outlines such a framework, which currently is the backbone of the PRO-DAIRY management program.

Assisting farm managers to improve the management of their farms has been a major thrust of extension work. Extension programs have gone a long way towards enhancing the efficiency of agricultural operations, usually by integrating scientific techniques and improving farm record keeping. The study of what has been called "farm management" began by observing what farmers were doing, and reporting those practices that proved most effective in improving farming. The sciences of agronomy, animal science, etc. developed to enable farmers to use these improved production practices. Record keeping and economic analysis also were developed, to assist in the accounting and managing of farm activities. Management research and education can be seen as a relatively young field of study having only emerged formally with the advent of industrialization.

PRO-DAIRY--a New York State dairy farm management program--has found that farm management can be improved further, through sound business planning, organizing, staffing, resource directing and controlling. In short, The PRO-DAIRY program has taken management techniques discussed in business school literature and applied them to dairy farm management. This paper provides an overview of the study of management, including the development of today's management techniques and their incorporation into the PRO-DAIRY program.

SCHOOLS OF MANAGEMENT

Records show that the desire to understand how to best organize and control trade and activities has been with us as early as ancient Rome when Diocletian implemented changes in the Roman hierarchy in an attempt to manage more effectively. Also, the Roman Catholic Church began compulsory staff service and staff independence to improve the decision-making process of the Church. Despite these early trials with management, the field of management didn't get off the ground until the intense, production-oriented times of the industrial revolution.

The first recognized management school of thought is known as the Quantitative or Scientific Management school and arose in order to find the most scientific, rational principals for handling people, machines, materials, and money. The goal of this school was to increase output and productivity per person by making work easy to perform. Attention to the needs of workers was minimal: Workers were considered only the additions to machines that were necessary to make them run. An engineer, Frederick W. Taylor (1815-1915) is often considered the father of Scientific Management. His major contribution was to define the concept of a task as a specific set of activities that instruct a laborer what to do, how to do it and the time frame in which to accomplish it. Taylor's philosophies about consistently maximizing output led to the development of time and motion studies. Taylor also began scientific decision making processes and cost accounting.

Scientific Quantitative approach

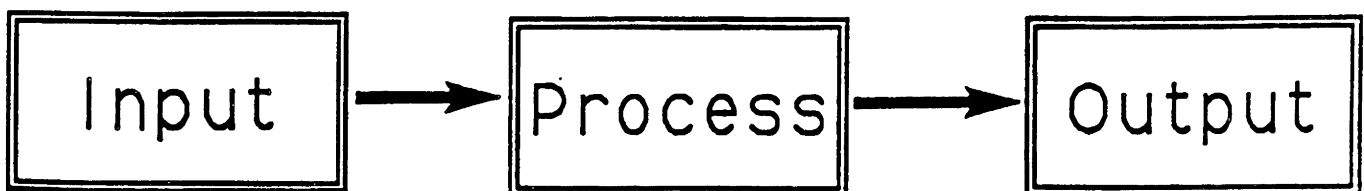

The second major school of management thought is called the process school or classical school and is based on the work of Henri Fayol (1841-1925), who is thought of as the father of modern management theory. Fayol first introduced the administrative operations of planning, organization, command, coordination and control, as diagramed below. Fayol was the first to suggest that management could be taught in a scholastic setting, using a conceptual framework with principals derived from research and experience. Fayol's original fourteen principals of management included such familiar ones as division of work, authority and responsibility, unity of command, subordination of individual interests to the common good, centralization, hierarchy, and esprit de corps.

### Management as interacting functions

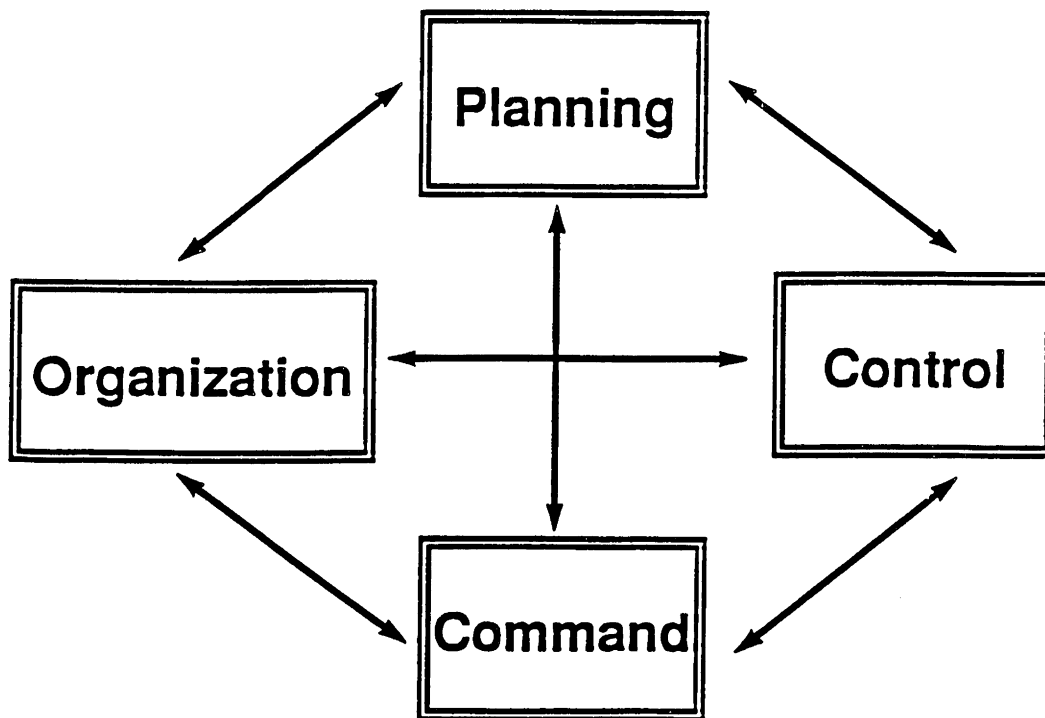

The final, major school of management is the behavioral school, which is commonly divided into two branches: 1) individual behavior or the interpersonal perspective and 2) group behavior or the social system perspective. Contributions to this school have come from the social sciences including psychology, sociology, anthropology, social psychology, and industrial psychology. The behavioral school deals with such topics as motivation, leadership, personality, style, behavior, teams, power and authority. The beginnings of this school can be traced to Elton Mayo (1880-1949), whose work is associated with early inquiries into the behavior of people in the work place. Mayo's Hawthorne studies were landmark studies within the field of management. This research showed that supervisory style effected worker output; workers changed their behavior when they were aware that they were being watched.

With Mayo's observations, the human relations school had begun. The first significant research about human organizations was conducted by Chester I. Barnard (1886-1961), whose work explored the concept that the manager created and maintained an organization's complex communications system. Barnard's thoery is called the acceptance theory of authority and features "zones of indifference" or that range of activities over which an employee readily grants authority.

As the study of management progressed, not only schools of management, but philosophies of management developed. The illustrated philosophical time line below shows that each management philosophy is built upon the ones that have come before it.

# Management Philosophy TIME LINE

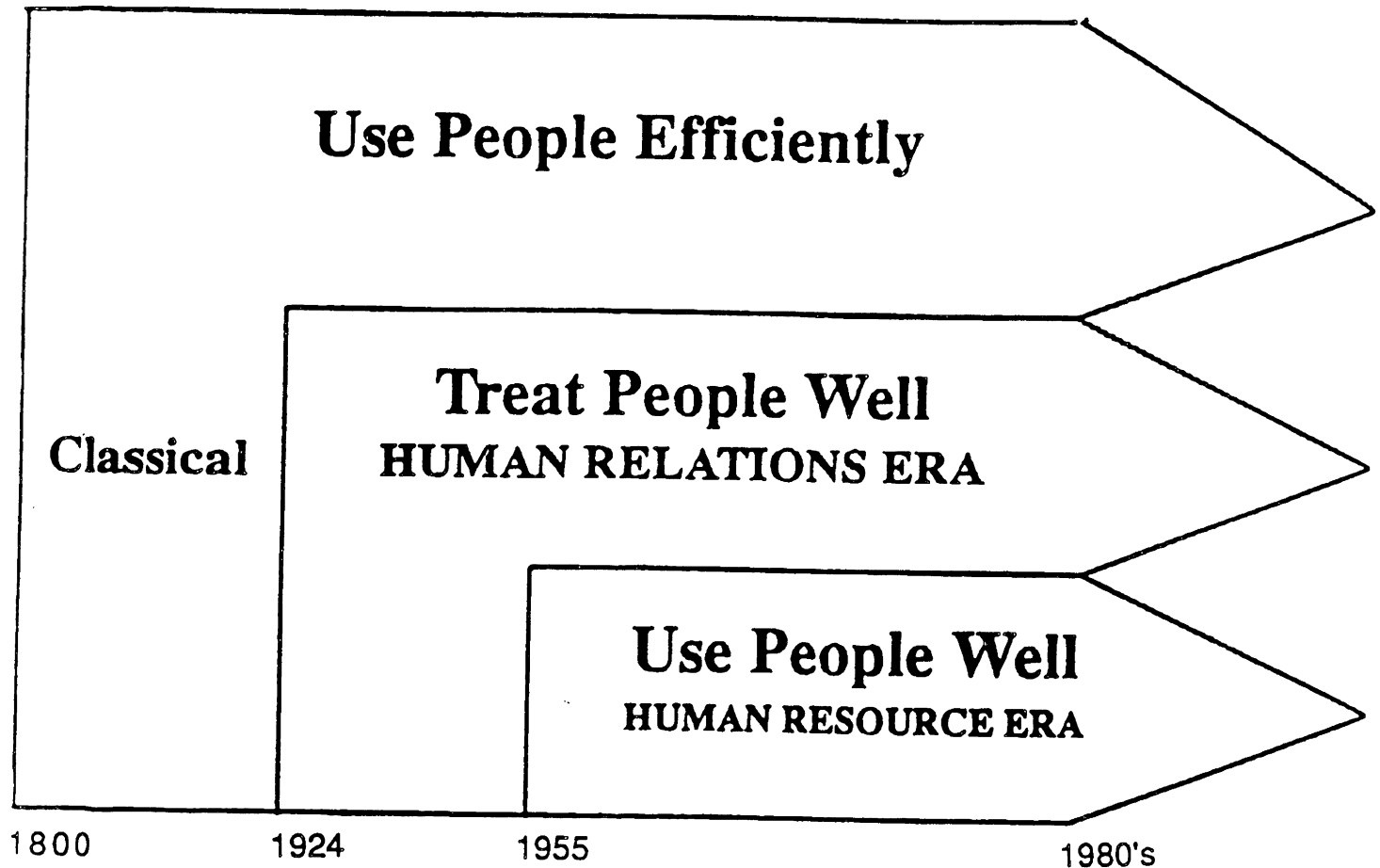

The classical philosophy draws primarily from the quantitative school, considering people merely an input into the productive function. Therefore, it has no managerial conceptual framework. The human relations philosophy recognizes that people are a unique input and emphasizes how people are treated by an organization. The human resource management philosophy asserts that management means the management of people--including oneself--and that management has a conceptual framework that separates management from labor.



The contributions of each of these schools can not be understated; they form the basis of modern management on which the operation of many businesses--including farms--are based. Each of these schools of thought adds to the overall understanding of management and suggests further areas for research and study. Each of the schools also has its short comings.

The quantitative school, with its emphasis on mathematical models and processes such as linear programming and games theory, leans heavily on economic effectiveness criteria and stresses the importance of goals and performance. This approach is criticized for only contributing a group of management tools, rather than a conceptual framework and also for failing to recognize the importance of people in management. This school does not provide enough emphasis on the general management of businesses, instead concentrating on narrow, operational problems.

The process school provides a model for separating and clearly defining functions and activities, a first step to evaluating newly implemented managerial techniques and to developing new principles. In this way, principles such as the primacy of planning and the exception principle can be tested and observed for validation. The process school offered structure to the study of management when management study was new and undefined. Today, the tenets of the process school are criticized for being too rigid to adapt to the unique scenarios of individual businesses.

The behavioral school stresses the observation of behavior on which to base understanding. This school is often criticized for not being scientific or quantitative enough in its approach.

PRO-DAIRY's observations of agricultural management indicate that the classical philosophy of management is the one most prevalent among agricultural businesses today. Most agriculturalists do not hold a conceptual framework for management, as evidenced by a recent PRO-DAIRY concept mapping exercise. Managers participating in the PRO-DAIRY exercise recognized that different technical concepts such as dairy and field crops were related to each other, but did not recognize different management concepts as inter-related. Most importantly, managers rated technical area concepts as more important than those

related. Most importantly, managers rated technical area concepts as more important than those associated with management. The concept map below, from New York Dairy Farm Managers, depicts the results of cluster analysis, showing the close grouping and high priority placed on technical activities (Activities 1-5) and the distance and low priority of management activities (Activities 6). The proximity of the shapes indicates the relationships of the concepts; the number of lines per shape indicates greater or lesser importance.

PRO-DAIRY also has observed that most managers see their employees as having low self-esteem.

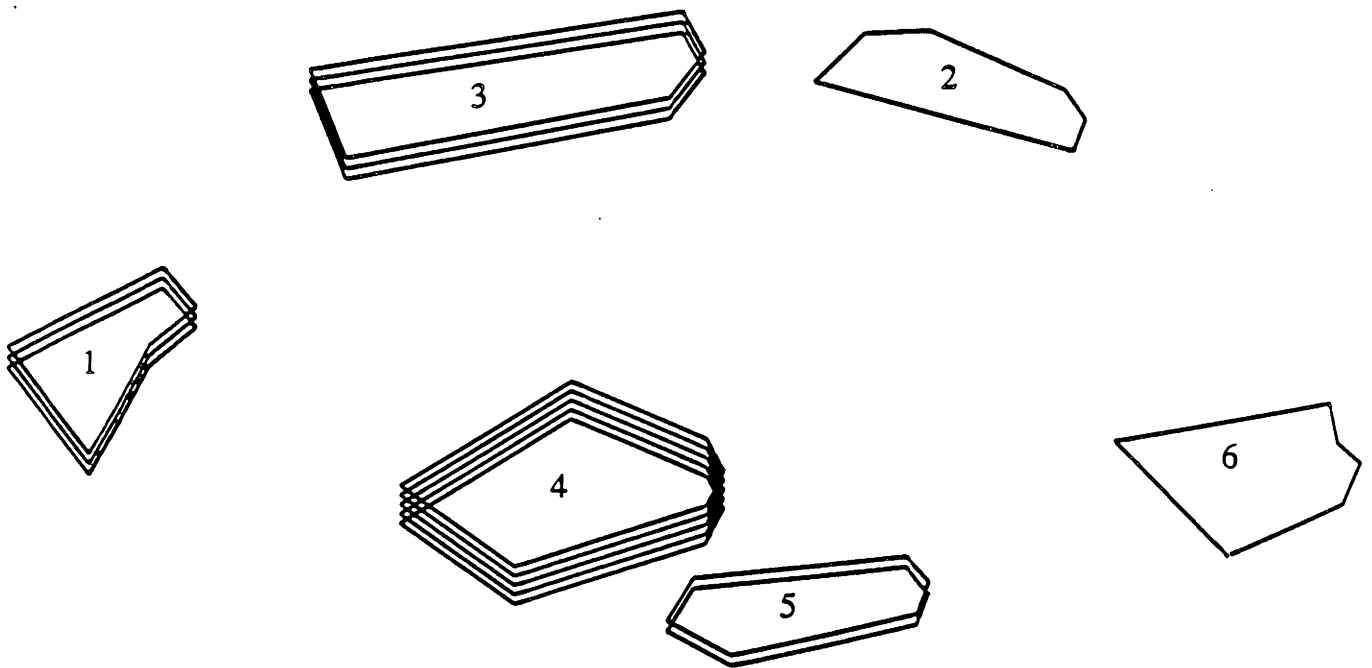

**PRO-DAIRY CONCEPTUAL FRAMEWORK OF MANAGEMENT**

The PRO-DAIRY program combines approaches of all three schools. This unified perspective is not meant to aid research, but rather, it is meant to provide a mental model which can be readily learned and applied to

everyday management situations. Even though each of the different schools is represented by the PRO-DAIRY approach, PRO-DAIRY uses just one set of terminology, to keep concepts clear and eliminate confusion among extension educators and practicing agricultural managers. (Much of the research in management is fractured, making synthesis of theory difficult. One industry will research motivation as it applies to them and another industry will study organization as it applies to their special case.)

PRO-DAIRY defines management as: Determining what must be done and achieving results through the efforts of oneself and other people. Management is planning, organizing, staffing, directing, and controlling the business resources toward the accomplishment of established goals. PRO-DAIRY adopts a human resource management philosophy, arguing that management can be differentiated from the technical and management is essentially the management of people. Both can be illustrated by analyzing why a herd of cows is thin. The usual answers--cows are not receiving enough feed, the feed ration is not balanced or forages are of poor quality--are technical. But if one continues to ask "why," causes relating to poor management will be revealed:

- - No one has devised a feeding plan;
- - No one is monitoring the cows intake;
- - There is no one responsible for feeding;
- - The individual balancing the ration is not capable;
- - No one has told the feeder how often to feed the cows.

Compared to technical causes of agricultural inefficiency, management causes are 1) more amenable to a solution and 2) people oriented. It is crucial to point out that even among small operations where the primary management is of oneself, management is essential.

PRO-DAIRY takes a process school approach to management while also integrating the other schools' contributions into the curriculum. The illustrated Function Wheel on the following page shows PRO-DAIRY's organization.

## FUNCTIONS OF THE FARM MANAGER

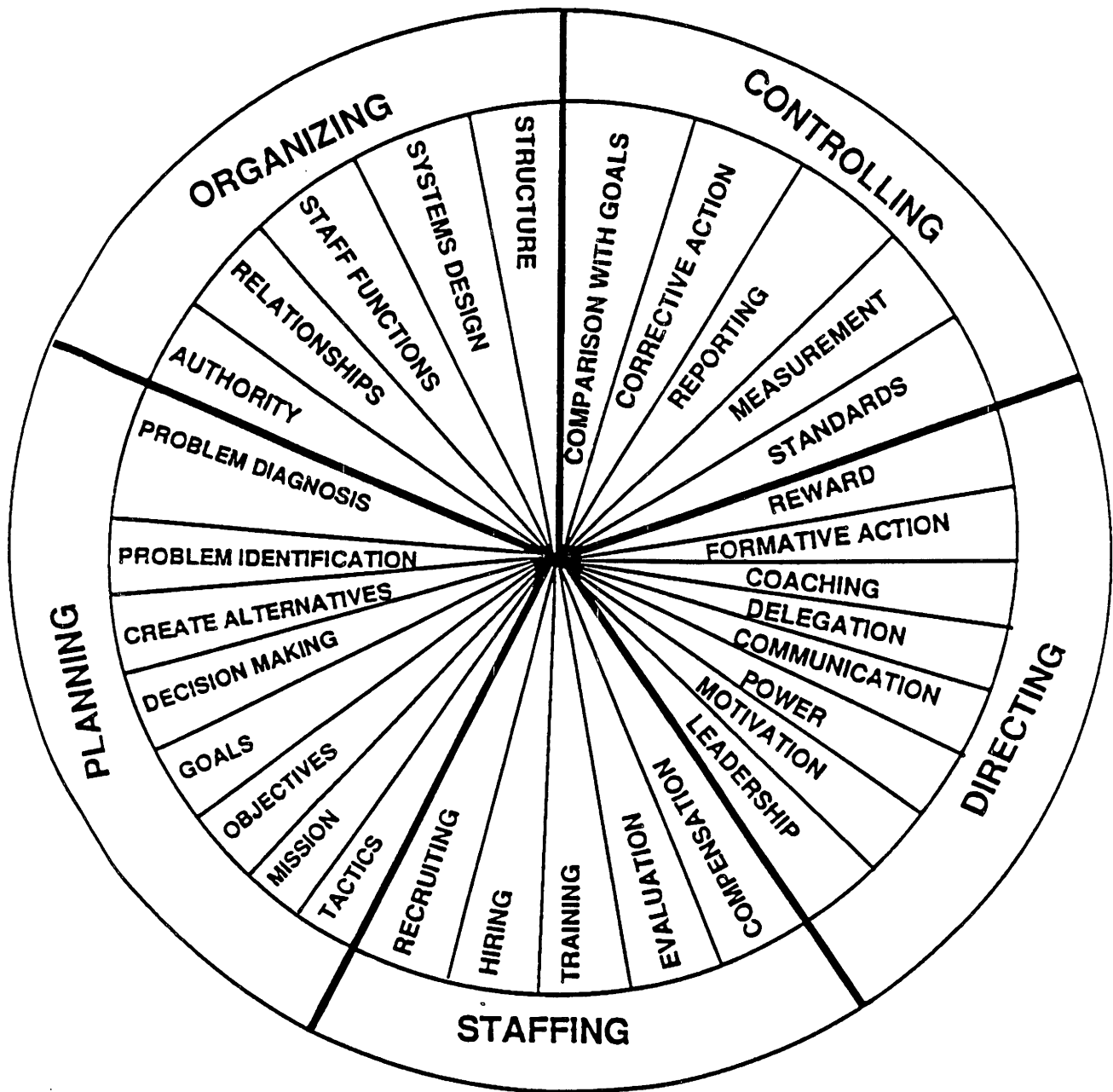

As you can see by looking at the functions and their breakdown into more specific activities, the quantitative and behavioral aspects have been integrated under the basic interactive functions. Like any spoked wheel, eliminating any spoke makes the wheel unbalanced--and hence, dysfunctional. Note that the management answers in the thin cow example above correspond to planning, controlling, organizing, staffing, and directing.

Another way of depicting the functions of management is illustrated on the page below. Here, management is conceptualized as applying to different operational areas.

# IMPORTANT ACTIVITIES and Functions of Management

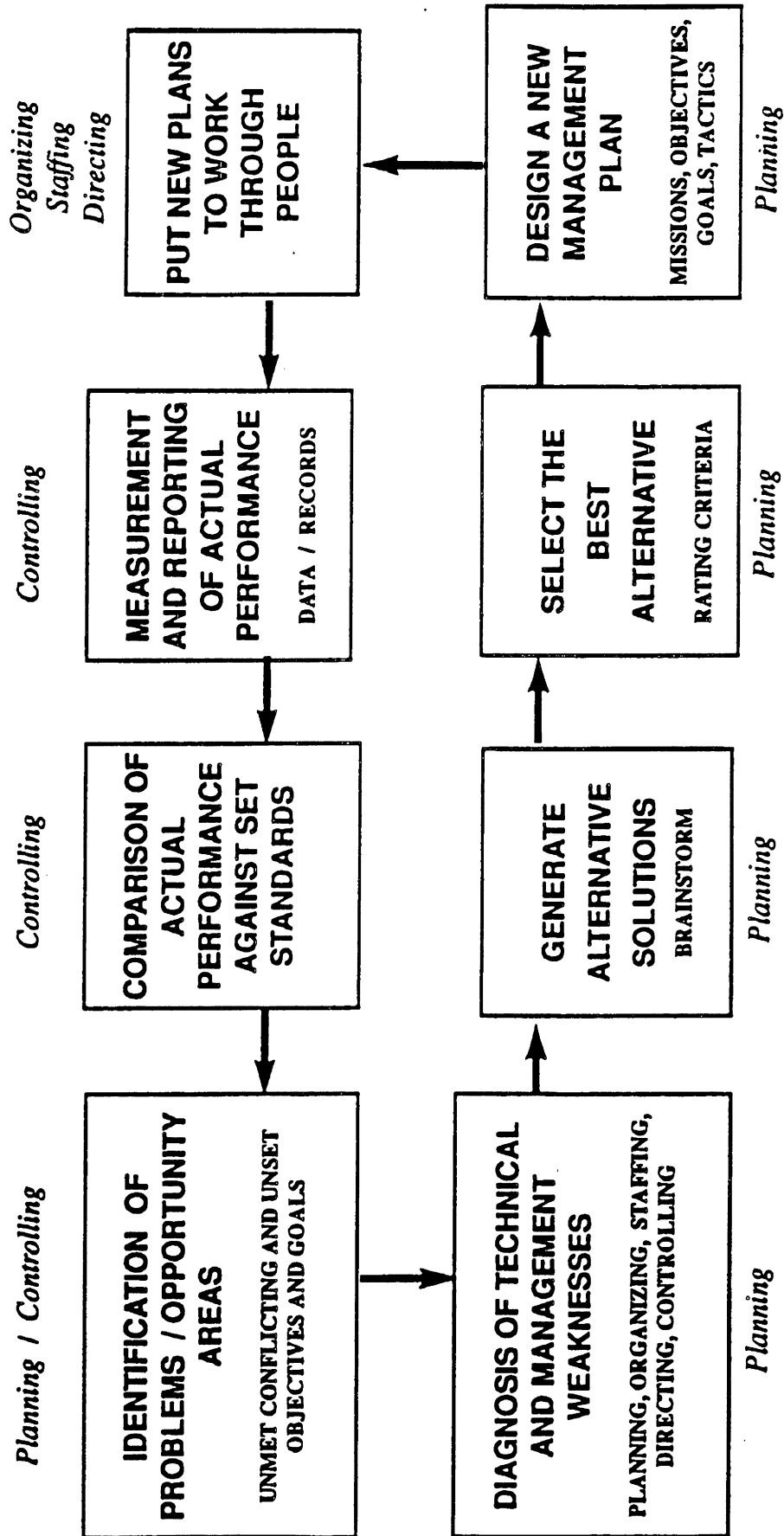

An agricultural enterprise may have several technical components under operational management such as crops, dairy, and equipment. The overall planning and organization of the operation and the integration of the different operational areas is considered to be a general management activity. The diagram on the following page displays each of these concepts. General management overlaps operational management which overlaps technical activities.

Operations management functions themselves can be "put under management" by effectively managing management. "Put under management" refers to the application of management concepts, skills, and tools to any operational area. If the feeding of dairy cows is "put under management," management functions are applied to that technical operation.

Solving a problem at an operational or general level of management improves the overall business and decreases the likelihood that a related technical problem, such as "thin cows," will arise again.

**General Management**  
activities

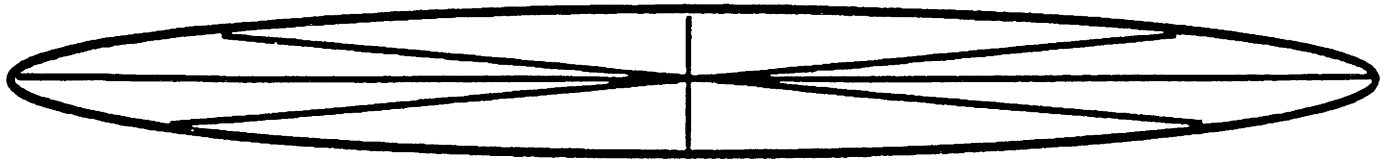

**Operational Management**  
activities

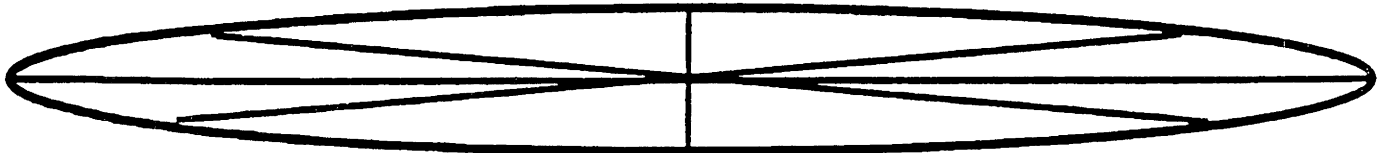

**Technical**  
activities

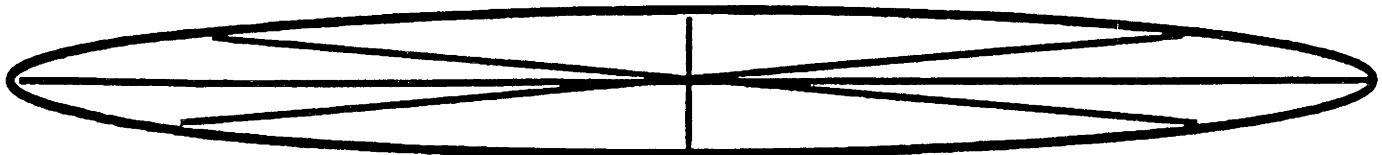



PRO-DAIRY also uses a systems approach, to help distinguish between business and family. This approach advocates dealing with farm business issues from a rational management perspective.<sup>1</sup>

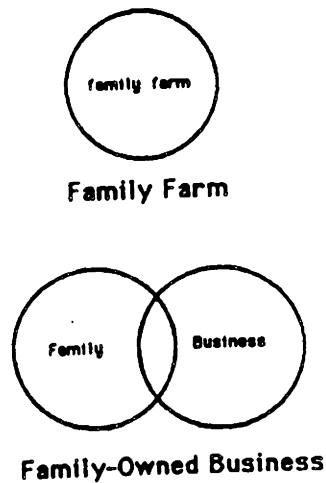

### STRUCTURE OF PRO-DAIRY CURRICULA

Our hypothesis is that greater farm manager understanding of management concepts and skills will increase the enthusiasm for management and raise the level of management performance in agriculture. Management is not understood because it has not been taught as a subject unto itself, distinct from technical areas of production. We are teaching management from the perspective that not only do we want to inspire changes in the behavior of managers, we also want them to try out new attitudes, mental models and values that can aid the management of their businesses. It is our intent that farm managers be able to adapt the problem solving models and managerial skills gained from a PRO-DAIRY workshop to a variety of situations.

---

<sup>1</sup>Managing the Family-owned Business Hutt and Hutt 1989; Agricultural News Service Cornell Cooperative Extension #3 7/89.

Because our subject matter is unique compared to past extension outreach--designed to inspire farm managers to transform their basic attitudes, values and thought processes--the type of educational methods we are using differ from some of the techniques extension has employed in the past. For example, PRO-DAIRY takes a curricular approach to education. Each curriculum is comprised of a series of workshops, designed to expose participants to concepts and tools to promote the learning and adopting of mental models and skills essential to sound farm management. As can be seen below, PRO-DAIRY's Managing for Success curriculum consists of seven workshops: Managing for Success, Management Clinic and a series of Focus Workshops, each dealing with specific areas of management. The leaders and participants of each workshop are supplied with curricular materials.

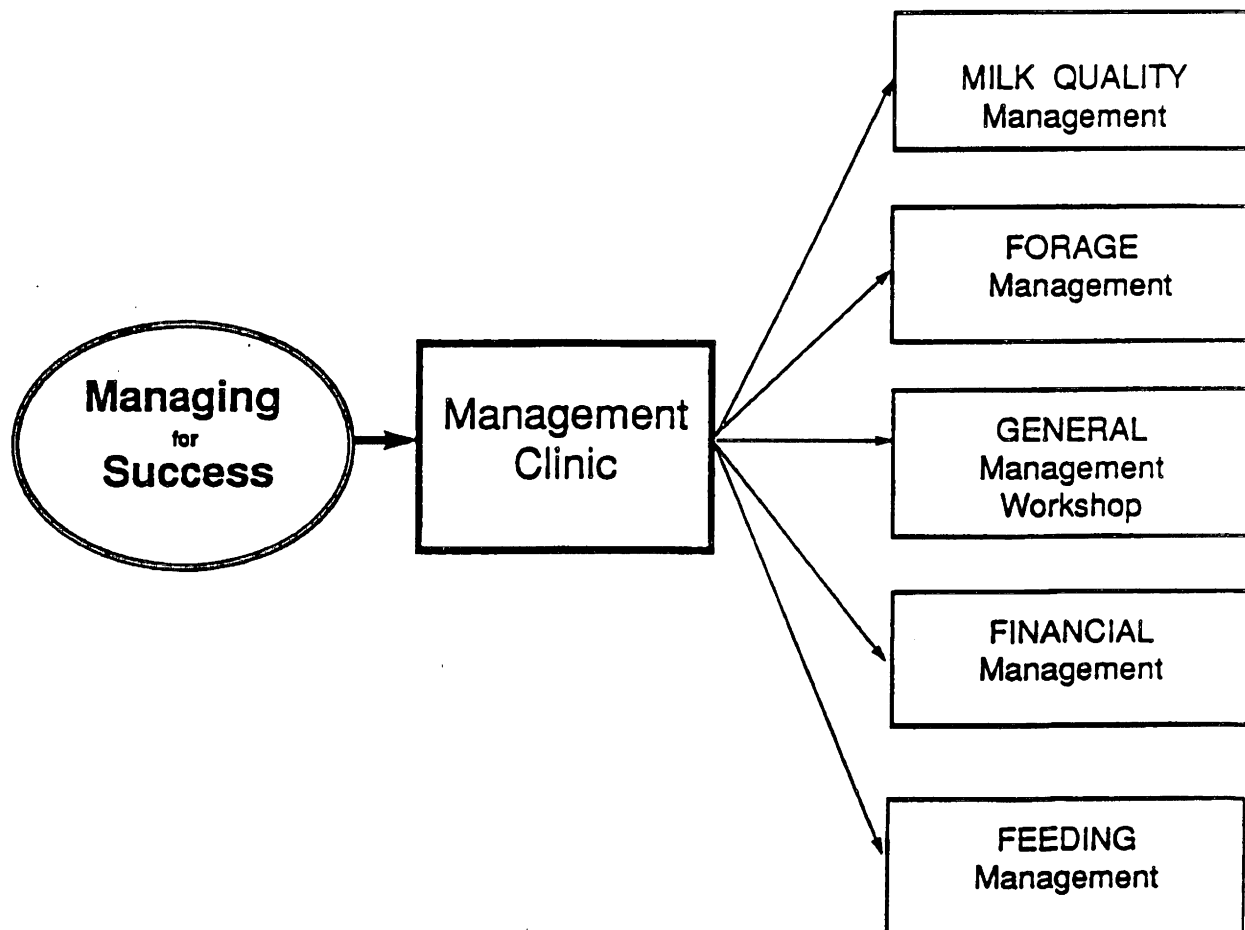

INTERACTIVE TEACHING METHODS<sup>2</sup>

Each PRO-DAIRY workshop has been structured to foster interaction among learners and workshop facilitators. The more involved the learner is in the learning experience, the greater his or her retention of the material. The learning of management skills must result in a personal, internal change to be effective and lasting. The chart on the next page illustrates the relationship among learner involvement, locus of meaning and the learner. Various teaching methods are presented at the bottom of the chart, ranging from on the left, those that incorporate low involvement and on the right, high involvement.

Note that the mini-lecture is more involving than the traditional lecture. This is because the mini-lecture incorporates activities on the part of the "audience." Interspersed throughout the course content are brief interactions among participants, designed either to personalize the points of the lecture and/or to generate readiness for the next topic.

---

<sup>2</sup>Based in part on Hall, J., *The Awareness Model: A Rational of learning and its application to individual and organizational practices*, Conroe, TX: Teleometrics, 1971; and Tannenbaum, R., & Schmidt, W.H., "How to choose a Leadership Pattern," *Harvard Business Review*, May-June 1973, pp. 162-164, 166-168.

### Workshop Stresses High Involvement

Low Involvement ..... High Involvement

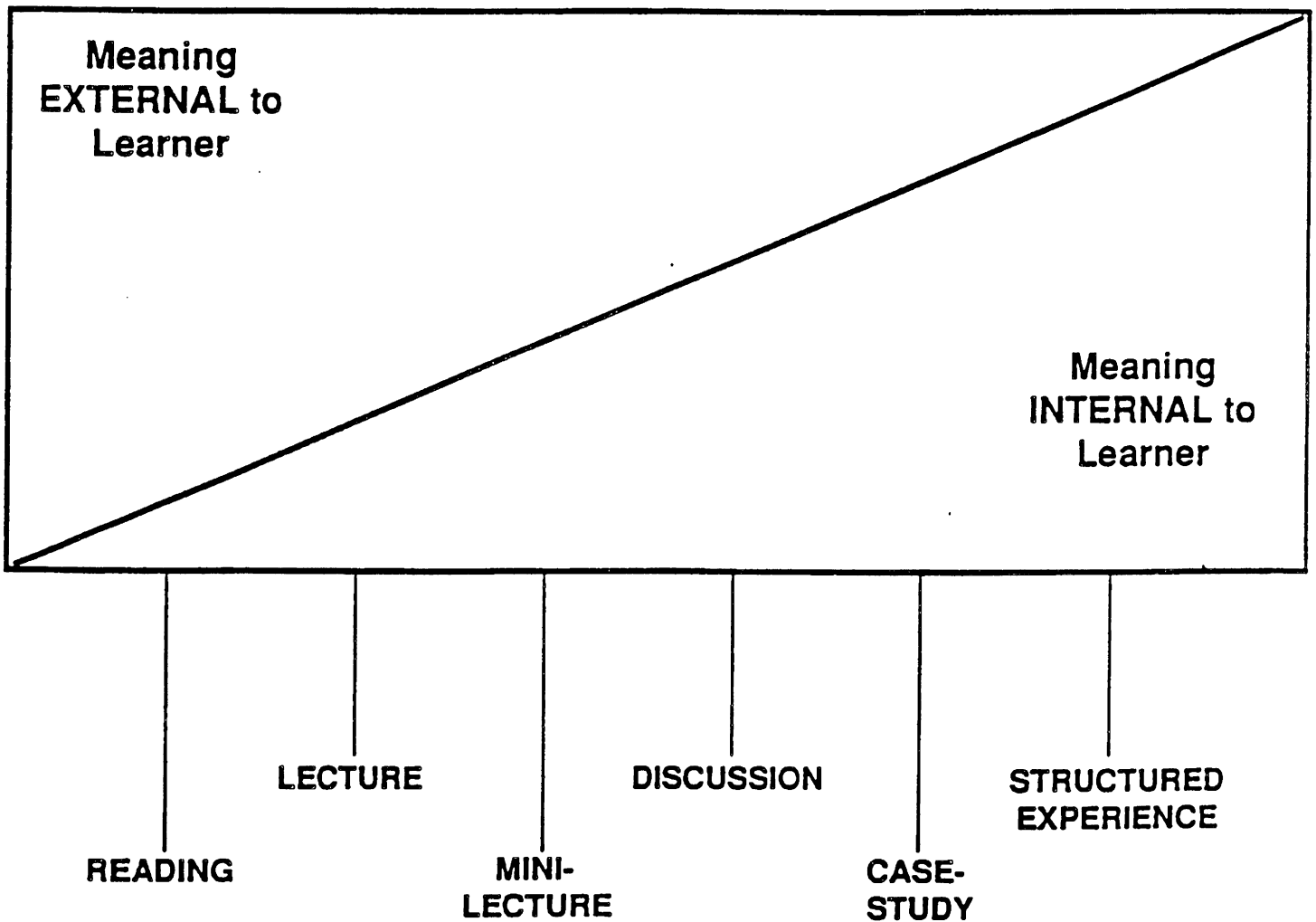

Each teaching method is useful for a different purpose and appropriate for certain situations. The challenging task of choosing which method to use given the course content and the orientation of learners is the responsibility of the workshop facilitators. The elements facilitators consider when planning their workshops is represented graphically below. In PRO-DAIRY workshops, a variety of teaching methods are used to effect the type of change necessary to improve management practices.

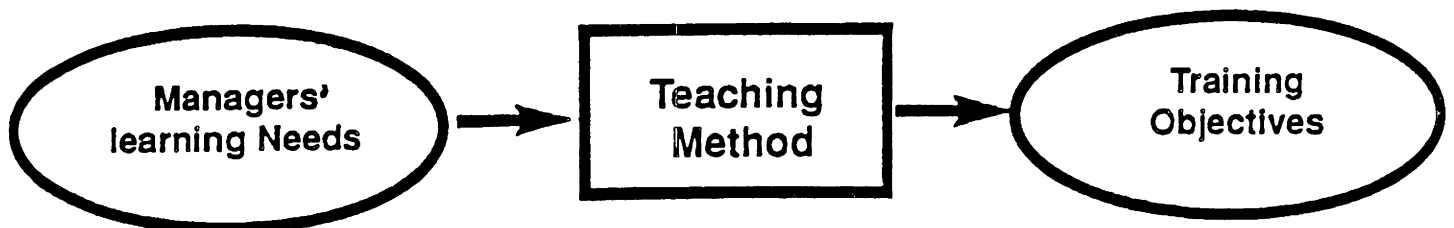

**INVOLVEMENT OF AGRISERVICE**

The involvement of agriservice businesses and professionals in the PRO-DAIRY program has proved to be a useful method of reinforcing management concepts, in addition to adding credibility in the eyes of the production agriculture manager. The statewide nature of the program has strengthened its continuity and allowed for the centralization of appropriate activities, while still leveraging the input of statewide extension program staff on curriculum development and for the actual creative delivery of the curriculum to the management audience. The regional staffing pattern for the program's core staff has proved effective in the management of the program.

PRO-DAIRY's innovative curricula and delivery methods have proved highly effective in improving the management of agricultural businesses, and hence, their profitability and productivity. This, in turn, improves the quality of life for the manager, the managed, and those who benefit from the production of agricultural products.

Other Agricultural Economics Staff Papers

No. 89-15	Survey of Firms/Agencies Employing Cornell Graduates With Bachelors Degrees in Applied Economics and Business Management	W. Knoblauch G. German
No. 89-16	Geographic Price Relationships in the U.S. Fluid Milk Industry. A Mathematical Programming Analysis	J. Pratt M. Keniston A. Novakovic
No. 89-17	An Analysis of Changes in Milk Production Per Cow by State, 1950-87	A. Weersink L. Tauer
No. 89-18	Testimony on Draft Underwriting and Repayment Standards for the Federal Agricultural Mortgage Corporation	E. LaDue
No. 89-19	Water Allocation Under a Riparian System Taking into Account Surface and Groundwater Interactions -- The Case of Irrigation Development in the Headwaters of the Susquehanna River	T. Steenhuis D. Allee
No. 89-20	Plant Location and Monopsonistic Pricing: The Milk Industry in the Northeast	J. Pratt
No. 89-21	Biotechnology: The Impact on Farm Firms and Regional Competitive Positions	R. Milligan
No. 89-22	The Distributional Impacts of Technical Change on the U.S. Dairy Sector	A. Weersink L. Tauer
No. 89-23	Input Aggregation and Firm Efficiency	A. Thomas L. Tauer
No. 89-24	Natural Resources, Structural Adjustment, and Sustainable Growth in Sub-Saharan Africa: A Critique of Policy Recommendations	A. Cunha S. Kyle
No. 89-25	Structural Adjustment, and Natural Resources: An Overview of the Issues	S. Kyle
No. 89-26	Economic Dimensions of CO <sub>2</sub> Treaty Proposals	D. Chapman T. Drennen