

Brambila, Jose; Albra, Pedro; Spathis, Paul; Vellutini, Roberto

**Working Paper**

## Stochastic Simulation of Buffer-Stock Stabilization Policies in the World Cocoa Market

Staff Paper, No. SP 82-27

**Provided in Cooperation with:**

Charles H. Dyson School of Applied Economics and Management, Cornell University

*Suggested Citation:* Brambila, Jose; Albra, Pedro; Spathis, Paul; Vellutini, Roberto (1982) : Stochastic Simulation of Buffer-Stock Stabilization Policies in the World Cocoa Market, Staff Paper, No. SP 82-27, Cornell University, Charles H. Dyson School of Applied Economics and Management, Ithaca, NY, <https://doi.org/10.22004/ag.econ.183964>

This Version is available at:

<https://hdl.handle.net/10419/276643>

**Standard-Nutzungsbedingungen:**

Die Dokumente auf EconStor dürfen zu eigenen wissenschaftlichen Zwecken und zum Privatgebrauch gespeichert und kopiert werden.

Sie dürfen die Dokumente nicht für öffentliche oder kommerzielle Zwecke vervielfältigen, öffentlich ausstellen, öffentlich zugänglich machen, vertreiben oder anderweitig nutzen.

Sofern die Verfasser die Dokumente unter Open-Content-Lizenzen (insbesondere CC-Lizenzen) zur Verfügung gestellt haben sollten, gelten abweichend von diesen Nutzungsbedingungen die in der dort genannten Lizenz gewährten Nutzungsrechte.

**Terms of use:**

*Documents in EconStor may be saved and copied for your personal and scholarly purposes.*

*You are not to copy documents for public or commercial purposes, to exhibit the documents publicly, to make them publicly available on the internet, or to distribute or otherwise use the documents in public.*

*If the documents have been made available under an Open Content Licence (especially Creative Commons Licences), you may exercise further usage rights as specified in the indicated licence.*

STOCHASTIC SIMULATION OF BUFFER-STOCK STABILIZATION  
POLICIES IN THE WORLD COCOA MARKET

Pedro Alba  
Jose Brambila  
Paul Spathis  
Roberto Vellutini

August 1982

No. 82-27

## FOREWORD

This paper is a revised version of the simulation project realized jointly by the authors for the purpose of fulfilling the requirements of the course Quantitative Methods II in the Department of Agricultural Economics (Ag Ec 713).

The purpose of the study is to apply stochastic simulation techniques and show their usefulness for policy analysis. The specific case chosen is the issues associated with commodity price stabilization programs. More specifically, the trade-offs involved in managing a buffer-stock stabilization scheme are analyzed through an econometric model of the world cocoa market.

During all stages of this study we benefited from Professor Robert Milligan's advice, who also encouraged us to pursue its publication as a Staff Paper. His suggestions are greatly appreciated. Of course, all remaining errors are our own responsibility.

## I. FORMULATION OF THE PROBLEM

Agricultural commodities are important for many LDC's; 50 percent or more of the exports of many of these countries are concentrated in one or two commodities. When these commodities have unstable prices, significant policy issues arise. A decrease in export revenues from this source can impose an important foreign exchange restriction on the country concerned, maybe causing a delay in its development process. Moreover, unstable commodity prices and consequently unstable export earnings preclude medium or long term development planning. Thus, it is important for these countries to secure prices that are stable and remunerative.

Cocoa is an important agricultural commodity with a highly unstable price. Ghana, Ivory Coast, Cameroon, and to a lesser extent Brazil and Nigeria, depend on the revenues generated by cocoa exports. Exports of this commodity account for over 60 percent of all foreign exchange earnings of Ghana and approximately 20 to 25 percent of those of Cameroon and the Ivory Coast (Okorie and Blandford). Cocoa prices have been subject to considerable instability; the world unit price has fluctuated annually 14.6 percent around trend from 1950-1976 (Okorie and Blandford).

Because of the above, cocoa has been included in UNCTAD's Integrated Commodity Program as one of the commodities whose price is going to be stabilized through jointly financed buffer stocks. Following Robinson (Chapter XX, p. 1): "A buffer stock is an international storage program designed to keep prices within an agreed range by creating an agency to buy the commodity at a stated minimum price, and to sell from stocks at a maximum price.". Cocoa meets two important requirements for price stabilization through a buffer stock. First, it is more or less a homogenous product; cocoa from the five major exporters is comparable in quality and

flavor. Second, it can be stored without major problems. This suggestion from UNCTAD raises the old problems of who benefits from a price stabilization program and under what conditions price stabilization assures stable export revenues.

Turnovsky has provided the answer to these questions under assumptions of linear demand and supply schedules, additive disturbances (i.e., random parallel shifts in these functions) and market transparency (i.e., full market information is available to both consumers and producers). Under these assumptions, whether producers (exporters) or consumers (importers) benefit from price stabilization depends upon the source of the disturbances. If price instability is due to random shifts in the supply function, then price stabilization will be to the benefit of producers (exporters). On the other hand, if price instability is due to stochastic demand, consumers (importers) benefit from price stabilization. Under these same assumptions, stable prices will insure stable revenues if the source of instability is random shifts in supply and if demand is at least as elastic as supply.

The characteristics of the world cocoa market are such that a price stabilization scheme based upon a buffer stock will be to the benefit of exporting countries. The instability in world cocoa prices is due mainly to random shifts in supply because of changing annual world weather. A buffer stock will also stabilize export revenues as it has been found that the long-run aggregate price elasticities of demand (of the developed countries, the main importers) and supply are 0.28 and 0.13 respectively (Lee).

The above discussion on the consequences of price stabilization for economic welfare has imbedded the assumptions that the cocoa price will be stabilized at the average long-run equilibrium price. But, some policy

makers propose to use buffer stocks as an income redistribution mechanism from consumers to producers by stabilizing prices at a level higher than the long-run trend. Buffer stocks can also be used to redistribute income from producers to consumers, by choosing as a target price a price below the long-run equilibrium trend. But, in the first case stocks would accumulate and almost assuredly reach intolerable levels; in the second case stocks will be depleted in a short time until the target price is brought in line with the equilibrium price. Thus, an important policy variable to be manipulated by the buffer stock authorities is the target price.

The purpose of this study is to evaluate alternative buffer stock policies on the basis of total cocoa purchases or sales which are likely to be required over a certain time period. The policies to be compared are all related to the level and type of target prices chosen by authorities. Basically, there are two types of target prices: a fixed one, that runs above the long-run trend, and a three year moving average. For each type of target price two policies are constructed. In one, buffer stock authorities intervene in the market so that the target price is achieved exactly; in the other, actual annual prices are allowed to vary within a certain range or band of the target price. Authorities will only place or withdraw cocoa from the market if the actual cocoa price is outside this band. These policies will then be compared on the basis of the level and degree of price stabilization achieved as well as on the basis of total net purchases required.

Finally, a second objective of this research is to analyze the implications for the alternative policies of changes in exogenous variables. Those chosen for analysis are weather (a stochastic variable) and income growth rates for the importers.

## II. THE MATHEMATICAL MODEL AND METHODOLOGY

### 1. Structure of the Model

The cocoa model is an econometric model consisting of five behavioral equations and one identity.<sup>1</sup> There is one supply equation, three demand equations, one stock equation, and one market-clearing identity.

Because of its "independence" from others, the supply equation was estimated by OLS whereas two-stage least squares was used to estimate the demand and stock equations. The full model and its estimated coefficients are described below.

$$QC_t = 567.87 + 1.286 PC_{t-3} + 39.198 T_t + 347.517 D_1 + 158.94 D_2$$

(6.92)      (3.52)      (12.7)      (5.6)      (3.89)

$$R^2 = 0.95 \quad DW = 1.91$$

$$SKC_t = -2.192 PC_t + 0.471 SKC_{t-1} + 492.1$$

(-4.3)      (3.9)      (4.5)

$$DCA_t = 1.27 YA_t - 0.742 PC_t + 0.604 DCA_{t-1} + 269.1$$

(1.9)      (-3.7)      (4.5)      (4.1)

$$DCL_t = 0.089 YL_t - 0.208 PC_t + 0.97 DCL_{t-1} + 42.6$$

(0.1)      (-2.3)      (2.1)      (2.9)

$$DCC_t = 0.369 YC_t - 0.21 PC_t + 0.779 DCC_{t-1} + 18.0$$

(1.4)      (-2.7)      (1.5)      (0.4)

where:

$YA_t$  = Real income index, advanced countries

$YL_t$  = real income index, less developed countries

$YC_t$  = real income index, centralized countries

$QC_t$  = cocoa world production, thousand long tons

---

<sup>1</sup>This model is presented in Lee (1980).

$SKC_t$  = world cocoa stocks (private) at year-end

$PC_t$  = cocoa price index deflated by the OECD price deflator  
(1963=100)

$DCA_t$  = cocoa consumption, advanced countries

$DCL_t$  = cocoa consumption, less developed countries

$DCC_t$  = cocoa consumption, centralized countries

$T_t$  = trend (time) variable

$D_1$  = dummy variable for exceptionally good weather, 1965

$D_2$  = dummy variable for exceptionally good weather, 1970-72

Endogenous variables:  $PC_t$ ,  $QC_t$ ,  $SKC_t$ ,  $DCA_t$ ,  $DCL_t$ ,  $DCC_t$

Exogenous variables:  $YA_t$ ,  $YL_t$ ,  $YC_t$ ,  $D_1$ ,  $D_2$ ,  $T_t$

The nine year lag for cocoa prices in the supply equation is based on the number of years necessary for fruit production in the cocoa tree. The two dummy variables represent exceptionally good weather for cocoa production in years 1965 and 1970-72, respectively. The estimation period is 1956-76.

## 2. Methodology

Four major factors suggest a simulation approach to our study (Naylor, 1971). First, it involves the use of random numbers (to account for weather variations). Second, given the characteristics of the model an analytical solution would be too complex or even impossible given the lack of an objective function. Third, it is among the objectives of our study to use policy experiments with the model and real life experiments would be unfeasible. Finally, there was enough data available to perform a simulation of the model over the 20 year period of interest.

### a. Stochastic Component

The only stochastic variable in the model is weather, which



influences supply. The basic assumption is that weather is the only omitted variable in the supply equation, and that its influence determines entirely the residual or error of the estimated supply. In other words, if weather had taken its expected value over all the estimation period, the supply equation as estimated would predict perfectly. This permitted us to assume that weather was a stochastic variable with a Gaussian distribution with mean zero and standard error equal to the standard deviation of the residual, 53.48. The variation explained by the two dummy variables was not summed to the residual when estimating this standard error. These years of extremely good weather captured by the dummy variables were considered to be abnormal; and should not be included when estimating the normal weather pattern as they would bias the result. A Chi-square test was performed to test our choice of probability distribution. The selected probability distribution was only acceptable at the 25 percent significance level.

To generate our weather variable for simulation, random numbers from a Standard Normal were drawn from a library function available on TROLL. These were transformed into observations from a  $N(0, 53.48)$  by the following equation:

$$W = 53.48 Z$$

where:  $W \sim N(0, 53.48)$  and  $Z \sim N(0,1)$ .

These parameters were then used in the generation of five random number streams used in the simulation replicates. These replicates amounted to five for each policy under different income assumptions. That is, for each design point, five replicates ( $W_i, i = 1,2,\dots,5$ ) were performed. The average value of the five replicates was then used in the subsequent analysis.

b. Income Assumptions

By affecting directly cocoa consumption through demand equations, income will have an important effect on the resulting (endogenously determined) price. Hence, different hypothesis regarding the growth rate of income in the simulation period would have different impacts on the resulting price and thus on buffer stock levels.

Three rates of growth were assumed for income for the 20 year simulation period (1977-96): high, medium, and low. The hypothesis of medium income growth reflects approximately the historical average growth rate of four subperiods: 1956-66, 1960-73, 1966-76, and 1970-76. High and low growth rates were set at one percent above and below the medium rate, respectively. This amounts to the following growth rates for income:

Table II.1 INCOME GROWTH RATES

Country	Growth Rates (%)		
	High	Medium	Low
Advanced	3.0	2.0	1.0
Less-developed	4.0	3.0	2.0
Centralized	5.5	4.5	3.5

Note that in the simulations, no interaction among the countries' different rates of growth under each hypothesis were allowed. For instance, "high" income hypothesis means running the model using 3.0, 4.0, and 5.5 percent as annual rates of growth for advanced, less-developed, and centralized countries, respectively.

c. Target Prices

Two different hypothesis for the target-price were used. The first (fixed target-price) assumes as target price the endogenously determined price obtained when the model is run in a deterministic mode.

This is accomplished by removing the randomness embodied in the quantity supplied and in the income variables of demand equations. This implies regressing quantity and incomes on the trend available and then using quantity and incomes "predicted" by trend instead of actual values. Theoretically, this procedure removes random fluctuations in both supply and demand. The target prices obtained through this methodology were then extrapolated for the simulation period (1977-96).

The second procedure used for calculating target prices is a three year moving average of endogenously determined prices under the three different income assumptions. That is, the model is run with the three income assumptions and a three year moving average is calculated for each of the three resulting prices. Figures II.1, II.2, and II.3 are a plot of the fixed target price, simulated (endogenously determined) price and three year moving average (target) price under the three different income assumptions.

Note that a three year moving average target price takes into account the overall trend followed by cocoa prices in the simulation period, whereas the fixed target price implies a more rigid price behaviour which is reflected directly on the buffer stock level. The plot of fixed target price and three year moving average target prices under different income assumptions is presented in Figure II.4.

Figure II.1.: Simulated and Target Prices for Cocoa - High Income Hypothesis

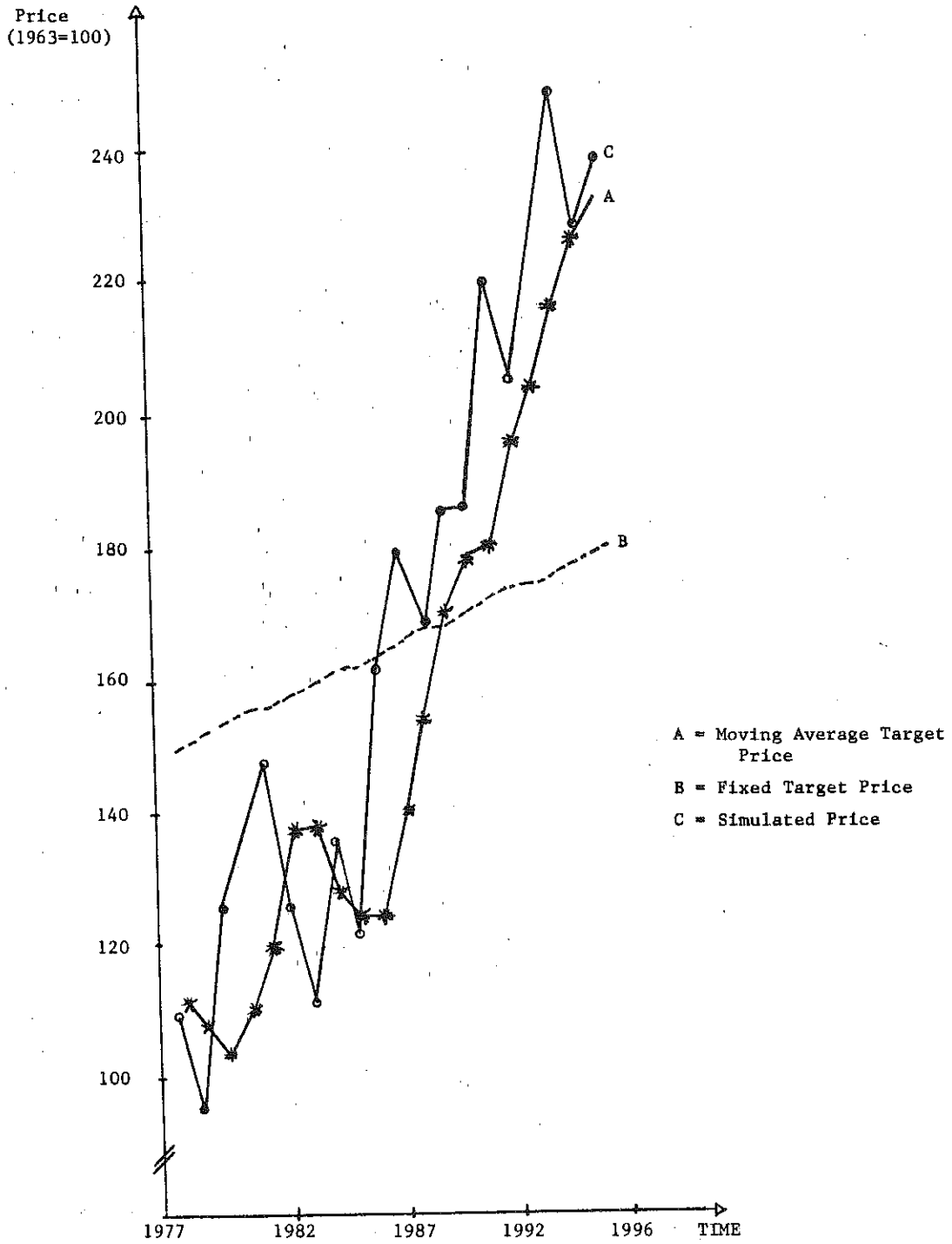

Figure II.2.: Simulated and Target Prices for Cocoa - Medium Income Hypothesis

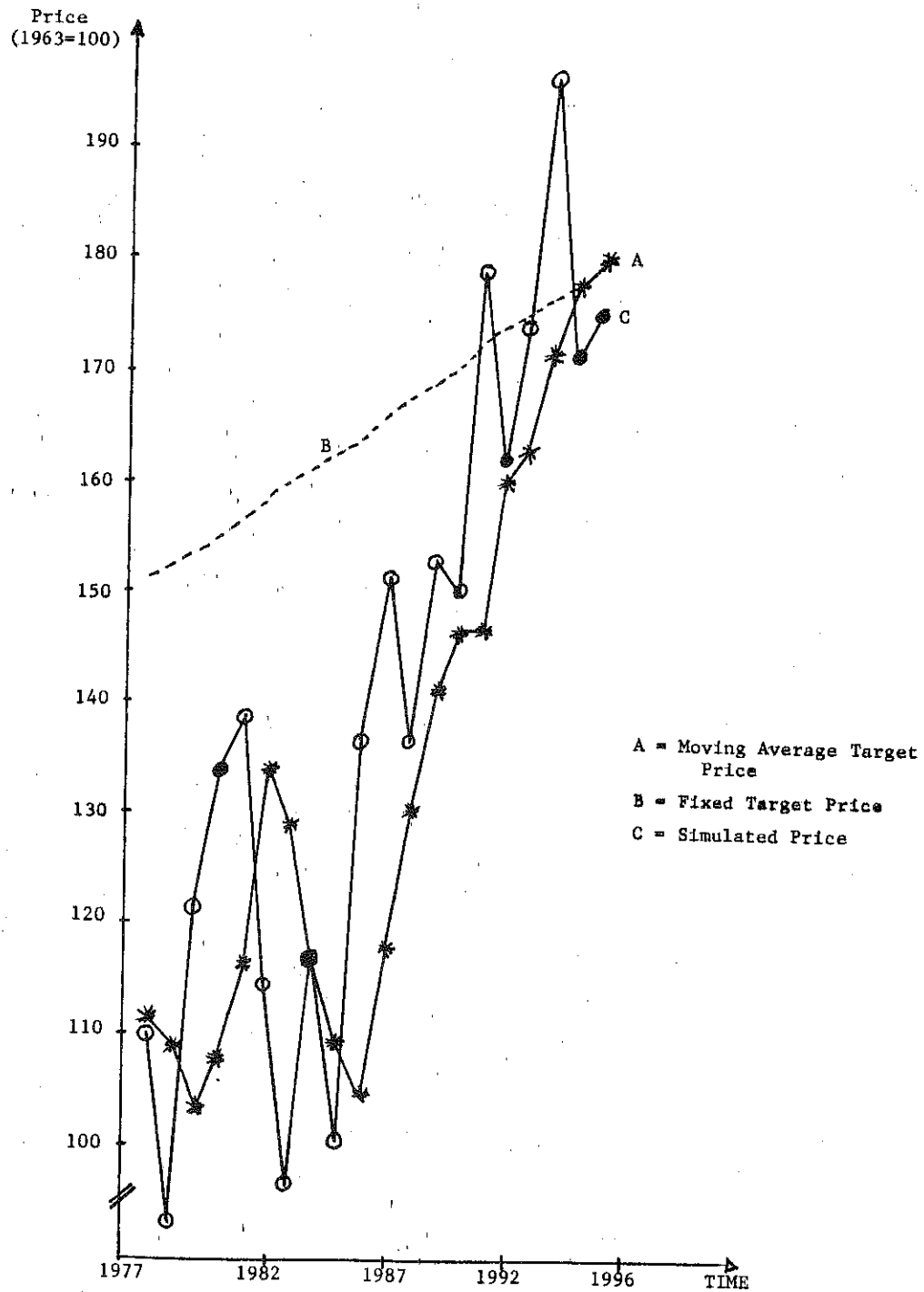

Figure II.3.: Simulated and Target Prices for Cocoa - Low Income Hypothesis

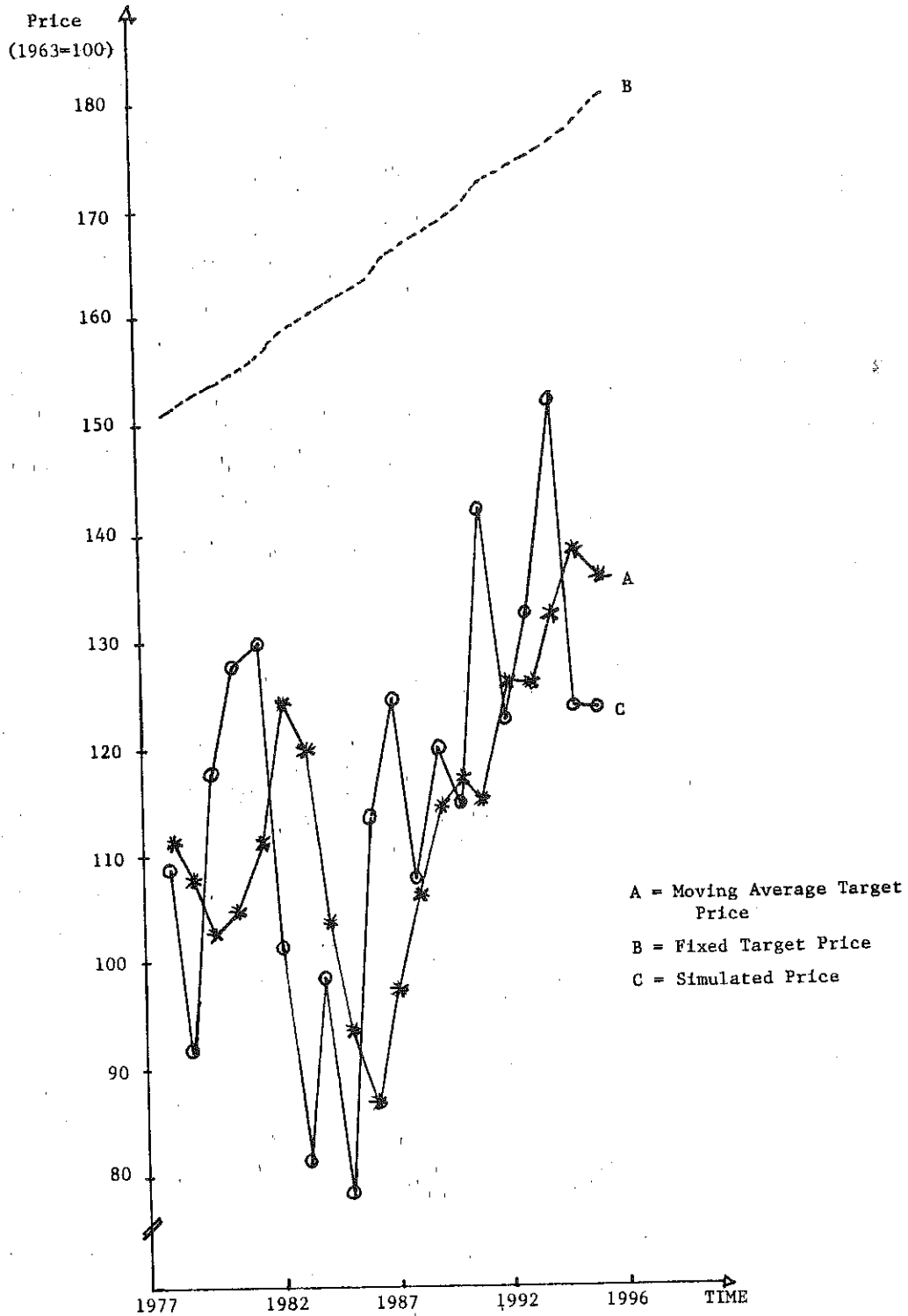
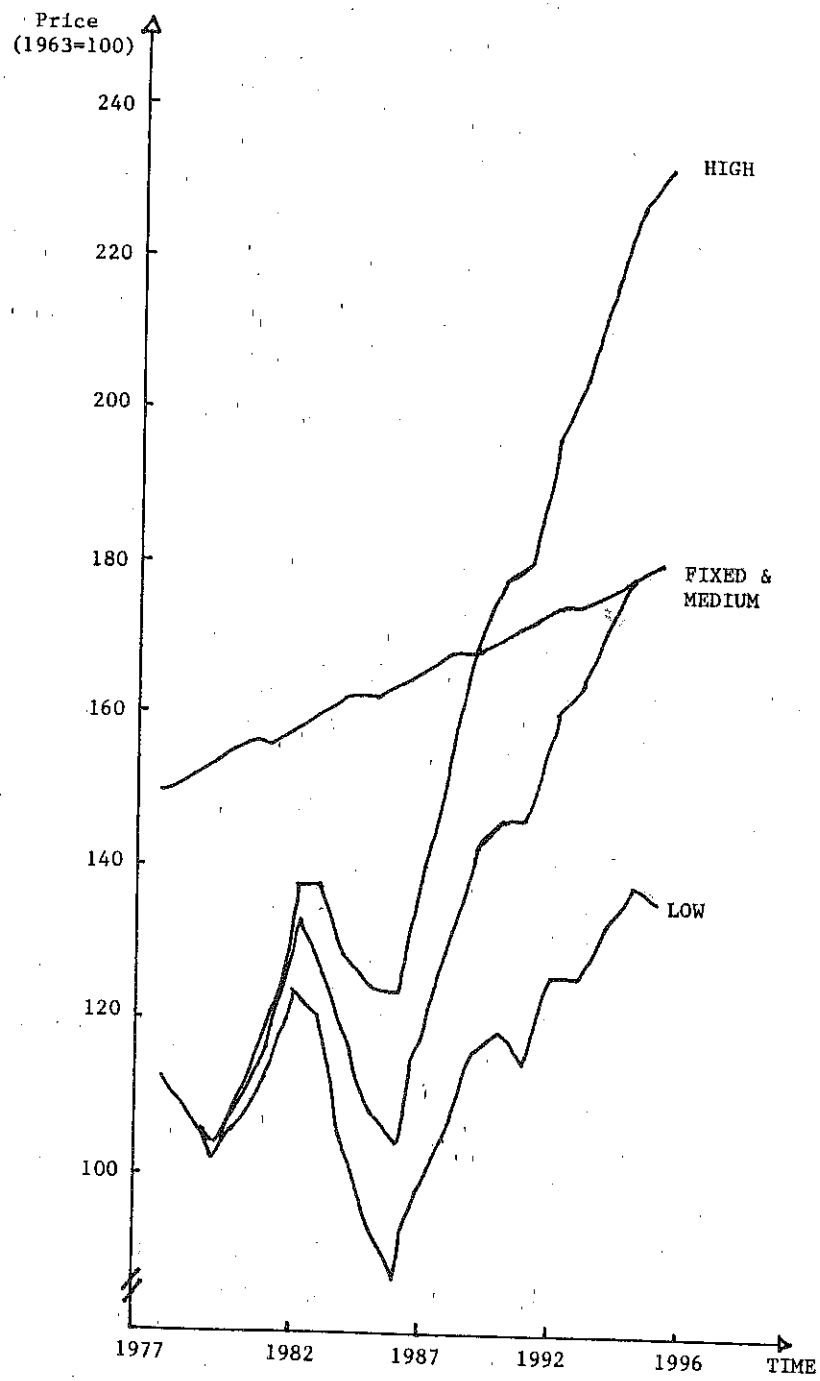

Figure II.4.: Target Prices: Fixed and Three-Year Moving Average for High, Medium, and Low Income Hypotheses



d. Buffer Stocks

The buffer stock level is calculated through the reduced form for endogenously determined prices. This is done with and without the buffer stock ( $u_t$ ). Mathematically, we have  $PC_t = f(X)$  as the reduced form for price, where  $X$  represents all exogenous variables in the model. When buffer stocks ( $u_t$ ) are included, the reduced form becomes  $PC_t^* = f(X, u)$ . Subtraction from the former yields  $PC_t - PC_t^* = \alpha(u_t)$ . Rearranging and solving for  $u_t$  yields:

$$u_t = \delta (PC_t - PC_t^*)$$

where  $\delta = 1/\alpha$ . Note that  $PC_t^*$  is the price obtained when buffer stocks are used. If we let  $PC_t^*$  be our target price, we may solve for  $u_t$  as the level of buffer stocks needed to keep the price equal to our price target.

The constant  $\delta$  is the summation of the coefficients of current prices in the supply, demand, and stock equations. Thus,  $\delta = 1/\alpha$  is easily calculated and amounts to  $\delta = -3.352$  in our model.

A flow chart outlines the logical sequence of events of the simulation model (Figure II.5). Basically, the core of the procedure can be summarized into the following. First, the world cocoa price, free of intervention by the buffer stock authorities and given the exogenous and stochastic variables, is estimated. Second, this price is compared with the target price, and given the specific policy rule, authorities decide if intervention is necessary. If the officials do decide to intervene, the amount bought or sold by the buffer stock is calculated. The procedure has to be repeated as many times as there are years in the simulation time horizon (20).



Figure II.5.: Flow Chart for Buffer Stock Price Stabilization Policy

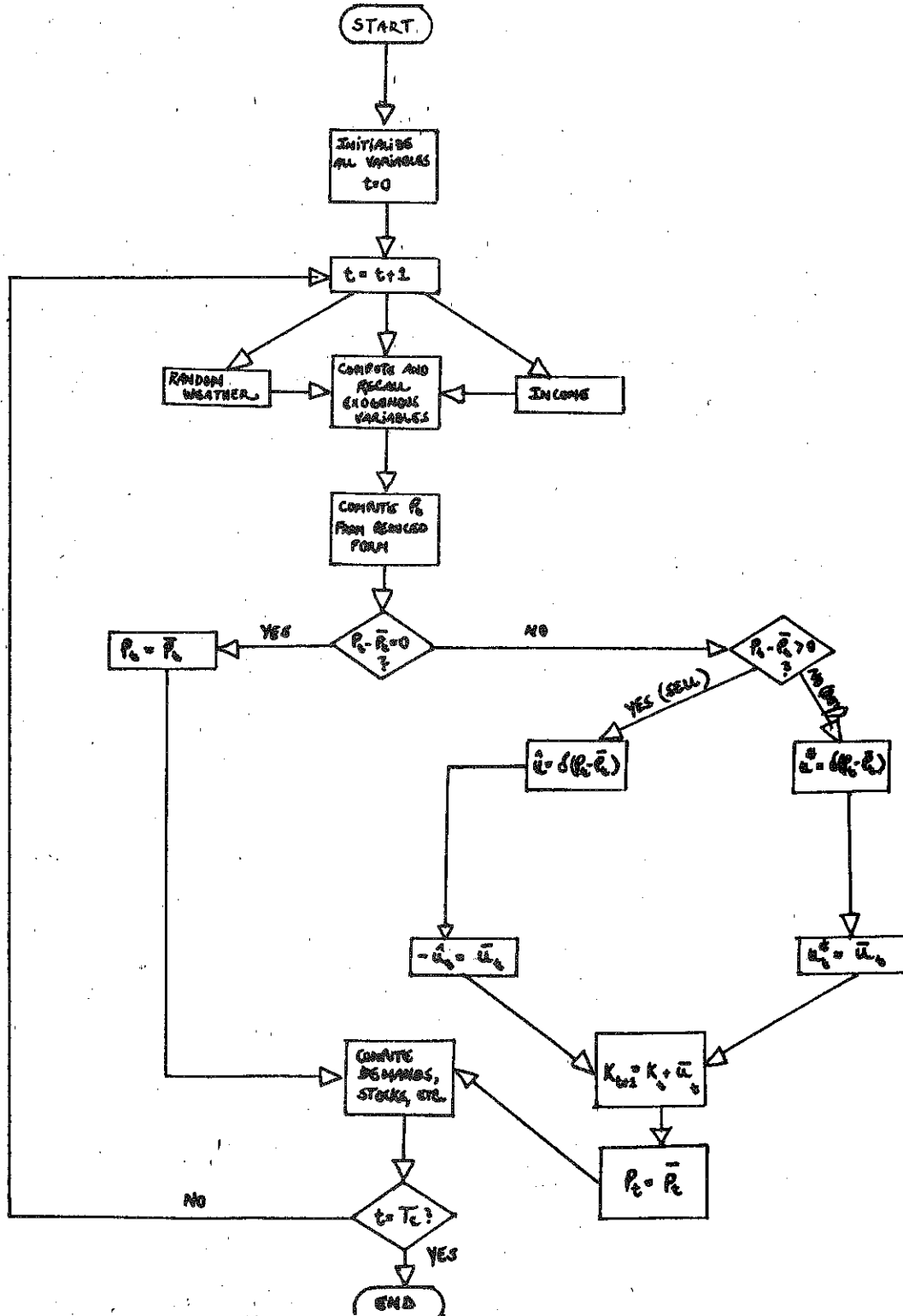

e. Simulation Runs

The model was run using three different income assumptions. For each of these runs, a three-year moving average target price was calculated. Using both the fixed and moving average target prices, changes in buffer stock levels were obtained. This was done under two hypothesis. Under the first, there is a buffer stock intervention (buy or sell) every time the resultant price is different from the target price. The second places a band around the target prices such that there is buffer stock intervention every time the resultant price is 20 percent above or below the target price.<sup>2</sup>

Twelve design points were identified for the purpose of data analysis: fixed target price, fixed target price with a 20 percent band (above and below), three-year moving average target price and three-year target price with a 20 percent band (above and below), each of these under three different assumptions about income growth (high, medium, and low). These design points reflect the accumulated buffer stock level for the 20 year period (1977-96) under the assumptions described above.<sup>3</sup>

---

<sup>2</sup>There was no assumption concerning initial buffer stock level. The reason for this is that one of the objectives of the study is to estimate the probably amounts of cocoa which would be required to run the buffer stock over a 20 year period under alternative buffer stock policies. This amount is equal to the total sales of cocoa which the buffer stock is likely to make in order to stabilize the price in the desired range.

<sup>3</sup>For estimation and simulation a computer package, TROLL, was used. TROLL is a flexible canned computer package for the estimation and simulation of econometric models. It is therefore appropriate for this study.

## III. MODEL EVALUATION

The first property of the model that was explored was its stability. Stability was not evaluated by mathematical analytical techniques (i.e., solving for the characteristic roots of the Jacobian) but by computer simulation. All the exogenous variables were fixed at their 1976 levels, and the model was allowed to run for 39 years. Weather was also constant at its expected value. As can be seen in Figure III.1, the model oscillates towards equilibrium around an upward sloping curve linear trend which is asymptotic to the long-run equilibrium price of approximately 183. The cycle length is approximately six years long, which seems to suggest that the oscillation is caused, in its major part, by the nine-year lag in the supply equation. When the model reaches the peak of a cycle, the price which determines supply is that of the trough of the cycle before the present one. Therefore, supply is low, causing the equilibrium price to be high if the market is too clear. The trend with a positive but decreasing slope is probably caused by the one year lag in the demand side of the model. Since the three demand equations are positively autocorrelated and price inelastic, total demand will be relatively stable. The stock equation, on the other hand, is more sensitive to price. These two factors, together with the fact that supply is also not too sensitive to price changes, will cause overall supply in period  $t$  (supply plus stocks lagged one period) to "lag" behind demand, therefore causing a tendency for price to rise. But, in the long run, as prices reach higher levels, demand will decrease sufficiently and supply increase sufficiently so as to arrive at our result of stability.

The basic objective in this section is to evaluate the model as a predicting device. There are two possible tests for economic models: comparing

Figure III.1.: Model Stability, Values Taken by Price, 1976 to 2015

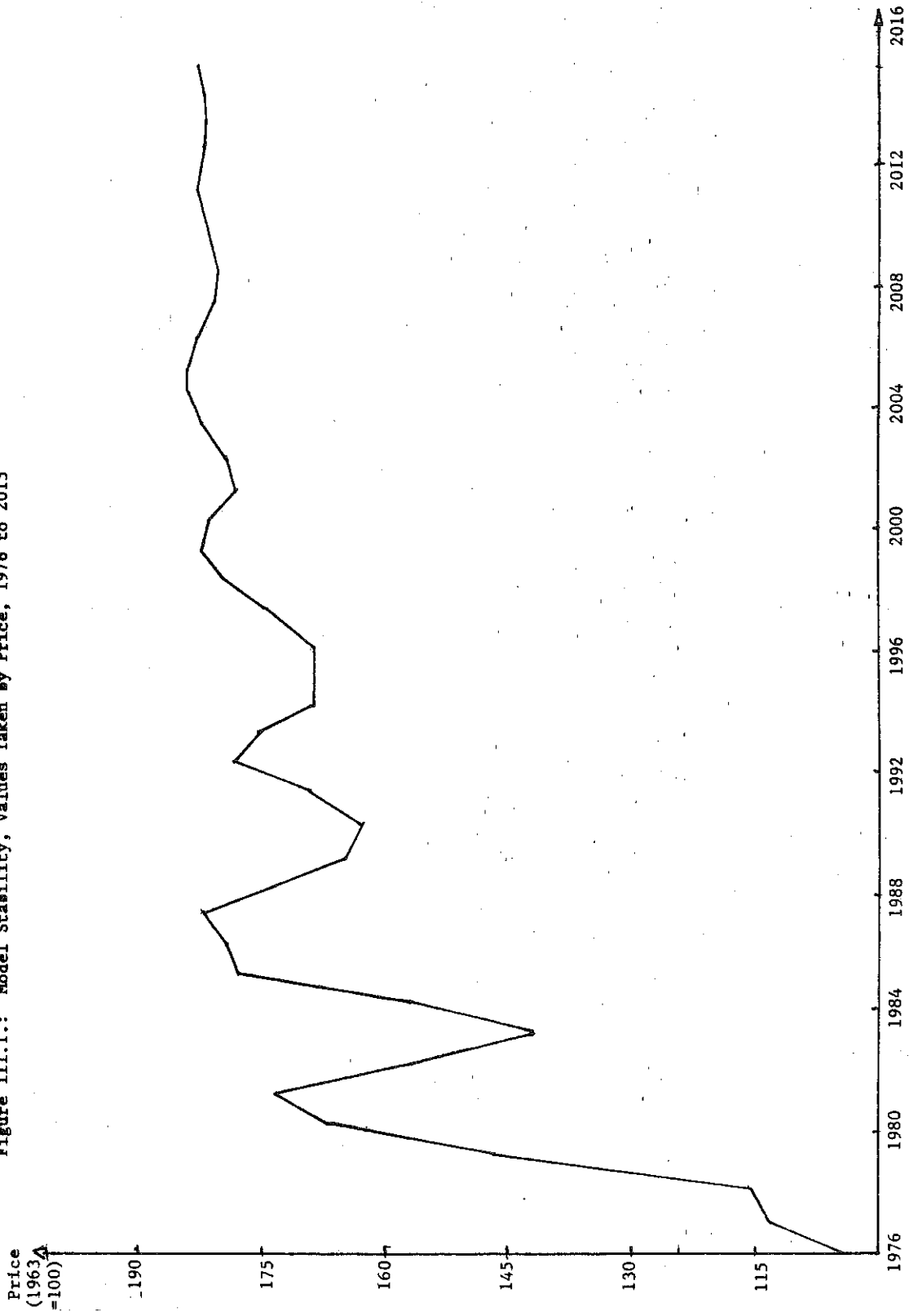

actual historical data of the endogenous variables used to estimate the model, versus the predicted endogenous variables; or actual values for periods outside the range used for estimation versus predicted values for these same time periods of the endogenous variables. The second option was discarded because it would have involved searching for many data sources which might not have been available. Evaluation was therefore performed over a 20-year range from 1956 to 1976 using the predicted endogenous variables whenever the model calls for lagged values.

The first test performed was to graph actual versus predicted values of our main endogenous variable, price (Figure III.2). As can be seen, the predicted values follow relatively closely the actuals. On the other hand, the model can be seen to have a slight tendency to overpredict.

The second test performed was the turning point analysis (Table III.1). Of the 19 points for which the analysis can be realized (the observations for 1956 and 1976 are lost), for 15 points or 79 percent of the time the model correctly predicts the existence or not of a turning point. More specifically, of the eight actual turning points, seven (88 percent) were correctly predicted, and of the 11 nonturning points, eight (73 percent) were also correctly predicted. These results are very satisfactory.

Four mean forecast measures for price were estimated: the mean forecast error for levels (MFE), the mean percent forecast error (percent MFE), the root mean square error for levels (RMS) and the root mean square percent forecast error (percent RMS). The following formulas were used:

$$\text{MFE} = \frac{\sum_{t=1}^N [P_t - A_t]}{N}, \quad \% \text{ MFE} = \frac{\sum_{t=1}^N [P_t - A_t]/N}{\bar{A}_t}$$

$$\text{RMS} = \sqrt{\frac{\sum_{t=1}^N [P_t - A_t]^2}{N}}$$

Figure III.2.: Actual Versus Simulated Values for Price, 1956-1976

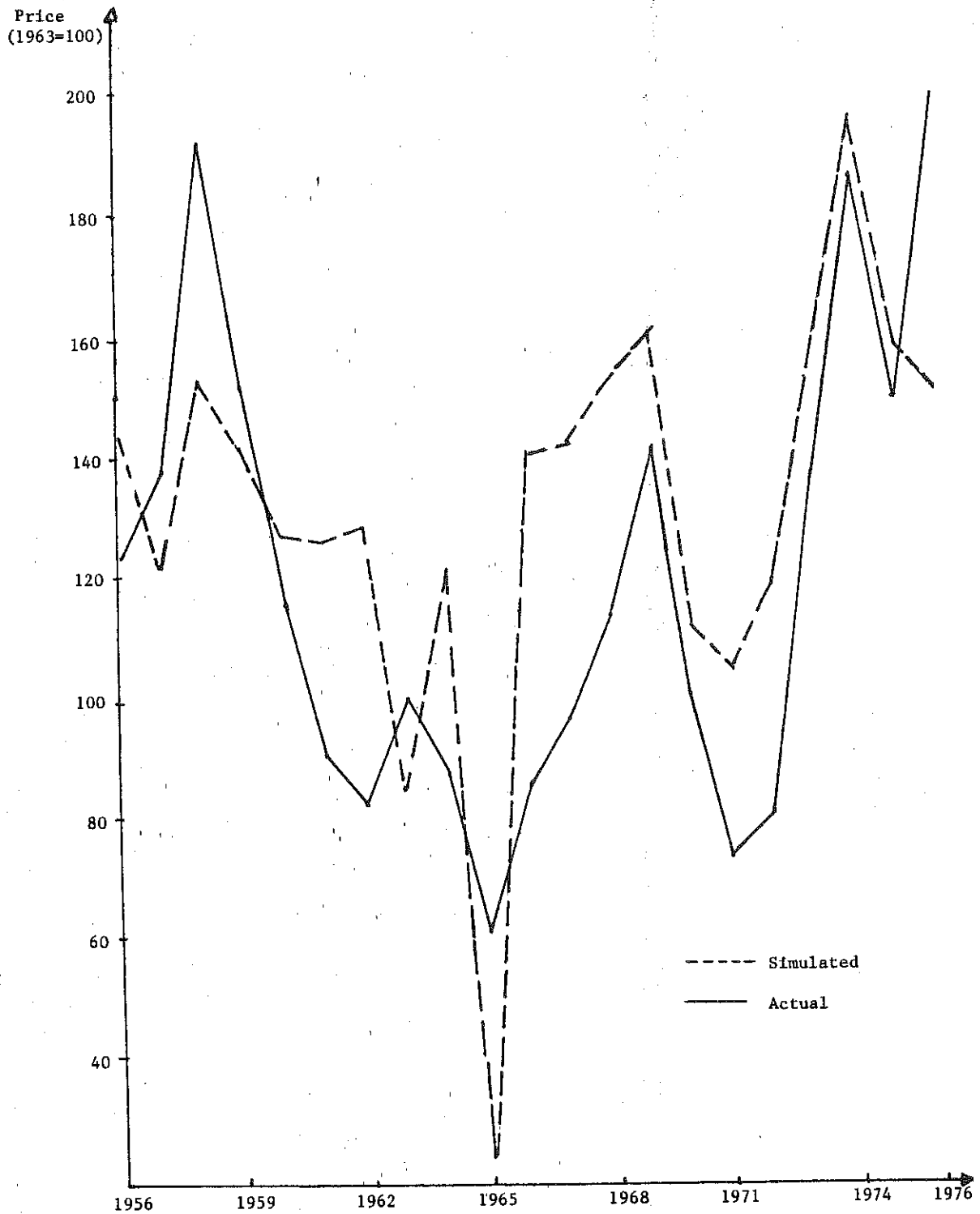

and

$$\% \text{ RMS} = \sqrt{\frac{N \sum_{t=1} [P_t - A_t]^2 / N}{\bar{A}_t}}$$

where P and A denote predicted and actual values of cocoa price, respectively and a bar denotes an average. The results are shown in Table III.2.

Both the mean forecast errors have the defect of allowing errors in opposite direction to cancel each other out. The RMS is difficult to evaluate without comparing it to the same measure of a similar model, or a measure of variability of the actual prices. The percent RMS is the best, as it gives us an indication of how much is the average error in percentage terms without allowing errors in opposite directions to cancel out. It is similar to the standard deviation of the percent error of prediction. None of the four measures are "large" (compare them with the standard deviation of the actual time series), although the percent RMS indicates that on average, our prediction was 32 percent off when both over and under predictions are taken into account.

The three measures taken simultaneously suggest that the model, while predicting correctly the directions of the changes in price, is relatively less able to forecast the absolute levels of cocoa price. In fact, the two mean forecast error measures are positive, which confirm our impression that the model overpredicts on the average. When both negative and positive residuals are evaluated, the model is on average 32 percent inexact. These errors can be explained in part by the assumed linearity and the limited number of explanatory variables. The level of aggregation is also important. It explains why, for example, on the supply-side the price of a competitive product (e.g., coffee) was found to be statistically insignificant (see Lee, 1980, Chapter 3). Therefore, given its simplicity and its level of aggregation, and for the purpose of this study, the model performance is satisfactory.

TABLE III.1. TURNING POINT ANALYSIS

Actual \ Predicted	No Turning Point	Turning Point
No Turning Point	8	7
Turning Point	1	7

TABLE III.2. MEAN FORECAST MEASURES

	<u>Mean Forecast Error</u>	<u>Root Mean Forecast Error</u>	<u>Standard Deviation of the Actual Price</u>
For Levels	13.1	30.2	38.8
For Percentage	15.3	31.9	



## V. SIMULATION RESULTS AND STATISTICAL ANALYSIS

As pointed out previously, the purpose of this paper is to evaluate alternative cocoa buffer stock policies on the basis of total cocoa purchases or sales which are likely to be required over the period 1977-96. The characteristics of each buffer stock policy are two; the target price used and the range over which the price is allowed to fluctuate around the target price. The following four policies are considered:

Policy P<sub>1</sub>

The target price for each year is established after calculating supply and demand for that year based on the trends of production and income. The actual price is assumed to be equal to the target price.

Policy P<sub>2</sub>

The target price is the same as in Policy P<sub>1</sub>. The actual price is allowed to fluctuate within a 20 percent range or below the target price.

Policy P<sub>3</sub>

The target price is a three year moving average of the actual prices. The actual price is assumed equal to the target price.

Policy P<sub>4</sub>

The target price is the same as in Policy P<sub>4</sub>. The actual price is allowed to fluctuate within a 20 percent range above and below the target price.

Apart from the buffer stock policy a second factor influencing the levels of purchases and sales of cocoa by the buffer stock is the actual increase of income in the various groups of countries. The reason for

is that income growth in the various groups of countries influences demand for cocoa and as a result the amounts of cocoa which have to be placed or withdrawn from the market to stabilize the price. Results were obtained for three different levels of income growth, high (H), medium (M), and low (L).

The results are shown in Tables IV.1 and IV.2. Table IV.1 shows the annual purchases (positive numbers) or sales (negative numbers) of cocoa by the buffer stock, under alternative buffer stock policies and income growth levels. Table IV.2 shows total and mean purchases or sales of cocoa by the buffer stock over the 20-year period examined for the various policies which are considered.

In the following section the impact of the various policies will be examined statistically to see if there are significant differences between the four policies. The analysis is based on Table IV.2.

a. F-Test

The F-test is used to test the null hypothesis,  $H_0$ , that the mean purchases or sales of cocoa by the buffer stock over the 20-year period are equal under the four different policies.

$$H_0: Y_1 = Y_2 = Y_3 = Y_4.$$

The two way analysis of variance which is necessary in this case, is shown in Table IV.3. From Table IV.3 one can see that the null hypothesis is rejected at the  $\alpha = 0.10$  level of significance.

b. Multiple Comparisons

Dunnett's method of multiple comparisons was used in order to compare one specific mean, called the control mean (in this case  $Y_4$ ) with all others. Since Dunnett's test refers to single-factor experiments, a one way analysis of variance was performed. This is

TABLE IV.1. Simulated yearly buffer stock purchases and sales of cocoa  
(thousand long tons) during period 1977-1996.

Year	Policy (P <sub>1</sub> )			Policy (P <sub>2</sub> )		
	H	M	L	H	M	L
1977	135.9	138.3	141.0	34.8	37.2	39.9
1978	191.6	199.3	206.3	89.5	97.2	104.2
1979	93.6	108.3	122.2	-	5.2	19.1
1980	48.8	71.8	93.8	-	-	-
1981	28.4	60.5	91.5	-	-	-
1982	107.3	149.5	189.7	1.2	43.3	83.6
1983	160.0	212.6	262.4	52.9	105.4	155.3
1984	86.8	150.3	209.9	-	42.1	101.7
1985	136.1	210.8	280.4	27.0	101.6	171.2
1986	6.7	92.2	171.0	-	-	60.8
1987	- 48.0	47.5	135.0	-	-	23.8
1988	- 2.0	103.5	198.8	-	-	86.6
1989	- 55.6	56.2	163.0	-	-	49.7
1990	- 52.4	70.3	184.4	-	-	70.2
1991	-159.1	-24.6	96.9	- 43.9	-	-
1992	-104.0	43.3	172.7	-	-	56.4
1993	-158.6	2.3	140.4	- 41.3	-	23.2
1994	-242.5	-67.2	80.6	-124.2	-	-
1995	-167.3	23.6	182.3	- 48.0	-	63.0
1996	-193.0	15.0	185.5	- 72.8	-	65.2
Total	-187.4	1663.5	3307.8	-124.9	432.1	1174.0

TABLE IV.1. (continued)

Year	Policy (P <sub>3</sub> )			Policy (P <sub>4</sub> )		
	H	M	L	H	M	L
1977	2.9	5.3	8.0	-	-	-
1978	45.2	51.9	58.2	-	-	-
1979	- 73.7	- 62.3	51.4	- 4.0	-	-
1980	-101.7	87.5	-72.8	-27.7	-14.8	- 2.0
1981	- 93.0	- 75.9	-59.4	-59.4	-	-
1982	40.2	68.3	77.0	-	-	-
1983	88.2	108.5	127.2	-	22.2	47.1
1984	- 21.9	- 0.7	18.3	-	-	-
1985	7.9	30.0	49.3	-	-	-
1986	-131.2	-109.1	-90.0	-48.6	-39.2	-32.0
1987	-134.7	-113.9	-95.8	-40.8	-35.0	-31.0
1988	- 43.9	- 23.5	- 6.9	-	-	-
1989	- 51.6	- 34.9	-15.6	-	-	-
1990	- 27.6	- 8.8	8.8	-	-	-
1991	-132.6	-111.4	-95.5	-12.1	-13.5	-18.8
1992	- 25.2	- 1.0	14.4	-	-	-
1993	- 63.8	- 37.6	-20.9	-	-	-
1994	-112.2	- 84.4	-66.3	-	-	-
1995	- 9.2	20.8	49.8	-	-	-
1996	- 13.9	18.6	40.9	-	-	-
Total	-851.8	-447.6	-19.9	-192.6	-80.3	-36.7

TABLE IV.2. Total purchases of cocoa (thousand long tons) during period 1977-1996 under alternative policies.

Income	Policy	P <sub>1</sub>	P <sub>2</sub>	P <sub>3</sub>	P <sub>4</sub>	Sum
	H	-187.4	-124.9	-851.8	-192.6	-1356.7
	M	1663.5	432.1	-447.6	-80.3	1567.7
	L	3307.8	1174.0	-19.9	-36.7	4425.2
	Sum	4783.9	1481.2	-1319.3	-309.6	4636.2
	Mean (Y <sub>i</sub> )	1594.6	493.7	-439.8	-103.2	

TABLE IV.3. Statistics for two-way analysis of variance.

<u>Source of Variation</u>	<u>Sum of Squares</u>	<u>Degrees of Freedom</u>	<u>Mean Square</u>	<u>F</u>
Between policies	7,180,823	3	2,393,608	4.57
Between different levels of income growth	4,178,982	2	2,089,491	3.99
Error	3,144,672	6	524,112	
Total	14,504,477	11		
$F_{3,6} = 4.76 \quad \alpha = 0.05$			$F_{2,6} = 5.14 \quad \alpha = 0.05$	
$F_{3,6} = 3.29 \quad \alpha = 0.10$			$F_{2,6} = 3.46 \quad \alpha = 0.10$	

shown in Table IV.4. As Table IV.4 shows the null hypothesis that  $Y_1 = Y_2 = Y_3 = Y_4$  is not rejected for both  $\alpha = 0.05$  and  $\alpha = 0.10$ . However, since  $F_{3,8}$  (experiment) = 2.62 is close to  $F_{3,8}$  (tables) = 2.92 at the  $\alpha = 0.10$  significance level, it was decided to perform Dunnett's test. Dunnett's t-statistic (d) was available only at the  $\alpha = 0.05$  and  $\alpha = 0.25$  significance levels. In Dunnett's method of multiple comparisons the confidence interval is given by the following relationship:

$$(Y_j - Y_4) \pm d_{m,u} \sqrt{2 MS e / \eta} \quad j = 1, 2, 3$$

where:

$d_{m,u}$  = tabulated Dunnett's t-statistic

$m = 3$  = number of sample means excluding the control mean

$\eta = 3$  = number of replications

$u = M(n-1)$  = degrees of freedom of MS e (mean square error).

For  $\delta = 0.05$ ,  $d_{3,6} = 2.56$  and the above relationship becomes:

$$Y_j - Y_4 \pm 2000$$

For  $\delta = 0.25$   $d_{3,6} = 1.32$  and the above relationship becomes:

$$Y_j - Y_4 \pm 1031$$

From Table IV.5 it is clear that none of the differences are significant at the 0.05 level while  $Y_1 - Y_4$  is significant at the 0.25 level.

#### c. Comparisons Among Target Prices

The purpose of this test is to examine whether the type of target price used (moving average or target price derived from long run trends in supply and income) has any significant impact on the amount of cocoa accumulated by the buffer stock over the 20-year period.

TABLE IV.4. Statistics for one-way analysis of variance.

<u>Source of Variation</u>	<u>Sum of Squares</u>	<u>Degrees of Freedom</u>	<u>Mean Square</u>	<u>F</u>
Between Policies	7,180,823	3	2,396,608	2.62
Error	7,323,654	8	915,457	
Total	14,504,477	11		

$F_{3,8} = 4.07 \quad \delta = 0.05$

$F_{3,8} = 2.92 \quad \delta = 0.10$

TABLE IV.5. Differences of sample mean ( $Y_j - Y_4$ ).

<u>j</u>	<u>1</u>	<u>2</u>	<u>3</u>
$Y_j - Y_4$	1697.8*	596.9	-1010

at  $\delta = 0.05$   $d_{3,6} = 2.42$

Confidence Allowance  $\pm 2000$

none of the differences are significant

at  $\delta = 0.25$   $d_{3,6} = 1.32$

Confidence Allowance  $\pm 1031$

only difference  $Y_1 - Y_4$  is significant.

Thus the null hypothesis in this case is:

$$H_0: \frac{1}{2} Y_1 + \frac{1}{2} Y_2 = \frac{1}{2} Y_3 + \frac{1}{2} Y_4$$

or

$$H_0: L_1 = \frac{1}{2} Y_1 + \frac{1}{2} Y_2 - \frac{1}{2} Y_3 - \frac{1}{2} Y_4 = 0$$

$$L_1 = \frac{1}{2} (4783.9) + \frac{1}{2} (1481.2) - \frac{1}{2} (-1319.3) - \frac{1}{2} (-309.6)$$

or

$$L_1 = 3947.$$

$$S_{L_1} = \text{MSE} \frac{\sum \lambda_i^2}{4} \quad \text{where} \quad \begin{aligned} \lambda_1 &= \lambda_2 = \frac{1}{2} \\ \lambda_3 &= \lambda_4 = -\frac{1}{2} \end{aligned}$$

$$n = \text{number of replications} = 3$$

So

$$S_{L_1} \text{ (standard deviation of } L_1) = \sqrt{915457(0.333)} = 552.4$$

$$S_o t(\text{experimental}) = \frac{394.7}{552.4} = 7.145$$

$$t_{m(n-1)} = t_{8(\text{tables})} = 2.306 \text{ for } \alpha = 0.05$$

Since  $t(\text{exp}) > t_{8(\text{tables})}$  the null hypothesis is rejected.

d. Comparisons Among Permissible Price Ranges Around Target Price

The purpose of this test is to examine whether the range over which the price is allowed to fluctuate around the target price has a significant impact on the amount of cocoa accumulated by the buffer stock over the 20-year period. As mentioned before, the cases examined were two; the actual price has to be equal to the target price (Policies P<sub>1</sub> and P<sub>3</sub>) and the actual price is allowed to fluctuate within a 20 percent range over or below the target price (Policies P<sub>2</sub> and P<sub>3</sub>).



Thus the null hypothesis in this case is:

$$H_0: \frac{1}{2} Y_1 + \frac{1}{2} Y_3 = \frac{1}{2} Y_2 + \frac{1}{2} Y_4$$

or

$$H_0: L_2 = \frac{1}{2} Y_1 + \frac{1}{2} Y_3 - \frac{1}{2} Y_2 - \frac{1}{2} Y_4 = 0$$

$$L_2 = \frac{1}{2} (4783.9) + \frac{1}{2} (-1319.3) - \frac{1}{2} (1481.2) - \frac{1}{2} (-309.6)$$

or

$$L_2 = 1146.5$$

$$S_{L_2} = \sqrt{915457 (0.3333)} = 552.4$$

$$\text{So } t(\text{exp}) = \frac{1146.5}{552.4} = 2.075$$

Since  $T_{8(\text{tables})} = 2.306$  for  $\alpha = 0.05$  the null hypothesis is not rejected. At the 0.10 significance level  $t_{8(\text{tables})} = 1.86$ ; so at this level of significance the null hypothesis is rejected.

e. Comparisons Among Permissible Price Ranges When Target Price is Calculated From Trends in Income and Supply

The null hypothesis in this case is:

$$H_0: 1Y1 = 1Y2$$

or

$$H_0: L_3 = 1Y1 - 1Y2 = 0$$

$$L_3 = 4783.9 - 1481.2 = 3302.7$$

$$S_{L_3} = \sqrt{915457 \left(\frac{1}{3} + \frac{1}{3}\right)} = 781.2$$

$$S \quad t(\text{exp}) = \frac{3302.7}{781.2} = 4.23$$

$t_{8(\text{tables})}$  for  $\alpha = 0.05 = 2.306$  so null hypothesis is rejected.

f. Comparisons Among Permissible Price Ranges When Target Price is Calculated as a Three-Year Moving Average

The null hypothesis in this case:

$$H_0: 1Y3 = 1Y4$$

or

$$H_0: L_4 = 1Y3 - 1Y4 = 0$$

$$L_4 = 1319.3 - 309.6 = 1009.7$$

$$S_{L_4} = \sqrt{915457 \left(\frac{1}{3} + \frac{1}{3}\right)} = 781.2$$

$$S_0 t(\text{experiment}) = \frac{1009.7}{781.2} = 1.292$$

Since  $t_{8(\text{tables})} = 2.306$  for  $\alpha = 0.05$

and  $t_{8(\text{tables})} = 1.860$  for  $\alpha = 0.10$

the null hypothesis is not rejected at both significance levels. A summary of comparisons 3, 4, 5, and 6 is presented in Table IV.6.

TABLE IV.6. Various Comparisons

Comparison	$H_0$	Linear combination ( $L_i$ )	Standard deviation of $\frac{L_i}{S_{L_i}}$	$t = \frac{L_i}{S_{L_i}}$	$H_0$ rejected or not
Comparisons among target prices	$\frac{1}{2} Y_1 + \frac{1}{2} Y_2 = \frac{1}{2} Y_3 + \frac{1}{2} Y_4$	$L_1 = \frac{1}{2} Y_1 + \frac{1}{2} Y_2 - \frac{1}{2} Y_3 - \frac{1}{2} Y_4 = 3947$	$S = 552.4$	7.14	rejected at $\alpha = 0.05$
Comparisons among price ranges	$\frac{1}{2} Y_1 + \frac{1}{2} Y_3 - \frac{1}{2} Y_2 + \frac{1}{2} Y_4$	$L_2 = \frac{1}{2} Y_1 + \frac{1}{2} Y_3 - \frac{1}{2} Y_2 - \frac{1}{2} Y_4 = 1146.5$	$S_{L_1} = 552.4$	2.075	rejected only at $\alpha = 0.10$
Comparisons among price ranges for target price 1*	$1_{Y_1} = 1_{Y_2}$	$L_3 = Y_1 - Y_2 = 3307$	$S_{L_3} = 781.2$	4.23	rejected at $\alpha = 0.05$
Comparisons among price ranges for target price 2**	$1_{Y_3} = 1_{Y_4}$	$L_4 = Y_3 - Y_4 = 1009.7$	$S_{L_4} = 781.2$	1.29	not rejected

\*Target price 1 is based on trends of supply and income.

\*\*Target price 2 is a three-year moving average.

## V. CONCLUSION

The model that was used proved to be stable and explained to a great extent the actual behaviour of the cocoa market.

The study also shows that the target price is the most important factor influencing the performance of the buffer stock when performance is measured as cocoa stocks accumulated during the 20-year period. Thus, if a target price above the long run equilibrium is used as a way to transfer income to exporting countries excessive stocks of cocoa will have to be accumulated. Because of this problem this policy does not seem to be feasible. The policy which combines a moving average target price with a 20 percent price range results in the minimum accumulation of cocoa stocks. If more price stability is desired, the price range should be reduced at the cost of higher cocoa accumulations.

Finally, the study shows that the rate of growth in income has a significant impact on the amount of cocoa accumulated by the buffer stock in order to keep the price within the desired range; for this reason a better knowledge of the likely level of income growth in the various groups of countries will improve the predictions of the cost of the various buffer stock policies.

## REFERENCES

1. Adams, F.G. and J.R. Behrman, "Econometric Models of World Agricultural Commodity Markets", Ballinger Cambridge, 1975.
2. Lee, Seon, "Buffer Stock Rules for World Commodity Markets: An Application of Optimal Control Theory", Ph.D. Thesis, Cornell University, 1980.
3. Naylor, Thomas H., "Computer Simulation Experiments with Models of Economic Systems", New York:John Wiley & Sons, Inc., 1971.
4. Okorie, A. and D. Blandford, "World Market Trends and Prospects for Cocoa", Cornell International Agriculture Mimeograph #73, September 1979.
5. Robinson, K.L., Farm and Food Policies, Lecture notes Ag. Ec. 351, Cornell University, Department of Agricultural Economics, 1980.
6. Turnovsky, S.J., "The Distribution of Welfare Gains from Price Stabilization: A Survey of Some Theoretical Issues", in Adams, F.G. and Klein, S.A., "Stabilizing World Commodity Markets", Lexington, Mass., D.C. Heath, 1978.