

Szromek, Adam R. (Ed.)

Book

Sustainable Business Models in Tourism

Provided in Cooperation with:

MDPI – Multidisciplinary Digital Publishing Institute, Basel

Suggested Citation: Szromek, Adam R. (Ed.) (2021) : Sustainable Business Models in Tourism, ISBN 978-3-0365-0889-4, MDPI, Basel, <https://doi.org/10.3390/books978-3-0365-0889-4>

This Version is available at:

<https://hdl.handle.net/10419/274009>

Standard-Nutzungsbedingungen:

Die Dokumente auf EconStor dürfen zu eigenen wissenschaftlichen Zwecken und zum Privatgebrauch gespeichert und kopiert werden.

Sie dürfen die Dokumente nicht für öffentliche oder kommerzielle Zwecke vervielfältigen, öffentlich ausstellen, öffentlich zugänglich machen, vertreiben oder anderweitig nutzen.

Sofern die Verfasser die Dokumente unter Open-Content-Lizenzen (insbesondere CC-Lizenzen) zur Verfügung gestellt haben sollten, gelten abweichend von diesen Nutzungsbedingungen die in der dort genannten Lizenz gewährten Nutzungsrechte.

Terms of use:

Documents in EconStor may be saved and copied for your personal and scholarly purposes.

You are not to copy documents for public or commercial purposes, to exhibit the documents publicly, to make them publicly available on the internet, or to distribute or otherwise use the documents in public.

If the documents have been made available under an Open Content Licence (especially Creative Commons Licences), you may exercise further usage rights as specified in the indicated licence.



<https://creativecommons.org/licenses/by/4.0/>



sustainability

Sustainable Business Models in Tourism

Edited by
Adam R. Szromek

Printed Edition of the Special Issue Published in *Sustainability*

Sustainable Business Models in Tourism

Sustainable Business Models in Tourism

Editor

Adam R. Szromek

MDPI • Basel • Beijing • Wuhan • Barcelona • Belgrade • Manchester • Tokyo • Cluj • Tianjin



Editor

Adam R. Szromek
Silesian University of
Technology
Poland

Editorial Office

MDPI
St. Alban-Anlage 66
4052 Basel, Switzerland

This is a reprint of articles from the Special Issue published online in the open access journal *Sustainability* (ISSN 2071-1050) (available at: https://www.mdpi.com/journal/sustainability/special_issues/Sustainable_Business_Models_Tourism).

For citation purposes, cite each article independently as indicated on the article page online and as indicated below:

LastName, A.A.; LastName, B.B.; LastName, C.C. Article Title. <i>Journal Name</i> Year , <i>Volume Number</i> , Page Range.
--

ISBN 978-3-0365-0888-7 (Hbk)

ISBN 978-3-0365-0889-4 (PDF)

The book was prepared for the implementation of a research project 'A business model for health resort enterprises' No. 2017/25/B/HS4/00301, supervised and financed by the National Science Center in Poland.

© 2021 by the authors. Articles in this book are Open Access and distributed under the Creative Commons Attribution (CC BY) license, which allows users to download, copy and build upon published articles, as long as the author and publisher are properly credited, which ensures maximum dissemination and a wider impact of our publications.

The book as a whole is distributed by MDPI under the terms and conditions of the Creative Commons license CC BY-NC-ND.

Contents

About the Editor	vii
Preface to “Sustainable Business Models in Tourism”	ix
Adam R. Szromek Model of Business Relations in Spa Tourism Enterprises and Their Business Environment Reprinted from: <i>Sustainability</i> 2020, 12, 4941, doi:10.3390/su12124941	1
Richard W. Butler and Adam R. Szromek Incorporating the Value Proposition for Society with Business Models of Health Tourism Enterprises Reprinted from: <i>Sustainability</i> 2019, 11, 6711, doi:10.3390/su11236711	21
Zygmunt Kruczek and Adam R. Szromek The Identification of Values in Business Models of Tourism Enterprises in the Context of the Phenomenon of Overtourism Reprinted from: <i>Sustainability</i> 2020, 12, 1457, doi:10.3390/su12041457	41
Ján Derco, Piotr Romaniuk and Michal Cehlár Economic Impact of the Health Insurance System on Slovak Medical Spas and Mineral Spring Spas Reprinted from: <i>Sustainability</i> 2020, 12, 3384, doi:10.3390/su12083384	53
Agnieszka Niezgoda and Klaudyna Kowalska Sharing Economy and Lifestyle Changes, as Exemplified by the Tourism Market Reprinted from: <i>Sustainability</i> 2020, 12, 5351, doi:10.3390/su12135351	65
Mateusz Naramski and Krzysztof Herman The Development of Mobile Tourism in the Upper Silesian Metropolitan Area of Poland Reprinted from: <i>Sustainability</i> 2020, 12, 44, doi:10.3390/su12010044	85
Adam R. Szromek, Beata Hysa and Aneta Karasek The Perception of Overtourism from the Perspective of Different Generations Reprinted from: <i>Sustainability</i> 2019, 11, 7151, doi:10.3390/su11247151	107
Anna Adamus-Matuszyńska, Piotr Dzik, Jerzy Michnik and Grzegorz Polok Visual Component of Destination Brands as a Tool for Communicating Sustainable Tourism Offers Reprinted from: <i>Sustainability</i> 2021, 13, 731, doi:10.3390/su13020731	127
Marek Józwiak and Patrycja Sieg Tourism Development in Post-Industrial Facilities as a Regional Business Model Reprinted from: <i>Sustainability</i> 2021, 13, 2028, doi:10.3390/su13042028	145
Mateusz Naramski The Application of ICT and Smart Technologies in Polish Museums—Towards Smart Tourism Reprinted from: <i>Sustainability</i> 2020, 12, 9287, doi:10.3390/su12219287	161
Adam R. Szromek An Analytical Model of Tourist Destination Development and Characteristics of the Development Stages: Example of the Island of Bornholm Reprinted from: <i>Sustainability</i> 2019, 11, 6989, doi:10.3390/su11246989	189

Michał Żemła

Winter Sports Resorts and Natural Environment—Systematic Literature Review Presenting Interactions between Them

Reprinted from: *Sustainability* **2021**, *13*, 636, doi:10.3390/su13020636 205

Piotr Oleśniewicz, Sławomir Pytel, Julita Markiewicz-Patkowska, Adam R. Szromek and Soňa Jandová

A Model of the Sustainable Management of the Natural Environment in National Parks—A Case Study of National Parks in Poland

Reprinted from: *Sustainability* **2020**, *12*, 2704, doi:10.3390/su12072704 223

Yusuke Kitamura, Yuki Ichisugi, Selim Karkour and Norihiro Itsubo

Carbon Footprint Evaluation Based on Tourist Consumption toward Sustainable Tourism in Japan

Reprinted from: *Sustainability* **2020**, *12*, 2219, doi:10.3390/su12062219 251

About the Editor

Adam R. Szromek is a Full Professor of Social Science in Tourism Management. He is a Professor of Management at the Silesian University of Technology in Poland and a member of the Commission on Management Sciences at the Polish Academy of Sciences.

His research interests focus on heritage tourism and health tourism, with special attention to spa tourism management and business models in spa enterprises.

Professor Szromek's research has appeared in the *Tourism Management*, *American Journal of Tourism Management*, *Health Policy*, *Health Services Research*, *Sustainability*, *Studies in Physical Culture and Tourism*, and *Human Resources for Health*.

Preface to "Sustainable Business Models in Tourism"

The progressing transformation of tourist and healing activities, in the scope of the broadly understood organizational and market processes, reveals, at the same time, that the tools for operating this activity are outdated. The functioning of an enterprise deprived of reliable strategic tools in a turbulent environment is becoming more and more difficult, and the lack of response to the reported market needs may even lead to a crisis.

Sustainable development, in its broader perspective, is another aspect necessary to include in contemporary business models. A tourist and spa company cannot ignore its own environmental impact, or fail to see the consequences of its activities.

It is necessary to offer managers modern management tools that cover the broadest possible scope of integration of the elements of the conducted business activities, at the same time adjusted to the specificity of the market and needs of the natural environment in which the enterprises managed by them operate.

I invite you to read my book on business models in tourism, in the context of considering the principles of sustainable development. This book, formulated in the light of the presented needs, aims to use the concept of business models and sustainability business models in the context of a tourism enterprise, adapted to the existing conditions of tourist and spa activities. We are also presenting exemplifications of business models and other management methods used in tourism activities.

The book was prepared for the implementation of a research project 'A business model for health resort enterprises' No. 2017/25/B/HS4/00301, supervised and financed by the National Science Center in Poland.

I sincerely thank all the authors of the following chapters, my team, and invited guest authors. I especially want to thank Professor Richard W. Butler for his friendship and mentoring.

Adam R. Szromek

Editor

Article

Model of Business Relations in Spa Tourism Enterprises and Their Business Environment

Adam R. Szromek

Department of Organization and Management, Institute of Economy and Informatics, Silesian University of Technology, Akademicka 2A, 44-100 Gliwice, Poland; innowator@o2.pl; Tel.: +48-32-277-7336

Received: 29 May 2020; Accepted: 15 June 2020; Published: 17 June 2020

Abstract: Sustainable tourism, carried out on spa tourism enterprises, is a key issue that requires the combination of the implementation of economic goals of business activity and, at the same time, the limitation of negative influences on the tourist areas, which are valuable from the point of nature. The main objective of this article and, at the same time, the objective of theoretical–cognitive and empirical research, is to find links and mutual relations between the entities carrying out tourist and therapeutic activity in health resorts in a model approach, taking into account sustainable tourism elements. The implementation of the goal will be carried out on the basis of empirical studies, covering business models of 17 of the largest health resorts in Poland. The article describes relations occurring in the health resort environment and defines a model of relations between health resort enterprises and other entities functioning within this sector. The network approach of the studied issue is analyzed from the point of view of relations found in the complementary cooperation of entities, among which one is ready to implement the benefit and others express their need for the said benefit and are willing to be its recipients. The network relation of the second type, where the entities combine their forces to meet a common goal, is presented in the form of exemplification of the health resort enterprise network in the Polish market.

Keywords: sustainability; business model; spa tourism; business environment

1. Introduction

Sustainable tourism, carried out in health resort areas, is a key research issue, having, at the same time, important practical effects. The necessity of combining the economic objectives of business activity and limiting its negative influence on health resort resources seems to be very difficult, if not contradictory. The complexity of the issue is further enhanced by the necessity to implement these objectives within the whole sector or its part. While the attempt to balance the activity within its own business model is possible to capture and regulate, the cooperation between particular entities of this market within the same proecological or cultural objectives can be more difficult [1]. However, this requires the analysis of mutual relations between a health resort enterprise and other entities functioning on the market. The contemporary approach to mutual relations to achieve synergy [2] cannot be based solely on quantitative criteria, especially in the area of price, but also on qualitative criteria, especially in terms of sustainable economic and social goals [1].

The main objective of this article and, at the same time, the objective of theoretical–cognitive and empirical research, is to find links and mutual relations between the entities carrying out tourist and therapeutic activity in health resorts in a model approach, taking into account sustainable tourism elements. Identification of relationships between dependent entities operating on the spa tourism market, as part of one business model or linked business models, will help managers of spa companies to look at the structure of market connections from a broader perspective. This approach to mutual business relations will enable individualized optimization of economic activities aimed at finding

sustainable solutions, in terms of costs and material savings, shortening delivery times, and changing the chain of relationships.

The general objective defined above is divided into two more specific cognitive objectives. The first specific objective is of theoretical and cognitive nature and is directed towards the identification of functioning mechanisms of health resort enterprises. The second objective (of empirical type) concerns the identification of the relationship between the health resort enterprises and their environment. The implementation of this objective requires its own research that covers the analysis of business models of health resort enterprises. After obtaining the research results, the four-factor approach to *design space* analysis [3] is used, and the conclusions are presented.

The network approach of the studied issue is analyzed from the point of view of relations found in the complementary cooperation of entities, among which one is ready to implement a benefit and others express their need for the said benefit and are willing to be its recipients. The network relation of the second type [4], where the entities combine their forces to meet a common goal, is presented in the form of exemplification of the health resort enterprise network in the Polish market.

2. Literature Review

The Global Sustainable Tourism Council (GSTC) [5] has developed criteria that are arranged in four pillars: sustainable management, socioeconomic impacts, cultural impacts, and environmental impacts (including consumption of resources, reducing pollution, and conserving biodiversity and landscapes). When discussing sustainable management, it was emphasized how important the modeling of business is, which fosters the protection of culture and the natural environment. In this aspect, the spa areas are very sensitive, meaning areas valuable from the point of nature, with health resources and health properties of the climate, where the infrastructure allowing for the implementation of tourist and therapeutic functions is located. Mutual relations between entities of the spa sector should be based on the responsibility to protect natural resources and local culture. Otherwise, the changes caused by overtourism can degrade the spa area and limit its tourist and therapeutic functions. Therefore, what is crucial is the proper formulation of relations between the health resort enterprise and its environment (suppliers, recipients, spa communes, partners, competition), taking into account practices protecting the health resort areas.

The health resort is a specific tourist and therapeutic entity, with various forms and tasks implemented in the health resorts for patients and spa tourists. This is not an easy area of activities to be defined, both by theoreticians and by practitioners, as the enterprise functioning in such an area implements both tasks, falling within the scope of tourism (within the private sector) and public health (within the public sector). The structure of Polish health resorts, carried out in the form of health resort facilities, covers such types of constituent entities as spas, spa hospitals (with associated catering facilities), as well as spa centers for children, spa clinics, and natural therapy centers rendering medical services [6]. However, apart from the spa enterprises in the health sector, there are also other dependent social and economic entities for which the enterprise can be a service provider, a recipient of medical raw materials, a beneficiary of contracts, and even the main provider of health policies. The importance and extensiveness of the roles in the specific relations require the standardization of the structure of links between these entities in the form of a business relations model, where the starting point is the health resort business model.

2.1. Responsiveness of Enterprise to the Change of Business Environment

Business modeling is a crucial organizational process for every enterprise. Its result is, in general, the model describing processes taking place in the business activity, as well as their link with the environment influencing the enterprise. Therefore, a business model is the characteristics of the described business [7] or a description of relations between components in an organization that result in the creation of value for the organization [8]. A business model is also a visual depiction of an organization's functioning logic, its elements, or ventures in the form of appropriately named,

interlinked elements of a template that—once populated with content—ensure logical understanding of the process of functioning, survival, and development of an organization [9]. However, another definition of a business model indicates that it is a conceptual tool, containing a set of elements and their relations with defined objectives, allowing us to expose the company's business logic. At the same time, it is a description of values that the enterprise is able to provide to market segments of the organization, along with its network relations with partners, to create value [10–12]. The idea of a business model as a tool is also promoted by D. Teece [13,14], who perceives it as a tool describing the design or architecture of creation, supply, or value-capturing mechanisms. S. Prendeville and N. Bocken [15] describe the business model as a conceptual tool, describing the activities that refer to business transactions between customers, partners, and suppliers, as well as the organization and their participation in the development and capturing of value.

The creators of the CANVAS business model structure, A. Osterwalder and Y. Pigneur [3], proposed a complex approach to create business models. They named six techniques of designing business models that can be treated as managerial tools. At the same time, they revealed six perspectives of creating models: (1) customer's inspiration, (2) creation of ideas, (3) visual thinking, (4) creation of prototypes, (5) storytelling, and (6) scenarios. As a consequence, a nine-element template of a business model named CANVAS was designed. These nine interconnected elements influencing one another are customer segments, value proposals, distribution channels, customer relations, revenue streams, key resources, key activities, key partners, and costs structure. Some of them strongly depend on the environment, which significantly influences the shape of such elements as key customer relations and partner relations in the environment and recipients' segments or distribution channels and key resources, as well as key activities.

The developments of the Board of Innovation [16], which has presented multiple innovative solutions and examples of business models for numerous industries, can be very helpful. The Board of Innovation explains that the innovation programs can be defined as the activity that influences and introduces innovations to a company's strategy. One of the dimensions is the scope of innovation influence intensity, and the second is the opportunities that the organization has. Therefore, the Board of Innovation has developed a modern manner of presenting mutual interactions taking place between the enterprise and its environment, as well as other participants of the same sector. The presentation of these relations can foster the correctness of formulating a business model of an enterprise functioning in a turbulent environment.

It seems that this is a very important remark, as, so far, the research has been more focused on the internal relations of the enterprise and rarely on external relations. It must be noted, however, that the enterprise is functioning in a specific environment that influences the enterprise and changes due to the business activity of the enterprises functioning in them. K. Obłój [17] pays attention to the fact that strategic decision-making requires strategic analysis of the environment and the analysis of the organization. The analysis of the environment and understanding of the present challenges, opportunities, and threats requires us to look at the environment of the company and then carry out a more indepth analysis of the industry and strategic group within which the company competes. Intrasectoral competitiveness of competition, complemented with the influence of suppliers, recipients, substitutes, and new market participants (new products), allows us to start a discussion on the competitiveness of the enterprise. However, such an analysis does not provide a full scope of information on the dynamics of the changes taking place. Meanwhile, establishing a business model requires such analysis not only in the context of one enterprise but also the whole sector within which the enterprise is functioning.

It must be noted that the literature presents such intrasectoral relations influencing the shape of the enterprise business model. According to B. Nogalski [18], it is the sector that forces the manner of carrying out business activity on the enterprise. It applies to the configuration of resources, activities, as well as offered products and services that ensure the creation of value for customers and the generation of profit for enterprise owners. The redefinition of a business model (also defined as strategic

regeneration) is a process that should ensure that the enterprise matches the external conditions, thanks to reorganization, diversification, divestment, change of technology or business activity, and/or re-engineering of operational processes or product portfolios. According to M. Porter [19], the sector is a part of industry grouping enterprises manufacturing products or providing services of similar purpose (substitutes) and selling them on the same geographical market. Meanwhile, K. Obłój [17] emphasized the complexity and dynamics of the environment, understood not only from the perspective of market and industry but also as a complex system of numerous trends, events, and markets creating the context for a company's function (meaning *environment*). The dynamics of changes in an enterprise's environment dictate the pace of the changes in the enterprise.

A. Osterwalder and Y. Pigneur [3] have suggested approaching the environment analysis as a *design space* to see the context where the new or changed business model should function. Therefore, they proposed to base the environment analysis on four factors, that is on (1) forces influencing the market, (2) forces present in the industry, (3) the most important trends, and (4) macroeconomic forces. The forces influencing the market are characterized by way of market segments, needs and expectations, market problems, costs of change, and by way of revenue attractiveness. The forces influencing the industry are suppliers and other elements of the value chain, stakeholders, present and prospective competitors, and substitution products and services. The key trends are characterized by way of technological, regulatory, social, and cultural trends, as well as social and economic trends. The fourth category, meaning macroeconomic forces, is analyzed through global market conditions, capital markets, economic infrastructure, as well as goods and other resources.

The approach proposed by A. Osterwalder and Y. Pigneur is similar to the concept of the integrated model (process) of management that treats the enterprise as a whole and not as a set of various functions and presents a new manner of organizing its future, with the use of the term of a system, as well as system properties and relations [20]. It is not a common approach, and due to the type of managers' reactivity, four models of proceeding [18] towards the new situation of the enterprise can be distinguished. The first model is the so-called *passive enterprise*, where no reaction to the occurring situation can be observed. It results from both the lack of knowledge of the changes taking place, as well as from the lack of faith in their stability, and the expectation that the situation will change back. The consequences of such a type of activity are the loss of competitiveness, greater distance from the position of leader, or even bankruptcy.

The second model is the so-called *reactive enterprise*, where the reaction to the changes taking place in the environment can be observed, but these are often delayed reactions resulting from a specific forced change (such as a change of law or market changes). The third type is the so-called *proactive enterprise*, where the future is predicted, and even trend forecasts are prepared, meaning its reaction to change is the fastest. However, all types of enterprises, be it passive, reactive, or proactive, depend on changes in the environment. The fourth type differs from the previous weak reactions to the environment as it independently shapes its environment with the use of its own resources. These are *active enterprises*, which are the leaders when it comes to market participation, political links, or innovation [18].

2.2. Interorganizational Relations

A modern creation of mutual relations between enterprises functioning on a specific market is often based on building an interorganizational network. H. Håkansson and D. Ford [21] claimed that the terms *relation* and *network* has become inseparable in the business dialect between enterprise managers. C.M. Hall [22] defines *network* as an interorganizational cooperation agreement. In subsequent works, he cited the advantages and disadvantages of using such a cooperation concept. Even though he stated that using economic and business solutions cannot be applied in the case of complex sectors with varied structures [23], he still considered network cooperation to be of greater effectiveness, quality, and end value offered to the customer.

In the literature, one can also stumble upon network participant typology [24]. The participants (also defined as network actors) take on specific roles, characterizing their functions in the network. One of the roles is the role of an architect, who establishes the initial network and is the creator of mechanisms responsible for its durability, establishing cooperation rules and the roles of specific network participants. Another role is the role of a watchman, who acts as a mediator in case of conflict and misunderstanding. There is also a broker who coordinates the whole enterprise.

Their mutual market relations can vary. Literature [25] names the following:

- Bureaucratic relations, where the linking elements are orders adopted and binding standards and procedures;
- Economic relations, where the linking elements are material and financial transactions;
- Operational relations, where the links between the entities are common activities, collective decision-making, and use of shared resources;
- Cultural relations, where the relationship is based on shared values and a community of opportunities and threats;
- Information relations based on access to, exchange, and sharing of information in the process of establishing the relationship.

Characteristic features of the network are dominating hubs, and their status results from the relations between the remaining network actors. D. Delporte-Vermeiren, P. Vervest, and E. Van Heck [26] indicated that the description of specific network hubs should take place from the point of view of relations that can be noted between its participants (actors). The quantification of these relations is three points of view: a consistency perspective (defined as the number, variety, and density of relations between the hubs), a combination potential perspective (meaning the size and variety of network peaks), and an activation manner perspective (defining the scope of creation of new relations between the network actors) [25]. One must remember, however, that the relations in the networks are often based on the cooperation agreement, but not every actor is directly linked with other network participants. In such a case, we are dealing with indirect links [27].

Entities functioning on a specific market (also, spa markets) can be subject to the networking process. This is made possible thanks to the characteristics of network hubs, that is the ability to establish mutual relations based on knowledge and resource flows, mutual legal and capital independence, the freedom to make a decision to enter or leave the network, activities synergy, possibility to implement both shared and individual objectives, the possibility of modular interaction, the ability to learn from other network actors and to use innovation through teamwork, mutual communication, and complementary character, as well as the ability to enter into risky relations [28]. However, it is worth noting that if the network is created by independent entities, then it can be difficult or even impossible to manage [29]. Therefore, quite often, the process stops at its coordination stage, even though this is also not a widely accepted opinion [30,31]. Irrespective of the adopted terminology, the manner in which the cooperation within the network is carried out and its effectiveness depend on managerial, steering, executive, and coordinating activities [32].

Network coordination is a dynamics of sorts that takes place in interorganizational networks linking various entities, such as public and private entities and natural persons [33]. The literature names four approaches to network governance [34]. These are such issues as *good/corporate governance*, *new public management/market governance*, *multilevel governance/intergovernmental relations*, and *network governance*. Coordination in an interorganizational network is a complex process, as it depends on the interaction between, quite often, different entities of varied strategic goals that are in a situation where they need to coordinate their activities by taking into account the objectives of other network participants.

P. Perri et al. [35] noticed that the coordination depends on such factors as network symmetry, internal structure, institutional form, adopted and dominating styles of learning, type of business activity, and tasks implemented within the network. The factors threatening network stability are

the lack of trust, too great a dependence on partners' activities, high complexity, and difficulty of processes implemented together with partners, different levels of absorption abilities concerning competences and skills [33].

An interesting approach to roles within the network is presented by J. Child and D. Faulkener [36], who identify dominated networks with a significant asymmetry of forces (they named them *kingdoms*) and partners' agreements with equal positions (*republics*). In the dominated networks, the nature of threats for the cooperation depends on the position occupied by a given entity—central or peripheral. For the latter, the threats are excessive dependency on partners and the risk of loss of independence [37], the risk of unequal use of opportunities offered by networks [38], and the risk of loss of flexibility at the individual level [39]. In the case of peer-to-peer networks, there is a risk of opportunism [38], stagnation in unfavorable relations, hindered forecasting of network development, and lower management control [39].

J. Lichtarski [4] proposed to divide the cooperation relations into two types: A and B. The first-type relations (A) are present when the cooperation is based on mutual complementation of entities—one is able to render a service, and the other expresses a demand for such service and is willing to be its recipient. The second-type relations (B) take place when two entities combine their forces (shared activities and shared resources) to achieve a common goal. In this work, the emphasis is put, in the majority, on the first-type relation (A), while type B is characterized by the use of the identified example of a spa enterprise network.

2.3. Public Law Networks in Health Resort Enterprise

It can be noted that on the health resort services market, entities belonging to the private, public, and sometimes also to nongovernmental sectors can be found. In such a case, the network will be characterized by the features of the cooperation network being built, taking into account the public law network. Such networks abstain from traditional separation of the public sphere from the private sphere, focusing its activities on the size of actors in the network and their engagement in order to achieve common goals [40]. On the spa market, one can observe mutual relations between spa enterprises, self-government units (the spa commune representing the local community), as well as suppliers and institutional recipients of spa services and research institutions (in the domain of medicine). The literature analysis indicated that the public law relations, observed within the network, have the following characteristics [41]:

- they are created by independent entities, where at least one is subject to public law;
- their objective is the shared implementation of public interest (it is also possible to generate profit by private entities);
- there are learning processes, based on a mutual adaptation of network participants to one another;
- their participants are independent entities that voluntarily participate in the network;
- *relational rent* is proof of the effectiveness of the implementation of tasks of public character.

It must be noted that networks established within the spa business are of a mixed character, covering both public and private entities. The motivation of the latter to join the network is to generate greater profits. The public entities, on the other hand, implement, first of all, public interest goals (in this case, objectives of the public health). Therefore, it is important to adopt an approach combining the perspective of private networks (cooperation networks from the point of view of entrepreneurs) with the perspective of public networks.

S. Goldsmith and W.D. Eggers [42] pointed out the features differentiating these approaches. They applied both to the goal and to the importance of relational rent in the carried-out business, as well as to the cooperation effect or the cooperation horizon, the implementation goals and mutual trust. Thus, when it comes to the purpose of the activity, public networks are oriented towards the implementation of public interest, while, in private networks, the individual interest is the dominating one. Relational rent in public networks is the effectiveness measure, while for private

networks, it is a source of competitive advantage. This also determines the shape of the cooperation effect, which, in public networks, is more difficult to define than in the case of private networks. What unites these two types of networks is the declared importance of trust, which in private networks, more often than not, is limited, as well as the long-term time horizon of activity and objective implementation, where private networks quite often agree to the implementation of short-term objectives. Within the objectives of particular entities belonging to a public network, a low level of compatibility can be observed, as opposed to private networks.

The research carried out by D. Dredge [43] indicates that the network approach, in the case of tourism, is characterized by four advantages. The networks take into account the variety of solutions in tourism, and that these problems are often solved by different communities. The network approach recognizes the fuzzy division of tasks between the private and public sectors and allows them to view tourism as multidimensional space, well-fitted into the rules of shared interest of these two groups. Networks make it possible for various levels of political support for various problems to be present, which, at the same time, differentiate the levels of attention paid to different problems. Network stakeholders can also be participants of other networks, and thus the level of their influence, roles, interactions, and functions in the network can change.

In the process of coordination of networks in tourism, three basic models of conduct can be identified [44]. It can be a network managed by a self-governing unit (e.g., council, government), a network managed by their participants (self-coordinating), or a network managed by a local tourist organization, although, in the case of health resorts, the dominant health insurer can be an informal coordinator.

The Good Governance Advisory Group [45] indicates that good coordination depends, first of all, on the actors of the network and groups associated with the network, their aspirations, and shared values, as well as the decisions made within the responsibility, transparency, participation, communication, knowledge sharing, efficiency, and fairness. The local tourist network coordination effectiveness in achieving goals depends on the effectiveness of structures and institutional processes, relation resources, and available skills [46–48].

In case of sustainable tourism carried out by health resorts, coordination of mutual intrasectoral relations, directed towards the protection of natural resources at the same time as maintaining the right to carry out one's business, is one of the most difficult issues when it comes to determining the shared values of entities belonging to that network.

3. Materials and Methods

The analysis of relations between the entities functioning on the spa services market required both theoretical and empirical studies. The theoretical research allowed us to identify the rules of the function of health resort enterprises. It allowed us to identify basic processes of value proposal creation for the customer and value captured by the enterprise. In turn, the empirical research allowed the analysis of the health resort enterprise environment and their mutual business relations. It must, however, be specified that the analysis was not aimed to assess these relations. It served only to show the structure of mutual relations between entities on the spa services market.

The research directed towards the analysis of health resort enterprise business processes and their relations with other entities functioning within this market was carried out in 2018 in 17 of the largest spa enterprises in Poland. The research was carried out by way of indepth interviews with enterprise managers carrying out tourist and therapeutic activities. In the research, a survey questionnaire that characterized the business model structure and market relations was used. The enterprises under analysis were selected from the list of health resort facilities developed and shared by the Ministry of Health by the Republic of Poland. The selection criteria were the largest health resort facilities, having, in total, 33% share on the health resort market in Poland, carrying out their activity in 95 facilities (spa and spa hospitals), and constituting 36% of all such facilities in Poland.

The designed survey questionnaire consisted of 26 items divided by two topics—business models with market relations and health resorts business activity. In the first part of the questionnaire, 18 questions were posed, characterizing the business model structure, considering the CANVAS nine-element model ((1) customers' segment, being the axis of each business model; (2) proposals of values for selected customers' segments; (3) communication channels between the defined elements; (4) relations with customers; (5) revenue streams; (6) key resources, (7) key activities; (8) key partners; (9) cost structure, meaning all the costs related to the execution of the defined business model) and intrasectoral relations. The second pool of questions was concerned with issues associated with the tourist and health resort business activities carried out and market relations resulting from these activities. This made it possible to describe the health resort environment and to visualize the relations occurring in the health resort environment and other entities functioning within this market.

4. Results and Discussion

The theoretical research carried out within the literature of the subject and documents governing the rules of providing health resort services and health tourism services in health resort enterprises, as well as empirical studies over the business model of 17 of the largest health tourism enterprises in Poland point to a complex structure of mutual market relations. It is associated mostly with the complexity of the process of providing value for patients. This complexity results from the necessity to reconcile both social goals within the public health initiatives implemented by the spa treatment and economic goals. An important partner of health resort enterprises is usually the national health insurer, which is the key service purchaser. This complexity also results from spa product creation process complexity that can be based on multiple therapeutic raw materials that depend on health resort localization (mineral water, brines, thermal springs, peat, seawater, salt, and therapeutic properties of the climate). The complexity of spa products is enhanced by its mixed service nature, covering both treatment and tourist services, as well as hotels, transport, catering, and even cosmetic services.

4.1. Using the Business Model and Characteristics of Selected Model Elements

The empirical studies allowed us to not only to assess the key relations with customers and partners in the environment and recipients' segments, but also the usability of business models associated with the forces of influence of the environment.

The observations made during indepth interviews with health resort enterprise managers indicated that the managers of 5 out of the 17 studied spa enterprises declared that they know and use business models when running their health resort business. However, when the research was deepened in this scope, it turned out that the actual knowledge of business models was scarce and, in general, it referred to their abstract understanding, but without textual or graphic representation, of linked model architecture structures or services that the enterprise was offering. Nonetheless, every third manager taking part in the study had a description concerning particular elements of the business being carried out. In general, the components that underwent modeling were key activities, market segments, communication channels, and customer relations. However, no concise characteristics of business model components were observed; for example, in the form of a detailed description of value proposals for the customer.

The interviews carried out in health resort enterprises proved that, currently, three main segments of recipients of spa services can be identified. Managers of health resort facilities named primarily:

- the segment of institutional recipients (contract);
- the segment of individual recipients (commercial);
- the segment of business recipients.

The first—*segment of institutional recipients* (also known as contract recipients)—is a group of leading health and social insurers, including National Health Fund (NFZ), Social Insurance Institution (ZUS), Farmers' Social Security Fund (KRUS), and State Fund for Rehabilitation of People with Disabilities

(PFRON). These insurers sign contracts for health resort services. Beneficiaries of such services are persons insured by these funds, who, once such a need is requested and justified by a general practitioner and then by a balneologist, receive such services in a specified order. A characteristic feature of this market segment is the fact that a direct recipient of health resort services is not the direct payer of the acquired services. It means that the institutional recipient, when acquiring the package of health resort services, does not benefit from it but becomes a holder of such a service.

As it results from the interviews carried out on health resort facilities, from the perspective of health resorts, contracts with insurers are characterized by a low level of profitability due to the adopted contracting criteria. In general, what is decisive is the low price of services, which determines the low attractiveness of stay and limited selection of offered natural therapy treatments. However, the low profitability of contracts does not limit the willingness to win them as, in general, revenues generated thanks to these contracts cover the day-to-day operating costs and ensure stability and possibility of carrying out business activity in other sectors. The source of additional revenue is servicing the second segment of health resort service recipients, being the *individual recipients*. This is a segment of patients that pay for the stay in the health resort themselves.

The research also indicated that contract and individual recipient groups are key market segments of Polish spa enterprises. Contract patients constitute, on average, $69.9\% \pm 13.5\%$ of serviced beneficiaries, $23.2\% \pm 11.9\%$ are national individual patients, and $7.5\% \pm 7.9\%$ are foreign patients (due to the fact that they pay for their stay themselves, they are classified as individual customers).

Some health resort enterprises generate the greatest profitability from the segment of *business recipients*. These stays, however, are incidental. This is the most complex segment as it covers stays of varying nature—from corporate team building and recreational trips for employees of a particular facility to industry conferences and special tourist or sports events.

The most important sources of revenue of health resort enterprises are the revenue on hotel activity (accommodation) and treatment services in the form of balneology and physical medicine treatments. Next, categories of revenue cover gastronomy and sale of resources, being at the enterprise's disposal, and then the rental of the premises. The revenues from spa and wellness services and activities of the health resort clinic come next. This structure of revenue sources indicates how important it is for a spa company to maintain lasting relationships with clients in the individual market segments.

Maintaining good relations with loyal customers is one of the basic tasks of every entrepreneur, as it is the level of these relations that quite often decides the profitability and survival of the enterprise on the market. This is also the case for health resorts, although not every patient is treated the same. This results from the fact that contract patients cannot influence the price of offered services (including the service quality) as the direct payer of the benefits is the insurer (who is, in general, guided by the price criterion). Since the return of the contract patient to the facility also does not depend on them, the relations between the personnel and the contract patients are of lesser importance for the service providers in the enterprise than the relations with individual and business customers.

Segments of individual and business customers are the target ones in terms of building positive relations, as this relation should result in the return of the customer to the facility, or at least in positive feedback on the received services via word-of-mouth marketing among potential patients, carried out by the current patients.

The analysis of health resort enterprise activities indicated that the main partners of health resort enterprises are entities, the cooperation with which provides the enterprise with value to capture. The state health and social insurers are of greatest importance, as they make it possible for health resort facilities to make profits on contract implementation. Travel agencies also benefit from individual customers traveling to reach the health resort enterprises.

Just as important as a partner is the spa commune, meaning the self-government administering the health resort, which is responsible for the maintenance of health resort status and caring for the quality of health resort assets (e.g., parks, pump rooms, graduation towers). The commune authorities influence the attractiveness of the health resort as a place of health resort treatment

and an area of tourist attractions, which is also important for the perception of the health resort offer and the reception of the whole treatment. It is such an important partner that its importance exceeds the importance of key suppliers.

The role of key partners is also played by the suppliers of natural resources, competitors, with whom they cooperate on the basis of competition, outsourcing companies, and advertising agencies. In one facility, it was stated that volunteers are also important partners.

4.2. The Four-Factor Approach to Design Space Analysis of Business Model

Using the four-factor approach to *design space* analysis of A. Osterwalder and Y. Pigneur [3], in the analysis of the health resort enterprise environment, the following forces were subject to assessment: (1) forces influencing the market, (2) forces present in the industry, (3) the most important trends, and (4) general economic forces (Figure 1).

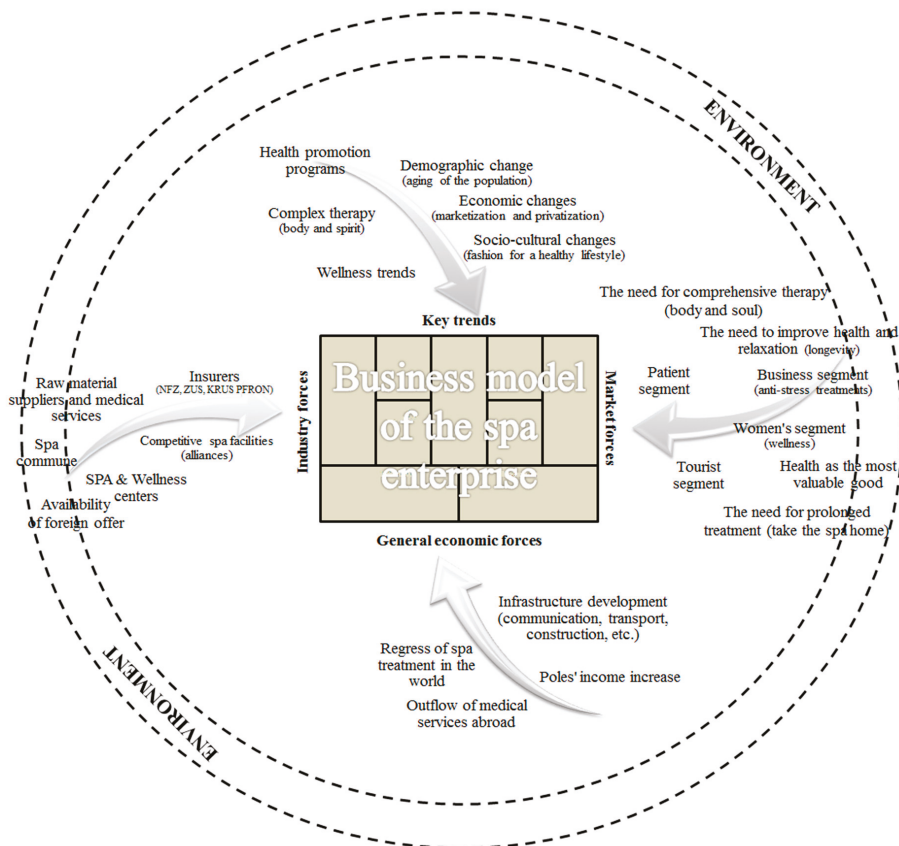

Figure 1. Environmental impact forces on the business model of a spa enterprise. Source: own study.

4.2.1. Key Trends of Health Resort Market

The first group of factors of the environment that influences health resort enterprises, which will be subject to characterization, are key market trends, within which the market segments, needs and expectations, market problems, changes costs, and revenue attractiveness were identified.

New trends that emerged in the health resort market are the factors that have allowed for the rebirth of health resort business activity in the past two decades. Nevertheless, this category is also associated with problematic factors for the whole community.

In this category, several main problems can be named. One of them is demographic changes, especially the aging of society and the associated low fertility rates. It is an extremely crucial factor that influences the offer of Polish spas. Statistics indicate that Poland has one of the lowest fertility rates (1.3) [49]. It also means that the natural generation renewal cannot be observed and that Polish society, or rather European society, is aging at a fast rate. There are a growing number of people of a postworking age, as compared with the number of people of working and preworking ages. These changes also result in greater demand for services associated with the needs requested by the segment of the elderly. These are mostly services associated with health and physical conditions, as well as all forms of spending free time with people of similar characteristics (e.g., seniors, widowers and widows, lonely people).

The influence of the named changes on the market of health resort services is significant as these are seniors who are the main group of recipients of these services, and the forecasted increase in the number of elderly should translate into the increase of the number of beds available in health resorts [50]. It is not, however, obvious, as the example of privatization of multiple health resorts indicates that political activity may squander the development opportunity of a promising market.

Nevertheless, it must be remembered that, along with the aging of Polish society, the change of trends concerning the care of one's body among younger generations must be noted. Therefore, the growth rate for the demand for health services can be greater than the growth of the number of elderly in society.

The second factor is the social and cultural changes that, in the context of public health, take on the characteristics of a healthy lifestyle trend. A manifestation of such attitudes is the more and more frequent rejection of mass products and looking for those created for individual needs. More and more often, it is not the price that is the basic criterion when it comes to making a decision to buy therapeutic goods and services, but the effectiveness and durability of the therapy effect. The increase in society revenues has made it possible to increase the standard of living of the poorest people. Along with growing revenues, the demand for services meeting higher-order needs also increases. The therapeutic treatment, although it refers to human health, is not a so-called bare necessity. It is a complementation of hospitalization, therapy carried out by general practitioner or specialist, and sometimes it has an entirely prophylactic character, as a manner of health prevention.

The healthy lifestyle trend is also manifested in the growing popularity of sports facilities and initiatives on the side of local self-government to build open-air gyms financed by way of participatory budgets. What can also be observed is the growing number of spa and wellness centers (especially in health resorts), as well as shops with so-called organic food. More and more often, consumers are choosing more expensive products of higher quality that better meet the demand of society.

Another factor is economic changes linked with the marketization of health resort business activity and changes in ownership. The reform of state health care facilities, including health resort facilities, carried out in Poland in the 1990s, resulted in a radical change in the situation of these entities. State health resort enterprises, so far fully financed from the state budget, were faced with the necessity of independent fund-raising to finance their activity. The health resort services were still financed from social funds but were acquired on the basis of tenders, where the criterion was the lowest price. This resulted in a decrease in the quality of health resort services (the quality of accommodation, catering) and, at the same time, limited the availability of treatment financed by the state. This phenomenon resulted in a new segment of recipients of health resort services, being patients agreeing to undergo fully-paid therapy.

The ownership changes mentioned before, which took place in the years 2005–2016 in the health resort sector, resulted in the almost complete resale of state health resort companies. Part of the sold enterprises

became the property of other state companies, becoming their additional activity. As a consequence of the marketization of health resort enterprises, the willingness to implement social goals decreased for economic goals, as currently in health resort facilities, it is more profitable to accommodate patients who pay for their stay themselves than patients referred for therapy by the insurers.

Another factor that influences the business relations model in health resorts is health programs financed by the local government units and government, as well as government policy associated with the preventive medicine of Poles. All activities promoting a healthy lifestyle can raise awareness on preventive medicine and reduce the possibility of premature death. Contact with nature in a natural environment and staying away from work and everyday life is one of the best ways to combat modern-age diseases.

One of the most important influencing factors is the observed trends of biological and spiritual renewal (spa and wellness). More and more often, offering therapy that combines a stay at a spa has a specific mental impact that can be observed. These are services covering complex activities in the scope of individual needs of the patient, not only in the sphere of treatment but also in the sphere of relaxation directed towards psycho-physical balance. Rest in a place that fosters relaxation is complemented with cosmetic services, rehabilitation, and relaxation classes (especially relaxation techniques having their sources in Eastern cultures).

The influence of these trends on the model of mutual relations between the entities of this sector can be linked with the necessity to propose additional offers in health resort enterprises in the scope of services improving the mental state of the patients (spiritual exercises, relaxation techniques, and cosmetic services). Even though these are not services directly linked with health resort treatment, it is perhaps worth considering the so-called *hybrid therapies* complementing traditional health resort therapy, with services regulating psychological and physical balance.

4.2.2. Forces of the Health Resort Industry

In the case of forces of the health resort industry, an important element influencing the relations in health resort enterprises is the influence of state health and social insurers, meaning the National Health Fund (NFZ), the Social Insurance Institution (ZUS), the Farmers' Social Security Fund (KRUS), and the State Fund for Rehabilitation of People with Disabilities (PFRON). The strength of their influence results from their role as an administrator of funds, having their source in the state budget. These are, in general, the main recipients of health resort services in Polish health resorts. They play the role of a payer for the health resort services on behalf of the patient, as the contributions paid by the patient to the state budget are administered by the insurers who, when the need to use the health resort therapy arises, cover the costs of the patient's stay in part or in whole.

It can, therefore, be stated that even though state insurers are not the direct beneficiaries of health resort services, often they act as a payer and contractor, ordering the benefits by being in direct contact with health resort enterprises. It is worth emphasizing that the maintenance of traditional balneology and rehabilitation medicine is possible mainly thanks to the contracts signed with state insurers, as this is still the main source of financing of natural therapy treatments and stays in spas and spa hospitals.

Another group of key contractors of health resort enterprises is the suppliers of natural medical raw materials and the medical employees responsible for therapy at the facility. It must be stated that both the suppliers and medical services can form a part of the health resort facility, yet in the majority of cases, these are separate economic entities, with whom constant cooperation is concluded. These entities, for example, deliver peat, brines, and mineral waters or provide specific therapeutic services (for example, physical exercises in the pool). As such, they play the role of one of the key partners of the health resort enterprise.

Another factor that influences the industry forces is the spa commune and its administration. This results from the fact that, in Polish law, a health resort is a territorial area being administered by local authorities. This is the spa commune that submits the request to the state to be granted the status of a health resort, as well as creating and financing the health resort survey that is the basis

of the request to be granted such a status. The spa commune is also responsible for determining and supervising the health resort spheres, taking care of health resort assets (health resort park, graduation towers, pump rooms), and collecting local tax from the guests coming to the health resort (tourists and patients). The spa commune administration is responsible for many control and coordination obligations, associated with the implementation of the provisions of the Act of 28 July 2005, on health resort treatment, health resorts and areas of health resort protection, and spa communes (Journal of Laws 2005, no. 167, item 1399 [6]).

Influence on the health resort sector is also associated with the presence of health resort competitors. These are not only entities providing substitution services, but also direct competition in the industry, meaning other health resort facilities functioning in the same or neighboring health resort.

Even though the approach to the described model is universal—applying, in general, to health resort enterprises and not to a specific enterprise—one must also take into account this competitive surrounding. The entities rendering the same or similar services in the same or neighboring area can undertake varied forms of cooperation (cooperation, competition) or focus on their own specialization and attempt to differentiate themselves from the competition.

In some health resorts, it can be noticed that one health resort or a complex of health resorts with one management dominates, and, in some cases, the market is divided between scarce entities of a similar influence. There are also such health resorts areas where only one health resort is present (that does not have a direct competition). The influence of the competition on the business model of a specific entity in each of these cases will be different and must be analyzed separately.

One of the substitution competitors is facilities and centers offering spa and wellness services, meaning services within the health and wellness-oriented stays. These facilities aim to integrate the physical, psychological, and spiritual spheres of a person using these services in order to achieve a balance in the natural and social environments [51].

Due to the implemented business activity profile, these facilities do not use health resort therapy (balneology and rehabilitation) and more often reach for unconventional therapeutic methods, in general, complementing the health resort offer.

A direct competitor of the health resort facilities is also the tourist facilities located in the health resort as they render similar services as the health resort enterprises. They do not have a natural therapy base, but they use the available therapy services with the cooperation of the health resort.

4.2.3. Forces of the Health Resort Market

The health resort market, being a part of a healthcare market, has varied forces of influence on the business model associated with segments of recipients and the needs voiced by them. The health resort market is based on the need to restore or maintain the health of the patients, but its main parts are also nonmedical services rendered for the guests staying in the health resorts for various specific purposes. These services benefit the health and recreational (tourist) objectives, as well those associated with the specific specialization of the health resort product.

One of the needs voiced in health resorts and spa and wellness facilities is the need for hybrid therapy (covering with its scope the body and soul). This therapy has already been mentioned when discussing the present therapeutic trends. It is a form of health resort product that combines therapy influencing the body with treatments referring to the mental and spiritual states of the person visiting the facility. Therapeutic treatments concerning the body are mostly rehabilitation and balneology. Treatments concerning the mental and spiritual states can cover many forms of more or less intensive influence (e.g., visits to salt grottos, consultation or psychotherapy, meditation exercises, relaxation techniques, and prayers).

Some needs of the patients result from their desire to live their lives in good psycho-physical conditions. Thus, their needs are not based on the current situation, but rather take into consideration the distant future. Therefore, they have a preventative character, with reference to old age. Other needs result from the desire to extend the health resort therapy at home by continuing some therapeutic

methods. It is strictly associated with another task of the health resort therapy, where, apart from treatments, they should provide health education.

All the mentioned human needs are supported by the philosophy that states that human health is the most precious physical good that a man can have and that it is not constant. Therefore, it requires care in order to be maintained as long as possible. Along with the needs that emerge on the health resort market, it is also worth attempting to identify basic market segments. Apart from the already mentioned division of recipients (institutional, individual, and business), other divisions can also be identified. They most often result from the age criteria, dividing recipients of services into seniors (65+) and other patients (younger than 65 years old). Still, this division, although necessary, is also insufficient, as, within the identified age groups, subgroups with varied characteristics can be named. Taking into account the changes in the offer directed towards younger market segments, the age criterion should be made more specific. It is, therefore, proposed to distinguish the recipients of health resort services, also taking into account the typology criterion, which is associated, for example, with the manner of how the treatment is financed, what the objective of the stay is, and if the patient needs to make use of specialist programs.

The first criterion of segmentation should be the age of patients (for example, 65 +) as, in the times of aging society, this group of recipients will significantly increase the market potential. However, when it comes to the remaining part of the society (up to the age of 65), it is worth identifying additional segments of specific needs. One such market segment is, undoubtedly, the segment of children and youth (up to the age of 18), for whom special offers and even health resorts' profiles are prepared (an example of a children's health resort is Rabka Zdrój). Another age segment consists of patients over 40 years old, who, during and after their intensive career or as a result of everyday hardships, feel the need to rest in a place where one can regenerate.

One of the basic methods of dividing patients, apart from age, is the already described division into individual patients (who pay for the stay themselves) and contract patients (institutional ones), meaning beneficiaries of health resort treatments paid by the insurer. A subgroup of patients that pay for their stay themselves, although less numerous than the group of contract patients, is the most profitable group. This group encompasses foreign patients. What is characteristic for this group of recipients is the fact that they are the decision-makers when it comes to the place, time, and duration of the treatment. This is not the case for the contract subgroup, which goes to the place of treatment indicated by the insurer and balneologist for a specific period (21 days) and at the time dictated by the insurer (in general, taking into account the queue managed by the insurer).

Another division is focused on the segment of tourists, who are not accommodated in the spas and spa hospitals, but elsewhere (guest houses, hotels, family), but they use the treatments offered by the natural therapy facility under the supervision of balneologists. Such a stay can cover both the treatments financed by the health insurer (within outpatient treatment), as well as treatments financed independently by their beneficiary. This group is neither subject to the health resort regime nor to medical and nurses' supervision in the place of accommodation.

It is worth mentioning that there are two other main segments of recipients. First is the segment of women using beauty and relaxation treatments. In this case, the health resort therapy serves mostly treatments of cosmetic and relaxation purposes and, by the way, also health purposes. There is no inconsistency with the objective of health resort function, as many treatments offered by natural therapy facilities are also treatments not only with health properties but also influencing body care (pearl baths, brine baths).

Another group of recipients is the segment concerning the needs of businessmen, both in the aspect of entrepreneurs, managers, as well as authorities, who, burdened with stress, feel the need for antistress therapy. In this segment, employees can also be found, where, as a reward for their work, they are sent to relax in a health resort.

One can name many other segments of the health resort market of lesser importance and influence on the business model. These can be individual or group recipients for whom a special offer

was prepared, for example, a stay for mental support groups within health resort therapy (for war veterans, pregnant women, mothers with children) or training camps for biological renewal.

4.2.4. General Economic Forces

The influence of the forces discussed so far (industry, market, and trends) can be complemented with general economic influence concerning the remaining aspects of the environment. In this case, factors and phenomena that can influence the business model structure were taken into account. One such factor is undoubtedly the HR situation in healthcare and, especially, the lack of specialist doctors [52]. The lack of necessary medical staff can decrease the quality of services and, in some cases, even limit the ability to render health resort services. In a spa business at a health resort, it is necessary to have specialization in balneology and rehabilitation.

In addition, worth noticing is the phenomenon of health resort treatment regress globally. There is a limited number of state health care systems that consider health resort treatment to be an integral part of it (as is the case in Poland [6]). In the majority of countries, traditional balneology treatments are often an element complementing the stay in spa cities and facilities and even on mobile health resorts (ships) [53]. This is not the case in Europe, where traditional health resort treatment, based on minerals and health properties of the climate, is still developing [54], expanding the scope of benefits.

An important factor is the development of health resort infrastructure and nonhealth resort infrastructure (communication, transport, buildings). It concerns the availability of health resort services, which are specific services offered only in health resorts, that need to be accessed individually to make use of the therapy. This is a factor that has both positive and negative influences on the health resorts: the development of infrastructure positively influences the business, but it is not always beneficial for the natural environment. At the same time, quite often, this factor becomes an obstacle associated with the excess of infrastructure and excess of critical levels of capacity and tourist absorption of the spa area, after which health resort degradation and the degradation of tourist and health functions take place [55].

The increase of revenues, especially in the group of the poorest, opens new possibilities for the health resorts. These are health resorts that are often a place of relaxation and treatment for those with the lowest income (retirement pension and pension holders, unemployed), as they can make use of accommodation that is financed from public funds. It is also quite often a challenge, as this segment is often not aware of the possibility of making use of the, so far, unattainable health benefits and holiday services. Additional revenues also mean the extension of the scope and number of communication channels with potential patients (for example, the Internet). It undoubtedly has an influence on business processes, especially in the scope of segments, channels, and streams of revenue.

The last factor of influence on health resort activity is the law that governs the functioning of health resorts and, in general, the functioning of tourist enterprises and areas. This is, however, an issue that varies depending on a country.

The performed analysis of health resort enterprises and their environment has made it possible to characterize the mechanisms and business relations concerning the health resort sector. The complementation of the analyses is the graphic model of business relations in the health resort environment. In the scope of relations of the first type, where the cooperation model is present, being about entities that complement one another, the business relations model was presented in the form developed by the Board of Innovation [16]. It can be seen in Figure 2.

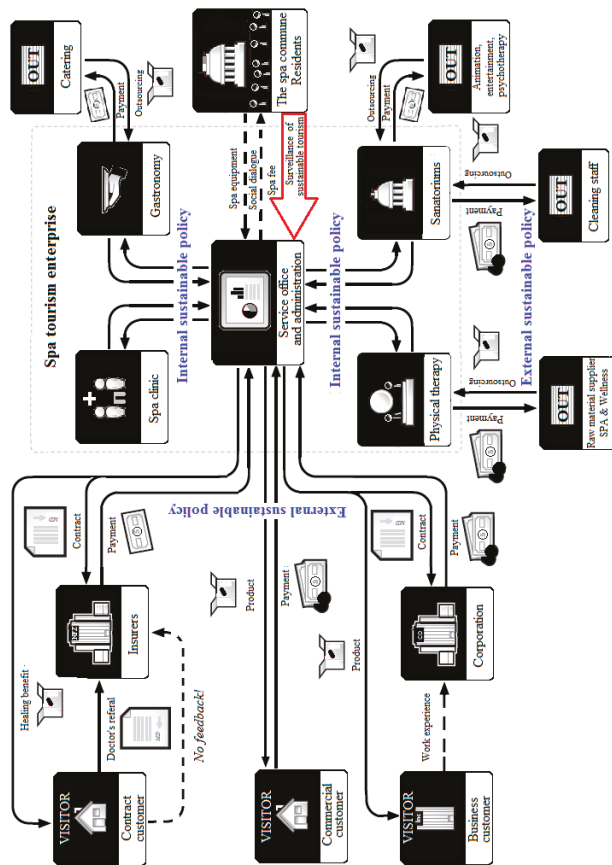

Figure 2. Model of health resort enterprise relations in its environment. Source: own study.

The relations shown in Figure 2 are based on the business objectives of particular entities, but it is also worth indicating their links with the objectives of sustainable tourism. In modern times, it becomes necessary to develop sustainable policy in the scope of implementation of sustainable development rules. In the case of health resorts, these rules should be defined separately for internal relations of business model elements and separately for external relations focusing on local cooperation. The internal sustainable policy should take into account as criteria proposed by the Global Sustainable Tourism Council (GSTC) [5] in the scope of proecological behaviors, in particular, concerning economic use of natural resources (both used for health resort treatment and for other purposes) and reduction of pollution (gas emission, transport, water, and electric energy), as well as combating the results of overtourism, overpopulation, and excess infrastructure. The internal sustainable policy should also cover the education of behaviors that protect the natural environment and local culture, directed towards the recipients of health resort services. It is one of the missions of socioeconomic entities, carried out to increase the responsibility for the health resort and cultural resources of the commune being visited, and for the place where the patient functions every day.

The external sustainable policy should be based on providing information on the implemented practices within the internal sustainable policy, encouraging people to undertake and maintain proecological behaviors among suppliers and contractors, and even among competitors.

During field research, carried out in Polish health resorts, what was also identified were the interorganizational networks of the second type, where the entities combine forces within a joint effort and resource sharing in order to achieve a common goal. Several such networks were identified among Polish health resort enterprises. The greatest network is composed of several health resorts named Polska Grupa Uzdrowisk (PGU) (Poland, Wrocław, 2-8 W. Sikorskiego Street) [56]. It is a company established on the basis of business relations of five health resort enterprises: Uzdrowisko Cieplice Grupa PGU, Uzdrowisko Połczyn Grupa PGU, Uzdrowisko Świeradów-Czerniawa Grupa PGU, Uzdrowiska Kłodzkie Grupa PGU, and Interferie Medical Spa. The owner of this network is KGHM Polska Miedź I Fundusz Inwestycyjny Zamknięty Aktywów Niepublicznych (First Closed Investment Fund of Non-Public Assets) (Poland, Lublin, 48 M. Skłodowskiej-Curie Street), which focuses its activity on protecting health in health resorts and on promoting leisure activity. According to the information of the owner of KGHM TFI, the long-term strategy of the development of PGU [56], adopted at the beginning of 2015, resulted in an increase in the financial results of health resort companies belonging to PGU. This is due to the adopted investment policy that assumes a constant increase of hotel infrastructure standard and the standard of treatment equipment, as well as due to the development policy associated with extending the institutional contracts and effective winning of customers from the country and abroad, who pay for their stays themselves.

The interorganizational network of this type is based on slightly different relations than the ones present in Figure 2. Therefore, it will be a subject for further studies. This is also an area that the author considers to be a base for further analyses, this time of an interorganizational nature, based on the rules of competition of competitors functioning in separate territories.

5. Summary

Research conducted with the managers of the largest spa tourism facilities in Poland has shown that business relationships are mainly built there with three groups of entities. The first group consists of clients from three market segments with different impacts on corporate income. These relationships depend on whether the recipient is also a payer of spa services or only the beneficiary of services financed by the insurer. Secondly, relationships are built with the closest contractors (e.g., suppliers of medicinal raw materials, centers that perform spa treatments, or catering outlets). The third entity to build relationships with is local government units that affect the perception of the spa area by tourists; in crisis situations, they become the main disposer of spa treatment facilities.

It is worth noting that the environment of health resorts is characterized by multiple factors influencing the structural elements of their business models and relations taking place in these environments. It is, in particular, linked with the presented social influences in the form of changing expectations of recipients of health resort services, the trend of healthy lifestyles, relaxation, and destressing, as well as the influence of competition and insurers and even changes taking place in the economy. Each of the discussed factors influences enterprise activity, even though the force of influence may differ. The analysis of mutual relations of health resort enterprises and the interdependent entities makes it possible to order the processes and to modify the mutual relations in a situation when it is necessary to adapt to changes in the environment. It can, therefore, increase the ability of the enterprise to benefit from changes taking place in the environment and to flexibly introduce changes to its function in relation to the environment.

The considerations concerning the forces of influence of the health resort environment and elements comprising health resort enterprise business models are characteristic of the business relations model on this market. An important issue resulting from the business relations presented here is the separation of sustainable policy that covers the introduction and maintenance of proecological and proclultural activities in the health resort area. The author hopes that the health resort enterprises will adopt the sustainable business and natural environment policies for mutual benefits and that they will encourage such practices among their contractors and recipients.

It should also be admitted that due to the complexity of the research problem, the weakness of the research is the lack of possibility to develop precise guidelines for spa companies. Each enterprise should take into account individual assumptions for modeling relations with the environment and indicate which business relations are key from its own perspective. Individual criteria for assessing market relations will be an important element of the strategy of each enterprise.

It is worth considering what these criteria will be. Economic perturbations and the crisis associated with the spread of the SARS-CoV-2 virus at the beginning of 2020 [57–59] have shown how important relationships between cooperating companies in the same market are. Entrepreneurs have recognized that the sustainability of mutual relations may be the only chance to survive the global crisis, especially in tourism.

This view of the research problem undertaken in the article suggests that intrasectoral relationships should also be based on building mutual trust, especially in crisis situations. The business models of spa companies should develop relationships with clients and entities with whom they cooperate on the market, but also with the state, through cooperation with local government units. An eloquent example is the situation during the COVID-19 pandemic, when all Polish spa tourism enterprises became a reserved resource in the event of overcrowding of hospitals. Despite the dismissal of the threat of overcrowding in hospitals where coronavirus patients were treated, places in Polish spa facilities were used for health prevention and quarantined persons. It seems that such practices in the future may be a good solution for maintaining health safety and should be a topic more often undertaken in future research.

Funding: This research received funding from the National Science Center in Poland.

Acknowledgments: This paper was published as part of the research project “A business model for health resort enterprises” No. 2017/25/B/HSS4/00301, supervised and financed by the National Science Center in Poland and as part of statutory research ROZ 1: 13/010/BK_20/0042 at the Silesian University of Technology, Faculty of Organization and Management.

Conflicts of Interest: The author declares no conflict of interest. The funders had no role in the design of the study; in the collection, analyses, or interpretation of data; in the writing of the manuscript, or in the decision to publish the results.

References

1. Butler, R.W.; Szromek, A.R. Incorporating the Value Proposition for Society with Business Models of Health Tourism Enterprises. *Sustainability* **2019**, *11*, 6711. [CrossRef]
2. Khair, Q.; Saeed, M.M. Different ways of synergistic effects of human resource management (HRM) practices on organizational performance: A method of 2 + 2 = 5. *Afr. J. Bus. Manag.* **2011**, *5*, 8610–8616.
3. Osterwalder, A.; Pigneur, Y. *Business Model Generation: A Handbook for Visionaries, Game Changers, and Challengers, Paperback*; John Wiley and Sons: Hoboken, NJ, USA, 2010; pp. 204–214.
4. Lichtarski, J. Współpraca przedsiębiorstwa z innymi podmiotami gospodarczymi. In *Podstawy Nauki o Przedsiębiorstwie*; Lichtarski, J., Ed.; AE we Wrocławiu: Wrocław, Poland, 2007; pp. 420–421.
5. GSTC, Global Sustainable Tourism Council. GSTC Criteria for Hotels. GSTC Criteria for Tour Operators. GSTC Criteria for Destinations. 2019. Available online: <http://www.gstccouncil.org/gstc-criteria/> (accessed on 1 August 2019).
6. Journal of Laws, The Act of 28 July 2005 on spa treatment, spas and spa protection areas, and on spa municipalities (Dz.U. 2005 r. Nr 167, poz. 1399).
7. Magretta, J. Why Business Models Matter? *Harvard Business Review*, 1 May 2002; 86–92.
8. Battistella, C.; Toni, A.; Zan, G.; Pessot, E. Cultivating business model agility through focused capabilities: A multiple case study. *J. Bus. Res.* **2017**, *73*, 65–82. [CrossRef]
9. Wit, B. *Ekologistyka w Systemie Zarządzania Odpadami Niebezpiecznymi*; Towarzystwo Naukowe Organizacji i Kierowania. Stowarzyszenie Wyższej użyteczności Dom Organizatora: Toruń, Poland, 2016; p. 138.
10. Oskam, I.; Bossink, B.; Man, A.P. The interaction between network ties and business modeling: Case studies of sustainability-oriented innovations. *J. Clean. Prod.* **2018**, *177*, 555–566. [CrossRef]

11. Tong, X.; Tao, D.; Lifset, R. Varieties of business models for post-consumer recycling in China. *J. Clean. Prod.* **2018**, *170*, 665–673. [CrossRef]
12. Rossignoli, F.; Lionzo, A. Network impact on business models for sustainability: Case study in the energy sector. *J. Clean. Prod.* **2018**, *182*, 694–704. [CrossRef]
13. Teece, D. Business models and dynamic capabilities. *Long Range Plan.* **2017**, *51*, 40–49. [CrossRef]
14. Foss, N.J.; Saebi, T. Business models and business model innovation: Between wicked and paradigmatic problems. *Long Range Plan.* **2018**, *51*, 9–21. [CrossRef]
15. Prendeville, S.; Bocken, N. Sustainable Business Models through Service Design. *Procedia Manuf.* **2017**, *8*, 292–299. [CrossRef]
16. Board of Innovation, THE INNOVATION MATRIX; 15 Companies You Should Copy. Business Models Visualized by @boardofinno; 50+ Business Models You Should Copy Today, Board of Innovation. Available online: www.boardofinnovation.com (accessed on 19 October 2018).
17. Oblój, K. *Strategia Organizacji*; PWE: Warszawa, Poland, 2001; p. 12.
18. Nogalski, B. Modele biznesu jako narzędzia reorientacji strategicznej przedsiębiorstw. *Master Bus. Adm.* **2009**, *17*, 3–14.
19. Porter, M. *Strategia konkurencji. Metody analizy sektorów i konkurentów*; PWE: Warszawa, Poland, 2000; p. 23.
20. Penc, J. *Decyzje i Zmiany w Organizacji*; Difin: Warszawa, Poland, 2007; p. 72.
21. Håkansson, H.; Ford, D. How should companies interact in business networks? *J. Bus. Res.* **2002**, *55*, 133–139. [CrossRef]
22. Hall, C.M. Rethinking collaboration and partnership: A public policy perspective. *J. Sustain. Tour.* **1999**, *7*, 274–289. [CrossRef]
23. Hall, C.M.; Page, S.J. Progress in tourism management: From the geography of tourism to geographies of tourism—A review. *Tour. Manag.* **2009**, *30*, 3–16. [CrossRef]
24. Stabryłwa, A.; Wawak, S. *Metody Badania i Modele Rozwoju Organizacji, Encyklopedia Zarządzania*; Mfiles.pl: Kraków, Poland, 2012.
25. Strategor. *Zarządzanie Firmą. Strategie, Struktury, Decyzje, Tożsamość*; PWE: Warszawa, Poland, 1995; p. 392.
26. Delporte-Vermeiren, D.; Vervest, P.; Van Heck, E. In search of margin for business networks: The European patent o_ce. *Eur. Manag. J.* **2004**, *22*, 167–182. [CrossRef]
27. Gomes-Cassers, B. Group versus group: How alliance networks compete. *Harv. Bus. Rev.* **1994**, *72*, 62–66.
28. Czakon, W. *Dynamika Węzi Międzyorganizacyjnych Przedsiębiorstwa*; Uniwersytet Ekonomiczny w Katowicach: Katowice, Poland, 2007; p. 163.
29. Parvinen, P.; Lukkari, P. Changing Healthcare Networks—Orchestrating Needed but Impossible? 2007. Available online: www.impgroup.org/uploads/papers/5922.pdf (accessed on 20 April 2017).
30. Bryant, J. *The Six Dilemmas of Collaboration. Interorganisational Relationships as Drama*; John Wiley & Sons: West Sussex, UK, 2003; pp. 187–207.
31. Möller, K.; Svahn, S. Managing Strategic Nets: A Capability Perspective. *Mark. Theory* **2003**, *3*, 201–226. [CrossRef]
32. Kale, P.; Dyer, J.H.; Singh, H. Alliance capability, stock market response and long-term alliance success: The role of the alliance function. *Strat. Manag. J.* **2002**, *23*, 747–767. [CrossRef]
33. Powell, W.W.; Koput, K.W.; Smith-Doerr, L. Interorganizational collaboration and the locus of innovation: Networks of learning in biotechnology. *Adm. Sci. Q.* **1996**, *41*, 116–145. [CrossRef]
34. Klijn, E.H. Governance and Governance Networks in Europe. An Assessment of Ten Years of Research on the Theme. *Public Manag. Rev.* **2008**, *10*, 505–525. [CrossRef]
35. Perri, P.; Goodwin, N.; Peck, E.; Freeman, T. *Managing Networks of Twenty-First Century Organizations*; Palgrave Macmillan: Hampshire, UK, 2006; pp. 31–32.
36. Child, J.; Faulkner, D. *Strategies of Co-operation. Managing Alliances, Networks and Joint Venture*; Oxford University Press: Oxford, UK, 1998; p. 120.
37. Dryl, T. Organizacja sieciowa. In *Koncepcje Zarządzania. Podręcznik Akademicki*; Czernska, M., Szpitter, A., Eds.; C.H. Beck: Warszawa, Poland, 2010; p. 256.
38. Stańczyk-Hugiet, E.; Sus, A. Konsekwencje przynależności do sieci. In *Sieci Międzyorganizacyjne. Współczesne Wyzwanie dla Teorii i Praktyki Zarządzania*; Niemczyk, J., Stańczyk-Hugiet, E., Jasiński, B., Eds.; C.H. Beck: Warszawa, Poland, 2012; pp. 92–94.

39. Sroka, W. Korzyści i zagrożenia uczestnictwa w sieci aliansów—Analiza porównawcza. *Przegląd Organ.* **2010**, *1*, 29–30. [CrossRef]
40. Kjaer, A.M. *Rządzenie*; Wyd. Sic!: Warszawa, Poland, 2007; p. 13.
41. Niemczyk, J.; Stańczyk-Hugiet, E.; Jasiński, B. (Eds.) *Sieci Międzyorganizacyjne, Współczesne Wyzwanie dla Teorii i Praktyki Zarządzania*; C.H. Beck: Warszawa, Poland, 2012; p. 181.
42. Goldsmith, S.; Eggers, W.D. *Governing by Network*; Brooking Institution Press: Washington, DC, USA, 2004.
43. Dredge, D. Policy networks and the local organization of tourism. *Tour. Manag.* **2006**, *27*, 269–280. [CrossRef]
44. Dredge, D. Local tourism governance: A comparison of three network approaches. *J. Sustain. Tour.* **2010**, *18*, 7–28.
45. Good Governance Advisory Group. *Good Governance Guide: The Principles of Good Government within Local Government*; The Municipal Association of Victoria: Melbourne, Australia, 2004.
46. Bell, S. “Appropriate” policy knowledge, and institutional and governance implications. *Aust. J. Public Adm.* **2004**, *63*, 22–28. [CrossRef]
47. Halley, P. Transforming governance: Challenges of institutional adaptation and a new politics of space. *Eur. Plan. J.* **2006**, *14*, 299–320. [CrossRef]
48. White, L. Effective governance through complexity thinking and management science. *Syst. Res. Behav. Sci.* **2001**, *18*, 241–257. [CrossRef]
49. Szromek, A.R. Changes in the management model of health care institutions in health resorts in the context of social and economic changes in the years 1989–2018. *Health Prim. Care* **2018**, *2*. [CrossRef]
50. Szromek, A.R. *Działalność Turystyczno-Lecznicza Zakładów Lecznictwa Uzdrawiskowego. Transformacja Działalności Przedsiębiorstw Uzdrawiskowych w Latach 1989–2010*; Proksenia: Kraków, Poland, 2011; pp. 69–83.
51. Myers, J.; Sweeney, T.; Witmer, J. The Wheel of Wellness counseling for wellness: A holistic model for treatment planning. *J. Couns. Dev.* **2000**, *78*, 251–266. [CrossRef]
52. Krajewski-Siuda, K.; Szromek, A.R.; Romaniuk, P. Emigration preferences and plans among medical students in Poland. *Hum. Resour. Health Springer* **2011**, *10*, 8–12. [CrossRef]
53. Spivack, S.E. Health spa development in the US: A burgeoning component of sport tourism. *J. Vacat. Mark.* **1998**, *4*, 65–77. [CrossRef]
54. Somkeatkun, W.; Wongsurawat, W. Perceptions of the Spa Industry: An Importance Performance Analysis. *J. Qual. Assur. Hosp. Tour.* **2017**, *18*, 416–436. [CrossRef]
55. Butler, R.W. The Concept of the Tourism Area Cycle Evolution: Implications for Management of Resources. *Can. Geogr.* **1980**, *24*, 5–12. [CrossRef]
56. Polska Grupa Uzdrawisk. Polska Grupa Uzdrawisk w Trendzie Wzrostowym. Available online: <http://tfi.kghm.pl/polska-grupa-uzdrawisk-w-trendzie-wzrostowym/> (accessed on 16 July 2018).
57. Sigala, M. Tourism and COVID-19: Impacts and implications for advancing and resetting industry and research. *J. Bus. Res.* **2020**. [CrossRef]
58. Naeen, M.; Che Suraya, Z. Religious tourism and mass religious gatherings—The potential link in the spread of COVID-19. Current perspective and future implications. *Travel Med. Infect. Dis.* **2020**, 101786. [CrossRef]
59. Zenker, S.; Kock, F. The coronavirus pandemic—A critical discussion of a tourism research agenda. *Tour. Manag.* **2020**, *81*, 104164. [CrossRef] [PubMed]



© 2020 by the author. Licensee MDPI, Basel, Switzerland. This article is an open access article distributed under the terms and conditions of the Creative Commons Attribution (CC BY) license (<http://creativecommons.org/licenses/by/4.0/>).

Article

Incorporating the Value Proposition for Society with Business Models of Health Tourism Enterprises

Richard W. Butler ¹ and Adam R. Szromek ^{2,*}

¹ Department of Hospitality and Tourism Management, University of Strathclyde, 16 Richmond Street, Glasgow G1 1XQ, Scotland, UK; r.butler2@btinternet.com

² Department of Organization and Management, Institute of Economy and Informatics, Silesian University of Technology, Akademicka 2A, 44-100 Gliwice, Poland

* Correspondence: innowator@o2.pl; Tel.: +48-32-277-7336

Received: 12 November 2019; Accepted: 25 November 2019; Published: 27 November 2019

Abstract: This article discusses the need to expand the concept of the value proposition, in order that this business model component includes the value for a customer, the value captured by the enterprise, and the value for the community, as well as benefits for the natural environment. The objective of the article is to identify sustainable development components that have been proposed for tourist enterprises in the research literature. The article proposes actions to complement existing tourist enterprises business models in order to give them the characteristics of a sustainable business model and to implement practices of value creation for the community. The research notes that the value captured by an enterprise determines the level of implementation of its economic objectives resulting from the value creation for the customer and implementation of social objectives (including pro-ecologic ones). The revenues of an enterprise depend, first of all, on meeting the expectations of the customer, meaning that they depend on the value proposition for the customer, and their volume will allow researchers to determine the possibility of creating value for the community. The expected tendency to create value for the community is argued to be proportional to the effectiveness of customer value influence, less the value captured by the enterprise. After an initial review of relevant literature, attention is focused on health tourism enterprises and how these principals can be applied in that context.

Keywords: sustainability; health resorts; spa tourism; business model

1. Introduction

The 19th and 20th centuries brought about progress in the form of intense industrialization. Impressive inventions, achievements, and solutions in the field of technology were the result of industrial development, but inevitably, technological development resulted not only in increased amenities for humanity, but also often impacted negatively upon the natural environment. This degradation has been observed for decades, for example in the levels of pollution and rises in global temperature and has raised social awareness of the consequences of industrialization and the costs the future generations will have to bear.

Modern enterprises, often still based on the consumption of natural resources and thus interfering in the environment in an indirect way, need to participate in the process of restoring natural resources or at least undertaking activities that reduce any degradation. However, for such revitalization activities to be carried out consistently and effectively, they need to be included in the basic structure of business processes. This argument applies equally to tourist enterprises and the article proceeds by reviewing the sustainable development literature to identify key elements that need to become essential elements in business models and processes.

The above goal was achieved through theoretical and empirical research. The source of the elements of sustainable tourism proposed and discussed in the article include literature studies, documents of agencies working for sustainable development, and qualitative research of authors, carried out in the 17 largest spa tourism enterprises in Poland. The main contribution of the presented research is to identify elements of sustainable tourism that are necessary in the current situation. The proposed solutions have been formulated to support managers of spa enterprises, both for achieving their competitive advantage as well as for protecting the natural environment and the culture of residents of tourist destinations.

2. Literature Review

2.1. Health Tourism and Health Resort Enterprises in Poland

Goodrich and Goodrich [1] define health tourism as an attempt to attract tourists through tourist facilities or areas in order to provide them with above-standard services (i.e., healthcare and providing appropriate equipment). Thus, health tourism contains a composition of three elements: A trip away from home, health as the main motivation for arrival, and a stay in holiday destinations (especially in spas) [2].

One of the forms of health tourism is tourism carried out in health resorts. Spa tourism is a stay in a spa, aimed at maintaining or improving the current state of health by isolating oneself from harmful factors of everyday life, and by physical and mental rest, using spa treatment methods and other forms of beneficial effects on health. In Poland and in many other European countries, health resorts are where therapeutic services (in the field of balneology and physical medicine) are provided as part of a tourist stay. It is also a tourist form, which is closest to the idea of sustainable development, due to the close relationship with the impact of the natural environment on tourists [3].

The history of health tourism organized in Poland had variable directions. In the second half of the 20th century, the predominant (and quite often the only) goal of health resort facilities was the social objective concerning the implementation of the state health promotion initiatives, which was possible because the health resort services were fully financed by the state budget [3,4]. However, the economic transformation in 1989 (associated with the fall of communism in Eastern European countries) led to the transformation of the state spa sector into private spa tourism companies [5].

These transformations, both in the national health system as well as changes in the ownership structure of health resort enterprises, made it necessary to change the way in which their activity was perceived. Polish health resort enterprises became, first of all, profit-oriented entities and only later became entities that worked to implement goals of implementing the state health policy [6].

In addition, Van Tubergen and Van Der Linden [7] and Erfurt-Cooper and Cooper [8] note that the current spa activity goes beyond the use of bathing in thermal waters for therapeutic purposes. This is noticeable in the spa tourism market in the form of various types of tourist and non-tourist services. The value for the customer that a spa company provides is not only standard treatment and prophylaxis (massages, hydrotherapy, physical exercises, and fitness), but also personalized health and fitness programs, cosmetics and care treatments, hairdressing, and manicure and pedicure services. Thus, the value proposition for the customer is expanding, as well as the value captured by the company.

2.2. Overview of Business Model Concept

A *business model* is a characteristic of the business being described in the form of a story that explains how the enterprise works [9] and, at the same time, a description of relations between components in an organization that result in creation of value for the organization [10]. In many cases, the business model is a tool used to run the business [11]. The literature also describes the business model as a conceptual tool that contains a set of elements and their relationships and allows expressing the business logic of a specific firm. [12]. At the same time, it is a description of values that the enterprise is able to provide to market segments, and a description of the organization, along with

network relations with partners to also create value. Teece [11] also sees it as a tool that can be used in practice for the purpose of design or description of the architecture of the creation, supply, and value capturing mechanisms of a business. The core of the business model is in defining the way in which the enterprise captures value for customers, entices them to pay for this value, and converts payables into profits.

Prendeville and Bocken [13] also view a business model in terms of a tool, using it to order business transactions between customers, partners, and suppliers and the organization, and their participation in the development and capturing of value.

Al.-Debei et al. [14] propose the business model as an abstract concept, where it is a textual or graphic representation of the interrelated structures of the model's architecture prepared by the organization, along with all the products and services that the organization has on offer and that are essential to achieving its aims.

One of the most comprehensive definitions was prepared by Wit [15], who states that the essence of a business model is the visual depiction of an organization's functioning logic, its elements, or ventures in the form of appropriately named, interlinked elements of a template that—once populated with content—ensure the logical understanding of the process of functioning, survival, and development of the organization.

The literature provides numerous other ways of defining business models, including those listed below:

- The CANVAS model [12], which takes into account nine interconnected and interacting business components that describe both the key processes and their interrelations.
- Cube business model [16–18] is a concept that establishes business model components in the form of a cube, selecting particular components in such a way to eliminate unnecessary ones and promote the crucial ones; the value proposal is thus created on the basis of a value chain with key and supporting functions
- Value network [19] is a methodology of modeling the business model that visualizes the business activities and sets of relations of the whole system from a dynamic perspective; it contains unique analysis methods, as well as integrating with other modeling tools, dealing with elements such as processes, social networks analysis, and system dynamics;
- *e³-value* [20] is an interdisciplinary approach based on studying an innovative idea by a thorough understanding of that idea and assessment of its potential profitability; this methodology uses an engineering approach with the use of terms and terminology sourced from economics, marketing, and axiology; it shows how to model business processes and to improve the business in complex value constellations of multiple entities that are common in e-commerce;
- Possession-ownership-availability (POA) [21] is a method used to model business processes focusing on providing value appropriate for Enterprise Resource Planning (ERP) systems and IT system designing; POA model defines specific roles in business process and describes value provision;
- Other alternative business model frameworks include lean startup (lean canvas) [22], four-factor *Seizing the Whitespace* by Johnson [23,24], a five-element template by Afuah [25] (VARIM—*Value, Adaptability, Rareness, Inimitability, Monetization*), a six-element template in the form of a circle (Business Model Institute) [26], six-factor *Open Innovation* by Chesbrough [27,28], six-element template by Seidenstricker, Scheuerle, Linder [29], six-element model of key values by McGrath [30], a seven-block template by Lindgren (*Value proposition, Target users and customer, Value chain, Competences, Network, Relations(s), Value formula Profit formula* [16,17], a 10-element template by Doleski [31] (*Normative Framework, Value, Strategy, Customer, Market, Revenue, Enablers, Processes, Partners, Finance*), a 13-element model of social business [32], and others.

The literature on this subject provides a varied division of the business model into specific components and proposes a varied model architecture. It is impossible to provide one universal

division. The most popular concept of the business model division into components is the one proposed by Osterwalder and Pigneur [12], who identified nine model components. Apart from value proposition, it contains market segments, distribution channels, relationships with the customers, revenue streams, key resources, key activities, key partnership, and costs structure. It is worth noting that one element that is found in almost all models is the proposed value, around which other model components are integrated. The *value proposition* is a major reason that customers prefer the offer of a given company as well; it is a solution to problems of customers and an element ensuring satisfaction of their needs. In the marketing context, the value proposition can be compared with the core of tourist product, meaning the core of the benefit that a tourist gains by using a specific tourist service [33]. In the scientific literature, the concept of customer value is identified with the concept of Porter's value chain [34]. However, this is not the only value generated by business activity, because the *value captured by the enterprise* is also important for managers.

2.3. Business Models Used by Tourist Enterprises

The nature and presence of business models in tourist enterprises still seem to be insufficiently researched. Due to the recent increasing popularity of this concept, its essence is still being modified and developed. However, with the emergence of special versions of the models, their limitations must be taken into account. A review of the tourist literature reveals that research on business models was almost exclusively limited to specific types of tourist activities [35,36]. An example is the research carried out in spa tourism [37]. Their results are generally positive, as they noted that the use of business models in the analyzed enterprises was incidental and fragmentary, and that the knowledge in this field referred to abstract understanding of business models, without the ability to present the interrelated architecture structures of the model with the use of text or graphics.

Another interesting scientific publication is the article by Reinhold et al. [38] on the subject of a typology of business models for destination management organizations. The authors identify four distinct ideal types of DMO (destination management organizations) business models (these are the destination factory, destination service center, value orchestrator, and value enabler).

It is also worth paying attention to the important article Reinhold, Beritelli, and Grünig [39], in which the authors identify a minimal consensus and dominant approach to conceptualizing the business model concept in tourism studies. The article reveals a strong preference for small-n case study research designs.

One of the key publications on sustainable business models is the article by Joyce and Paquin [40]. They note (after Collins and Porras [41]) that for sustainability-oriented companies, creating social value is likely a clear part of their mission. They present the triple-layer business model canvas tool, which contributes to sustainable business model research by providing a design tool, which structures sustainability issues in business model innovation. Their research extends the original business model canvas by adding two layers: An environmental layer based on a lifecycle perspective and a social layer based on a stakeholder perspective. Boons and Lüdeke-Freund [42] find that research on sustainable innovation has tended to neglect the way in which firms need to combine a value proposition, the organization of the upstream and downstream value chain, and a financial model, in order to bring sustainability innovations to the market. They note that the current literature does not offer a general conceptual definition of sustainable business models. Therefore, they sketch the outline of a research agenda by formulating a number of guiding questions. Among them, they formulate a concept social profit equation and conclude, "sustainable business models enable social entrepreneurs to create social value and maximize social profit; of significance is the business models' ability to act as market device that helps in creating and further developing markets for innovations with a social purpose" (p. 17).

There is also a study on the value proposition in the form of a business model for cultural heritage tourist enterprises [43,44] and attempts to apply CANVAS with regard to entities operating in the market of health tourism [35].

Also noteworthy is the template proposed by Threebility—Tools for Sustainable Innovation as The Sustainable Business Model Canvas [45]. This template proposes an approach to the issue of generated value through the following questions:

- *Which problem do we solve and which value do we create?*
- *What is the function and form of our product or service?*
- *Can we solve our customers' problems more sustainably?*
- *Can we transform sustainability into customer value?*
- *Is ownership necessary or is the product as a service model applicable?*
- *Can we extend the product life cycle? [45]*

A majority of the analyzed research works focuses on particular components of business models, but only rarely focuses on the whole model. One can refer to the works of Bodenau [46], Cranmer, Jung, and Dieck [47], as well as Havemo [48] and Prebenseni Dahl [49], which have discussed the topic of the value proposition for a tourist.

In a related area, the work of Mantaguti and Mingotto [50] tackled the subject of relations with customers in the tourist market and Miguéns, Baggio, and Costa [51], as well as Inversini, Xiang, and Fesenmaier [52] discussed customer relations in social media in the business context.

Diaconu and Dutu [53] also paid attention to the evolution of the hotel industry towards innovative business models, while Langvinienė and DaunoraviPinjti [54] listed a number of factors that need to be taken into account when creating a business model that would be successful in the hospitality industry. Overall, compared to the very extensive literature on the nature, structure, and application of business models in general, the literature on business models used by tourism enterprises is still limited and very few papers indeed deal specifically with sustainability issues in a tourism business model context.

2.4. Sustainable Business Models in Tourism

Threats generated by tourism, and in particular the burdens caused by overtourism, affect both the area of tourist destinations and residents [55]. Since 2002, one can notice in the literature a specific set of business models [56]. These are sustainable business models, defined as a set of components where the interactions between these components and the stakeholders create, provide, capture, and list a sustainable value for many stakeholders [57]. It is, therefore, a recent development to include sustainable development principles in the company's value logic and the logic of value creation by an enterprise [58,59]. Sustainable business models can be a source of competitive advantage and economic benefits, by taking into account the sustainable value proposal in business model [60].

One of the key research works on this subject is an article by Nosratabadi et al. [55], who analyzed works from various thematic areas, concluding, that since 2016, "Environmental Science (18.6%)", "Business, Management, and Accounting (16.4%)", "Social Science (14.4%)", and "Engineering (12.3%)" are the fields in which the majority of uses of the concept of sustainable development were found. Analysis of works published in the years 2007–2018 reveals that the incorporation of sustainable development principles in business models is the topic discussed most often by researchers from the US, Great Britain, and China, with American researchers discussing this issue twice as often as the British and Chinese.

Among the 14 thematic areas analyzed by Nosratabadi et al. [55] was the issue of the hospitality industry. They noticed that studies on the sustainable development elements in business models in the hospitality industry were in the initial stage. A majority of the analyzed research projects examined the level of sustainable development in hotels but stopped at the stage of current status diagnosis. No solutions for the further development of sustainable business models for this industry as a whole were provided.

Research on business models, analyzed in the context of sustainable development, allowed the introduction of the subject of transforming the enterprise business model into a sustainable one. In the

last decade, one can notice both research discussing this issue, as well as policy and strategy documents of organizations that transform such solutions into specific proposals.

One such work is the article by Boons and Lüdeke-Freund [42], who identified four features that lead to the introduction of sustainable development rules in the element of the business model.

One is the extension of the value proposition in the business model. The value proposition provides measurable ecological and/or social values in concert with economic value (being based on socio-economic dialogue concerning the balance of economic, ecological, and social needs) reflecting the fact that such values are temporally and spatially determined).

The second feature relates to expanding the responsibility for the natural environment. The supply chain involves suppliers who take responsibility towards their own, as well as the focal company's stakeholders. The company does not shift its own socio-ecological burdens to its suppliers, but actively engages suppliers into sustainable supply chain management.

The third feature is cooperation with consumers, whereby the organization–customer interface motivates customers to take responsibility for their consumption, as well as the focal company's stakeholders.

The last feature is the division of costs and benefits resulting from the ecologic activity. The financial model reflects an appropriate distribution of economic costs and benefits among actors involved in the business model and accounts for the company's ecological and social impacts.

The implementation of the above elements is often associated with obstacles. In the literature, one can find many signs of such limitations. One example would be an attempt to influence the suppliers or to divide the financial burden of business changes [61].

Nosratabadi et al. [55] developed four approaches to designing a sustainable business model. These are:

- Designing a sustainable value proposition (values are achieved taking into account sustainable development practices);
- Designing sustainable value creation (value is achieved involving all stakeholders, including the community and natural environment);
- Designing sustainable value delivering (value is also provided in a sustainable manner);
- Generating sustainable partnership networks for creating and delivering such sustainable value, which simultaneously can meet the social, environmental, and economic benefits.

This proposed approach to creating a sustainable business model requires the establishment of numerous relationships. It applies not only to relations with customers, but also to creating partnerships with all involved stakeholders. Norris and West [62], and later Grefen [63], identified several market relations:

- B2C (*Business-to-Customer*), meaning a relation aimed at winning over individual customers by focusing the relationship on the direct recipient.
- B2B (*Business-to-Business*), meaning focusing the relationship development in the enterprise on other enterprises by focusing on group recipients (including wholesalers, contract recipients, and state recipients).
- B2A (*Business-to-Administration*), meaning using the transactions between the entrepreneurs and public administration bodies as a basis.
- C2B (*Customer-to-Business*), a relationship sometimes referred to as M-commerce (*Mobile Commerce*), in which the access to wireless devices is used, making it possible to carry out the transaction. It is a relationship based on the opportunity to make purchase offers to which the manufacturers can respond.
- C2C (*Customer-to-Customer*), meaning targeting the activities to the possibility of direct exchange of goods between the consumers.
- C2A (*Customer-to-Administration*), a relation between consumers and public administration.

- P2P (*Peer-to-Peer*) is the use of Internet in such a way as to make the direct exchange of data possible without the need to send them through the main server;
- B2R (*Business-to-Reseller*), is a relationship where the relational entities are entrepreneurs and resellers;
- G2B and G2C, where the government is one of the parties to the relationships with entrepreneurs and customers.

Creating relations in terms of a sustainable business model needs one more relation. This is a B2S relation, meaning *Business-to-Society*, whereby society becomes the beneficiary of values generated by the business, influencing the natural environment and the community. It is, therefore, an addition to the B2C relation, in which the beneficiary is the entity (individual customer) and not society. In practical terms, the values would not be the results of the manufactured goods and services, but the benefits of the practiced rules, programs, and investments limiting the dysfunctional activities and/or abolishing the degradation of natural resources. These would include all types of programs or campaigns for sustainable development in which the particular enterprise participates.

A very important statement in the discussion on the application of sustainable development rules that can be applied to tourism is the article by Siakwah, Musavengane, and Leonard [64], which is a reference to the sustainable development goals (SDG) and tasks that the tourism can implement in this context. The United Nations Development Program [65] promotes the sustainable development goals (SDGs), which represent a universal call to action to end poverty, protect the planet, and ensure that all people enjoy peace and prosperity. These 17 goals build on the successes of the millennium development goals, while including new areas, such as climate change, economic inequality, innovation, sustainable consumption, peace, and justice.

One of these objectives can be implemented within health tourism, as its aim is to ensure healthy lives and the promotion of wellbeing for all at all ages. As a consequence, good health and wellbeing can help achieve sustainable livelihoods.

Another important source of sustainable activities is the Global Sustainable Tourism Council (GSTC) criteria [66], which include four pillars: Sustainable management, socioeconomic impacts, cultural impacts, and environmental impacts (including consumption of resources, reducing pollution, and conserving biodiversity and landscapes). The GSTC criteria, formulated separately for hotels, tour operators, and tourist destinations, were established on the basis of numerous pro-ecological activities and experiences carried out in this context around the world, and take into account guidelines and standards concerning sustainable tourism from every continent. It is impossible to cite them all here, but it is appropriate to note that they were developed taking into account environmental, social, cultural, economic, quality, human rights, health, safety, risk, and crisis management issues and that they can support overall development.

The criteria are divided into four sections:

- Demonstrating effective sustainable management,
- Maximizing social and economic benefits to the local community and minimizing negative impacts,
- Maximizing benefits to cultural heritage and minimizing negative impacts,
- Maximizing benefits to the environment and minimizing negative impacts.

They were developed to ensure common global understanding of “sustainable tourism” and represent a minimum level to which every tourist enterprise should strive. The criteria indicate *what* needs to be done in terms of the achievement of sustainable tourism, but not *how* to implement it. The performance indicators complement those criteria and allow the determination of the level of implementation of set goals. In Table 1, the solutions proposed by the Council for the GSTC Hotel Criteria (Version 3, 21 December 2016) are presented.

Table 1. Global Sustainable Tourism Council (GSTC) hotel criteria (Version 3, 21 December 2016).

Demonstrate Effective Sustainable Management	Maximize Social and Economic Benefits to the Local Community and Minimize Negative Impacts	Maximize Benefits to Cultural Heritage and Minimize Negative Impacts	Maximize Benefits to the Environment and Minimize Negative Impacts
<p>A1. Sustainability management system</p> <p>The organization has implemented a long-term sustainability management system that is suitable to its size and scope, addresses environmental, social, cultural, economic, quality, human rights, health, safety, risk, and crisis management issues and drives continuous improvement.</p>	<p>B1. Community support</p> <p>The organization actively supports initiatives for local infrastructure and social community development. Examples of initiatives include education, training, health and sanitation and projects which address the impacts of climate change.</p>	<p>C1. Cultural interactions</p> <p>The organization follows good practice and locally agreed guidance for the management and promotion of visits to indigenous communities and culturally or historically sensitive sites in order to minimize adverse impacts and maximize local benefits and visitor fulfillment.</p>	<p>D1. Conserving resources</p> <p>The criterion includes:</p> <ul style="list-style-type: none"> • Environmentally preferable purchasing, • Efficient purchasing, • Energy conservation, • Water conservation.
<p>A2. Legal compliance</p> <p>The organization is in compliance with all applicable local, national, and international legislation and regulations including, among others, health, safety, labor and environmental aspects.</p>	<p>B2. Local employment</p> <p>Local residents are given equal opportunities for employment and advancement, including in management positions.</p>	<p>C2. Protecting cultural heritage</p> <p>The organization contributes to the protection, preservation and enhancement of local properties, sites and traditions of historical, archaeological, cultural, and spiritual significance and does not impede access to them by local residents.</p>	<p>D2. Reducing pollution</p> <p>The criterion includes:</p> <ul style="list-style-type: none"> • Greenhouse gas emissions • Transport (reducing transportation requirements), • Wastewater, • Solid waste, • Harmful substances, • Minimize pollution.
<p>A3. Reporting and communication</p> <p>The organization communicates its sustainability policy, actions, and performance to stakeholders, including customers, and seeks to engage their support.</p>	<p>B3. Local purchasing</p> <p>When purchasing and offering goods and services, the organization gives priority to local and fair-trade suppliers whenever these are available and of sufficient quality.</p>	<p>C3. Presenting culture and heritage</p> <p>The organization values and incorporates authentic elements of traditional and contemporary local culture in its operations, design, decoration, cuisine, or shops, while respecting the intellectual property rights of local communities.</p>	<p>D3. Conserving biodiversity, ecosystems, and landscapes</p> <p>The criterion includes:</p> <ul style="list-style-type: none"> • Biodiversity conservation, • Invasive species, • Visits to natural sites, • Wildlife interactions, • Animal welfare, • Wildlife harvesting and trade,

Table 1. *Cont.*

Demonstrate Effective Sustainable Management	Maximize Social and Economic Benefits to the Local Community and Minimize Negative Impacts	Maximize Benefits to Cultural Heritage and Minimize Negative Impacts	Maximize Benefits to the Environment and Minimize Negative Impacts
<p>A4. Staff engagement Staff are engaged with development and implementation of the sustainability management system and receive periodic guidance and training regarding their roles and responsibilities in its delivery.</p>	<p>B4. Local entrepreneurs The organization supports local entrepreneurs in the development and sale of sustainable products and services that are based on the area's nature, history, and culture.</p>	<p>C4. Artefacts Historical and archaeological artefacts are not sold, traded, or displayed, except as permitted by local and international law.</p>	
<p>A5. Customer experience Customer satisfaction, including aspects of sustainability, is monitored and corrective action taken.</p>	<p>B5. Exploitation and harassment The organization has implemented a policy against commercial, sexual or any other form of exploitation or harassment.</p>		
<p>A6. Accurate promotion Promotional materials and marketing communications are accurate and transparent with regard to the organization and its products and services, including sustainability claims. They do not promise more than is being delivered.</p>	<p>B6. Equal opportunity The organization offers employment opportunities, including in management positions, without discrimination by gender, race, religion, disability or in other ways.</p>		
<p>A7. Buildings and infrastructure Planning, siting, design, construction, renovation, operation and demolition of buildings and infrastructure.</p>	<p>B7. Decent work Labor rights are respected, a safe and secure working environment is provided, and employees are paid at least a living wage. Employees are offered regular training, experience, and opportunities for advancement.</p>		

Table 1. *Cont.*

Demonstrate Effective Sustainable Management	Maximize Social and Economic Benefits to the Local Community and Minimize Negative Impacts	Maximize Benefits to Cultural Heritage and Minimize Negative Impacts	Maximize Benefits to the Environment and Minimize Negative Impacts
<p>A8. Land water and property rights Acquisition by the organization of land and water rights and of property is legal, complies with local communal and indigenous rights, including their free, prior, and informed consent, and does not require involuntary resettlement.</p>	<p>B8. Community services The activities of the organization do not jeopardize the provision of basic services, such as food, water, energy, healthcare, or sanitation, to neighboring communities.</p>	-	-
<p>A9. Information and interpretation The organization provides information about and interpretation of the natural surroundings, local culture, and cultural heritage, as well as an explanation of appropriate behavior while visiting.</p>	<p>B9. Local livelihoods The activities of the organization do not adversely affect local access to livelihoods, including land and aquatic resource use, rights-of-way, transport, and housing.</p>	-	-

Source: [66].

The analysis of threats resulting from the ongoing dysfunctions of a business can be carried out in a highly customized manner, which varies depending on the nature of the determined influence. One can, however, note several topics that the literature proposes in the course of research and analysis. Some of them refer, in particular, to tourism activities. Liu [59], for example, proposed viewing the sustainable tourism issues from the perspective of six categories:

1. The role of tourism demand,
2. The nature of tourism resources,
3. The imperative of intra-generational equity,
4. The role of tourism in promoting sociocultural progress,
5. The measurement of sustainability,
6. Forms of sustainable development.

In 2018, these proposed solutions were corrected and supplemented. The provisions of the Cape Town Declaration on Responsible Tourism of 2018 [67] considered the objectives of sustainable tourism to be about minimizing negative economic, environmental, and social impacts; generating greater economic benefits for local people and enhancing the wellbeing of host communities (improving working conditions and access to the industry); involving local people in decisions that affected their lives and life chances; making positive contributions to the conservation of natural and cultural heritage and to the maintenance of the world's diversity; providing more enjoyable experiences for tourists through more meaningful connections with local people, as well as a greater understanding of local cultural, social, and environmental issues; providing access for physically challenged people; and strengthening individual culturally sensitivity by encouraging respect between tourists and hosts and building local pride and confidence.

3. Materials and Methods in the Context of Health Tourism Enterprises

To make an analysis of the value proposition that health tourism enterprises in particular currently provide, in-depth interviews were carried out among managers of 17 such enterprises in Poland in 2018. The objective of this research was to determine the applicability of various business models and determine the content of their components, in particular the value proposition in one aspect of health tourism, namely in spa tourism enterprises in Poland. This was undertaken on the basis of the CANVAS business model structure [12] discussed earlier.

The enterprises under analysis were selected from the list of health resort facilities developed and shared by the Ministry of Health by the Republic of Poland. The selection criteria were the largest health resorts that had a market share amounting to at least 33% of the overall health resort market in Poland. In the research, a survey questionnaire was used based on the business model structure. This research tool was developed according to the assumptions of the interview scenario. The basic idea was to allow some issues to be examined in more depth if necessary. It was therefore a semi-structured study.

The survey questionnaire contained 26 items, divided by topic (and is included in the annex to the paper). In the first part of the questionnaire, 18 questions were posed, characterizing the business model structure and each of the studied components. The second pool of questions concerned issues associated with the tourist and health resort business activity carried out and the sources of their financing. The survey questionnaire included many issues falling within the broad topic of business models, but consistent with the specific focus of this article, detailed considerations took into account only selected results of these studies. The authors focused exclusively on the value proposition in the business model, in particular the empirical research concerned only customer value and the value captured by the company. Conducting empirical research focused on these two categories of values. However, in the course of the literature research and review of the values generated by the surveyed enterprises, a third value emerged—this is a value that a tourist enterprise generates for society, both locally and globally.

In the statistical analysis of the obtained empirical data, both descriptive analysis as well as an advanced multi-dimension method were used. In this article, only one component is discussed, therefore the presentation of results is limited to quantification with the use of structure measurement subject to weighting. Analysis of the significance of specific model components was made by the use of a substantive feature indicator (Φ), that was developed on the basis of the structure indicator that later was subject to weighting with the use of ranks assigned by the managers to particular features.

4. Results of Research

The research revealed managers of almost one-third of the tourist enterprises declared that they knew and use business models when carrying out health resort operations (29.4%). The in-depth nature of the research concluded that the actual knowledge of business models in these enterprises was smaller than initially self-declared. A majority of managers declaring knowledge of business models had an abstract form in mind, without any text or graphics that represented the links between model architecture components.

In addition, no attempt was made to formally integrate all business model components on the basis of business model concepts found in literature. Only scarce attempts to integrate selected business model components were noted. It can be stated that the use of business models in analyzed enterprises therefore is incidental and fragmentary.

However, it was found that the enterprises examined held other documents that described the business activity, and these included the articles of association, rules, operational plans, investment business plans, and company strategies. Almost all of the enterprises had developed strategy for running their own business. It cannot be concluded, therefore, that no business models were found in the studied health tourism enterprises, as usually managers of these entities operated in a defined manner of activities organization in the form of procedure sets, key objectives, and plans for business activity at particular levels of management or within specific levels of functioning. However, this is not a complete business model, but a fragmentary elaboration on selected areas of the business activity being carried out.

When analyzing the value proposition that the health resort enterprises provide, every manager was asked to determine the value for the customer and value captured by the enterprise and then to indicate the three most important ones.

Enterprise managers identified the treatment effect; that is, the maintenance or improvement of the health of the patient to be the key benefit for the customer ($\Phi = 1.000$). Further indicated values included achieving the relaxing services effect, that is de-stressing of the patient, a sense of beauty, beauty improvement, a loss of body mass, an improvement of fitness and sport results ($\Phi = 0.824$), and a stay in comfortable conditions that is in a place of therapeutic climate properties ($\Phi = 0.824$). Quite high rated also was the socialization between the tourist and other patients ($\Phi = 0.706$), and a slightly higher rating was observed in case of the possibility to stay away from routine ($\Phi = 0.647$). Other indicated values for the consumer had lower significance ratings:

- Cognitive, cultural, and religious impressions obtained through various forms of culture (*additional services*) ($\Phi = 0.471$),
- Cognitive experiences and physical effort through tourism (*tourist services*) ($\Phi = 0.353$),
- Adventure, entertainment, trip, fulfilling holidays ($\Phi = 0.353$).

In the scope of values captured by the enterprises, the financial benefits dominated among the responses given. Managers taking part in the research sought primarily to make a profit from their business activity. An increase in profit was the objective indicated the most often placing it at the top of the list of leading objectives of the business activity ($\Phi = 1.000$). Almost as important were the increase of services sale ($\Phi = 0.970$) and increase in the numbers of commercial customers (those who pay for their stay independently) ($\Phi = 0.970$). Other values were significantly less popular, for example the

increase of contracts with insurers was rated at $\Phi = 0.626$. The remaining preferred benefits for the enterprise are presented in Table 2.

Table 2. Enterprise values from the health resort operations.

Value for the Enterprise Presented in the Form of Objectives Resulting from the Health Resort Activity	Φ
Increase of profit	1.000
Increasing the number of commercial customers	0.970
Increase of sale	0.970
Increasing the contracts with insurers	0.626
Increasing the number of beds/facilities	0.596
Increasing the assets of the enterprise	0.548
Survival of the enterprise	0.430

Source: Based on own study.

Therefore, the analysis of benefits expected from the business activity of these health resorts confirms a strong dominance of objectives directed towards profit by the enterprise managers, and an increase in the number of commercial customers (see additional details in [35]). Disappointingly, no activities that would benefit the local community were observed among the priorities.

During interviews with managers of spa companies, it was revealed that their business models do not take into account values for society. Managers undertake optimization actions aimed at eliminating waste of medicinal raw materials. However, this is not an element of the business model (even informally), but a business practice focused on limiting losses.

Therefore, key actions taken by managers of spa enterprises were analyzed. The actions of spa enterprises rated highest by managers (conducted in the scope of their basic activities) are mainly services related to accommodation ($\Phi = 1.000$), natural therapy treatments ($\Phi = 1.000$), catering services ($\Phi = 0.769$), programming of treatments ($\Phi = 0.769$), help of a dietitian, psychologist, and other specialists ($\Phi = 0.646$), and spa clinic services ($\Phi = 0.631$). In assessing the significance of individual activities (priority and additional) in spa enterprises, much lower scores were received for activities that could be described as investments in the development of society. These were conducting classes in health education ($\Phi = 0.600$), organizing cultural events ($\Phi = 0.449$), and conducting research and development activities ($\Phi = 0.415$). Most often, such activities were described as additional, rather than a priority.

The low awareness of managers regarding the value that an enterprise should generate for society is also an important argument for formulating a proposal for introducing such value for society into business models.

5. Discussion of a Sustainable Tourism Business Model

Based on the research results cited above, it is clear that the issue of considering activities based on sustainable development principles does not currently fall within the priorities of health resort tourism enterprises. The result is that there is not only the need to raise awareness of the managers about these issues, but also to give them inspiration and provide examples of the potential practical implementation of sustainable tourism principles in the health resort.

Managers need to be referred to the practice of creating sustainable business models of tourism enterprises. It seems that what would be logical in this case would be to start with the value proposition component and then to expand this key business model component through subsequent integrated components of business activity leading to a more sustainable tourist operation.

An extremely important change concerning current manager practice would be a change in the understanding of the value proposal. In the overall value proposal, such elements as a value proposal for the tourist, values captured by the enterprise, as well as a value proposal for the community (such

as natural environment protection) should be included. Therefore, it seems appropriate to divide the component defining the value proposal into these three categories.

The value proposal for the customer in the context of the sustainable development goals requires a definition of the benefits that a tourist will gain by having appropriate contact with nature and the cultural heritage of the local community in a favorable atmosphere with the local community and in comfortable conditions of tourist infrastructure. These are, therefore, elements that, once ensured for the guest, will make the realization of their goals possible. Due to their differentiation and sometimes even contradictory nature, it is impossible to identify universal elements of these components for every tourist enterprise because they can involve can implement recreational purposes, cognitive purposes, health purposes, and entertainment purposes, and sometimes even extreme experiences (such as stay just behind a front line during armed conflict or space travel). It seems, however, that the core of the benefits elements, resulting from sustainable tourism, is the improvement of tourist awareness on how precious the natural environment and the community and its cultural heritage are.

The value captured by an enterprise is not only about making a profit or increasing the scope of the targeted market, but also about other benefits resulting from the business activity being carried out. It is worth emphasizing, in this context, the ability to create a local tourist product, ensure satisfaction with providing services meeting the expectations of tourists, as well as contributing to the economic development of the local community and supporting its cultural heritage.

The value for the community includes the benefits of the business activity carried out by the enterprise that the local community receives in the economic, cultural, and ecological context. These benefits are, in general, those resulting from solving or alleviating current social problems, at both local and global levels. A crucial and easily discernible benefit for the local community would be a decrease in unemployment through the establishment of additional jobs. It could also reflect an emphasis on the identity of the region by way of organizing an exhibition of regional craft production and also by increasing the comfort of the stay and ease of travel, for example by reducing congestion of traffic. Less discernible benefits from pro-ecology activity could take the form of introducing regulations on water and energy saving, limiting traffic emissions, and encouraging suppliers to join programs limiting the degradation of natural environment.

A complete definition of value for all three groups of elements allows the determination of the subsequent model components. Taking into account the division of components used by Osterwalder and Pigneur [12], these will be key activities, meaning those activities that must be undertaken to achieve complex benefits. This, in turn, will also determine the selection of key partners in both the closer and more distant environments, the necessary resources, and the cost streams resulting from the value creation.

The values for the customers will also depend on such components as the serviced market segment; distribution channels; relationships with the customers; and even revenue streams. In turn, values for the community can strongly influence the selection and formulation of key activities undertaken by the enterprise in their policy of partner (especially suppliers) selection, the use of natural resources, and their cost streams, as well as the relationship with their customers in terms of pro-ecology behaviors and pro-community behaviors involving the local community.

The influence of social values on the revenue streams is long-term nature in nature. The time needed for the improvement of air quality or the regeneration of local culture will depend on the intensity and level of engagement in the introduction of sustainable tourism practices among all facilities in a defined area.

It must be noted, however, that the creation of these values (for the customers and the community) without reference to the value for the enterprise is impossible. The value captured by the enterprise determines the level of implementation of economic objectives resulting from the value creation for the customer and the implementation of social objectives (including pro-ecologic ones). The revenues of an enterprise depend, first of all, on the fact that the expectations of the customer are met, meaning

they depend on the value proposition for the customer, and their volume will allow the determination of the possibility of creating value for the community (Figure 1).

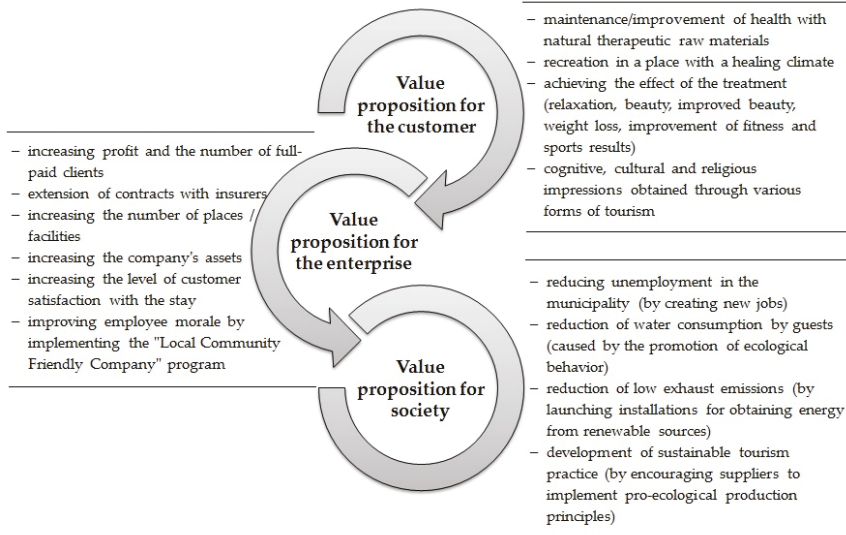

Figure 1. Value proposition of tourist tourism enterprises; source: Own study.

Figure 1 shows the postulated values that tourism companies should consider in their business model. The first two categories of values result from the analysis of the literature on business models and the empirical research conducted. Values for society were identified in the course of the literature research and include criteria developed by GSTC [66] and analysis of key activities in tourist business models.

When analyzing possible market scenarios, it can be expected that the tendency to create value for the community will be proportional to the effectiveness of customer value influence, less the value captured by the enterprise (1).

$$Asv \approx Ecv - Cev, \tag{1}$$

where

- Asv*—acceptance to create value for society;
- Ecv*—effectiveness of customer value impact;
- Cev*—value captured by the enterprise.

The priority of the enterprise traditionally has been the economic goals, not the implementation of social goals. Thus, the social activity can be financed only if the enterprise makes profits that meet the expectations of the owners. At the same time, abstaining from pro-social activity tends to be one of the first decisions in a situation when it is necessary to carry out remedial restructuring caused by creation of maladjusted values (or inadequate proportion of each of the three value types). The value proposition for the community is, therefore, a value that depends to a great degree on the success of propositions of other types of values created in any business model.

The limitations of the conducted research mainly relate to the scope of analyzed values generated by the tourist enterprises. The article analyzes customer values and values captured from the companies surveyed. Only the subsequent in-depth interviews revealed the need to formulate values for society. Therefore, further research should focus on the priorities in terms of the value generated by the tourist enterprise for the community. Another limitation of the presented research is the need to generalize

the postulated activities so that they can be applied to various types of tourist activities. In the case of tourist enterprises in which transport will be the dominant activity, the postulated values may have different priorities than those for enterprises in which accommodation services dominate.

6. Conclusions

The research discussed here demonstrates that the values created by the health tourism enterprises examined do not include benefits for the community. Instead, among the current priorities are benefits for the tourists and the enterprise itself. Subsequent research should determine why this is the case and if it is correct to assume that the tendency of an enterprise to carry out social objectives is associated with meeting the economic goals of that enterprise that result directly from providing value to the customer.

The analysis of literature and of selected program documents of organizations and conferences indicated the presence of a number of proposals for implementing rules associated with achieving sustainable development in tourist enterprises. Such key sets of rules could be the criteria and proposals for two documents. The first one is the Global Sustainable Tourism Council criteria [61] which apply to hotels, tour operators, and tourist destinations, and constitute a unique inspiration for entrepreneurs of tourist industry. The second document is the Cape Town Declaration on Responsible Tourism of 2018 [67] that provides directions on activities necessary to be undertaken by those entrepreneurs that aim to co-create a responsible tourist economy.

A key element of creating a community that undertakes activities associated with responsible tourist businesses is that such a community is taking into account actions and objectives associated with sustainable tourism, and applying these principles as laid out in its basic policy or strategy and similarly that all involved businesses are following an appropriate business model that is also established on the basis of sustainable development principles. This research has demonstrated the fragmentary knowledge of those managers surveyed with respect to the business model concept, and also revealed potential opportunities for implementing the sustainable business principles by incorporating them into the business model priorities. The approach proposed here is one by which the proposals for the created values are divided into three groups. In such an approach, complementing the values gained by the customer and values captured by the enterprise combined with the gain in overall social values can foster greater effectiveness in the undertaking of sustainable activities.

Author Contributions: A.R.S. prepared the following elements of the article: The methodology, introduction, and conclusions, and conduct of research. R.W.B. developed the final contents of the article and proofread and revised it.

Funding: This research received funding by the National Science Center in Poland.

Acknowledgments: This paper was published as part of the research project 'A business model for health resort enterprises' No. 2017/25/B/H54/00301, supervised and financed by the National Science Center in Poland and as part of statutory research No. 13/990/BK_19/0138 at the Silesian University of Technology, Faculty of Organization and Management.

Conflicts of Interest: The authors declare no conflict of interest. The funders had no role in the design of the study; in the collection, analyses, or interpretation of data; in the writing of the manuscript, or in the decision to publish the results.

References

1. Goodrich, J.; Goodrich, G. Health-care Tourism: An Exploratory Study. *Tour. Manag.* **1987**, *8*, 217–222. [\[CrossRef\]](#)
2. Bushell, R.; Sheldon, P.J. (Eds.) *Wellness and Tourism: Mind, Body, Spirit, Place*; Cognizant Communication Corporation: New York, NY, USA, 2009; p. 8.
3. Health Resort Treatment. Health Resorts, Health Resort Protection Areas and Health Resort Communes. *J. Laws* **2005**, *167*, 1399.
4. Szromek, A.R. Changes in the management model of health care institutions in health resorts in the context of social and economic changes in the years 1989–2018. *Health Prim. Care* **2018**, *2*, 1–2. [\[CrossRef\]](#)

5. Szromek, A.R.; Romaniuk, P.; Hadzik, A. The privatization of spa companies in Poland—An evaluation of policy assumptions and implementation. Health Policy & Services category. *Health Policy* **2016**, *120*, 362–368.
6. Kapczyński, A.; Szromek, A.R. Hypotheses Concerning the Development of Polish Spas in the Years 1949–2006. *Tour. Manag.* **2008**, *29*, 1035–1037. [CrossRef]
7. Van Tubergen, A.; Van Der Linden, S. A brief history of spa therapy. *Ann. Rheum. Dis.* **2002**, *61*, 273–275. [CrossRef] [PubMed]
8. Erfurt-Cooper, P.; Cooper, M. *Health and Wellness Tourism Spas and Hot Springs*; Channel View Publication: Toronto, ON, Canada, 2009; p. 4.
9. Magretta, J. Why business models matter? *Harv. Bus. Rev.* **2002**, *80*, 86–92. [PubMed]
10. Battistella, C.; Toni, A.; Zan, G.; Pessot, E. Cultivating business model agility through focused capabilities: A multiple case study. *J. Bus. Res.* **2017**, *73*, 65–82. [CrossRef]
11. Teece, D. Business models and dynamic capabilities. *Long Range Plan.* **2018**, *51*, 40–49. [CrossRef]
12. Osterwalder, A.; Pigneur, Y. *Business Model Generation: A Handbook for Visionaries, Game Changers, and Challengers*; John Wiley & Sons: Hoboken, NJ, USA, 2010; p. 59.
13. Prendeville, S.; Bocken, N. Sustainable Business Models through Service Design. *Procedia Manuf.* **2017**, *8*, 292–299. [CrossRef]
14. Al-Debei, M.; El-Haddadeh, R.; Avison, D. Defining the Business Model in the New World of Digital Business. In Proceedings of the Fourteenth Americas Conference on Information Systems, Toronto, ON, Canada, 14–17 August 2008.
15. Wit, B. *Ekologistyka w Systemie Zarządzania Odpadami Niebezpiecznymi, Towarzystwo Naukowe Organizacji i Kierownia*; Stowarzyszenie Wyższej Użyteczności Dom Organizatora: Toruń, Poland, 2016; p. 138.
16. Lindgren, P. Business Model Innovation Leadership: How Do SME's Strategically Lead Business Model Innovation? *Int. J. Bus. Manag.* **2012**, *7*, 53–66. [CrossRef]
17. VDMbee Platform. VDML Roots: Business Model. Available online: <https://www.vdmbee.com/2014/07/vdml-roots-business-model/> (accessed on 1 August 2019).
18. Lindgren, P.; Rasmussen, O.H. The Business Model Cube. *J. Multi Bus. Model Innov. Technol.* **2013**, *1*, 135–182.
19. Allee, V.; Schwabe, O.; Krause Babb, M. Innovation at the Intersection of Business and Technology. In *Value Networks and the True Nature of Collaboration*; Meghan-Kiffer Press: Tampa, FL, USA, 2011; p. 33.
20. Gordijn, J.; Akkermans, H. Value based requirements engineering: Exploring innovative e-commerce ideas. *Requir. Eng. J.* **2010**, *8*, 114–134.
21. Scheller, C.V.; Hruby, P. Modeling, Services and Intellectual Property Rights Using POA (Possession, Ownership, Availability). In Proceedings of the 5th International Workshop on Value Modeling and Business Ontologies, Gent, The Netherlands, 7–8 February 2010.
22. Maurya, A. Iteracja od planu A do planu, który da Ci sukces. In *Metoda Running LEAN*; Helion, wyd. II: Gliwice, Poland, 2013; p. 47.
23. Johnson, M.W.; Christensen, C.M.; Kagermann, H. Reinventing Your Business Model. *Harv. Bus. Rev.* **2008**, *86*, 50–59.
24. Johnson, M.W. *Seizing the White Space: Business Model Innovation for Growth and Renewal*; Harvard Business Review Press: Brighton, NY, USA, 2010; pp. 113–173.
25. Afuah, A. *Business Model Innovation: Concepts, Analysis, and Cases*; Routledge-Taylor & Francis Ltd.: Abingdon, UK, 2014; p. 12.
26. Muehlhausen, J. *Business Models for Dummies*; John Wiley & Sons: Hoboken, NJ, USA, 2013; p. 80.
27. Chesbrough, H.W. *Open Business Models: How to Thrive in the New Innovation Landscape*; Harvard Business Review Press: Brighton, NY, USA, 2016; pp. 1–272.
28. Westa, J.; Salter, A.; Vanhaverbeke, W.; Chesbrough, H. Open Innovation: The Next Decade. *Res. Policy* **2014**, *43*, 805–811. [CrossRef]
29. Seidenstricker, S.; Scheuerle, S.; Linder, C. Business Model Prototyping—Using the Morphological Analysis to Develop New Business Models. *Procedia Soc. Behav. Sci.* **2014**, *148*, 102–109. [CrossRef]
30. McGrath, R. Business Models: A Discovery Driven Approach. *Long Range Plan.* **2010**, *43*, 247–261. [CrossRef]
31. Doleski, O.D. *Integrated Business Model: Applying the St. Gallen Management Concept to Business Models*; Springer Fachmedien Wiesbaden: Wiesbaden, Germany, 2015.
32. Michelini, L. *Social Innovation and New Business Models. Creating Shared Value in Low-Income Markets*; Springer: New York, NY, USA, 2012; p. 30.

33. Szromek, A.R. Propozycja wartości dla klienta przedsiębiorstwa uzdrowiskowego. *Folia Tur. Proksenia Kraków* **2018**, *47*, 9–25. [CrossRef]
34. Porter, M. *Competitive Advantage*; Free Press: New York, NY, USA, 1985; Volume 61.
35. Bojar, E.; Wit, B. Triple Bottom Line w szablonie modelu biznesu A. Osterwaldera i Y. Pigneura w perspektywie interesariuszy. *Zeszyty Naukowe Politechniki Śląskiej, Organizacja i Zarządzanie* **2016**, *99*, 37–53.
36. Souto, J. Business model innovation and business concept innovation as the context of incremental innovation and radical innovation. *Tour. Manag.* **2015**, *51*, 142–155. [CrossRef]
37. Naramski, M.; Szromek, A.R. A Business Model in Spa Tourism Enterprises: Case Study from Poland. Sustainable Tourism—Ways to Counteract the Negative Effects of Overtourism at Tourist Attractions and Destinations. *Sustainability* **2019**, *11*, 2880.
38. Reinhold, S.; Beritelli, P.; Grünig, R. A business model typology for destination management organizations. *Tour. Rev.* **2019**, *74*, 1135–1152. [CrossRef]
39. Reinhold, S.; Zach, F.; Krizaj, D. Business models in tourism—state of the art. *Tour. Rev.* **2019**, *74*, 1120–1134. [CrossRef]
40. Joyce, A.; Paquin, R.L. The triple layered business model canvas: A tool to design more sustainable business models. *J. Clean. Prod.* **2016**, *135*, 1–13. [CrossRef]
41. Collins, J.C.; Porras, J.I. Building your company's vision. *Harv. Bus. Rev.* **1996**, *74*, 65–76.
42. Boons, F.; Lüdeke-Freund, F. Business models for sustainable innovation: State of the art and steps towards a research agenda. *J. Clean. Prod.* **2013**, *45*, 9–19. [CrossRef]
43. Herman, K.; Szromek, A.R. Przedsiębiorstwo turystyczne w ujęciu modelowym. In *Model Biznesu w Przedsiębiorstwie Turystyki Dziedzictwa Przemysłowego*; Wyd. Pol.Sl: Gliwice, Poland, 2018; pp. 180–202.
44. Herman, K.; Szromek, A.R. A Business Creation in Post-Industrial Tourism Objects: Case of the Industrial Monuments Route. *Sustainability* **2019**, *11*, 1451.
45. Threebility—Tools for Sustainable Innovation. The Sustainable Business Model Canvas. Available online: <https://www.threebility.com/sustainable-business-model-canvas> (accessed on 21 November 2019).
46. Bodenau, A. Innovative Value of Sustainable Tourism Practices. In *Innovation and Value Creation in Experience Based Tourism*. In Proceedings of the 22nd Nordic Symposium in Tourism and Hospitality Research, Bodø, Lofoten, Norway, 24–27 September 2013; University of Nordland: Nordland, Norway, 2013; pp. 23–25.
47. Cranmer, E.; Jung, T.; Dieck, M.C.T. The Value of Augmented Reality from a Business Model Perspective, e-Review of Tourism Research. 2017. Available online: <https://ertr.tamu.edu/> (accessed on 1 August 2019).
48. Havemo, E. A visual perspective on value creation: Exploring patterns in business model diagrams. *Eur. Manag. J.* **2018**, *36*, 441–452. [CrossRef]
49. Prebensen, N.; Dahl, J. Value co-creation significance of tourist resources. *Ann. Tour. Res.* **2013**, *42*, 240–261. [CrossRef]
50. Mantaguti, F.; Mingotto, E. Innovative business models within niche tourist markets: Shared identity, authenticity and flexible networks. The case of three Italian SMEs. *J. Tour. Res.* **2016**, *6*, 9–10.
51. Miguéns, J.; Baggio, R.; Costa, C. Social media and Tourism Destinations: TripAdvisor Case Study, Advances in Tourism Research. *Adv. Tour. Res.* **2008**, *26*, 1–6.
52. Inversini, A.; Xiang, Z.; Fesenmaier, D.R. New Media in Travel and Tourism Communication: Toward a New Paradigm. Available online: https://inversini.files.wordpress.com/008/01/27_cont_9783110266535_inversini_xiang_fesenmaier1.pdf (accessed on 1 August 2019).
53. Diaconu, M.; Dutu, A. Business model in the hospitality industry, from traditional to open innovation. *Sci. Bull. Econ. Sci.* **2017**, *16*, 3–10.
54. Langvinienė, N.; Daunoravičienė, I. Factors influencing the success of business model in the hospitality service industry. *Procedia Soc. Behav. Sci.* **2015**, *213*, 908. [CrossRef]
55. Dodds, R.; Butler, R.W. Overtourism. Issues, realities and solutions. *Gruyter Stud. Tour.* **2019**, *1*, 1–22.
56. Nosratabadi, S.; Mosavi, A.; Shamshirband, S.; Zavadskas, E.K.; Rakotonirainy, A.; Wing Chau, K. Sustainable Business Models: A Review. *Sustainability* **2019**, *11*, 1663. [CrossRef]
57. Geissdoerfer, M.; Bocken, N.M.; Hultink, E.J. Design thinking to enhance the sustainable business modelling process—A workshop based on a value mapping process. *J. Clean. Prod.* **2016**, *135*, 1218–1232. [CrossRef]
58. Abdelkafi, N.; Täuscher, K. Business models for sustainability from a system dynamics perspective. *Organ. Environ.* **2016**, *29*, 74–96. [CrossRef]

59. Liu, Z. Sustainable Tourism Development: A Critique. *J. Sustain. Tour.* **2003**, *11*, 459–475. [CrossRef]
60. Porter, M.E.; Kramer, M.R. The big idea: Creating shared value. *Harv. Bus. Rev.* **2011**, *89*, 62–77.
61. Luo, J.M.; Lam, C.F.; Ye, B.H. Barriers for the Sustainable Development of Entertainment Tourism in Macau. *Sustainability* **2019**, *11*, 2145. [CrossRef]
62. Norris, M.; West, S. *E-biznes, Wydawnictwa Komunikacji i Łączności*; Wydawnictwa Komunikacji i Łączności sp. z o.o.: Warszawa, Poland, 2001; p. 179.
63. Grefen, P. *Mastering e-Business*; Routledge–Taylor & Francis Ltd.: Abingdon, UK, 2010; Volume 1, pp. 16–32.
64. Siakwah, P.; Musavengane, R.; Leonard, L. Tourism Governance and Attainment of the Sustainable Development Goals in Africa. *Tour. Plan. Dev.* **2019**, *5*, 1–29. [CrossRef]
65. United Nations. The United Nations Development Programme. 2016. Available online: <http://www.undp.org/content/undp/en/home/sustainable-development-goals.html> (accessed on 1 August 2019).
66. Global Sustainable Tourism Council. GSTC Criteria for Hotels. GSTC Criteria for Tour Operators. GSTC Criteria for Destinations. 2019. Available online: <http://www.gstccouncil.org/gstc-criteria/> (accessed on 1 August 2019).
67. Cape Town Declaration on Responsible Tourism. The Cape Town Conference on Responsible Tourism in Destinations. Responsible Tourism Partnership and Western Cape Tourism. Cape Town. 2018. Available online: <https://responsibletourismpartnership.org/cape-town-declaration-on-responsible-tourism/> (accessed on 1 August 2019).



© 2019 by the authors. Licensee MDPI, Basel, Switzerland. This article is an open access article distributed under the terms and conditions of the Creative Commons Attribution (CC BY) license (<http://creativecommons.org/licenses/by/4.0/>).

Article

The Identification of Values in Business Models of Tourism Enterprises in the Context of the Phenomenon of Overtourism

Zygmunt Kruczek ^{1,*} and Adam R. Szromek ²

¹ Department of Tourism Geography and Ecology, University School of Physical Education, Al. Jana Pawła II 78, 31-571 Kraków, Poland

² Department of Organization and Management, Institute of Economy and Informatics, Silesian University of Technology, Akademicka 2A, 44-100 Gliwice, Poland; innowator@o2.pl

* Correspondence: zygmunt.kruczek@awf.krakow.pl; Tel.: +48-602-758-513

Received: 8 February 2020; Accepted: 14 February 2020; Published: 15 February 2020

Abstract: This article presents considerations on business models, overtourism, and sustainable development on an example of the most important Polish tourist destination, which is Krakow. The purpose of the article is to identify the values generated and captured by tourist enterprises in the context of the occurrence of a specific level of overtourism. The authors have attempted to identify the values of sustainable tourism declared by entrepreneurs, referring to the companies providing services as well as tourists and the local community. The research, conducted on a sample of 518 respondents including 371 residents and 147 entrepreneurs, not only allowed us to determine the attitudes of Krakow inhabitants toward the phenomenon of overtourism related to the Doxey model of irritation, but also to assess the impact of having/using a business model based on the acceptance of principles in sustainable tourism development. A comparison of the results obtained between enterprises declaring having and not having a business model indicates a great similarity in terms of declared value propositions.

Keywords: sustainability; overtourism; business model; Doxey model; Krakow

1. Introduction

The negative impact of tourist activities in the area of tourist destinations is one of the key problems of modern tourism. Balancing the expectations of tourists and residents not only becomes the task of local authorities in a tourist destination, but also that of the entrepreneurs conducting these activities. The literature proves that the enterprise's use of a tool in the form of a business model streamlines and organizes their operations. It allows, among others, for mistakes to be avoided in the form of the omission of actions necessary to achieve market success. In recent years, care for the natural environment and the local culture of inhabitants has become one of these tasks. However, these elements are rarely included in the business models of modern enterprises.

The purpose of the article is to identify the values generated and captured by tourist enterprises in the context of the occurrence of a specific level of overtourism on the example of the historic city of Krakow. The paper is based on research conducted in 2019 among the inhabitants and tourism entrepreneurs of this tourist city. Although Krakow, as the most recognizable tourist destination in Poland and Central Europe, shows signs of an excessive concentration of visitors, the level of tourist traffic load here is rather moderate, excessively burdening its inhabitants only in the historical center. The key values of tourist business conducted by entrepreneurs can be referred to two groups of companies: those with a formal business model and those not having such a model. The respondents' business responses not only concern the values generated for the enterprise, but also for tourists and the local community, and are referred to in the city's sustainable tourism development policy.

2. Literature Review

2.1. Sustainable Business Models

One of the modern strategic tools in managing an enterprise or any other organization is the business model. The evolution of this tool is evident in the variety of definitions used to describe it, especially in the 21st century, where it was initially referred to as an abstract concept or a description of relationships or ongoing processes. However, literature has been dominated by the tool importance of business models. According to the definition of Osterwalder and Pigneur [1], it is a conceptual tool containing a set of elements and their relationship with set goals, allowing the company's business logic to be exposed. It is a description of the value that an enterprise is able to provide to market segments and a description of the organization itself, along with its network connections with partners in order to create value. Teece [2] sees it as a practical application in designing or describing the architecture of mechanisms for creating, delivering, and capturing value. Prendeville and Bocken [3] refer to it as ordering business transactions between customers, partners, and suppliers as well as the organization, and their participation in creating and capturing value. Margareta defines the business model as a characteristic of the described business in the form of a story explaining how the enterprise operates [4]. Often, it is also a description of the ongoing relationships between the components in the organization that lead to the creation and capture of its value [5].

Al-Debei et al. [6] portray business models in the form of an abstract textual or graphic representation of related model architecture structures developed by the organization, and all products and services that the organization proposes, and that are needed to achieve the goal.

The affordability and versatility of business models have led to the fact that, for two decades, the use of business models has been observed to expand not only to further industries (including business models of industrial, food, tourist, energy, etc. enterprises), but also to the specific dimensions of ongoing processes, taking into account the needs of a changing business environment. An example of such a specific model is its form, dedicated to enterprises wishing to implement the assumptions of sustainable development. Geissdoerfer [7] defines sustainable business models as a set of elements in which the interrelationships between these elements and their interactions with stakeholders create, deliver, capture, and exchange sustainable value for many stakeholders. Abdelkafi and Täuscher [8] see sustainable business models as a tool to integrate sustainable development principles into the company's value logic and the logic of value creation by the enterprise. Entering sustainable development principles into business operations can help protect the environment, but, as Porter and Kramer [9] state, can also be a source of competitive advantage and economic benefits for the enterprise.

Nosratabadi et al. [10] reviewed the work from various thematic areas. An interesting fact can also be seen in the literature analysis after 2007. The context of sustainable development in business models is most often taken up in the work of scientists from the United States and Great Britain as well as in China, with Americans taking up this topic in their research twice as often as the British and almost three times more often than the Chinese.

However, it should be noted that the adaptation of activities and solutions related to sustainable development is not only the direct impact of enterprises on the environment, but also on the immediate business environment (contractors, customers, recipients). Therefore, the implementation of sustainable development elements is often associated with obstacles.

The findings of the Cape Town Declaration on Responsible Tourism from 2018 [11] include the objectives of sustainable tourism. Another example relating to business models in tourism is the study of Peric and Wise [12], which is a holistic and in-depth analysis of how sports tourism experiences are delivered by looking at two existing case studies in Istria (Croatia). An important source of sustainable development activities in tourism are the Global Sustainable Tourism Council (GSTC) Criteria [13], which were developed for the implementation of "sustainable tourism" in the tourist company.

2.2. Value for the Customer, Enterprise, and Society

From the perspective of many approaches to the structure of the business model, the place and role of one of them is extremely significant: the element of value proposition for the customer. This element appears in almost all concepts, regardless of the number of components and the way they are grouped. However, considering that the value proposition is something, without which an enterprise loses the basic sense of functioning, and thus a set of products and services that generate value for a particular customer segment, the universality of its occurrence is understandable.

Customer value is a very broad concept. The cited definition of Osterwalder and Pigneur [1] defines it as a set of products and services that generate value for a particular customer segment as well as the reason why customers prefer the offer of a given company over the offer of its competitors. They also add that it is a value that solves customer problems or meets their needs. However, customer value is often complemented by business value, which is what the enterprise captures as part of its own business. Most often it is profit and other intangible assets.

As part of their business, tourism businesses also generate other values that are not related to what the customer or the enterprise itself gains [14]. This value is the social value of the business, determined by the tendency to pursue social goals in the form of activities and services that go beyond tourism. This may be, for example, therapeutic treatment provided as part of spa tourism or medical services provided as part of medical tourism, or activities that protect the natural environment and indigenous culture through the implementation of sustainable tourism [15]. However, it should be noted that the structure of these three categories of values is likely to change as soon as a certain level of tourist traffic load is reached. Therefore, in the second part of this article, efforts were made to simultaneously examine the value structure generated by the tourist enterprise and determine the level of burden on residents with the presence of tourists.

2.3. Overtourism and How to Measure it

One of the important problems of modern tourism is overtourism (i.e., the overload of tourist traffic on tourist destinations and the measurement of this load). Tourism space has its limitations resulting from the size of the usable area and its response to tourism traffic [16]. An important problem is determining the permissible volume of traffic, exceeding which could be considered excessive. In relation to cities and large tourist centers that are struggling with the invasion of tourists, indicators of the optimal level of sociopsychological capacity have been proposed [17]. In a very short time, the term overtourism has become a descriptor of the negative impact of tourism and refers to the problem of excess tourists in many cities. The discussion around overtourism has drawn attention to the negative consequences of unlimited tourism growth and also pointed out directions of restrictions and voluntary compromises aimed at effectively preventing growing problems [18].

The literature mentions other issues that are related or similar to overtourism. An example is the publication by Torres Outón [19], Jover, and Diaz-Parra [20], which refers to gentrification and touristification. For the sake of completeness, it is worth adding that the phenomenon of touristification includes processes caused by excessive tourist traffic that contribute to the destruction of the socio-cultural tissue of the city: they break down social networks and neighborhoods and erode local identities that are supplanted by marketing activities targeted at tourists [21]. Regarding the second concept, gentrification is a process of changing the character of a neighborhood through the influx of more affluent residents and businesses. Gentrification often shifts a neighborhood's racial/ethnic composition and average household income by developing new, more expensive housing, businesses, and improved resources [22].

It is very difficult to determine the assessment of the social effects of the influx of tourists. The level of tolerance of inhabitants toward the influx of tourists varies depending on local and private interests [23,24]. An important tool is the analysis of the limits of acceptable change (LAC) [25,26]. However, it should be noted that residents' tolerance for social difficulties may be greater due to economic benefits [27].

There are various ways of solving this issue, besides limiting the number of visitors. This may include:

- increasing the tourist capacity of reception areas, and
- making a variety of tourism forms and to build correct relationships between stakeholders who are involved in tourism [28–30].

The tool for measuring the residents' response to the occurrence of tourism traffic is the methodology proposed by Doxey [16,31], which has been used for over four decades. The literature also presents other methods of assessing the intensity of tourist traffic (e.g., with the help of the Baretje-Defert, Defert, Charvat and Schneider indicators) as well as accommodation density indicators and the use of accommodation potential and tourist enterprises (in all enterprises) [31–34]. Concepts that include measuring the capacity and tourist absorption of the area [35–37] or analyzing the development of the area through the typology of tourists visiting the area [38,39] are also often used.

However, the simplicity of the Doxey index means that it is still used. An example of this is the research into assessing the attitudes of locals toward tourists and tourism in Dubai, a city of rapid development in the tourism industry in the Middle East [40]. Their research indicates that the tourism industry in this city can continue to grow without becoming antagonistic with the inhabitants. Similar research on the socio-cultural influences of tourism development have been conducted in Hungary's Lake Balaton [41] and the island of Mauritius [42].

Doxey [33,34] assumes that the emergence of negative attitudes of inhabitants toward tourists is the result of exceeding the limits of the *social carrying capacity* (i.e., the ability to accept changes). Describing ongoing changes in the attitudes of inhabitants in four successive levels. The first level is *euphoria*, a phase in which residents experience enthusiasm and joy at the appearance of tourists. Satisfaction with this fact is reciprocal, as tourists enjoy a joyful reception and residents receive income. The second phase is *apathy* (i.e., stabilization of emotions toward tourists). Tourist traffic is becoming something ordinary and a tourist is an obvious element of earning of residents. In the third phase, which is *irritation*, an approximation of the volume of tourist traffic approaches the saturation point with tourists. This generally results in infrastructure development. In the fourth phase, *antagonism*, the tourist is perceived as the source of all that is bad. In place of courtesy, abuse and even fraud are increasingly creeping into relationships with tourists. The last phase, although not named by Doxey, is a permanent change of the area and its inhabitants, and often also the loss of tourist function.

3. Materials and Methods

The purpose of the article was to identify the values generated by tourist enterprises in the context of the occurrence of a specific level of overtourism using the example of the historic city of Krakow. To achieve this goal, empirical research was conducted among randomly selected inhabitants and entrepreneurs conducting business activities related to tourism in Krakow, Poland (i.e., in one of the cities most visited by tourists in Central Europe).

In 2019, Krakow had 780 thousand inhabitants and its administrative division included four main districts (i.e. Podgórze, Nowa Huta, Old Town, and Krowodrza) [43]. The most interesting areas for tourists is the Old Town, covering the urban layout of the historic old town with the royal castle (Wawel), the former Jewish district of Kazimierz, churches, and numerous museums where mainly hotels, apartments, restaurants, clubs, theatres, etc. are located. This district has the largest tourist crowds and there has been a rapid increase in the short-term tourist rental offers, causing gentrification.

Krakow is one of the most popular Polish tourist destinations. It belonged to the United Nations Educational, Scientific and Cultural Organization (UNESCO) Creative Cities Network in 2013, and the European Capital of Gastronomic Culture in 2019. The proof of the high significance of the problem of overtourism in Krakow is the development of a general Sustainable Tourism Policy Program for 2021–2028, under the patronage of the City of Krakow [44]. In 2019, Krakow was visited by as many as 14 million people, who spent almost PLN 7.5 billion during their stay in Krakow. The GDP generated

by the tourist industry in Krakow is over 8% of the city's total GDP [43]. The pace of changes is also indicated by statistical data. The volume of tourist activity in Krakow has doubled in the last decade [45]. Tourism in Krakow generates 29,000 jobs [44,46], and tourist arrivals from abroad to Poland in 2014–2019 increased by one third (from 12.5 to 19.5 million tourists) [47,48].

The research tool used in the study was a research questionnaire made available to 518 respondents including 371 randomly selected residents of Krakow and 147 entrepreneurs operating in Krakow. A permanent feature for all respondents was permanent residence in one of the four main districts of Krakow or tourist activity there. The research questionnaire contained nine questions with an extensive structure. The first part of the questionnaire included questions that first classified the respondent to a specific group of respondents (residents/entrepreneurs), and then to a subgroup. In the case of entrepreneurs, subgroups were created by the criterion used, which was the generic scope of the business (hospitality, gastronomy, other tourist services), while in the case of city residents, the respondents were classified into a subgroup related to local origin and the relationship of professional work with tourism. The second part of the research questionnaire included questions aimed at assessing the impact of tourist traffic in Krakow on the daily lives of city residents and people conducting business activity there as well as the proposal of value in the business models of enterprises operating there.

The analysis of the answers obtained was made using the methodology proposed by Doxey by enabling respondents to choose one of five answers that most accurately determined their attitude to tourists. Table 1 presents the method of determining the level of tourism impact on residents and entrepreneurs, in which specific opinions were assigned an appropriate level of tourism load. The Doxey model was also supplemented with an extreme attitude, which expresses the complete degradation of the tourism (*decline stage*).

Table 1. Assigning standardized opinions to individual stages of development in tourist traffic load in the Doxey concept.

Doxey Index	Opinion Characterizing the Residents' and Entrepreneurs' Specific Attitude
Stage I: Euphoria	<i>I am glad that tourists come here, because it means income for the city, new contacts, jobs, prestige ...</i>
Stage II: Apathy	<i>It is obvious that tourists come to us. It doesn't impress me. We have to show hospitality ...</i>
Stage III: Irritation	<i>Unfortunately, I see more negative than positive sides to tourists coming to my city. It is no longer the same city it used to be ...</i>
Stage IV: Antagonism	<i>Currently, tourists mainly mean problems. There are too many of them, which reduces the quality of life for inhabitants. Something needs to be done about it, e.g. introduce restrictions ...</i>
Stage V: Decline	<i>I cannot tolerate tourists in my surroundings!</i>

Source: Based on own study.

However, the respondents were asked to rate the load on a scale of 0–10. The collected data were subjected to statistical analysis [49]. The level of the significance of differences between the obtained average values was also studied (Mann–Whitney test was used) [50], taking into account significance at the level of $\alpha \leq 0.05$.

4. Results of Research

Empirical research was conducted on a sample of 518 respondents including 371 city residents (71.6%) and 147 entrepreneurs conducting business activity in the analyzed tourist destination (28.4%). Among the entrepreneurs participating in the research, every fifth provided hotel services (19.9%) and 7.8% of the surveyed companies provided catering services. Entrepreneurs providing other tourist

services than those above-mentioned were the dominant group (72.3%). The age structure of the resident respondents indicates the dominance of people over 35 (51.0%). More often than every third respondent (35.6%) was 36–55 years old, while every seventh was more than 55 years old.

More often than every second respondent (56.6%) declared being of Krakow origin. It is also known that the majority of the surveyed residents were active in the field of tourism (51.0%).

4.1. Quantitative Analysis Results

Quantitative analysis of the tourist traffic load showed that the load expressed on a scale of 0–10 was assessed at the level of optimal load (i.e., oscillating around an average rating of 5 ($x_{AV} = 5.49 \pm 2.81$; $Me = 5$)). However, this is the average result from the ratings of four individual districts. As expected, the distribution of loads in individual districts is not even. One of the districts showed an optimal load, while the others were either overloaded with tourism (Old Town $x_{AV} = 7.43 \pm 2.4$; $Me = 8$) or showed an underload of tourists such as in Krowodrza and Nowa Huta, where tourists are still expected there to a larger extent than before ($Me = 4$).

By not focusing the respondents' attention on the rated district, but on the whole city, a much higher average result ($x_{AV} = 7.57 \pm 1.97$; $Me = 8$) was obtained than in the case of the average result for the ratings of individual districts ($x_{AV} = 5.49 \pm 2.81$; $Me = 5$). This means that respondents rated the city's load based on the load perceived in the most tourist-borne district of this destination (Old Town).

Therefore, analyzing the results obtained for the whole city, it can be concluded that Krakow is struggling with an excessive number of tourists, but to a moderate degree. Assuming that the tourist traffic load within the 0–5 limits is also a load not exceeding the level of critical capacity and tourist absorption, it can be stated that the limit of tourist capacity has been exceeded in Krakow. However, it does not seem to be a level that degrades the tourist function of the city, but the level of load is rather moderate or sometimes excessively burdensome for its inhabitants.

The origin of respondents from the city or outside the city had no effect on the expressed attitude toward tourists or the assessment of the city's tourist traffic load ($p > 0.05$). The fact of whether the respondent was employed in tourism or outside tourist activities had an impact on the attitude toward tourists ($p < 0.001$), which seems to be understandable, but also had an impact on the assessment of the tourist traffic load in the city ($p < 0.001$).

In the case of differences between the ratings of residents and entrepreneurs conducting their tourist activities in the city, significantly different notes can be seen in all of the analyzed variables. While entrepreneurs showed a lower comfort of doing business in the city than residents ($p = 0.029$), in the case of tourists, entrepreneurs had significantly higher scores than the residents ($p < 0.001$).

As far as the tourist traffic load in the city is concerned, it is worth noting that residents had a significantly higher load than entrepreneurs ($p < 0.001$). Considering the fact that entrepreneurs earn income from tourism, while among the residents, only every second was associated with tourism, the obtained result is understandable.

4.2. Qualitative Analysis Results

The obtained results regarding the ratio of residents to arriving tourists were verified using the model of changes in attitudes of inhabitants toward tourists, according to the Doxey concept. For this purpose, residents were asked to indicate the attitude that characterized their relationship toward tourists, according to the classification presented earlier in Table 1.

In terms of assessment in individual districts, the answers of the majority of inhabitants in the Krakow districts surveyed indicated the first two phases of the Doxey model (i.e., euphoria and apathy). By almost the same percentage of respondents, which was about 40% (the difference between the percentage of people indicating these two phases generally only reached $\Delta = 2$ –5%). The Old Town, being the most burdened with tourists, is unique in this respect, where euphoria is strongly indicated, but, at the same time, had the highest percentage of people who described their attitude as antagonism (13.6%).

However, the overall result obtained was an average assessment, taking into account the ratings of entrepreneurs and residents. An in-depth analysis of the results obtained indicates that these opinions did not coincide. While every third city inhabitant indicated the attitude of euphoria, expressed by the opinion: *I am glad that tourists come here, because it means income for the city, new contacts, jobs, prestige ...* (33.8%), among the entrepreneurs, this attitude was shown by twice as many respondents (71.9%). Among the residents, the attitude of conflict with tourists was expressed by 9.4% of people, while among the entrepreneurs, it was only 2.1%. The structure of the residents' and entrepreneurs' attitudes is presented in Table 2.

Table 2. The structure of the residents' and entrepreneurs' attitudes toward tourists in accordance with the Doxey concept.

Doxey Index [%]	Inhabitants	Entrepreneurs	In General
Stage I: Euphoria	33.8%	71.9%	42.5%
Stage II: Apathy	36.9%	14.6%	31.7%
Stage III: Irritation	20.0%	10.4%	17.8%
Stage IV: Antagonism	9.4%	2.1%	7.7%
Stage V: Decline	0.0%	1.0%	0.2%

Source: Based on own study.

4.3. Tourist Traffic Load Depending on the Use of the Business Model

The analysis of the obtained results was also conducted in the direction of identifying differences between entrepreneurs using the business model and those who did not use it. Although the differences between the percentages of entrepreneurs with specific attitudes in both groups of analyzed entrepreneurs were not statistically significant, some differences were clearly noticeable. Entrepreneurs not using the formal business model more often showed euphoria from the presence of tourists (66.04% \leftrightarrow 78.05%), but the attitude of apathy and irritation was more often shown by entrepreneurs using the business model (Table 3).

Table 3. Results of average ratings expressed according to the Doxey model.

Doxey model	Entrepreneurs with A Business Model	Significance Level (p)	Entrepreneurs without A Business Model	In General
Euphoria	66.04%	0.2756	78.05%	71.28%
Apathy	18.87%	0.6814	9.76%	14.89%
Irritation	11.32%	0.0704	7.32%	9.57%
Antagonism	1.89%	0.9604	2.44%	2.13%
Decline	1.89%	0.9604	2.44%	1.06%

Source: own work.

4.4. Declared Value Proposition in Business Models

Entrepreneurs were also asked about the value proposition for customers, the enterprise, and society. These values were declared by both those who used the business model and those who did not know the business models (Table 4).

Table 4. Comparison of the attitudes of residents and entrepreneurs of the main districts of Krakow.

VALUE FOR TOURISTS	[%]
Interaction with family members, friends as well as encountered tourists and residents	68.09%
Enabling tourists to rest by meeting their needs (accommodation, catering etc.) <i>(accommodation and catering services)</i>	63.83%
Providing cognitive, cultural, religious experiences., etc. by providing tourists with the opportunity to commune with forms of culture and art <i>(tourist services)</i>	58.51%
Achieving recreation effects (health, relaxation, beauty, better looks, sport results, etc.) <i>(recreational and spa services)</i>	52.13%
Staying away from the everyday routine	27.66%
Other	2.13%
VALUE FOR ENTREPRENEURS	[%]
Satisfaction with playing an important role in the chain of creating the tourist offer of the city, region, and country	88.30%
The opportunity to develop and invest in one's own business	79.79%
Cooperation with suppliers and a team of colleagues	47.87%
Obtaining income to support the company	25.53%
Satisfaction of tourists from a feeling of meeting their needs	19.15%
Other	3.19%
VALUE FOR THE COMMUNITY	[%]
Carrying out preventive actions against excessive tourist traffic loads (reduction in pollution).	72.34%
Supporting the city by paying public levies (taxes etc.), creating jobs	35.11%
Playing an important social role in the city's economy	28.72%
Selection of ecological contractors (without plastic, old technologies, etc.)	20.21%
Introduction of rules for the provision of services limiting tourist dysfunctions (disputes, noise)	11.70%
Other	7.45%

Source: own work.

In the case of customer value, more than half of the entrepreneurs (>50%) appreciated values such as:

- The ability to interact with family members, friends as well as encountered tourists and residents;
- Enabling tourists to rest by meeting their needs (accommodation, catering, etc.);
- Providing cognitive, cultural, religious experiences, etc. by providing tourists with the opportunity to commune with forms of culture and art; and
- Achieving recreation effects (health, relaxation, beauty, better looks, sport results, etc.).
- Among the most appreciated values captured by enterprises are:
- Satisfaction with playing an important role in the chain of creating the tourist offers of the city, region, and country, and
- The opportunity to develop and invest in one's own business.

The key social value indicated by entrepreneurs was conducting preventive measures against excessive tourist traffic loads (reduction of pollution). This is due to the significant air pollution in Krakow.

5. Conclusions

A comparison of the results obtained between enterprises declaring having and not having a business model indicates a great similarity in terms of the declared value propositions. However, three cases of significant differences between entrepreneurs were noticed.

The first of the differences was observed in the case of enterprise value (in terms of satisfaction with playing an important role in the chain of creating the tourist offer of the city, region, and country). Entrepreneurs with a business model more often declared satisfaction with this role, which was 62.26% of entrepreneurs, compared to 53.66% of entrepreneurs without a business model. It is, therefore, significant evidence that the awareness of the role in the economy of the area goes hand in hand with the awareness of the advantages of having structured business principles.

The next two differences relate to values for society, but this time the results are not clear. Entrepreneurs who do not use the business model (58.54%) see more value from playing an important social role in the city's economy than those who have such a model (39.62%). Over half of entrepreneurs with a business model saw their own role in the city's economy.

However, the introduction of the principles of providing services limiting tourist dysfunctions (disputes, noise, etc.) in an enterprise was more often declared by entrepreneurs who did not use a business model (85.37%), than those who had such a tool (75.47%). This time, the issue of greater awareness of social impact did not accompany the use of the business model in conducting business.

Among other conclusions, it is worth quoting those that resulted from the obvious subjectivity of perception of the phenomenon of the presence of tourists in the city. While residents more often stressed the annoyance of tourism than entrepreneurs, the benefits of tourism in the city were more often appreciated by entrepreneurs. However, it seems reasonable to observe the percentage of entrepreneurs who poorly assessed the presence of tourists in the city and the residents who well assessed the impact of tourists.

One of the very important elements of this research was also noticing the diversity of perceived loads in individual city districts. While a moderate tourist traffic load was observed in the city, the inhabitants and entrepreneurs of individual districts showed different opinions on this subject. While the main tourist district of the city had an excessive load reaching 8 on the scale of quantified load ($1 \div 10$), the other district only had a value of 4 and might mean an ability to take more tourists.

An important solution in the business models of enterprises operating in areas with a significant intensity of tourist traffic should become elements limiting the negative effects of tourist visits, and activities aimed at raising the awareness of guests brought in with their impact on the visited area. Appropriate education of tourists carried out by tourist enterprises may reduce the antagonisms on the part of the inhabitants, and thus extend the ability of entrepreneurs to benefit from tourism. Another important solution may be including the local community in the business models of tourism enterprises among key partners, and, at the same time, conducting activities supporting residents. However, it is not about increasing the financial (including tax) burden on enterprises, but about increasing the intensity of activities protecting inhabitants against tourism dysfunctions as well as strengthening the survival of indigenous cultural elements.

However, the proposed solutions should be sustainable through a permanent place in the business models, and at the same time, should be oriented toward the implementation of sustainable development, making these models sustainable.

An issue that may determine future research is to determine the strength and direction of the relationship between the three values in business models. These are the value proposition for the customer, the values captured by enterprises, and the value proposition for society. It is also important to identify the measurable reasons for restricting tourism activities to avoid the negative consequences of excessive tourist traffic.

Author Contributions: Conceptualization, A.R.S. and Z.K.; methodology, A.R.S. and Z.K.; software, A.R.S. and Z.K.; validation, A.R.S. and Z.K.; formal analysis, A.R.S. and Z.K.; investigation, A.R.S. and Z.K.; resources, A.R.S. and Z.K.; data curation, A.R.S. and Z.K.; writing—original draft preparation, A.R.S. and Z.K.; writing—review

and editing, A.R.S.; visualization, A.R.S. and Z.K.; supervision, A.R.S. and Z.K.; project administration, A.R.S.; funding acquisition, A.R.S. All authors have read and agreed to the published version of the manuscript.

Funding: This research received funding by the National Science Center in Poland.

Acknowledgments: This paper was published as part of the research project ‘A business model for health resort enterprises’, No. 2017/25/B/H54/00301 that was supervised and financed by the National Science Center in Poland, and as part of statutory research ROZ 1: BK-235/ROZ-1/2020 (13/010/BK_20/0042) at the Silesian University of Technology, Faculty of Organization and Management.

Conflicts of Interest: The authors declare no conflicts of interest. The funders had no role in the design of the study; in the collection, analyses, or interpretation of data; in the writing of the manuscript, or in the decision to publish the results.

References

1. Osterwalder, A.; Pigneur, Y. *Business Model Generation: A Handbook for Visionaries, Game Changers, and Challengers*; John Wiley and Sons: Hoboken, NJ, USA, 2010; p. 59.
2. Teece, D. Business models and dynamic capabilities. *Long Range Plan.* **2018**, *51*, 40–49. [CrossRef]
3. Prendeville, S.; Bocken, N. Sustainable Business Models through Service Design. *Procedia Manuf.* **2017**, *8*, 292–299. [CrossRef]
4. Magretta, J. Why business models matter. *Harv. Bus. Rev.* **2002**, *80*, 86–92.
5. Battistella, C.; Toni, A.; Zan, G.; Pessot, E. Cultivating business model agility through focused capabilities: A multiple case study. *J. Bus. Res.* **2017**, *73*, 65–82. [CrossRef]
6. Al-Debei, M.; El-Haddadeh, R.; Avison, D. Defining the Business Model in the New World of Digital Business. In Proceedings of the Fourteenth Americas Conference on Information Systems, Toronto, ON, Canada, 14–17 August 2008.
7. Geissdoerfer, M.; Bocken, N.M.; Hultink, E.J. Design thinking to enhance the sustainable business modelling process—A workshop based on a value mapping process. *J. Clean. Prod.* **2016**, *135*, 1218–1232. [CrossRef]
8. Abdelkafi, N.; Täuscher, K. Business models for sustainability from a system dynamics perspective. *Organ. Environ.* **2016**, *29*, 74–96. [CrossRef]
9. Porter, M.E.; Kramer, M.R. The big idea: Creating shared value. *Harv. Bus. Rev.* **2011**, *89*, 62–77.
10. Nosratabadi, S.; Mosavi, A.; Shamshirband, S.; Zavadskas, E.K.; Rakotonirainy, A.; Wing Chau, K. Sustainable Business Models: A Review. *Sustainability* **2019**, *11*, 1663. [CrossRef]
11. Cape Town Declaration on Responsible Tourism. Available online: <https://responsibletourismpartnership.org/cape-town-declaration-on-responsible-tourism/> (accessed on 1 August 2019).
12. Peric, M.; Wise, N. Understanding the delivery of experience: Conceptualising business models and sports tourism, assessing two case studies in Istria, Croatia. *Local Econ. J. Local Econ. Policy Unit* **2015**, *30*, 1000–1016. [CrossRef]
13. Global Sustainable Tourism Council, GSTC Criteria for Hotels. GSTC Criteria for tour operators. GSTC Criteria for destinations. 2019. Available online: <http://www.gstccouncil.org/gstc-criteria/> (accessed on 1 August 2019).
14. Butler, R.W.; Szromek, A.R. Incorporating the Value Proposition for Society with Business Models of Health Tourism Enterprises. *Sustainability* **2019**, *11*, 6711. [CrossRef]
15. Herman, K.; Szromek, A.R. A Business Creation in Post-Industrial Tourism Objects: Case of the Industrial Monuments Route. *Sustainability* **2019**, *11*, 1451.
16. Szromek, A. *Wskaźniki Funkcji Turystycznych. Koncepcja Wskaźnika Funkcji Turystycznej i Uzdrawiskowej*; Wyd. Politechniki Śląskiej: Gliwice, Poland, 2012.
17. Russo, A.P. The “Vicious Circle” of Tourism Development in Heritage Cities. *Ann. Tour. Res.* **2002**, *29*, 165–182. [CrossRef]
18. Russo, A.P.; Scarnato, A. Barcelona in common: A new urban regime for the 21st-century tourist city? *J. Urban Aff.* **2018**, *40*, 1–20. [CrossRef]
19. Outón, S.M.T. Gentrification, touristification and revitalization of the Monumental Zone of Pontevedra, Spain. *Int. J. Tour. Cities* **2019**, *2/5*, 109–124. [CrossRef]
20. Jover, J.; Díaz-Parra, I. Gentrification, transnational gentrification and touristification in Seville, Spain. *Urban Stud.* **2019**. [CrossRef]

21. Kubicki, P. Wpływ studentyfikacji i turystyfikacji na społeczno-kulturową przestrzeń miasta. *Miasto. Pamięć i Przyszłość* **2017**, *2*, 63–73. [CrossRef]
22. Health Effects of Gentrification. Centers for Disease Control. Available online: <https://www.cdc.gov/healthypplaces/healthtopics/gentrification.htm> (accessed on 11 February 2020).
23. McCool, S.F.; Lime, D.W. Tourism Carrying Capacity: Tempting Fantasy or Useful Reality? *J. Sustain. Tour.* **2001**, *9*, 372–388. [CrossRef]
24. Saveriades, A. Establishing the social tourism carrying capacity for the tourist resorts of the east coast of the Republic of Cyprus. *Tour. Manag.* **2000**, *21*, 147–156. [CrossRef]
25. Lucas, R.C.; Stankey, G.H. Role of Research in Applying the Limits of Acceptable Change System. In Proceedings of the Southern Recreation Research Conference, Myrtle Beach, SC, USA, 28 February–1 March 1985; pp. 1–15.
26. Frauman, E.; Banks, S. Gateway community resident perceptions of tourism development: Incorporating Importance-Performance Analysis into a Limits of Acceptable Change framework. *Tour. Manag.* **2011**, *32*, 128–140. [CrossRef]
27. Nijs, V. Resident Attitudes towards Tourism; Testing the Resident Empowerment through Tourism Scale (RETS) in Bruges. Master's Thesis, MODUL University, Vienna, Austria, 2017.
28. *Overtourism? Understanding and Managing Urban Tourism Growth beyond Perceptions*; UNWTO: Madrid, Spain, 2018; Available online: <https://www.e-unwto.org/doi/pdf/10.18111/9789284420070> (accessed on 20 November 2019).
29. Pearce, P.L. Limiting overtourism the desirable new behaviours of the smart tourist. In Proceedings of the Tourism Intelligence Forum (t-Forum) Global Exchange Conference 2018, Palma de Mallorca, Spain, 11–13 March 2018.
30. Bianchi, R.V. The 'Critical Turn' in Tourism Studies: A Radical Critique. *Tour. Geogr.* **2009**, *11*, 484–504. [CrossRef]
31. Baretje, R.; Defert, P. Aspects Economiques du Tourisme. *Rev. Géographie Alp.* **1973**, *61-2*, 319–320.
32. Defert, P. Le Taut de Fonction Touristique: Mise au point et critique. *Cah. Tour.* **1967**, *C-13*, 33.
33. Doxey, G. A causation theory of visitor–resident irritants, methodology and research inferences. The impact of tourism. In Proceedings of the Sixth Annual Conference Proceedings of the Travel Research Association, San Diego, CA, USA, 8–11 September 1975.
34. Doxey, G.V. When enough's enough: The natives are restless in Old Niagara. *Herit. Can.* **1976**, *2*, 26–27.
35. Butler, R.W. The concept of a tourist area cycle of evolution: Implications for management of resources. *Can. Geogr.* **1980**, *24*, 5–12. [CrossRef]
36. Butler, R.W. The resort cycle two decades on. In *Reflections on Experience*; Faulkner, B., Laws, E., Morcado, G., Eds.; Cassell: London, UK, 2000; pp. 284–299.
37. Butler, R.W. Tourism Area life Cycle. In *Contemporary Tourism Reviews*; Goodfellow Publishers Limited: Oxford, UK, 2011; pp. 7–21.
38. Plog, S.C. Why Destination Areas Rise and Fall in Popularity. The Cornell Hotel and Restaurant Administration Quarterly. *Cornell Hotel Restaur. Adm. Q.* **1974**, *14*, 55–58. [CrossRef]
39. Plog, S.C. Why Destination Areas Rise and Fall in Popularity. The Cornell Hotel and Restaurant Administration Quarterly. *Cornell Hotel Restaur. Adm. Q.* **2001**, *42*, 13–24. [CrossRef]
40. Zaidan, E.; Kovacs, J. Resident attitudes towards tourism and tourism growth: A case Study from the Middle East, Dubai in United Arab Emirates. *Eur. J. Sustain. Dev.* **2017**, *6*, 291–307. [CrossRef]
41. Ratz, T. Residents' perceptions of the socio-cultural impact of tourism at lake Balaton, Hungary. In *Tourism and Sustainable Community Development*; Richard, G., Hall, D., Eds.; Routledge: London, UK, 2003.
42. Soper, A.K. Developing Mauritianness: National Identity, Cultural Heritage Values and Tourism. *J. Heritage Tour.* **2007**, *2*, 94–109. [CrossRef]
43. CSO, Central Statistical Office. 2019. Available online: <https://stat.gov.pl/> (accessed on 23 October 2019).
44. Krakow City Hall. *Sustainable Tourism Policy Cracow for the Years 2021–2028*; Tourism Department: Krakow, Poland, 2020.
45. Kruczek, Z.; Mazanek, L. Krakow as a Tourist Metropolitan Area. Impact of Tourism on the Economy of the City. *Studia Peregrinica* **2019**, *26*. [CrossRef]
46. Banaszkiwicz, M. A dissonant heritage site visited. The case of Nowa Huta in Kraków. *J. Tour. Cult. Chang.* **2017**, *15*, 185–197. [CrossRef]

47. *Tourist Potential and its Exploitation in the Years 2014–2018—Regional Approach*; GUS Statistical Office: Rzeszów, Poland, 2019.
48. Greenacre, M.; Hastie, T. The Geometric Interpretation of Correspondence Analysis. *J. Am. Stat. Assoc.* **1987**, *82*, 437–447. [[CrossRef](#)]
49. Stanisław, A. *Biostatystyka*; Wyd. Uniwersytetu Jagiellońskiego: Kraków, Poland, 2005; pp. 109–409.
50. Kendall, M.G. *Multivariate Analysis*; Charles Griffin: London, UK, 1975; pp. 3–198.



© 2020 by the authors. Licensee MDPI, Basel, Switzerland. This article is an open access article distributed under the terms and conditions of the Creative Commons Attribution (CC BY) license (<http://creativecommons.org/licenses/by/4.0/>).

Article

Economic Impact of the Health Insurance System on Slovak Medical Spas and Mineral Spring Spas

Ján Derco ^{1,*}, Piotr Romaniuk ² and Michal Cehlár ³

¹ Faculty of Mining, Ecology, Process Control and Geotechnologies, Technical University of Kosice, Nemcovej 32, 042 00 Kosice, Slovakia

² Department of Health Policy, School of Health Sciences in Bytom, Medical University of Silesia in Katowice, Ul. Piekarska 18, 41-902 Bytom, Poland; promaniuk@sum.edu.pl

³ Faculty of Mining, Ecology, Process Control and Geotechnologies, Technical University of Kosice, Letna 9, 042 00 Kosice, Slovakia; michal.cehlar@tuke.sk

* Correspondence: jan.derco@tuke.sk; Tel.: +421-055-602-2443

Received: 15 March 2020; Accepted: 18 April 2020; Published: 21 April 2020

Abstract: The article deals with the financing of spa undertakings through the health insurance system. The analysis is based on the financial statements of 28 spa undertakings operating in the Slovak Republic, their contracts with the individual health insurance companies and secondary data sources (accommodation statistics of these undertakings, the number of medical stays paid by clients themselves and of those covered by public health insurance, the spa treatment expenditure of the health insurance companies, the percentage of this expenditure out of the total expenditure spent by the health insurance companies on health care). The still significant percentage of revenues from the health insurance companies out of the total revenues of spa undertakings shows the prevalence of the medical nature of spa care. At the same time, it reflects the current tax measures related to the spa industry and shows that the introduction of a recreation allowance might influence the future development of spa care.

Keywords: health insurance; health tourism; medical spas; spa tourism; state support

1. Introduction

In the 20th century, the ownership of spa undertakings and the manner of financing spa care changed twice in the Slovak Republic. The first fundamental social and economic changes occurred after World War II. It has been noted that “these changes radically changed the quantitative and qualitative parameters of Slovak spas. The traditional picture of spa life as a leisure time and a way of social and cultural enjoyment was ideologically unacceptable for communists. With the rise of state centralization, regulated economy and state-owned health and social services, a significant reduction of the spa network took place” [1]. Act No. 125/1948 on the nationalization of natural healing springs and on the incorporation and management of confiscated property of 1948 was crucial for the fate of Slovak spas. Thus, the State acquired the exclusive right to dispose of the healing springs and the title to the property of the spas. The Act was also the first step towards the inclusion of the spa industry in a unified health system, excluding its economic use and inbound tourism [2]. Finally, the nationalization process resulted in all spa facilities being run by the single operator—the Czechoslovak State Spas [3]. Notably, “after the nationalization of spas and springs in 1948, the ratio between patients sent for treatment by the national insurance company and private spa guests (self-payers) began to change significantly. In 1948, policyholders (state-insured patients) accounted for only about 15% of all spa guests. In 1953, the ratio was already reversed—85% accounted for policyholders and only 15% for private spa guests—self-payers. In 1954, only 244 domestic and 53 foreign clients received treatment at the spas managed by the Main Administration of Specialized Medical Institutes, Spas and Springs at

their own expense. Although the number of beds reserved for self-payers had been growing since 1955, the percentage of spa clients who paid for their stays themselves was less than 2%. In these early years, the importance of spas as recreation and tourism centers was underestimated. New construction began in the 1960s of the 20th century, but not everywhere and not at the same time" [4].

The second significant change of the Slovak spas was their economic transformation during the changed political and social conditions that developed after 1990. According to the original plans, the restructuring of the state-owned Slovak medical spas was intended to create 14 joint-stock companies with 51% state participation, 5% was earmarked for voucher privatization, 5% intended for the municipalities in whose territories the spas were located, 3% for restitutions and 36% for public auction [5]. As the spa industry was considered to be one of the most lucrative and promising economic sectors within the Slovak economy, there was a lot of interest in its privatization. As a result, the original privatization plan was changed [6]. The municipal shareholdings rose to 10% and the shareholding intended to be sold within a public tender was increased to 51%. On the other hand, the shareholding allocated to the National Property Fund of the Slovak Republic decreased to 20–34% (state-owned shareholdings) [5]. The privatization of the spa undertakings was expected to help restore dilapidated buildings, improve services, invest in the renewal of healing springs and bring an influx of foreign clients [6]. For most of the spas, this process took place in the period of 1995–1997 [1]. The way the privatization was carried out [7] was questioned and criticized by the public. Responses to this criticism led to the transformation of the state-owned undertakings into newly formed joint-stock companies whose statutes guaranteed the preservation of the medical character of the spas. For this purpose, the state-owned General Health Insurance Company (Všeobecná zdravotná poisťovňa) retained minority shareholdings in the spa undertakings. The privatization of the Slovak medical spas was accompanied by legislative reforms affecting the Slovak spa industry and spa care [6].

The other changes that affected spa care were (1) the emergence of the health insurance market in the early 1990s and (2) the changeover in the spa care financing from the state to the health insurance companies in 2004. The health insurance system started to operate based on Act No. 7/1993 Coll. on the establishment of the National Insurance Company and on the financing of health, sickness and pension insurance. The Act led to the establishment of a single insurance company on 1 January 1993, which was the holder of compulsory health, sickness and pension insurance. The incompatibility of all three systems led to problems. The lack of finances in the health sector was, inter alia, caused by the fact that the state was not able to fully comply with its obligations to pay insurance for a large economically passive/inactive population. This subsequently created a problem of insufficient financing of health care. Due to these and other reasons, the National Insurance Company ceased to exist, and both the Social Insurance Agency responsible for the sickness and pension insurance system and the state-owned health insurance company (Všeobecná zdravotná poisťovňa) were established on 1 January 1995. Pursuant to Section 49 of Act No. 274/1994 Coll. on the Social Insurance Agency, spa care was covered by a special Social Insurance Agency account into which money was paid by the state. Under Act No. 273/1994 Coll., private health insurance companies could also be established from 1 January 1995. The health insurance market has stabilized gradually; there is currently only one state-owned health insurance company (Všeobecná zdravotná poisťovňa), and there are two private health insurance companies (Dôvera and Union) [6,8]. The Social Insurance Agency significantly reduced the purchase of 'spa vouchers' and the expenditures related to spa care. Therefore, the responsibility to pay for spa care was transferred from the Social Insurance Agency to the health insurance companies in 2004.

"Natural Curative Spas are medical facilities where healthcare is provided to stabilise the state of health, regeneration of health or prevention of diseases and which use natural healing water or weather conditions suitable for treating recognised under Act 538/2005 Coll. to provide health care" [9]. "Spa care indicated for health reasons is fully (category A) or partially (category B) covered by public health insurance. The indications and length of medical stays (21–28 days) are set forth in Act No. 577/2004 on the Scope of Health Care Covered by Public Health Insurance and on Payments for Services related to the Provision of Health Care" [10]. In the case of medical spa stays under

Category A, the insurance companies reimburse the costs of accommodation, catering services and spa care. However, clients have the option to pay for a higher standard of these services. The clients only pay a statutorily prescribed charge (€1.70 per night) and a local accommodation tax. In the case of indications of Category B, the insurance companies only reimburse the costs of health care (medical examination including diagnostic services, three treatment procedures per day on average and the administration of medicines in the case of acute diseases or deterioration of the state of health). Accommodation and catering services are chosen and paid by the clients themselves [11]. The financial stability of these undertakings is based on the balance between medical products covered by public health insurance and medical and wellness products reimbursed by patients [10]. Qualifying patient into Category A or B is dependent on the disease being treated, as specified in the Appendix 6 to Act No. 577/2004 on the Scope of Health Care Covered by Public Health Insurance and on Payments for Services related to the Provision of Health Care.

Regulation of prices related to spa care by health insurance companies does not take into account the needs of spa businesses but mainly the needs of insurance companies. In Slovakia [11–15], the Czech Republic [14,16] and Poland [17–23], spa therapy is an integral part of the public health system, but medical facilities providing these services also act as tourist establishments. The uncertainty of financing products with strong medical backgrounds have forced businesses to look for new products to be offered in this sector, the financing of which would not be bound only to public finances. Short stays marketed as wellness, medical wellness or relaxation include activities aimed at improving mental and physical conditions, as these treatments are not specifically used for the treatment of concrete diseases. Its funding is not regulated and prices reflect actual costs [9].

Smith and Puczkó [24] described regional and cultural differences in understandings of European health and wellness tourism in Northern, Western, Southern, Central and Eastern Europe. It is difficult to compare medical services provided in the Slovak spas with those of other destinations [25–35]. This is due to the different legislative framework in each country. There is also variance in the level of social or health care coverage. The issues of the spas' orientation towards the target clientele according to the analyzed forms of reimbursement, the dependence of their financing on the health insurance system and the percentage of such financing (plus other factors mentioned in this article) are crucial in any legislative changes and discussion about them. An example of this is the crisis situation in the Czech Republic in 2013 after the adoption of a restrictive indication list, which shortened the length of spa stays for certain diagnoses, reduced re-stays, introduced regulatory fees and canceled the reimbursement of stay costs for certain diagnoses from public health insurance [32,35]. The current legislative framework for this kind of business imposes strict requirements not only on the material and technical equipment and staff of natural medical spas, but also on the use and protection of natural healing springs, their monitoring, recognition of climatic conditions suitable for treatment and their protection, the protection of the spa area and spa environment requirements. Meeting these criteria requires resources to cover costs which are not expended by hotels focused solely on the wellness segment. This aspect should be taken into account when assessing the competitiveness of spa facilities and non-medical facilities. At the same time, however, the issue of financing these undertakings is important not only for the undertakings themselves and for the local economy built on the use of natural healing springs in spa facilities, but also in terms of the aforementioned environmental aspects and a sustainable spa care concept.

The aims of this article are:

1. to analyze the development and changes of financial conditions related to spa treatment in Slovakia in years 2006–2018. We also analyze the percentage of medical spa care expenditure compared to the total health care expenditure of the health insurance companies.
2. to determine the proportion/importance of the medical segment covered by public health insurance in relation to the segment of self-payers seeking wellness or medical wellness (care under medical supervision with the use of natural healing springs for balneotherapy).

3. to analyze correlations between revenues of spas and after-tax profits of spas with the factors determining their infrastructural and financial environment.

2. Materials and Methods

Mainil et al. [36] states that “distinguishing the size of each of the markets in health tourism (i.e., medical, wellness and spa tourism) in the EU is difficult due to the limited and fragmented data available and the wide (and often overlapping) scope of the definitions used by different sources and statistical bureaus”. This analysis is based on secondary data sources [37–51]. The data on the amount of financially recognized services paid out of public health insurance to natural medical spas and the percentage of this expenditure out of the total expenditure spent by the health insurance companies on health care are sourced from the Reports on the state of public health insurance for 2005–2018, as published by the Health Care Surveillance Authority [52–65]. The current amount of reimbursements is obtained from the contracts between the individual health insurance companies and the spa undertakings. The accommodation statistics contain data from Monthly Accommodation Facility Activities Reports to be submitted by the accommodation facilities to the Statistical Office of the Slovak Republic. The National Health Information Centre collects client data through Completed Spa Treatment Reports and the Annual Report on Natural Medical Spas.

The data on revenues (from the sale of services and goods) and after-tax profits of 28 natural medical spas operating in the Slovak Republic have been obtained from the public register of financial statements (<http://www.registeruz.sk/cruzpublic/domain/accountingentity/simplesearch>), which has been publishing the financial statements of companies since 2013. For the purpose of statistical analyses, we applied descriptive statistical methods as well as the Shapiro-Wilk test to verify the normality of distribution of data. Since non-normal distribution had been observed in most cases, the correlation analyses were performed using non-parametric methods, namely Spearman’s correlation test [31] and Kendall’s tau test. All statistical analyses were performed using Statistic aver. 13.3 software (TIBCO, Palo Alto, CA, USA).

3. Results

Table 1 provides basic information on the financing of medical spa treatment by public health insurance in Slovakia in the years 2006–2018, along with data on total revenues of the spa companies for the years 2013–2018 and their profits in the same period. From the presented data, we can observe that in 2006–2018, the amount of expenditure of insurance companies on medical spa treatment grew on a year-over-year basis, with the exception of the years 2012, where the amount was comparable to the previous year, and 2014, where a decrease appeared compared to 2013. The growth in nominal expenditure however did not directly translate into the increase of the share of spending on spa treatment in the total expenditure of health insurance companies. In the reporting period, this share accounted for 0.88–1.5% of total expenditure, presenting an upward trend up to 2011, but decreasing in the following years, despite general increase in nominal expenditure. The total revenues of spa companies in a given period generally showed a growing trend, while the share of income gained from insurance companies in their total revenues, after a decrease between 2013 and 2014, generally remained at a similar level, with some slight fluctuations between years. A similar situation tends to appear in terms of spa companies’ profits, which do not show a clear trend, although losses only appeared once instead of profits, and profits generally appeared to be visibly higher in 2018 compared to in previous years.

To verify what the possible determinants of spa companies’ financial results are, we decided to apply correlation tests comparing companies’ revenues and profits with a set of factors potentially determining them. Results are presented in Table 2.

Table 1. Services of spa undertakings financially recognized by the health insurance companies (EUR) and their percentage in the total health care expenditures of the health insurance companies in 2006–2018, revenues (from the sale of services and goods) and profits/losses of spa undertakings (EUR) in 2013–2018.

	2006	2007	2008	2009	2010	2011	2012
Public health insurance expenditure on medical spa treatment	16,698,883	25,546,905	36,240,453	42,156,543	44,680,727	49,241,510	46,429,978
Percentage of medical spa treatment expenditure out of the total expenditure of the health insurance companies	0.88	1.04	1.23	1.31	1.35	1.50	1.38
	2013	2014	2015	2016	2017	2018	
Public health insurance expenditure on medical spa treatment	49,524,141	47,867,905	48,924,934	52,365,195	52,887,253	56,112,848	
Percentage of medical spa treatment expenditure out of the total expenditure of the health insurance companies	1.39	1.25	1.23	1.24	1.00	1.25	
Revenues of spa undertakings in 2013–2018	139,655,694	146,578,286	146,347,229	156,236,005	162,570,995	169,661,551	
Percentage of reimbursements from the health insurance companies in the revenues of spa undertakings	35.46	32.66	33.43	33.52	32.53	33.07	
After-tax profits of spa undertakings in 2013–2018	4,866,307	4,092,029	5,830,157	−2,403,112	5,687,645	6,114,908	

Source: [52–65], The data on revenues (from the sale of services and goods) and after-tax profits of spa undertakings have been obtained from the public register of financial statements (<http://www.registeruz.sk/cruzpublic/domain/accountingentity/simplesearch>).

Table 2. Spearman’s and Kendall’s tests comparing companies’ after-tax profits and revenues with a set of factors potentially determining them.

	Kendall’s Tau	Profits	Revenues
Numbers of beds		−0.333333	−0.600000
Number of domestic visitors		0.066667	0.600000
Number of which medical stays reimbursed by the insurance company		0.066667	0.866667
Number of which medical stays reimbursed by the patient		0.466667	0.733333
Number of nights spent at spa companies by domestic visitors		0.200000	0.733333
Number of foreign visitors		−0.333333	−0.333333
Number of medical stays reimbursed by the insurance company		−0.466667	−0.200000
Number of medical stays reimbursed by the patient		−0.333333	−0.333333
Number of nights spent at spa companies by foreign visitors		−0.333333	−0.866667
Total number of visitors		0.066667	0.600000
Total number of nights spent at spa companies		0.066667	0.866667
Number of medical stays in spa facilities		0.333333	0.600000
Public health insurance expenditure on medical spa treatment (EUR)		0.333333	0.600000
Total healthcare expenditures financially recognized by the health insurance companies (EUR)		0.333333	0.866667
The percentage of medical spa care expenditure out of the total health care expenditure of the health insurance companies		−0.200000	−0.200000
Gross Domestic Product of Slovakia at current prices (nominal GDP) (Million EUR)		0.333333	0.866667
	Spearman’s Test	Profits	Revenues
Numbers of beds		−0.371429	−0.657143
Number of domestic visitors		0.028571	0.771429
Number of medical stays reimbursed by the insurance company		0.142857	0.942857
Number of medical stays reimbursed by the patient		0.542857	0.828571
Number of nights spent at spa companies by domestic visitors		0.314286	0.885714
Number of foreign visitors		−0.600000	−0.428571
Number of medical stays reimbursed by the insurance company		−0.657143	−0.257143
Number of medical stays reimbursed by the patient		−0.485714	−0.485714
Number of nights spent at spa companies by foreign visitors		−0.485714	−0.942857
Total number of visitors		0.028571	0.771429
Total number of nights spent at spa companies		0.142857	0.942857
Number of medical stays in spa facilities		0.428571	0.771429
Public health insurance expenditure on medical spa treatment (EUR)		0.428571	0.771429
Total healthcare expenditure financially recognized by the health insurance companies (EUR)		0.485714	0.942857
The percentage of medical spa care expenditure out of the total health care expenditures of the health insurance companies		−0.257143	−0.257143
Gross Domestic Product of Slovakia at current prices (nominal GDP) (Million EUR)		0.485714	0.942857

Source: processed by P.R.

Both Spearman's and Kendall's tests showed similar results, despite some slight differences in exact values of the correlation coefficient. We found that both revenues and profits are negatively and with a moderate or weak strength correlated with the global number of beds in spa companies, which may be interpreted as a symptom of the restructuring processes taking place in the companies and their efforts to optimize infrastructure. Similarly, a negative correlation appears in the case of the number of foreign visitors to spa companies operating in Slovakia. This correlation generally appears to be weak, although a stronger one has been shown by the Spearman's test in the case of after-tax profits. On the other hand, an interesting fact has been observed in relation to the general number of visitors and the number of domestic visitors to spa companies. In both cases a positive correlation exists, both with regard to revenues and profits. However, for revenues, this correlation is relatively strong and statistically significant when it comes to the numbers given in categories of reimbursed and self-paid stays, while in the case of profits, it appears to be positive but extremely weak. Interestingly, it is stronger, moderate in a general manner, although not statistically significant, for stays self-paid by patients. The dependence on public resources as a main source of income seems to be reflected by the correlation that appears in the case of total public expenditure on health care. Interestingly, this correlation is higher for general expenditure than for the part intended for spa treatment. Moreover, correlation with the factor showing the share of expenditure on spa treatment in general health expenditure appears to be negative and weak at the same time, while the value of the correlation coefficient with Slovak GDP takes the same values as in the case of correlation with general health expenditure.

4. Discussion

In our study, we observed several interesting facts regarding the operation of spa companies in Slovakia. Correlation analyses may lead to an interpretation that companies in general are becoming more dependent on domestic clients rather than on foreign ones, and that the revenues coming from public health insurance play a crucial and probably a growing role as their source of income. Profitability of the stays remains at a low level, being at the same time visibly higher in the case of self-paid patients. These observations seem to be confirmed by general data regarding development of the spa sector in Slovakia. In 2018, 28 Slovak natural medical spas operated 77 accommodation facilities. The total number of clients reached 311,963, of which 248,413 were domestic and 63,550 foreign clients. Out of this number, 72,702 domestic policyholders and 197 foreign policyholders received medical spa treatment paid for by a health insurance company. Another 73,128 domestic clients and 33,186 foreign clients received medical spa treatment paid by the patients themselves. Spa treatment is most often indicated for a group of musculoskeletal disorders—Vertebrogenic syndrome with transient painful spine disorders, post-traumatic conditions or conditions after musculoskeletal operations (mainly related to the following diagnoses: M40–M54 Spine and back diseases, M17 Gonarthrosis—arthrosis of the knee joint and M16 Coxarthrosis—arthrosis of the hip joint). The next most common reasons for treatment are non-tuberculous respiratory diseases and circulatory system diseases [66]. The remaining clients are accompanying persons (spouse of the client, mother with a child on medical stay, guide for the disabled) or guests who buy non-medical wellness products (such as weekend wellness stays including access to the aqua park, saunas or steam baths, but without a prescription for traditional balneological procedures provided by a specialist).

The rate of occupancy of permanent beds in the spa undertakings reached 66.3%. The average number of overnights spent by domestic visitors was 9.4 and of those spent by foreign visitors was 7.2. When comparing these data with the data for 2005–2017 [10,37,38], it can be stated that: (1) an increase in the total number of clients occurred; (2) an increase in the number of medical stays of domestic clients covered by public health insurance (in 2018) or of those who paid themselves for their stays (in 2016–2018) occurred, (3) the number of foreign visitors has stabilized since 2009, (4) the traditional exploitation of natural healing springs for treatment, its connection to the public health insurance system and the level of spa treatments resulted in an increasing prevalence of medical stays (according

to data on the total number of clients and the number of clients who received medical spa treatment). In 2006–2018, the amount of financially recognized services performed by spa undertakings grew on a year-over-year basis, with the exception of the years 2012 and 2014. In the reporting period, the percentage of this expenditure out of the total health care expenditure of the health insurance companies accounted for 0.88–1.5%. A noteworthy fact is that the share of expenditure on spa services in the case of Slovak health insurance generally appears to be higher than for in neighbouring Poland, where after implementation of the health insurance in 1999, it remains at relatively stable level of circa 1% [67,68]. Despite this fact, the Association of Slovak Spas proposes that the percentage of spa care expenditures be increased. This proposal seems to be well grounded in data regarding financial operation of spa companies, where the increase of stays and income not necessarily translates into better financial stability and profitability, as shown in our study, especially by the negative correlation between the share of spa treatment expenditure out of general health expenditure for health insurance. It is likely that the revenues and income of spa companies reflect the general condition of the Slovak economy, and thus its influence on health care financing, rather than any changes in policy of insurance companies regarding spa treatment. This observation is similar to that in Poland, where the expenditure are is perceived as being insufficient to sustain financial stability of the spa companies, despite the nominal increase in expenditure [69].

The share of reimbursements from the health insurance companies in 2013–2018 accounted for approximately one third of the revenues of spa undertakings. The losses reported in the spa sector in 2016 were due to the poor economic performance of one spa, which is currently being restructured. The impact of restrictive measures of the health insurance companies on the economy of the individual spa companies is mainly reflected in the amount of reimbursement provided by the health insurance companies per patient (treatment day). The amount of reimbursements by the health insurance companies per treatment day for indication group A ranges between €32.50 and €50.50, and for indication group B it ranges between €20.00 and €24.30. The current situation is a natural consequence of the health insurance companies giving their preference to reimbursements for medicines, outpatient care and institutional care in hospitals. The solution is the currently adopted state support for accommodation facilities, including spa undertakings (in the segments of medical stays not covered by public health insurance, medical stays for indication group B, stays designated as medical wellness or wellness paid by self-payers), investments into the reconstruction and modernization of buildings, better promotion in the countries that are the main source markets (Czech Republic, Germany, Israel, Poland, Russia and Austria). For Europe, Directive 2011/24/EU on the application of patients' rights in cross-border healthcare regulates patients' rights for reimbursement in cross-border health care and has an important impact on the mobility of medical tourists. Four Slovak spa facilities hold the international European quality certificate EuropeSpa med. This certification is of particular importance if the spas wish to provide spa care to foreigners to a larger extent.

The state support for accommodation facilities, including spa undertakings, is based on four instruments. (1) Decreasing the value-added tax [70] on accommodation services from 20% to 10% as of 1 January 2019. (2) At the same time, as of 1 January 2019, an entity employing more than 49 employees is obliged to provide a recreation allowance. Employees, whose employment relationship with the employer lasts for at least 24 consecutive months, may apply for a recreation allowance from the employer. The employer is obliged to pay the employee a recreation allowance in the amount of 55% of the recreation expenses, but not more than €275 per calendar year. Eligible recreation expenses are expenses demonstrably incurred by the employee on tourism services related to accommodation for at least two nights in the Slovak Republic. The employer is obliged to contribute not only to the recreation of the employee, but also to the recreation of the spouse and the child of the employee and other persons living in a common household with the employee, provided that they are on holiday together with the employee. From the employee's point of view, recreation allowances provided to the employee by his/her employer are exempt from income tax, while the employee and employer do not pay any health and social insurance contributions on such allowances. For employers (including natural

persons with income from business and other self-employment activities), recreation allowances are a tax-deductible expense according to Act No. 595/2003 Coll. on Income Tax, which reduces their income tax base. This support could increase the percentage of short-term wellness stays in the following years. (3) Demonstrably paid reimbursements related to spa care incurred in natural medical spas shall, from 1 January 2018, be deemed a non-taxable part of a natural person's tax base. The non-taxable part of the tax base for spa care may include payments for spa treatments provided, including payments for meals and accommodation made by the taxpayer and which are not paid to the natural person from other sources, e.g., paid out of public health insurance or by the employer as a recreation allowance, while the duration of the stay in the spa is not decisive. The non-taxable part of the tax base for spa care may be applied by a natural person as evidenced by proof of payment, but cannot be more than €50 per year for each person for whom the non-taxable part of the tax base is applied (spouse and child). (4) At the same time, more favorable tax treatment is given to reconstruction and modernization works on buildings which are located in the spa area, are used for spa care, and are part of a natural medical spa. From a tax perspective, they are treated as other assets that are depreciated separately from the building (which are currently depreciated over a period of 40 years) and are included in the depreciation group with a depreciation period of 6 years.

The limiting factor of this study is the fact that it does not take into account the impact of governmental instruments furthering domestic and spa tourism. The assessment of medically recognized services submitted by natural medical spas for settlement (and checked in the health insurance information system) may result in more accurate results. At the same time, further research should focus on the cost-benefit analysis of the costs of additional pharmacological treatment and reimbursements to physiotherapeutic rehabilitation clinics and departments in the event that spa treatment expenditure is reduced by health insurance companies. As such, further research is still required in this field.

5. Conclusions

Financial resources for spa treatment coming from public health insurance generally showed a growing trend in years 2006–2018. Nonetheless, the share of expenditure on spa treatment out of general expenditure on health services, after an increase between the years 2006–2011, did not show any clear trend in the following years, appearing in a scale between 1 and 1.39% in the second part of the investigated period. Public health insurance appears to be the dominant source of income for spa companies operating in Slovakia, having the biggest influence on its revenues. Self-paying patients in turn seem to be more profitable for spa companies. A decreasing role of foreign patients in generating income for spa companies appears in the investigated period. The possibility of attracting foreign visitors seems not to be taken advantage of by the companies in a scale adequate to its potential. Revenues of spa companies in Slovakia show the highest correlation with domestic visitors' medical stays paid by health insurance, as well as with general health expenditures of health insurance companies and GDP of the Slovak Republic. The revenues therefore reflect the general condition of the Slovak economy and its influence on health care financing rather than any changes in policy of insurance companies regarding spa treatment. The level of financing spa treatment by health insurance is being perceived as being too low, which is confirmed by visibly weak correlations between spa companies' after-tax profits and medical stays covered by health insurance, as well as general spending of health insurance funds on spa treatment.

Author Contributions: Conceptualization, J.D. and P.R.; Methodology, J.D. and P.R.; Software, P.R.; Validation, J.D. and P.R.; Formal Analysis, P.R.; Investigation, J.D. and P.R.; Resources, J.D. and P.R.; Data Curation, J.D. and P.R.; Writing—Original Draft Preparation, J.D., P.R. and M.C.; Writing—Review and Editing, J.D. and P.R.; Visualization, J.D. and P.R.; Supervision, J.D. and P.R.; Project Administration, M.C.; Funding Acquisition, M.C. All authors have read and agreed to the published version of the manuscript.

Funding: The article was publishing as a part and with financial support of the Scientific Grant Agency of the Ministry of Education, Science, Research and Sport of the Slovak Republic and the Slovak Academy of Sciences No. VEGA 1/0515/18 “The decision-making model of process of evaluating raw material policy of regions”.

Conflicts of Interest: The authors declare no conflict of interest. The funders had no role in the design of the study; in the collection, analyses, or interpretation of data; in the writing of the manuscript, or in the decision to publish the results.

References

1. Kasagrandá, A.; Gurnák, D. Spa and Wellness Tourism in Slovakia (A Geographical Analysis). *Czech J. Tour.* **2017**, *6*, 27–53. [[CrossRef](#)]
2. Fialová, D.; Orosz, Ö. Vývoj lázeňství na území dnešního Slovenska (v období od konce 16. století do současnosti) [Development of spa industry in the territory of present-day Slovakia (from the end of the 16th century to the present)]. *Kladyán: Internetový Časopis Pro Hist. Geogr. A Enviromentální Dějiny* **2012**, *8–9*, 94–106.
3. Kraftová, I.; Masuyama, Y.; Matěja, Z.; Kornfeldová, M. Společenská odpovědnost v lázeňství: Shody či rozdíly? (Komparativní studie českého a Japonského prostředí) [Corporate social responsibility in spa industry: Equalities or differences? (comparative study of Czech and Japanese environment)]. *E+M Ekon. A Manag.* **2011**, *14*, 123–136.
4. Mulík, J. *Dejiny kúpeľov a kúpeľníctva na Slovensku [History of spas and spa industry in Slovakia]*, 1st ed.; Osveta: Martin, Czechoslovakia, 1981; p. 187.
5. Eliašová, D. *Slovenské kúpeľníctvo v 20. Storočí [Slovak spas in the 20th century]*, 1st ed.; Ekonóm: Bratislava, Slovakia, 2009; p. 201.
6. Kmeco, L. Development of the Spa Industry and Its Legislation in Slovakia since 1989. *Studia Tur.* **2019**, *10*, 37–49.
7. Williams, A.M.; Baláž, V. Privatisation and the development of tourism in the Czech Republic and Slovakia: property rights, firm performance, and recombinant property. *Environ. Plan. A* **2000**, *32*, 715–734. [[CrossRef](#)]
8. Nemeč, J.; Lawson, C. Health policy in Slovakia and the outcomes of health care reforms: 1989–2003. *J. Comp. Policy Anal. Res. Pract.* **2005**, *7*, 49–71. [[CrossRef](#)]
9. Derco, J. The Slovak spas in the light of the health care system. *Tour. Plan. Dev.* **2014**, *11*, 243–252. [[CrossRef](#)]
10. Derco, J.; Pavlisinová, D. Financial position of medical spas—the case of Slovakia. *Tour. Econ.* **2017**, *23*, 867–873. [[CrossRef](#)]
11. Derco, J. Impact of health care funding on financial position of Slovak medical spas. *Turiz. Medunardni Znan. Stručni Časopis* **2017**, *65*, 376–380.
12. Holub, D.; Magurová, H.; Kropaj, M. Legislation of spa industry as a part of tourism in the Slovak Republic. In *Právo v Podnikání Vybraných Členských Států Evropské Unie*, 1st ed.; Štěpánková, K., Ed.; TROAS Ltd.: Prague, Czech Republic, 2017; Volume 9, pp. 78–84.
13. Kerekeš, J. *Kúpeľníctvo a jeho Význam v Turizme [Spa industry and its importance in tourism]*, 1st ed.; Weltprint Ltd.: Bratislava, Slovakia, 2018; p. 285.
14. Kotikova, H.; Schwartzhoffova, E. Health and spa tourism in the Czech and Slovak Republics. In *Medical tourism: The Ethics, Regulation, and Marketing of Health Mobility*, 1st ed.; Hall, C.M., Ed.; Routledge: Abingdon, UK, 2013; pp. 109–122. [[CrossRef](#)]
15. Marčeková, R.; Pompurová, K.; Gúčík, M. *Zdravotný Cestovný Ruch [Health tourism]*, 1st ed.; Belianum Matej Bel University Press: Banská Bystrica, Slovakia, 2015; p. 168.
16. Vystoupil, J.; Šauer, M.; Bobková, M. Spa, Spa Tourism and Wellness Tourism in the Czech Republic. *Czech J. Tour.* **2017**, *6*, 5–26. [[CrossRef](#)]
17. Dryglas, D.; Różycki, P. Profile of tourists visiting European spa resorts: a case study of Poland. *J. Policy Res. Tour. Leis. Events* **2017**, *9*, 298–317. [[CrossRef](#)]
18. Dryglas, D.; Salamaga, M. Segmentation by push motives in health tourism destinations: A case study of Polish spa resorts. *J. Destin. Mark. Manag.* **2018**, *9*, 234–246. [[CrossRef](#)]
19. Dryglas, D.; Salamaga, M. Applying destination attribute segmentation to health tourists: A case study of Polish spa resorts. *J. Travel Tour. Mark.* **2017**, *34*, 503–514. [[CrossRef](#)]
20. Kapczyński, A.; Szromek, A.R. Hypotheses concerning the development of polish spas in the years 1949–2006. *Tour. Manag.* **2008**, *29*, 1035–1037. [[CrossRef](#)]
21. Szromek, A.R.; Wybrańczyk, K. Proposal of Value for Customer of Spas: Expectations of Spa Patients and Tourist in Polish Spas. *Sustainability* **2019**, *11*, 3598. [[CrossRef](#)]
22. Szromek, A.R.; Naramski, M. A Business Model in Spa Tourism Enterprises: Case Study from Poland. *Sustainability* **2019**, *11*, 2880. [[CrossRef](#)]

23. Szromek, A.R.; Romaniuk, P.; Hadzik, A. The privatization of spa companies in Poland - an evaluation of policy assumptions and implementation. *Health Policy* **2016**, *120*, 362–368. [CrossRef]
24. Smith, M.; Puczko, L. Taking your life into your own hands? New trends in European health tourism. *Tour. Recreat. Res.* **2010**, *35*, 161–172. [CrossRef]
25. Gustavo, N.S. A 21st-century approach to health tourism spas: The case of Portugal. *J. Hosp. Tour. Manag.* **2010**, *17*, 127–135. [CrossRef]
26. Vilar Rodriguez, M.; Lindoso Tato, E. From the belle epoque to the new era of spa tourism: spas in Spain in historical perspective (1874–2016). *AYER* **2019**, *114*, 23–64.
27. Smith, M. Baltic health tourism: Uniqueness and commonalities. *Scand. J. Hosp. Tour.* **2015**, *15*, 357–379. [CrossRef]
28. Matlovičová, K.; Šimčík, D. Spa and Wellness Tourism in Estonia. *Geogr. Cassoviensis* **2010**, *4*, 108–113.
29. Snoj, B.; Mumel, D. The measurement of perceived differences in service quality—The case of health spas in Slovenia. *J. Vacat. Mark.* **2002**, *8*, 362–379. [CrossRef]
30. Nikoli, G.; Lazakidou, A. A review of thermal tourism in Europe and Greece. *Turiz. Međunarodni Znan. Stručni Časopis* **2019**, *67*, 318–322.
31. Vrkljan, S.; Hendija, Z. Business performance of health tourism service providers in the Republic of Croatia. *Acta Clin. Croat.* **2016**, *55*, 79–85. [CrossRef] [PubMed]
32. Trnka, S. Efficacious holidays: The therapeutic dimensions of pleasure and discipline in Czech respiratory spas. *Med Anthropol. Q.* **2018**, *32*, 42–58. [CrossRef]
33. Pforr, C.; Locher, C. The German spa and health resort industry in the light of health care system reforms. *J. Travel Tour. Mark.* **2012**, *29*, 298–312. [CrossRef]
34. Hofer, S.; Honegger, F.; Hubeli, J. Health tourism: definition focused on the Swiss market and conceptualisation of health(i)ness. *J. Health Organ. Manag.* **2012**, *26*, 60–80. [CrossRef]
35. Vavrečková, E.; Stuchlíková, J.; Dluhošová, R. The Results of the Development of Balneal Care Provision and the State of the Czech Spa Industry in Connection with the Changes in Legislation. *Czech J. Tour.* **2017**, *6*, 93–104. [CrossRef]
36. Mainil, T.; Eijgelaar, E.; Klijs, J.; Nawijn, J.; Peeters, P. *Research for TRAN Committee—Health Tourism in the EU: A General Investigation*, 1st ed.; European Parliament, Policy Department for Structural and Cohesion Policies: Brussels, Belgium, 2017; p. 27.
37. Spa Tourism 2018—Accommodation Statistics of Tourism in Slovakia. Available online: <https://www.mindop.sk/ministerstvo-1/cestovny-ruch-7/statistika/kupelny-cestovny-ruch> (accessed on 5 December 2019).
38. Health Statistics Yearbook of the Slovak Republic 2018. Available online: http://www.nczisk.sk/Statisticke_vystupy/Zdravotnicka_rocenka/Pages/default.aspx (accessed on 5 December 2019).
39. Health Statistics Yearbook of the Slovak Republic 2017. Available online: http://www.nczisk.sk/Statisticke_vystupy/Zdravotnicka_rocenka/Pages/Archiv.aspx (accessed on 5 December 2019).
40. Health Statistics Yearbook of the Slovak Republic 2016. Available online: http://www.nczisk.sk/Statisticke_vystupy/Zdravotnicka_rocenka/Pages/Archiv.aspx (accessed on 5 December 2019).
41. Health Statistics Yearbook of the Slovak Republic 2015. Available online: http://www.nczisk.sk/Statisticke_vystupy/Zdravotnicka_rocenka/Pages/Archiv.aspx (accessed on 5 December 2019).
42. Health Statistics Yearbook of the Slovak Republic 2014. Available online: http://www.nczisk.sk/Statisticke_vystupy/Zdravotnicka_rocenka/Pages/Archiv.aspx (accessed on 5 December 2019).
43. Health Statistics Yearbook of the Slovak Republic 2013. Available online: http://www.nczisk.sk/Statisticke_vystupy/Zdravotnicka_rocenka/Pages/Archiv.aspx (accessed on 5 December 2019).
44. Health Statistics Yearbook of the Slovak Republic 2012. Available online: http://www.nczisk.sk/Statisticke_vystupy/Zdravotnicka_rocenka/Pages/Archiv.aspx (accessed on 5 December 2019).
45. Health Statistics Yearbook of the Slovak Republic 2011. Available online: http://www.nczisk.sk/Statisticke_vystupy/Zdravotnicka_rocenka/Pages/Archiv.aspx (accessed on 5 December 2019).
46. Health Statistics Yearbook of the Slovak Republic 2010. Available online: http://www.nczisk.sk/Statisticke_vystupy/Zdravotnicka_rocenka/Pages/Archiv.aspx (accessed on 5 December 2019).
47. Health Statistics Yearbook of the Slovak Republic 2009. Available online: http://www.nczisk.sk/Statisticke_vystupy/Zdravotnicka_rocenka/Pages/Archiv.aspx (accessed on 5 December 2019).
48. Health Statistics Yearbook of the Slovak Republic 2008. Available online: http://www.nczisk.sk/Statisticke_vystupy/Zdravotnicka_rocenka/Pages/Archiv.aspx (accessed on 5 December 2019).

49. Health Statistics Yearbook of the Slovak Republic 2007. Available online: http://www.nczisk.sk/Statisticke_vystupy/Zdravotnicka_rocenka/Pages/Archiv.aspx (accessed on 5 December 2019).
50. Health Statistics Yearbook of the Slovak Republic 2006. Available online: http://www.nczisk.sk/Statisticke_vystupy/Zdravotnicka_rocenka/Pages/Archiv.aspx (accessed on 5 December 2019).
51. Health Statistics Yearbook of the Slovak Republic 2005. Available online: http://www.nczisk.sk/Statisticke_vystupy/Zdravotnicka_rocenka/Pages/Archiv.aspx (accessed on 5 December 2019).
52. Report on the State of Public Health Insurance for 2018. Available online: <http://www.udzs-sk.sk/web/sk/spravy> (accessed on 5 December 2019).
53. Report on the State of Public Health Insurance for 2017. Available online: <http://www.udzs-sk.sk/web/sk/spravy> (accessed on 5 December 2019).
54. Report on the State of Public Health Insurance for 2016. Available online: <http://www.udzs-sk.sk/web/sk/spravy> (accessed on 5 December 2019).
55. Report on the State of Public Health Insurance for 2015. Available online: <http://www.udzs-sk.sk/web/sk/spravy> (accessed on 5 December 2019).
56. Report on the State of Public Health Insurance for 2014. Available online: <http://www.udzs-sk.sk/web/sk/spravy> (accessed on 5 December 2019).
57. Report on the State of Public Health Insurance for 2013. Available online: <http://www.udzs-sk.sk/web/sk/spravy> (accessed on 5 December 2019).
58. Report on the State of Public Health insurance for 2012. Available online: <http://www.udzs-sk.sk/web/sk/spravy> (accessed on 5 December 2019).
59. Report on the State of Public Health Insurance for 2011. Available online: <http://www.udzs-sk.sk/web/sk/spravy> (accessed on 5 December 2019).
60. Report on the State of Public Health Insurance for 2010. Available online: <http://www.udzs-sk.sk/web/sk/spravy> (accessed on 5 December 2019).
61. Report on the State of Public Health Insurance for 2009. Available online: <http://www.udzs-sk.sk/web/sk/spravy> (accessed on 5 December 2019).
62. Report on the State of Public Health Insurance for 2008. Available online: <http://www.udzs-sk.sk/web/sk/spravy> (accessed on 5 December 2019).
63. Report on the State of Public Health Insurance for 2007. Available online: <http://www.udzs-sk.sk/web/sk/spravy> (accessed on 5 December 2019).
64. Report on the State of Public Health Insurance for 2006. Available online: <http://www.udzs-sk.sk/web/sk/spravy> (accessed on 5 December 2019).
65. Report on the State of Public Health Insurance for 2005. Available online: <http://www.udzs-sk.sk/web/sk/spravy> (accessed on 5 December 2019).
66. Spa Care in the Slovak Republic in 2018. Available online: http://www.nczisk.sk/statisticke_vystupy/tematicke_statisticke_vystupy/Kupelna_starostlivost/Pages/default.aspx (accessed on 5 April 2020).
67. Suchecka, J.; Jaworska, R. Finansowanie Publiczne i Realizacja świadczeń lecznictwa uzdrowiskowego w Polsce w latach 2003–2014 [The Public Financing and Implementation of Health Resort Services in Poland in the years 2003–2013]. *Probl. Zarządzania* **2015**, *13*, 216–230. [CrossRef]
68. Romaniuk, P.; Holecki, T. Finansowanie świadczeń uzdrowiskowych w Polsce [Financing of spa services in Poland]. In *Rola Uzdrawisk i Przedsiębiorstw Uzdrawiskowych w Turystyce i Lecznictwie Uzdrawiskowym*, 1st ed.; Szromek, A.R., Ed.; Proksenia: Kraków, Poland, 2014; pp. 177–192.
69. Szromek, A.R.; Romaniuk, P. Ubezpieczenie uzdrowiskowe kuracjuszy—Trzy propozycje rozwiązań systemowych w ramach ubezpieczenia zdrowotnego [Spa insurance for patients—Three proposals for system solutions as part of health insurance]. In *Uzdrowiska i ich funkcja turystyczno-lecznicza*, 1st ed.; Szromek, A.R., Ed.; Proksenia: Kraków, Poland, 2012; pp. 275–296.
70. Pavliková, L.; Bánociová, A.; Jakubiková, E. The Practical Application of Value Added Tax in the Slovak Republic in the Spa Facilities. *Procedia Econ. Financ.* **2014**, *15*, 192–199. [CrossRef]



© 2020 by the authors. Licensee MDPI, Basel, Switzerland. This article is an open access article distributed under the terms and conditions of the Creative Commons Attribution (CC BY) license (<http://creativecommons.org/licenses/by/4.0/>).

Article

Sharing Economy and Lifestyle Changes, as Exemplified by the Tourism Market

Agnieszka Niezgoda and Klaudyna Kowalska *

Department of International Economics, Institute of International Business and Economics, Poznań University of Economics and Business, Al. Niepodległości 10, 61-875 Poznań, Poland; agnieszka.niezgoda@ue.poznan.pl

* Correspondence: klaudyna.kowalska@ue.poznan.pl

Received: 30 April 2020; Accepted: 29 June 2020; Published: 2 July 2020

Abstract: The aim of the article is to analyze the relationship between lifestyle changes and willingness to use sharing economy services in tourism, including peer-to-peer accommodation. On the one hand, knowledge of lifestyle changes can help adapt the product offer to the requirements of consumers. On the other hand, products that consumers use can reflect lifestyle changes. The following classification of motivations for sharing economy activity selection resulting from the subjects' lifestyles has been proposed: personal motivations—related to economic advantages; social (conformist) motivations—resulting from the need to fit in with others; and ideological motivation—resulting from the understanding of the processes of natural environment degradation and excessive consumption. In order to gather opinions and to understand behaviors, attitudes, and preferences regarding sharing economy activities (i.e., the sharing of transportation, food, clothes, equipment, and accommodation), the focus group interview method was used (6 groups, 5–8 participants each). Discussions were conducted separately for two populations: young with time (YT) and older rich (OR). The study demonstrates lifestyle changes between the generations. YT actions are the consequence of personal and ideological motivations. OR have lifestyles that result from personal and conformist motivations. Neither population sees a relationship between participating in the sharing economy and caring for the environment and preventing excessive consumption.

Keywords: consumer behavior; lifestyle; sharing economy; peer-to-peer accommodation; tourism market

1. Introduction

The growing importance of the sharing economy is a consequence of many simultaneous changes: the global economic crisis, growing concerns about sustainable consumption, the development of information and communication technologies (ICTs), a tendency towards reurbanization, changes in consumers' behaviors, and increasingly widespread initiatives related to social entrepreneurship [1–5]. Despite the lack of empirical evidence, the rise of the sharing economy and the 2008 financial crisis are often linked [5,6]. As a result of the crisis, discussions of sustainable development, including sustainable consumption, have intensified. In recent years, interest in the sharing economy has increased. The new economic situation has led to a reassessment of consumption patterns, including spending habits and the value attached to ownership [6–8], thus making it necessary to rethink the changes in previously existing behaviors resulting from one's lifestyle. The sharing economy has provided useful business models for consumers who engage in anti-consumption lifestyles, because a number of consumers see participation in the sharing economy as an alternative to ownership [9] (pp. 1422–1423).

Lifestyle is considered by many authors as one of the factors in consumer behavior [10–13]. In the tourist market, lifestyle can affect tourists' behaviors and determine the choices they make regarding, e.g., how they travel and what services they use [14–17]. It is natural for people to constantly pursue a higher standard of living [18]. This pursuit can be manifested by the wish to constantly improve one's economic standing, but may involve non-financial aspects of life as well. Consumers create tendencies and are incredibly demanding about what they want and do not want. Tourists as consumers seek products that can adapt to their lifestyle [13]. Knowledge of lifestyle changes can help adapt the product offer to the requirements of consumers. At the same time, products that consumers use can reflect lifestyle changes. The idea of sharing is important, mainly in the context of satisfying unlimited needs under conditions of limited resources. The sharing economy is seen as a way to reach sustainability [19] (p. 19). It may be considered a sustainable business model [20] that will change consumers' relationship to objects and other components of a materialistic lifestyle [5]. Consumers are increasingly aware of environmental, economic, and social issues. Their growing concern for the environment may lead to more rational purchasing decisions [21,22] and prompt them to search for providers with a sustainable business model. Consumers' lifestyles and values are changing, and consumer behavior patterns are changing with them [13,21,23]. This also applies to leisure time and the ways it is managed, including the choice of accommodation during travel [16,23,24]. Changes in lifestyle could reduce the excessive consumption of goods, and promote more responsible consumer behaviors [5] and more sustainable business models.

The objective of the article is to analyze the relationship between lifestyle changes and readiness to use peer-to-peer accommodation services, which are part of the sharing economy. In order to achieve this objective, it was first necessary to analyze this relationship in a broader context, by assessing consumers' sense of responsibility for the use of resources, and their engagement in sharing economy activities, involving the sharing of transportation, food, clothes, and equipment. The key issue for the study was the focus on the behavioral aspect of respondents' attitudes. Once the respondents' general attitude towards the sharing economy was known, it was possible to examine their hidden motives resulting from lifestyle changes in the context of travel patterns and accommodation. Therefore, as well as respondents' declarations of whether they performed certain actions, their motivations behind choosing (or not choosing) peer-to-peer accommodation and other sharing economy activities was examined. The paper is based on the authors' own classification of motivations (personal, social, and ideological), with an attempt to verify these motivations based on qualitative research in six focus groups.

The systematic literature review in the article contributes to a clearer understanding of lifestyle changes in the context of the sharing economy. The review was carried out with a view to identifying existing research directions in this field. While an abundant literature covers tourists' motivations for participating in the sharing economy [1,2,23–29], researchers have paid less attention to these tourists' lifestyles [28], and more importantly, to how lifestyle influences their behavior in the context of the sharing economy. This paper contributes to a better understanding of the lifestyle changes associated with behaviors, attitudes, and preferences regarding sharing economy initiatives. In addition, the qualitative study enabled a thorough analysis of hidden motives resulting from the subjects' lifestyle and the gap between lifestyle changes and the use of peer-to-peer accommodation, which, to the best of the authors' knowledge, has not been covered in any previous research. The study reveals differences between generations in terms of: (1) lifestyle and a sense of responsibility for the use of resources; (2) lifestyle and motivations for participating in sharing economy activities, including the sharing of transportation, food, clothes, and equipment; (3) lifestyle and motivations for the specific organization of travel and use of peer-to-peer accommodation. The focus group study offers a better understanding of the role of lifestyle changes in the sharing economy and the popularization of sustainable business models. The results contribute to the literature on peer-to-peer services by including a lifestyle perspective, allow the establishment of an informational background, offer a

starting point for further quantitative research in this field, and provide some guidelines for tourism companies with sustainable business models.

2. Systematic Literature Review—Lifestyle, Sharing Economy and Peer-to-Peer Accommodation

Lifestyle is a term which is often used in conjunction (or sometimes even replaced) with terms such as “the way, quality and standard of living”, “patterns of behavior”, “values”, and “attitudes”. In the literature, one can find various attempts to define this term, as it falls within the scope of interest of scholars from the fields of economics, psychology, sociology, pedagogy, and medicine [10]. As a result, there is no single commonly accepted definition of lifestyle.

Lifestyle includes observable behaviors and non-observable values [10,30]. According to scholars, lifestyle is a method of market segmentation; they have emphasized, however, that it has never been accepted as the dominant method [14]. Lifestyle is intrinsically associated with psychographic methods of market segmentation. In literature, there have been many attempts to determine the lifestyle characteristic for societies in developed countries, so as to make it easier to profile market segments, develop the concept of market position, develop advertisements, etc. Lifestyle comprises behaviors, knowledge, and attitudes—both what people do and what they feel. It is a complex and evolving category, which can include both differences and similarities, due to the multi-directional transmission of cultural values [31]. Although it is hard to find a single, all-encompassing definition of lifestyle, the fact that lifestyle in developed countries undergoes transformations is commonly accepted in literature [13].

From the perspective of this article, it is worth considering whether analyses of lifestyle refer to attitudes and values opposing consumption, and to the sharing economy. Tourism is associated with the way people spend their time and with personal preferences; therefore, one might assume that choices people make concerning tourist services can be the consequence of a specific lifestyle.

2.1. Lifestyle Changes and the Sharing Economy

Educational campaigns for rational and healthy living contribute to the rationalization of some areas of consumption [32], including the way people satisfy their need to relax, as well as other needs that involve tourist activities. Excessive mass consumption is increasingly rejected in favor of sustainable consumption and de-consumption, i.e., the conscious limitation of consumption to a rational size [4,33–35], which can be observed especially in groups of young, educated individuals who use digital media and technology [3,36]. Furthermore, consumers are becoming more rational, responsible, and aware when it comes to issues related to environment protection [37] and are aiming at sustainable consumption. On the other hand, consumers are exposed to constant pressure related to the artificial stimulation of certain needs, mainly through aggressive advertising, which leads to the so-called Diderot effect, whereby people pursue their ideal of a good life through the purchase of particular consumer goods, purchasing more than one actually needs [38]. Thus, consumers’ behavior is becoming clearly inconsistent—they aim at limiting consumption, but at the same time they buy more, because they want to satisfy all their needs [3]. The concept of the sharing economy can be seen as an attempt to reconcile the two perspectives (i.e., simultaneously using products and limiting purchases).

The sharing economy—which is essentially about better management of underused assets—has become one of the leading economic trends in the 2010s. It is an economic and technological idea that can be perceived as an umbrella term for changes occurring within modern technologies and including collaborative consumption [39]. Collaborative consumption endorses sharing the consumption of goods and services through online platforms [39] and can include the following activities: traditional sharing, bartering, lending, trading, renting, gifting, and swapping, providing benefits related to accessing products and services rather than owning them [7,39–41].

The growth of the sharing economy in tourism, driven by the global economic crisis, the development of modern technologies, environmental factors (de-consumption, sustainable consumption), and the increased significance of authenticity and sense of community [1–3,7,16,42–44] has led to the emergence of many businesses that enable and coordinate the direct exchange of products and services between individuals (consumers). In tourism, examples of the sharing economy can be found in the following fields [45,46]: (1) accommodation services—in the form of short-term rental of entire houses, flats, or rooms, where both guests and hosts are registered users of a platform, or in the form of home-swapping; (2) transport services—in the form of ride-sharing, as a way of getting from home to a tourist destination (long-distance travel, instead of a train or bus) or moving around as part of the tourist experience (short-distance travel as an alternative to public transport or taxis); (3) catering services—meal-sharing, carried out mainly in private houses in the tourist area; (4) tourist guide services—where the function of a tour guide is performed by residents of a given tourist area. The sharing economy concept is associated with certain behaviors of tourists that may manifest themselves as a result of lifestyle changes across generations. Therefore, the relationship between these constructs should be traced in the literature.

A review of articles on the sharing economy and peer-to-peer accommodation reveals a number of qualitative and quantitative studies directly or indirectly related to the subject of lifestyle. As shown in Table 1, the covered lifestyle contexts included lifestyle in an intercultural context [47]; lifestyle as a driver, result, or part of the sharing economy (or related consumption patterns) [4,5,9,16,48–50]; lifestyle threatened by the sharing economy [51]; description of the lifestyles of sharing economy users [52]; sustainable lifestyle [53]; and lifestyle as a direction in research on the sharing economy [54]. In some papers, no direct link between lifestyle and the sharing economy was found [47,50,52], but most included cases of sharing economy accommodation [9,16,47–49,51,52].

The analysis shows that lifestyle has an impact on the behaviors associated with the sharing economy and peer-to-peer accommodation, but that the relationship can also work in the opposite direction. The various opportunities offered by the sharing economy may influence consumers' behaviors and changes in their lifestyles. Contemporary tourists try to avoid the tourism industry by making long-term lifestyle changes and seek authenticity by interacting with locals. Therefore, tourism is not just an industry, it is also negotiated between private individuals, with or without intermediaries, which calls for a rethinking of the concept of "tourism" [17] (p. 297).

Table 1. Research on lifestyle and the sharing economy in core literature (Web of Science).

Aim	Method	Overall Results	Lifestyle Context	Activity Type	Sharing Economy–Lifestyle Links	Study
The study investigated western Airbnb hosts' experiences with Chinese outbound tourists (p. 288).	Four-stage analysis of hosts' comments. Co-occurrence analysis using the Gephi software	The research highlighted the role that cultural differences and tradition play in guest–host encounters, and offered a theoretical framework on inter-cultural host–guest relationship that provides an initial understanding of this phenomenon.	Lifestyle in an intercultural context: western hosts–Chinese guests	Peer-to-peer accommodation	Not directly indicated. Differences in the represented lifestyles can affect the experiences of both hosts and guests in case of peer-to-peer accommodation.	[47]
The study examined the nuanced styles of collaborative consumption in relation to market-mediated access practices and socially mediated sharing practices (p. 692).	Observation, ethnographic interviews, and a netnographic study	The research identified three styles of collaborative consumption: communal (pro-social), consumerist (commercial), and opportunistic (exploitative).	Lifestyle as part of collaborative consumption styles	Ridesharing	Convenient and trendy lifestyle as a factor influencing the consumerist collaborative consumption style in ridesharing.	[4]
The study re-established the role of the Airbnb platform in contemporary tourist destination management (p. 458).	Critical approach to regulatory measures	The findings indicated that restrictions on Airbnb are often unfounded. This is due to preconceptions regarding the impact on traditional hotels and the preservation of local lifestyles, rather than specific and objective measurements of impact.	Local lifestyle at risk due to the sharing economy	Short-term rental accommodation	The sharing economy is falsely seen as a threat to the local lifestyle. Local identity and lifestyle should be protected from unregulated sharing economy development.	[51]

Table 1. *Cont.*

Aim	Method	Overall Results	Lifestyle Context	Activity Type	Sharing Economy–Lifestyle Links	Study
<p>The study described anti-consumption lifestyles and the impact of such lifestyles on the acceptance of commercial sharing systems (CSS) (p. 1422).</p>	<p>Structural equation modeling (SEM)</p>	<p>The findings indicated that anti-consumption lifestyles consist of frugality, voluntary simplicity, environmental protection, small luxury and tightwadism, and that they differently influence consumers' behaviors with respect to using commercial sharing systems.</p>	<p>Lifestyle as a major driver of commercial sharing system use</p>	<p>Car and accommodation sharing services</p>	<p>The use of commercial sharing systems results from different anti-consumption lifestyles. Lifestyle trends of reducing consumption have emerged with the growth of the sharing economy.</p>	<p>[9]</p>
<p>This paper presented the results of an in-depth study into Italian home-swappers and discussed their socio-economic profiles, motivations, and lifestyles (p. 202).</p>	<p>Self-administered online survey</p>	<p>The findings indicated that home-swapping is an alternative form of tourism which requires trust, open-mindedness, inventiveness, enthusiasm, and flexibility.</p>	<p>Well-defined lifestyles as a driver of home-swapping</p>	<p>Home-swapping</p>	<p>In the case of the sharing economy (home-swapping), there is an overlap with other social practices present among niche consumers who are more concerned about the environment and more willing to respond to these concerns by changing their own lifestyle and consumption practices.</p>	<p>[16]</p>
<p>The study developed a method to understand users' lifestyles based on their interactions with social networks (p. 1).</p>	<p>OWA (ordered weighted averaging) and hierarchical clustering</p>	<p>The selected partition for the Airbnb case defined a set of seven clusters. Six of them represented a different lifestyle.</p>	<p>Qualitative description of lifestyle</p>	<p>Dining in peer-to-peer accommodation (Airbnb)</p>	<p>Not directly indicated. The various lifestyle descriptions were determined based on characteristics obtained from comments from Airbnb accommodation users.</p>	<p>[52]</p>

Table 1. *Cont.*

Aim	Method	Overall Results	Lifestyle Context	Activity Type	Sharing Economy–Lifestyle Links	Study
<p>The study investigated how the sharing economy enables a digital platform to impact the way of life of Airbnb hosts (p. 794).</p>	<p>In-depth and semi-structured interviews</p>	<p>This shift in the sharing economy due to financial imperatives shows how much this field has been promoting the creation of new digital monopolies and the permanence of labor precariousness scenarios. People subject themselves to new forms of production that capitalize on their own intimacy.</p>	<p>Lifestyle changes as a result of being an Airbnb host</p>	<p>Peer-to-peer accommodation</p>	<p>Transforming the home into a commercial space forces hosts to adopt new social behaviors, and to acquire a new lifestyle. The contribution of hosting in the sharing economy is to challenge traditional social values.</p>	<p>[48]</p>
<p>The study explored the factors influencing consumer adoption of Airbnb.</p>	<p>Online survey</p>	<p>Performance expectancy, social influence, hedonic motivation, and price value are significant predictors of intention to use Airbnb. Consumers' trust is positively related to performance expectancy. Consumers' cross-cultural experience moderates the relationship between performance expectancy and behavior intention, and consumers' extroversion. Change-seeking tendency moderates the relationship between hedonic motivation and behavior intention.</p>	<p>"Airbnb" as a new lifestyle</p>	<p>Short-term rental accommodation</p>	<p>The sharing economy appeals to those seeking change. Change-seeking refers to the demand for stimuli that a person needs to keep oneself in the best condition. It is a curiosity-motivated and variety-seeking behavior. Since Airbnb provides a lot of lodging types, change seekers are more likely to enjoy this feature.</p>	<p>[49]</p>
<p>The study identified a new consumer materialism within the sharing economy (p. 1).</p>	<p>Surveys collected during various events</p>	<p>Traditional materialism, i.e., the ownership and accumulation of goods, is losing its importance in favor of new materialism. Materialism is evolving from a mere static accumulation of goods towards a hybrid model (property and the enjoyment of goods coexist with the enjoyment of experience).</p>	<p>New materialism as a lifestyle</p>	<p>Sharing economy in general</p>	<p>The sharing economy can be a business model that will change consumers' relationship to objects and the materialistic lifestyle. Changes in lifestyles caused by the economic crisis could lead to a reduction in the excessive consumption of goods and promote more responsible consumer behavior.</p>	<p>[5]</p>

Table 1. *Cont.*

Aim	Method	Overall Results	Lifestyle Context	Activity Type	Sharing Economy–Lifestyle Links	Study
<p>The study investigated the readiness of the young generation to face the challenge of changing their lifestyle based on unlimited consumption towards one that will take sustainability into account as a basis for consumer behavior (p. 179).</p>	<p>CAMI (Computer-Assisted Web Interview) method and online interviews</p>	<p>The quality of life, in the context of responsible development, requires a change in the way of thinking and philosophy of life, recognition of new values and lifestyles, and different shaping of living conditions. This includes changing consumer habits, which would contribute to changing lifestyles and thus reducing environmental damage.</p>	<p>Lifestyle results from consumption patterns</p>	<p>Freeganism (the reuse of food that has been thrown away or is to be thrown away)</p>	<p>Not directly indicated. Lifestyle results from consumer behavior. The method of consumption and striving for its rational dimension contribute to changing consumer habits and lifestyle, and to reducing environmental damage. The sharing economy can be the solution.</p>	<p>[50]</p>
<p>The study investigated how trust and regulation shape relations between providers and consumers in the sharing economy (p.1).</p>	<p>Literature review</p>	<p>Most sharing economy research is not focused on sustainability. Some areas of the sharing economy are conducive to sustainable development, others are conducive to social cohesion and ultimately build social capital, while still others focus on comfort and lifestyle.</p>	<p>Sustainable lifestyle</p>	<p>Sharing economy in general</p>	<p>Adopting a sustainable lifestyle can reduce the exploitation of natural resources. The sharing economy is part of a sustainable lifestyle—it offers and shares underutilized resources.</p>	<p>[53]</p>
<p>The study uncovered the theoretical foundations and key themes underlying the sharing economy.</p>	<p>Systematic literature review</p>	<p>There are three distinct areas within the sharing economy literature and two areas specific to tourism and hospitality: the sharing economy's impact on destinations and tourism services, and the sharing economy's impact on tourists. Five research streams were identified: lifestyle and social movement, consumption, sharing, trust, and innovation.</p>	<p>Lifestyle as one of the research streams</p>	<p>Sharing economy in general</p>	<p>The sharing economy has a strong intellectual tradition in the lifestyle and social movement field, consumption practices, and the sharing paradigm. Lifestyle is a primary means to foster social change.</p>	<p>[54]</p>

Source: Authors' own work.

2.2. Motivations for Activities Pertaining to the Sharing Economy

In the sharing economy, the traditional concept of renting or sharing has changed and become more efficient, intelligent, and human-centered [55,56], and this does not mean that users do not buy anything, just that they do not have to buy everything [55] (p.87). Relinquishing the former attachment to ownership and replacing it with temporary access to underused assets can be motivated by many factors. The most common motivations for participating in the sharing economy in tourism are financial ones, including savings and lower transaction costs [1,2,23–27], and non-financial ones, related to care for the environment, social responsibility, enjoyment, and meeting new people [7,23,24,39]. In the existing studies on motivations for using peer-to-peer accommodation, various groups of factors were taken into consideration (see Table 2), but in most, economic and social factors were the strongest.

Table 2. Motivation for peer-to-peer accommodation use.

Variable	Study
Cost savings, familiarity, trust, utility	[2]
Social appeal, economic appeal	[24]
Enjoyment, perceived network effect	[56]
Enjoyment, monetary benefits, accommodation amenities	[27]
Enjoyment, independence through ownership, modern lifestyle, social experience	[28]
Interaction, home benefits, novelty, sharing economy ethos, local authenticity	[29]

Source: Authors’ own work.

The behavior of some sharing economy consumers is economically motivated, while for others it is driven by social and environmental factors. Decisions related to tourism and leisure are affected by a system of beliefs comprising a certain mindset. Many lifestyle-related factors influence the intention of consumers to use the sharing economy and their eventual behavior (see Figure 1). Therefore, for the purpose of the analysis, the authors categorized motivations in accordance with the represented lifestyle. The selection of sharing economy services can result from the following motivations:

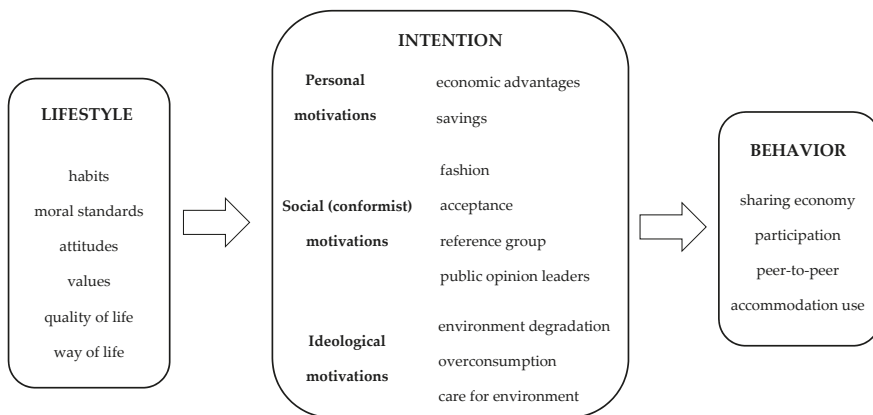

Figure 1. The impact of lifestyle on the intention to participate in the sharing economy and to use peer-to-peer accommodation. Source: Authors’ own work.

(1) Personal motivations, related to economic advantages and potential financial savings. Tourists choose sharing economy activities because it is more financially reasonable for them and their families, and allows them to visit many interesting places at a lower cost than in the case of regular hotel accommodation or transportation.

(2) Social (conformist) motivations. They result from the need to fit in with others, as well as from acceptance of the shifts and processes taking place in contemporary society, e.g., increasing environmental awareness. These motivations can be the result of pressure from the society, reference groups, public opinion leaders, as well as (or maybe primarily) producers and service providers. Potential consumers are influenced by them due to their own beliefs or the need to conform to the society in which they function. The selection of sharing economy services can result from a wish to follow leaders or from a short-lived trend for traveling “off the beaten path” and interacting with the locals.

(3) Ideological motivations. These motivations result from their awareness of processes such as natural environment degradation and excessive consumption, as well as their genuine desire to prevent these processes out of care for the future. In those motivations one can find the strongest manifestation of increased environmental awareness and opposition to excessive consumption.

Increased social development means that more and more people may want not only to improve their own living conditions, but also to look for authentic experiences, protect the environment, and take care of the future of the Earth, all of which can lead to participation in the sharing economy. Consumers are becoming aware of the relationship between their behavior and other aspects of social and economic life. They discover that their shopping decisions can affect the environment in which they live, thus impacting the quality of both their own life and the life of the entire society and the communities they visit.

3. Materials and Methods

In the study, both secondary and primary sources of data were used. First, a review of relevant literature on lifestyle, the sharing economy, and peer-to-peer accommodation was conducted (presented above). It included scientific articles indexed in Web of Science databases, published in the last 10 years, since 2010 (last updated: 7 March 2020). The articles were searched according to the following search terms: “sharing economy and lifestyle”, “peer-to-peer accommodation and lifestyle”, and “Airbnb and lifestyle”. A total of 43 results were found. After the removal of duplicates and a preliminary analysis of abstracts, 12 papers were included in the detailed content analysis (Appendix A). The literature review was supplemented by articles related to the subject of the study, but not included in the Web of Science database. The literature review was performed to establish a link between lifestyle and the sharing economy and motivations for peer-to-peer accommodation selection, and to provide a basis for empirical research.

The empirical part of the study was devoted to the relationship between lifestyle changes and willingness to use sharing economy services, with an emphasis on accommodation. The aim was to answer the question: which motivations resulting from the respondents’ lifestyle affect their willingness to use peer-to-peer accommodation? In order to achieve this, it was first necessary to analyze this relationship in a broader context, i.e., by assessing respondents’ sense of responsibility for the use of resources, importance of sustainability in individual actions, and motives for engaging in sharing economy activities such as transportation, food, and equipment sharing, or clothes swapping. In order to gather opinions and to understand behaviors, attitudes, and preferences regarding the use of sharing economy services, the focus group interview method was used. This method is particularly helpful for an exploratory investigation of new phenomena [57]. The study was carried out in 6 groups, with 5–8 participants each.

The most important factors differentiating motivations for choosing particular accommodation types are age, educational level, and household income [18]. Therefore, the study was carried out in two relevant populations, with 3 groups per population. One population consisted of young people—students, with low incomes, relatively abundant free time, and no life responsibilities (young with time, YT). Previous studies reported that young people in Poland are educated in the spirit of environmental awareness and concern for the natural environment. A moderate stability of behavior and inclination towards de-consumption was observed in this population [58]. The other population

consisted of subjects with higher incomes, aged between 40 and 50, with a wealth of life experience, who demonstrate their genuine attitudes through autonomous, financially unlimited shopping decisions (older rich, OR). One might assume that the latter group manifests their lifestyle preferences through their shopping decisions.

Group discussions were carried out separately for the two populations (3 groups per population), which made it possible to seek differences and similarities between the behaviors of respondents who differed in terms of age and financial status. The key issue for the study was the focus on the behavioral aspect of respondents' attitudes. Therefore, as well as their declarations about whether they performed certain actions, the authors examined respondents' motivations behind choosing (or not choosing) sharing economy activities.

In the first part of the group discussions, general questions were asked in order to determine respondents' lifestyles and their openness towards the sharing economy. Understanding the general attitude of the respondents made it possible to examine hidden motives resulting from lifestyle changes in the context of tourism. Then, the discussion focused on the motivations for selecting sharing economy services (the sharing of transportation, food, clothes, equipment, accommodation), resulting from the subjects' lifestyles. Group discussions were not structured in nature, and the role of the moderator was simply to direct the conversation. The interviews were carried out in June 2019, then transcribed and coded; this was followed by a synthesis of the collected material.

4. Results of the Empirical Study

4.1. Global Waste of Resources

Since the sharing economy is essentially based on concern for the proper utilization of assets, the first part of the study was devoted to the subject of global waste of resources. All studied groups in the YT population pointed out that food waste is a very serious problem. It was also noted that this problem is present at all levels—in single households, local communities, and entire countries. In one of the groups, a direct remark concerning hotels was made—it was pointed out that “throwing away food in hotels” is a great problem. The YT population clearly indicated that the most important motivation to limit waste is concern for other, poorer countries. This indicated an ideological motivation. Regarding food waste, some respondents said it should be avoided as it is uneconomical for households (personal motivations).

In the OR group, the problem of wasting resources was only mentioned in the context of an increased amount of rubbish, particularly plastics. Motivation to prevent the waste of resources was not observed in any of the OR groups. In the YT population, the problem of the growing amount of rubbish was considered one of the most burning issues in the contemporary world. In two groups, the problem of plastics was mentioned. Smog and environmental pollution were listed as other serious threats. In the OR population, the problem of smog in Poland was also pointed out. Both YT and OR respondents indicated personal motivations as a reason to counteract these problems. Smog damages health, and everyone is to blame for it—individual citizens (who “do not care what goes through their chimneys”), as well as local, national, and European authorities. Both studied populations (YT and OR) agreed that the problem of rubbish is severe, and that sorting is essential. However, the YT population was willing to stop buying expensive products in fancy packaging, while the OR population could not give up this luxury. To sum up, the YT population indicated more environmental threats, e.g., large-scale farming, littering in forests, and excessive logging. In unstructured interviews, OR subjects did not point out these problems. This suggests that the lifestyle of the YT population results from pro-environmental changes. This part of the study was fundamental for the subsequent analysis of lifestyle changes.

4.2. Engaging in the Sharing Economy—Transportation, Food, Clothes, and Equipment

A discussion was initiated regarding the possibilities for engaging in the sharing economy. Young people from the YT group were willing to use shared urban means of transport (bicycles, scooters). Respondents said that it is “cheaper” and “more convenient”. In other words, personal motivations prevailed. In the OR population, respondents were not interested in using such means of transport in their place of residence. Most subjects lived in single-family houses in the suburbs and used private cars for transport. One person pointed out that such means of transport are more attractive and fun, and that he used them on holidays. This is confirmed by studies which found that people demonstrate so-called chameleon behavior—during one trip, a tourist can play many roles, e.g., choosing very cheap accommodation and expensive means of transport, saving money on food, and at the same time buying very expensive clothing [59]. Only the YT population admitted to using the Uber service, and only in the YT population was it said that this is good for the environment. Therefore, ideological motivations were present.

In the analysis of lifestyle changes, the attitude towards “healthy eating” was an important issue. The results regarding this topic are quite astonishing. In all OR groups, the subjects emphasized the need to lead a healthy lifestyle. All women recommended “healthy eating”, and their motivations were of a personal and conformist character. In the younger YT group, there were no clear declarations that “healthy eating is better”—quite the opposite. Several people emphasized that “everyone is free to choose and eat what they want”, and even made statements like “I like junk food a lot”. The wealthier OR respondents said they read labels out of concern for their own health (personal motivation), while the YT groups admitted to paying no attention to such information.

Another subject discussed was the so-called “breakfast markets”, an alternative to preparing meals at home, which may be considered part of the sharing economy. The YT groups demonstrated willingness to try out this option “out of curiosity”. The OR groups elaborated on this subject. Respondents thought that such initiatives were “extremely attractive for tourists”. One person participated in the organization of such an event for charity, and was proud they had a chance to help others. Therefore, one might observe ideological motivations associated with concern for others.

Another topic of discussion was clothes swapping. In the OR group, it was pointed out that this is a way to “get rid of clothes”—the respondents did not undertake similar actions to help others or the environment. The YT groups presented an entirely different attitude—they admitted to participating in such swaps or buying clothes in second-hand shops. The following motivations were listed: saving money, a desire to have original clothing, and doing something for the environment (economic, personal, and ideological motivations). Respondents in one of the YT groups pointed out a serious problem of the excessive production of clothing by chain stores. In the OR group, the discussion of the problem of buying new clothing led to the conclusion that “one should follow trends”, i.e., conformist attitudes were manifested. None of the OR respondents admitted to wearing second-hand clothes, as opposed to the young YT subjects.

Lifestyle changes can also be observed in attitudes towards wearing natural fur and leather goods. Wealthy OR respondents noticed the problem associated with fur-bearing animals, but emphasized that they “would not give up wearing leather shoes and bags”. The YT groups clearly stated that wearing leather goods contradicts the modern lifestyle.

The analysis of the sharing economy also included the rental of various pieces of equipment or appliances. Responses in the two populations differed. The OR population did not see the need to use other people’s equipment—they actually made it very clear that their status was related to buying things. Furthermore, as a result of conformist motivations, they demonstrated consumerist attitudes, e.g., replacing kitchen appliances, cars or pieces of furniture regardless of their condition—just to show off their status and be fashionable. There was also a discussion of “how good you look when you buy a new boat”. In two YT groups, different attitudes were manifested. Several subjects made arguments that renting equipment is a good and useful habit, and that their families cultivated such a habit with their neighbors, with no cash involved. There was even an opinion that “in the countryside, you would

buy one machine for three farms, and you use it in turn". However, in this group, some also manifested concern and a lack of trust when lending one's own equipment to others, which seems quite surprising in the case of young people. Differences between small towns and large cities were pointed out: in the latter, the level of trust is considerably lower, as people do not know one another. Such an attitude can also result from Polish historical heritage, which has led to a significant decrease in the level of social trust. What Poles experienced caused a certain social and cultural trauma (probably passed from generation to generation), which undoubtedly led to the emergence of the "crisis syndrome" and lack of trust [60].

4.3. Travel Patterns, Peer-to-Peer Accommodation

The above problems were fundamental for the analysis of lifestyle changes. The next part of the study mainly focused on the influence of these changes on the way people travel, including the choice of peer-to-peer accommodation. In all OR groups, the respondents admitted to using the Airbnb platform. They emphasized that they choose places with a high standard of services. The respondents used this service, as it is more economical and provides an option to stay with a larger group of friends or acquaintances. The subjects pointed out that access to kitchen facilities is important, because they can make "healthy food" any time they want. This reinforces the view that wealthier people follow certain diets, and that they are motivated by personal benefits. In this population, the subjects expressed criticism towards large hotels, unattractive for wealthier people who traveled a lot. There is also a need to stand out, resulting from trends and the influence of social groups. It is not "cool" to travel to popular holiday destinations. It can be concluded that the selection of peer-to-peer accommodation results from personal and conformist motivations. In the OR group, using shared accommodation was not mentioned as an activity leading to the protection of resources. Respondents from the YT population made similar observations regarding the use of such services: "It is not about the environment; it is about money. It is budget-friendly". Therefore, in this population, personal motivations prevailed. Other important benefits of using Airbnb or Couchsurfing were also observed in this group: "We can live in one flat with a local person, we can learn more and have a free tour guide".

The discussion indicated that YT respondents are more open to new experiences and trying out new solutions. In one group, staying at a luxurious "all-inclusive" hotel was mentioned as something new. For people who are used to organizing trips on their own, staying at such hotels is attractive. According to the subjects "you do not have to follow the trends". It is an example of the lack of a conformist approach. The topic of cleaning house, both at home and on holidays, was also discussed. None of the populations had any problem with using professional cleaning services. In the OR group, criticism of absolute reliance on professionals was expressed. Wealthy people noticed that it impaired the independence of their own, almost adult children. It was pointed out that even on holidays, it is "not good" if the children do not have a habit of cleaning up after themselves, and that they should be included in daily chores. According to the respondents, peer-to-peer accommodation can "teach you real life". In the YT groups there were opinions voiced that "hiring cleaning staff is nothing unusual". There were economic motivations: a respondent claimed that "if I make more money per hour in my job than I pay the cleaning person, it makes more sense economically".

The discussion of changes in attitudes towards tourist trips was concluded with a question about which is better: a package holiday or an independently organized trip. In the groups of wealthy subjects, it was pointed out that typical package holidays are not "trendy". Only one person praised such holidays, but this was because it had been a new experience for them. Other people wanted to be perceived as "travelers", and organizing one's travels independently was seen as manifestation of this status. Detailed questions demonstrated that travel, for the OR groups, was not entirely independent. In three groups, local guides were booked; in one, an agency was used for organizing accommodation, and in another for booking transport.

In the YT population, all groups of respondents said that trips organized independently and individually are "definitely" preferable. The following advantages were mentioned: "we are not

dependent on anybody”, “we can adjust the budget to our possibilities”, “we can plan everything on our own”, and “we decide how much time we want to spend there”. In these groups, it was also noted, though, that package holidays may at times be more attractive in terms of pricing and offer. The main motivation for organizing one’s holidays individually was conformist for the OR population, and personal for the YT population. No ideological motivations were present in the discussion.

5. Discussion and Conclusions

Decisions of how to use tourist services can result from specific lifestyles and lifestyle changes. For the purpose of the article, the authors divided motivations for the selection of accommodation services and other collaborative consumption activities into personal, conformist, and ideological. The study was conducted in two populations of respondents: (1) young, with a lot of free time and limited income, and (2) wealthy, aged between 40 and 50, with rich life experience; and demonstrated lifestyle changes between the generations. The findings are as follows: (1) Subjects from the YT population are more aware of environmental threats and are more concerned about the environment. Their actions result not only from personal motivations (financial savings) but also ideological ones. The YT subjects are also interested in participating in sharing economy activities: they are more willing to use shared means of transport, participate in clothing swaps, and rent equipment and appliances than the OR subjects. (2) The OR population leads a lifestyle that is mainly based on personal (often conformist) motivations, which result from the influence of social groups. They aim at staying healthy and lead a so-called “healthy lifestyle”. Subjects from the YT population do not express too much interest in healthy eating and reading labels, while the subjects from the OR group do. (3) All groups of respondents prefer independent travel, but for different reasons. Young people seek interaction with the local community, while older and wealthier people who have already traveled a lot want to show off as “travelers”, not “tourists”. Their decisions are also affected by social judgment. (4) When it comes to using peer-to-peer accommodation, YT respondents are more open to new experiences and trying out new solutions. OR respondents are driven to use these types of services because of personal economic benefits and convenience. (5) Neither population recognizes a relationship between participating in the sharing economy on the one hand, and caring for the environment and preventing excessive consumption on the other. The final classification of motivations in both groups is presented in Table 3.

Several conclusions can be drawn based on these findings:

1. The lack of a relationship between participation in the sharing economy and care for the environment is in contrast with some studies on motives for participating in the sharing economy in tourism and using peer-to-peer accommodation [16,24,61]. This could indicate that sharing economy business models may not be seen by consumers as sustainable or environmentally friendly. However, this finding does correspond to the economically and socially motivated behaviors reported in previous studies. Therefore, more attention should be paid to sustainability issues. Although the sharing economy model was conceived as an answer to over-consumption and the waste of resources, in reality, consumers pay more attention to financial and social benefits. By participating in sharing economy activities, they tend to contribute to reducing resource use in an unconscious and unintentional way.
2. The results may be useful for companies that would like to operate according to a sustainable business model, which includes creating value for the customer in accordance with the principles of sustainable development. When constructing their own business models, companies should consider the overall lifestyle changes that characterize both groups of respondents (potential customers) and the importance of new customers’ preferences. These preferences should be taken into account in the creation of extended and potential components of business models, which may give a competitive advantage to traditional businesses in the tourism market (accommodation, transport, catering).

3. The study shows differences between the two generations in terms of lifestyle, sense of responsibility for the use of resources, and motivations for participating in the sharing economy and for the specific organization of travel and use of peer-to-peer accommodation. In planning activities to promote sustainable consumption and sustainable business models, one should take these differences into account and highlight diverse lifestyle aspects in messages to both groups.
4. The study was exploratory in nature and only included Polish respondents, but it should be noted that in the era of globalization, the needs and preferences of consumers may not necessarily differ between countries. People from both surveyed segments, YT and OR, can model their lifestyles on those found in other countries due to the frequency of travel and possibilities of communication using new technologies.

Table 3. Respondents' motivations for sharing economy activities.

Activities	Motivations	
	YT	OR
Prevention of wasting resources	Ideological, personal	None
Fighting with environment pollution	Personal, ideological	Personal
Healthy eating	None	Personal, conformist
Attending "breakfast markets"	Personal	Personal, ideological
Using means of transport associated with the sharing economy	Personal, ideological	Personal
Swapping clothes	Personal, ideological	None
Renting equipment	Personal, ideological	None
Using peer-to-peer accommodation	Personal	Personal, conformist
Individual organization of holidays	Personal	Conformist

Source: Author's own work. Abbreviations: YT, young with time; OR, older rich.

The authors are aware that the selected research method does not produce representative results and entire populations may not be assessed based on the data acquired in this manner. Nonetheless, the subject of consumers' behaviors required a qualitative data collection method to explain the discussed topic in more detail (e.g., to establish an informational background, propose ideas, detect needs, formulate hypotheses, etc.). Due to the broad scope of the problem and the preliminary character of the analysis, the study was strictly exploratory.

The study was conducted in two populations of respondents, differing in terms of their age and income. One must take into account that sociological analyses also suggest other qualities that may be used to differentiate segments of buyers. It was shown that the studied YT and OR populations are significantly different in terms of the presented lifestyles and motivations for participating in activities pertaining to the sharing economy, including the organization of holidays and choosing accommodation. Quantitative studies should be carried out in the future to verify whether the presented motivations are consistent with the observations made in the studied populations. Another potential research subject would be the analysis of why young Poles tend to be distrustful, especially since previous studies listed young people as the most eager to use sharing economy services (also in tourism) [2,62–64].

Author Contributions: Conceptualization, A.N. and K.K.; Methodology, A.N. and K.K.; Supervision, A.N. and K.K.; Visualization, A.N. and K.K.; Writing—original draft, A.N. and K.K.; Writing—review and editing, A.N. and K.K. All authors have read and agreed to the published version of the manuscript.

Funding: This research received no external funding.

Conflicts of Interest: The authors declare no conflict of interest.

Appendix A

List of papers included in the systematic literature review (Web of Science)

1. Cheng, M.; Zhang, G. When Western hosts meet Eastern guests: Airbnb hosts' experience with Chinese outbound tourists. *Ann. Tour. Res.* 2019, 75, 288–303.
2. Guyader, H. No one rides for free! Three styles of collaborative consumption. *J. Serv. Mark.* 2018, 32, 692–714.
3. Avdimiotis, S.; Poulaki, I. Airbnb impact and regulation issues through destination life cycle concept. *Int. J. Cult. Tour. Hosp. Res.* 2019, 13, 458–472.
4. Lee, H.J. The effect of anti-consumption lifestyle on consumer's attitude and purchase intention toward commercial sharing systems. *Asia Pacific J. Mark. Logist.* 2019, 31, 1422–1441.
5. Forno, F.; Garibaldi, R. Sharing Economy in Travel and Tourism: The Case of Home-Swapping in Italy. *J. Qual. Assur. Hosp. Tour.* 2015, 16, 202–220.
6. Nguyen, J.; Armisen, A.; Sánchez-Hernández, G.; Casabayó, M.; Agell, N. An OWA-based hierarchical clustering approach to understanding users' lifestyles. *Knowledge-Based Syst.* 2020, 190, 1–26.
7. Saturnino, R.; Sousa, H. Hosting as a Lifestyle: The Case of Airbnb Digital Platform and Lisbon Hosts. *Partecip. E Conflitto* 2019, 12, 794–818.
8. Min, W.; Lu, L. Who Wants to Live Like a Local?: An Analysis of Determinants of Consumers' Intention to Choose AirBNB. In *Proceedings of the 2017 International Conference on Management Science and Engineering (ICMSE); IEEE, 2017; pp. 642–651.*
9. Alonso-Almeida, M. del M.; Perramon, J.; Bagur-Femenías, L. Shedding light on sharing ECONOMY and new materialist consumption: An empirical approach. *J. Retail. Consum. Serv.* 2020, 52, 1–9.
10. Gierszewska, G.; Seretny, M. Sustainable Behavior—The Need of Change in Consumer and Business Attitudes and Behavior. *Found. Manag.* 2019, 11, 197–208.
11. Penz, E.; Hartl, B.; Hofmann, E. Collectively Building a Sustainable Sharing Economy Based on Trust and Regulation. *Sustainability* 2018, 10, 1–6.
12. Cheng, M. Current sharing economy media discourse in tourism. *Ann. Tour. Res.* 2016, 60, 111–114.

References

1. Bardhi, F.; Eckhardt, G.M. Access-Based Consumption: The Case of Car Sharing. *J. Consum. Res.* 2012, 39, 881–898. [[CrossRef](#)]
2. Möhlmann, M. Collaborative consumption: Determinants of satisfaction and the likelihood of using a sharing economy option again. *J. Consum. Behav.* 2015, 14, 193–207. [[CrossRef](#)]
3. Skalska, T.; Markiewicz, E.; Pędzierski, M. Konsumpcja kolaboratywna w obszarze turystyki. Próba prezentacji stanu zjawiska na rynku polskim. *Folia Tur.* 2016, 41, 165–190.
4. Guyader, H. No one rides for free! Three styles of collaborative consumption. *J. Serv. Mark.* 2018, 32, 692–714. [[CrossRef](#)]
5. del Alonso-Almeida, M.M.; Perramon, J.; Bagur-Femenías, L. Shedding light on sharing ECONOMY and new materialist consumption: An empirical approach. *J. Retail. Consum. Serv.* 2020, 52, 101900. [[CrossRef](#)]
6. Böcker, L.; Meelen, T. Sharing for people, planet or profit? Analysing motivations for intended sharing economy participation. *Environ. Innov. Soc. Transit.* 2017, 23, 28–39. [[CrossRef](#)]

7. Belk, R. You are what you can access: Sharing and collaborative consumption online. *J. Bus. Res.* **2014**, *67*, 1595–1600. [CrossRef]
8. Gansky, L. *The Mesh—Why the Future of Business Is Sharing*; Penguin: London, UK, 2010; ISBN 9780874216561.
9. Lee, H.J. The effect of anti-consumption lifestyle on consumer's attitude and purchase intention toward commercial sharing systems. *Asia Pac. J. Mark. Logist.* **2019**, *31*, 1422–1441. [CrossRef]
10. Sobotko, E. Lifestyles in Modern Society and their Impact on the Market Behaviour of the Young Consumers. *Ekon. Wrocław Econ. Rev.* **2017**, *23*, 71–83.
11. Patrzalek, W. The Determinants of Young Consumer's Lifestyle. *Mark. i Zarz.* **2017**, *2*, 63–71.
12. Mihajlović, I.; Koncul, N. Changes in consumer behaviour—The challenges for providers of tourist services in the destination. *Econ. Res. Istraz.* **2016**, *29*, 914–937. [CrossRef]
13. Sarmento, E.; Loureiro, S.; Martins, R. Foodservice tendencies and tourists' lifestyle: New trends in tourism. *Rev. Tur. Desenvolv.* **2017**, *1*, 2265–2277.
14. Chon, K.S.; Pizam, A.; Mansfeld, Y. *Consumer Behavior in Travel and Tourism*; Routledge: London, UK, 2012.
15. Meyer, B. Consumer Behaviours on the Tourism Market. *Econ. Probl. Tour.* **2014**, *4*, 135–148.
16. Forno, F.; Garibaldi, R. Sharing Economy in Travel and Tourism: The Case of Home-Swapping in Italy. *J. Qual. Assur. Hosp. Tour.* **2015**, *16*, 202–220. [CrossRef]
17. Kannisto, P. Travelling like locals: Market resistance in long-term travel. *Tour. Manag.* **2018**, *67*, 297–306. [CrossRef]
18. Rivero, M.S.; Rangel, C.R.; Caldito, L.A. Analysis of spa tourist motivations: A segmentation approach based on discriminant analysis. *Enl. Tour. A Pathmaking J.* **2016**, *6*, 19–43.
19. Nosratabadi, S.; Mosavi, A.; Shamshirband, S.; Kazimieras Zavadskas, E.; Rakotonirainy, A.; Chau, K.W. Sustainable Business Models: A Review. *Sustainability* **2019**, *11*, 1663. [CrossRef]
20. Daunorienė, A.; Drakšaitė, A.; Snieška, V.; Valodkienė, G. Evaluating Sustainability of Sharing Economy Business Models. *Procedia Soc. Behav. Sci.* **2015**, *213*, 836–841. [CrossRef]
21. Hojnik, J.; Ruzzier, M.; Ruzzier, M.K. Transition towards sustainability: Adoption of eco-products among consumers. *Sustainability* **2019**, *11*, 4308. [CrossRef]
22. Popovic, I.; Bossink, B.A.G.; van der Sijde, P.C. Factors influencing consumers' decision to purchase food in environmentally friendly packaging: What do we know and where do we go from here? *Sustainability* **2019**, *11*, 7197. [CrossRef]
23. Tussyadiah, I.P.; Pesonen, J. Impacts of Peer-to-Peer Accommodation Use on Travel Patterns. *J. Travel Res.* **2016**, *55*, 1022–1040. [CrossRef]
24. Tussyadiah, I.P.; Pesonen, J. Drivers and barriers of peer-to-peer accommodation stay—An exploratory study with American and Finnish travellers. *Curr. Issues Tour.* **2018**, *21*, 703–720. [CrossRef]
25. Balck, B.; Cracau, D. Empirical analysis of customer motives in the shareconomy: A cross-sectoral comparison. Working Paper Series, University of Magdeburg. 2015. Available online: www.fww.ovgu.de/fww_media/femm/femm_2015/2015_02-EGOTEC-pfuspggp6m5tm4cr9hkm6h00i1.pdf (accessed on 10 April 2020).
26. Karlsson, L.; Dolnicar, S. Someone's been sleeping in my bed. *Ann. Tour. Res.* **2016**, *58*, 159–162. [CrossRef]
27. Tussyadiah, I.P. Factors of satisfaction and intention to use peer-to-peer accommodation. *Int. J. Hosp. Manag.* **2016**, *55*, 70–80. [CrossRef]
28. Hawlitschek, F.; Teubner, T.; Gimpel, H. Understanding the Sharing Economy—Drivers and Impediments for Participation in Peer-to-Peer Rental. In Proceedings of the 49th Hawaii International Conference on System Sciences (HICSS), Koloa, HI, USA, 5–8 January 2016; Volume 4801, pp. 4782–4791.
29. Guttentag, D.; Smith, S.; Potwarka, L.; Havitz, M. Why Tourists Choose Airbnb: A Motivation-Based Segmentation Study. *J. Travel Res.* **2018**, *57*, 342–359. [CrossRef]
30. Antonides, G.; Van Raaij, W.F. *Consumer Behaviour. A European Perspective*; PWN: Warsaw, Poland, 1999.
31. Mazurek-Lopacińska, K.; Sobocińska, M. Virtualization of Marketing Communication in the Context of Population and Lifestyle Changes. *Zesz. Nauk. Univ. Szczecińskiego. Probl. Zarządzania Finans. Mark.* **2015**, *39*, 143–154. [CrossRef]
32. Lim, E.; Arita, S.; Joung, S. Advancing sustainable consumption in Korea and Japan-from re-orientation of consumer behavior to civic actions. *Sustainability* **2019**, *11*, 6683. [CrossRef]
33. Bywalec, C. *Consumption in Economic Theory and Practice*; PWN: Warsaw, Poland, 2007.
34. Mróz, B. Consumerism vs. sustainability: The emergence of new consumer trends in Poland. *Int. J. Econ. Policy Emerg. Econ.* **2010**, *3*, 1–15. [CrossRef]

35. Kadic-Magljalic, S.; Arslanagic-Kalajdzic, M.; Micevski, M.; Dlacic, J.; Zabkar, V. Being engaged is a good thing: Understanding sustainable consumption behavior among young adults. *J. Bus. Res.* **2019**, *104*, 644–654. [[CrossRef](#)]
36. Zalega, T. Sustainable Consumption in Consumer. *Stud. Ekon. Zesz. Nauk. Univ. Ekon. Katow.* **2019**, 82–107.
37. Ting, C.T.; Hsieh, C.M.; Chang, H.P.; Chen, H.S. Environmental consciousness and green customer behavior: The moderating roles of incentive mechanisms. *Sustainability* **2019**, *11*, 819. [[CrossRef](#)]
38. Lorenzen, J.A. Diderot Effect. In *The Wiley Blackwell Encyclopedia of Consumption and Consumer Studies*; John Wiley & Sons: New York, NY, USA, 2015.
39. Hamari, J.; Sjöklint, M.; Ukkonen, A. The sharing economy: Why people participate in collaborative consumption. *J. Assoc. Inf. Sci. Technol.* **2016**, *67*, 2047–2059. [[CrossRef](#)]
40. Botsman, R.; Rogers, R. *What's Mine Is Yours: The Rise of Collaborative Consumption*; HarperCollins: New York, NY, USA, 2010; ISBN 978-0-06-196354-4.
41. Barnes, S.J.; Mattsson, J. Understanding current and future issues in collaborative consumption: A four-stage Delphi study. *Technol. Forecast. Soc. Chang.* **2016**, *104*, 200–211. [[CrossRef](#)]
42. Akbar, Y.H.; Tracogna, A. The sharing economy and the future of the hotel industry: Transaction cost theory and platform economics. *Int. J. Hosp. Manag.* **2018**, *71*, 91–101. [[CrossRef](#)]
43. germann Molz, J. Social networking technologies and the moral economy of alternative tourism: The case of couchsurfing.org. *Ann. Tour. Res.* **2013**, *43*, 210–230. [[CrossRef](#)]
44. Liang, L.J.; Choi, H.C.; Joppe, M. Understanding repurchase intention of Airbnb consumers: Perceived authenticity, electronic word-of-mouth, and price sensitivity. *J. Travel Tour. Mark.* **2018**, *35*, 73–89. [[CrossRef](#)]
45. Dredge, D.; Gyimóthy, S. The collaborative economy and tourism: Critical perspectives, questionable claims and silenced voices. *Tour. Recreat. Res.* **2015**, *40*, 286–302.
46. Heo, C.Y. Sharing economy and prospects in tourism research. *Ann. Tour. Res.* **2016**, *58*, 166–170. [[CrossRef](#)]
47. Cheng, M.; Zhang, G. When Western hosts meet Eastern guests: Airbnb hosts' experience with Chinese outbound tourists. *Ann. Tour. Res.* **2019**, *75*, 288–303. [[CrossRef](#)]
48. Saturnino, R.; Sousa, H. Hosting as a Lifestyle: The Case of Airbnb Digital Platform and Lisbon Hosts. *Partecip. Confl.* **2019**, *12*, 794–818.
49. Min, W.; Lu, L. Who Wants to Live Like a Local?: An Analysis of Determinants of Consumers' Intention to Choose AirBNB. In Proceedings of the 2017 IEEE International Conference on Management Science and Engineering (ICMSE), Guilin, China, 18–20 August 2017; pp. 642–651.
50. Gierszewska, G.; Seretny, M. Sustainable Behavior—The Need of Change in Consumer and Business Attitudes and Behavior. *Found. Manag.* **2019**, *11*, 197–208. [[CrossRef](#)]
51. Avdimiotis, S.; Poulaki, I. Airbnb impact and regulation issues through destination life cycle concept. *Int. J. Cult. Tour. Hosp. Res.* **2019**, *13*, 458–472. [[CrossRef](#)]
52. Nguyen, J.; Armisen, A.; Sánchez-Hernández, G.; Casabayó, M.; Agell, N. An OWA-based hierarchical clustering approach to understanding users' lifestyles. *Knowl. Based Syst.* **2020**, *190*, 1–26. [[CrossRef](#)]
53. Penz, E.; Hartl, B.; Hofmann, E. Collectively Building a Sustainable Sharing Economy Based on Trust and Regulation. *Sustainability* **2018**, *10*, 3754. [[CrossRef](#)]
54. Cheng, M. Sharing economy: A review and agenda for future research. *Int. J. Hosp. Manag.* **2016**, *57*, 60–70. [[CrossRef](#)]
55. Palos-Sanchez, P.R.; Correia, M.B. The collaborative economy based analysis of demand: Study of airbnb case in Spain and Portugal. *J. Theor. Appl. Electron. Commer. Res.* **2018**, *13*, 85–98. [[CrossRef](#)]
56. Sung, E.; Kim, H.; Lee, D. Why do people consume and provide sharing economy accommodation?-A sustainability perspective. *Sustainability* **2018**, *10*, 2072. [[CrossRef](#)]
57. Mansourian, Y. Exploratory nature of, and uncertainty tolerance in, qualitative research. *New Libr. World* **2008**, *109*, 273–286. [[CrossRef](#)]
58. Niezgoda, A.; Markiewicz, E. Lifestyle and Ecological Awareness of Consumers in the Tourist Market—Relations, Conditions and Problems. *Ekon. Wroc. Econ. Rev.* **2017**, *23*, 49–62.
59. Niezgoda, A. Wpływ mody na rozwój turystyki. In *Współczesne Uwarunkowania i Problemy Rozwoju Turystyki*; Pawlusiński, R., Ed.; Instytut Geografii i Gospodarki Przestrzennej Uniwersytet Jagielloński w Krakowie: Kraków, Poland, 2013; pp. 85–92.
60. Sztompka, P. *Zaufanie. Fundament Społeczeństwa*; Znak: Kraków, Poland, 2007.

61. Tussyadiah, I.P. An Exploratory Study on Drivers and Deterrents of Collaborative Consumption in Travel. In Proceedings of the Information and Communication Technologies in Tourism 2015, Lugano, Switzerland, 3–6 February 2015; Tussyadiah, I., Inversini, A., Eds.; Springer: Cham, Switzerland, 2015; pp. 817–830.
62. Owyang, J.; Tran, C.; Silva, C. *The Collaborative Economy: Products, Services, and Market Relationships Have Changed as Sharing Startups Impact Business Models. To Avoid Disruption, Companies Must Adopt the Collaborative Economy Value Chain*; Altimeter: San Mateo, UK, 2013.
63. Rostek, A.; Zalega, T. Konsumpcja kolaboratywna wśród młodych polskich i amerykańskich konsumentów (cz. 1). *Mark. Rynek* **2015**, *5*, 11–19.
64. Skalska, T. Sharing economy in the tourism market: Opportunities and threats. *Kwart. Nauk. Uczel. Vistula* **2017**, *4*, 248–260.



© 2020 by the authors. Licensee MDPI, Basel, Switzerland. This article is an open access article distributed under the terms and conditions of the Creative Commons Attribution (CC BY) license (<http://creativecommons.org/licenses/by/4.0/>).

Article

The Development of Mobile Tourism in the Upper Silesian Metropolitan Area of Poland

Mateusz Naramski * and Krzysztof Herman

Department of Organization and Management, Institute of Economy and Informatics, Silesian University of Technology, Akademicka 2A, 44-100 Gliwice, Poland; krzysztof.herman@polsl.pl

* Correspondence: mateusz.naramski@polsl.pl; Tel.: +48-32-277-7336

Received: 14 November 2019; Accepted: 10 December 2019; Published: 19 December 2019

Abstract: Smart tourism is a concept that is becoming more and more popular worldwide in modern tourism. It is a tourism orientated part of the smart city concept, which can also be treated as a specific type of business model. Support and presence of tourist attractions for smartphone users through various apps is one of the first technological stages in the process of adapting this concept in a touristic region. Therefore, the paper's aim was to observe and measure the development of touristic sites' presence in mobile applications, in a developing touristic region. In order to do so, we compared data obtained from mobile applications in the years 2015 and 2019. The selected apps contain databases of touristic sites and allow tourists to search for attractions, hotels and restaurants. The comparison showed quantitative changes in the number of those types of objects found by mobile apps in the Upper Silesian metropolitan area, picturing the development and use of those apps in this given region.

Keywords: m-tourism; mobile applications; sustainability in tourism; smart tourism; sustainable business models

1. Introduction

Modern day tourism has been growing rapidly all over the world. This is due to the increase in income and quality of global society life [1]. In addition, the number of modern technologies that are used to support tourism and tourist attractions is growing. Especially interesting are mobile applications that include records regarding tourist infrastructure in a region. In most cases, those apps can be co-created by tourists and the entries are based on their experiences.

Mobile applications can be seen as the easiest technological solutions to adopt, which can improve tourism in a region. There are many already existing services that contain databases of touristic points of interest. Therefore, a region that transforms into a tourist destination does not need to develop its own platform, but rather start by marking its presence in those databases. Those allow visitors to search for attractions, hotels and restaurants. This makes tourists aware of their surroundings in a given area. As we later discuss, most of such applications not only allow users to search for touristic objects, but they can also be reviewed. This changes the classical model of a touristic product and puts the consumers into the role of co-producers. Those reviews are perceived as a powerful source of impact on other tourists, who orientate themselves based on such reviews, and see them as the most reliable source of information. Adopting mobile tourism (m-tourism) is also one of the main pillars of the smart tourism concept, which has become more and more popular. As a result, tourists expect certain destinations to support a proper technological infrastructure and also be able to use mobile solutions, not only for searching attractions but also for booking hotels, finding restaurants, sharing experiences and reviews. Destinations that adapt to those demands are more likely to be chosen by the part of potential tourists who only rely on such internet-based solutions for trip planning or by those who will prefer such destinations over those that did not adapt to the smart tourism concept. This implies that

m-tourism presence and support become a necessity in almost every touristic region, especially in the developing ones that aspire to become a well-recognized and desired destination (especially by tourists out of a given country, who discovered it by themselves and had no opportunity to get recommendations from the local community that is familiar with it). The Upper Silesian metropolitan area in Poland is a good example of such a region. Since the 1990s, the once known for heavy industry area, has started to transform into a post-industrial region. This has left the region with a lot of heritage, both in the form of cultural and industrial monuments. Many former mines, factories, and other facilities have become museums, restaurants, galleries and other tourist attractions, where cultural heritage is presented and preserved, making it also a sustainability issue.

The idea of sustainable development emphasizes finding a use for material and non-material values that are socially important and would be lost if no other action was taken [2]. Heritage tourism fits well into this category since it allows artifacts, old technology and culture to be saved from the past, which would otherwise perish because there are no other applications for it that would generate sufficient income to sustain it [3]. Therefore, the process of transformation from a former industrial facility to a touristic site that conserves heritage is a sustainability issue and can be well explained through the perspective of business models [2]. Such an approach can be applied to single entities from various branches of tourism [4,5], but also to a set of touristic sites that try to improve in their efforts to reach sustainable development, through cooperation and trust-building [6]. In the widest perspective, part of the sustainable development goals of a touristic region could be achieved through a business model applied to whole cities or metropolis. Such an approach can be found in the concept of smart tourism, which utilizes technology to reach its goals and is the tourism-orientated part of the smart city concept (with falls into the category of sustainable business models) [7,8].

In Upper Silesia, there are two industrial heritage sites that have been inscribed on the World Heritage Site's list by UNESCO—with one of them quite recently in 2017 [9]. This illustrates well that the Upper Silesian transformation into a worldwide known and recognizable touristic destination is still in process and makes a good case for studying how smart technology use develops and is applied to support such transformation, illustrating the early stages of the smart tourism concept application.

Therefore, the paper's aim was to observe and measure how the presence of touristic sites from the Silesian region develops in mobile applications. In our work, we focus on 14 mobile applications that are used to find tourist attractions, hotels and restaurants. It is based on research that was conducted in 2015 [10], and now we compare the result of that research with data collected in 2019. The paper is divided into two sections. In the first one, we focus on a literature review on digital technology use in tourism, smart tourism concepts and business models in tourism. In the second part, we examine the functionality of selected mobile applications and we compare the results with previous ones. The area we refer to in our research is the Silesian Voivodeship in the southern part of Poland.

2. Literature Review

2.1. The Role of Modern Technology in Sustainable Tourism

Tourism is one of the most significant world markets. The UNWTO report [11] indicates that in 2017, international tourist arrivals increased by 6% in comparison to the previous year. As a result, it can be seen that tourism is constantly evolving. Development is visible in all fields of tourism. It is especially evident in the area of digital technologies. Mobile apps, interactive museums, virtual and augmented reality are only a few examples of modern technology that emerged in recent years. To understand what modern technology really is, it is important to discuss both terms.

Technology may be defined as a composition of two primary components—the physical one, which contains products, technics, and processes, and the second one, which is information that contains the know-how, marketing, and quality control [12]. The term "modern" is commonly understood as everything that nowadays is in use and is also frequently associated with any electronic elements. This point of view is confirmed by the Cambridge Dictionary (available online). In connection with those

definitions, modern technology can be understood as a set of components (joined together physically and by information) that are used nowadays and can be used interchangeably with digital technologies.

Modern technologies have found an application in all life areas in the modern world. It is easy to find examples in medicine, engineering, psychology or military science. Digital technologies are used in tourism as well. As an example, one can name the reservation system. The popularity of the CRS (computer reservation system) has been growing since the 1990s. Its basic function is to store information about all available service providers and to transfer such data between users. In comparison with traditional models of reservation, CRS significantly increases the rate of service sales by eliminating the physical distance between the producer and the consumer [13]. To name another example, the tour-guide system is a commonly known one. It is used in many tourist attractions and frequently is associated with recordings. Digital technologies have increased their functionality. The technology was expanded by touchscreens, video projections, the Internet and even GPS systems. For this reason, the guide end-user system provides few capabilities such as access to extended information, the possibility to send and receive messages or access to interactive services [14].

A new way of using “commonly known” technology is Smart CCTV (closed-circuit television). This technology significantly extends the functionality of CCTV and, in addition to the security function, enables to recognize the behavior of tourists and, as a consequence, better planning of tourism space [15,16]. Another idea is the beacon technology which is used to deliver extended information about exhibits by short-range signal transmitters [17]. In the context of modern technologies in tourism, augmented reality (AR) and virtual reality (VR) are frequently pointed out. These two technologies offer some benefits to human experience. The major advantages of VR are personalization, interactivity, and full immersion which have a significant influence on explaining the main phenomena [18]. AR, although it works differently (do not create reality, only adds some virtual objects to available space), has a similar effect to explaining the main phenomena.

An example of technology that suggests itself in the described context are mobile applications. Mobile technologies are correlated with the growing use of smart phones, that have been popularized and made known by Apple’s iPhone. Their App Store, soon followed by the Google Play Store, started in 2008 [19]. In 2011, it was one of the fastest-growing media outlets in the history of consumer technology [20]. Since that time, the mobile market has considerably increased and today it can no longer be seen as a curiosity, but as a major part of life and business. Take the Gartner report [21] for instance: mobile apps are projected to have the most impact on business success by 2020. Without doubt, smartphones and mobile applications are an important part of everyday life also in tourist activity. In Poland, above 58% of smartphone users have been using them to book hotels, planes or make car reservations [22]. One of the most popular mobile platforms: *Trip Advisor* has over 490 billion users every month. On the basis of the above data, it is possible to predict that the market of smartphones and mobile applications will grow and it is necessary to examine its dynamics. Moreover, those technologies are directly connected with the idea of smart tourism.

A study published in 2018 focused on how tourists’ risk perception affects their use of mobile devices, and the results suggest that there is no single digital tourist profile. Risk perception by tourists who use mobile devices is an important sustainability factor, because it is shaping their experience, through its influence on tourist behavior and satisfaction with a service. Tourist destinations should include a smart tourism policy in their efforts to promote a destination and it is suggested to include the perception of risk. The referred research shows that there is a dependence between mobile device dependence and its usefulness, but also that privacy risk has a major negative impact on the tourist experience (yet it does not affect future use of mobile devices and their perceived utilitarian value) [23]. This is crucial since the tourist experience is believed to be the essence of modern tourism [24], and it is also considered to become increasingly impactful on value co-creation [25].

Nowadays, the use of mobile devices like smartphones, tablets, etc., is so broadly spread that they have become a standard resource, also used by tourists to search for experiences, places and attractions. This behavior influences both the way information reaches tourists and the way they

are acting during a holiday [26,27]. A modern tourist business should be aware of this and respond through its management to the elements that shape tourist behavior regarding this medium, not only by single actions but by incorporating it into its business model [23].

In modern tourism, the use of technology and mobile phones in particular, puts tourists into the role of co-producers of tourist experiences [28–30]. Tourist destinations that emphasize on introducing smart tourism are dependent on technology, making the attractions available and appealing to tourists through this media, but also allowing them to co-shape the product by reviewing it, sharing opinions, recommendations, etc.

Those shared opinions, recommendations, ratings, etc., have also another meaning for a tourist destination. All tourist areas, no matter the size (from villages, cities, regions or countries) are (or at least should be) monitoring and constantly improving the destinations' image and attractiveness [31]. This topic was in the scope of researchers for decades [32]. The sources of factors that affect the formation and change of a tourist destination image can be divided into three groups: organic (originating and transmitted by individuals), induced (coming from the entities that promote a region) or autonomous (not related to the previous two) [33,34].

The first group contains all activities of word of mouth marketing, like sharing information with friends, family, and work colleagues, and is best known under its informal name: grapevine. In modern days, this form of creating opinions about destinations is therefore, also building or ruining its image, and becomes expanded by technology. User-generated content that includes opinions or recommendations that are shared over social media, websites, services, apps, etc., is an electronic form of word of mouth marketing (eWoM) [35]. Thanks to the constant development of technology and increasing meaning, and use and application of electronic media by tourists, the eWoM has undergone many changes in the course of the last 10 years from online guides and blogs to portals and mobile apps, that are now the most widely used medium for online tourist reviews [36]. Those can be used by researchers, as E. Marine-Roig has shown [35], to examine a well-known tourist destinations' image, that emerges from online reviews. The same data can be useful for local administration, promoters of a tourist region and entrepreneurs, in terms of gathering feedback about their single product or about the whole destination in general and its image.

This implies that in order to meet the requirements of modern tourists, a region that aspires to develop an advanced tourist function should undertake actions that will ensure its presence in those widely used social apps and services. After this is achieved, the feedback from online tourist reviews offers a plentiful source of information that is easily accessible (compared to conducting reviews, surveys, etc.), and can be used for creating sustainable development plans which can incorporate solutions for current, environmental, civil, juridical and touristic problems found in a region.

Online reviews in tourism and hospitality are perceived as a significant factor that nowadays strongly impacts the decision-making process of a consumer [25,37–40]. Those sources are even considered to be seen by customers as more reliable and believable than information coming from third party and product vendors [41–43]. As mentioned before, this puts the customers in the role of co-creators of a tourist experience but also makes those reviews valuable information sources for the service providers [44,45]. Therefore, one can say that the role of online reviews and ICT's (Information and Communication Technologies) in tourism are bilateral and conjunctive; on the one hand, they are an information source for potential tourists that make decisions based on that information, and on the other hand, during and after the consumption of a touristic product, they are used for sharing experiences, opinions, and recommendations [46]. Due to the above, ICT is frequently an inseparable element of business models in tourism enterprises.

2.2. Business Models in Tourism

Business models are a popular issue among researchers. The phrase "business model" as keywords in ScienceDirect returns over 350,000 research articles. This popularity is due to a few factors. The first one is the practical dimension. A good created business model is frequently indicated as one of the

most important factors of success in business [47]. The second factor is cognitive value. Analyzing existing business models allows to recognize the strengths and weaknesses of an organization, and it also allows to identify trends in business and indicate success factors. The third is the number of tools for creating the business model.

Such great interest in the issues of business models is also caused by the disagreement regarding the definition of the business model. It is understood differently, depending on the researcher's scientific discipline. The literature review allows us to assume that the business models are understood in two ways. The first one is a synthetic description of the company's operation. J. Magretta is one of the scholars who follows this approach and who explains the business model as a story that explains how enterprises work [48]. The second way is to understand the business model as a tool to create value for customers. It is mentioned by D. Teece, who describes the business model as a tool to design the mechanism of creating, describing and capturing value for customers [49]. Regardless of the approach to the characteristics of business models, numerous researchers agree that it consists of several components. Researches conducted by M. Morris et al. [50] and Shafer et al. [51] refer to this. The first team analyzed 19 perspectives on business model components. As a result, these researchers prepared six questions that describe a business model, and based on the answers, six major components of a business model could be created: factors related to offering (how the value is created), market factors, internal capability factors, competitive strategy factors, economic factors, and growth/exit factor. The second team analyzed 12 definitions of business models and specified 42 different components (unique building blocks or elements) that make a business model. In that research, they organized all ideas into four categories based on their similarity: strategic choices, create value, value network, and capture value.

One of the most popular conceptions is the business model CANVAS. The idea was developed and disseminated by A. Osterwalder and Y. Pigneur [52]. They include a framework based on nine elements: customer segments, value propositions, channels, customer relationships, revenue streams, key resources, key activities, key partners, and cost structure. These nine elements are widely used as a tool to create new business models and describe existing ones. Another example is the Cube business model. It consists of seven blocks: value proposition, users and customers, value chain, competences, networks, relations and value formula [53]. Another example is the proposal of M. Johnson et al. [54]. It contains four elements of a "Successful Business Model": value proposition for the client, profit formula, key resources, and key processes. Literature analysis shows significant differences in the components of business models. However, one element is common. It is the value that the company offers to its clients.

Business models described in the context of providing tourist services often refer to modern technologies. E. Cranmer et al. [55] point out the possibility of creating value by using augmented reality (AR). This technology gives the opportunity to present collections to which access is difficult (e.g., delicate exhibits). Researchers also describe the possibility of sharing such a tool by many entities, whereby the belonging of many museums to a common network allows them to create virtual exhibitions, extending the presented heritage with exhibits or collections owned by other units. Thanks to AR, exhibits can be better protected and made available to tourists and other entities in the form of models without the risk of damage. Therefore, digital technologies enable the creation of a joint virtual exhibition, extending the heritage presented by exhibits or owned collections by values owned by other units. In the opinion of C. Ciurea and F. G. Filip [56], virtual exhibitions are also an excellent opportunity to correlate museum collections located in various cultural units such as museums, libraries, archives, and galleries. The combination of these units, although only virtual, causes a real increase in the number of visitors and in the revenue stream.

N. Langvould and I. Daunoravīpinjtø [57], in a publication on factors that influence the success of a business model in the hospitality service industry, show that technology is one of the most important factors because it can reduce the cost of business. In addition, technology has a strong relationship with

other factors, which include internal and external marketing, relationship management, innovation, value proposition, and employee competencies.

The fundamental importance of modern technologies in creating business models was noted by M. Diacon and A. Dutu [58]. Those researchers claim that the development of new technologies has become a way to achieve success because it offers the possibility of expanding distribution channels, shortens the time of booking processing and creates a network of organizations involved in maintaining the value chain.

F. Mantaguti and E. Mingotto [59] show that knowledge is important in business models. Especially, it applies to knowledge generated by stakeholders, such as public institutions, local governments, business partners and even volunteers. Organizations using such knowledge effectively can become flexible enterprises, where entrepreneurs and their employees are in some sense creative agents, for whom customer relations are a priority. Modern technologies are used to gather and process knowledge because of their generality.

Modern technologies, their development and the attractiveness of their use, have caused business models to evolve. One of the directions of this development is the Smart Tourism concept.

2.3. Smart Tourism

Smart tourism is quite a new idea. The basis of it can be found in Web 2.0 conception. The term has been widely used to describe the role of technologies for modern tourists. Tourists are no longer passive but active [60]. They co-create tourist services through the opinions they leave on the Internet. In connection with this, a lot of companies have been obligated to change their products or even their business models. The idea of co-creating services seems tempting also for managers of tourist attractions. The era of m-tourism 2.0 has begun. This conception, described by Beça [60], enables users to get access to extended information that may help enrich their experience, provide their own opinions and get feedback or update some information in the future. This holistic approach is the basis of the smart tourism idea. Smart tourism may be defined as the integrated efforts of entities in destination to collect, aggregate and use data that could be transformed into on-site experiences and business value-propositions [61]. It seems reasonable to assume that it is the future of tourism. Big data, as a total experience of tourists, tourism attractions, government, tourist companies or even residents, could be used to create better touristic products.

The topic of sustainability in tourism roots back to the 1960s, when global tourism entered a rapid growth [62], and it was a response to negative effects in regions overblown by tourists, like inflation, increasing crime rate, rising housing prices, negative influence on local society (especially children) and higher number of strangers in previously sheltered neighborhoods [63]. The primal sustainable solutions for establishing sustainability in tourism reached out to the (back then) most influential methods, but technology was left out and not perceived as a key aspect in this matter [63]. As already mentioned before, over the last decades, things have changed dramatically, and now the use of modern technology is an inevitable part of tourism, which should be used for the benefits of sustainable development. D. Kim and S. Kim [64] researched the role of technology in achieving sustainable tourism by conducting a complex review of papers, news, mobile apps, and patents. The conclusion drawn from their research shows that the impact of mobile technology on sustainability is hard to measure directly, but can be deduced quantitatively from frameworks already established in literature, since the environmental effects of tourism and cultural heritage, as well as ICT's role in creating smart city communities, are all subjects of sustainable tourism discussions [65–68]. Mobile applications enhance the social capital by offering resources for tourist to tourist relations and the instant communication that can take place through them can be used by the transactors to share value and build cultural capital. Those among others positively affect sustainability. Furthermore, ICTs can be used to obtain big data, and perform large scale measurements and analysis, sometimes even in real-time. This allows them to track environmental impacts, support decision making and accelerate the introduction of new policies.

In the area of business models in tourism, special attention is paid to innovations in value propositions in business models, such as the use of new technologies. They significantly extend the value that companies can offer to their customers. Noteworthy is the recently popular concept of Smart Tourism [61], which is based on transforming huge amounts of data obtained through an application (usually mobile) into a value proposition for the client. In tourism, VR technology is increasingly being used, which makes it possible to get to know a space that is inaccessible to a client. This is emphasized by E. Crammer [55], who points out that, on the one hand, it may diversify the offer of a venture, and on the other hand, it contributes to increasing the competitiveness of that venture and increases its profits.

Smart tourism is a subset of the smart city concept in which the main idea is to connect people, business processes and systems, government and other entities together, with the main goal of improving the life quality of all citizens [7]. In other words, a smart city concept is essentially a business model of a city that is oriented at reaching specific goals with the use of innovative systems and processes. Smart city concepts focus on ICTs, platforms that allow engaging stakeholders, data generation and analysis coming from big data and open data sources [8]. This concept also focuses on human capital and information management [68–72]. This meaning, it is oriented at using employees' skills to produce desired outcomes. Smart tourism is the outcome of applying a smart city concept in a tourist destination, so that some of the developed solutions can enhance tourist experience, by automating some of the processes or improving their efficiency [73,74]. Therefore, smart tourism provides an interface between the visitor and the destination, allowing them to meet their needs [7]. Moreover, smart tourism requires the use of innovative solutions, that cover all main areas of sustainability (environmental, sociocultural, economic) while spreading cultural heritage to tourists [7,69].

According to some authors [7], destinations that apply the smart tourism concept incorporate three components:

1. Cloud services—those provide access to technological solutions in the form of applications, software, and data [75].
2. Internet of things—it is responsible for control and automation in providing destinations with information management and analysis [75].
3. End-user Internet Service System—they are designed to provide users (tourists) with applications (and sometimes equipment) that allow access to tourist-oriented services (booking, payment, internet access, finding destinations and attractions, etc.).

Those means serve to accomplish one of the main goals of smart tourism, that is—to create and manage tourist experiences [76]. Thanks to this, it is possible for multiple tourists to draw different, individual experiences from the same product offered by a destination [77].

In the light of all findings from various studies shown above, one can conclude that the smart tourism concept is virtually a necessity in destinations that aspire to become a tourist region or try to maintain such function. Modern tourists expect to find information about destinations, attractions, hotels, restaurants and locally available experiences, in apps, social media and other web-oriented services. They also expect to find a proper ICT infrastructure on-site, so they can continuously use those services, not only to find new places and activities but also to share those experiences with friends, family and other tourists, as well as for booking and regulating payments. Upon returning home, they want to review and recommend (or advise against) certain places or service providers. Moreover, those opinions are more likely to be taken into consideration by potential tourists, than content from other sources (advertisements, service providers, third party reviews). This does not only concern the young and middle age, technology-oriented tourists. As a recent study from Spain [78] has shown, the line of age in which tourists use apps has shifted, and senior citizens are a substantial tourist group that uses ICT technologies, mainly in the pre-travel phase, to book accommodation and transportation, and to locate and search for services and products.

Smart tourism was mainly studied from the perspective of the advantages that it can offer. However, there are also some risks that one should consider. Among those risks one can name [61,79–83]:

1. Information safety—this includes all sensitive information validations, like payment and location, information, but also storing of digital footprints left by unaware users.
2. Risk of losing tourists intimidated or unfamiliar with smart technology. Individuals who know that a destination is heavily oriented on smart technologies in tourist services, and do not use them or do not do it with comfort and confidence, might refrain from using such apps or even cancel the trip. This also poses a risk and fear of losing, damaging or misusing those devices.
3. Risk of losing tourists who are well familiar with modern technology, but get dependent on them, so they make it impossible for tourists to enjoy their travels (fully and uninterrupted).

Even if the chances for some of those events in the first point are very small, the fear of them taking place may place some tourists into feeling discomfort and discourage them from traveling. These issues should also be taken into consideration by smart tourism destinations (local administration, service providers, app designers, etc.) and use appropriate means to avert those negative effects.

3. Research Details

In 2015, one of the authors [10] conducted an analysis of six mobile tourist apps, that were designed overseas, offer an interface in English and are dedicated for the global market. Those applications were: *Tripadvisor*, *TripCase*, *WorldMate*, *TouristEye*, *Gogobot*, and *EloMaps*. During the referenced research three Polish apps, dedicated only for domestic tourists, were also analyzed: *Polska Niezwykła*, *Polskie Szlaki*, and *wyjade.pl*. Choosing these two types of apps allowed to compare the number of hotels, restaurants and tourist attractions found by apps dedicated both to domestic and foreign tourists. Taking apps into account that are dedicated to foreign tourists seems particularly important when one considers that according to the Central Statistical Office's (CSO) [83] data, almost every fifth (20.89%) tourist in Poland is a foreigner. The same statistic also says that visitors from other countries make almost a quarter (24.48%) of all hotel guests in Poland.

Some of the mentioned applications no longer operate on the market as for the day of this publication, and some of them were changed to follow a new business model, offering a different functionality compared to 2015. In this research, we collected data from all previously mentioned applications that still operate on the market and from four new ones that have gained popularity during the last four years. The additional apps were: *Airbnb*, *Booking.com*, *Foursquare*, and *Tripso*. The criteria for choosing these apps were the same as during the previous research—a high position in the Google Play store when searching for phrases like: *tourist guide*, *trip planner*, *tourist application*. Google ranks its apps higher according to the bigger the user count and user rating, and the better the match with the searched phrase. The subject for the analysis was: the number of hotels, restaurants and tourist attractions found by each app (not all of them allow to search for all three types of objects) in selected cities: Katowice, Chorzów, Bytom, Zabrze, and Gliwice. Those towns have been selected because they were the most visited cities in Silesian Voivodeship during the years 2013 to 2015 (annually approximately 50% of all tourists in this Voivodeship visited these towns) [84]. Table 1 shows which of the given functions (searching for hotels, restaurants and tourist attractions) were available in 2015 and/or still in 2019, and also how some of the functionality has changed in this time period.

Two of the analyzed applications changed their names over the course of four years (from 2015 to 2019). *Gogobot* has become *Trip by Skyscanner*, but the available functions did not change. The second application that was renamed is *Guides by Lonely Planet* (former *TouristEye*). Originally, *TouristEye* allowed, just as similar services do, to search for restaurants and tourist attractions in selected user cities. Nowadays, the business model of this app has changed and it offers access to comprehensive guides through selected cities popular among tourists all over the world (in the case of Poland, as for 2019, there were two guides available through Warsaw and Cracow). Two from the nine apps that were analyzed back in 2015 expired and are no longer available, those are *EloMaps* and *WorldMate*.

Only three of the services allow to search for all three types of objects (hotels, restaurants and tourist attractions). The presented changes in availability, functionality, and business models show how prone to change and dynamic the application market is. Almost half (5 out of 9) of the previously analyzed applications has undergone no major changes. This dynamic should also affect the development of each app, especially regarding the size of databases that are available for the users. Thus, the next stage of the research was to analyze the amount of tourist objects found by each application.

Table 1. Comparison of available search functionality in mobile applications.

Application	Hotels		Restaurants		Tourist Attractions	
	2015	2019	2015	2019	2015	2019
Airbnb	N	√	N	×	N	×
Booking.com	N	√	N	×	N	×
EloMaps	×	E	×	E	√	E
Foursquare	N	×	N	√	N	√
Gogobot/Trip by Skyscanner* ¹	√	√	√	√	√	√
Polska Niezwykła	×	×	×	×	√	√
Polskie Szlaki	×	×	×	×	√	√
TouristEye/Guides by Lonely Planet* ¹	×	×	√	×	√	×
Tripadvisor	√	√	√	√	√	√
TripCase	√	√	√	×	×	×
Triposo	N	√	N	√	N	√
WorldMate	√	E	×	E	×	E
wyjade.pl	√	√	√	√	√	√

Explanations: √—function available; ×—function not available; E—end of operation; N—no data from 2015, the application was taken into consideration only in current research; *1—the name of the application was changed between 2015 and 2019; *2—the business model has changed, resulting in the function being no longer available (Source: Own research).

4. Results

Before analyzing the actual results obtained from mobile applications it is worth to delve into the characteristics of tourism in the Silesian region. Table 2 contains selected statistical indicators provided by the Polish Central Statistical Office (CSO) for the years 2014–2018, for tourism in the Silesian Voivodeship. One can notice that both the Schneider and Charvat Indexes have been constantly rising during the last five years, indicating that the number of tourists in Silesia has been constantly growing in this period of time. The growth was also noted by the indicator of tourist traffic density. It is also worth noting that even if the index of accommodation establishments per 100 km² rose, the tourist accommodation development rate has also risen. This might be interpreted as a sign that the accommodation base develops slower than the tourist traffic in this region. It is also interesting that even if tourism traffic seems to be growing, the number of catering units per every 100 km² in 2018 was lower than in the previous four years. Since the whole Voivodeship has an area of 12,333 km², it means that the total number of catering units has sunk by around 280. This took place, even though the total number of tourists visiting the Silesian region has been rising significantly since 2013, as presented in the graph in Figure 1.

As mentioned before, Upper Silesia is developing as an industrial heritage touristic region. This reflects on the number of objects inscribed on the register of monuments, that has been constantly growing over the course of the last five years. It is also worth mentioning that in 2006, the Industrial Monuments Route (IMR) of Upper Silesia was created, and since 2010, the creators (Marshals Office) organize an annual event called *Industriada*. It is described as a holiday of the route, during which every site on the route (42 as for 2019) organizes special events (concerts, free tours, educational presentations, etc.). The number of visitors during each *Industriada* has been growing every year, and in 2018 it tipped in comparison to the first edition. In Figure 2, we present a graph that illustrates the growing number of *Industriada* participants. One might say that this is the indisputable proof of Upper Silesia developing as an industrial heritage tourist region.

Table 2. Selected indicators regarding tourism in Silesian Voivodeship.

Indicator	Year				
	2014	2015	2016	2017	2018
Baretje's Index (bed places per 100 inhabitants)	1.0	1.0	1.0	1.0	1.1
Schneider Index (tourists per 100 inhabitants)	43.9	46.9	50.8	57.0	61.9
Charvat Index (nights spent per 100 inhabitants)	102.1	108.0	115.4	127.6	139.1
Tourist accommodation development rate (tourists in comparison to bed places)	44.8	46.8	51.7	55.0	57.2
Indicator of density of tourist traffic (tourists per 1 km ²)	163.6	174.1	187.9	210.5	227.8
Indicator of density of tourist accommodation establishments (bed places per 1 km ²)	3.6	3.7	3.6	3.8	4.0
Number of tourist accommodation establishments per 100 km ²	5.2	5.1	4.9	5.2	5.4
Museum visitors per 1000 population	309.9	351.5	316.4	355.7	333.3
Objects inscribed on the register of monuments per 100 km ² of area	31.1	31.9	32.0	33.1	34.6
Catering units per 100 km ² of area	13.1	14.3	14.3	13.6	12.0

(Source: [85–89]).

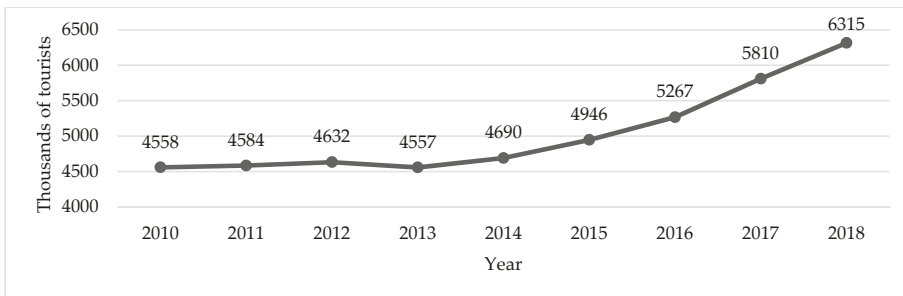
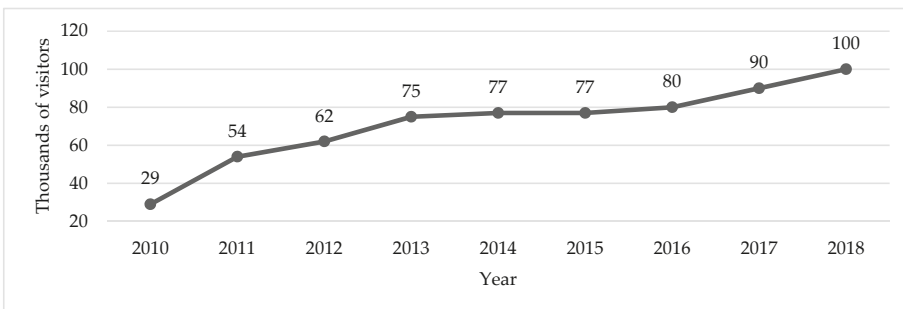
**Figure 1.** Overnight stays of tourists in Silesia, in 2010 to 2018 (Source: [85–89]).**Figure 2.** Number of tourists attending *Industriada* every year since it was started in 2010 (Source: [90]).

The first of the analyzed functions of mobile tourist applications was the number of accommodation facilities found in selected cities. Out of the 13 applications studied, eight offer or have offered this

function (the *WorldMate* application is no longer maintained by its authors and its activity has been terminated). Table 3 shows the results obtained from every application.

Table 3. The number of accommodation facilities found by each application.

City	Application Name															
	Tripadvisor		Tripcase		Worldmate		Gogobot/Trip by Skyscanner		wyjade.pl		Triposo		Booking.com		Airbnb	
	Year		Year		Year		Year		Year		Year		Year		Year	
	2015	2019	2015	2019	2015	2019	2015	2019	2015	2019	2015	2019	2015	2019	2015	2019
Katowice	23	112	25	29	12		17	151	0	0	100		352		318	
Chorzów	3	11	5	6	2		2	9	0	0	-2		22		37	
Zabrze	5	19	5	12	1	*1	3	10	0	0	-	7		30	-	
Gliwice	8	35	11	13	2		3	20	0	0	17		58		66	
Bytom	3	16	6	5	0		0	4	0	0	12		38		36	
Sum	42	193	52	65	17	-	25	194	0	0	-	136	-	500	-	
Difference	151		13		-		169		0		-		-		-	
Change in percent	359.52%		25.00%		-		676.00%		-		-		-		-	

*1—end of market operation; *2—this location is not supported by the app, the results for Katowice contain also objects from Chorzów (Source: Own research).

The last three applications presented in Table 1 (*Tripso*, *Booking.com*, and *Airbnb*) were only included in the current research, so in their case, the authors did not have data from 2015. The sum of accommodation facilities for applications that have been operating for the last four years has increased (*Tripadvisor*, 359.52%; *TripCase*, 25.00% and *Trip by Skyscanner*, 676.00%). Despite the long period between measurements, the application *wyjade.pl* still does not have in its database a single object of the chosen type, for any of the largest cities of the Upper Silesian Industrial District (although the application provides such functionality).

Portals created solely to search for accommodation facilities (*Tripso*, *Booking.com*, and *Airbnb*) returned several times more results than the applications analyzed in 2015 that offer searching for various types of objects. It should also be noted that for all applications, the number of accommodation facilities found in Katowice was many times higher than in other city.

Figure 3 presents a graph comparing the number of accommodation facilities found by each app in 2015 and 2019.

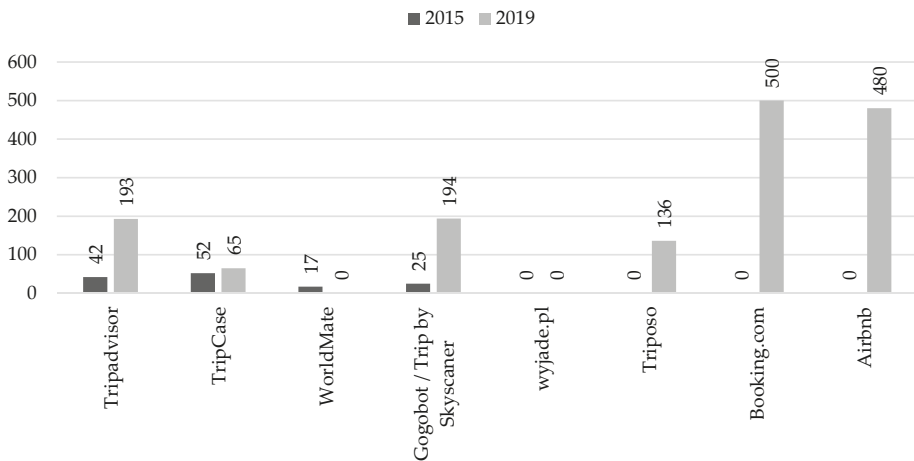

Figure 3. The number of accommodation facilities in selected cities by each application in 2015 and 2019 (Source: Own research).

One can notice that for most of the studied applications, the results have changed significantly compared to the figures recorded in 2015. The exception is *TripCase*, where the latest results increased by only 25% compared to the results from four years ago. All of the previously studied applications also obtained significantly lower results (not exceeding 200 records) compared to newer applications dedicated only for searching accommodation (*booking.com* and *Airbnb*), which have found about 500 accommodation facilities. It should be emphasized here that the number of accommodation facilities in the largest cities of Upper Silesia found by *Tripadvisor* (one of the most popular tourist applications in the world) is also not as large as in the other two applications. This can be an area for improvement among Silesian hoteliers, giving the opportunity to reach potential customers who use only one application to meet all their basic needs. The results from other applications clearly show that the number of hotels in the cities selected for the study has increased (as far as it goes to their presence in mobile applications), but the databases of many applications still do not include a significant proportion of existing facilities. The data from CSO also reflects that the accommodation base in Silesia has been growing, so the clear increase of those facilities' presence in mobile apps might be caused by the rapidly growing number of tourists visiting this region.

The second of the analyzed quantities was the number of gastronomic establishments found by mobile tourist applications. Out of the 14 services taken into consideration in this study, seven offer this feature. Table 4 presents the results obtained in 2015 and 2019 by each application.

It can be noticed that within those four years between the described researches, the database of gastronomic establishments in the application *wyjade.pl* has not changed and still did not contain a single object in the cities selected for the study. As mentioned earlier, the *Guides by Lonely Planet* application was created on the basis of the former *TouristEye* service, and its business model changed. Thus, it was impossible to compare the results from 2015 and 2019 in this application. It was similar in the case of *TripCase*, which was remodeled into a flight search engine. In the case of applications that retained their original functions (*Tripadvisor* and *Trip by Skyscanner*), there was a clear increase in the number of gastronomic establishments included in the databases of each service. During the research, *Tripadvisor* found a total of 694 objects of this type in selected cities. This is an increase by almost 129% compared to 2015 and, at the same time, the highest result among all applications included in this research. The relatively largest increase in the gastronomic establishments was observed for the *Trip by Skyscanner* application (from 13 to 381, which gives an increase of over 2380% compared to 2015). Figure 4 presents a graph comparing the number of gastronomic establishments found by each application in 2015 and 2019.

It can be seen that over the past four years there has been a development of mobile tourist applications regarding extending databases covering gastronomic establishments. Applications that did not contain a large number of records in 2015 (*TripCase* and *TouristEye*) changed their business model and focused on other functionalities. The exception is the portal *wyjade.pl*, which, despite providing the search function of gastronomic establishments, still does not have any facilities in its database located in major cities of the Upper Silesian metropolitan area. These results, in juxtaposition with the statistical data from CSO, show that despite the decrease in the total number of catering units in Silesian Voivodeship, their presence in mobile apps has been growing, even if not uniformly in every case. This might also be an indication that the number of restaurants in the metropolitan area has been growing, but it did not affect the overall statistic for the whole Voivodeship, which noted a downfall in this matter.

The last of the analyzed aspects of mobile tourist applications was the number of tourist attractions found by them. Out of all 14 applications included in the current and previous study, nine have or had such a function. The only application whose developers terminated it was *EloMaps*. As mentioned earlier, the *TouristEye* application has been remodeled into a set of guides through selected cities, in which none of the cities selected for this study were included. Two new applications have been included into the current study, due to their development and high positioning in 2019. These are *Tripso* and *Foursquare*. The number of tourist attractions found by each application is shown in Table 5.

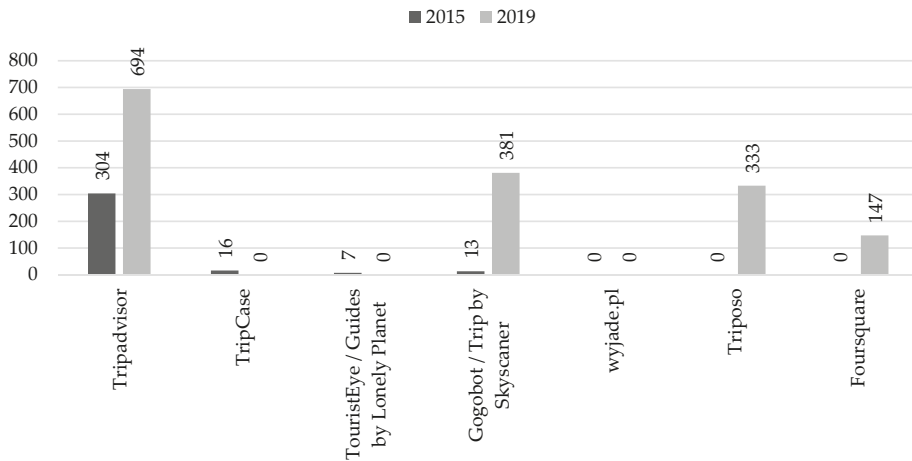

Figure 4. The number of gastronomic establishments found in all selected cities by each application in 2015 and 2019 (Source: Own research).

Since 2015, a significant increase in the number of tourist facilities has been observed in all applications that continued to operate in 2019. The highest number of attractions is contained in the *Polska Niezwykła* application's database (421 facilities in selected cities). In this application, the largest nominal change in the number of objects was noted. It took place in the course of the last 4 years and 152 new objects were added. Regrettably, this application is available only in Polish, which makes it difficult for foreigners to use. *Triposo* has the largest number of objects in an application available to foreigners, which has 201 records in its database (therefore, it is not even half of the objects listed in *Polska Niezwykła*). Figure 5 presents a graph comparing the number of tourist attractions found by each application in 2015 and 2019.

It can be noted that in the case of the *wyjade.pl* application, the increase in the number of tourist facilities noted in 2019 is still insufficient compared to competing platforms. Domestic tourists using *Polska Niezwykła* have access to a much larger database of attractions. For foreign tourists, using the *Trip by Scanner* application also seems to be the least favorable option, knowing that *Tripadvisor* has a database almost four times larger, and *Triposo* five times as big. The CSO data suggests that the increase in mobile app records regarding tourist attractions might also be caused by the significant rise in the number of tourists that started in 2014 (just like in the case of hotel records). This is even more evident when one considers that the increase in the number of monuments in Silesia is nowhere near to the proportion of the attraction database growth (the number of monuments has changed only by 11%). This development in mobile app use was probably also not caused by an increase in museum interest since the number of visitors over the last five years followed no clear trend. The obtained data can be also investigated from the perspective of the share of each city in the total results found. The average number of hotels, restaurants and tourist attractions in all of the analyzed applications was calculated for each city. Figure 6 presents a graph illustrating the share of individual cities in the overall average values for each category.

Table 4. The number of gastronomic establishments found by each application.

City	Tripadvisor		Tripcase		TouristEye/Guides by Lonely Planet		Application Name		Gogobot/Trip by Skyscanner		wyjade.pl		Triposo		Foursquare	
	2015	2019	2015	2019	2015	2019	2015	2019	2015	2019	2015	2019	2015	2019	2015	2019
Katowice	167	388	7		6		10	200	0	0	0	0	200	63		
Chorzów	32	63	1		0		3	44	0	0	0	0	0	13		
Zabrze	24	56	0	*1	0	*2	0	46	0	0	0	0	0	0	0	11
Gliwice	64	137	6		1		0	75	0	0	0	0	83	53		
Bytom	17	50	1		0		0	16	0	0	0	0	50	7		
Sum	304	694	16	0	7	-	13	381	0	0	0	0	333	-	147	
Difference	390		-		-		368		-	-	-	-	-	-	-	-
Change in percent	128.29%		-		-		2830.77%		-	-	-	-	-	-	-	-

*1—the business model was changed, the app is designated now for booking flights; *2—the business model was changed, the app contains now only complex guides through selected cities (Source: Own research).

Table 5. Number of tourist attractions found by a given application.

City	Tripadvisor		TouristEye/Guides by Lonely Planet		Gogobot/Trip by Pscanner		EloMaps		Application Name		Polskie Szlaki		wyjade.pl		Triposo		Foursquare	
	2015	2019	2015	2019	2015	2019	2015	2019	2015	2019	2015	2019	2015	2019	2015	2019	2015	2019
Katowice	14	62	11		3	27	17		112	166	18	35	3	5	98	50		
Chorzów	6	20	0		0	9	3		36	38	11	16	0	3	3	11		
Zabrze	5	20	0	-1	0	1	0	-2	24	31	11	14	1	3	-	34	-	8
Gliwice	9	34	5		0	4	12		58	108	13	22	0	3	30	17		
Bytom	3	18	0		0	0	39		39	78	2	34	0	0	39	4		
Sum	37	154	16	-	3	41	32	-	269	421	55	121	4	14	201	68		
Difference	117		-		38		152		66		66		10		-	-		
Change in percent	316.22%		-		1266.67%		56.51%		120.00%		250.00%				-	-		

*1—change in business model, the application offers only comprehensive guides through selected cities; *2—end of market operation; *3—this location is not supported by the app, the results for Katowice contain also objects from Chorzów (Source: Own research).

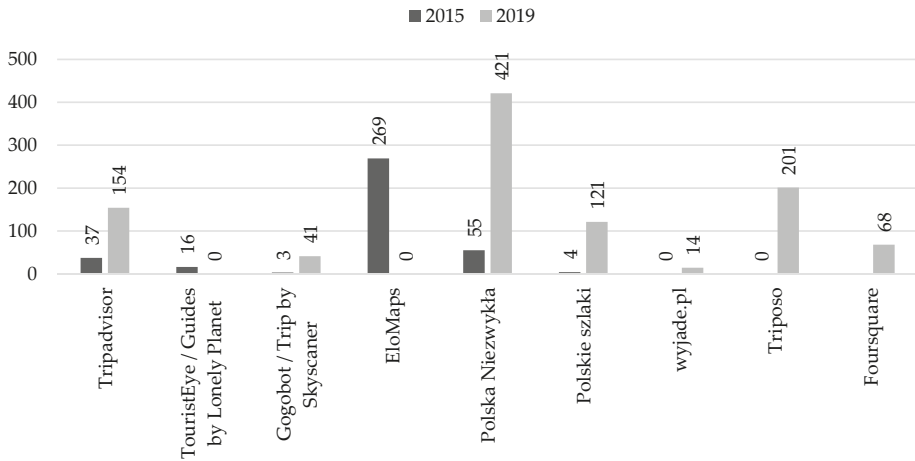

Figure 5. The number of tourist attractions found in all selected cities by each application in 2015 and 2019 (Source: Own research).

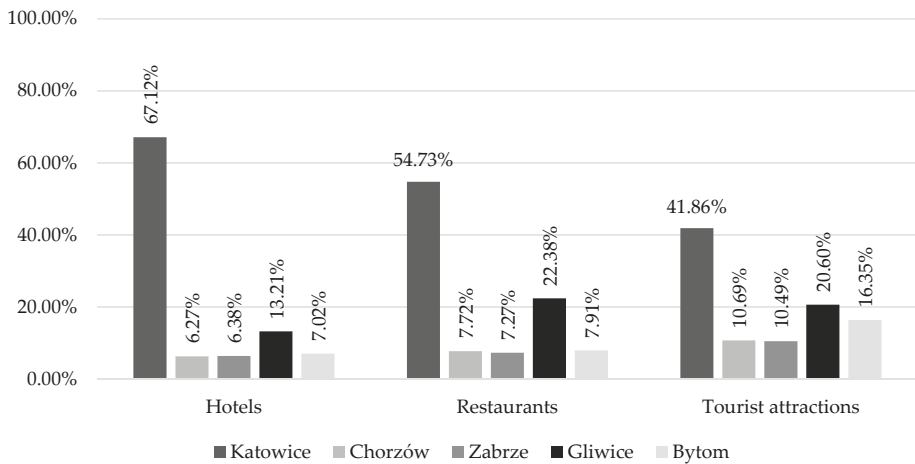

Figure 6. The percentage share of the average number of hotels, gastronomic establishments and tourist attractions found in individual cities (Source: Own research).

The presented data shows that the largest share of objects found in each category falls on Katowice. The second destination for which the analyzed applications found the most results was Gliwice. In other cities, the results in each category were similar. This shows that tourists visiting the Upper Silesian Industrial District using mobile applications will find, primarily, attractions, accommodation and restaurants in the capital of the Silesian Voivodeship.

5. Discussion

Based on the research results presented, several observations can be made. The first one is to note the high dynamics of the mobile application market targeted at tourists. Over the past four years, out of 14 applications analyzed, two ended their activities (*EloMaps* and *Worldmate*), and another two were transformed to fulfill a new, different function (*TouristEye* and *TripCase*). In addition, three of them (*Airbnb*, *Booking*, *Triposo*), did not function or did not gain their nowadays popularity back in

2015. This shows how dynamically the business models in tourism change, and adapt to changing conditions on the market.

For every functionality that was unchanged during the four year research period, some level of development was noted; hotel, restaurant, and tourist attraction databases contain more records than in the past (in many cases multiple increases).

In addition, it seems interesting that one of the most popular tourist applications in the world, *TripAdvisor*, offering comprehensive functionality of finding all three types of facilities, has relatively seen a small number of accommodation facilities in its database (compared to *Booking.com* and *Airbnb*). One can make a recommendation here to take action in this matter and undertake some programs that encourage Silesian hoteliers to post their facilities on this site.

In terms of the number of tourist attractions found, *Polska Niezwykła* leaves all other services behind (more than twice as many objects as in any other application). Unfortunately, this rich collection of entries is currently only available in the Polish language. It can be assumed that if the developers of this application added an interface and descriptions in English, it would effectively increase the group of its users, and at the same time, it would allow for more effective use of the tourist potential of Silesian region.

Generally speaking, the presented results show that significant development took place in the region of Upper Silesia in terms of adopting mobile technologies in tourism (or at least by marking the presence of the most important points of interest for tourists in existing services). As it goes for the restaurants and hotels, those are private businesses. One can expect that when more attractions will be present in apps for foreigners, the demand for those private services will increase and drive the managers and owners into advertising their businesses more extensively in apps for English speakers; hence, their presence in the most popular apps should grow. However, as mentioned before, this an expected outcome of increasing the number of tourist attractions available through mobile apps. Since a large portion of these are part of the public sector (government, voivodeship, town hall, etc.) it lays in its competence to develop programs that would support and encourage these entities to mark their presence in mobile applications—as part of nowadays very intensively executed promotional programs for the voivodeship. Achieving a stage where a significant number of touristic sites are available for smartphone users, both domestic and foreigner tourists, would be the first step in adopting the smart tourism concept in the Silesian metropolis, and more elements of it could consistently be added.

The development of tourists' uses of mobile apps and extend in their database records can be explained by the increasing number of tourists visiting Silesia. Since 2013, the number of tourist overnight stays has been constantly growing (from 4.6 M to 6.3 M in 2018). This shows that both the campaigns promoting Silesia as a touristic region and the start of adapting industrial heritage into touristic assets (since the IMR was created) have brought measurable effects. Upper Silesia, with its Industrial Monuments Route and sites on the UNESCO List, is heading in the direction of becoming an international industrial heritage tourism region, following the example of Ruhr region in Germany.

In terms of sustainable development of the Silesian region, the findings show that there is still a lot of space for improvements. The large disproportions between results from domestic apps and those for English-speaking users, that allow to find tourist attractions, indicate that the managers of touristic sites in Silesia might not be fully aware of the interconnections between all entities in a region, their role in international tourism, and how it is important for achieving sustainable development goals for the region, as well as for preserving heritage that is the core that attracts tourists to their business. They rather take the individual perspective, focusing on present customers and not on what causes them to be there, ignoring the big picture. This indication lays a path for further research in this area, and it might be beneficial for decision-making authorities to know the motivation of touristic sites runners and their awareness of their role in sustainable tourism. In the area of night's lodging and gastronomy, things look differently. The results from international apps showed that their databases are better suited for tourists from any part of the world.

The overall increase in database records shows the increasing interest in mobile apps among tourists and their meaning for them. This can be also interpreted as proof that mobile apps are not just a temporary phenomenon, but rather, they have become a permanent element of it. Therefore, they should be taken into consideration while making sustainable development plans for touristic sites and regions, i.e., by incorporating the smart tourism concept. This also implies that businesses that focus on supporting mobile solutions, and advertise themselves in them, incorporate these technologies into their business models. When a model like this proves to be successful, it is expected that it will be replicated and applied by other entities, and the readiness to adopt the smart tourism concept in Silesia should continue to increase.

The research also showed that there is a large disproportion between the number of touristic sites figuring in mobile apps in Katowice and all other cities. This is mostly due to the fact that Katowice is the capital of the Silesian Voivodeship, and acts as a communication node for this southern part of Poland, as many national and international train connections and flights start or end in this city. Therefore, the portion of temporary international visitors is much higher in this city, and the demand for an offer for global customers is higher. It would be in the spirit of sustainability if future development plans for this region would include projects for better communication and promotion of attractions in neighboring cities, that are based on cultural heritage, in order to provide sufficient interest in it so they do not become a subject of degradation.

6. Concluding Insights and Future Research

There are some limitations to this research. First of all, it was concerning only one region, with a specific type of tourism standing out—industrial heritage tourism. The touristic function in this region is still developing, as it is a former heavy industry district, where the transformation to a post-industrial economy is still in progress. Things might be very different in other parts of the country, where tourism has been developing for much longer (i.e., the city of Cracow, Warsaw, etc.). Furthermore, we limited our research to a certain part of the whole voivodeship. We focused on the Upper Silesian Metropolitan area since it is the main region where industrial tourism occurs. The statistical data provided by the CSO, as well as results that concern the whole voivodeship, can distort the real picture of industrial heritage tourism in this area since the southern part of Silesia has few characteristic features: it shares borders with the Czech Republic and it has many mountain resorts in the Beskids area. Moreover, the north part of the Silesian Voivodeship is a significant religious center in Częstochowa. These features draw different types of tourists to this region, other than industrial heritage tourists, making it hard to distinguish which type of tourism had more impact on certain effects or touristic indicators. Therefore, one can consider the fact that we focused on a specific type of tourism as another limiting factor. Industrial heritage that is used in tourism already is mainly concentrated in selected parts of the world or a country. In Europe, it can be mainly found in southern Poland, north-west Germany, some regions in France, Belgium, and various parts of the UK. Therefore the results and conclusions that we draw can be especially useful for those regions, or for regions that have the potential to become an industrial heritage region (like, for example, parts of Ukraine or Russia). Another limitation is that in our research, we focused mainly on one element of smart tourism, which is m-tourism, by selecting the most popular international and domestic touristic applications for smartphones. This did not include other types of applications that might be utilized in tourist attractions (like general VR, AR, QR code apps, etc.), or technologies that are offered or are supported by mobile devices (tracking, traffic analysis or gathering of big data).

Further analogous research carried out at a similar time interval (or shorter, e.g., annually) would allow a more accurate understanding of the phenomenon of m-tourism development in the Silesian region and the use of modern technologies by local tourism service providers. There is also a need to research and assess the readiness of the entire region to adopt the smart tourism concept regarding technical infrastructure, available systems, the degree to which ICTs and other technologies are already in use in Silesian tourist sites, and the willingness of public and private tourist sites to participate and

adopt this approach. Such findings, combined with previous ones, could potentially be used to build a framework, a model or a set of guidelines for cities, metropolitan areas or regions that could make the process of becoming a smart tourism destination more efficient and effective.

The obtained results could also be used for other types of research. First of all, future research in the Silesian Region could focus on comparing statistical data gathered over the last years with data from other, more developed touristic regions. Such comparison would allow one to assess the development rate in comparison to other regions and find potential areas of improvement, avoiding mistakes or applying solutions for issues that have already been solved elsewhere. Secondly, the data could be used to compare it with results from other regions that are, at the same or earlier, at the touristic development stage, in order to identify development trends and patterns that are characteristic for them. Having such a reference point, future destinations could use it for benchmarking and monitoring their own development.

The conclusion that can be drawn from the obtained results, and that would apply to many other touristic regions, is that since a large portion of heritage all over the world is financed and governed by the public sector, it lacks elasticity in adapting to change and new conditions (more tourists overall and a bigger demand for foreigner orientated services). Our results show that the response to the increasing number of tourists visiting the analyzed region was much more intense from the private sector (hotels and restaurants) than the public one (the majority of tourist attractions based on heritage are governed by the state or city). This reveals itself when one notices that the changes in database records regarding tourist attractions for international travelers are much smaller in comparison with hotel and gastronomy records. Meaning that, in the course of the last four years, many hotels and restaurant owners added their objects into the databases of global-ranged apps, responding to the demand of international tourists, while most of the tourist attractions are still mainly findable in apps dedicated only for Polish speaking users.

Other regions and local authorities can learn from the Silesian case, and while formulating development plans they should focus on two things. The first one is to use tourism as part of sustainable development that protects and preserves heritage in its most possible unchanged form for future generations; keeping in mind that smart tourism is not a temporary trend but rather the future form of tourism. Therefore, the future success of a tourist destination and its heritage faith depends on how fast and well a region can adopt this concept. The second thing is that while adopting the smart tourism concept, one should mainly concentrate on the public sector, which is more inertive to change because it functions and is financed differently than private entities, which need to adapt immediately to the changes in supply and demand and will do it by themselves.

Author Contributions: M.N. reviewed the literature in terms of smart tourism and mobile technologies, developed the methodology, co-developed the introduction and conclusions, developed and conducted the research, as well prepared the final contents of the article and proofread, K.H. reviewed the literature in terms of business models in tourism, smart tourism, and mobile technologies, as well as co-developed the introduction and conclusions. All authors have read and agreed to the published version of the manuscript.

Funding: This research received funding by the Ministry of Science and Higher Education in Poland.

Acknowledgments: This paper was published as part of the research project ‘Modern technologies in the functioning of industrial tourism enterprises’ No. 13/010/BKM19/0038, financed by the Ministry of Science and Higher Education in Poland.

Conflicts of Interest: The authors declare no conflict of interest. The funders had no role in the design of the study; in the collection, analyses, or interpretation of data; in the writing of the manuscript, or in the decision to publish the results.

References

1. Ginting, N.; Wahid, J. Exploring Identity’s Aspect of Continuity of Urban Heritage Tourism. *Procedia Soc. Behav. Sci.* **2015**, *202*, 234–241. [[CrossRef](#)]
2. Szromek, A.R.; Herman, K. A Business Creation in Post-Industrial Tourism Objects: Case of the Industrial Monuments Route. *Sustainability* **2019**, *11*, 1451. [[CrossRef](#)]

3. Szromek, A.R.; Naramski, M. Measuring Trust in Business Relations between Tourist Facilities on One Thematic Route. *Sustainability* **2019**, *11*, 3935. [CrossRef]
4. Szromek, A.R.; Naramski, M. A business Model in Spa Tourism Enterprises: Case Study from Poland. *Sustainability* **2019**, *11*, 2880. [CrossRef]
5. Szromek, A.R.; Wybrańczyk, K. Proposal of Value for Customers of Spas: Expectations of Spa Patients and Tourists in Polish Spas. *Sustainability* **2019**, *11*, 3598. [CrossRef]
6. Naramski, M.; Szromek, A.R. Configuring a Trust-based Inter-organizational Cooperation Network for Post-industrial Tourist Organizations on a Tourist Route. *Sustainability* **2019**, *11*, 3542. [CrossRef]
7. Khan, M.; Woo, M.; Nam, K.; Chathoth, P. Smart City and Smart Tourism: A case of Dubai. *Sustainability* **2017**, *9*, 2279. [CrossRef]
8. Berrone, P.; Ricart, J.; Carrasco, C. The open kimono: Toward a general framework for open data initiatives in cities. *Calif. Manag. Rev.* **2016**, *59*, 39–70. [CrossRef]
9. World Heritage Site List. Available online: <https://whc.unesco.org/en/list/> (accessed on 7 November 2019).
10. Naramski, M. Promocja śląskich obiektów turystycznych za pośrednictwem aplikacji mobilnych. In *Nowe Media I Technologie W Komunikacji Marketingowej—Obszary Zastosowań I Kierunki Badań*; Głuchowski, J., Spyra, Z., Maciag, J., Eds.; University of Economics in Katowice: Katowice, Poland, 2015; pp. 199–210.
11. UNWTO Annual Report 2017. Available online: <https://www.e-unwto.org/doi/pdf/10.18111/9789284419807> (accessed on 1 July 2018).
12. Kumar, V.; Kumar, U.; Persaud, A. Building Technological Capability through Importing Technology: The Case of Indonesian Manufacturing Industry. *J. Technol. Transf.* **1999**, *24*, 81–96. [CrossRef]
13. Schulz, A. The Role of Global Computer Reservation Systems in the Travel Industry Today and in the Future. *Electron. Mark.* **1996**, *6*, 17–20.
14. Davies, N.; Cheverst, K.; Mitchell, K.; Efrat, A. Using and Determining Location in a context-Sensitive Tour Guide. *Computer* **2001**, *34*, 35–41. [CrossRef]
15. Beaumont, E. Using CCTV to study visitors in The New Art Gallery, Walsall, UK. *Surveill. Soc.* **2002**, *3*, 251–269. [CrossRef]
16. Nerngchamnon, K.; Kaviya, S.; Fujii, Y. World Heritage City Surveillance System by a Smart CCTV. *Syst. Procedia Eng.* **2011**, *8*, 321–327. [CrossRef]
17. Choi, H.; Kim, S. A content service deployment plan for metaverse museum exhibitions—Centering on the combination of beacons and HMDs. *Int. J. Inf. Manag.* **2017**, *37*, 1519–1527. [CrossRef]
18. Tussyadiah, I.; Dan, W.; Jung, T.; Dieck, M. Virtual reality, presence, and attitude change: Empirical evidence from tourism. *Tour. Manag.* **2018**, *66*, 140–154. [CrossRef]
19. Mortiz, C. Mobile Application Development in the Tourism Industry and its Impact on On-Site Travel Behavior. Bachelor’s Thesis, Vienna University, Vienna, Austria, 2015.
20. Kennedy-Eden, H.; Gretzel, U. A taxonomy of mobile applications in tourism. *e-Rev. Tour. Res.* **2012**, *10*, 47–50.
21. Gartner Report. Available online: <https://www.gartner.com/en/newsroom/press-releases/2019-04-04-gartner-says-the-future-of-app-development-is-multiex> (accessed on 30 September 2019).
22. SpicyMobile 2019. Available online: https://spicymobile.pl/assets/doc/Turysci_2019.pdf (accessed on 30 September 2019).
23. González-Reverté, F.; Díaz-Luque, P.; Gomis-López, K.M.; Morales-Pérez, S. Tourists’ Risk Perception and the Use of Mobile Devices in Beach Tourism Destinations. *Sustainability* **2018**, *10*, 413. [CrossRef]
24. Cheung, C.M.; Thadani, D.R. The impact of electronic word-of-mouth communication: A literature analysis and integrative model. *Decis. Support Syst.* **2012**, *54*, 461–470. [CrossRef]
25. Hlee, S.; Lee, H.; Koo, C. Hospitality and Tourism Online Review Research: A systematic Analysis and Heuristic-Systematic Model. *Sustainability* **2018**, *10*, 1141. [CrossRef]
26. Porter, M.E.; Heppelmann, J.E. How smart, connected products are transforming competition. *Harv. Bus. Rev.* **2014**, *92*, 64–88.
27. Koo, C.; Ricci, F.; Cobanoglu, C.; Okumus, F. Special issue on smart, connected hospitality and tourism. *Inf. Syst. Front.* **2017**, *20*, 699–703. [CrossRef]
28. Gretzel, U.; Fesenmaier, D.R.; O’Leary, J.T. The transformation of consumer behavior. In *Tourism Business Frontiers*; Buhalis, D., Costa, C., Eds.; Elsevier: Oxford, UK, 2006; pp. 9–18.

29. Lamsfus, C.; Wang, D.; Alzua-Sorzabal, A.; Xiang, Z. Going mobile: Defining context for on-the-go travelers. *J. Travel Res.* **2015**, *54*, 691–701. [[CrossRef](#)]
30. Wang, D.; Park, S.; Fesenmaier, D.R. The Role of Smartphones in Mediating the Touristic Experience. *J. Travel Res.* **2012**, *51*, 371–387. [[CrossRef](#)]
31. Ritchie, J.R.B.; Crouch, G.I. The competitive destination: A sustainability perspective. *Tour. Manag.* **2000**, *21*, 1–7.
32. Stepchenkova, S.; Mills, J.E. Destination image: A meta-analysis of 2000–2007 research. *J. Hosp. Mark. Manag.* **2010**, *19*, 575–609. [[CrossRef](#)]
33. Gartner, W.C. Image formation process. *J. Travel Tour. Mark.* **1993**, *2*, 191–215. [[CrossRef](#)]
34. Marine-Roig, E.; Ferrer-Rosell, B. Measuring the gap between projected and perceived destination images of Catalonia using compositional analysis. *Tour. Manag.* **2018**, *68*, 236–249. [[CrossRef](#)]
35. Marine-Roig, E. Destination Image Analytics Through Traveller-Generated Content. *Sustainability* **2019**, *11*, 3392. [[CrossRef](#)]
36. Gretzel, U.; Yoo, K.H. Use and impact of online travel reviews. In *Information and Communication Technologies in Tourism 2008*; O'Connor, P., Höpken, W., Gretzel, U., Eds.; Springer: Vienna, Austria, 2008; pp. 35–46.
37. Litvin, S.W.; Goldsmith, R.E.; Pan, B. Electronic word-of-mouth in hospitality and tourism management. *Tour. Manag.* **2008**, *29*, 458–468. [[CrossRef](#)]
38. Liu, Z.; Park, S. What makes a useful online review? Implication for travel product websites. *Tour. Manag.* **2015**, *47*, 140–151. [[CrossRef](#)]
39. Marchiori, E.; Cantoni, L. The role of prior experience in the perception of a tourism destination in user-generated content. *J. Destin. Mark. Manag.* **2015**, *4*, 194–201. [[CrossRef](#)]
40. Wu, L.; Shen, H.; Fan, A.; Mattila, A.S. The impact of language style on consumers' reactions to online reviews. *Tour. Manag.* **2017**, *59*, 590–596. [[CrossRef](#)]
41. Hlee, S.; Lee, J.; Yang, S.B.; Koo, C. An Empirical Examination of Online Restaurant Reviews (Yelp. Com): Moderating Roles of Restaurant Type and Self-image Disclosure. In *Information and Communication Technologies in Tourism*; Springer: Cham, Switzerland, 2016; pp. 339–353.
42. Shin, S.; Chung, N.; Kang, D.; Koo, C. A Test of the Psychological Distance Effect for Online Travel Reviews Based on Construal-Level Theory. *Asia Pac. J. Inf. Syst.* **2017**, *27*, 216–232. [[CrossRef](#)]
43. Yang, S.B.; Shin, S.H.; Joun, Y.; Koo, C. Exploring the comparative importance of online hotel reviews' heuristic attributes in review helpfulness: A conjoint analysis approach. *J. Travel Tour. Mark.* **2017**, *34*, 963–985. [[CrossRef](#)]
44. Shaw, G.; Bailey, A.; Williams, A. Aspects of service-dominant logic and its implications for tourism management: Examples from the hotel industry. *Tour. Manag.* **2011**, *32*, 207–214. [[CrossRef](#)]
45. Wang, Y.; Fesenmaier, D.R. Towards understanding members' general participation in and active contribution to an online travel community. *Tour. Manag.* **2004**, *25*, 709–722. [[CrossRef](#)]
46. Ho, C.T.B.; Gebsumbut, N. Communication Factors Affecting Tourist Adoption of Social Network Sites. *Sustainability* **2019**, *11*, 4198. [[CrossRef](#)]
47. Muraya, A. *Running Lean: Iterate from Plan A to a Plan That Works*; O'Reilly Media: Sebastopol, CA, USA, 2012.
48. Magretta, J. Why business models matter? *Harv. Bus. Rev.* **2002**, *80*, 86–92.
49. Teece, D. Business models and dynamic capabilities. *Long Range Plan.* **2017**, *51*, 1–10. [[CrossRef](#)]
50. Morris, M. The entrepreneur's business model: Toward a unified perspective. *J. Bus. Res.* **2005**, *58*, 726–735. [[CrossRef](#)]
51. Shafer, S.; Smith, H.J.; Linder, J. The power of business models. *Bus. Horiz.* **2005**, *48*, 199–207. [[CrossRef](#)]
52. Osterwalder, A.; Pigneur, Y. *Business Model Generation: A Handbook for Visionaries, Game Changers, and Challengers*; Wiley: Hoboken, NJ, USA, 2010.
53. Lindgren, P.; Rasmussen, O.H. The Business Model Cube. *J. Multi Bus. Model Innov. Technol. River Publ.* **2013**, *1*, 135–182.
54. Johnson, M.W.; Christensen, C.M.; Kagermann, H. Reinventing your business model. *Harv. Bus. Rev.* **2008**, *86*, 57–68.
55. Cranmer, E.; Jung, T.; Dieck, M.C.T. The Value of Augmented Reality from a Business Model perspective. *e-Rev. Tour. Res.* **2017**, *8*, 1–4.
56. Ciurea, C.; Filip, F.G. Validation of a Business Model for Cultural Heritage Institutions. *Inform. Econ.* **2015**, *19*, 46–56. [[CrossRef](#)]

57. Langvinienė, N.; Daunoravipijntė, I. Factors influencing the success of business model in the hospitality service industry. *Procedia Soc. Behav. Sci.* **2015**, *213*, 902–910. [[CrossRef](#)]
58. Diaconu, M.; Dutu, A. Business model in the hospitality industry, from traditional to open innovation. *Sci. Bull. Econ. Sci.* **2014**, *16*, 3–10.
59. Mantaguti, F.; Mingotto, E. Innovative business models within niche tourist markets: Shared identity, authenticity and flexible networks. The case of three Italian SMEs. *J. Tour. Res.* **2016**, *6*, 9–10.
60. Beça, P.; Raposo, R. m-Tourism 2.0: A Concept Where Mobile Tourism Meets Participatory Culture. *e-Rev. Tour. Res.* **2011**, *2*, 30–35.
61. Gretzel, U.; Sigala, M.; Xiang, Z.; Koo, C. Smart tourism: Foundations and developments. *Electron. Mark.* **2015**, *25*, 179–188. [[CrossRef](#)]
62. Saarinen, J. Critical sustainability: Setting the limits to growth and responsibility in tourism. *Sustainability* **2014**, *6*, 1–17. [[CrossRef](#)]
63. Moscardo, G.; Murphy, L. There is no such thing as sustainable tourism: Re-conceptualizing tourism as a tool for sustainability. *Sustainability* **2014**, *6*, 2538–2561. [[CrossRef](#)]
64. Kim, D.; Kim, S. The role of Mobile Technology in Tourism: Patents, Articles, News, and Mobile Tour App Reviews. *Sustainability* **2017**, *9*, 2082. [[CrossRef](#)]
65. Mithat Ünler, M.; Güven, F.; Tamer Cavusgil, S. Bundling of telecom offerings: An empirical investigation in the Turkish market. *Telecommun. Policy* **2015**, *39*, 53–64. [[CrossRef](#)]
66. Trinh, T.T.; Ryan, C. Heritage and cultural tourism: The role of the aesthetic when visiting Mỹ Sơn and Cham Museum, Vietnam. *Curr. Issues Tour.* **2016**, *19*, 564–589. [[CrossRef](#)]
67. McKercher, B.; Ho, P.S.Y.; du Cros, H. Relationship between tourism and cultural heritage management: Evidence from Hong Kong. *Tour. Manag.* **2005**, *26*, 539–548. [[CrossRef](#)]
68. Du Cros, H. A new model to assist in planning for sustainable cultural heritage tourism. *Int. J. Tour. Res.* **2001**, *3*, 165–170. [[CrossRef](#)]
69. Gomez-Oliva, A.; Alvarado-Urbe, J.; Parra-Merono, M.C.; Jara, A.J. Transforming Communication Channels to the Co-Creation and Diffusion of Intangible Heritage in Smart Tourism Destination: Creation and Testing in Cetui (Spain). *Sustainability* **2019**, *11*, 3848. [[CrossRef](#)]
70. Fermeña-Serra, F.; Beuhofer, B.; Ivars Baidal, J. Towards a conceptualization of smart tourists and their role within the smart destination scenario. *Servic. Ind. J.* **2019**, *39*, 109–113. [[CrossRef](#)]
71. Bakıcı, T.; Almirall, E.; Wareham, J. A smart city initiative: The case of Barcelona. *J. Knowl. Econ.* **2013**, *4*, 135–148. [[CrossRef](#)]
72. Storper, M.; Scott, A.J. Rethinking human capital, creativity and urban growth. *J. Econ. Geogr.* **2009**, *9*, 147–167. [[CrossRef](#)]
73. Buhalis, D.; Amaranggana, A. Smart tourism destinations. *Inf. Commun. Technol. Tour.* **2014**, *1*, 553–564.
74. Gretzel, U. Intelligent systems in tourism: A social science perspective. *Ann. Tour. Res.* **2011**, *38*, 757–779. [[CrossRef](#)]
75. DeEsteban Curiel, J.; Delgado Jalón, M.L.; Rodríguez Herráez, B.; Antonovica, A. Smart Tourism Destination in Madrid. In *Sustainable Smart Cities*; Peris-Ortiz, M., Bennett, D., Pérez-Bustamante Yábar, D., Eds.; Innovation, Technology, and Knowledge Management; Springer: Berlin, Germany, 2017.
76. Koo, C.; Shin, S.; Gretzel, U.; Hunter, W.C.; Chung, N. Conceptualization of Smart Tourism Destination Competitiveness. *Asia Pac. J. Inf. Syst.* **2016**, *26*, 561–576. [[CrossRef](#)]
77. Lamsfus, C.; Martín, D.; Alzua-Sorzabal, A.; Torres-Manzanera, E. Smart Tourism Destinations: An Extended Conception of Smart Cities Focusing on Human Mobility. In *Information and Communication Technologies in Tourism*; Springer: Berlin, Germany, 2015; pp. 363–375.
78. Ramos-Soler, I.; Martínez-Sala, A.; Campillo-Alhama, C. ICT and the Sustainability of World Heritage Sites. Analysis of Senior Citizens' Use of Tourism Apps. *Sustainability* **2019**, *11*, 3203. [[CrossRef](#)]
79. Pradhan, M.K.; Oh, J.; Lee, H. Understanding Travellers' Behaviour for Sustainable Smart Tourism: A Technology Readiness Perspective. *Sustainability* **2018**, *10*, 4259. [[CrossRef](#)]
80. Buhalis, D.; Amaranggana, A. Smart tourism destinations enhancing tourism experience through personalisation of services. In *Information and Communication Technologies in Tourism 2015*; Springer: Berlin, Germany, 2015; pp. 377–389.
81. Huang, C.D.; Goo, J.; Nam, K.; Yoo, C.W. Smart tourism technologies in travel planning: The role of exploration and exploitation. *Inf. Manag.* **2017**, *54*, 757–770. [[CrossRef](#)]

82. Kwon, H.S.; Chidambaram, L. A test of the technology acceptance model: The case of cellular telephone adoption. In Proceedings of the 33rd Annual Hawaii International Conference on System Sciences, Maui, HI, USA, 4–7 January 2000; IEEE: Piscataway, NJ, USA, 2000.
83. Wolfe, H.B. The Insecurity of Mobile Phones. In Proceedings of the Informing Science & Information Technology Education Conference, Cassino, Italy, 19–24 June 2010; pp. 119–131.
84. Główny Urząd Statystyczny: Turyści w bazie noclegowej. Grudzień 2018 roku. Available online: https://stat.gov.pl/download/gfx/portalinformacyjny/pl/defaultaktualnosci/5494/5/79/1/kts_turysci_12m_2018.xlsx (accessed on 26 August 2019).
85. Tourism in 2014, Statistical Information and Elaborations, Central Statistical Office, Warsaw 2015. Available online: https://stat.gov.pl/files/gfx/portalinformacyjny/pl/defaultaktualnosci/5494/1/12/1/kts_turystyka_w_2014.pdf (accessed on 28 November 2019).
86. Tourism in 2015, Statistical Information and Elaborations, Central Statistical Office, Warsaw 2016. Available online: https://stat.gov.pl/files/gfx/portalinformacyjny/pl/defaultaktualnosci/5494/1/13/1/turystyka_w_2015.pdf (accessed on 28 November 2019).
87. Tourism in 2016, Statistical Information and Elaborations, Central Statistical Office, Warsaw 2017. Available online: https://stat.gov.pl/files/gfx/portalinformacyjny/pl/defaultaktualnosci/5494/1/14/1/turystyka_w_2016_zmieniona_07-11-2017.pdf (accessed on 28 November 2019).
88. Tourism in 2017, Statistical Information and Elaborations, Central Statistical Office, Warsaw 2018. Available online: https://stat.gov.pl/files/gfx/portalinformacyjny/pl/defaultaktualnosci/5494/1/15/1/turystyka_w_2017.pdf (accessed on 28 November 2019).
89. Tourism in 2019, Statistical Information and Elaborations, Central Statistical Office, Warsaw 2019. Available online: https://stat.gov.pl/files/gfx/portalinformacyjny/pl/defaultaktualnosci/5494/1/16/1/turystyka_w_2018_r.pdf (accessed on 28 November 2019).
90. Industriada Website. Available online: <http://industriada.pl/archiwum/> (accessed on 28 November 2019).



© 2019 by the authors. Licensee MDPI, Basel, Switzerland. This article is an open access article distributed under the terms and conditions of the Creative Commons Attribution (CC BY) license (<http://creativecommons.org/licenses/by/4.0/>).

Article

The Perception of Overtourism from the Perspective of Different Generations

Adam R. Szromek ¹, Beata Hysa ^{1,*} and Aneta Karasek ²

¹ Department of Organization and Management, Institute of Economy and Informatics, Silesian University of Technology, Akademicka 2A, 44-100 Gliwice, Poland; adam.szromek@polsl.pl

² Faculty of Economics, Maria Curie-Skłodowska University, Plac Marii Skłodowskiej-Curie 5, 20-031 Lublin, Poland; aneta.karasek@umcs.pl

* Correspondence: beata.hysa@polsl.pl; Tel.: +48-32-277-7336

Received: 15 November 2019; Accepted: 11 December 2019; Published: 13 December 2019

Abstract: The problem of overtourism, i.e., tourist congestion in visited places, and the negative impacts of tourists on the environment and residents, are increasingly noticeable with the increase in popularity of tourism. In addition, human impact on the environment is often negative in relation to the assumptions of the concept of sustainable development. However, the attitude of tourists to the problem of overtourism may vary depending on their ages, because, as in every aspect of life, there are intergenerational differences arising from the political, economic or technological development of the times in which a given generation grew up. The main purpose of the article is to examine the public awareness of the phenomenon of overtourism in the context of intergenerational differences, as well as to determine the impact of tourists on the places visited and the local community. The study was conducted on a sample of 386 respondents representing the X, Y, and Z generations. The study results showed that there is awareness among all generations of respondents about the problem of overtourism, although indifference to this phenomenon was demonstrated by the youngest respondents (Z generation). The respondents also agreed on individual elements of their own impact on the environment and residents, but with different determinations. The article ends with recommendations on the introduction of various management practices that should be implemented in order to make tourism more responsible and sustainable in the future. It is proposed that a road map should be compiled at the local level for sustainable tourism development.

Keywords: sustainable development; overtourism; Generation X; Generation Y; Generation Z

1. Introduction

The world's population is constantly growing, as is the number of tourists. The dynamism of tourism development in the world is due to, in particular, the industrial revolution, i.e., it is associated with the development of transport, speed of movement and the increase in wealth of individual countries and their inhabitants. This translates into an increase in the number of people who can afford to travel more frequently. In 2018, international tourist travel amounted to 1.4 billion people, while 710 million tourists come to Europe [1]. Along with the increase in the popularity of tourism, the problem appears with tourist congestion in visited places and the negative impact of tourists on the environment and residents. The tourism economy is one of the main contemporary sources of organized human impact on the landscape. However, this impact is often negative and interferes with the idea of sustainable development. Therefore, there is a tendency to implement the concept of sustainable development in tourism. According to the World Tourism Organization (UNWTO), we call sustainable tourism the kind that fully takes into account its current and future economic, social, and environmental impact, meeting the needs of visitors, industry, the environment, and host communities. The basis of this concept is, therefore, to achieve a balance between the needs of tourists, the natural

environment, and local communities. While the objectives of tourists, entrepreneurs, local authorities, and residents converge at the initial stages of tourism development in a defined area, conflicts increase with the expansion of tourism. One such conflict is the situation in which the expectations of tourists collide with the expectations of residents dissatisfied with the burdensome intensity of tourist traffic [2]. Hence, the main objective of the World Tourism Organization's 2030 agenda is to increase the level of sustainability knowledge and inspire the sector to take the necessary measures to accelerate the transition towards more sustainable tourism [3], which affects the sustainable development of individual countries. Therefore, it becomes important to explore the problem of excessive tourism (overtourism), because, although this concept increasingly appears in both media [4,5] and scientific discourse [6–8], in many countries this phenomenon is poorly known [9]. In particular, the awareness of tourists themselves as to their negative impact on the environment and residents seems to be poor. For example, when analysing the number of Internet searches for the term “overtourism” on a weekly basis in Poland in the period from November 2018 to October 2019, it can be seen that the maximum noted was only eighty [10]. It is also assumed that low social awareness in this area is probably not the same in all age groups of tourists. In this regard, it seems interesting to deepen scientific research on the phenomenon of overtourism in relation to specific age groups, or rather generations. The observed differences between generations result from the political and economic situation, and technological development in the times when a given generation grew up [11–13]. That is why they are often characterized by different tastes, dress styles, behaviours, musical preferences, approach to work, and even to travel. Moreover, the age-based classification of the population is often used in the segmentation of the tourism market. Determining the characteristics of the target group allows for a better adaptation of the product to the needs and capabilities of the customer—tourist. What is more, there are intergenerational differences in the motives for undertaking tourist trips, preferences stay in tourist destinations or harmfulness of tourists' impact on the environment. Four generations are distinguished in social sciences [11–13]: Baby Boomers, Generation X, Generation Y, and Generation Z, as well as the youngest Generation Alpha (born after 2010).

Therefore, it seems reasonable to conduct a study diagnosing the phenomenon of overtourism in the context of the awareness of different generations. Therefore, the purpose of the article is to assess the awareness of tourists of different generations in the field of the phenomenon of overtourism, and to learn about their knowledge of their personal impact on visited places and the local community.

2. Literature Review

2.1. Sustainable Development and Sustainable Tourism

Achieving sustainable development goals requires ensuring the coherence of three key elements: economic growth, social inclusion, and environmental protection, which is important for achieving the well-being of individuals and entire societies. In August 2015, 193 UN (United Nations) member states reached a compromise on the final document of the new agenda “Transforming our world: Agenda for Sustainable Development—2030”, which contains 17 goals and 169 tasks. Sustainable development requires action on many levels and entails the implementation of regulations in particular areas. Enterprises, thanks to the implementation of more inclusive and sustainable business models, can, among others, increase their business efficiency and risk management [3] (p. 13). On the other hand, the implementation of the Sustainable Development Goals (SDG) into the enterprise's operations can improve the sector's competitiveness [14]. In many countries, tourism is an important sector of the economy, which brings financial benefits for the state, the region, and the local community. In the world, the largest financial revenues from tourism were noted in Europe (USD 570 billion), as well as Asia and the Pacific region (USD 435 billion) in 2018. [1]. In the European Union (EU), the number of overnight stays at tourist accommodation establishments has been steadily increasing since 2009 and reached 3254.3 million in 2017, with the share of overnight stays provided to foreign tourists increasing by 49.2% [2], while 2018 global earnings amounted to 1.7 trillion [1]. More than half of

EU residents' overnight stays (55.2%) were spent in rented accommodation [15]. Therefore, hotels or similar places need qualified staff to provide tourists with accommodation and other tourist services. In 2016, over 13 million people were employed in the tourism industry in EU countries [15]. Consequently, employment in tourism translates into macroeconomic indicators for the region. In the EU, 21 of 30 regions with the highest tourism intensity have an unemployment rate below the national average [16]. The data presented above indicates a number of financial benefits, which are obtained by destinations eagerly visited by tourists.

Analyzing the number of tourists, we can see their steady increase since 2009. In 2018, international tourist arrivals increased by 5% and reached 1.4 billion people. [1]. Europe was visited by the largest number of tourists (710 million), while the largest increase in the number of tourists was noted in Asia-Pacific and Africa (7%) [1]. In 2017, more than half (58%) of the total nights spent by nonresidents in the EU were spent in Spain, the United Kingdom, Italy, and France [15]. In turn, 62% of EU residents made at least one personal trip in 2017, while Finns did it the most often (91.3%) [15]. Analysing European statistics, Poland stands out the most, as in 2018 it was visited by 19.6 million tourists [2]. In this country, one can observe a continuous increase in the number of accommodation facilities provided to tourists. In Poland, in the first half of 2019, compared to the first half of 2018, there was a visible increase in the total number of tourists using an accommodation facility by 6.1%, as well as the number of overnight stays by 6.5% [16]. At the same time, there was an increase noted in the number of foreign tourists by 4.5% and the number of nights spent by them by 5.1% [16]. However, the average share of overnight stays provided to foreign tourists in the total number of overnight stays for the EU was 49.2%, while for Poland it was only 19.9% [2], which was the second-lowest share of tourists among the surveyed countries. This indicates that the interest of tourists in Poland is growing, despite the fact that now there is a low level of foreign tourists' participation. Therefore, it is necessary to explore the problem of overtourism in Poland, because that phenomenon will increase in strength. Analysing the data of tourism intensity, one can observe a large variation in the scope of guest nights spent in tourist accommodation establishments per inhabitant. Among European countries in 2017, the highest rate was recorded in the following countries: Malta (20.8), Croatia (20.7), Cyprus (19.6), and Austria (13.8), while there was an average of 6.1 guest nights throughout the EU [15]. The presented data indicates that the number of tourists is constantly increasing, which causes high tourist traffic on access routes, in public transport, as well as in the places visited. Moreover, estimates indicate that in 2030, 1.8 billion tourists in the world will cross borders [9]. In 2017, 62% of EU residents made at least one personal trip [15]. Therefore, in order to ensure sustainable development, it is necessary to take action in the field of sustainable tourism.

The 2030 agenda aims to inspire industries to take measures to maintain sustainable development, including in the area of tourism. This is reflected in Goal 8, "Decent Work and Economic Growth"; Goal 12, "Responsible Consumption and Production"; and Goal 17, "Partnerships for the Goals". Moreover, task 8.9 was formulated stating that, by 2030, policies should be developed and implemented to promote sustainable tourism that creates jobs, and promotes local culture and products. In order to measure the degree of implementation of this measure, an indicator has been developed, which is calculated as a percentage of tourism in relation to GDP. The value of this indicator in 2017, both on a global scale and in Poland, was 0.1%, and its value increased compared to the previous year [15].

Unfortunately, with the expansion of tourist traffic, incidents related to its burden on the natural and cultural environments of tourist areas are increasingly observed. To support sustainable tourism development practices, the World Tourism Organization and the United Nations have developed a Development Program. In it, they recommend that donor countries need to pay special attention to the challenges and needs of developing countries, and that tourism decision-makers in developing countries can attract more funding if their tourism activities focus on those areas that are most relevant for donor countries [3]. In order to ensure sustainable development, it is necessary to identify factors affecting the sustainable development of tourism in the context of a given location. Local authorities should support entrepreneurs and provide financial support so that they will be able to develop

business models that foster inclusive green growth—in particular in those areas where voluntary action is not sufficient to achieve the SDGs [3]. In order to manage tourist traffic and preserve sustainability, a number of different actions are proposed. Actions are proposed to minimize the anthropogenic impact on the environment and to protect the natural environment and culture [17,18]. In turn, other recommendations were formulated to ensure the sustainable development of entertainment tourism [19].

It becomes necessary to conduct research in the field of sustainability in tourism, which is emphasized in the literature [20]. In particular, research on tourists' awareness of their impact on sustainable development appears to be important. Sustainable tourism has been described as tourism "that takes full account of the current and future economic, social, and environmental impacts, addressing the needs of the visitors, the industry, the environment, and host communities" [9]. It indicates that attention should be focused on time, type of influence and various stakeholders. The group of stakeholders is diverse, as it includes both residents and visitors, for whom the expected benefits of tourism are different. Tourists expect access to tourist attractions and amenities for them, while residents demand respect for their rights regarding access to urban infrastructure, public services, and improvement of quality of life.

It should be emphasized that stakeholders have different levels of awareness about the economic benefits of sustainability. This is confirmed by the results of research that showed that the perceptions of the sustainability of the stakeholders involved in rural tourism development were very different [20]. Moreover, tourism enterprises often lack awareness of how efforts and investment in sustainable business operations can also significantly boost competitiveness and profitability, while increasing customer and host community satisfaction [3].

The basic prerequisite to undertake research and to formulate the research problem is the significant increase in the number of tourists, noticeable for years, and the continuous growth of the tourism sector (as estimated by the World Tourism Organization (UNWTO)) by 3.3% annually until 2030 [9] (p. 4). Tourists visit areas of natural and cultural interest, as well as for entertainment. More and more tourists visit residential areas [18], while entertainment attractions are located in many places to encourage tourists to travel and provide them with joy [20]. The increase in the number of visiting tourists, as well as the development of spending time, will have an effect on other sectors of the economy and enterprises. Moreover, adverse climate change, environmental degradation, population growth, and the growing awareness of buyers about their chosen solutions means that a new approach is needed to build a sustainable and disaster-proof future strategy for society and all organizations. Therefore, it is necessary to take actions, in the field of sustainable tourism development. Such actions were taken, for example, by the Global Sustainable Tourism Council (GSTC), whereby it developed criteria/standards for sustainable development in tourism. These criteria are organized into four pillars [19]:

- sustainable management;
- socio-economic effects;
- impact on culture;
- environmental impact (including resource consumption, pollution reduction, and preservation of biodiversity and landscapes).

For this purpose, it is necessary to examine the level of public awareness of its impact on ensuring sustainable development. This becomes important because of the impact that stakeholders have in economic, social, and environmental terms in a given area [21]. The divergent needs of tourists and residents cause a conflict of interest in the area of tourism, in particular in terms of their impact on the economy, society, and the environment. It is emphasized that sustainable tourism and overtourism are an important context that affects the right to travel and the right to live [18]. Certainly, a discussion is needed on how to achieve sustainable development, in particular in the area of growing tourist traffic.

2.2. Overtourism

The notion of overtourism in literature appeared relatively recently, which is why in many languages there is not yet a shaped translation of this concept. However, the presence of this phenomenon is often observed in the media, which reports on the problems of congestion and the negative impact of tourists on the environment, and on inhabitants in popular tourist destinations [3,4,22,23]. Although the term has only appeared in scientific publications only since 2017 [24], this does not mean that this problem has not been raised before. In the 1970s, special indicators were developed to determine the optimal size of tourist traffic for various regions: an absorption indicator, a capacity indicator, and a flow indicator [25]. We also see the beginnings of measuring changes in residents' attitudes towards tourists in the work of Doxey [26], who lists four phases: euphoria, apathy, annoyance, and antagonism. However, in 1980, Butler [27], in the concept of the tourism area life cycle (TALC) points out that tourist destinations negatively feel the consequences of their success. Although the term 'overtourism' was not used at that time, previous publications clearly revealed the potentially negative effects of the rapidly growing tourism sector. The TALC concept already contains elements that quantify overtourism, by using the terms 'tourism capacity' and 'absorbency'. Four decades later, the same author tackles the topic of overtourism to its full extent [28].

The World Tourism Organization (UNWTO) defines overtourism as: "the impact of tourism on a destination, or parts thereof, that excessively influences the perceived quality of life of citizens and/or quality of visitors' experiences in a negative way" [3]. In contrast, the EU [24] in its research on overtourism describes this phenomenon as: "the situation, in which the impact of tourism, at certain times and in certain locations, exceeds physical, ecological, social, economic, psychological, and/or political capacity thresholds". The definition of the phenomenon of excessive movement around the world, with the following references to literature, both historical and current research, is discussed extensively by Kruczek [29].

Currently, according to recent studies [30–32], excessive tourism causes, among other issues, alienation of residents, a worsening of the tourist experience by visitors, an overload of infrastructure, damage to the natural environment, and a threat to culture and heritage. Every year, the number of cities in the world, such as Venice, Barcelona, Dubrovnik, Amsterdam, Berlin, Prague, Hong Kong, Rio de Janeiro, Shanghai, Palma de Mallorca, and Lisbon [33]; or in Poland, such as Zakopane and Kraków [34], that struggle with the problem of excessive tourist traffic, increases.

There are three dimensions to the negative impact of overtourism [24] (pp. 87–88): environmental, economic, and social. The consequences of excessive tourism for the natural environment primarily include overpopulation and devastation in places attractive to tourists, including natural, historical, and architectural places, a strong or noticeable contribution to water, land and air pollution, and problems with solid waste removal [24] (pp. 87–88). In places, where the number of tourists increases significantly, there is a greater economic dependence on tourism, including the strong impact of seasonality and degradation of other sectors or types of employment. Beyond the problems concerning the negative impact of overtourism on the environment and the economy of individual cities, the social dimension is also significant. The growing number of tourists causes many burdens and inconveniences for the local community. It is observed that adaptation to tourists occurs first, and then to residents [8]. Therefore, the implementation of stricter regulations for tourists is recommended to ensure inhabitable, tourist-friendly cities [35].

In particular, the young generation can be a big problem for the local community, because their way of spending time disturbs the peace in tourist destinations. Young people are eager for new experiences—for many of them traveling is the goal of life, their passion. The social effects of overtourism are also the worsening of (perceived) security, due to increased crime and violence, problems related to uncivilized behavior, alcohol consumption, prostitution, gambling, and drug trafficking. It also leads to possible misunderstandings or hostility (e.g., social conflicts and protests) [24] (pp. 87–88). In addition, it can also weaken local cultural traditions, moral values, and standards, leading to a loss of community spirit and pride, as well as a loss of the given country's cultural identity.

Cities recognize the problem of overtourism and are looking for different solutions [2,4,5,7,8,36]. There is a lively discussion regarding the rights of tourists and residents [37]. Politicians, city managers, and scientists are wondering how to solve the problem of tourist congestion [38] having a negative impact on the local community and the environment [22].

Various kinds of strategies and countermeasures are adopted. For example, the following can be mentioned [9] (p. 10): promoting the temporary dispersion of visitors, stimulating the creation of new routes and attractions for visitors, communication, and the involvement of local stakeholders and visitors. Solutions are being implemented for the adaptation of tourism practices, increasing the capacity of existing systems, and improving residents' perceptions of tourism, also by means of "smart" technological solutions [8]. It is also worth providing local communities with the opportunity to enjoy tourist attractions and create places that benefit both the residents and visitors.

In turn, EU recommendations [24] (pp. 87–88) contain, among other items, such guidelines as conducting more systematic research on the issue of excessive tourism in rural areas, coasts, and islands, as well as natural and cultural heritage; initiating debates on tourism development; and management of economy sharing platforms, such as Airbnb [39]. Moreover, more attention was paid to the qualitative elements of tourism development (profitability, local employment, fair pay rates) and not just the increase in the number of tourists. An important aspect is also supporting the monitoring of the "moods" of tourists, hosts, and (other) residents to earlier notice psychological and social problems during the excessive development of tourist traffic. Moreover, managers in tourist cities should collect data on the stay duration, expenditure, and/or intention to act, in order to identify profitable markets that are more economically, socially and environmentally resilient [6].

The problem of excessive tourism can also be solved by striving to develop sustainable tourism destinations, in this way balancing the equality of the right to travel with the rights of residents. This requires the involvement and cooperation of a wide range of stakeholders, thanks to which it is possible to implement tourism planning and management measures that will be accepted by everyone. An example is the Paris Agreement on Climate Change, which helped mobilize individuals, industries, governments, and other organizations to cooperate, in order to reduce greenhouse gas emissions [14]. However, to adopt some general principles and assumptions, it is necessary to thoroughly investigate and describe this phenomenon.

2.3. Travel by Generations

Assuming that the generation is an identifiable group of people, who share similar birth times and experience of important events at development stages, one can now point to four generations of people indicated in the scientific literature, ([11,13,40], ([41] p.234), ([42] p.307), [43]) those active and physically fit enough to enjoy tourist trips [44]. Namely, they are [43]:

- Baby Boomers (BB)—born in 1945–1964, the so-called generation of the baby boom and economic boom;
- Generation X—born in 1965–1980, growing up during the economic crisis of the 1970s;
- Generation Y (Millennials)—born in 1981–1994, brought up in the era of globalization and universal access to the Internet;
- Generation Z—born after 1995, which uses modern information and communication technology for everything.

The next generation after Z is the Alpha Generation (born after 2010). It is a group of children aged nine years and younger, so they are not considered in the elaborated study.

The Baby Boomers generation nowadays is taking an increasingly active part in recreational activities, such as hiking, diving, surfing, climbing, and traveling to various places around the world. The growing mobility of this generation is associated with their well-established social position, financial possibilities, and having more free time because their adult children have started their own families. The eldest of this generation are already retired and those who are still working need more

time to relax and relieve stress. The needs and interests of the baby-boom generation are changing because this generation has become healthier and wealthier than in previous years [45]. As the Naidoo research [46] shows, the main motivators in making tourist trips of this generation are taking pleasure and joy from traveling, soothing stress and tension, relaxation, the need for change and novelties, as well as the appreciation of the attractiveness of the physical environment, and caring for better health.

Generation X are people born in 1965–1977, who are currently 37–49 years old, and who grew up and entered adult life in Poland during the restructuring of the economy. Inflation, increased unemployment and employment instability forced them to accept temporary contracts and accept jobs below their qualifications. The times in which they had to start their careers made them entrepreneurial people, but also exacerbated the atmosphere of uncertainty and fear associated with the possibility of losing their jobs. However, as mature people, they are most often the owners of large enterprises, as well as supervisors and teachers for Generations Y and Z. Similarly, in the United States, Generation X is described as born in bad economic conditions [47], and their attitudes and beliefs were shaped by the first war in Iraq [47], the climate of school shootings, reality shows [48] and HIV epidemics. Family is first for this generation, which is why they plan trips with the family and children to the sea, mountains, or lakes. They also often visit popular cities, where you can find interesting monuments or rich history. When choosing to travel abroad, they usually look for quiet, recreational places, or interesting cultural monuments. Despite the fact that people from this generation were born in analogue times, they fit perfectly into the modern digital world and modern technologies, which is why they willingly use the Internet when planning and booking their tourist trips.

The phenomenon that shaped Generation Y (Millennials) was globalization, which caused the blurring of barriers between countries, internationalization of enterprises, merging cultures, and increasing access to products and services from around the world. Double earnings of parents have become a standard, guaranteeing good conditions for the personal development of their children. Respect for ethics, multiculturalism, awareness of social problems, and the possibility of using information and communication technology are of great importance for this generation. This generation is extremely mobile, willingly travels, moves from one place to another, and the decision to emigrate is ready to be made quickly and not necessarily for economic reasons. The circle of friends of this generation is not limited to people living in one place, but they have friends all over the world. Their main values are independence, ambition, creativity, innovation, and development. Representatives of Generation Y travel more than their predecessors, they visit and explore a greater number of destinations, spend more while traveling and are eager for interesting experiences and information [46,49]. Moreover, as research by Dębski [50] and Xiang, Magnini, Fesenmaier [31] indicate, people from Generation Y show a strong need to use the opportunities generated by the Internet and social media while planning and sharing their experiences during and after the journey. Research by Santos, Veiga, and Aguas [51] shows that Millennials are an increasingly important and larger group in tourism, which is also associated with their great need to travel. Moreover, they highly value travel comfort and follow a variety of adventures, seek unique experiences, and do not just expect passive recreation. Generation Y tourists are increasingly avoiding mass tourism, wanting to be seen as travelers rather than tourists [51]. This is associated with greater independence in planning trips and also with their concerns about the environment [52]. In comparison with Baby Boomers and Generation X, Generation Y is much more active when it comes to planning travel trips or booking accommodation through the Internet (dedicated websites, e.g., booking.com), or using social media (such as TripAdvisor) [53].

Despite that the representatives of Generation Z have many features in common with representatives of Generation Y, there is agreement among researchers [12,44,54] of this generation, that although some features are more visible in them, they are significantly different in many respects. Generation Z is a generation open to the world and novelties, not only technological but also those related to exploring new places. This is a multitasking generation, where social media is their main form of communication. A characteristic feature of this category is often the preference for virtual relationships, rather than establishing real interpersonal relationships. People from Generation Z are

very open to the world and willingly undertake various forms of tourist activity, although they often lack financial resources because they are not yet professionally employed and are dependent on their parents. Therefore, due to financial restrictions, this group dominates domestic recreation, with family or friends. A survey conducted by Expedia Group Media Solutions in 11 different countries in 2017 and 2018 revealed that representatives of Generation Z most often travel to rest (59%), visit family (41%), take part in special events (26%), or for entertainment purposes (21%). The analysis of Expedia Group Media Solutions also shows that 84% of people from Generation Z think that social media plays an important role when planning travel. On social networks, they look for promotions, among other things, as well as getting inspiration to travel by viewing photos and videos published by friends or experts. It is also worth noting that as many as 66% of the representatives of Generation Z during trip planning are not committed to a specific destination and are open to inspiration regarding the holiday spot and the place of departure (74%).

3. Materials and Methods

In order to get the answer to the research questions posed in the article, it was necessary to conduct empirical research among people from different generations, where the division of society into different groups was made on the basis of literature analysis. The main criterion for dividing the respondents was the generation the respondent came from. They were determined based on the respondent's year of birth. The sample was stratified random sampling in Poland. However, the respondents had to have one consistent feature, which was experienced in the field of tourist trips. A pre-test was conducted and some adjustments were made before sending the questionnaire. The invitation to the survey was distributed by 424 emails in October 2019. In order to reach people of different ages (generational layers), who have undertaken tourism activity in recent years, emails with the link have been shared on discussion forums and travel groups on social media.

The research questionnaire contained seven questions, two of which had an extensive structure, including testing the agreement of respondents with the opinions presented on the occurrence of overtourism and their own impact on the tourist area. The choice of questions was deliberate, as they were to indicate selected phenomena that resulted in the occurrence of overtourism in tourist destinations. In several cases, the question was repeated in the opposite context to verify the reliability of the answers given. Thanks to the Likert scale used, it was possible to choose one of five response variants, arranged symmetrically, in terms of positive or negative reference to the issue being addressed. The choice of an intermediate answer meant a neutral attitude to the issue under review, or no opinion on a given topic. The obtained responses were quantified in such a way that a positive attitude towards a particular phenomenon was assessed by a value of 2 or 1 when the positive response was supported only partially. In the case of a negative rating, the grade awarded was -2 , unless it was partially negative, then the grade -1 was allocated. The neutral grade was awarded with a value of 0. Meanwhile, the average rating of a given response variant higher than zero means a positive attitude of all respondents to the issue. A negative average value indicated a negative attitude of all respondents to a given opinion. This made it possible to compare the responses given by nonparametric statistical tests in individual groups designated by generational identification. The main questions were followed by a record specifying their gender, age, and education, as well as tourist experience, differentiated by the length and frequency of tourist trips.

After the initial selection of collected questionnaires, 396 respondents were qualified for further analysis, which exceeded the minimum random sample size estimated at 386 questionnaires (for the assumed maximum statistical error rate of the sample of $\pm 5\%$ and the confidence level $p = 0.95$).

The elaboration of the collected data involved the performance of statistical analysis, of both one-dimensional (in the form of classical or positional descriptive analysis) and two-dimensional (in the form of analysis of the relationships of pairs of tested features) natures, and even in a multidimensional dimension, by means of correspondence analysis [55]. In some cases, the level of significance of differences between the obtained average values was also studied. For comparison of two

groups of variables with a distribution different than normal, the U (Mann–Whitney) test was used [56]. The significance of differences between structure indicators was verified with the Chi-squared test. When verifying statistical hypotheses, the statistical tests were used, taking into account significance at the level of $\alpha \leq 0.05$. In the interdependence analysis, Pearson’s linear correlation coefficients and t-Student significance test for the correlation coefficient were used [57].

Correspondence analysis is a method of multivariate qualitative analysis, using a two-dimensional comparison of many variables by using their taxonomic distances. The results of correspondence analysis are presented in two-dimensional drawings of mutual relations of the qualitative responses obtained.

4. Results of Research

The survey involved 386 respondents, among whom 59.8% were women and 40.2% men. Taking into account the criterion of division of the respondents according to generations, the survey sample included 58.8% of people from Generation Z, 21.5% of people from Generation Y and 19.7% of people from Generation X. The BB generation also took part in the study. However, it was not possible to obtain sufficient numbers of this group of respondents (<30). This is not a sufficient representation of the respondents on the basis of which it is possible to infer, therefore this generation was omitted in further analyses. Table 1 gives the structure of the respondents. It already covers only three generations. Undoubtedly, this is one of the limitations of the presented study, which is why it will be undertaken in subsequent studies of the authors. Among the respondents, well-educated people predominated—over 60% of people had at least post-secondary education (first-degree graduates). High school graduates constituted 38.6% of respondents (Table 1).

Table 1. Structure of respondents.

Generations	[%]	Length of Tourist Trips	[%]
X	19.7%	no rule	33.6%
Y	21.5%	1–3 days	27.0%
Z	58.8%	4–6 days	26.5%
		one week >	12.9%
Level of Education	[%]	Frequency of Tourist Trips	[%]
Basic/Junior high	1.0%	less than once a year	15.4%
Secondary	38.6%	once a year on average	28.3%
Higher I	27.5%	several times a year	56.3%
Higher II	30.8%		
Postgraduate	1.0%		
PhD	1.0%		
Gender of Respondents	[%]	Knowledge about Overtourism	[%]
Woman	59.8%	Yes, I met this phenomenon personally	67.7%
Man	40.2%	I heard about it from the media/friends	20.7%
		No, I’ve never encountered it	11.1%

Source: based on own study.

The surveyed people showed a very diverse length of tourist trips including at least one night. More than every fourth respondent usually decided on 1–3 days’ weekend trips (27.0%) or trips lasting 4–6 days (26.5%). In terms of the frequency of trips, the overwhelming majority (56.3%) go several times a year, and every fourth (28.3%) at least once a year. Every third respondent (33.6%) undertook trips of varying lengths.

Respondents were asked about knowledge on overtourism. Nine out of ten respondents (88.4%) stated that they knew of this phenomenon. However, every fifth respondent (20.7%) heard about this from the media or from friends, while 67.7% of people came across this phenomenon directly.

Analyzing the responses of the respondents in general (without a generational breakdown) to the questions in which the respondents had to agree or disagree with the opinions presented to them, one can indicate the opinions for which a high degree of agreement has been noticed, as well as several of those to which the respondents disagreed. These opinions can be ranked according to the decreasing degree of agreement of the respondents. This is the following order:

- *During the trip, I do not litter the environment, I do not make noise, and I turn off electrical devices when leaving the hotel room* (average rating is 1.48 ± 0.78);
- *I always behave in a civilized way, no matter where I am* (the average rating is 1.48 ± 0.80);
- *During the trip, I use natural resources in the same way as in my home* (the average rating is 1.08 ± 1.00);
- *My presence in a tourist location means only benefits for residents* (the average rating is 0.26 ± 1.00);
- *I pay for the holiday, so I can use the local amenities however and whenever I want* (average rating is 0.06 ± 1.28);
- *To be honest, it is not my concern—I want to relax when I feel like it* (average rating is 0.04 ± 1.39);
- *This is an exaggeration—in my opinion, the negative impact of tourists is exaggerated* (the average rating is -0.30 ± 1.04);
- *During the trip, I sometimes use more water for washing and more electricity than at home* (the average rating is -0.51 ± 1.29);
- *I believe that during a tourist trip I am free to do more, I am on holiday after all* (average score is -0.61 ± 1.30);
- *I do not intend to deal with what the residents think about my presence and behavior* (average score is -0.76 ± 1.16).

According to the adopted methodology for assessing individual issues, the following intergenerational differences can be noticed:

- Indifference to the phenomenon of overtourism was demonstrated by the youngest respondents (Z generation). Their results of agreement with the opinion that overtourism is not their concern are similar and positive, which means that they generally agree with this opinion. Intermediate groups of respondents (X and Y generations) do not agree with indifference to this phenomenon. Comparative analysis between the generations confirmed that there is a statistically significant difference between the average ratings of the X and Z generations ($p < 0.001$) and Y and Z ($p = 0.020$).
- In general, all respondents agree that tourist visits are associated with benefits for residents. Generation Y agrees with this statement much more often than people from other generations, in which there is a greater tendency to an intermediate response (*difficult to say/I do not know*).
- In the case of opinions that the popularity of the phenomenon of overtourism results from exaggerating its real significance, the responses are unambiguous. All generations negatively refer to this statement, which means that in generations X, Y, and Z the problem of overtourism is perceived as serious.
- The distribution of responses on the subject of higher water and electricity consumption during tourist stays is interesting. The respondents from all generations disagree with this opinion, while it is twice as emphatic in Generation X than in the Y and Z generations, which show great similarity in this respect ($p = 0.767$).
- The opinion on whether during the tourist trip the respondents were allowed more than in everyday life did not gain approval. In general, the ratings obtained were negative, and in Generation X, strong opposition to this opinion was more frequently expressed (-1.14 ± 1.08).

- A material factor related to the opinion that a tourist has the right to use the destination freely, since they pay for it, did not gain the approval of the X and Y generations, while the people of Generation Z rather agree with this view (0.41 ± 1.17).
- For all generations of tourists, the opinion of residents on their behavior in the destination turns out to be important. This is indicated by average ratings in all groups, with higher averages again in generations X and Y.
- The above result seems to be consistent with what was obtained in the study on the responses of respondents from different generations on their opinions about their manners during the trip. All generations agree that their civilized behavior does not depend on where they are, and therefore is identical in a holiday spot and the home environment.
- In the next question, in order to control the reliability of responding, one of the previously asked questions was repeated (but in the opposite context). It was a question about similar consumption of natural resources at home and during a tourist trip. The answers obtained confirm the reliability of the research tool, because the average scores are very similar to those given when asked about water and electricity consumption. Of course, the results were positive this time, because they were put in a positive context.
- The respondents generally strongly agreed with the statement that they do not litter the environment, do not make noise, and turn off electrical devices while leaving the hotel room. What is noticeable here is the fact that the frequency of confirming this opinion decreases with the increasingly lower age of respondents (Table 2).

Table 2. Results of average agreement assessments of respondents from different generations with the opinions presented.

<i>What do You Think About Your Own Impact on the Inhabitants' Environment and the Environment in the Visited Tourist Destinations?</i>	Generations		
	X	Y	Z
	<i>Mean ± Standard Deviation (Median)</i>		
<i>To be honest, it is not my concern—I want to relax when I feel like it</i>	0.49 ± 1.44	-0.13 ± 1.33	0.27 ± 1.34
<i>My presence in a tourist location means only benefits for residents</i>	0.16 ± 1.09	0.45 ± 0.86	0.21 ± 1.01
<i>This is an exaggeration—in my opinion, the negative impact of tourists is exaggerated</i>	-0.5 ± 1.11	-0.44 ± 1.04	-0.24 ± 0.96
<i>During the trip, I sometimes use more water for washing and more electricity than at home</i>	-0.85 ± 1.21	-0.47 ± 1.16	-0.47 ± 1.32
<i>I believe that during a tourist trip I am free to do more, I am on holiday after all</i>	-1.14 ± 1.08	-0.88 ± 1.21	-0.36 ± 1.33
<i>I pay for rest, so I can use the local amenities whenever I want and when I want</i>	-0.65 ± 1.18	-0.36 ± 1.25	0.41 ± 1.17
<i>I do not intend to deal with what the residents think about my presence and behavior</i>	-1.14 ± 1.01	-0.96 ± 1.01	-0.58 ± 1.21
<i>I always behave in a civilized way, no matter where I am</i>	1.58 ± 0.73	1.49 ± 0.79	1.45 ± 0.85
<i>During the trip, I use natural resources in the same way as in my home</i>	1.27 ± 0.99	1.06 ± 0.94	1.05 ± 1.02
<i>During the trip, I do not litter the environment, I do not make noise, and I turn off electrical devices when leaving the hotel room</i>	1.58 ± 0.69	1.52 ± 0.74	1.43 ± 0.84

Source: own work.

A comparative analysis in terms of average ratings of individual generations proves many previously observed similarities between generations, but also a lot of differences, determined on the basis of a nonparametric test of the significance of differences between means (Table 3). The most significant differences between individual pairs of generations were observed in the case of X and Z pairs ($p < 0.001$). In many cases, these generations expressed opposite opinions, such as in the case of indifference to their own impact on the tourist area, or regarding the requirements for the destination in which they leave their money. Or they had similar opinions, but with radically different firmness, as in the case of allowing oneself more when on holiday, or indifference to the opinions of residents about their behavior.

Table 3. The results of the nonparametric test of the significance of differences between average ratings for agreement with opinions in individual generations.

<i>Opinion on Own Impact on the Tourist Area and Residents</i>	Level of Significance of Differences between Generations		
	XZ	XY	YZ
<i>To be honest, it is not my concern—I want to relax when I feel like it</i>	0.001	0.088	0.020
<i>My presence in a tourist location means only benefits for residents</i>	0.854	0.093	0.043
<i>This is an exaggeration—in my opinion, the negative impact of tourists is exaggerated</i>	0.034	0.685	0.076
<i>During the trip, I sometimes use more water for washing and more electricity than at home</i>	0.027	0.026	0.767
<i>I believe that during a tourist trip I am free to do more, I am on holiday after all</i>	0.001	0.142	0.002
<i>I pay for rest, so I can use the local amenities whenever I want and when I want</i>	0.001	0.147	0.001
<i>I do not intend to deal with what the residents think about my presence and behavior</i>	0.001	0.209	0.019
<i>I always behave in a civilized way, no matter where I am</i>	0.221	0.371	0.839
<i>During the trip, I use natural resources in the same way as in my home</i>	0.054	0.041	0.805
<i>During the trip, I do not litter the environment, I do not make noise, and I turn off electrical devices when leaving the hotel room</i>	0.218	0.557	0.553

Source: based on own study.

In terms of similarities, the fewest discrepancies can be seen between the X and Y generations—there are just two results indicating significant differences between opinions in these generations. The first relates to higher consumption of water and electricity during a tourist trip than at home ($p = 0.026$), while the second concerns the control question, i.e., the opinion that during a tourist trip they use natural resources in the same way as in their own environment ($p = 0.041$). The generation that disagrees less with the opinion that it consumes more water and electricity, as well as agrees less with using natural resources in the same way, is Generation Y.

The impact of individual generations on the area of tourist destinations and residents is similar, although with a varied impact. Representatives of all generations strongly indicate that their presence has an impact on the economic situation of residents. Other indications are no longer that significant (Table 4).

Table 4. The assessment of respondents' own impact on residents and tourist destinations.

<i>I Think that My Presence in A Tourist Destination May Affect:</i>	Generations		
	X	Y	Z
	<i>Mean ± Standard Deviation (Median)</i>		
<i>Economic situation of residents (living costs, income)</i>	1.37 ± 0.66	1.33 ± 0.79	1.14 ± 0.95
<i>State of relations of residents (family/neighborly/friendly)</i>	0.6 ± 0.74	0.51 ± 0.79	0.41 ± 0.85
<i>Communication possibilities (moving, parking)</i>	−0.18 ± 1.03	−0.22 ± 1.02	−0.22 ± 1.18
<i>Comfort of recreation for residents in their free time</i>	−0.07 ± 1.02	−0.13 ± 1.01	0.01 ± 1.13
<i>Religious practices and access to culture by local people</i>	0.25 ± 0.81	0.19 ± 0.73	0.19 ± 0.88
<i>Satisfaction of residents with professional life</i>	0.92 ± 0.81	0.76 ± 0.77	0.88 ± 0.83
<i>Residents' access to social infrastructure</i>	0.49 ± 0.92	0.44 ± 0.95	0.46 ± 1.06
<i>Sense of security on the streets</i>	0.42 ± 0.82	0.27 ± 0.92	0.25 ± 1.02
<i>Sense of pride of residents for belonging to the city</i>	0.76 ± 0.76	0.79 ± 0.77	0.83 ± 0.90
<i>Condition of the natural environment in the town</i>	0.01 ± 1.06	0.14 ± 1.05	0.09 ± 1.12

Source: own work.

Generation X, in addition to economic impact, notices its own impact on the satisfaction of residents with professional life (0.92 ± 0.81) and residents' sense of pride in belonging to the city (0.76 ± 0.76). They also perceive their own impact on residents' family, neighborly, and friendly relations (0.6 ± 0.74). This group of respondents generally did not show clear or even moderate opposition to the indicated elements of influence. If they disagreed with them, they usually described some factors as indifferent. Such a situation occurred in the case of their impact on the natural environment (0.01 ± 1.06), or the comfort and relaxation of residents on days off (-0.07 ± 1.02).

In the case of people from Generation Y, the strongest impact is similarly observed in the case of economic impact on residents (1.33 ± 0.79). A much lower, but clear impact, is seen in the case of a sense of pride in the resident’s belonging to the tourist destination community (0.76 ± 0.77) and the impact on the satisfaction of residents with professional life (0.79 ± 0.77). Similarly, in the case of Generation X, likewise Generation Y generally does not expressly disagree with the opinions, but is neutral on the same factors as Generation X.

Generation Z also indicated its own economic impact, i.e., impact on living costs and income (1.14 ± 0.95). Similarly to all the analyzed generations, in Generation Z, there is seen to be an impact on the residents’ satisfaction with their professional work (0.88 ± 0.83) and a sense of pride with belonging to a destination (0.83 ± 0.90).

Summing up the results from particular generations, it is worth noting that, in general, respondents pointed to the same elements of their own impact, but with a different firmness. Generations X, Y, and Z are very similar in their indications and intensity of impact. In addition, average extreme values (both the highest and the lowest) are seen in Generation Z.

The analysis of correspondence made in relation to the collected data allowed confirmation of several previously presented conclusions. The first of two visualizations (Figure 1) presents a set of variables covering the diversity of respondents by the generations they represent, their gender, level of education, and tourist experience expressed in the length and frequency of tourist trips.

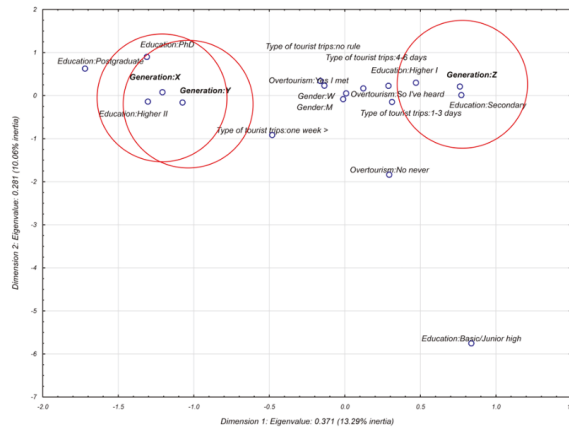

Figure 1. Correspondence analysis results—statement I. Source: own study.

Figure 1 shows a clear separation of the locations of the Z generations from the generations X and Y, which are almost identical in their behavior. People from the older generation more often indicated that they had never heard of the phenomenon of overtourism, although the questionnaire explained the definition of this phenomenon and examples of behavior that could express it. Other generations more often showed the recognition of such a phenomenon (in the media or in person). Experience in overtourism did not depend on the gender of the subjects or the length of trips.

The next set, obtained on the basis of correspondence analysis (Figure 2), again proves discrepancies in the responses given by generations. Generations X, Y, and Z show, in this respect, both greater tourist activities expressed in the length and frequency of tourist trips undertaken, but also knowledge of overtourism. Generation Z recognizes the phenomenon of overtourism in the media more often than generation Y and Z. People from Generation X most often have personal experience in this field.

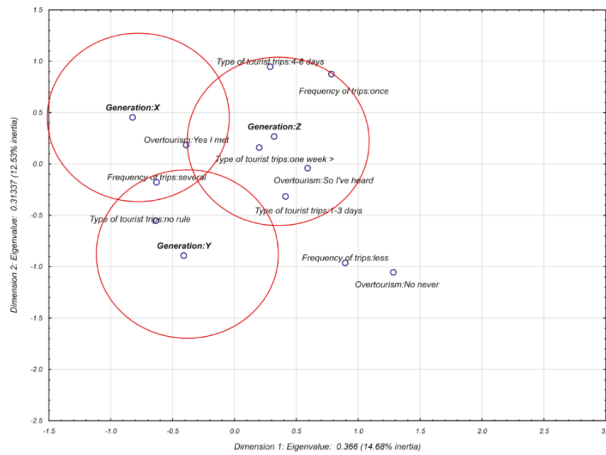

Figure 2. Correspondence analysis results—statement II. Source: own study.

5. Discussion and Conclusions

There are significant implications drawn from this study. The study showed that respondents most often take short trips lasting 1–3 days (27%) and 4–6 days (26.5%), which confirms the data collected by Eurostat, where [58] short trips dominated among the respondents (50.2%). The conducted research indicates that Generation Z is indifferent to the phenomenon of overtourism, based on which it can be concluded that they do not pay attention to the needs of others. This is confirmed by the research of focus groups, on the basis of which it can be stated that the main purpose of the respondents’ travel was their own hedonistic experiences. This may indicate selfish behavior towards the residents of a given destination [59]. However, the authors suggested that with natural environments potentially offering a playground for the hedonistic experience, sustainability needs to be fully embedded in the destination management, with the preservation of natural environments becoming the central factor to attracting potential consumers [59]. The approval of the X and Y generations has not gained the opinion that the tourist has the right to use the destination freely, as they pay for it, and representatives of Generation Z rather agree with this view. Knowledge of these discrepancies in opinions may affect the choice of solutions used in destinations with the aim of solving the problem of overtourism. High demand causes, in many destinations, prices in bars and restaurants to increase, which makes services less available to the local community and some customers. Moreover, bars are closed down, so that hotels and apartments can be built in their place, which means that 18% of residents consider changing their place of residence [60]. Some of the destinations are considering implementing solutions aimed at attracting high-income tourists. However, this could lead to widening social inequalities. Therefore, it is necessary to develop solutions that ensure equal access to destinations for tourists with different incomes. In turn, subsequent generations disagreed with this opinion, but it was twice as firm in Generation X than in the case of generations Y and Z. Natural resources are limited; therefore, according to UNWTO directives [3] or the GSTC criteria [19], tourists’ awareness should be raised and rules for the use of natural resources should be established. This will require a redefinition of tourism, in order to place the rights of local communities above the rights of tourists for holidays and the rights of tourism corporates to make profits [61]. You can use information technology (IT) and social media (SM) solutions, which are being increasingly used by representatives of the young generation [45].

Tourism is a driving force for other sectors of the economy. It is developing very dynamically and brings great financial benefits to various stakeholders. However, apart from the obvious benefits, the tourism industry also has a harmful effect on the natural environment and the local community. As already mentioned, this phenomenon is called overtourism. The negative impact of overtourism can

be considered in three dimensions [24] (pp. 87–88): environmental, economic, and social. These include overpopulation and devastation in places attractive for tourists, destruction of the natural environment, strong seasonal influence, and an increase in the economic dependence of a given city on tourism, as well as the creation of many burdens and inconveniences for the local community. In particular, the young generation of tourists can be a big problem for the local community, because the way they spend their time disturbs peace in tourist destinations and can cause increased crime or problems related to uncivilized behavior. Overtourism is therefore, a significant barrier to ensure sustainable development.

The results of the conducted research indicate that nine out of ten respondents knew the meaning of the word overtourism and have met it. However, indifference to this phenomenon was indicated by the youngest respondents (Generation Z). Respondents of Generation X and Generation Y showed the least indifference to the problem of overtourism. The respondents also agreed on individual elements of their own impact on the environment and residents, but with different firmness.

Obtaining research results enabled the preparation of managerial and theoretical implications. Recommendations have been prepared for solving the problem of overtourism in economic, environmental and social aspects.

Residents of tourist areas gain economic benefits from tourism; however, the excess of tourist traffic causes conflicts in the social background, therefore, it is necessary to examine the expectations of residents to be able to see psychological, social, economic, or environmental problems. Doxey's [26] or Butler's [27] research on this subject is a good example of this. It is recommended to create a space for discussion, where stakeholders representing different generations would have the opportunity to exchange opinions on sustainable tourism, which would contribute to acquiring new knowledge, increasing their level of awareness in the field of overtourism, and developing various solutions to help solve this problem [19,32]. It is necessary to support this process by local authorities in order to take action to counteract the negative impact of tourism on the local community. It is worth having residents participate in it, which will help create optimal solutions. Moreover, it should also be discussed on forums to help engage Generation Z in discussions, for which social media is important, and appreciate group (crowd-related) problem-solving. This would help to compile strategic documents that would indicate goals and propose solutions in the field of solving the problem of overtourism.

Local authorities should monitor tourist traffic and collect data, including qualitative data, in terms of customer expectations and types of activity, which would allow the creation of road maps for sustainable tourism development. This could include, among other matters, encouraging the extension of stays; expanding the possibilities of spending time; and creating new attractions located in less populated areas, which could be less burdensome for residents. It is worth implementing initiatives that would support local businesses run by residents.

In order to counteract the negative impact of overtourism on the environment, it is proposed to implement smart technologies that would monitor the level of traffic in the city and prevent overcrowding in places attractive to tourists. It is also worth using SM to provide information encouraging tourists to respect local culture and the environment, as well as informing them of the negative effects of not respecting these principles. In order to minimize the negative impact of overtourism on the environment, acceptable levels of tourists' impact on tourist attractions can be defined through a participatory process involving all interested parties. This will make it easier for local communities to reap the benefits, create shared experiences of the city for visitors and residents, and help communicate with residents.

The presented article has its limitations, which is the limited territorial scope of research, as well as the limited number of respondents representing the BB generation. Therefore this generation was excluded from statistical analyses. The small sample of the BB population is most likely due to the way the questionnaire is delivered. The BB generation uses less modern technology, social networking sites, and forums. In order to examine this group of people, it should be considered to use face-to-face interviews based on a questionnaire in different tourist destinations.

In further research, the authors will examine the generational awareness of overtourism in other countries and make international comparisons. The authors plan to conduct further studies in cooperation with tourist resorts. This will enable to use the recommendations contained in the article. In particular, to increase the awareness level of generation Z, decision-makers should consider using IT technologies and social media, which are natural communication tools for this generation. Another intention of the authors is also to obtain the opinion of the BB generation, therefore the way of distributing the questionnaire will be changed from online to offline.

Author Contributions: A.R.S. prepared the following elements of the article: the methodology, conduct of research, analysis of data, developed research results. B.H. created the review of literature, developed the final contents of the article and proofread. A.K. co-created the review of literature, conclusions and conducted the research.

Funding: This research received funding from the National Science Center in Poland.

Acknowledgments: This paper was published as part of the research project ‘A business model for health resort enterprises’ No. 2017/25/B/HS4/00301, supervised and financed by the National Science Center in Poland and as part of statutory research No. 13/990/BK_19/0138 at the Silesian University of Technology, Faculty of Organization and Management.

Conflicts of Interest: The authors declare no conflicts of interest. The funders had no role in the design of the study; in the collection, analyses, or interpretation of data; in the writing of the manuscript; or in the decision to publish the results.

References

1. World Tourism Organization, International Tourism Highlights 2019 Edition. UNWTO, Madrid. Available online: <https://www.e-unwto.org/doi/book/10.18111/9789284421152> (accessed on 20 October 2019).
2. Turystyka w UE, GUS. Available online: <https://stat.gov.pl/obszary-tematyczne/kultura-turystyka-sport/turystyka/turystyka-w-unii-europejskiej-dane-za-2017-rok,11,4.html> (accessed on 20 October 2019).
3. World Tourism Organization and United Nations Development Programme Tourism and the Sustainable Development Goals—Journey to 2030, Highlights, UNWTO, 2017, Madrid. Available online: <https://www.e-unwto.org/doi/pdf/10.18111/9789284419401> (accessed on 20 October 2019).
4. Dickinson, G. A timeline of overtourism: Key moments in global battle between locals and travelers, The Telegraph, 21 August 2019. Available online: <https://www.telegraph.co.uk/travel/news/timeline-action-against-overtourism/> (accessed on 10 October 2019).
5. Portal Samorządowy. Available online: <https://www.portalsamorzadowy.pl/wydarzenia-lokalne/miasta-nie-potrzebuja-turystow-szaranczy,133542.html> (accessed on 20 October 2019).
6. Oklevik, O.; Gössling, S.; Hall, C.M.; Kristian, J. Overtourism, optimisation, and destination performance indicators: A case study of activities in Fjord Norway. *J. Sustain. Tour.* **2019**. [CrossRef]
7. Panayiotopoulos, A.; Pisano, C. Overtourism Dystopias and Socialist Utopias: Towards an Urban Armature for Dubrovnik. *Tour. Plan. Dev.* **2019**, *16*, 393–410. [CrossRef]
8. Pechlaner, H.; Innerhofer, E.; Erschbamer, G. (Eds.) *Overtourism: Tourism Management and Solutions*; Series: Contemporary Geographies of Leisure, Tourism and Mobility; Routledge: Abingdon, UK, 2019.
9. ‘Overtourism’?—Understanding and Managing Urban Tourism Growth beyond Perceptions | World Tourism Organization. Available online: www.e-unwto.org (accessed on 25 October 2019).
10. Google Website. 2019. Available online: <https://trends.google.pl/trends/explore?q=Overtourism> (accessed on 30 October 2019).
11. Dolot, A. *The Characteristics of Generation, Z*; E-mentor, Warsaw School of Economics: Warszawa, Poland, 2018.
12. Grenčíková, A.; Vojtovič, S. Relationship of generations X, Y, Z with new communication technology. *Probl. Perspect. Manag.* **2017**, *15*, 558–564. [CrossRef]
13. Hysa, A. Zarządzanie różnorodnością pokoleniową. *Zeszyty naukowe Politechniki Śląskiej* **2016**, *97*, 385–398.
14. Erickson, L.; Robinson, J.; Cutsor, J.; Brase, G. Sustainable Development. In *Solar Powered Infrastructure for Electric Vehicles: A Sustainable Development*; Erickson, L., Robinson, J., Brase, G., Cutsor, J., Eds.; Taylor and Francis Group: Abingdon, UK, 2016.
15. Eurostat Statistic. Available online: https://ec.europa.eu/eurostat/statistics-explained/index.php?title=Tourism_industries_-_employment[Source:Eurostat (accessed on 20 October 2019).

16. GUS. 2019. Available online: <https://stat.gov.pl/obszary-tematyczne/kultura-turystyka-sport/turystyka/baza-noclegowa-wedlug-stanu-w-dniu-31-lipca-2019-r-i-jej-wykorzystanie-w-pierwszym-polroczu-2019-roku,4,16.html> (accessed on 20 October 2019).
17. Kuznetsov Viktor, S. An integrated approach to tourism development in protected natural areas. *Arct. North*. **2016**. [CrossRef]
18. Luo, J.M.; Lam, C.F.; Haobin Ye, B. Barriers for the Sustainable Development of Entertainment Tourism in Macau. *Sustainability* **2019**, *11*, 2145. [CrossRef]
19. Global Sustainable Tourism Council. GSTC Criteria for hotels. GSTC Criteria for tour operators. GSTC Criteria for destinations. Available online: <http://www.gstccouncil.org/gstc-criteria/> (accessed on 14 August 2019).
20. Perkumiene, D.; Pranskuniene, R. Overtourism: Between the Right to Travel and Residents' Rights. *Sustainability* **2019**, *11*, 2138. [CrossRef]
21. Hatipoglu, B.; Alvarez, M.D.; Ertuna, B. Barriers to stakeholder involvement in the planning of sustainable tourism: The case of the Thrace region in Turkey. *J. Clean. Prod.* **2016**, *111*, 306–317. [CrossRef]
22. Wu, L. How Cities Around The World Are Fighting Overtourism. 2019. Available online: <https://www.forbes.com/sites/lesliewu/2019/05/26/how-cities-around-the-world-are-fighting-overtourism/#20f554db212a> (accessed on 20 October 2019).
23. McKinsey & Company, & World Travel & Tourism Council. Coping with success: Managing overcrowding in tourism destination. 2017. Available online: <https://www.wttc.org/-/media/files/reports/policy-research/coping-with-success---managing-overcrowding-in-tourism-destinations-2017.pdf> (accessed on 20 October 2019).
24. Peeters, P.; Gössling, S.; Klijs, J.; Milano, C.; Novelli, M.; Dijkmans, C.H.S.; Eijgelaar, E.; Hartman, S. *Research for TRAN Committee—Overtourism: Impact and Possible Policy Responses*; Policy Department for Structural and Cohesion Policies Directorate-General for Internal Policies: Brussels, Belgium, 2018.
25. Kruczek, Z. Ways to Counteract the Negative Effects of Overtourism at Tourist Attractions and Destinations. In *Annales—Universitatis Mariae Curie-Skłodowska, Sectio B, VOL. LXXIV*; University School of Physical Education: Kraków, Poland, 2019; pp. 45–57.
26. Doxey, G.V. A causation theory of visitor/resident irritants: Methodology and research inferences. In Proceedings of the Travel Research Association 6th Annual Conference, San Diego, CA, USA, 8–11 September 1975; pp. 195–198.
27. Butler, R.W. The concept of tourism area cycle of evolution: Implications for management of resources. *Can. Geogr.* **1980**, *24*, 5–12. [CrossRef]
28. Dodds, R.; Butler, R.W. Overtourism. Issues, Realities and Solutions. In *De Gruyter Studies in Tourism 1*; Walter de Gruyter: Berlin, Germany, 2019; pp. 1–22.
29. Kruczek, Z. "Overtourism"—around the definition, Encyclopedia, 2019, v1. Available online: <https://encyclopedia.pub/163> (accessed on 20 October 2019).
30. Coping with success managing overcrowding in tourism destinations, 2017, McKinsey & Company & World Travel & Tourism Council. Available online: <https://www.wttc.org/-/media/files/reports/policy-research/coping-with-success---managing-overcrowding-in-tourism-destinations-2017.pdf> (accessed on 20 October 2019).
31. Xiang, Z.; Magnini, V.P.; Fesenmaier, D.R. Information Technology and Consumer Behaviour in Travel and Tourism: Insights from Travel Planning Using the Internet. *J. Retail. Consum. Serv.* **2015**, *22*, 244–249. [CrossRef]
32. Expedia Group Media Solutions survey, "Multi-generational travel trends. Travel habits and behaviours of Generation Z, Millennials, Generation X, and Baby Boomers". Available online: <https://info.advertising.expedia.com/british-travel-and-tourism-trends-research> (accessed on 10 October 2019).
33. Globetrender Website. Available online: <https://globetrender.com/2019/05/11/overtourism-crisis/> (accessed on 10 October 2019).
34. Zmysłony, P.; Kowalczyk-Anioł, J. Urban tourism hypertrophy: who should deal with it? The case of Krakow (Poland). *Int. J. Tour. Cities* **2019**. [CrossRef]
35. González, A.T. Venice: the problem of overtourism and the impact of cruises. *Investig. Reg.—J. Reg. Res.* **2018**, *42*, 35–51.
36. Benner, M. From overtourism to sustainability: A research agenda for qualitative tourism development in the Adriatic. *German J. Econ. Geogr.* **2019**, *92213*, 1–18.
37. Butler, R.W.; Szromek, A.R. Incorporating the Value Proposition for Society with Business Models of Health Tourism Enterprises. *Sustainability* **2019**, *11*, 6711. [CrossRef]

38. World Tourism Organization. *Making Tourism More Sustainable—A Guide for Policy Makers*; UNEP and UNWTO: Madrid, Spain, 2005; pp. 11–12. Available online: <http://www.unep.fr/shared/publications/pdf/DTIx0592xPA-TourismPolicyEN.pdf> (accessed on 10 October 2019).
39. Milano, C.; Novelli, M.; Joseph, M. Overtourism and Tourismphobia: A Journey through Four Decades of Tourism Development, Planning and Local Concerns. *Tour. Plan. Dev.* **2019**, *14*, 353–357. [CrossRef]
40. Smola, K.W.; Sutton, C.D. Generational differences: Revisiting generational work values for the new millennium. *J. Organ. Behav.* **2002**, *23*, 363–382. [CrossRef]
41. Smolbik-Jęczmień, A. Rozwój kariery zawodowej przedstawicieli pokolenia X i Y w warunkach gospodarki opartej na wiedzy. *Nierówności Społeczne a Wzrost Gospodarczy* **2013**, *36*, 228–238.
42. Mazur-Wierzbicka, E. *Kompetencje pokolenia Y—wybrane aspekty*, *Studia i prace Wydziału Nauk Ekonomicznych i Zarządzania Nr 39, t. 3*; Wydawnictwo Naukowe Uniwersytetu Szczecińskiego: Szczecin, Poland, 2015; pp. 307–320.
43. McCrindle, M. *The ABC of XYZ: Understanding the Global Generations Kindle Edition*; McCrindle Research Pty Ltd.: Sydney NSW, Australia, 2014.
44. Lyons, S.T.; Schweitzer, L.; Ng Eddy, S.W. How have careers changed? An investigation of changing career patterns across four generations. *J. Manag. Psychol.* **2015**, *30*, 8–22. [CrossRef]
45. Ruth, N.; Bolton, A.; Parasuraman, A.; Hoefnagels, A.; Migchels, N.; Kabadayi, S.; Gruber, T.; Loureiro, Y.K.; Solnet, D. Understanding Generation Y and Their Use of Social Media: A Review and Research Agenda. *J. Serv. Manag.* **2013**, *24*, 245–267.
46. Naidoo, P.; Ramseook-Munhurrub, P.; Seebaluck, N.V.; Janvierd Procedia, S. Investigating the Motivation of Baby Boomers for Adventure Tourism. *Soc. Behav. Sci.* **2015**, *175*, 244–251. [CrossRef]
47. Zabel, K.L.; Benjamin, B.J.; Biermeier-Hanson, B.B.J.; Baltes Early, B.J.; Shepard, A. Generational Differences in Work Ethic: Fact or Fiction? *J. Bus. Psychol. Sci. Bus. Media* **2016**. [CrossRef]
48. Kupperschmidt, B.R. Multigeneration employees: Strategies for effective management. *Health Care Manag.* **2000**, *19*, 65–76. [CrossRef]
49. Vukic, M.; Kuzmanovic, M.; Kostnic Stankovic, M. Understanding the Heterogeneity of Generation Y's Preferences for Travelling: A Conjoint Analysis Approach. *Int. J. Tour. Res.* **2015**, *17*, 482–491. [CrossRef]
50. Dębski, M.; Krawczyk, A.; Dworak, D. Wzory zachowań turystycznych przedstawicieli Pokolenia Y. In *Studia i Prace Kolegium Zarządzania Finansów, Zeszyt Naukowy 172*; Uniwersytet Warszawski: Warsaw, Poland, 2019; pp. 9–27.
51. Santos, M.C.; Veiga, C.; Aguas, P. Tourism Services: Facing the Challenge of new Tourist Profiles. *Worldw. Hosp. Tour. Themes* **2016**, *8*, 654–669. [CrossRef]
52. Leask, A.; Fyall, A.; Byron, P. Generation Y: An Agenda for Future Visitor Attraction Research. *Int. J. Tour. Res.* **2014**, *16*, 462–471. [CrossRef]
53. Sun, S.; Nang Fong, L.H.; Law, R.; Luk, C. An Investigation of Gen-Y's Online Hotel Information Search: The Case of Hong Kong. *Asia Pac. J. Tour. Res.* **2016**, *21*, 443–456. [CrossRef]
54. Huang, Y.-C.; Petrick James, F. Generation Y's Travel Behaviours: a comparison with Baby Boomers and Generation X. In *Tourism and Generation Y*; Beckendorff, P., Moscardo, G., Pendergast, D., Eds.; CABI: Wallingford, UK, 2010; pp. 27–37.
55. Greenacre, M.; Hastie, T. The Geometric Interpretation of Correspondence Analysis. *J. Am. Stat. Assoc.* **1987**, *82*, 437–447. [CrossRef]
56. Stanisław, A. (Ed.) *Biostatystyka*; Wyd. Uniwersytetu Jagiellońskiego: Kraków, Poland, 2005; pp. 109–409.
57. Kendall, M.G. *Multivariate Analysis*; Charles Griffin: London, UK, 1975; pp. 3–198.
58. Eurostat. 2019. Available online: https://ec.europa.eu/eurostat/statistics-explained/index.php/Tourism_statistics#Tourism_expenditure:_highest_spending_by_German_residents (accessed on 15 October 2019).
59. Hanna, P.; Font, X.; Scarles, C.; Weeden, C. Harrison Ch: Tourist destination marketing: From sustainability myopia to memorable experiences. *J. Destin. Mark. Manag.* **2018**, *9*, 36–43. [CrossRef]

60. Smith, M.K.; Sziva, I.P.; Olt, G. Overtourism and Resident Resistance in Budapest. *Tour. Plan. Dev.* **2019**, *16*, 376–392. [[CrossRef](#)]
61. Higgins-Desbiolles, F.; Carnicelli, S.; Krolikowski, C.; Wijesinghe, G.; Boluk, K. Degrowing tourism: rethinking tourism. *J. Sustain.* **2019**. [[CrossRef](#)]



© 2019 by the authors. Licensee MDPI, Basel, Switzerland. This article is an open access article distributed under the terms and conditions of the Creative Commons Attribution (CC BY) license (<http://creativecommons.org/licenses/by/4.0/>).

Article

Visual Component of Destination Brands as a Tool for Communicating Sustainable Tourism Offers

Anna Adamus-Matuszyńska ¹, Piotr Dzik ², Jerzy Michnik ^{3,*} and Grzegorz Polok ¹

¹ Department of Market and Marketing Research, University of Economics in Katowice, 40-287 Katowice, Poland; anna.adamus-matuszynska@ue.katowice.pl (A.A.-M.); grzegorz.polok@ue.katowice.pl (G.P.)

² Faculty of Design, Academy of Fine Arts in Katowice, 40-074 Katowice, Poland; piotr.dzik@asp.katowice.pl

³ Department of Operations Research, University of Economics in Katowice, 40-287 Katowice, Poland

* Correspondence: jerzy.michnik@ue.katowice.pl

Abstract: The starting point of the presented research is the theory of destination marketing, in which the concept of destination branding is the key element. Destination branding models include the idea of visual brand identity, which includes the logo as a crucial element. Since the 1980s, the concept of sustainable development has shaped the society and global economy, including tourism. Tourists are increasingly guided by the analysis of the tourist area in terms of the importance of nature and the possibility of spending free time responsibly. They look for a sustainable tourist offer. Therefore, the aim of this work is to evaluate the tourist offers of Polish territorial units in terms of visual message—logo and its content, and to examine whether they comprise design components that reveal the sustainable development of the destination. The research method was content analysis of promotional signs. Sustainable development in tourism focuses on three pillars: nature, responsible tourist activity, and the historical remains protected in a sustainable way. The authors search for such images in the logos. In the conclusion, the authors summarize that elements of nature and historical heritage are strongly present in the logos, which does not mean that the tourist offer is a balanced offer.

Citation: Adamus-Matuszyńska, A.; Dzik, P.; Michnik, J.; Polok, G. Visual Component of Destination Brands as a Tool for Communicating Sustainable Tourism Offers. *Sustainability* **2021**, *13*, 731. <https://doi.org/10.3390/su13020731>

Received: 14 November 2020

Accepted: 9 January 2021

Published: 13 January 2021

Publisher's Note: MDPI stays neutral with regard to jurisdictional claims in published maps and institutional affiliations.



Copyright: © 2021 by the authors. Licensee MDPI, Basel, Switzerland. This article is an open access article distributed under the terms and conditions of the Creative Commons Attribution (CC BY) license (<https://creativecommons.org/licenses/by/4.0/>).

Keywords: destination branding; sustainable tourism; visual identity

1. Introduction

The visual components of the destinations' brands—signatures of towns and counties (in Polish language—poviats)—were the subjects of the presented research. The authors examined obtainable logos and slogans (obtainable here means practiced in destination branding at the time of the query (from January to the end of June 2020)). The study tries to answer the following research questions:

1. What does the destination's signature communicate the potential tourists?
2. How many of these narratives communicate the sustainable development of tourist destinations?
3. How is sustainable tourism communicated in promotional signatures?

The novelty of the presented research consists of three related elements. First, the use of a visual analysis method by analyzing the presence of design components which are closely connected with sustainability. In social research, visual methods raise methodological questions [1,2], and although they are used in tourism analysis [3], they still raise doubts in academia. The authors indicate, however, that the subject of research (logo) itself provokes the use of visual analysis, and the method would have to be appropriate—at the same time—for quantitative and qualitative analyses. Secondly, the study also enriches research on destination branding by conducting analyses of Poland as a case study and thirdly applying an interdisciplinary approach—both elements are rare in the literature [4]. The authors endeavored to investigate the relationship between destination branding and

sustainability in the visual presentation of the Polish logos. Such an effort has been successfully undertaken in other researches [5], which indicates the theoretical and practical usefulness of such interdisciplinary approaches.

Three main concepts were the starting points for the study: (1) destination branding as a theory of tourist promotion of a place, (2) semiotics and visual semiotics [6] as the methodology of research and (3) sustainable tourism as an industry which ensures the development of local community and natural environment and promotes human welfare and public participation in decision-making [7]. The research mostly focuses on the analysis of visual components of the destination brands. The signature is a visual element of the brand consisting of a logo, slogan and other additional elements such as fonts. It is the structured relationship between a logotype, landmark, and tagline [8] that in graphic design theory is understood as precisely defined relationships among these elements in terms of proportion, placement, distance, colour, typeface, background control, and non-distortion (misused). As Healey stresses, the conventional solution of symbol plus wordmark is the most common form for a logo, which is expected to have form and colours [9]. The other researchers have stressed that a logo also contains additional elements such as shape [10–12] (The authors decided not to take into account the shape (form) of the analyzed logos. There are studies showing that the shape of the logo affects the effectiveness of its impact [10,11]; such attempts were also made in Poland [12]. There was also an attempt at such an analysis with regard to sustainability [13]. However, there are methodological concerns to these studies: they took place in controlled, laboratory conditions, and not in a natural environment, they manipulated the shape and form of the logo (e.g., names were removed, fonts were changed), fictitious logos were used, and the study groups were deliberately selected, not random.)

The aim of this work is to get knowledge about the content of promotional visual signs (signatures) which try to promote the sustainable development of a destination and at the same time, sustainable tourism. To reach such a goal, in the process of examination, the symbols of sustainability in the destination's signatures were searched for by analysing them, using content analysis as the research method. The authors try to fill the gap in research on destination branding by exploring the issue of what a signature communicates to the audience, considering only one of the contemporary perspectives, such as sustainability.

Knowledge obtained from the study has two aspects: (1) theoretical—the research is aimed to improve the destination branding theory with the communication functions of the visual content of signatures and (2) practical, by indicating the applied guidance resulting from this concept.

Content analysis as a qualitative research method was chosen because it allows for the analysis of logos and slogans contained in the promotional signs. Secondly, considering the theory of destination branding, one may assume that a creator of the territorial signatures wants to disclose some properties important for a place, and he/she chooses such elements which may symbolize the most crucial and typical features of the destination and its community. The results of the research may put a new perspective on understanding the signature's significance in destination branding. The content analysis method of the research is valued in such an examination because it helps to recognise what the senders (in the case of destination signatures they are local government units—LGU) want to communicate to the receivers—tourists and residents [14].

During the research process, the authors met a practical problem. It was difficult to separate the creator of the signature (an author of the logo and slogan) from the sender (a transmitter of the message contained in the signature). The term 'creator' is understood as the graphic designer who carries out a task delegated by the competent administrative authority. The sender is the LGU commissioning a logo for marketing purposes. Therefore, there are consequences that affect the content of the logo. The authors in the previous research [15] concluded that there are three ways to build the visual system of a place in Poland:

- (1) Signs are created in offices, i.e., they are made by officials.
- (2) The client (in that case the LGU) specifies the requirements for the content of the logo in details, what limits the creativity of the graphic designer.
- (3) The signs are subject to stakeholders' consultation processes (e.g., citizens) that influence the content of the signatures.

Such a variety of signature creation methods has consequences in their content. Some of them express what governors of the territory wish to disclose, some present features which are expected by the governors of the place, however they do not necessarily reflect the specificity (*genius loci* of the place) of a given destination, and some are created in a long, complex, and relational process [15,16] which has an impact on identity or description of the promoted place.

The literature dealing with the functions of visual identification in tourism promotion is limited [17–19], and based mainly on case studies [3].

The present study enriches the existing literature by the semiotic analysis of signatures, with a special interest in symbols of sustainability, marked by the visual identification of places which are aimed to promote tourism in a particular destination. The main objective of the research is therefore to describe the content of the signatures and indicate to what extent this content communicates the sustainable development of a tourist destination. Choosing from the rich literature about the symbols of sustainability, the authors are aware of the limitation of participants' observations. Considering such a subjective point of view, the researchers wanted to understand the logo phenomena genuinely and in such a way that has an impact on recognizing visual phenomena significance in destination branding.

When examining visual signs, the authors treat them as objects inseparably linked with the entities commissioning the logo creation (officials), and the direct authors, i.e., graphic designers. The research follows a humanistic mode of inquiry developed specifically to address socially constructed phenomena [20] that assumes that the logo (a subject) is strongly associated with the entity that created it (the author). Taking into account the above assumptions, one may conclude that signatures communicate official images of the places, but not the characteristics of the community and the destination itself, which they are supposed to represent. Considering the concept of reception, it is presumed in the presented research that the participants in a social action are the judges of rationality (in the case of logo design they are local governments who are senders) whose judgement is local and necessarily relative. The audience (i.e., prospective tourists in that case) seeks a more universal rational explanation of the signatures' content and meaning [21] (p. 172).

The structure of the article is as follows:

- Theoretical framework
- Materials and methods
- Results
- Conclusions, including theoretical implications, managerial implications, limitations and future research.

2. Theoretical Framework

2.1. From Destination Marketing to Destination's Logo

Destination marketing is a relatively new subject in the professional tourism literature (Pike suggests the following definition of destination marketing: ... *the process of matching destination resources with environment opportunities, with the wider interests of society in mind* [22] (p. 27). For definitions see also [23].) The first research papers appeared in the 70s, but considerable development occurred at the beginning of the 21st century [24]. The concept of destination branding is even newer—the scientific studies began after 2000 [4,25,26]. The first scientific conference on this topic was held in 2005 [22]. However, since then, destination branding has become a legitimate theoretical concept in scientific tourism research. Studies in this field indicate the multidisciplinary nature of the 'destinations' phenomenon [27]. It should be added that destination marketing adopts many concepts from so-called 'universal marketing'. One of them is the idea of brand identity [28,29], and

brand identity development, which is understood as the vision of how the destination should be perceived in the marketplace [18,30]. Many previous studies suggested that the abovementioned idea—brand identity—is the key ingredient of a brand [8,31], and—as a consequence—destination brand identity in tourism [30,32–36]. As Zavattaro clearly states: *Identity is what brand managers shape and put out to stakeholders via communications tools, landscape design, and other elements of place making* [37] (p. 29). All above cited studies indicate that the tangible component of the brand's identity is its visual identity, as Alina Wheeler states: *Brand identity fuels recognition, amplifies differentiation, and makes big ideas and meaning accessible* [8] (p. 4). Many studies highlight that brand identity is a prerequisite for successful marketing communication in business as well as in the public sector [38,39]. This also applies to destination brands [40]. An indispensable condition for reliable marketing communication is a coherent identification of the sender—in the case of destination, it is a city, town, community, region, etc., which is why the visual signs (signatures) have a crucial impact. The place brand communicates the particular attributes of that place, and thus it gives the destination its specific meaning [41].

The authors consider a destination the basic analytical unit [22], and try to analyse the logos of destinations considering destination marketing and branding as legitimate research fields. Destination is a geographical space in which a cluster of tourism resources exists, and the tourists actively take advantage of them [18]. In order for this destination to become a tourist attraction, it is necessary to match these resources with the interests of tourists, which is carried out by marketing [18]. However, in view of the multitude of marketing activities, including destination marketing, both in theory and in practice, the need to build a destination brand is emphasized as a unique combination of product characteristics and added values [m]. The comprehensive definition of the destination brand, from both the buyer and seller perspective, is proposed by Blain, Levy, Ritchie [42] (p. 337). This definition incorporates the visual identity of the destination brand:

Destination branding is the set of marketing activities that (1) support the creation of a name, symbol, logo, word mark or other graphics that readily identifies and differentiates a destination; that (2) consistently convey the expectation of a memorable travel experience that is uniquely associated with the destination; that (3) serve to consolidate and reinforce the emotional connection between the visitor and the destination; and that (4) reduce consumer search costs and perceived risk. Collectively, these activities serve to create a destination image that positively influences consumer destination choice.

It must be stressed that destination branding is more complex than product or corporate branding, which is why it is so difficult to define a brand message [43]. The process of brand building depends on the destination marketing phases which run in parallel with the brand building process. The content of the destination brand depends on the identity of the place (genius loci) and any kind of symbols important to local stakeholders who are more or less actively involved in the destination branding process. Taking into account the literature on the subject matter and the cited definitions, the authors propose their own analytical model, which is concentrated on the sender's perspective (Figure 1).

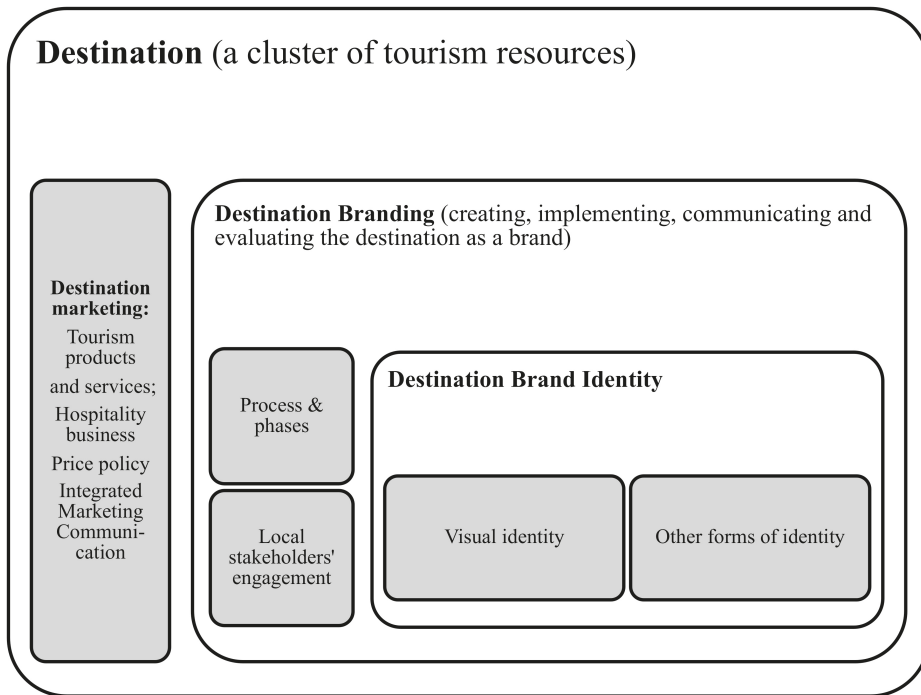

Figure 1. Conceptual model of destination as a marketing invention.

Previous researches of the authors [15,44] illustrate that identity is a key component determining destination marketing and branding. However, examination of the visual identification of places is relatively rare, grounded primarily in single case studies, and the conclusions are not coherent enough [45–48]. Assuming that identity affects the image and attitudes of tourists towards the destination [22], it seems important to examine the content of identity and—especially—visual identity as significant components of destination brand identity. Following the analysis of Echtner [49], visual signs practiced in the tourism industry not only denote, but also connote the place identity. The author states [49] (p. 49):

That which is a sign (namely, the associative total of a concept and an image) in the first system [i.e., denotative], becomes a mere signifier in the second. Part of the semiological enterprise becomes moving beyond the denotated sign system to the mythical level. Such a layered view of semiotics has particular relevance to the analysis of tourism's signification systems, with their emphasis on denotation, myth and fantasy.

To sum up, the research approach can be operationalized as an attempt to gain a profounder understanding the connotative meanings hidden under the denotative surface. Visual identity of destination denotes what creators want to reveal and at the same time it connotes, in the light of culturally accepted codes, a particular meaning of the iconic sign which is expected by the authors as a visual form of identity [50] (p. 248). As Eco stresses, the iconic sign refers not to the subject itself, but to its perceptual schema [50] (p. 136). A signature is an iconographic code which connotes the cultural symbols of the destination. Therefore, in such a way, a logo or/and slogan might become an iconic sign that can be reproduced, quoted, or transmitted to the recipients (tourists and residents).

Many logos of Polish destinations refer to the substance (Ger. Substanz), and display what the city/community has to offer to the tourists [51]. It should be added that from the studies on the Polish cases [15,52] two additional conclusions follow: (1) the logos of

local government units are also destinations' logos (creation of separate tourist brands occurs rarely) and (2) these logos are closer to illustrations for clarification than symbols of reality. Logos are stories, illustrations, and narratives, which make them easier to interpret. Studying the logo as a narrative enables extensive content analysis. The logo is a story [51], and thus it is a bearer of history, legends, tales about a place and its inhabitants (community).

2.2. From Sustainability to Sustainable Tourism

There is a systematically growing concern regarding sustainability and sustainable development both in research and business practice. The term sustainable tourism occurred when it was recognised that tourism should be developed in a sustainable manner [53]. Since tourism has a crucial impact on economy, society, and culture, this industry can be a vital factor of sustainability [54].

Tourism can be analysed as an economic activity as well as an element of sustainable development of the particular territory [55]. Sustainable development as an idea emerged in the early 90s when "Journal of Sustainable Tourism" appeared [56].

There are many definitions of sustainable tourism which vary depending on the methodological approach adopted. The concept of sustainable tourism can be interpreted as a process of tourism development [57] and/or an outcome of tourism development [58]. In the classic textbook "Global Tourism", sustainable tourism is a component of sustainable development, which consists of seven main dimensions: resource management, economic activity, social obligation, aesthetic appeal, ecological parameters, biological diversity, and basic life support system [59] (p. 178–179). The World Tourism Organization defines sustainable tourism as *tourism which leads to the management of all resources in such a way that economic, social, and aesthetic needs can be filled while maintaining cultural integrity, essential ecological processes, biological diversity and life support systems* [60]. As Faulkner [61] stresses, sustainable tourism development is a form of tourism which protects and improves the natural and cultural assets of the destination, the resident population quality of life, satisfies the tourists market, achieves a return on tourist operators, and achieves equity in the distribution of costs and benefits of tourism between current and future generations.

Considering the above approaches to sustainable tourism, it is noticeable that governance is the key element for implementing sustainable tourism [62]. Major changes in the governance of a place started at the beginning of globalisation and in many countries, especially after the transition from centralised to democratic countries, when marketing tools started to be introduced by self-government units to promote regions and towns as tourist attractions [63]. Place branding is implemented today as a governance strategy of local government units for creating better environmental, social, and economic conditions [41]. As stated in the literature, the Destination Marketing Organisations (DMO) play a significant role in the sustainable management of tourism destinations [22]. Here, it should be stressed that there is a difference between place and destination branding. The first kind of branding targets all stakeholders while the second one targets tourists and residents [14].

Despite the significance of sustainability, both inside and outside of the tourism industry, tourism is less sustainable than ever [64]. Undoubtedly public and commercial interest in environmental issues and their implications did lead to an expansion in the scope of marketing to appropriate concerns over the sustainability of resources and consumption [65–70].

The need for a response to tourist demands and local community expectations is clearly significant for tourism as it faces increased challenges with respect to sustainability and its contribution to society and destination economies [71]. There are many indicators which may measure the sustainability of the destination [72]. Examples include [73]:

- resource use
- waste pollution
- local production

- access to basic human needs
- access to facilities
- freedom from violence and oppression
- access to the decision-making process
- diversity of natural and cultural life.

Generally, there are three main dimensions of sustainability: environmental, economic and sociocultural [74,75]. However, there are many indicators that reveal the degree of sustainable tourism [76]. Taking into account the recommendations of sustainable development indicated by the United Nations [77], four main dimensions of sustainability should be indicated: economic, environmental, cultural, and locality (the sociocultural dimension has been divided into two: cultural and locality).

For the purposes of the research, the authors followed the sustainable tourism issues created by Tanguay et al. [76] who also pointed out the indicators suitable to each of the issues. The issues were divided into four categories and to each of them the visual symbols were examined in destinations' logos.

3. Materials and Methods

An image, which could be photography, pictures, or graphics, is a part of contemporary social life. Therefore, contemporary social sciences increasingly study images to examine them as evidence of social illusions or hope [78]. This means that brands, including destination brands, are part of the cultural landscape, and the above-mentioned definitions of destination brand indicate that an important component of the brand is its visual identity [79].

The authors were aware of the imperfect option to make a shift from the case studies analysis to quantitative research. Therefore, all Polish town and county's logos that were used in the public space at the time of scrutiny, have been reviewed. It turned out that of the 380 Polish towns and counties, 183 of them used signatures in marketing practice. All were analysed through the use of the content analysis research method.

Content analysis is a valid research method in place branding [80,81]. Govers, Go, and Kumar suggest that in destination research "The 3-Gap Destination Image Formation Model" is applicable. As they suggest, there is a strategic gap between the projected tourism destination image and the perceived tourism experience. However, to investigate and assess such a gap, one needs to analyse the situation from both sides, i.e., supply and demand [82]. In the presented research the authors examine the tourist destination promoters.

In the case of the graphic symbol analysis practiced in promotion, the research process consists of four stages [83] (pp. 56–66):

1. finding images—destination logos were found on official webpages, social media, and in other promotional authorised publications;
2. formulating categories for coding—coding means attaching a set of descriptive labels (or categories) to the images [83] (p.58);
3. coding the images—applying distinguished categories to destination logos;
4. analysing the results—formulating conclusions and discussion of the questions.

Visual content analysis is associated with many theoretical and practical complications, especially with reliability, replicability, accuracy and methods of sample selection for research. Referring to these issues, the authors followed the process of reliability assessment prepared by Neuendorf [84]: development of the coding scheme, practice coding, pilot reliability (it was done during previous researches of the authors), actual coding data and testing a sub-sample of units. The issue of repeatability and accuracy is related to the selection of the sample, which is why the authors decided to work with the full population of poviats and cities with poviat status in Poland. Such research may be repeated; the only difficulty may be changes of an administrative nature (e.g., establishment or liquidation of a poviat as an administration unit). The authors tried to accurately describe

the research procedure, creating categories for coding and the coding process. It seems that the descriptions and examples contained in the article allow for the reconstruction of the research. The authors are aware of the limitations of the used research method, because it is not appropriate for research focused on the reception process [69]. However, as shown by other studies, the actions undertaken by authorities in charge of tourism have a fundamental impact on the creation of the identity and image of the destination brand [85].

4. Results

Taking into account the characteristics of sustainable tourism, the following symbols have been considered for analysis: graphical (logo), verbal (slogan), or a unification of both logo and slogan called a 'slogo' [86].

In the first stage—finding images—the authors decided to analyse the signatures of Polish towns and counties. That is why all such units were scrutinized: 66 towns and 314 counties (The administrative division of Poland is three-tier and includes: 16 voivodships (regions), 380 poviats (including 314 country [rural] poviats and 66 city-poviats) and 2477 communes). Searching on the internet, looking for documents, doing interviews with officials, and travelling across Poland, 190 signatures were collected (see Table 1). All of them were examined to verify the symbols communicating the destination as a place of sustainable development. Using a qualitative thematic coding methodology, a categorical framework for studying logos classification was created.

Table 1. Number of local government units (LGU) analysed.

	Analysed Units	Total	Number of LGUs Practiced Signatures in Promotion	Number of LGUs Practiced Signatures Symbolized Sustainability of the Destination
1.	Number of analysed units	380	190	183
2.	Counties	314	134	129
3.	Towns	66	56	54

Coding is the stage in the examination process that moves from the collected data to abstract categories [87]. In the process of qualitative research, codes emerge directly from the research [87] (p. 95). In the presented study, key words were developed on the basis of the literature on sustainable tourism [49,88–90], but graphics intended to be visual symbols of these concepts emerged during the coding process as an outcome of this process. The strategy of the coding process involved image-by-image coding. For example, the image of flying birds was a symbol of nature in a destination. Then the collected codes were ordered according to previously worked out coding categories to present the data in the form of statistics.

Categories which represented sustainability of the tourist destination chosen to code the logo's content were as follows:

1. Economic sustainability:
 - local business
 - guidelines for training and certification
 - sustainable tourist behaviour promotion
 - products diversity
 - ethical marketing
2. Ecological sustainability:
 - ecological processes,
 - biological diversity
 - biological resources
 - symbols of nature

3. Cultural sustainability:
 - cultural symbols
 - heritage
 - cultural diversity
4. Local sustainability
 - local human capacity
 - local community symbols
 - indigenous people and traditional skills and jobs.

Since the year 2010, voivodship development strategies have perceived sustainability as the purpose of regional growth, but formerly the idea of environmental protection was developed in such strategies. That's why, up to that year, the idea of sustainable tourism had not been implemented in any of the documents.

The process of coding, classifying and assigning to individual categories was carried out by the authors of the article in accordance with their knowledge, experience in logo researches, and defined codes.

A total of 352 items have been classified; their number is greater than the number of units, because some signatures, due to their complexity and multielement nature, were classified in several items (cf. e.g., Sulęcin County). The most common sustainability symbols come from the cultural sustainability category, symbols of ecological sustainability are the second category practiced in visual promotion, the third one is local sustainability, and economic sustainability visual signs are the least popular in such LGUs activities. As Table 2 shows, the most often are symbols of nature represented, followed closely by symbols of the past culture (heritage). The other signatures contain very diverse content. However, it should be emphasized that those related to local culture, local community, and local business are the most frequently used. What needs attention is a very poor representation of economic sustainability visual symbols. It seems that cities and counties do not communicate in their logos any signs connected with economic activities supporting sustainable development. Examples of signatures in categories of sustainability are presented in Table 3.

Table 2. Categories symbolising sustainability in signatures of towns and counties.

No.	Symbols of Sustainability—Categories	The Number of Signatures Containing Elements of the Given Sustainability	Percentage of Analysed Items
Economic sustainability			
1.	Local business	23	6.5%
2.	Guidelines for training and certification	1	0.3%
3.	Sustainable tourist behaviour promotion	3	0.9%
4.	Products diversity	5	1.4%
5.	Ethical marketing and promotion	2	0.6%
		34	9.7%
Ecological sustainability			
6.	Ecological processes	1	0.3%
7.	Biological diversity	6	1.7%
8.	Biological resources	19	5.4%
9.	Symbols of nature	74	21%
10.	Ecological tips for tourists	5	1.4%
		105	29.8%
Cultural sustainability			
11.	Cultural symbols	16	4.5%
12.	Heritage of the place	71	20.2%

Table 2. Cont.

No.	Symbols of Sustainability—Categories	The Number of Signatures Containing Elements of the Given Sustainability	Percentage of Analysed Items
13.	Cultural diversity	8	2.3%
14.	Social consultation	6	1.7%
15.	Local culture, local identity	23	6.5%
		124	35.2%
	Local sustainability		
16.	Local human capacity	41	11.6%
17.	Local community symbols	29	8.2%
18.	Indigenous people	3	0.9%
19.	Local traditional skills and jobs	8	2.3%
20.	Representative of the local community	8	2.3%
	Total	352	100%

Table 3. Examples of signatures and their sustainably content.

Sustainability Categories	Signature	Remarks
Economic sustainability	 <p>The signature of Łódź</p>	This signature has been chosen for the 'guidelines for training and certification' category. It promotes modern fonts referring to the Władysław Strzemiński idea of a universal alphabet [91], who is one of the most famous artists living in this city. With the slogan 'kreuje', what means 'creates', promotes the value of sustainable development, which is creating favourable conditions for development while maintaining the values of the past.
Ecological sustainability	 <p>Powiat Chełmski Chełmski powiat.</p>	This signature has been chosen for the 'biological resources' category. The picture promotes the places referring to the birds (storks) one can observe in this powiat.
Cultural sustainability	 <p>Siewierz Siewierz community</p>	This signature has been chosen for the 'cultural diversity' category. The logo discloses the characteristics of the community (nature, renaissance castle and local product—"Siewierz bread") and slogan adds stresses typical features of sustainability, and slow life, it states: "No Hurry".
Local sustainability	 <p>powiat koniński energia pokoleń</p> <p>Koniński powiat</p>	This signature has been chosen for the 'local community symbols' and 'indigenous people' categories. It discloses a horse as a region symbol, which itself is connected with the nature and the slogan states: "energy of generations", what specifies a feature of the citizens living there.

In the case of a tourist offer addressed to customers from outside Poland, there is a difficulty with translation or foreign language versions of promotional slogans originally created in Polish (The authors would like to mention here that they conduct a research

project on territorial branding in Poland and maintain regular contacts with LGU's all over Poland what allows them to make such a general conclusion). Although Poland is a relatively large market for inbound tourism [92], in the case of marketing communication, the most common solution is a literal translation of the slogans from the native language into foreign one. There are translations that are linguistically questionable (for example "Chorzów—puts in motion"), but this does not affect the authors' conclusions about the slogans. Untranslatable word games or puns are very rare, in such cases, promotional materials, descriptions, or additional explanations are used to explain the meaning of the slogans. Such an approach, i.e., a literal translation of a slogan in Polish into e.g., English, is justified by the following premises—tourist traffic in Poland is dominated by domestic tourists (80% of overnight stays), and foreign tourists' expenses per capita are almost twice as high as Polish tourists [92].

The Table 4 contains information about the slogans of regional capitals in Poland. It comes from the official identification systems that the authors received from the relevant offices.

Table 4. Slogans used by the capitals of Polish regions (voivodships).

No.	Capital of the Region	Slogo (Tagline)	Remarks
1.	Wrocław (Dolnośląskie)	The meeting place	Literal translation from Polish, general tagline
2.1.	Bydgoszcz (In two regions: Kujawsko-Pomorskie and Lubuskie, the regional administration is, respectively, divided between two cities: Bydgoszcz and Toruń as well as Gorzów and Zielona Góra) (Kujawsko-Pomorskie)	Be our guest	Literal translation from Polish, general tagline
2.2.	Toruń (Kujawsko-Pomorskie)	No tagline	The city uses a brand code built around the idea of gothic architecture.
3.	Lublin (Lubelskie)	City of inspiration	Literal translation from Polish, general tagline
4.1.	Gorzów (Lubuskie)	Haven	Literal translation from Polish, general tagline
4.2.	Zielona Góra (Lubuskie)	No tagline	
5.	Łódź (Łódzkie)	Creates	Literal translation from Polish, general tagline
6.	Kraków (Małopolskie)	No tagline	
7.	Warszawa (Mazowieckie)	Fall in love with Warsaw	Literal translation from Polish, general tagline
8.	Opole (Opolskie)	"Przebojowe"	"Hit", i.e., popular, known, liked. It refers to the Polish song festivals. The logo can be used without a tagline
9.	Rzeszów (Podkarpackie)	Capital of innovation	Literal translation from Polish, general tagline
10.	Białystok (Podlaskie)	No tagline	Until the end of 2019, the slogan "Rising Białystok" was used
11.	Gdańsk (Pomorskie)	City of freedom	Literal translation from Polish, general tagline
12.	Katowice (Śląskie)	For a change	Literal translation from Polish, general tagline
13.	Kielce (Świętokrzyskie)	No tagline	The work on a new visual identification is underway, to be completed in 2021.
14.	Olsztyn (Warmińsko-Mazurskie)	"O!gród z natury"	Slogan only in Polish, untranslatable due to the play on words: garden and 'castle' (archaic—city) and the use of a diacritical sign.
15.	Poznań (Wielkopolskie)	No tagline	
16.	Szczecin (Zachodniopomorskie)	Floating garden	Tagline in English only

5. Conclusions

Half of the surveyed local government units use visual signs, such as the logos in their promotional activities, and most of them communicate symbols representing the values of sustainable development. The quantitative analysis shows that local governments denote mostly nature and cultural heritage in visual messages addressed to visitors and residents.

Therefore, every fifth LGU recognizes nature as a symbol that denotes destination. Fewer destinations reveal their cultural past in visual signs, which means that the nature and traditional culture are expected to be recognised by the recipients of LGU visual messages. The local government units are also relatively attached to local values, which are presented in promotional signs. Especially important, disclosed by 10% of LGUs, is local human capacity.

5.1. Theoretical Implications

The paper contributes to an understanding of logos functions in promoting sustainable tourism. LGUs, revealing the elements of sustainable development, consciously communicate features of a given destination associated with elements of sustainable development. They present themselves to the visitors as places friendly to sustainable development, caring for natural and historical heritage. However, it should be emphasised that ethical and economic categories, which are the principal features of sustainability, are marginally presented in the examined signatures.

When analysing the logo content of the Polish cities and counties, and considering a semiotic analysis, it should be emphasized that although nature and culture, which are important elements of sustainable development, are strongly represented, the connotation will be different. The iconic symbols of nature and traditional cultural objects, in the light of the contemporary expectations of the audience, would rather connote tradition, the past, and even conservatism.

Sustainable development, including sustainable tourism, is a symbol of the present, postmodernity, and in essence, is an idea directed towards the sustainable future. The Polish destinations' signatures do not have such features. Therefore, the denotation is different from the connotation of these messages. The recipient receives the image of a traditional country that cares about nature and culture, but cannot identify the relationship between the Polish culture and nature with the economy, which, in accordance with the concept of sustainable development, should reveal symbols that allow us to think about a future reality similar to the current one. It is known from the researches that tourism has already shifted from traditional tourism to sustainable tourism and tourists might expect symbols clearly connected with economic and local sustainability, which in the examined signatures are poorly represented.

Indication, through consistent visual identification, of the sustainable type of a tourist offer has, from the point of view of DMO, at least two features:

1. Such visual identification may build relationships with the local (host) community.
2. It also may perform a sort of selective role in target markets.

From the communication point of view, the second feature is more important. The form of the offer itself automatically selects interested visitors for those looking for sustainable offers and not. The form of the message itself can tell who the desired customer is.

5.2. Managerial Implications

Research has shown that several sustainability indicators are significantly more numerous than others. They are symbols of nature (74), heritage of place (71), and local human capacity (41). It is commonly accepted that there are two primary goals in creating and managing a brand identity—description and distinction [93]. If so, many signs refer to the same symbols; distinguishing them can be difficult as they do not fulfill one of the basic marketing functions. Other studies, at least in the case of Poland, also indicate that the visual content is relatively poor and more or less literally represent things such as the sun, water, and greenery [94].

5.3. Discussion and Limitations

Although the authors made every effort to gather all signatures, the collected signature database is still incomplete. For example, there are logos that can be found on websites, but the lack of documentation makes it impossible to qualify (authors have found at least

three such cases). The second reason why the database is incomplete is the variability of logos practiced in the management of cities and regions in Poland. Signatures are withdrawn, modified, or replaced by new ones, without official announcement. The image of the place presented by the signatures could change if you take into account the so-called investment signatures (e.g., logos created to encourage investors to invest in a particular place). However, this requires separate data collection methods as the sources are not widely available.

Another difficulty that limits the presented research is related to the relationship between the destination signature and the logo of the office (LGU administration of this destination) that holds the power in that destination. Moreover, there is also the difficulty of implementing visual identity for a particular destination. The process of development and implementation is very long, and the multitude of management procedures resulting from national law make it difficult. Multiple identification breaks down the uniformity of the brand, an issue noticed also by other researchers [51].

There is a question about the impact of logos and slogans on tourist's perception. Do they influence tourists' decisions, and if so—how effectively? Since the paper does not concern research on the reception of advertising messages, one can only indicate the direction of further research. Firstly, there are extensive analyses of territorial promotional slogans in Poland, which enable comparative research [95,96]. Secondly, practitioners emphasize the importance of the quality of slogans. Steve Cone, for example, emphasizes that official tourist slogans are “shallow and boring” [97]. Thirdly, this quality should be assessed not only in terms of logo content, but also the form, i.e., the impact on the reception of such elements as: shape, colour, fonts or unusual graphic solutions in the slogan (vide Szczecin “Floating garden”). As Gałkowski stresses [98] “The effectiveness of a slogan consists of a number of factors, also nonformal and nonintentional. The success of its use also depends on the cultural conditions”.

Therefore, the additional question arises of how to promote tourism when there is no uniformity in legal regulations and in governing the destination. For example, there are two types of communication: (1) formal—official communication practiced by a given LGU, which informs what activities in the field of sustainable development a town or region undertakes, and what the attitudes of the inhabitants toward sustainable tourism are, and (2) advertising communication that uses rhetorical artifices, which often allow for free interpretation of the message. This freedom in reading the content of the signatures as a visual identity is limited and even imposed by the verbal text—a slogan that specifies what the signature is about. As Eco wrote, there can be either concordance or incompatibility [50]. An image with a significant aesthetic function is accompanied by a slogan with an emotive function, or an image with a metaphorical structure is accompanied by a slogan with a metonymic structure. There could be a very business-like logo, but the slogan contradicts its content, as an example.

The results reported here add to the existing literature in the field data which show how signatures may promote a particular idea, in this case sustainable tourism. However, the results show that what is communicated in the signature content may have a completely different meaning for the recipient of the message. Natural, historical or cultural symbols do not imply that a destination is oriented towards sustainable tourism. According to the semiotics, the denotation of a sign may connote the opposite meaning. The fact that nature is promoted in the logo does not mean that it is properly protected in the promoted territory. Showing cultural goods in the visual promotion of the destination does not mean that they are valuable in the life of the local community.

5.4. Future Research

Further research should concern the recipient's perspective. Knowing the content of signatures covering sustainable symbols does not mean that this content is perceived by recipients. The researches presented so far [3,99,100] mainly focused on case studies, including in the case of Poland.

Understanding tourists' perception as to whether a particular destination supports sustainability is critical, especially today, during the COVID-19 pandemic [101]. However, such an issue is the subject of comprehensive research focused on the audience.

An important research direction may be the analysis of the inhabitants' identification with the values of sustainable development. It can be assumed that the stronger the identification with these values, the stronger the acceptance of the visual expression of the specificity of a place as attractive due to these values.

Author Contributions: Conceptualization, P.D. and A.A.-M.; methodology, A.A.-M.; validation, J.M. and G.P.; formal analysis, J.M. and P.D.; resources, P.D.; data curation, P.D.; writing—original draft preparation, A.A.-M.; writing—review and editing, J.M.; visualization, J.M.; supervision, G.P.; project administration, G.P.; funding acquisition, A.A.-M. All authors have read and agreed to the published version of the manuscript.

Funding: This research received no external funding.

Institutional Review Board Statement: not applicable.

Informed Consent Statement: not applicable.

Data Availability Statement: Data available in a publicly accessible repository that does not issue DOIs.

Conflicts of Interest: The authors declare no conflict of interest.

References

1. Pauwels, L. Urban Communication Research | Visually Researching and Communicating the City: A Systematic Assessment of Methods and Resources. *Int. J. Commun.* **2016**, *10*, 22.
2. Pauwels, L. Conceptualising the 'Visual Essay' as a Way of Generating and Imparting Sociological Insight: Issues, Formats and Realisations. *Sociol. Res. Online* **2012**, *17*, 76–86. [CrossRef]
3. Burns, P.M.; Palmer, C.; Lester, J.-A.M. (Eds.) *Tourism and Visual Culture*, 1st ed.; CABI: Oxfordshire, UK; Cambridge, MA, USA, 2010; ISBN 978-1-84593-609-9.
4. Ruiz-Real, J.L.; Uribe-Toril, J.; Gázquez-Abad, J.C. Destination branding: Opportunities and new challenges. *J. Destin. Mark. Manag.* **2020**, *17*, 100453. [CrossRef]
5. Paganoni, M. *City Branding and New Media: Linguistic Perspectives, Discursive Strategies and Multimodality*; Palgrave Macmillan: London, UK, 2015; ISBN 978-1-137-38795-0.
6. Dunleavy, D. Visual Semiotics Theory: Introduction to the Science of Signs. In *Handbook of Visual Communication. Theory, Methods, and Media*; Josephson, S., Kelly, J.D., Smith, K., Eds.; Routledge: Abingdon, UK, 2020; pp. 155–170.
7. Bramwell, B. Theoretical activity in sustainable tourism research. *Ann. Tour. Res.* **2015**, *54*, 204–218. [CrossRef]
8. Wheeler, A. *Designing Brand Identity: An Essential Guide for the Whole Branding Team*, 5th ed.; Wiley: Hoboken, NJ, USA, 2017; ISBN 978-1-118-98082-8.
9. Healey, M. *Deconstructing Logo Design: 300+ International Logos Analysed and Explained by Matthew Healey*; Rotovision: Brighton, UK, 2010.
10. Henderson, P.W.; Cote, J.A. Guidelines for Selecting or Modifying Logos. *J. Mark.* **1998**, *62*, 14–30. [CrossRef]
11. Van Der Lans, R.; Cote, J.A.; Cole, C.A.; Leong, S.M.; Smidts, A.; Henderson, P.W.; Bluemelhuber, C.; Bottomley, P.A.; Doyle, J.R.; Fedorikhin, A.; et al. Cross-National Logo Evaluation Analysis: An Individual-Level Approach. *Mark. Sci.* **2009**, *28*, 968–985. [CrossRef]
12. Walas, B. Znaczenie Logo Miast w Rozpoznawalności Miejsca Docelowego. *Studia Oeconomica Posnaniensia* **2014**, *2*, 264.
13. Xu, L.; Yu, F.; Ding, X. Circular-Looking Makes Green-Buying: How Brand Logo Shapes Influence Green Consumption. *Sustainability* **2020**, *12*, 1791. [CrossRef]
14. Zenker, S.; Braun, E.; Petersen, S. Branding the destination versus the place: The effects of brand complexity and identification for residents and visitors. *Tour. Manag.* **2017**, *58*, 15–27. [CrossRef]
15. Adamus-Matuszyńska, A.; Dzik, P. *Tożsamość Wizualna Polskich Województw, Miast i Powiatów. Identyfikacja, Prezentacja, Znaczenie; Wydawnictwo Adam Marszałek: Torun, Poland, 2017; ISBN 978-83-8019-602-5.*
16. Johnston, K.A. Community Engagement: Exploring a Relational Approach to Consultation and Collaborative Practice in Australia. *J. Promot. Manag.* **2010**, *16*, 217–234. [CrossRef]
17. Pike, S. Destination brand positions of a competitive set of near-home destinations. *Tour. Manag.* **2009**, *30*, 857–866. [CrossRef]
18. Pike, S.; Page, S.J. Destination Marketing Organizations and destination marketing: A narrative analysis of the literature. *Tour. Manag.* **2014**, *41*, 202–227. [CrossRef]
19. Belkadi, E. City Branding: Proposal of an Observation and Analysis Grid. In *Strategic Innovative Marketing and Tourism*; Springer: Cham, Switzerland, 2020; pp. 121–128. ISBN 978-3-030-36125-9.

20. Hirschman, E.C. Humanistic Inquiry in Marketing Research: Philosophy, Method, and Criteria. *J. Mark. Res.* **1986**, *23*, 237. [[CrossRef](#)]
21. Pizzorno, A. Rationality and recognition. In *Approaches and Methodologies in the Social Sciences: A Pluralist Perspective*; Della Porta, D., Keatinge, M., Eds.; Cambridge University Press: Cambridge, UK, 2008; pp. 162–174. ISBN 978-0-521-88322-1.
22. Pike, S. *Destination Marketing: An Integrated Marketing Communication Approach*; Routledge: Abingdon, UK, 2008; ISBN 978-0-7506-8649-5.
23. Leiper, N. The framework of tourism: Towards a definition of tourism, tourist, and the tourist industry. *Ann. Tour. Res.* **1979**, *6*, 390–407. [[CrossRef](#)]
24. Morrison, A.M. *Destination Management and Destination Marketing: The Platform for Excellence in Tourism Destinations*. *Tour. Rev.* **2013**, *28*, 6–9.
25. Morgan, N.; Pritchard, A.; Pride, R. (Eds.) *Destination Branding: Creating the Unique Destination Proposition*; Routledge: Abingdon, UK, 2004; ISBN 978-0-7506-5969-7.
26. Kasapi, I.; Cela, A. Destination Branding: A Review of the City Branding Literature. *Mediterr. J. Soc. Sci.* **2017**, *8*, 129–142. [[CrossRef](#)]
27. Hankinson, G. The management of destination brands: Five guiding principles based on recent developments in corporate branding theory. *J. Brand Manag.* **2007**, *14*, 240–254. [[CrossRef](#)]
28. Pike, S. Tourism destination branding complexity. *J. Prod. Brand Manag.* **2005**, *14*, 258–259. [[CrossRef](#)]
29. Morgan, N.; Pritchard, A. Meeting the destination branding challenge. In *Destination Branding: Creating the Unique Destination Proposition*; Morgan, N., Pritchard, A., Pride, R., Eds.; Routledge: Abingdon, UK, 2004; pp. 59–78. ISBN 978-0-7506-5969-7.
30. Cai, L.A. Cooperative branding for rural destinations. *Ann. Tour. Res.* **2002**, *29*, 720–742. [[CrossRef](#)]
31. Kapferer, J.-N. *The New Strategic Brand Management: Advanced Insights and Strategic Thinking*; Kogan Page: London, UK; Philadelphia, PA, USA, 2008; ISBN 978-0-7494-6515-5.
32. Balakrishnan, M.S. Strategic branding of destinations: A framework. *Eur. J. Mark.* **2009**, *43*, 611–629. [[CrossRef](#)]
33. Florek, M. *Podstawy Marketingu Terytorialnego*; Wydawnictwo Uniwersytetu Ekonomicznego w Poznaniu: Poznań, Poland, 2013; ISBN 978-83-7417-727-6.
34. Nandan, S. An exploration of the brand identity–brand image linkage: A communications perspective. *J. Brand Manag.* **2005**, *12*, 264–278. [[CrossRef](#)]
35. Konecnik Ruzzier, M. Country brand and identity issues: Slovenia. In *Destination Brands*; Morgan, N., Pritchard, A., Pride, R., Eds.; Routledge: Abingdon, UK, 2012; ISBN 978-1-136-34663-7.
36. Çınar, K. Customer Based Brand Equity Models in Hotel Industry: A Literature Review. In *Strategic Innovative Marketing and Tourism*; Springer: Berlin, Germany, 2020; pp. 281–288. ISBN 978-3-030-36125-9.
37. Zavattaro, S. *Place Branding through Phases of the Image: Balancing Image and Substance*. Palgrave Macmillan: New York, NY, USA, 2014; ISBN 978-1-137-39443-9.
38. Pasquier, M.; Villeneuve, J.-P. *Marketing Management and Communications in the Public Sector*; Routledge: Abingdon, UK, 2012; ISBN 978-1-136-50459-4.
39. Percy, L. *Strategic Integrated Marketing Communication: Theory and Practice*; Routledge: Abingdon, UK, 2008; ISBN 978-0-7506-7980-0.
40. Marczak, M. Branding as an Essential Element of the of Destination Management Process Using the Example of Selected States. *Manag. Sci. Nauk. Zarządzaniu* **2018**, *23*, 29–40. [[CrossRef](#)]
41. Kiryluk, H.; Glińska, E.; Barkun, Y. Benefits and barriers to cooperation in the process of building a place’s brand: Perspective of tourist region stakeholders in Poland. *Oeconomia Copernic.* **2020**, *11*, 289–307. [[CrossRef](#)]
42. Blain, C.; Levy, S.E.; Ritchie, J.R.B. Destination Branding: Insights and Practices from Destination Management Organizations. *J. Travel Res.* **2005**, *43*, 328–338. [[CrossRef](#)]
43. Sartori, A.; Mottironi, C.; Corigliano, M.A. Tourist destination brand equity and internal stakeholders: An Empirical Research. *J. Vacat. Mark.* **2012**, *18*, 327–340. [[CrossRef](#)]
44. Adamus-Matuszyńska, A.; Dzik, P. Measurement of Local Government Unit Marketing Orientation. *Studia Ekon.* **2017**, *336*, 172–182.
45. Konecnik Ruzzier, M.; Petek, N. Country Brand I Feel Slovenia: First Response from Locals. *Econ. Res. Ekon. Istraživanja* **2012**, *25*, 465–484. [[CrossRef](#)]
46. Francesconi, S. *Reading Tourism Texts: A Multimodal Analysis*; Channel View Publications: Bristol, UK, 2014; ISBN 978-1-84541-428-3.
47. Barisic, P.; Blazevic, Z. Visual Identity Components of Tourist Destination. *World Acad. Sci. Eng. Technol. Int. J. Soc. Behav. Educ. Econ. Manag. Eng.* **2014**, *8*. [[CrossRef](#)]
48. Kladou, S.; Kavaratzis, M.; Rigopoulou, I.; Salonika, E. The role of brand elements in destination branding. *J. Destin. Mark. Manag.* **2017**, *6*, 426–435. [[CrossRef](#)]
49. Ehtner, C.M. The semiotic paradigm: Implications for tourism research. *Tour. Manag.* **1999**, *20*, 47–57. [[CrossRef](#)]
50. Eco, U. *La Struttura Assente: La Ricerca Semiotica e il Metodo Strutturale*; Casa Editrice Valentino Bompiani & C.: Milano, Italy, 2016. (In Polish)
51. Beyrow, M.; Vogt, C. *Städte und Ihre Zeichen: Identität, Strategie, Logo*; Avedition: Stuttgart, Germany, 2014; ISBN 978-3-89986-202-7.

52. Kozak, M. *Turystyka i Polityka Turystyczna a Rozwój: Między Starym a Nowym Paradygmatem*; Wydawnictwo Naukowe Scholar: Warsaw, Poland, 2009.
53. Lee, K.F. Sustainable tourism destinations: The importance of cleaner production. *J. Clean. Prod.* **2001**, *9*, 313–323. [CrossRef]
54. Nguyen, T.Q.T.; Young, T.; Johnson, P.; Wearing, S. Conceptualising networks in sustainable tourism development. *Tour. Manag. Perspect.* **2019**, *32*, 100575. [CrossRef]
55. Sharpley, R. Tourism and Sustainable Development: Exploring the Theoretical Divide. *J. Sustain. Tour.* **2000**, *8*, 1–19. [CrossRef]
56. Bramwell, B.; Higham, J.; Lane, B.; Miller, G. Twenty-five years of sustainable tourism and the Journal of Sustainable Tourism: Looking back and moving forward. *J. Sustain. Tour.* **2017**, *25*, 1–9. [CrossRef]
57. Williams, A.M. Mobilities and sustainable tourism: Path-creating or path-dependent relationships? *J. Sustain. Tour.* **2013**, *21*, 511–531. [CrossRef]
58. Berno, T.; Bricker, K. Sustainable Tourism Development: The Long Road from Theory to Practice. *Int. J. Econ. Dev.* **2001**, *3*, 1–18.
59. Murphy, P.E.; Price, G.G. Chapter 9—Tourism and sustainable development. In *Global Tourism (Third Edition)*; Theobald, W.F., Ed.; Butterworth-Heinemann: Boston, MA, USA, 2005; pp. 167–193. ISBN 978-0-7506-7789-9.
60. World Tourism Organization (UNWTO) (Ed.) *UNWTO Tourism Highlights, 2002 Edition*; World Tourism Organization (UNWTO): Madrid, Spain, 2002; ISBN 978-92-844-0687-6.
61. Faulkner, B. Chapter 15. *Destination Australia: A Research Agenda for 2002 and Beyond*; Channel View Publications: Bristol, UK, 2003; pp. 341–357. ISBN 978-1-873150-49-8.
62. Bramwell, B.; Lane, B. Critical research on the governance of tourism and sustainability. *J. Sustain. Tour.* **2011**, *19*, 411–421. [CrossRef]
63. Bramwell, B.; Meyer, D. Power and tourism policy relations in transition. *Ann. Tour. Res.* **2007**, *34*, 766–788. [CrossRef]
64. Hall, C.M. A typology of governance and its implications for tourism policy analysis. *J. Sustain. Tour.* **2011**, *19*, 437–457. [CrossRef]
65. Peattie, K. *Green Marketing*; Pitman: New York, NY, USA, 1992; ISBN 978-0-7121-0843-0.
66. Coddington, W.; Florian, P. *Environmental Marketing: Positive Strategies for Reaching the Green Consumer*; McGraw-Hill: New York, NY, USA, 1993; ISBN 978-0-07-011599-6.
67. van Dam, Y.K.; Apeldoorn, P.A.C. Sustainable Marketing. *J. Macromarketing* **1996**, *16*, 45–56.
68. Crane, A. Marketing and the Natural Environment: What Role for Morality? *J. Macromarketing* **2016**. [CrossRef]
69. Dolan, P. The Sustainability of “Sustainable Consumption.” *J. Macromarketing* **2002**, *22*, 170–181. [CrossRef]
70. Hunt, S.D. Toward the Institutionalization of Macromarketing: Sustainable Enterprise, Sustainable Marketing, Sustainable Development, and the Sustainable Society. *J. Macromarketing* **2012**, *32*, 404–411. [CrossRef]
71. Hall, C. *Tourism and Social Marketing*; Routledge: Abingdon, UK, 2014; ISBN 978-0-415-57665-9.
72. Mowforth, M.; Munt, I. *Tourism and Sustainability: Development, Globalisation and New Tourism in the Third World*, 3rd ed.; Routledge: London, UK; New York, NY, USA, 2008; ISBN 978-0-415-41403-6.
73. Conaghan, D.; Hanrahan, J.; McLoughlin, E. The Sustainable Management of a Tourism Destination in Ireland: A Focus on County Clare. *Adv. Hosp. Tour. Res.* **2015**, *3*, 62–87.
74. Ooi, N.; Laing, J.H. Backpacker tourism: Sustainable and purposeful? Investigating the overlap between backpacker tourism and volunteer tourism motivations. *J. Sustain. Tour.* **2010**, *18*, 191–206. [CrossRef]
75. Aydin, B.; Alvarez, M.D. Understanding the Tourists’ Perspective of Sustainability in Cultural Tourist Destinations. *Sustainability* **2020**, *12*, 8846. [CrossRef]
76. Tanguay, G.; Rajaonson, J.; Therrien, M.-C. Sustainable Tourism Indicators: Selection Criteria for Policy Implementation and Scientific Recognition. *J. Sustain. Tour.* **2012**, *21*. [CrossRef]
77. Agenda 21 for the Travel & Tourism Industry. 1997. Available online: <https://www.e-unwto.org/doi/book/10.18111/9789284403714> (accessed on 10 January 2021).
78. Magala, S. Antropologia wizualna. In *Badania Jakościowe. Podejścia i Teorie*; Jemielniak, D., Ed.; Wydawnictwo Naukowe PWN: Warsaw, Poland, 2012.
79. Schroeder, J.; Salzer-Morling, M.S. Introduction: The Cultural Codes of Branding. In *Brand Culture*; Schroeder, J., Salzer-Morling, M.S., Eds.; Routledge: Abingdon, UK, 2006; ISBN 978-0-203-00244-5.
80. Govers, R.; Go, F. *Place Branding: Glocal, Virtual and Physical Identities, Constructed, Imagined and Experienced*; Palgrave Macmillan UK: London, UK, 2009; ISBN 978-0-230-23073-6.
81. Hashim, A.R. Urban design and the entrepreneurial city: Place branding theory and methods. In *Advertising and Branding: Concepts, Methodologies, Tools, and Applications*; IGI Global: Hershey, PA, USA, 2017; pp. 204–227.
82. Govers, R.; Go, F.M.; Kumar, K. Promoting Tourism Destination Image. *J. Travel Res.* **2007**, *46*, 15–23. [CrossRef]
83. Rose, G. *Visual Methodologies: An Introduction to Researching with Visual Materials*; SAGE: Thousand Oaks, CA, USA, 2016; ISBN 978-1-4739-6791-5.
84. Neuendorf, K.A. Reliability for Content Analysis. In *Media Messages and Public Health: A Decisions Approach to Content Analysis*; Jordan, A., Kunkel, D., Manganello, J., Fishbein, M., Eds.; Routledge Taylor & Francis Group: Abingdon, UK, 2008; ISBN 978-0-203-88734-9.
85. Dymond, S.J. Indicators of Sustainable Tourism in New Zealand: A Local Government Perspective. *J. Sustain. Tour.* **1997**, *5*, 279–293. [CrossRef]
86. Kochan, M. *Slogany w Reklamie i Polityce*; Trio: Warsaw, Poland, 2005; ISBN 978-83-88542-35-0.

87. Glinka, B.; Hensel, P. Teoria ugruntowana. In *Badania Jakościowe. PODEJŚCIA i Teorie*; Jemielniak, D., Ed.; Wydawnictwo Naukowe PWN: Warsaw, Poland, 2012.
88. Shafiee, S.; Rajabzadeh Ghatari, A.; Hasanzadeh, A.; Jahanyan, S. Developing a model for sustainable smart tourism destinations: A systematic review. *Tour. Manag. Perspect.* **2019**, *31*, 287–300. [[CrossRef](#)]
89. Lane, B. Will sustainable tourism research be sustainable in the future? An opinion piece. *Tour. Manag. Perspect.* **2018**, *25*, 161–164. [[CrossRef](#)]
90. Northcote, J.; Macbeth, J. Conceptualizing Yield: Sustainable Tourism Management. *Ann. Tour. Res.* **2006**, *33*, 199–220. [[CrossRef](#)]
91. Szydłowska, A.; Misiak, M. *Paneuropa, Kometa, Hel: Szkice z Historii Projektowania Liter w Polsce*; Karakter: Kraków, Poland, 2015.
92. Czernicki, Ł.; Kukołowicz, P. Maciej Miniszewski. In *Branża Turystyczna w Polsce. Obraz Sprzed Pandemii*; Polski Instytut Ekonomiczny: Warszawa, Poland, 2020.
93. Mollerup, P. *Marks of Excellence: The Development and Taxonomy of Trademarks Revised and Expanded Edition*, 2nd ed.; Phaidon Press: London, UK, 2013; ISBN 978-0-7148-6474-7.
94. Adamus-Matuszyńska, A.; Dzik, P. Logo w Komunikacji Marketingowej Samorządu Terytorialnego. *Mark. Rynek* **2017**, *10*, 26–42.
95. Jędrzejczak, B. *Słownik Sloganów Reklamujących Polskie Marki Terytorialne*; Wydawnictwo Uniwersytetu Gdańskiego: Gdańsk, Poland, 2018; Volume 1.
96. Jędrzejczak, B. *Językowe Środki Perswazji w Sloganach Reklamujących Polskie Marki Terytorialne Na Przykładzie Hasel Promujących Polskę, Województwa i Miasta Wojewódzkie*; Wydawnictwo Uniwersytetu Gdańskiego: Gdańsk, Poland, 2020.
97. Cone, S. *Superslogany. Słowa, Które Zdobywają Klientów i Zwolenników, a Nawet Zmieniają Bieg Historii*; Wolters Kluwer Polska: Warsaw, Poland, 2010.
98. Gałkowski, A. Hasła Reklamowe Miast Polskich w Kontekście Urbanomicznym. *Rozprawy Komisji Językowej ŁTN* **2014**, 67–79. Available online: <http://cejsh.icm.edu.pl/cejsh/element/bwmeta1.element.desklight-3082afe9-1b8c-4b32-9bd8-bda19da835fa> (accessed on 5 January 2021).
99. Van, H.T.; Huu, A.T.; Ushakov, D. Destination Branding as a Tool for Sustainable Tourism Development (The Case of Bangkok, Thailand). *Adv. Sci. Lett.* **2018**, *24*, 6339–6342. [[CrossRef](#)]
100. Florek, M.; Insch, A.; Gnoth, J. City Council websites as a means of place brand identity communication. *Place Brand.* **2006**, *2*, 276–296. [[CrossRef](#)]
101. Lima Santos, L.; Cardoso, L.; Araújo-Vila, N.; Fraiz-Brea, J.A. Sustainability Perceptions in Tourism and Hospitality: A Mixed-Method Bibliometric Approach. *Sustainability* **2020**, *12*, 8852. [[CrossRef](#)]

Article

Tourism Development in Post-Industrial Facilities as a Regional Business Model

Marek Józwiak * and Patrycja Sieg

Department of Organizational Innovation Management, Faculty of Management, UTP University of Science and Technology in Bydgoszcz, 430 Fordońska St, 85-790 Bydgoszcz, Poland; patrycjasieg1@gmail.com

* Correspondence: marek.jozwiak@utp.edu.pl

Abstract: In the article presented, the authors have attempted to define the development of post-industrial facilities, on the example of a thematic trail located in Bydgoszcz, as well as to assess the impact of this route on the city's attractiveness. The TeH₂O thematic trail is an example of a business model that utilizes post-industrial facilities for the development of a business partnership between the route facilities, the objects located in the vicinity, as well as the route participants. The article discusses the use of post-industrial facilities for tourist purposes and the legal aspects associated with the process of transforming such facilities. This paper presents the results of a research carried out on two groups of respondents, i.e., the residents of the city of Bydgoszcz and the tourists who have visited or are about to visit the city of Bydgoszcz. As a result of the research carried out, it has been found that the thematic trail examined affects the attractiveness of the city of Bydgoszcz. Both the respondents from the city of Bydgoszcz as well as the tourists visiting the city acknowledged it. The TeH₂O thematic trail is more popular among the inhabitants of Bydgoszcz than among the visitors.

Keywords: business models; industrial tourism; post-industrial facilities; TeH₂O Industrial Themed Trail

Citation: Józwiak, M.; Sieg, P. Tourism Development in Post-Industrial Facilities as a Regional Business Model. *Sustainability* **2021**, *13*, 2028. <https://doi.org/10.3390/su13042028>

Academic Editors: Marc A. Rosen and Adam R. Szromek
Received: 21 December 2020
Accepted: 5 February 2021
Published: 13 February 2021

Publisher's Note: MDPI stays neutral with regard to jurisdictional claims in published maps and institutional affiliations.



Copyright: © 2021 by the authors. Licensee MDPI, Basel, Switzerland. This article is an open access article distributed under the terms and conditions of the Creative Commons Attribution (CC BY) license (<https://creativecommons.org/licenses/by/4.0/>).

1. Introduction

Industrialization of Europe contributed to the formation of generations. Such innovations as the steam engine, electricity, and medical progress have shaped the world to its present state, which we know today. Nevertheless, the rather rapid and intensive economic and industrial growth as well as the exploitation of natural resources contributed to changes in many areas and infrastructure, turning them into degraded, desolate land, impacting the natural environment significantly. The landscapes of natural regions had been completely changed, and the remains of the industrial period became a difficult problem to solve.

Owing to the development of industrial tourism, and above all, sustainable tourism, post-industrial facilities get new life [1]. The idea of sustainable development replaces the emphasis on finding a perfect solution with the use of tangible and intangible values, which is important from the perspective of social life and would be lost if no activities have been undertaken [2]. Therefore, the process of changing post-industrial buildings into tourist facilities, including tourist trails, is related to the design of sustainable development models as well as business models [3].

An increased interest in industrial tourism has been noticed in the past decade. This trend is seen both in Europe and Poland. Industrial tourism becomes one of the best forms of promoting the tourist and cultural potential of a specific region, area, or city [4].

The purpose of this article is to determine the development of post-industrial facilities based on the TeH₂O Industrial Themed Trail in Bydgoszcz serving as an example of industrial tourism and its impact on city attractiveness. It additionally indicates a business model that is based on resource utilization, in the form of industrial tourist trail landmarks.

In order to achieve these goals, it was necessary to conduct an analysis of the state of knowledge, the technology and the terminology related to development of post-industrial facilities, as to explain the role they play in contemporary tourism and discuss the topic of business models. The most important issue was to conduct a survey among the Bydgoszcz residents and visitors, in order to determine the impact that the development of post-industrial buildings has on the city's attractiveness.

Development of post-industrial facilities for the purposes of industrial tourism becomes increasingly popular. Such activity allows for the protection of historic landmarks, equipping them with new roles, providing creative impact on the life of local residents, and facilitating development of new business models. All the advantages arising from heritage site revitalization contribute to the increasing number of industrial tourism advocates. Through their educational, historical, and creative character these sites become increasingly attractive to present-day tourists. One additional advantage of developed post-industrial facilities is the fact that they promote the locations, in which they are featured. In this way, they make the current industrial cities more interesting [5]. A similar process can be seen in Bydgoszcz, where owing to the presence of the TeH₂O Water, Industry and Craft Trail, the city's tourist attractiveness has considerably increased. The trail mentioned attracts a growing number of tourists from outside the city, who are interested in industrial tourism. Developed post-industrial facilities also provide important information about the region which they represent, raising interest among their visitors.

The trail's full name is the TeH₂O Water, Industry and Craft Trail. For the purpose of this article, the authors will also use other names in reference to the trail: TeH₂O Trail, TeH₂O Industrial Thematic Trail in Bydgoszcz, TeH₂O Thematic Trail, TeH₂O Water, Industry and Craft Trail.

The TeH₂O Water, Industry and Craft Trail in Bydgoszcz encompasses the following city heritage sites: The Explozeum, the Granaries on the Brda River, the Mill Island, the Bydgoszcz Canal, the Museum of Soap and the Dirt History, Water Tower, the Museum of Photography, the Bydgoszcz Beer Brewery, the "Pod Łabędziem" Pharmacy, the Water Supply Pump Hall, the Bookbinding Workshop, the Former municipal gas works, Woodworking Factory, the "Lemara" Barge, the Museum of the Bydgoszcz Canal [6].

The TeH₂O thematic trail was established as a result of the SHIFT-X project co-financed by the European Regional Development Fund and joined by the city of Bydgoszcz. The Bydgoszcz City Hall is thus the originator and the founder of the TeH₂O Trail. Since 2016, the trail has been administered by the Leon Wyczółkowski District Museum, with only one person employed at the Department of Education and Promotion as the route coordinator.

The person responsible for the operation of the trail on behalf of the Leon Wyczółkowski District Museum is the Coordinator of the TeH₂O Water, Industry and Craft Trail in Bydgoszcz. The coordinator's main tasks include, inter alia, the following [7]:

- Representation of the entities operating as part of the trail in contacts with third parties;
- Promotion and provision of information about the trail offer on behalf of all partners, development and implementation of promotional activities;
- Implementation of all activities within the trail structure, i.e., communication between entities, development of a permanent offer as well as the issues related to customer service and tourism-related infrastructure, etc.

One important element of the trail's functioning entails its support for the Bydgoszcz City Hall, which makes annual budget decisions and can issue recommendations for the Leon Wyczółkowski District Museum regarding the functioning of the TeH₂O Trail. The functioning of the trail is also assisted by the Bydgoszcz Information Center and the Kujawsko-Pomorska Organizacja Turystyczna (a tourist organization). The results of the survey conducted enrich the literature on sustainable industrial tourism and on development of post-industrial facilities in the context of creating business models. In addition, they serve as a recommendation for conduction of further quantitative research in this field. They provide good practice knowledge for the development of new tourist

products—tourist trails based on post-industrial facilities, serving as a foundation for a business model.

2. Literature Review

2.1. Utilization of Post-Industrial Facilities and Industrial Tourism

Technological progress has significant impact on the way some things, goods, and articles of everyday use are made. Development of humanity, from the beginning of its existence, has influenced new discoveries and inventions. A huge part of it was so significant, that it resulted in the changes in the structure and organization of industry. These sites and—first of all—the post-industrial facilities in our surroundings have been identified for a relatively short time. They primarily pertain to city centers, which in the past two centuries had served as industrial centers. Nowadays they serve as relics of the industrial period, unique reminders, and historical witnesses of the bygone era [8].

These areas or facilities, which ceased to operate as production plants or do not fulfill their other auxiliary functions associated with production, along with the areas of unfinished industrial projects, are called post-industrial areas or brownfield lands [9]. Many post-industrial objects result from industrial revolutions, but they are also related to political system changes, business bankruptcies, as well as development of technology and science [10,11].

Depending on the time of development of post-industrial areas, these locations, both in Poland and Europe, had certain common features. During the 1930s, post-industrial facilities were located in city centers or on their outskirts, but also in close proximity to rivers. In the following decades (i.e., the 1960s and 1970s), along with the technological progress, post-industrial facilities were situated in the vicinity of railroads or thoroughfares [12].

Both in Poland and Europe construction of many post-industrial facilities was determined by such factors as reduced coal mining and implementation of environmentally friendly solutions. It led to the restructuring of industry, which was losing its status. These activities resulted in profitability declines or even business closures experienced by many enterprises [10,13].

Many countries faced the problem of post-industrial facilities, not being sure how to treat them—as a burden, which should be discarded as soon as possible or as something useful, bringing benefits in the future. Many post-industrial facilities completely disappeared, or their purpose was suddenly changed. Frequently, due to hasty decisions, it had negative impact, causing irreversible long-term changes [14,15].

Tourism plays an increasingly important role in the economy, social activity, and the culture. According to the report published by the World Travel & Tourism Council, the tourism industry generates 10.3% of the global GDP, which translates to 8.9 billion American dollars [16].

One of the reasons for post-industrial area utilization in tourism has contributed to the development of industrial tourism. It targets traveling, in which destination is determined by the cultural value of specific sites. This type of tourism encompasses not only heritage sites, but also contemporary landmarks. Revitalized post-industrial facilities blend in perfectly with the latest trends of today's travelers who visit and search for new cultural experiences. Constant growth and promotion of industrial tourism is one of the priorities in the Polish tourism economy; it results from the fact that post-industrial facilities can play an important role in tourism as revitalized objects. Attention should primarily be paid to the way these facilities are developed in terms of attractiveness, education, and entertainment. Such activities allow the degraded, abandoned areas to breathe a new life into towns and regions, thus contributing to the development of society and improvement of culture. It has a positive impact on the locations and the level of their residents' satisfaction. These activities are part of sustainable development and have positive impact on the creation of new business models on the part of the organizations operating in the tourism industry [11,17–20].

2.2. The Process of Post-Industrial Facility Restructuring in the Light of the Law

The problem of post-industrial facility and area development can be recognized as a common issue. Such areas and objects can frequently be distinguished by the attractive location and infrastructure, preserved at varying levels. Studies and analyses have led to the development of practical tools, which are focused on post-industrial area restructuring. These tools include proper organizational structures, legal regulations, procedures, and model projects [14,21,22].

The solutions implemented proved to be necessary for ensuring reasonable, compliant with the principle of sustainable development, implementation of the activities carried out in these areas, which places emphasis—first of all—on natural protection and fulfilment of the present generations' aspirations, keeping in mind the future generations, through efficient utilization of natural resources, e.g., energy savings and reduction of environmental pollution [23,24].

Under the Polish law, the first document regulating the issues related to brownfield land is the government program for post-industrial areas, passed by the Council of Ministers on 27 April 2004. The program mainly aimed to determine the conditions and mechanisms used for the development of post-industrial areas, maintaining the principles of sustainable development [25,26].

The act on revitalization (Journal of Laws 2015, art. 1777), which was passed on 9 October 2015 is the first Polish regulation focused on this issue. Brownfield land and post-industrial facilities were incorporated into revitalization areas. It results from the fact that development thereof will contribute to the prevention of negative social phenomena. Economic phenomena include the fact that local business is in bad shape and the quality of environment poses serious threats to people [27].

Analyzing the legal acts that are currently in force in Poland, it can be concluded that revitalization activity in post-industrial areas requires specific conditions. One of the most important conditions entails assurance that a post-industrial area, as a result of restructuring, solves the social problems mentioned in art. 9 sec. 1 items 1–4 of the act on revitalization [27].

2.3. Utilization of Business Models

Business models have been known in foreign and Polish literature on the subject for more than several decades [28,29]. The significance of business models in contemporary business can be characterized by the clear difference existing between management practitioners and theoreticians [30].

In Polish literature, different definitions of business model can be found [31]. T. Falencikowski characterizes business model as a “relatively isolated, compound conceptual object, describing the running of business through articulation of the logic of creating values for customer and interception of part of this value for an enterprise” [32]. P. Timmers, on the other hand, defines business model as product, service, and information flow architecture, including a description of the various business actors; and a description of the sources of revenues [33]. D. Teece claims that business model is a tool used to design a mechanism for creation, delivery, and value capturing for customer purposes [34].

One of the main tasks of business models entails description of business, explaining how a given company works and the ways to develop competitive advantage on the market [35]. It additionally describes the relations between the organization's components leading to the creation and capture of its value [36]. Business models are flexible and have to be adjusted to the changes that take place in markets, the innovations, and the legal frameworks. Business model is regarded as a way of building business and adding value for its customers [37].

Business models are complex—they consist of many models, which incorporate a range of activities in an organization, starting from the organization as a whole, and ending with models of individual business units, products, or processes [38–40].

It should be noted that in the source literature, business models for regional products consist of entry and exit conditions, quality standards, and mechanisms for control and improvement. They additionally should clearly identify the social, image-related and financial benefits, specifying their financing [41].

Currently, one of the most serious threats resulting from tourism is the burdens caused by overtourism. Creation of business models, which combine sustainable development and value for businesses is therefore important [42]. Such business models can constitute a significant source of competitive advantage, generating many economic benefits [36]. Nowadays, owing to their affordability and versatility, business models are used in an increasingly higher number of industries, i.e., in industrial, food, tourist, energy, and other enterprises [43].

Development of new business models in tourism allows for the generation and maximization of profits [44]. One reason for this is the development of information technology, which owing to its mobility can transform the tourism market not only in Poland, but also globally. Moreover, the information technology progress has contributed to increased competitiveness of the companies operating on the tourist market [45].

Companies operating in the tourism industry, wanting to create a business model, should keep in mind that it is supposed to reflect the mechanisms of the activities that contribute to the achievement of their targets [46]. One important aspect is the ability to modify business models. Frequently, this ability is perceived as a precondition for dealing with changes that can result from the surrounding as a consequence of an economic decline or due to the permanent transitions of the market in terms of supply and demand [47].

2.4. Industrial Tourist Trail as a Model of Sustainable Tourism

Utilization of post-industrial facilities is part of sustainable tourism. According to the European Commission, sustainable tourism is tourism that is economically and socially profitable, not affecting the environment and the local culture [48]. The concept of sustainable tourism was developed along with the implementation of sustainable development [49,50]. During the conference dedicated to sustainable tourism in 1995, the Charter for Suitable Tourism was adopted, which was accepted by the biggest international organizations, such as the World Tourism Organization, the United Nations Environment Program, UNECSO, and the European Commission [51].

Sustainable tourism became part of the New Urban Agenda as one of the sectors that can have significant impact on the development of urban economy and the creation of new, high quality jobs. The significant growth of industrial tourism can be associated with various activities that not only are focused on tourist traffic stimulation, but above all have a positive impact on the economy, the life of the local people, helping avoid the negative effects of overtourism in urban space, paving the path toward sustainable development of tourist initiatives, which is beneficial for both the tourists and the residents [52]. Creation of themed tourist trails incorporating post-industrial facilities, is therefore a positive undertaking, from the perspective of sustainable tourism and economy.

The idea of themed trails emerged from the dynamic development of industrial tourism, which utilizes brownfield land and post-industrial facilities [53]. One of the biggest themed trails operating across Europe is the European Route of Industrial Heritage (ERIH). In Poland, there are ten trails of this type, which are part of the European Route of Industrial Heritage [54,55].

It should be noted that the ERIH does not encompass all the trails. We should therefore pay special attention to the trails that are not part of this European giant with regard to the post-industrial facility aspect, the cultural trails in Poland can be divided into two types. The first type comprises trails with post-industrial facilities featuring several industrial heritage landmarks. Another type consists of industrial trails dedicated fully to industrial heritage. Currently, in Poland, there are about 600 cultural trails, 7% of which are industrial trails [56]. The TeH₂O Water, Industry and Craft Trail in Bydgoszcz belongs in this group of trails.

The intertwining of history, industry, and environmental protection gave rise to the development of a regional business model. The TeH₂O Water, Industry and Craft Trail in Bydgoszcz combines public buildings with private property. A business partnership exists between the tourist route facilities and the numerous facilities within the infrastructure surrounding the route. This, among others, promotes the trail and results in the improvement of the functioning of the local economy. The trail is multi-productive, which means that tourists can use many products or services. Such a combination improves the local economy and promotes the trail. Existence of business partnership fosters the competitive advantage of the tourist region and facilitates the development of enterprises that are able to cooperate within such a network. Owing to the development of the business model, the effectiveness of advertisement and promotion cost minimization, in relation to the trail objects and locations, has improved. Access to information on the building of a position in the market improved, along with the ability to make decisions faster. Development of a business model that brings together post-industrial facilities enabled funding from the previously mentioned international SHIFT-X project co-financed by the European Regional Development Fund. A network of entrepreneurs emerges around the trail. The building of a business model facilitated acquisition of new knowledge-sharing skills pertaining to the ability of finding best solutions in case of problems. The business model also increased the innovation capacity of the trail participants. As a result, it is possible to create innovative industrial heritage products. The products associated with the business model developed include, among others: organization and coordination of tourist services (sightseeing, organization of tours), the monitoring of the route and facility markings, promotion of the trail and its facilities, updating and distribution of information about the trail, distribution of various materials about the trail, initiation and coordination of thematic products for tourists, sale of own services, etc. The TeH₂O thematic trail addresses its offer both to the inhabitants of Bydgoszcz and the tourists, the passers-by who decided to visit the city. The customers who have decided to take advantage of the thematic trail offer can, first of all, learn about the people and the events in the industrial heyday of Bydgoszcz. The visitors can additionally take advantage of the following: a single entry ticket to many facilities, a system of discounts (e.g., for workshops) for the recipients visiting more than one facility, discounts on the services provided by the facilities/entities in the vicinity of the trail, co-creation of offers for business (company meetings, integration events, etc.). TeH₂O thematic trail intends to acquire new partners in the coming years (new facilities on the route, new facilities/accompanying entities), but above all, to acquire new key foreign partners for the development. Development of an offer for new groups of recipients (foreign tourists) is one of the key elements of a long-term strategy. The development strategy additionally includes continuous emergence of new products offered as part of the trail [7,43,57,58]. It is worth adding, that some regions were not very popular among tourists, but their inclusion in the trail has become one of the main development factors for those locations.

3. Materials and Methods

The study used both secondary and primary data sources. The first part of the research entailed a survey carried out via free online questionnaire tools. The target survey group involved two sets of respondents—the residents of the city of Bydgoszcz and the tourists visiting Bydgoszcz.

The subject scope of the study encompassed Bydgoszcz as a tourist destination, in particular the TeH₂O Water, Industry and Craft Trail. The time frame was 2015–2019. The study of primary sources was carried out in 2019.

The questionnaire was made available on social media—i.e., Facebook, associating the biggest group of Bydgoszcz residents, as well as on theme groups addressing tourism and sightseeing. The Facebook groups—My (Our) Bydgoszcz, Bydgoszcz Fordon, Bydgoszczanie, Bydgoszczanki, Tourism, Must-See Historic Sites, and various groups associated with specific neighborhoods of the city.

The study entailed a non-random sample selection, i.e., the purposeful selection method was used. The research was divided into two parts. The first part involved a survey carried out among the residents of Bydgoszcz, whereas the second part involved a survey carried out among the tourists visiting Bydgoszcz. The survey time range was set at one month. After the data collection stage was completed, the authors acknowledged the number of the survey questionnaires received as appropriate for the first part of the analysis and enabling verification of the research assumptions. During the data reduction stage, none of the questionnaires received was rejected. Total of 212 people took part in the first part of the study. In the second part of the study, the population was 208 persons. The total number of the respondents was thus estimated at 420 persons. Table 1 shows the structure of the research sample.

Table 1. Research sample.

Gender	Bydgoszcz Residents	Bydgoszcz Visitors
Female	147	112
Male	65	96
Total	212	208

The questionnaire consisted of 16 questions. Ultimately, the questionnaire included an imprint with questions about gender, age, education, and employment status. In the category of closed questions, the authors offered multiple selections of answers and a frequency scale of certain phenomena. The questionnaire concerned the assessment of the city's tourist attractiveness and industrial tourism, taking into consideration the assessment of a number of aspects related to the examined TeH₂O Water, Industry and Craft Trail in Bydgoszcz.

Analysis of the questionnaire results was preceded by a description of Bydgoszcz tourism. Figure 1 presents the statistical indexes of the tourist traffic in Bydgoszcz. The information on to the number of tourists visiting Bydgoszcz was published by the Bydgoszcz Information Center [20,59–62]. The number of tourists in Bydgoszcz over the past five years was increasing systematically. Such factors as improvement of the hotel service quality as well as the increased number of beds and tourist facilities have most likely contributed to the growing number of tourists. Additionally, in the period described, new flights were added to the schedule of the Bydgoszcz Airport, thus affecting the increased number of the tourists coming from abroad.

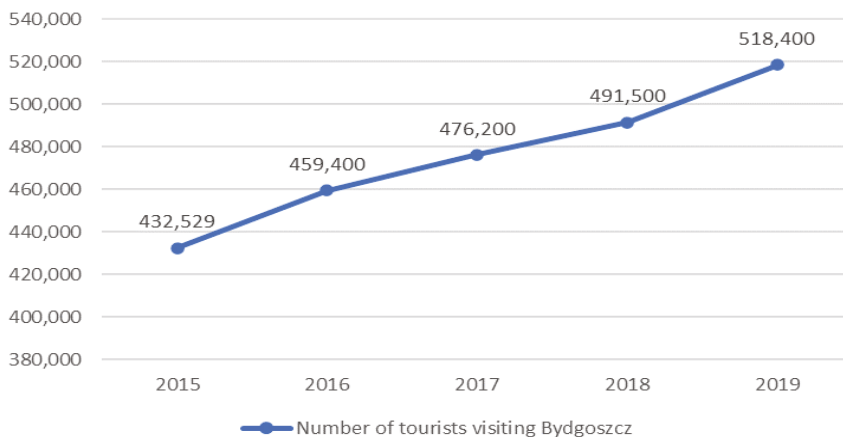

Figure 1. Number of tourists visiting Bydgoszcz in 2015–2019.

The survey participants represented various employment groups and different levels of education. Table 2 shows the sample structure in employment distribution. Among the respondents from Bydgoszcz, the biggest group comprised white-collar (office) workers, whereas the unemployed constituted the smallest group.

Table 2. Structure of the sample acc. to: employment groups of those polled.

Professional Status	Bydgoszcz Residents	% Share	Bydgoszcz Visitors	% Share
Office worker	112	52.8	44	21.2
Manual worker	33	15.6	41	19.7
Student	16	7.5	64	30.8
Pensioner	23	10.8	19	9.1
Unemployed	8	3.8	12	5.8
Entrepreneur	20	9.5	28	13.5

The most diverse group of the surveyed consisted of the tourists visiting Bydgoszcz. The biggest groups included students, white-collar workers, and blue-collar (manual) workers. Just like in the case of residents, the unemployed constituted the smallest group. The survey result comparison is presented in Table 2.

The greatest share of the surveyed, in age distribution, i.e., both the residents of Bydgoszcz and the visitors, was the group of people aged 21 to 30. The results are shown in Table 3. Because of the educational nature of post-industrial tourism, the authors considered the large share of this group purposeful and appropriate for the assessment of the phenomenon under examination.

Table 3. Sample structure in age distribution.

Age	Bydgoszcz Residents	% Share	Bydgoszcz Visitors	% Share
Under 20	11	5.2	14	6.7
21–30	60	28.3	110	52.9
31–40	55	25.9	35	16.8
41–50	42	19.8	25	12
51+	44	20.8	24	11.6

The next stage of the study entailed an in-depth interview with the Coordinator of the TeH₂O Water, Industry and Craft Trail in Bydgoszcz. Because of spread of the COVID-19 pandemic, the interview was carried out remotely. At the request of the Coordinator of the TeH₂O Water, Industry and Craft Trail, all questions were sent by e-mail. The authors of the study also used secondary sources, most important of which was the report on the tourist traffic in Bydgoszcz in 2015–2019, prepared by Leszek Woźniak and the Bydgoszcz Information Center and made available by the City of Bydgoszcz—Bydgoszcz Information Center.

4. Empirical Study Results

The non-resident (visitor) respondents were asked if they have visited the city or plan to do so in the coming year. Based on the study, it has been found that 177 survey participants (85%) had visited the city of Bydgoszcz. Whereas 93 survey participants (4.7%) intended to do so, and 75 (36.1%) did not express their opinion on this matter.

Additionally, they were asked about the purpose of their trips to Bydgoszcz. Figure 2 presents their answers.

The respondents from the city of Bydgoszcz stated that the city is touristically attractive. Such an opinion was expressed by 97 respondents (45.8%). The visiting respondents shared a similar opinion. This opinion was expressed by 81 respondents (38.9%). Table 4

presents the detailed results of the Bydgoszcz tourist attractiveness assessment expressed by the respondents.

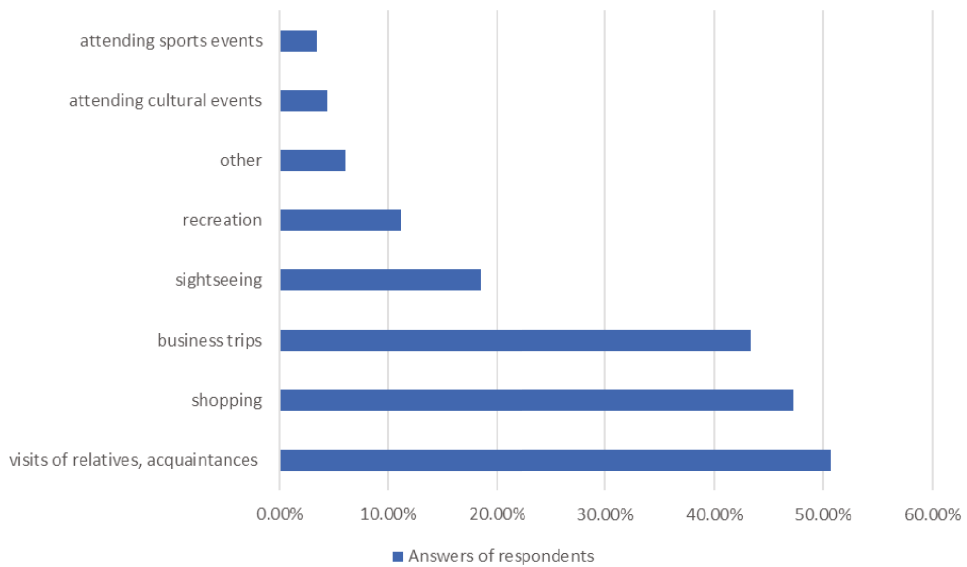

Figure 2. Purpose of trip to Bydgoszcz.

Table 4. Assessment of the city of Bydgoszcz tourist attractiveness.

Assessment	Bydgoszcz Residents	% Share	Bydgoszcz Visitors	% Share
Yes	97	45.8	81	38.9
Rather yes	61	28.8	84	40.4
No	29	11.7	12	14.9
Hard to tell	25	13.7	31	5.8
Size	212	-	208	-
Average	1.556604	-	1.899038	-
Standard deviation	1.049308	-	1.009328	-
SEM mean	0.072067	-	0.069984	-

During the research, the respondents were asked about the knowledge of the TeH₂O industrial trial. Out of the city of Bydgoszcz inhabitants, as many as 60.4%, i.e., 128 respondents, stated that they have heard about this route, while 34.9%, i.e., 71 respondents, were not familiar with what the trial analyzed was, and 4.7%, i.e., 10 respondents, were unable to indicate any answer. The results were similar in the case of the question addressing the fact of visiting an industrial trial object. These results are as follows: 60.4%, i.e., 128 resident respondents had visited a trail facility, 23.1%, i.e., 49 respondents, had not, while 16.5%, i.e., 35 respondents, were unable to indicate whether they had visited any of the facilities of the industrial trial.

The visiting (non-resident) respondents' answers to same question were as follows: 72.6% have never heard about the TeH₂O Industrial Trail, 16.8% are familiar with it, and 10.6% did not provide any answer. The visitors' answers to the question regarding visiting any of the sites on the Industrial Trail can be summarized as follows: 54.8% have not visited

any of the sites, 13.9% visited one of the sites, and as much as 31.3% were not able to state if they have visited any of the sites.

The surveyed were asked to provide their opinion on the share of the TeH₂O Industrial Trail in the assessment of the city's attractiveness. The answers provided ranged from 1 to 6, where 1 indicated the smallest share and 6 the greatest. Table 5 presents the assessment results for both groups of the respondents.

The respondents were then asked about their assessment of industrial tourism. They were to mark their opinion of industrial tourism on a 5-point scale, where 1 meant completely unattractive, and 5 very attractive. The full range of the answers provided is shown in Table 6.

Table 5. Assessment of the TeH₂O trial's role in the perception of the city of Bydgoszcz attractiveness (6 is the highest and 1 is the lowest).

Assessment	Bydgoszcz Residents	% Share	Bydgoszcz Visitors	% Share
1	2	1.1	2	0.8
2	4	2.1	2	0.8
3	30	14.2	6	3.1
4	52	24.7	35	16.7
5	67	31.6	96	46.5
6	57	26.3	67	32.1

Table 6. Assessment of industrial tourism's attractiveness (5 is the highest, 1 is the lowest).

Assessment	Bydgoszcz Residents	% Share	Bydgoszcz Visitors	% Share
1	2	1.1	2	1
2	13	5.8	15	7.2
3	31	14.2	47	22.6
4	91	43.2	47	22.6
5	75	35.7	97	46.6
Size	212	-	208	-
Average	4.056604	-	4.047308	-
Standard deviation	0.911539	-	1.033398	-
SEM mean	0.062604	-	0.071653	-

The figure below (Figure 3) shows assessment of the development of post-industrial facilities on the TeH₂O Trail.

The questions contained in the in-depth interview addressed assessment of the city's attractiveness, its industrial tourism and the share of the Water, Industry and Craft Trail in this scope. Other issues that were discussed included the establishment of the TeH₂O Trail as well as the source of and the purpose behind this undertaking. Information on the attendance, the marketing strategies and the economy was included as well.

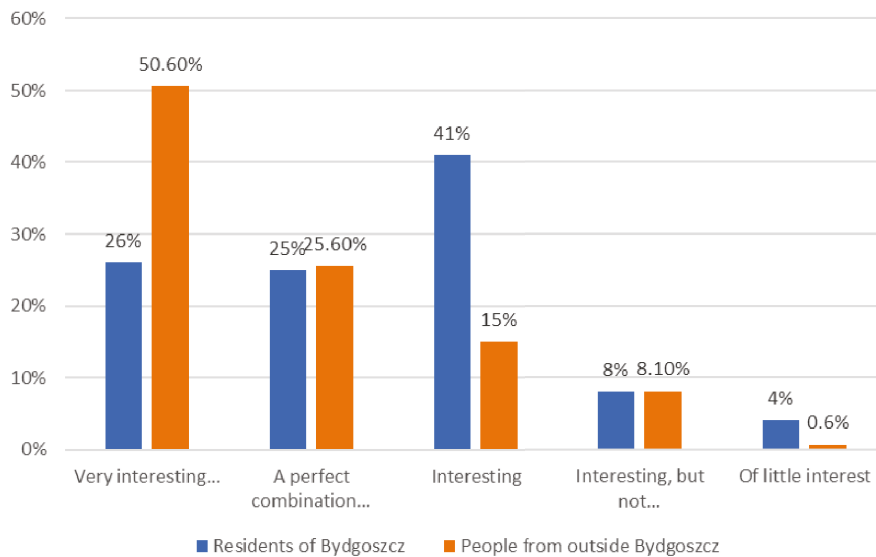

Figure 3. Assessment of the development of post-industrial facilities on the TeH₂O Trail.

In the coordinator's opinion, based on the survey answers obtained, the city's attractiveness has significantly increased when it began to be associated with the TeH₂O Water, Industry and Craft Trail. The residents' awareness of the industrial value of Bydgoszcz was very important as well. Development of post-industrial facilities for tourist purposes has breathed new life into those sites, allowing the history of these sites to be presented, thus reaching a wide group of its offer recipients. The Coordinator of the TeH₂O Water, Industry and Craft Trail stated that industrial tourism is a perfect answer to the tourists' ever increasing demand for new experiences. It mainly results from the fact that such tourism combines the function of sightseeing with the knowledge of the world, the familiarization with technology and production processes, as well as the history of these sites, facilities, and societies. Some of the reasons that led to the establishment of the Trail include the need for protection and promotion of the industrial heritage of Bydgoszcz, the strive for increased awareness among the residents and the administrators of post-industrial facilities. The Coordinator of the TeH₂O Water, Industry and Craft Trail also stated that the idea of the TeH₂O Trail is based on the assumption that technology does not exist without the man. The Coordinator mentioned that annually the Trail reports about 100–150,000 entries, with a steady growth in the trend. She also emphasized the difficulty in the estimation of the number of the people who are aware of the Trail's existence and choose recreation on the Młyńska Island or the Bydgoszcz Canal. The city's residents account for a significant share among the Trail visitors.

5. Discussion and Conclusions

The article presents an example of restructured areas and facilities affected by past industrial activity. The laws and regulations in force allow restructuring of post-industrial facilities for tourism-related purposes. It should be mentioned, however, that every post-industrial area exhibits different features, which result from many variables, e.g., the type of the industrial activity conducted in the past, its location, the society's needs, the degradation level of the facility, and/or the area and the surrounding environment, the administrative authority's prospects, as well as the feasibility of investment plans.

The authors described the laws and regulations pertaining to the changes indicated as well as examples of development, in relation to the facilities and areas that meet specific

social problems. The current state of this issue in Poland has been presented as well. Other key topics include description of post-industrial area utilization for tourism purposes and the role of industrial tourist trails as an example of business model.

The study and the literature analysis allowed the research objective to be achieved. Development of post-industrial facilities for tourist purposes is an attractive form of tourism, which results from the information obtained via numerous references, statistics, and the research addressing topic. More than 60% of the respondents residing in Bydgoszcz have visited the post-industrial facilities located on the TeH₂O Trail. Their assessment of the attractiveness this type of tourism offers, 43% of the surveyed selected answers 4/5, and 36% of the respondents selected answer 5, where on the 5-point scale, 1 meant completely unattractive, and 5 very attractive. The non-resident respondents have also visited the TeH₂O Industrial Trail sites, but only at a 13.9% rate.

The method of post-industrial object development on the TeH₂O Water, Industry and Craft Trail in Bydgoszcz has been assessed as well. Also in this case vast majority's opinion was positive. The respondents assessed that it is an example of a very interesting post-industrial area utilization; this opinion was expressed by 26% of the resident respondents and 50.6% of the non-resident (visiting) respondents. Moreover, 41% of the respondents from Bydgoszcz answered that the Trail embodies an interesting form of post-industrial facility development. Conversely, 25.6% of the non-resident respondents recognize that the Trail constitutes a perfect combination of technology, history, and spatial development. The development of industrial tourism had also a positive impact on the improvement of the environment. Thematic routes are a perfect example of how post-industrial facilities can be used in a sustainable way, which fits with the canons of sustainable tourism.

The authors of the article did not find results similar to the research conducted. The authors searched such databases as: Google Scholar, BazEkon, Scopus, etc. No similar publications addressing to the research field that would allow comparison of the results with the hypothesis and objectives set at the beginning of the study have been found. The lack of similar studies may result from the fact that industrial tourism, and in particular tourist routes, have only gained popularity in the recent years. It is therefore necessary to indicate the need for research in this area.

The research conducted in 2018 by Zawadka et al. [63] on the popularity of the tourist routes located in the rural areas of the Podlasie and Masovian voivodeships shows familiarity and the popularity of this type of tourist routes is low. The most famous trail is the Chopin Trail (Chopin's Mazovia). The authors indicate that, on average, over half of the respondents were not aware of the existence of the routes analyzed. These routes are known to the persons residing in the vicinity of those objects. The lack of familiarity with the routes analyzed may result from poorly implemented promotional activities that were aimed at popularization of such tourist attractions.

A research conducted by Krzysztof Widawski et al. [55] on the tourist attractiveness of the objects making up the Land Flowing with Milk and Honey trail indicates that only one of the 22 sites analyzed is of low attractiveness.

Nevertheless, the research carried out by the above-mentioned authors does not specify how the thematic routes examined affect the attractiveness of the places in which they are located. It is therefore important to take the problem identified in the research into account.

Based on the research carried out and the authors' observations, several conclusions can be drawn:

1. Development of post-industrial facilities for the purpose of industrial tourism has become an increasingly popular solution, aimed at attracting a growing number of recipients. The research allowed a conclusion that development of post-industrial facilities significantly improves city attractiveness, thus contributing to the promotional activities of these cities and regions. As such, the cities that had once been known for their industry, later degraded and forgotten, now can rebuild their identity and show their history.

2. The TeH₂O Water, Industry and Craft Trail in Bydgoszcz has had considerable impact on the increase of the city's attractiveness. The Trail has become a tourist destination for both the residents of the city of Bydgoszcz and the visitors. Owing to the inflow of tourists in the past years, the TeH₂O Trail can be popularized both domestically as well as in Europe.
3. The TeH₂O Water, Industry and Craft Trail in Bydgoszcz offers great potential for the region, which when properly utilized can bring measurable benefits. Among the benefits arising from the TeH₂O Trail there are economic advantages, including the profits generated by specific landmarks located on the Trail as well as the general hospitality of the services situated in the proximity of the Trail, i.e., hotels, restaurants, souvenir shops, etc., prevail. It should be noted that industrial tourist trails improve the competitive position of any region. They also strengthen the social, economic, cultural, and spatial ties within their area.
4. This significant increase in the popularity of industrial tourism in Poland requires proper adjustment of the industrial heritage and the sightseeing packages are presented. It is important that such offers are addressed to individual tourists, groups of tourists, and tour operators. It is also necessary to develop a clear, easily available landmark information system that would provide details on the sites to be visited and the themed trails operating in Poland. Moreover, such landmarks should be better promoted in mass media. This problem can thus be solved by the development of a business model that would entail utilization of resources, i.e., the components comprising a themed trail, via an online service, which would serve as a tool allowing the tourists to create their own itinerary, adjusted to their needs and providing many other functionalities.
5. According to the studies conducted by the authors, the TeH₂O Industrial Trail is better known among the residents of the city of Bydgoszcz than the visitors (non-residents). This may result from the fact that the Trail is insufficiently advertised outside Bydgoszcz. It also should be mentioned that many people visiting sites of the TeH₂O Industrial Trail were not aware that specific landmarks are part of this Trail.

The city of Bydgoszcz is a place where industrial history plays a very important role. Many post-industrial buildings can be found there which set the city's rhythm. This is one of the reasons why the authors of the article engaged in the topic of business models preserving the historical value of the city. The design of such models, which are based on post-industrial facility development, is a perfect example of activities that are aimed at monument protection and simultaneous creation of business ties between the trail participants.

The authors of this article are aware that the study does not provide representative results and the data received cannot be generalized onto the entire population. Nevertheless, the results of this study can serve as a foundation for in-depth research in this field.

It thus rightly concluded that development of post-industrial facilities for tourism purposes, by establishment of a themed tourist route, such as the TeH₂O Water, Industry and Craft Trail in Bydgoszcz for instance, is a just, needed, and attractive solution. Utilization of post-industrial facilities generates measurable benefits, not only in economic or social, but also in ecological terms.

Author Contributions: Methodology M.J. and P.S.; writing—original draft M.J. and P.S.; writing—review and editing M.J. All authors have read and agreed to the published version of the manuscript.

Funding: This research received no external funding.

Institutional Review Board Statement: Not applicable.

Informed Consent Statement: Not applicable.

Data Availability Statement: Data available in a publicly accessible repository that does not issue DOIs.

Acknowledgments: The authors of the article would like to thank the head of the Department of Organizational Innovation Management—Habil. Iwona Posadzińska, associate professor, for support and assistance in the preparation of the article. The authors of the article would like to thank Puchowska, The Coordinator of the TeH₂O Water, Industry and Craft Trail for participation in an interview in these difficult times of the COVID-19 pandemic.

Conflicts of Interest: The authors declare no conflict of interest.

References

- Sala, K. Praktyczne wykorzystanie i współczesne znaczenie obiektów poprzemysłowych w Polsce na przykładzie hoteli loftowych. *Pr. Kom. Geogr. Przem. Pol. Tow. Geogr.* **2020**, *34*, 167–178. [CrossRef]
- Szromek, A.R.; Herman, K. A business creation in post-industrial tourism objects: Case of the industrial monuments route. *Sustainability* **2019**, *11*, 1451. [CrossRef]
- Naramski, M.; Herman, K. The development of mobile tourism in the upper silesian metropolitan area of Poland. *Sustainability* **2020**, *12*, 44. [CrossRef]
- Bujok, P.; Klempa, M.; Jelinek, J.; Porzer, M.; Rodríguez Gonzalez, M.A.G. Industrial tourism in the context of the industrial heritage. *Geoj. Tour. Geosites* **2015**, *15*, 81–93.
- Martinat, S.; Navratil, J.; Hollander, J.B.; Trojan, J.; Klapka, P.; Klusacek, P.; Kalok, D. Re-reuse of regenerated brownfields: Lessons from an Eastern European post-industrial city. *J. Clean. Prod.* **2018**, *188*, 536–545. [CrossRef]
- Szlak Wody Przemysłu i Rzemiosła TeH₂O w Bydgoszczy—Przewodnik, 2015. Available online: https://issuu.com/visitbydgoszcz/docs/przewodnik_teh2o.compressed (accessed on 14 December 2020). (In Polish)
- Locativo Sp. z o.o. *Koncepcja Zarządzania Dziedzictwem Poprzez Utworzenie Szlaku Kulturowego o Tematyce Przemysłowej: Część 3; Zarządzanie Szlakiem*: Kraków, Poland, 2014. (In Polish)
- Lamparska, M. Post-mining tourism in Upper Silesia and Czech-Moravian country. *J. Geogr. Politics Soc.* **2019**, *9*, 57–68. [CrossRef]
- Domański, B. Restrukturyzacja terenów poprzemysłowych w miastach. In *Rewitalizacja, Rehabilitacja i Restrukturyzacja—Odnowa Miast*; Instytut Gospodarki Przestrzennej i Komunalnej: Krakow, Poland, 2000; ISBN 8386847905. (In Polish)
- Denis, M. Tereny poprzemysłowe w dobie zrównoważonego rozwoju. *Stud. Miej.* **2017**, *26*, 25–37. [CrossRef]
- Samuil, I.; Caramidaru, I.; Ionica, A. The Emergence of Industrial Tourism in Post-Mining Closure Areas—Project Management Models and Local Practices. *MATEC Web Conf.* **2020**, *305*, 00077. [CrossRef]
- Alexandrescu, F.; Martinat, S.; Klusáček, P.; Bartke, S. The Path from Passivity Toward Entrepreneurship. *Organ. Environ.* **2014**, *27*, 181–201. [CrossRef]
- Glumac, B.; Han, Q.; Schaefer, W.F. Actors' Preferences in the Redevelopment of Brownfield: Latent Class Model. *J. Urban Plan. Dev.* **2015**, *141*, 04014017. [CrossRef]
- Gasidło, K. Przekształcenia terenów poprzemysłowych—Efekty i perspektywy badań i działań. *Probl. Ekol.* **2008**, *R. 12*, 76–80.
- Pardo Abad, C.J. The post-industrial landscapes of Riotinto and Almadén, Spain: Scenic value, heritage and sustainable tourism. *J. Herit. Tour.* **2017**, *12*, 331–346. [CrossRef]
- World Travel. Tourism Council Travel and Tourism. Global Economic Impact & Trends. 2020. Available online: <https://wtcc.org/Research/Economic-Impact/moduleId/1445/itemId/91/controller/DownloadRequest/action/QuickDownload> (accessed on 14 December 2020).
- Klempa, M.; Bujok, P.; Porzer, M.; Skupien, P. Industrial complexes and their role in industrial tourism—Example of conversion. *Geosci. Eng.* **2016**, *62*, 45–50. [CrossRef]
- Xie, P.F. A life cycle model of industrial heritage development. *Ann. Tour. Res.* **2015**, *55*, 141–154. [CrossRef]
- Staszewska, A.; Żemla, M. The Industrial Monuments Route of the Silesian Voivodeship as an example of the regional tourism product enhancing tourism competitiveness of the region. *Czech. J. Tour.* **2013**, *2*, 37–53. [CrossRef]
- Woźniak, L.; Brudnicki, R. *Badanie Ruchu Turystycznego w Bydgoszczy w 2019 Roku*; Bydgoskie Centrum Informacji: Bydgoszcz, Poland, 2019. Available online: https://visitbydgoszcz.pl/images/do_pobrania/badania/Turystyka_w_Bydgoszczy_w_roku_2019.pdf (accessed on 14 December 2020). (In Polish)
- Venu, V.; Goodwin, H. The Kerala Declaration on responsible tourism. In Proceedings of the Incredible India, Second International Conference on Responsible Tourism in Destinations, Kochi, India, 21–24 March 2008.
- Franklin, A.; Kovách, I.; Csurgó, B. Governing Social Innovation: Exploring the Role of 'Discretionary Practice' in the Negotiation of Shared Spaces of Community Food Growing. *Sociol. Rural.* **2017**, *57*, 439–458. [CrossRef]
- Buiok, P.; Rodriguez, M.A.; Klempa, M.; Jelinek, Y.; Porzer, M. Industrial Tourism and the Sustainability of the Development of Tourism Business. *Tour. Educ. Stud. Pract.* **2014**, *3*, 88–97. [CrossRef]
- Hwang, D.; Stewart, W.P.; Ko, D. Community Behavior and Sustainable Rural Tourism Development. *J. Travel Res.* **2012**, *51*, 328–341. [CrossRef]
- Maciejewska, A.; Turek, A. Rewitalizacja i jej znaczenie w kontekście realizacji polityki przestrzennej na terenie województwa mazowieckiego. *Maz. Stud. Reg.* **2018**, 71–89. [CrossRef]
- Rall, E.L.; Haase, D. Creative intervention in a dynamic city: A sustainability assessment of an interim use strategy for brownfields in Leipzig, Germany. *Landsc. Urban Plan.* **2011**, *100*, 189–201. [CrossRef]

27. Dziennik Ustaw Rzeczypospolitej Polskiej. *Ustawa z Dnia 9 Października 2015 r. o Rewitalizacji*; SEJM: Warsaw, Poland, 2015; pp. 1–20. (In Polish)
28. Amit, R.; Zott, C. Value creation in E-business. *Strateg. Manag. J.* **2001**, *22*, 493–520. [[CrossRef](#)]
29. Mičieta, B.; Biňasová, V.; Kasajová, M.; Howaniec, H. Business Model Canvas as a Tool of Manager 4.0. *Zesz. Nauk. Wyższej Szk. Humanit. Zarządzanie* **2020**, *21*, 51–64. [[CrossRef](#)]
30. Mazurek, J.; Kułakowski, K. Satisfaction of the condition of order preservation: A simulation study. *Oper. Res. Decis.* **2020**, *30*, 77–89. [[CrossRef](#)]
31. Malara, Z.; Paweł, Z. Information Gap in Value Propositions of Business Models of Language Schools. *Oper. Res. Decis.* **2020**, *30*, 59–76. [[CrossRef](#)]
32. Falencikowski, T. Strategia a model biznesu—Pi różnice. *Pr. Nauk. Uniw. Ekon. Wrocławiu* **2012**, *260*, 80–93.
33. Timmers, P. Business Models for Electronic Markets. *Electron. Mark.* **1998**, *8*, 3–8. [[CrossRef](#)]
34. Teece, D.J. Business models and dynamic capabilities. *Long Range Plan.* **2018**, *51*, 40–49. [[CrossRef](#)]
35. Bite, P.; Konczos-Szombathelyi, M. Employer branding concept for small-and medium-sized family firms. *J. Int. Stud.* **2020**, *13*, 143–160. [[CrossRef](#)] [[PubMed](#)]
36. Butler, R.W.; Szromek, A.R. Incorporating the value proposition for society with business models of health tourism enterprises. *Sustainability* **2019**, *11*, 6711. [[CrossRef](#)]
37. Han, J.; Heshmati, A.; Rashidghalam, M. Circular economy business models with a focus on servitization. *Sustainability* **2020**, *12*, 8799. [[CrossRef](#)]
38. Maciąg, J. Modele biznesowe oparte na standardach jakości na przykładzie regionalnych szlaków turystyki kulinarnej. *Stud. Ekon. Uniw. Ekon. Katowicach. Zarządzanie* **2015**, *4*, 45–64.
39. Niedbała, G.; Jęczynek, A.; Steppa, R.; Uglis, J. Linking of Traditional Food and Tourism. The Best Pork of Wielkopolska—Culinary Tourist Trail: A Case Study. *Sustainability* **2020**, *12*, 5344. [[CrossRef](#)]
40. Kleinhempel, S.; Niłtchi, Ş.I.; Rusu, L. Business Process Management in Service-Oriented Companies. *Inform. Econ.* **2010**, *14*, 189–198.
41. Meyer-Cech, K. Regional Cooperation in Rural Theme Trails. In *Rural Tourism and Sustainable Business*; Channel View Publications: Bristol, UK, 2005; pp. 137–148.
42. Dymitrowski, A. Investigations on business model innovation and company’s development. *Ekon. Prawo. Econ. Law* **2020**, *19*, 233–247. [[CrossRef](#)]
43. Kruczek, Z.; Szromek, A.R. The identification of values in business models of tourism enterprises in the context of the phenomenon of overtourism. *Sustainability* **2020**, *12*, 1457. [[CrossRef](#)]
44. Mazurek-Łopacińska, K. Sprzedaż wielokanałowa (omnichannel) w kształtowaniu procesu dystrybucji na rynku konsumpcyjnym. *Przegląd Organ.* **2020**, *5*, 3–10. [[CrossRef](#)]
45. Buhalis, D. *E-Tourism: Information Technology for Strategic Tourism Management*; Pearson Education: Edinburgh, UK, 2003.
46. Kędziera, M. Zmiana modeli biznesowych pod wpływem nowych technologii w sektorze turystycznym. *Stud. Ekon.* **2020**, *391*, 45–56.
47. Kachniewska, M. Turystyka zdrowotna jako determinanta kształtowania nowych modeli biznesowych. *Przedsiębiorczość Zarządzanie* **2019**, *20*, 19–30.
48. Havlíková, M.; Stupková, L.C.; Plišková, L. Evaluation of sustainable tourism potential of the principle Giant Mountains resorts in the Czech Republic. *Environ. Socio-Econ. Stud.* **2019**, *7*, 26–35. [[CrossRef](#)]
49. Sinsin, T.E.M.; Mounir, F.; Aboudi, A. El Conservation, valuation and sustainable development issues of the Argan Tree Biosphere Reserve in Morocco. *Environ. Socio-Econ. Stud.* **2020**, *8*, 28–35. [[CrossRef](#)]
50. Ferreira, A. Between Development and Sustainability: Symbiotic Synergy or Irreconcilable Duality. *Cent. Eur. Rev. Econ. Manag.* **2017**, *1*, 27. [[CrossRef](#)]
51. Mazur-Wierzbička, E. Agritourism as a form of sustainable tourism. *Intercathedra* **2018**, *1*, 45–53.
52. Komorowski, J.; Holderna-Mielcarek, B. Economic and Social Consequences of Mass Tourism in City Management—The Case of Poznań and Wrocław. *Stud. Perieget.* **2019**, *3*, 27–43.
53. Nizioł, A.; Życzynski, N. An increase of the region’s competitiveness through effective tourist product management: An example using the thematic trail. *Humanit. Soc. Sci. Q.* **2020**, *25*, 41–48. [[CrossRef](#)]
54. European Route of Industrial Heritage. Available online: <https://www.erih.net/> (accessed on 14 December 2020).
55. Widawski, K.; Oleśniewicz, P. Thematic Tourist Trails: Sustainability Assessment Methodology. The Case of Land Flowing with Milk and Honey. *Sustainability* **2019**, *11*, 3841. [[CrossRef](#)]
56. Bogacz-Wojtanowska, E.; Gaweł, Ł.; Góral, A. *Szlaki Kulturowe jako Medium Zmian w Kulturze*; Stowarzyszenie Gmin i Powiatów Małopolski: Kraków, Poland, 2016. (In Polish)
57. Argasiński, W. Korzyści z partnerstwa w turystyce (na przykładzie programu marketingowego Karta Tatrzańska). *Handel Wewnętrzny* **2014**, *6*, 157–170.
58. Puczek, L.; Ratz, L. Trailing Goethe, Humbert, and Ulysses; Cultural Routes in Tourism. In *Cultural Tourism, Global and Local Perspectives*; The Haworth Hospitality Press: New York, NY, USA, 2007; pp. 131–148.

59. Brudnicki, R. *Badanie Ruchu Turystycznego w Bydgoszczy w Roku 2016*; Bydgoskie Centrum Informacji: Bydgoszcz, Poland, 2016. Available online: https://visitbydgoszcz.pl/images/do_pobrania/szacunkowa-liczba-turystow-w-bydgoszczy-w-roku-2016.pdf (accessed on 14 December 2020). (In Polish)
60. Brudnicki, R. *Badanie Ruchu Turystycznego w Bydgoszczy w Roku 2015*; Bydgoskie Centrum Informacji: Bydgoszcz, Poland, 2015; pp. 1–66. Available online: https://visitbydgoszcz.pl/images/do_pobrania/Raport_2015.pdf (accessed on 14 December 2020). (In Polish)
61. Woźniak, L.; Brudnicki, R. *Badanie Ruchu Turystycznego w Bydgoszczy w Roku 2017*; Bydgoskie Centrum Informacji: Bydgoszcz, Poland, 2017. Available online: https://visitbydgoszcz.pl/images/do_pobrania/badania/Turystyka-w-Bydgoszczy-w-roku-2017.pdf (accessed on 14 December 2020). (In Polish)
62. Brudnicki, R. *Badanie Ruchu Turystycznego w Bydgoszczy w 2018 Roku*; Bydgoskie Centrum Informacji: Bydgoszcz, Poland, 2019; pp. 1–4. Available online: https://visitbydgoszcz.pl/images/do_pobrania/badania/liczba_turystow_w_Bydgoszczy_w_roku_2018_szacunki.pdf (accessed on 14 December 2020). (In Polish)
63. Zawadka, J.; Pietrzak-Zawadka, J. Tourist Trails as an Element of a Rural Tourist Product and their Popularity among the Inhabitants of Poland. *Ekon. Śr.* **2018**, *3*, 195–207.

Article

The Application of ICT and Smart Technologies in Polish Museums—Towards Smart Tourism

Mateusz Naramski

Department of Economy and Informatics, Faculty of Organization and Management,
Silesian University of Technology, Akademicka 2A, 44-100 Gliwice, Poland; mateusz.naramski@polsl.pl

Received: 1 September 2020; Accepted: 6 November 2020; Published: 9 November 2020

Abstract: The concept of Smart Tourism is rapidly developing alongside Smart Cities, with increasing numbers of ICT solutions being applied for the convenience of travelers as well as for gathering information, which has become a valuable resource. The vast progress in the development of Information Technologies has also impacted the needs and expectations of tourists. However, various branches of tourism are adopting this concept at a different pace, and thus a growing development gap might emerge. Cases from all over the world show that museums are not immune to this, and it is important for their future to meet these expectations. Therefore, the main objective of this study was to investigate the use of modern technologies in Polish museums and assess their readiness for adopting Smart Tourism. For this purpose, a nationwide online survey was conducted with a sample size of 218 museums (from 500 unique entities in total). The results show that the issue of Smart Tourism in Polish museums is ambiguous. The results reveal that, currently, the status of Smart Tourism adoption in museums is quite low, and significant gaps in some areas are shown; at the same time, other areas revealed a high potential for the future application of Smart Tourism.

Keywords: smart tourism; museums; Poland; ICT; smart technologies

1. Introduction

The world that we live in is constantly changing, and as time passes, societies are having to face new challenges. In the last decades, the main challenges have been climate change, urbanization and globalization. As Komnios [1] noticed, the fact that increasing amounts of the world population live in urban areas creates a pressure to create cities that are suited for the needs of future society. This is reflected in how cities are currently being developed and planned, with a strong emphasis being placed on innovation and on intelligent and knowledge-intensive solutions. Urban areas are expected to fully utilize the benefits of the synergies coming from combining the technologies, knowledge and skills found in various societies and organizations. This requires an undisturbed flow of information and knowledge, meaning that adequate (smart) environments and spaces need to be in place and interlinked with each other, creating a complex network of inter-organizational, social, institutional and environmental connections. This need can be seen as the origin of the Smart City paradigm, which has emerged at the turn of the millennium in various sciences.

The concept of Smart Tourism has emerged from the Smart City paradigm and is an essential part of every tourist destination that adopts it. ICTs are the main component of every smart concept [2]. The rapid development of the Internet and the related Information Technologies and innovations affect and reconfigure all sectors of the economy, including tourism, which needs to adapt to the new standards by creating smart, individual offers to technology users [3–8]. As cities increasingly embrace the smartness concept, tourism is also following this path. This sets the expectations and needs of modern tourists at a new level, and museum visitors are not an exception to this. This is because technological progress has not only affected business possibilities but has also impacted the needs

and expectations of tourists, who seek the customization of products and expect to influence product creation [9–13]. In multiple sources, ICTs have been highlighted for their contribution to improving tourists' experiences, providing benefits to the industry and having a positive effect on the quality of life of local communities in tourist destinations [14–17], meaning that Smart Tourism can improve a destination's competitiveness [18]. The main advantages of using technology for tourists are saving time, allowing the better planning of a trip, allowing purchases to be made with satisfying terms and convenient conditions, allowing information to be found at a site and making the travel experience more practical and functional [18–24]. On the other hand, all the traffic, information and digital footprints left by travelers on the Internet form a part of Big Data, which can be analyzed to provide tourist destinations with valuable knowledge on the behavioral patterns, habits and needs of tourists, allowing the creation of more targeted and individualized products with higher sales chances [23,25–29]. Moreover, as a 2020 study by Cuesta-Valiño et al. [30] showed, the smartness concept in tourism can be utilized to tackle issues that expand beyond economic matters by addressing the problems of the cultural differences of travelers and their resulting needs and expectations, making this concept a sustainability domain as well.

The studies on technology use in tourism seem to be perspective-oriented, and an imbalance of studies regarding one perspective in comparison to another can be noticed. In 2019, a team of researchers [31] published a detailed literature review of over 130 papers on the topic of mobile technologies and applications in Smart Tourism published between 2012 and 2017. The main findings showed that most of the research focused on the customer perspective (their attitudes and intentions, their experience and co-creation and their adoption of smartphones for traveling). Very little research was done regarding the provider experience, and when this was considered, the studies focused on ICT solutions on the level of an entire tourist destination or the adoption of particularly selected technologies or mobile applications and the stock market. While tourists benefit from conveniences provided by technological solutions (by offering fast services, more means of reliable communication and streamlined connectivity, trips can be planned more easily and quickly and on more transparent conditions, which increases tourists' satisfaction and allows the providers to better meet the needs and expectations of customers), the same study revealed that stakeholders still do not fully recognize and appreciate the importance of ICTs (foremost, mobile technologies) and the benefits they can provide. This reveals an interesting gap in the field of Smart Tourism research concerning comprehensive studies on entire branches of tourist service providers and their experiences, use histories and attitudes towards technology.

Therefore, the main goal of the present study was to explore this gap regarding the museum branch and recognize the degree to which modern technologies are used in museums across the entire country of Poland. This allows us to determine the readiness of Polish museums to embrace the Smart Tourism concept, or in other words, to show the already existing Smart Tourism potential and expose possible issues that have to be overcome in the future to take advantage to this to the full extent. This also allows us to determine if the previously mentioned statement that stakeholders do not fully recognize and appreciate the potential of ICTs also applies to museums.

2. Smart Tourism and Smart Technologies

2.1. The Smart City Concept

The development of technology and the digitalization of data have impacted most social and economic organizations by introducing the smartness concept. This has improved general quality of life, as well as enhancing economic performance [2]. The Smart City concept grew on this basis, and the improved resource use and pollution reduction resulting from this concept has led to the more focused concepts of the Smart Village, Smart Tourism and finally Smart Tourism Destinations [32,33].

Some researchers [34,35] argue that the term Smart City is an evocative slogan that lacks a precisely defined core. This may lead sometimes to the abuse of this term by governments, politicians or

organizations to realize their agenda by simply labeling it under this term. The same deficiency in the commonly agreed definition of a Smart City often leads to explaining this term rather than using the six distinct characteristics of a Smart City [35–37]:

1. Smart Economy, which is understood as an innovative and flexible economy that is integrated with international markets and that transforms easily.
2. Smart Mobility, which relates to the wide use and access to ICTs, the use of safe and sustainable transportation and local accessibility.
3. Smart Governance, which refers to governance that includes the society in decision-making processes, with transparent systems and accessible public systems. This characteristic relates also to the quality of political strategies.
4. Smart Environment, which refers to low or no pollution, the sustainable use of resources and the attractiveness of the natural environment.
5. Smart Living, which reflects the quality of life in a given city and may be expressed in the availability of cultural and educational services, public safety, the accessibility of tourist attractions, the health of the environment and the unity of society.
6. Smart People, which is understood as the quality of human–social capital, tolerance, flexibility, creativity, participation in social life and the level of cosmopolitanism.

Other researchers have proposed definitions for Smart Cities in the course of their research, taking into account the aspect of the concept that they were analyzing; an example is the work of Valano [35], who concluded that a Smart City (SC) is “an urban imaginary combining the concept of ‘green cities’ with technological futurism and giving a name to techno-centric visions of the city of tomorrow. At the same time, the Smart City is a framework for policies supporting technological and ecological urban transitions, a political technology that is currently spreading across Europe and fertilizing national and local political agendas.” He also named two main dangers that come from this concept, which are shared by other researchers as well [34,38,39]: the first one is that, as with any other new urban vision, the concept requires some degree of restructuring, which eventually leads to the exclusion of some current subjects in favor of others—the same is true for people, where some will benefit at the price of the marginalization of others; the second one is that the SC concept is heavily technologically orientated, reducing the vision of a future city into a technology-centric idea, which may limit the opportunities for possible alternatives that might emerge.

As Battino and Lampreu [2] have noted, the development of smart concepts has to be evened out between cities that have enjoyed the advantage of early digitalization and less-developed areas. Otherwise, the advantages provided by technology will lead to an increasing gap between those areas and intensify the problems of already neglected and depopulating areas [2]. One can assume that the same might apply to tourism from another perspective, namely various tourism branches or sectors. If some sectors, services or branches follow the smart concepts trend and develop towards it, they might overwhelm others that did not keep up with the pace. This might be the case when one tourism sector is dominated by private companies and another is mainly the domain of public entities (such as museums) whose development is less affected by market stimuli such as competition and more dependent on local regulations and funding policies. It is important to keep up with the development pace; otherwise, the underestimation and inactive response to technological opportunities by tourist suppliers will lead to severe consequences [40].

2.2. The Smart Tourism Concept

Smart Tourism, as with the Smart City, is a concept that has many definitions, and researchers approach it differently depending on their field and discipline; however, even if the boundaries may seem blurry sometimes, some characteristics that define the concept can be distinguished [36,41]:

- It uses the Internet and network infrastructure to improve economic effectiveness and introduce policies that support social, cultural and urban growth.

- It emphasizes the creation of attractive business spaces that incorporate social needs in their services.
- It engages high-tech and creative industries.
- It focuses on the relational and social capital in the development of cities.
- It recognizes sustainable development as a strategic aspect of Smart City development.

For this research, Smart Tourism can be defined as a subset of the Smart City concept; as with Smart Cities, its aim is to improve the quality of life of its residents. Smart Tourist Destinations (STD) concentrate on the needs of travelers by improving the functioning of systems, business processes, governments and authorities, as well as other entities from the public and private sectors [42]. Tourists now rely less on travel agencies and organized trips in favor of individually planned tours. The development of the Internet and mobile technologies, as well as the popularization of Smart Tourism, has strengthened and aided this trend. This also affects the habits and expectations of tourists towards destinations, meaning that they support the information sources that modern tourists want to use [43].

The concept of Smart Tourism can be also treated as an evolution of previous technology applications in tourism rather than a completely new concept [44], meaning that Smart Tourism can be seen as a more advanced form of eTourism [45]. Both of these concepts come down to the use of ICTs for development in tourism, but Smart Tourism places more emphasis on collecting, integrating and utilizing data gathered from infrastructure and user devices to provide an improved and more personalized tourism experience [46]. In other words, Smart Tourism is a concept that focuses on turning data and information into knowledge that can be used for the benefits of destinations, residents and tourists [47].

One can go even further, as Buhalis [48] did in one of his recent publications, sharing an interesting vision of how tourism supported by technology can enter a new stage: Ambient Intelligence Tourism (AIT). AIT seems to be the next step in the evolution of tourism (preceded by eTourism and then Smart Tourism) and is driven by a range of technologies: IoT, 5G networks, the Internet of Everything, RFID, mobile devices and smart wearables and their applications, cryptocurrencies, beacon networking, machine learning, artificial intelligence, pervasive computing and gamification. These various technologies contribute to a growing and fast-developing infrastructure that connects all stakeholders. This network provides a fluid and multidimensional interaction between the physical and digital worlds. The AIT is the source of intelligence in current and future tourism ecosystems, making them sensitive but also flexible and adaptive to changes. The future cooperation of stakeholders in tourism seems to be increasingly dependent on technological innovations; at the same time, if those innovations are used adequately, it will make it easier to establish collaboration.

Regardless of the possible development paths, ICTs have introduced significant and inevitable changes to tourism, bringing the business to the realm of online solutions [49], which has enhanced the tourist experience and created new smart travel services (in the forms of various apps and platforms which help users to get information, share opinions, find hotels, restaurants and attractions and to travel through a destination). Simply put, Smart Tourism is the set of all information services surrounding tourists in the touring process (therefore, it is not only limited to the services provided on site while touring, but it also includes the pre and post-tour processes) [50]. It can also be defined as the development process of tourism that incorporates ICT solutions to eTourism and old-style tourism [46,51]. As stated by Pradhan et al. [52], keeping up with changes in technology is a key task for all tourism stakeholders (as well as tourists themselves) because of the rapid change and fast development of information technology.

In conclusion, it is worth noting that there are five crucial components of Smart Tourism [53]: transportation, gastronomy, accommodation, ancillary services and attraction. The basis for a Smart Tourism experience is the whole smart business ecosystem, built on data sharing between stakeholders (especially on the private–public plane). For Smart Tourism to develop all of the mentioned components, it needs to be supported by intelligent services within a Smart City and provide the necessary

functionality for tourists at any time. The reliability of this functionality is directly linked to technological development and ICT application.

2.3. The Role of ICTs in Smart Tourism and for Smart Tourists

As previously stated, Smart Tourism emerged from the combination of tourism and ICT or, as other sources mention, from tourism and smart technologies [54,55]. Smart Tourism can be also considered as an entire ecosystem [55,56] consisting of smart tourists, smart technologies and smart businesses. S. Shen et al. [40] listed different forms of smart technologies that find application in smart tourism, including the following:

- The Internet of Things;
- Cloud computing;
- Artificial intelligence;
- Mobile communication technologies;
- Mobile devices and apps;
- Big Data;
- Virtual reality;
- Augmented reality;
- Intelligent chat robots;
- Wearable devices;
- Beacon networking.

Celdrán-Bernabeu et al. [41] mapped how key technologies and key elements of the touristic system have changed over time, from traditional tourism and through eTourism to today's Smart Tourism concept. Regarding key technologies, computer servers dominated in the era between the 1950s and 1990s. After this, eTourism emerged on the basis of the rapid development of web technologies and the increasing availability of the Internet. This laid ground for modern Smart Tourism, which originates back to the beginning of the new millennium and is based on technologies such as Big Data, mobile technologies, the Internet of Things, cloud services and sensors. The key elements of touristic systems have evolved from the global distribution and reserve systems, which later have been replaced by brokers, information sharing via the Internet and direct transactions (B2B, B2C and C2C).

Ivars-Baidal et al. [57] in another work have also studied the importance of particular ICTs in tourism. According to their findings, the first technologies (with 2–5 years until they reveal their full impact or use) with the highest influence for tourism (according to the majority of the experts that participated in the study) are real-time databases, local connectivity, mobile communications payments and 5G, Near Field Communication (NFC) payments, Bluetooth, wearables, Augmented Reality and unmanned aerial vehicles (UAVs). Some of the experts also listed technologies such as Big Data, IoT or Virtual Reality in this context.

The key role that technology plays in the Smart City and Smart Tourism concepts is not without its downsides and limitations. Sometimes, it has been criticized for privileging technological tycoons, raising citizens' concerns regarding their privacy and the dependency on technology, as well as for pushing public services into the private sector [35,57].

It is obvious that various technologies now play different roles in tourism and impact tourists' behavior and change the functioning of a destination. Smartphones are now standard and are a necessity in tourism, representing the main platform for interaction between tourists and their destinations both in the real and virtual world [58]. They have taken word to mouth (WTM) promotion and expanded it into the electronic world (eWTM) [59,60], making it even more impactful for the value of a tourist experience at all travel stages (pre-travel, on-travel and post-travel) [61–65]. The popularity and importance of online reviews in tourism have been growing both for tourists and service providers [66]. Online platforms such as TripAdvisor and similar apps have placed tourists in the role of the co-creators of a touristic product by shaping an image for other customers [67,68].

Through technological development, tourists are no longer consumers but rather “adprosumers” [69] (they advertise, produce and consume a good). Information that can be extracted from such a large data set can be of use from the sustainability perspective for planning, developing, marketing and operating touristic products that are advantageous both for the quality of residents’ life and tourist visits [46,50,70,71].

Smart technologies play different roles in each of the previously mentioned travel cycle stages [40]. In the pre-visit stage, they are used for gathering information about attractions, finding places and services, getting opinions and feedback from different sources and finally shaping plans for the tour. Therefore, smart technologies impact the tourists’ experience by affecting how they search for and plan their visit, increasing their interests in the destination, reducing decision risks and providing a better overall understanding of the journey. In the on-site phase, the use of smart technologies includes mobile communications and transactions, the storing of memories or moments in the forms of recordings or images, making on-site short-term decisions and supplementing the visitors’ knowledge by reading detailed online comments or reviews about a point of interest the tourist is about to seek out. Thus, in terms of tourists’ experience, technologies influence how a visitor navigates and communicates, providing additional convenience, saving time and making the whole experience more flexible and more enjoyable, as well as affecting the form of how memories are made and kept. Finally, at the post-visit stage, smart technologies are used to share memories and gathered knowledge and also for tourists to write their own reviews (therefore providing others with the same advice the tourists received at previous stages). On this basis, it can be stated that smart technologies also influence how experiences are shared and memories are recollected and how the evaluation process runs [40].

Smart technologies do not only affect the (smart) tourists’ experience, but they also help tourists to impact others’ behavior to be more responsible and sustainable. This was proved in a study by Shen et al. [72], who found evidence that social networking sites are effective tools for developing sustainable and responsible behaviors from Smart Tourists at all three previously mentioned stages of the travel cycle (the influence is the strongest for the first two stages).

Tourists who embrace technological solutions can be seen as a separate subgroup of all tourists and referred to as Smart Tourists. Characteristics of Smart Tourists that distinguish them from other tourist groups can be found in research on this topic [13,44,45]:

1. Their use of smart devices is more integrated during their whole trip.
2. They share their experiences during their trip through social media (in the form of live streams or real-time updates).
3. They use websites and mobile apps to get the most up-to-date information, both during and before their trip.
4. They experience the least inconvenience related to language and mobility while being more familiar with their destination environment.
5. They are reported to have the highest additional consumption during a trip, while at the same time reporting the smallest income and spending budget in comparison to other groups.
6. They are more prone to be positively influenced by social media, so they act more responsibly and sustainably during their trip.

It is worth mentioning at this point that, even if the previously mentioned research works have proven that data gathering and its analysis serve the purpose of sustainable development and that tourists are increasingly dependent on technology and expect the newest solutions to be supported in touristic destinations, there is also another side of this aspect that has to be addressed, namely privacy issues and risk factors. As a study published in 2018 [73] has shown, there is no single model of technology users among tourists. The authors identified four clusters of different tourist types that differ in terms of their technology use and risk perception on the use of smartphones while traveling:

1. Not frequent travelers that use technology mainly for entertainment and do not see themselves as highly technology-oriented, but are concerned with data privacy and rather use technology for trip planning rather than for on-site information searching.
2. Senior travelers, who travel more frequently than the previous group and are more concerned with privacy issues than the first cluster. This group also uses technology mainly for entertainment, but is less dependent on it and has a neutral attitude towards the use of smart technologies in tourism.
3. Generation X tourists, who are technologically highly aware and travel frequently. Even if this group expresses awareness of privacy risks from technology use in travels, they use it not only for entertainment but also for information finding while on a trip and use technology intensively at a destination.
4. Technology-oriented young intensive travelers, who are not concerned with data privacy issues. This group is dominated by young millennials, mostly men, who use smart technologies at a destination more intensively than any other group while being least concerned with potential risks.

Another study [52] on the preconception of risk related to technology use by tourists has shown that, in general, the perceived benefits of smart devices outweigh the potential risks. Smart technologies have been proven to aid tourists in terms of cost-saving (while planning, browsing, booking or deciding on a tour), getting information while traveling and making the whole experience more convenient. The main worries for smart technology-using tourists are distrust towards the security of technology regarding location tracking, sensitive information privacy and financial transaction security. On the other hand, a study on ICT in tourism by Ramos-Soler et al. [74] shares a different perspective on the reception of technology by senior tourists: the authors of the mentioned study underline the concept that ICTs and applications are key tools for sustainability in tourism, especially at World Cultural Heritage Sites. Their study proved that these tools are essential for senior travelers and that they have a positive impact on their traveling experience.

2.4. Current Findings on ICT Use in Museums

As mentioned in the introduction, most of the research on ICT use in Smart Tourism has focused on the clients' perspective, and the service providers' point of view seems to be less frequently raised, let alone research that focuses on a specific branch, such as museums. However, some work in this field has already been undertaken, mainly by analyzing selected cases of museums that apply various ICTs or by reviewing a single technology and its benefits to museums.

From the perspective of Smart Tourism application in museums, all of the previously mentioned technologies can be of importance and use. Some studies focus on particular technologies, such as Near Field Communication (NFC), because museums—especially public ones—are often hosts of various meetings, conferences, incentives and most of all exhibitions. Findings from research in Columbia have shown that, in the modern world, NFC technology can be advantageous both for the organizers and participants of such events in tourism [75].

Smart technologies and the Internet of Things (IoT) in particular are not only useful solutions for tourists or valuable information sources about their behavior but can be also applied in museums to maintain perfect display conditions for valuable exhibits. A study from Naples shows that smart sensors can monitor the environment and provide information about the health status of cultural objects inside the museum [76].

Another technological solution that might find a broad application in smart museums is audio-guides. However, a study [77] that was dedicated to reviewing audio-guides in the era of Smart Tourism found that the use of audio-guides is still unexpectedly low. The study identified four major reasons for this: (1) firstly, in many cases, the environment is not audio-guide friendly, with too many noises and people who may disturb the listeners; (2) the use of audio-guide devices is still not user-friendly enough for casual users, who get frustrated when they have to operate the device when entering every new exhibition or change locations and eventually give up on using it; (3) the

devices also hinder any social activity and interaction between tour participants, making the whole experience feel extremely isolated; and finally, (4) the narrative of an audio-guide lacks the elasticity and individuality of a tour guided by a person, who can adapt to the needs of individuals (many tourists do not seek long detailed educational content, but would rather get brief information in favor of more entertainment, taking pictures and simply embracing the ambiance of a place). This shows that the simple adoption of technology is not enough to achieve “smartness” in tourism but rather creates good conditions to do so; in combination with other technologies such as Augmented Reality and a more individual approach to customer needs, the mentioned issues can be overcome, as Boletsis and Chasanidou [78] have shown in their work.

Another study by Empler [79] was dedicated to ICTs in museums; this work took the form of a case study on five museum installations in Italy. The study focused on already applied ICTs in the selected museums. The findings of this study were that, in museums with low numbers of artifacts and exhibitions, technology offers an additional commutation layer for additional information and the interactive enrichment of the visiting experience, offering unique visualizations of spaces and events that would otherwise be left to the imagination of the visitors. The author named three main groups who benefit from these solutions: school children (who become more engaged and attracted by gamification in the studied sites), tourists for whom the visited site was not their first choice (because they were only familiar with the most famous, main museums in city) and scholars (referring to scientists who specialize in the field of the given museum’s theme).

One can also find examples of studies regarding the needs and expectations of museum visitors regarding ICT use in such sites. One such example is the study by Owen et al. [80], which was conducted in five Cultural Heritage sites in the UK. The research indicated the underutilization of ICTs in the studied cases. However, it also showed that visitors strongly support advanced applications, such as AR, interactive museum installations, avatar applications and mobile media guides. The respondents in this particular study also indicated that the variety of technologies used in a site has more impact on their satisfaction rating than how they are used. The main objective of such technology providers is to present the expected benefits that come from using technology to the visitor, because tourists have to decide what they will spend their limited time on and will not trade it off for something without knowing its possible advantages. As another example, in the study by Rey and Casado-Niera [81], the authors studied perceptions and expectations regarding the use of ICTs in museums based on a survey that was conducted on 115 participants. The study showed that many tourists are not fully aware of the possibilities and advances that ICTs offer. It is expected that ICTs will not be used as a replacement for traditional information carriers, but rather as tools that can enhance the visitors’ experience by supplementing the already existing information and offering a cognitive and sensory addition to the experience. The expectations included also that ICTs would take a role that supports contact, information sharing and carrying out cultural activities. These observations are supported by a different study from Indonesia showing that if a museum falls behind the trend of introducing new technologies, it quickly loses its visitors because it gets perceived as boring, ancient and unmaintained [82] or not personalized enough for individual visitors [83].

Finally, it is worth underlining the fact that Smart Tourism does not only benefit tourists and tourist service providers but has a significant role in the sustainable development of the whole destination. Smart Tourism adopts the perspective that tourists generate information that can be used to track their activity and that this information can be utilized not only to improve their experience but also to help develop plans for the future in terms of better tourist distribution and the protection of the local society and natural resources [84]. Big Data is only one of many ICTs that can be useful for this; the Internet of Things, data mining, cloud computing and other modern technologies have expanded tourism to a new dimension, and they play now an important role in sustainable growth [85] as a development driver for tourism and society [33,70]. Many researchers confirm that Smart Tourism contributes to the creation of innovation and technology development and aids sustainability [70,86,87].

To conclude the theoretical section of this paper, it can be stated that the use of ICTs is inevitable in Smart Tourism, and the literature is full of different conceptions regarding its role and which particular technologies are key to its success. A large amount of research has been done analyzing the benefits of Smart Tourism application in tourist destinations, as well as on the potential benefits for tourists that ICTs can provide. Studies that focus on the service providers are rare, and works that focus on an entire branch, such as museums, are even scarcer. As presented in this section, the studies that do concentrate on museums are mainly case studies of specific institutions or are dedicated to a selected technology. This observation led the author of this publication to explore this field in more depth, adopting a more comprehensive approach and conducting research on all museums in a country (selecting their native country of Poland for the best communication possibilities with the researched entities and the best familiarity with their environment, as gathered from previous studies). The aim of this work was to recognize the cross-section of ICT use in the entire sector and the museum managers' attitudes towards adopting ICTs and the Smart Tourism concept. Museums seem to be an interesting choice because the most important and most recognizable (and therefore most visited) examples are public entities; therefore, they also reflect the national approach and policies of a given country to this concept.

3. Materials and Methods

According to the register of Polish museums published by the Ministry of Culture and National Heritage [88], there were 879 registered museum entities in the whole of Poland in April 2020. However, the list includes not only museums that are already operational, but also museums that are still in preparation or being organized. The list also contains departments of a parent entity (if a museum has one or more branches in different locations but are run by the same parent organization, each of them has a separate record on the list). Therefore, for this research, the list was narrowed down to active museums and only to the main parent units if a museum had multiple departments (thus, a record was excluded if it related to a museum that was marked as "in preparation" or as a branch of a main museum on the list). With those restrictions, the final list counted 500 entities.

For 2 months, from the beginning of May 2020 until the end of June 2020, an invitation to participate in the research and three reminding messages (with a 2-week interval) were sent via email (because of the COVID-19 restrictions) to the 500 museums. The respondents were asked to fill out an online form (using Google forms) that included 28 questions which provided the overall characteristics of a museum, listed the technologies used in it and provided an insight into the awareness of Smart Tourism and the application of technological solutions in that given museum. The questionnaire did not contain any questions about the museum's name and precise location to ensure anonymity. The research was anonymous because of the desire to obtain reliable information that was not burdened with the emotional factor of museums wanting to present themselves as better than their competitors. Figure 1 presents the described research process in a synthesized diagram form.

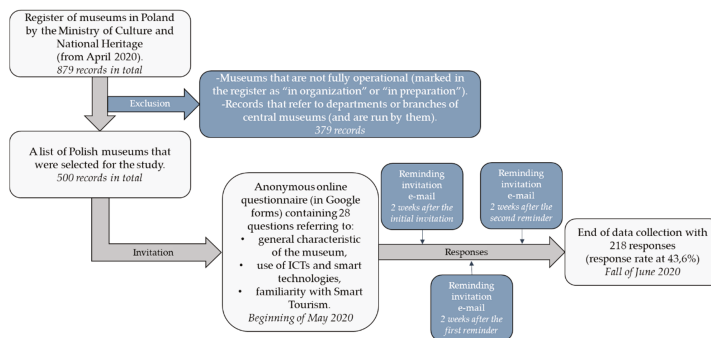

Figure 1. Research subject selection and data collection diagram.

Since the intention of the author was to keep the confidence interval below 5% at a confidence level of 95%, the sample size had to extend to over 217 respondents. This goal was reached at the end of June, when the 218th filled form was sent back to the author, and the data collection process was ended.

The collected data were analyzed and visualized using the R programming language and RStudio open software.

4. Research Results and Analysis

4.1. General Characteristics of the Research Sample

As mentioned above, 218 museums from across Poland participated in the presented research. The majority of the responses came from public museums (83.94%). The remaining answers came from private museums (10.09%) and the voluntary sector (5.05%), and two entities were marked as mixed (public–private) ownership (0.92%). The researched population differs from this proportion to a certain extent. The private sector makes up 32.02% of the 500 unique museums from the Ministerial list (and public entities make up the remaining 67.98%).

In Figure 2, one can see the spatial distribution of museums participating in the research, divided into voivodeships (administrative regions of Poland). Panel (a) shows the share of museums from a given voivodeship participating in the study, and in panel (b), the share of museums from a given voivodeship in the research sample is shown.

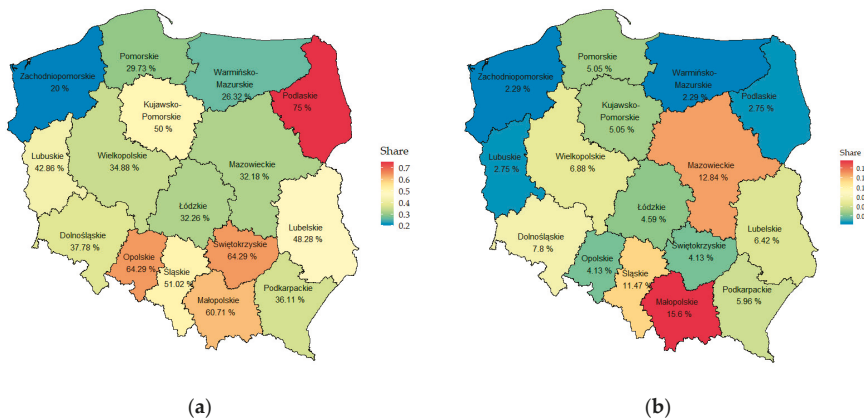

Figure 2. The share of museums participating in the study, presented (a) as the percentage of all registered museums in a given voivodeship and (b) as a percentage of the total number of museums taking part in the research.

It can be seen that museums located in southern and eastern voivodeships showed the highest research participation turnout (with Podlaskie voivodeship museums reaching the highest response rate of 75%, and Zachodniopomorskie exhibiting the lowest, at 20%). Additionally, the museums from southern and central Poland made up the majority of the research sample (with Małopolskie voivodeship having the highest share of 15.6%).

The first questions in the research form provided basic data that allowed the general characteristics of Polish museums to be obtained. One of the main parameters that describe these entities is the number of tourists visiting a museum annually. The participants were asked for the total number of tourists visiting their object in the previous year (2019). The main descriptive statistics for this variable are shown in Table 1.

Table 1. Descriptive statistics for the variable describing the number of tourists visiting Polish museums in 2019.

Statistic	Value
Min.	0
1st Quartile	7500
Median	20,000
Mean	84,768
3rd Quartile	64,427
Max.	2,320,000

As can be seen, the mean value is quite high, extending beyond the third quartile. This is because of the small number of museums with an extraordinarily high number of annual visitors in comparison to other museums; e.g., the internationally recognized museum in the former Auschwitz concentration camp (the maximum value probably comes from this site, but it is worth mentioning that the research forms were anonymous, so there is no certainty).

In Figure 3, the distribution of the annual tourist number is shown, varied by the sector of ownership (the mixed sector was omitted, since it contained only two observations, and for better clarity, the outlying values were also left out).

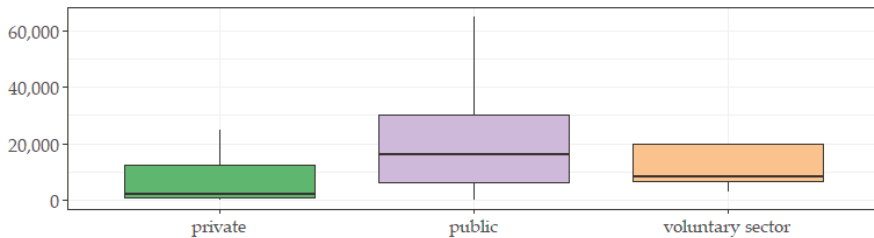

Figure 3. The annual number of tourists in Polish museums, varied by the type of ownership sector.

It can be seen that the number of tourists visiting public museums is much more varied than in the case of private museums or those from the voluntary sector. The value of the first quartile for the public sector is significantly higher than the median for the private sector and almost matches the median of the voluntary sector. One might assume that the reason for this may be the fact that many public museums offer free entry once a week, and because of the public funding, the entry tickets are often also cheaper during the rest of the week in comparison to private museums. Figure 4 shows this by illustrating the distribution of entry prices to museums from all three sectors, and Table 2 contains the descriptive statistics of this variable.

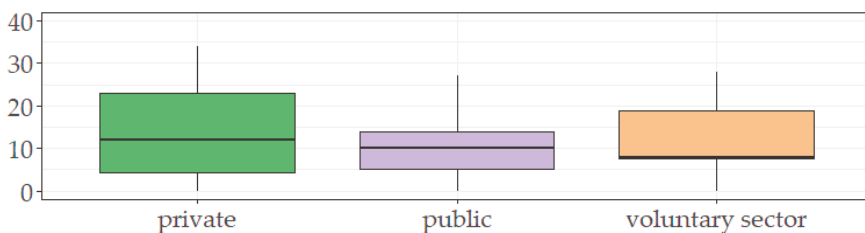

Figure 4. The entry ticket price to Polish museums (in PLN), varied by the type of ownership sector.

Table 2. Descriptive statistics for the variable showing the entrance fee in Polish museums.

Statistic	Value
Min.	0.0
1st Qu.	5.0
Median	10.0
Mean	11.4
3rd Qu.	15.0
Max.	70.0

The ticket price range for the museums in the public sector is visibly smaller than in the other two sectors. It is also worth mentioning that the shown prices are in Polish Złoty (PLN) (1 PLN \approx 0.25 USD/0.22 EUR (by exchange rates from the beginning of July 2020)). Additionally, it should be noted that the respondents were asked to name the price for their most commonly chosen tour in case there were multiple variants available.

However, the assumed dependency between price and annual tourist count has been negated by a statistical test. The Pearson's correlation coefficient between those two variables indicates a moderate positive correlation (PCC = 0.59 and p -value $< 2.2 \times 10^{-16}$), meaning that the more popular a museum is, the higher the price (which is understandable and economically justified). Therefore, the reason for such a large number of people visiting public museums must be something other than their relatively low price; it is probably related to the quality of the exhibits and their better fit to the taste of mass visitors.

The last chosen general characteristic of Polish museums was their theme or discipline. Most entities (59.6%) from the research sample selected only one kind of theme that their museum focuses on; the remaining 40.4% can be tagged as interdisciplinary museums. In Figure 5, how often every kind of museum was selected by the respondents is shown.

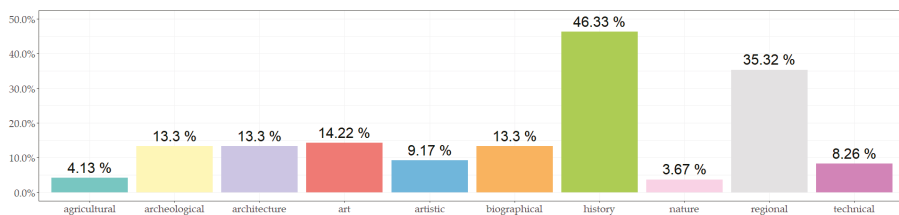
**Figure 5.** The share of selected kinds of museum selected by the research participants.

As can be observed in the plot above, almost half of the museums declared that history is their main domain, while over a third of the research sample represented regional museums. The least represented kinds of museum were nature and agricultural museums.

4.2. Smart Tourism in Polish Museums

The main objective of this study was to recognize the development stage of the Smart Tourism concept in Polish museums. To do so, it was important to approach this problem both directly and indirectly; the direct approach refers to the awareness of Smart Tourism solutions and their purposeful application in museums, while the indirect approach relates to the recognition of solutions that are used in Polish museums and are—or could be—used in Smart Tourism but are not recognized as such by the museum officials.

The direct approach was simple and straightforward. The representatives were asked if they were familiar with the Smart Tourism term (and if they were, they had to declare their attitude towards it). The share of responses to this question is depicted in Figure 6.

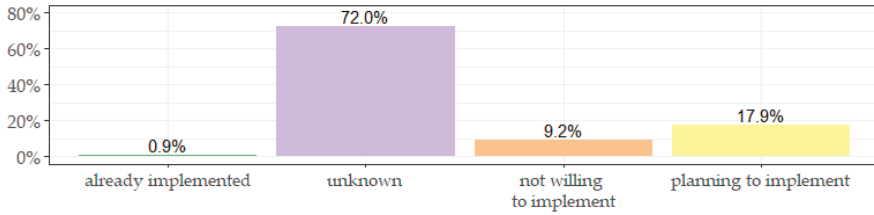

Figure 6. The recognition of Smart Tourism in Polish museums.

The collected data show that most (72%) of the museums in Poland were unfamiliar with the idea of Smart Tourism. Nearly a tenth (9.2%) declared that they knew the concept but were not planning to implement it, and only 17.9% were planning to do so in the future. Only a marginal fraction (0.9%) claimed that they had already realized this function. There was no significant difference in the distribution of the answers to this question in museums from various ownership sectors, kinds of museums or in museums run by different levels of administration.

Based on the data above, one might say that the development stage of Smart Tourism in Polish museums is low, at least in the area of its deliberate use. The following questions that were asked in the research form were designed to identify areas in which Smart Tourism has been implemented without that intention and to reveal the potential to change this low level of development of Smart Tourism.

First, the respondents were asked to select all the available tour types in their entity and to identify how common tours that use modern technology to extend the traditional sightseeing experience are. Figure 7 contains the percentages showing how often a given sightseeing option was confirmed by the respondents.

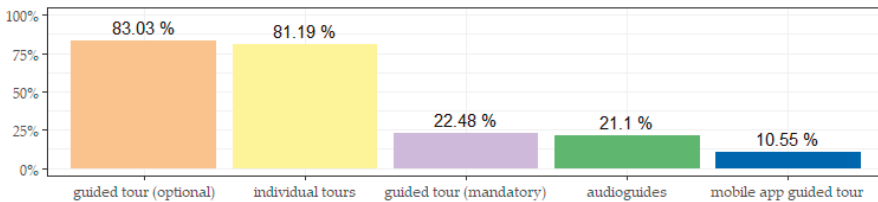

Figure 7. The forms of sightseeing available in Polish museums.

One can see that the majority of the researched museums used traditional forms of sightseeing, with over 80% of museums offering individual sightseeing or optionally guided tours. It may be argued that if 83.03% of museums offer guided tours as an option, the result of 22.48% of mandatory guided tours should be excluded; however, this might be explained by the fact that some museums offer various products (different routes or multiple locations), where some require a mandatory guide service and others do not. The fact that over a fifth (21.1%) of the researched entities offer audio guided tours and over a tenth (10.55%) incorporate tours that are guided through a mobile application should be noted as a positive input regarding Smart Tourism’s development potential.

Furthermore, many researched sites declared that they were already planning to introduce more modern solutions to the visitors’ experience. This is illustrated in Figure 8.

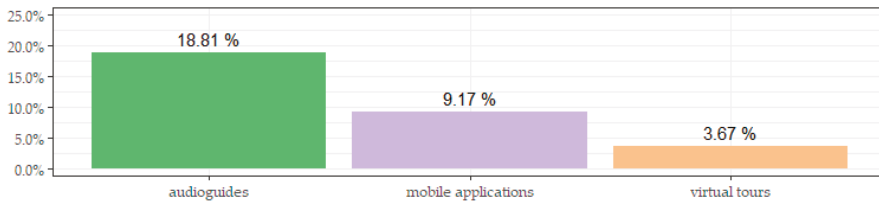

Figure 8. The forms of sightseeing that are planned for introduction in Polish museums.

Should these planned actions be realized, the total percentage of museums in Poland offering audio-guided tours would reach a decent share of approximately 40%, and the number of sites with the option of using mobile applications for guidance would double to a modest 20%.

One of the key aspects of Smart Tourism is to serve and support one of the main requirements of modern tourism—increasing a destination’s attractiveness—and therefore to attract more tourists, both domestic and foreign. In this sense, the adaptation of a touristic entity to provide services in multiple languages might be considered to be another Smart Tourism development indicator. For this purpose, the study participants had to select the number of languages that were available for various sources of information about their site. Figure 9 presents the share of answers for each selected information source.

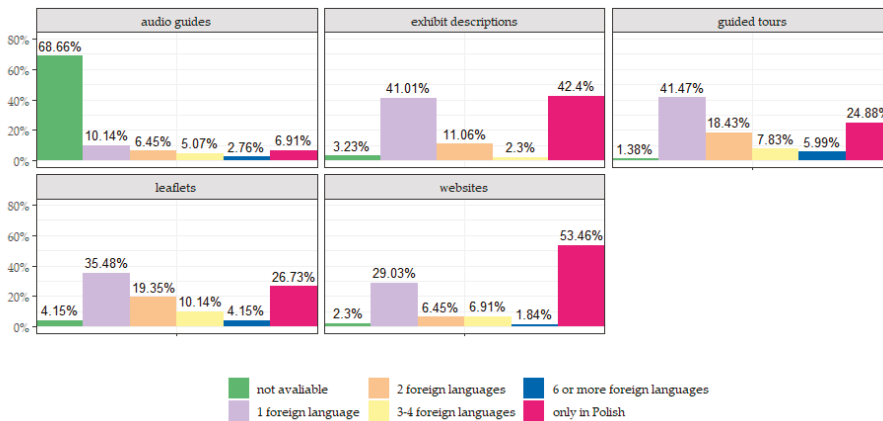

Figure 9. The number of available languages in selected information sources for museum visitors.

Interestingly, the collected data show that foreign languages are widely available in Polish museums, particularly in the case of guided tours. These tours are available in the Polish language exclusively in approximately only a quarter of the museums; the remaining majority of the researched entities offer these tours in at least one language other than Polish. Surprisingly, the websites are on the other end of the spectrum in this matter; over half (53.46%) of all museum websites are not available in languages other than Polish. This could be an area for relatively easy improvement in the future, especially because most of the researched sites have access to translation services and have already employed them for other materials, such as leaflets or information boards on the exhibits.

Continuing the subject of accessibility for foreigners and domestic visitors through modern media, the representatives of the researched museums were asked to name the mobile application in with their object is positioned. In Figure 10, the shares of museums using each selected mobile application are shown. The applications were selected based on one of the author’s previous papers that was dedicated to the issue of mobile applications in tourism [89].

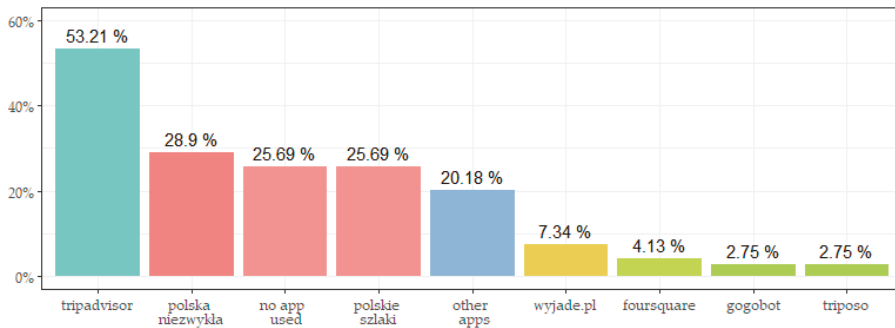

Figure 10. The presence of Polish museums in selected mobile applications.

Starting from the highest result, one may interpret the relatively high score of 53.21% of museums being registered on TripAdvisor as a positive result from the perspective of the potential of Smart Tourism in Polish museums. TripAdvisor is one of the most popular applications dedicated to tourists globally. Such a large share of museums using the service to make themselves easier to find for domestic and international tourists makes up to some extent for the lack of foreign languages on their websites. The second-highest score (28.9%) relates to “Polska Niezwykła,” a Polish application with one of the richest databases of touristic sites in Poland [89]; unfortunately, this application supports only the Polish language. On the other hand, the fact that over a quarter (25.69%) of the museums do not use any mobile application to promote themselves leaves a significant unused potential that should be explored in the future. The fourth- and sixth-highest results also correspond to domestic applications, and the last three correspond to international apps (again, revealing a potential that has not yet been fully exploited). The bar named “other apps” refers to mobile applications that have been named by fewer than five respondents and were added together to form a single group.

The idea that the use of technology could be significantly improved in Polish museums is reinforced by further findings of this research. In the following question, the participants of the study were asked about the use of online systems for reservations on ticket sales. The answer distribution is pictured in Figure 11.

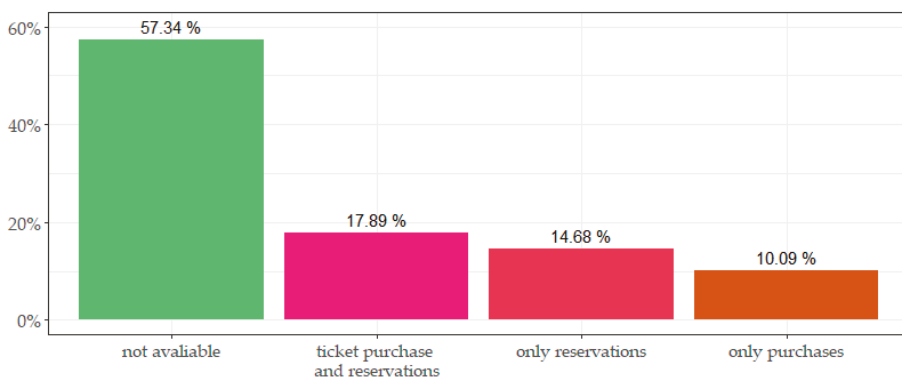

Figure 11. The availability of online tour purchases and reservations in Polish museums.

As shown above, more than half (57.34%) of museums in Poland do not use any online tools for ticket sales or reservations; these can only be made on-site or via a phone call. Less than a fifth (17.89%)

of the researched entities use online tools both for tour reservations and entry ticket sales, and the remaining quarter allow only one of those options—either reservations (14.68%) or purchases (10.09%).

Another important aspect of Smart Tourism is to not only use technological solutions to improve service quality and accessibility but also to use those inputs to collect and utilize data that could be used for future improvements as well as for other entities belonging to a larger structure, such as a Smart City. To explore this aspect in Polish museums, the research form included questions about the museum’s approach to the collection of data (regarding clients, employees, finance, inventory, business partners, tour reservation history and tour sales). The respondents could choose one of the following options, for each kind of data: the data are archived, the data are kept only temporarily, the data are not collected, the data are collected and used to build a database or the data are only kept by the period required by law (i.e., for insurance or tax purposes). The results are visualized in Figure 12.

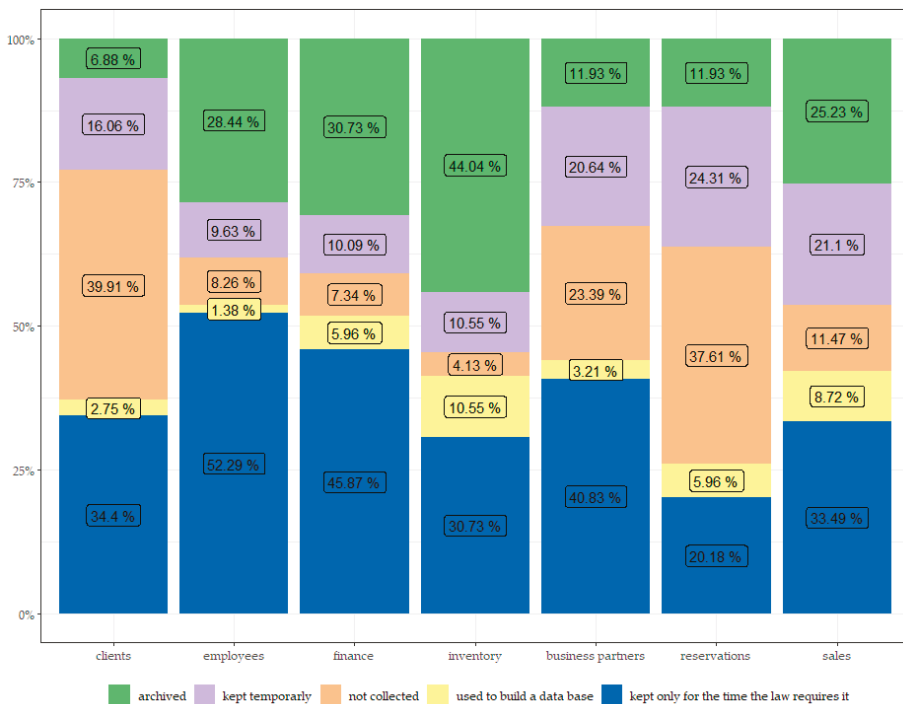

Figure 12. Data collection in Polish museums, varied by the subject that the data concern.

The attitude towards data collection in Polish museums varies depending on what the data concern. Surprisingly, the kind of data that is least recorded by the museums is about their clients (39.91% of all museums claim that they do not collect any data regarding their customers) and past reservations (37.61% of museums do not gather this information). It could also be considered unusual that the second-highest share of data, which is kept only because of legal restrictions, concerns business partners (40.83%, exceeded only by the 52.29% of data regarding employees). The information about a museum’s inventory was named as the most frequently archived data (44.04%), as well as representing the highest share of the information used to build a database. The presented results might be interpreted as an indication of an outdated, old-fashioned approach to data exploitation in Polish museums. This is because the inventory data that are mostly archived and utilized in databases can be considered

the least useful for generating new knowledge; the data also do not lead to innovative solutions for providing services for tourists or giving related urban institutions information that could be used by them. The collection of these data is simply for the internal convenience of the museum in cataloging and keeping track of their exhibits. This thought is only reinforced by the results from a follow-up question that concerned the familiarity of museums with Big Data and its analysis. Figure 13 contains the results.

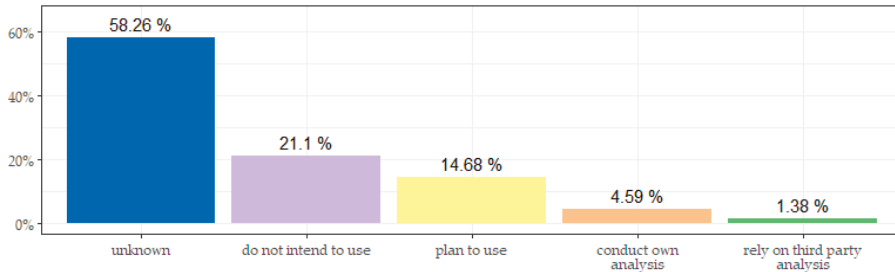

Figure 13. The recognition of Big Data and its use in Polish museums.

The majority (58.26%) of the researched museums are not familiar with the concept of Big Data, and the second biggest share (21.1%) of answers was for “we are familiar with it, but we do not use it and do not intend to do so in the future”. Only a marginal (<6%) percentage of all researched museums claim to use Big Data and analyze it to improve their functionality, where 4.59% do their own research and 1.38% rely on analysis that is outsourced or prepared by parent institutions.

Smart Tourism does not only refer to the use of technology and information collection but also to the application of those means for a bigger cause—improving cooperation and achieving goals on a larger scale (within a Smart City, a region, a country or even larger scales). However, to do so, information, data and the knowledge gained from them need to be made accessible and be shared. Therefore, the research form included a question about the museum’s attitude towards data sharing, and the results are shown in Figure 14.

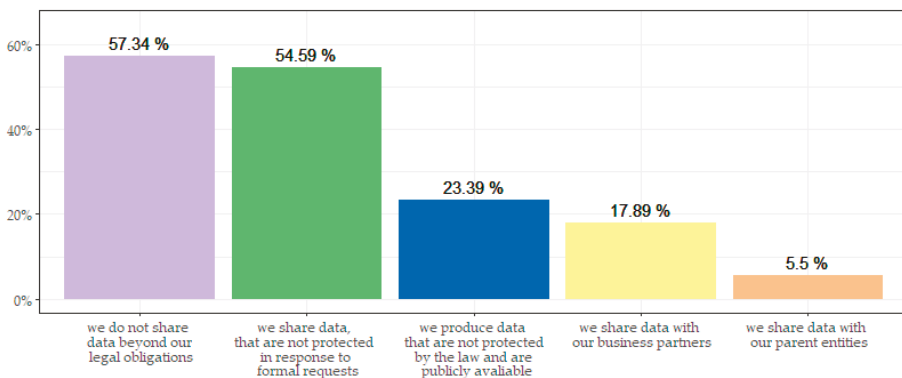

Figure 14. The attitude of Polish museums to data sharing.

The presented results show that the most common attitude towards data sharing is rather conservative, where over half (57.34%) of the museum representatives claimed that they do not share any information beyond legal obligations (resulting from contracts and law) on their own initiative. On the other hand, over half (54.59%) of the researched entities are willing to share information in

response to formal requests (i.e., from government units, researchers or statistical offices). Interestingly, even if the majority of the research sample was made up of public museums, only 5.5% of them agree to share data with parent institutions (i.e., the city hall or Marshal’s Office). This, with the addition of the 17.89% share for data sharing with business partners, may indicate a lack of initiative regarding Smart Tourism in the environment in which the museums function. As the results show, most of the museums are able and willing to share data (this is indicated by the high share for the answer “we share data in response to requests”), but the surrounding environment (local and national policies, public and business entities) is simply not oriented to gathering and utilizing data yet and therefore does not demand it.

Knowing that most Polish museums are not familiar with the popular concept of Big Data, but also knowing that a significant portion of the information is being kept by them (in the form of temporary storage, archive or even a database), the next question asked in the research form was specifically about the use of databases by business partners, clients, contractors and suppliers that cooperate with the investigated museums. The received answers may appear to be somehow inconsistent with the previous answers, as shown in Figure 15.

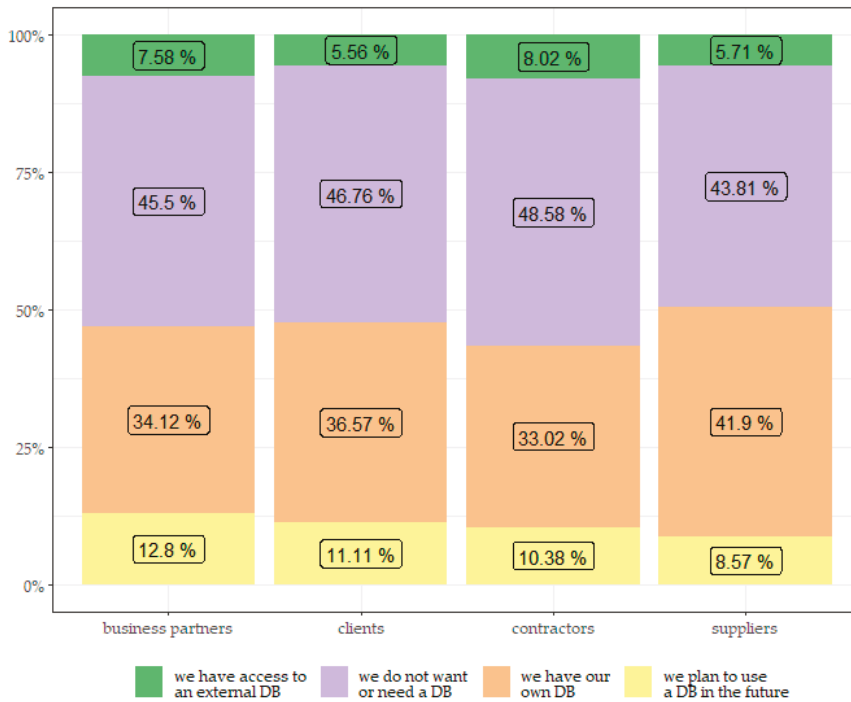

Figure 15. The use of databases in Polish museums, varied by subject. DB: database.

It should be noted that, even if the highest share of all database subject categories corresponded to the statement that a given museum does not need a database, all the other answers indicate a higher level of database use (over 40% in all categories when combining the use of a museum’s own and external databases) than might arise from the previously discussed results (from Figure 11 especially). A probable explanation for this that provides consistency to the logic of those answers might be that the museums use databases to store information that in previous questions were marked as only being kept temporarily or only for the time required by law. If so, this might be another field for improvement

in the future: the awareness of the importance of data gathering and processing could be increased through a better understanding of and orientation toward Smart Tourism.

To complete the investigation on the use of Smart Tourism-oriented technology in Polish museums, the final three questions concerned technologies used for communications, divided into the use of (1) social media, (2) means of communication and (3) modern technologies used in the everyday functioning of a museum. The social media question referred to the assessment of the frequency of use of a given medium by the museum to inform customers about its activity. The respondents could use an ordinal scale (from never to constantly) to assess the frequency of use of 11 globally recognizable social media platforms (Facebook, Instagram, LinkedIn, Pinterest, Reddit, Snapchat, TikTok, Tumblr, Twitter, WeChat and YouTube), as well as naming others if they used a medium not included on the list. From those 11 selected social media platforms, seven were not used by most of the researched entities (where 93% or more of the museums claimed they never used it). The distribution of given answers for the remaining four social media platforms is shown in Figure 16.

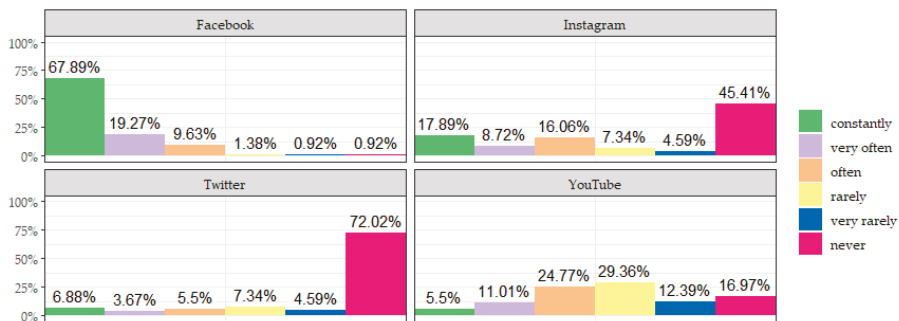

Figure 16. The use of social media by Polish museums.

It can be seen that, apart from Facebook, social media platforms are used by the museums in Poland rather scarcely, with YouTube being the second most used by most of them. Given the fact that those two media platforms have been available for more than a decade, they do not attract the youngest audience, who have migrated to newer media platforms that are growing in popularity. Therefore, those should be seen as more representative of today’s standard, which may quickly change in the future. The recommendation here would be to invest more interest into newer social media platforms to keep pace with “tomorrow’s” customers and to awaken more interest in culture and history in today’s youth by reaching out to them through media and content they find interesting and appealing today (the latest studies have shown that Facebook is aging with its users, and younger users, although present there, use other platforms such as Snapchat or Instagram more extensively [90,91]).

To complement the previous question, the museum representatives were asked to select which means of communication are used within the institution and which are used when contacting customers or business partners. The respondents could choose between yes or no answers for each recipient group and each communication platform listed (12 in total). The share of positive answers for each option is shown in Figure 17.

The results show clearly that some communication media are preferred by the museums over others, regardless of the type of recipient. Phone calls (both cellular and landline) and e-mail are the most frequently used in contacts with clients, partners and within institutions. Additionally, short messages and the Facebook Messenger application are used by a significant share of museums, primarily, but not only, for internal communication. Surprisingly, although the study was conducted after the strictest COVID-19 restrictions in Poland had been introduced, the communication media that aid distance working (via videoconferencing) were selected only by a minority of respondents. The picture emerging from these results suggests that the museums’ approach towards means of

communication is rather conservative, and they rely on traditional and standardized solutions. At the same time, they also indicate that there is a portion of employees who are familiar with alternative solutions but that those are kept for internal matters and not utilized for the external issues of the institution.



Figure 17. The means of communication used in Polish museums.

The closing question in the research form was designed to recognize the use of selected ICT technologies in Polish museums, concluding the investigation into the familiarity and application of Smart Tourism solutions in those cultural institutions. The share of answers describing the current state of use of seven selected technologies is shown in Figure 18.

It can be seen that the technology that is already used by the highest share (50%) of museums is virtual touring. This technology was selected as “already used” multiple times more frequently than any other listed technology (the second highest result was 15.14% for cloud computing). Moreover, 36.7% of museums decided they were interested in this technology and are planning to also introduce it in the future. Virtual tours were the second highest ranking (36.7%) technology planned for implementation, immediately behind the desire to design a dedicated mobile application for a given museum (37.16%). At this point, it is worth remembering that, according to the previous results, over half of the museums have websites available only in the Polish language and another third in only one foreign language (presumably English). Apart from virtual tours, other technologies listed in the form were selected by a comparable fraction of museums as solutions that are not used by them (ranging from 29.36% to 40.83%). Two of the listed technologies were selected as unknown by approximately half of the museums: the Internet of Things (53.21%) and NFC with RFID (48.17%). Those two technologies are often used in modern ICT and play a significant role in the smart concept (in Smart Homes, Smart Cities and consequentially in Smart Tourism). The high rate of unfamiliarity in this matter is yet another

indicator that museums in Poland could increase their Smart Tourism potential and are not fully ready to embrace this concept without several improvements (mentioned earlier when they emerged from the presented results). The main reason for this is probably not the lack of will on the side of the museums' management but rather a matter of regional and national policies that are still not fully oriented towards introducing Smart Tourism into Polish museum tourism; thus, the museums are not required to embrace those solutions.

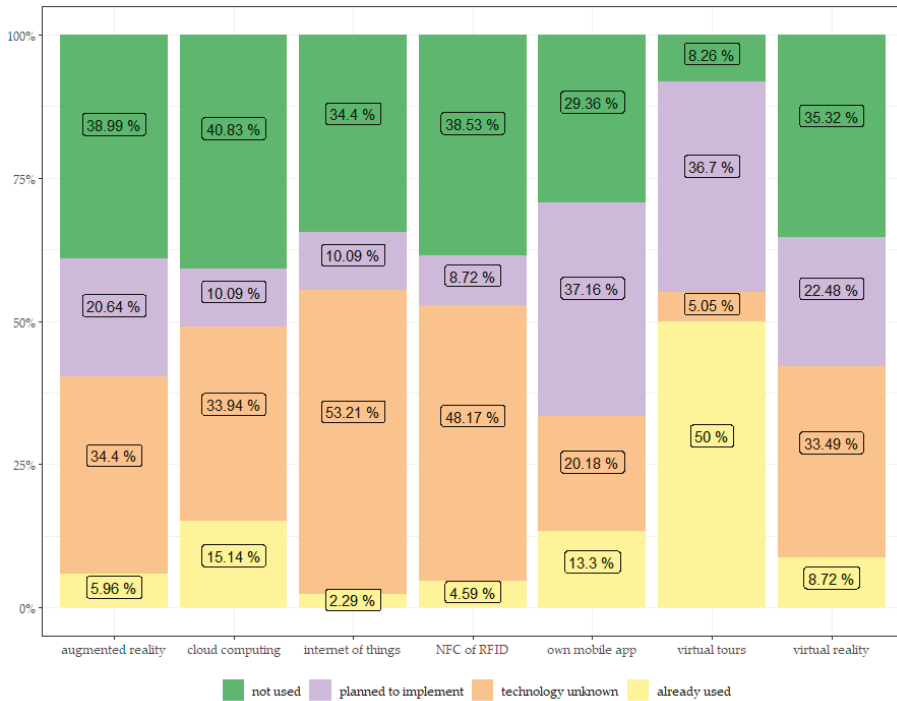

Figure 18. The recognition and use of various technologies in Polish museums.

5. Discussion and Conclusions

Based on the research results, the main observation that can be made is that Smart Tourism is a rather unknown concept to museums in Poland. However, the findings have also shown that there is some potential that would ease the introduction of this concept.

Traditional tours in Polish museums are the dominant form of sightseeing, but many museums have introduced technical solutions that support their operation. Many museums plan to develop in this area, especially by increasing the availability of audio-guided tours (if the museums fulfill their declarations, the availability of this solution should reach 40%) and designing their mobile applications (the expected availability would reach approximately 20%).

Concerning the handling of the needs of international tourists, the research has shown great differences in this matter depending on the given aspect of a museum's operation. Most of the museums offer guided tours in at least one language other than Polish; on the other hand, over half of the museums' websites are only available in Polish and therefore are not suited for foreigners to find information there directly. This paucity is however compensated to some extent by the fact that over half of the researched entities are registered in an internationally recognized service; i.e., TripAdvisor.

Similar diversity pertains to the use of technology in museums. A prominent majority of the institutions in Poland do not enable customers to buy or reserve tours via an online system. Additionally, data and information that are or could be gathered by museums are not utilized to their full potential; often, they are not stored or are only kept to fulfill legal obligations. In the most developed regions of the world that focus on sustainability and use technology to aid it, tourism is required to match and keep up with the development of a Smart City. The flow of data and information, as well as their understanding, analysis and effective use to gain benefits throughout this structure, form the basis of this smart system. However, to do so, the public sector must undertake awareness-raising actions and prepare courses on the use of appropriate data analysis tools for public institution workers. As the research results have shown, Big Data analysis and the building and using of databases are sparsely present in Polish museums. It is possibly even implied that museum management assumes that future tourism will not differ from how it is conducted today, and that the use of technology is only an oddity or an additional feature to their business, rather than the basis of future operation (this thought emerges from the fact that many museums are interested in creating mobile apps and creating virtual tours on their websites while there is simultaneously a low interest in the Internet of Things concept or the use of cloud computing and other crucial Smart Tourism solutions).

The museums' attitude towards social media and communication platforms seems also not to follow the newest trends, and they rather use traditional (in today's standards) solutions, focusing their Internet activity on Facebook and occasionally on YouTube. Reaching out and raising interest in culture for young generations of tourists might require opening up to other communication channels that reach them more effectively. The same might also apply to the expectations and needs of international tourists who come from wealthier and more developed countries, in which newer social media and communication platforms are more popular among a broader population. For example, foreign tourists might not want to risk expensive international phone calls to gain information or make a reservation for a museum tour, and the lack of an immediate response through e-mail communication might be discouraging for them. A solution to this might be for museums to use not only traditional phone services for their booking service but also online communicators alongside them (i.e., WhatsApp).

The presented observations can be used to formulate recommendations for museums and regional administrations, which would increase Smart Tourism's potential and allow for a full adaptation of the concept in the future. These recommendations are presented as follows.

1. Official museum websites would benefit from being translated into English (and maybe other languages), or at least parts of them containing basic information about the institution (opening time, contact, available kinds of tours and pricing).
2. The museums should continue to mark their presence in mobile applications and continue to expand the information about themselves in those media while also taking into consideration and concentrating more on the needs of both domestic and foreign tourists.
3. In the long-term perspective, the reservation and ticket sales systems should be modernized and become available via the Internet. In times when people can book a restaurant table or reserve an appointment in a barbershop through a dedicated service or a mobile app and official matters can be handled completely through a government website, one might expect the same functionality to be available in cultural institutions such as museums (which, as has been shown in the results, are mainly public entities).
4. It is important to raise awareness of how useful and valuable it is to gather, keep and analyze information. Even if, at first glance, Big Data might seem not to be of the highest importance, from the museum's perspective, it plays a key role in the whole "ecosystem" of a Smart City. Therefore, it is indirectly related to the operating of museums and in the end can provide benefits in the form of better infrastructure, more recognition and attracting more visitors. The gathered data could be also used to build databases that are of use for museums.
5. The museums' presentation and promotion of offers should expand to more social media platforms, especially those that are gaining global popularity. Furthermore, the contact options could be

supplemented by a wider spectrum of communication platforms—mainly online—that could be used both (1) to reach technology-oriented customers (2) and in times when the traditional functioning of a museum is disturbed (as in the case of the COVID-19 pandemic outbreak).

6. For the previous recommendations to be effective, it is important to consider Smart Tourism orientation in development plans for cities and regions by setting guidelines and requirements that have to be met. Without those, the intrinsic implementation of Smart Tourism solutions will remain dependent only on the intentions and goodwill of museum officials (and as the study has shown, there is no conviction of its importance for the future of museum tourism inside of those institutions).

One of the main contributions of this study to the field is a comprehensive summary of ICT and technology use in Polish museums, which may be representative for countries in a similar stage of development that already embrace new technologies in the public domain but in which the adaptation of the Smart Cities concept is limited to few major cities (and not to its full extent). It shows the cross-section of to which extent each technology is used on average in this particular branch of tourism. The study has also shown that museums' use of new technologies and ICTs is rather selective, with museums most of the time limiting themselves to technologies that are well-known and already solidly established in the mainstream while also viewing them as an optional oddity and as an additional attraction that does not represent the core of future services. Therefore, the study confirms that the hypothesis by Dorcic et al. [31] (that stakeholders do not fully recognize and appreciate the importance of ICTs and their benefits) also applies to museums.

The identified weaknesses and areas that need development should be solved and removed over time. A network approach on the city level (or even wider) to information and knowledge sharing would help in the area of effective data collection and utilization, as well as knowledge and information sharing, which was identified to be a weak spot in the studied entities. Additionally, a successful application of such network solutions would also aid in the process of the adoption of the Smart City concept (and consequently Smart Tourism), as it is one of its core elements [1,41,48]. Better funding programs and improved policies that support new technology being introduced into the public domain are also an important improvement that has to be made. Referring back to Pradhan [52], it is a key task for tourism stakeholders to keep up with technologies and introduce a variety of them, not only because they are key for further development but also, as Owen et al. [80] observed, if presented as advantageous for tourists and used in a variety of ways, they have a significant impact on tourists' satisfaction. One might also expect that, because of this effect, private museums will be the first to follow this path (their actions are not as limited by funding and law policies but driven by the free market, and therefore clients' satisfaction is key for their survival), and afterward, public entities will follow to meet the standards set by the private sector to stay competitive. The same effect is expected to occur in the area of museums meeting the needs and expectations of international travelers that were currently identified to be lacking. Additionally, the development of society and the further popularization of Smart Cities is also expected to be of help in this case, since it is based on the evolution of society; as the concept of Smart People increases in recognition, the public will become more tolerant, cosmopolitan and open to the needs of others [35–37].

The conducted research has some limitations. The main limitation is that the final research sample contained a greater proportion of public museums to private ones than in the general population that was researched. Therefore, the finding concerning private entities may not show the full picture of the Smart Tourism potential in this sector. The second limitation is that the study concerned only the internal state of the museums.

Future studies could supplement these findings by adding observations from the macro- and microenvironment of museums. City and regional policies, as well as national regulations and funding policies, could provide a wider perspective on the current state of Smart Tourism development in Poland. The presented results might also be useful in other studies on the same or related subjects in other countries, providing a reference point for comparisons and benchmarking.

Funding: This research received funding from the Ministry of Science and Higher Education in Poland.

Acknowledgments: This paper was published as part of the research project “Smart Tourism in Polish tourism” (original title: “Smart Tourism w polskiej turystyce”) No. 13/010/BKM20/0047, financed by the Ministry of Science and Higher Education in Poland.

Conflicts of Interest: The author declares no conflict of interest.

References

1. Komninos, N. *The Age of Intelligent Cities: Smart Environments and Innovation-for-All Strategies*; Routledge: London, UK, 2014.
2. Battino, S.; Lampreu, S. The role of the sharing economy for a sustainable and innovative development of rural areas: A case study in Sardinia (Italy). *Sustainability* **2019**, *11*, 3004. [[CrossRef](#)]
3. Mathews, S.; Bianchi, C.; Perks, K.J.; Healy, M.; Wickramasekera, R. Internet marketing capabilities and international market growth. *Int. Bus. Rev.* **2016**, *25*, 820–830. [[CrossRef](#)]
4. Ferrero, R.; Beattie, E.; Phoenix, J. Sensor city-A global innovation hub for sensor technology. *IEEE Instrum. Meas. Mag.* **2018**, *21*, 4–16. [[CrossRef](#)]
5. Law, R.; Buhalis, D.; Cobanoglu, C. Progress on information and communication technologies in hospitality and tourism. *Int. J. Contemp. Hosp. Manag.* **2014**, *26*, 727–750. [[CrossRef](#)]
6. Ghaderi, Z.; Hatamifar, P.; Henderson, J.C. Destination selection by smart tourists: The case of Isfahan, Iran. *Asia Pac. J. Tour. Res.* **2018**, *23*, 385–394. [[CrossRef](#)]
7. Semerádová, T.; Vávrová, J.N. Using a systemic approach to assess Internet marketing communication within hospitality industry. *Tour. Manag. Perspect.* **2016**, *20*, 276–289. [[CrossRef](#)]
8. Buhalis, D.; O'Connor, P. Information communication technology revolutionizing tourism. *Tour. Recreat. Res.* **2015**, *30*, 7–16.
9. Aurélien, D.; Desiré, R. An Evaluation of Destination Management Systems in Madagascar with Aspect of Tourism Sector. *Am. J. Ind. Bus. Manag. Sci. Res. Publ.* **2014**, *4*, 9. [[CrossRef](#)]
10. Alaei, A.R.; Becken, S.; Stantic, B. Sentiment Analysis in Tourism: Capitalizing on Big Data. *J. Travel Res.* **2019**, *58*, 175–191. [[CrossRef](#)]
11. Jovicic, D.Z. From the traditional understanding of tourism destination to the smart tourism destination. *Curr. Issues Tour.* **2019**, *22*, 276–282. [[CrossRef](#)]
12. Talón-Ballester, P.; García-Muiña, F.E.; Rienda-Gómez, J.J.; González-Serrano, L. Repeat Consumer Behavior on Smart P2P Tourism Platforms. *Sustainability* **2019**, *11*, 7082. [[CrossRef](#)]
13. Femenia-Serra, F.; Perles-Ribes, J.F.; Ivars-Baidal, J.A. Smart destinations and tech-savvy millennial tourists: Hype versus reality. *Tour. Rev.* **2019**, *74*, 63–81. [[CrossRef](#)]
14. Gretzel, U.; Zhong, L.; Koo, C.; Cacho, A.; Mendes-Filho, L.; Estaregue, D.; Alves, C.; Moura, B.; Cacho, N.; Lopes, F. Mobile tourist guide supporting a smart city initiative: A Brazilian case study. *Int. J. Tour. Cities* **2016**, *2*, 164–183.
15. Lepkowska-White, E.; Parsons, A. Strategies for monitoring social media for small restaurants. *J. Foodserv. Bus. Res.* **2019**, *22*, 351–374. [[CrossRef](#)]
16. Wang, X.; Li, X.R.; Zhen, F.; Zhang, J. How smart is your tourist attraction? Measuring tourist preferences of smart tourism attractions via a FCEM-AHP and IPA approach. *Tour. Manag.* **2016**, *54*, 309–320.
17. Xiang, Z.; Magnini, V.P.; Fesenmaier, D.R. Information technology and consumer behavior in travel and tourism: Insights from travel planning using the internet. *J. Retail. Consum. Serv.* **2015**, *22*, 244–249. [[CrossRef](#)]
18. Koo, C.; Shin, S.; Gretzel, U.; Hunter, W.C.; Chung, N. Conceptualization of smart tourism destination competitiveness. *Asia Pac. J. Inf. Syst.* **2016**, *26*, 561–576. [[CrossRef](#)]
19. Xu, F.; Huang, S.; Li, S. Time, money, or convenience: What determines Chinese consumers' continuance usage intention and behavior of using tourism mobile apps? *Int. J. Cult. Tour. Hosp. Res.* **2019**, *13*, 288–302. [[CrossRef](#)]
20. Kim, M.J.; Chung, N.; Lee, C.K.; Preis, M.W. Motivations and Use Context in Mobile Tourism Shopping: Applying Contingency and Task-Technology Fit Theories. *Int. J. Tour. Res.* **2015**, *17*, 13–24. [[CrossRef](#)]
21. Wang, D.; Xiang, Z.; Fesenmaier, D.R. Smartphone use in everyday life and travel. *J. Travel Res.* **2016**, *55*, 52–63. [[CrossRef](#)]

22. Garcia-Madariaga, J.; Recuero Virto, N.; Blasco López, M.F.; Aldas Manzano, J. Optimizing website quality: The case of two superstar museum websites. *Int. J. Cult. Tour. Hosp. Res.* **2019**, *13*, 16–36. [[CrossRef](#)]
23. Dickinson, J.E.; Ghali, K.; Cherrett, T.; Speed, C.; Davies, N.; Norgate, S. Tourism and the smartphone app: Capabilities, emerging practice and scope in the travel domain. *Curr. Issues Tour.* **2014**, *1*, 84–101. [[CrossRef](#)]
24. Rasinger, J.; Fuchs, M.; Höpken, W. Information Search with Mobile Tourist Guides: A Survey of Usage Intention. *Inf. Technol. Tour.* **2007**, *9*, 177–194. [[CrossRef](#)]
25. Vecchio PDel Mele, G.; Ndou, V.; Secundo, G. Creating value from Social Big Data: Implications for Smart Tourism Destinations. *Inf. Process. Manag.* **2018**, *54*, 847–860. [[CrossRef](#)]
26. Del Chiappa, G.; Baggio, R. Knowledge transfer in smart tourism destinations: Analyzing the effects of a network structure. *J. Destin. Mark. Manag.* **2015**, *4*, 145–150. [[CrossRef](#)]
27. Pine, B.J.; Gilmore, J.H. Welcome to the experience economy. *Harv. Bus Rev.* **1998**, *76*, 97–105.
28. Neuhofer, B.; Buhalis, D.; Ladkin, A. Smart technologies for personalized experiences: A case study in the hospitality domain. *Electron. Mark.* **2015**, *17*, 243–254. [[CrossRef](#)]
29. Gomez-Oliva, A.; Alvarado-Uribe, J.; Parra-Meroño, M.C.; Jara, A.J. Transforming Communication Channels to the Co-Creation and Diffusion of Intangible Heritage in Smart Tourism Destination: Creation and Testing in Ceutí (Spain). *Sustainability* **2019**, *11*, 3848. [[CrossRef](#)]
30. Cuesta-Valiño, P.; Bolifa, F.; Núñez-Barriopedro, E. Sustainable, Smart and Muslim-Friendly Tourist Destinations. *Sustainability* **2020**, *12*, 1778. [[CrossRef](#)]
31. Dorcic, J.; Komsic, J.; Markovic, S. Mobile technologies and applications towards smart tourism—state of the art. *Tour. Rev.* **2019**. [[CrossRef](#)]
32. Guzal-Dec, D.; Zwolinska-Ligaj, M. The social field of smart villages concept: The case of peripheral region—Lublin province in Poland. In Proceedings of the 2018 International Conference Economic Science for Rural Development, Jelgava, Latvia, 9–11 May 2018; Volume 49, pp. 296–306.
33. Buhalis, D.; Amaranggana, A. Smart Tourism Destination. In *Information and Communication Technologies in Tourism*; Xiang, Z., Tussyadiah, I., Eds.; Springer International Publishing: Cham, Switzerland, 2014; pp. 553–564.
34. Hollands, R.G. Will the real smart city please stand up? Intelligent, progressive or entrepreneurial? *City* **2008**, *12*, 303–320. [[CrossRef](#)]
35. Vanolo, A. Smartmentality: The smart city as disciplinary strategy. *Urban Stud.* **2014**, *51*, 883–898. [[CrossRef](#)]
36. Caragliu, A.; Del Bo, C.; Nijkamp, P. Smart Cities in Europe. *J. Urban Technol.* **2011**, *18*, 65–82. [[CrossRef](#)]
37. Lombardi, P.; Giordano, S.; Farouh, H.; Yousef, W. Modelling the smart city performance. *Innov. Eur. J. Soc. Sci. Res.* **2012**, *25*, 137–149. [[CrossRef](#)]
38. Harvey, D.; Harvey, F.D. *Spaces of Hope*; University of California Press: Berkeley, CA, USA, 2000; Volume 7.
39. Davis, M. Who Will Build The Ark? *New Left Rev.* **2010**, *61*, 29–46.
40. Shen, S.; Sotiriadis, M.; Zhang, Y. The Influence of Smart Technologies on Customer Journey in Tourist Attractions within the Smart Tourism Management Framework. *Sustainability* **2020**, *12*, 4157. [[CrossRef](#)]
41. Celdrán-Bernabeu, M.A.; Mazón, J.N.; Ivars-Baidal, J.A.; Vera-Rebollo, J.F. Smart tourism. A study on systematic mapping. *Cuad. Tur.* **2018**, *41*, 655–658. [[CrossRef](#)]
42. Khan, M.S.; Woo, M.; Nam, K.; Chathoth, P.K. Smart City and Smart Tourism: A Case of Dubai. *Sustainability* **2017**, *9*, 2279. [[CrossRef](#)]
43. Chung, H.C.; Chung, N.; Nam, Y. A Social Network Analysis of Tourist Movement Patterns in Blogs: Korean Backpackers in Europe. *Sustainability* **2017**, *9*, 2251. [[CrossRef](#)]
44. Kiatkawsin, K.; Sutherland, I.; Lee, S.K. Determinants of Smart Tourist Environmentally Responsible Behavior Using an Extended Norm-Activation Model. *Sustainability* **2020**, *12*, 4934. [[CrossRef](#)]
45. Femenia-Serra, F.; Neuhofer, B.; Ivars-Baidal, J.A. Towards a conceptualisation of smart tourists and their role within the smart destination scenario. *Serv. Ind. J.* **2019**, *39*, 109–133. [[CrossRef](#)]
46. Gretzel, U.; Sigala, M.; Xiang, Z.; Koo, C. Smart tourism: Foundations and developments. *Electron. Mark.* **2015**, *25*, 179–188. [[CrossRef](#)]
47. Vargas-Sánchez, A. Exploring the concept of smart tourist destination. *Enl. Tour. Pathmak. J.* **2016**, *6*, 178–196.
48. Buhalis, D. Technology in tourism—from information communication technologies to eTourism and smart tourism towards ambient intelligence tourism: A perspective article. *Tour. Rev.* **2019**, *75*, 267–272. [[CrossRef](#)]

49. Colby, C.; Bell, K. The On-Demand Economy Is Growing, and Not Just for the Young and Wealthy. Available online: <https://hbr.org/2016/04/the-on-demand-economy-is-growing-and-not-just-for-the-young-and-wealthy> (accessed on 15 June 2020).
50. Li, Y.; Hu, C.; Huang, C.; Duan, L. The concept of smart tourism in the context of tourism information services. *Tour. Manag.* **2017**, *58*, 293–300. [[CrossRef](#)]
51. Yoo, C.; Kwon, S.; Na, H.; Chang, B. Factors Affecting the Adoption of Gamified Smart Tourism Applications: An Integrative Approach. *Sustainability* **2017**, *9*, 2162. [[CrossRef](#)]
52. Pradhan, M.K.; Oh, J.; Lee, H. Understanding Travelers' Behavior for Sustainable Smart Tourism: A Technology Readiness Perspective. *Sustainability* **2018**, *10*, 4259. [[CrossRef](#)]
53. Lee, P.; Hunter, W.C.; Chung, N. Smart Tourism City: Developments and Transformations. *Sustainability* **2020**, *12*, 3958. [[CrossRef](#)]
54. Koo, C.; Mendes-Filho, L.; Buhalis, D. Guest editorial: Smart tourism and competitive advantage for stakeholders. *Tour. Rev.* **2019**, *74*, 1–128. [[CrossRef](#)]
55. Gretzel, U.; Zhong, L.; Koo, C. Application of smart tourism to cities. *Int. J. Tour. Cities* **2016**, *2*, 106–108. [[CrossRef](#)]
56. Buonincontri, P.; Micera, R. The experience co-creation in smart tourism destinations: A multiple case analysis of European destinations. *Inf. Technol. Tour.* **2016**, *16*, 285–315. [[CrossRef](#)]
57. Ivars-Baidal, J.A.; Celdrán-Bernabeu, M.A.; Mazón, J.N.; Perles-Ivars, Á.F. Smart destinations and the evolution of ICTs: A new scenario for destination management? *Curr. Issues Tour.* **2019**, *22*, 1581–1600. [[CrossRef](#)]
58. Gómez Oliva, A.; Server Gómez, M.; Jara, A.J.; Parra-Meroño, M.C. Turismo inteligente y patrimonio cultural: Un sector a explorar en el desarrollo de las Smart Cities. *Int. J. Sci. Manag. Tour.* **2017**, *3*, 389–411.
59. Cheung, C.M.K.; Lee, M.K.O.; Rabjohn, N. The impact of electronic word-of-mouth: The adoption of online opinions in online customer communities. *Internet Res.* **2008**, *18*, 229–247. [[CrossRef](#)]
60. Chu, S.; Kim, Y. Determinants of consumer engagement in electronic word-of-mouth (eWOM) in social networking sites. *Int. J. Advert.* **2011**, *30*, 47–75. [[CrossRef](#)]
61. Martínez-Sala, A.M.; Monserrat-Gauchi, J.; Campillo Alhama, C. The relational paradigm in the strategies used by destination marketing organizations. *Rev. Lat. Comun. Soc.* **2017**, *72*, 374–396.
62. Martínez-Sala, A.M.; Cifuentes Albeza, R.; Martínez-Cano, F.J. Las redes sociales de las organizaciones de marketing de destinos turísticos como posible fuente de eWOM. *Observatorio OBS** **2018**, *3*, 246–271. [[CrossRef](#)]
63. Campillo Alhama, C.; Martínez-Sala, A.M. La estrategia de marketing turístico de los Sitios Patrimonio Mundial a través de los eventos 2.0. *PASOS* **2019**, *17*, 425–452. [[CrossRef](#)]
64. Martínez-Sala, A.M. Marketing 2.0 applied to the tourism sector: The commercial function of the websites of destination marketing organization. *Vivat Acad.* **2018**, *143*, 1–23. [[CrossRef](#)]
65. Parra-Meroño, M.C.; Beltrán-Bueno, M.A. *Estrategias de Marketing para Destinos Turísticos*; Eumed Universidad de Málaga: Málaga, Spain, 2016.
66. Hlee, S.; Lee, H.; Koo, C. Hospitality and Tourism Online Review Research: A Systematic Analysis and Heuristic-Systematic Model. *Sustainability* **2018**, *10*, 1141. [[CrossRef](#)]
67. Shaw, G.; Bailey, A.; Williams, A. Aspects of service-dominant logic and its implications for tourism management: Examples from the hotel industry. *Tour. Manag.* **2011**, *32*, 207–214. [[CrossRef](#)]
68. Wang, Y.; Fesenmaier, D.R. Towards understanding members' general participation in and active contribution to an online travel community. *Tour. Manag.* **2004**, *25*, 709–722. [[CrossRef](#)]
69. Caro, J.L.; Luque, A.; Zayas, B. Nuevas tecnologías para la interpretación y promoción de los recursos turísticos culturales. *PASOS* **2015**, *13*, 931–945.
70. Boes, K.; Buhalis, D.; Inversini, A. Smart tourism destinations: Ecosystems for tourism destination competitiveness. *Int. J. Tour. Cities* **2016**, *2*, 108–124. [[CrossRef](#)]
71. Koo, C.; Gretzel, U.; Hunter, W.C.; Chung, N. The role of IT in tourism. *Asia Pac. J. Inf. Syst.* **2015**, *25*, 99–104.
72. Shen, S.; Sotiriadis, M.; Zhou, Q. Could Smart Tourists Be Sustainable and Responsible as Well? The Contribution of Social Networking Sites to Improving Their Sustainable and Responsible Behavior. *Sustainability* **2020**, *12*, 1470. [[CrossRef](#)]
73. González-Reverté, F.; Díaz-Luque, P.; Gomis-López, J.M.; Morales-Pérez, S. Tourists' Risk Perception and the Use of Mobile Devices in Beach Tourism Destinations. *Sustainability* **2018**, *10*, 413. [[CrossRef](#)]

74. Ramos-Soler, I.; Martínez-Sala, A.-M.; Campillo-Alhama, C. ICT and the Sustainability of World Heritage Sites. Analysis of Senior Citizens' Use of Tourism Apps. *Sustainability* **2019**, *11*, 3203. [CrossRef]
75. Silva-Pedroza, D.; Marin-Calero, R.; Ramirez-Gonzalez, G. NFC Evaluation in the Development of Mobile Applications for MICE in Tourism. *Sustainability* **2017**, *9*, 1937. [CrossRef]
76. Chianese, A.; Piccialli, F. Designing a smart museum: When cultural heritage joins IoT. In Proceedings of the 2014 Eighth International Conference on Next Generation Mobile Apps, Services and Technologies, Oxford, UK, 10–12 September 2014; pp. 300–306.
77. Lee, S.J. A review of audio guides in the era of smart tourism. *Inf. Syst. Front.* **2017**, *19*, 705–715. [CrossRef]
78. Boletsis, C.; Chasanidou, D. Smart tourism in cities: Exploring urban destinations with audio augmented reality. In Proceedings of the 11th Pervasive Technologies Related to Assistive Environments Conference, Corfu, Greece, 26–29 June 2018; pp. 515–521.
79. Emler, T. Traditional Museums, virtual Museums. Dissemination role of ICTs. *DISEGNARECON* **2018**, *11*, 13-1.
80. Owen, R.; Buhalis, D.; Pletinckx, D. Visitors' Evaluations of ICTs Used in Cultural Heritage. In *VAST; The Eurographics Association: Aire-la-Ville, Switzerland, 2005; Volume 2005*.
81. Rey, F.B.; Casado-Neira, D. Participation and technology: Perception and public expectations about the use of ICTs in museums. *Procedia Technol.* **2013**, *9*, 697–704. [CrossRef]
82. Amanda, R.; Santosa, P.; Rizal, M.N. Analysis of Tourists Preferences on Smart Tourism in Yogyakarta (Case: Vredeburg Fort Museum). *J. Phys. Conf. Ser.* **2018**, *1007*, 12040. [CrossRef]
83. Podzharaya, N.; Sochenkova, A. The Concept of Smart Tourism Based on Museum Digitalization in Montenegro. In Proceedings of the 2020 9th Mediterranean Conference on Embedded Computing (MECO), Budva, Montenegro, 8–11 June 2020; pp. 1–4.
84. Encalada, L.; Boavida-Portugal, I.; Cardoso Ferreira, C.; Rocha, J. Identifying Tourist Places of Interest Based on Digital Imprints: Towards a Sustainable Smart City. *Sustainability* **2017**, *9*, 2317. [CrossRef]
85. Gargiulo Morelli, V.; Weijnen, M.; Van Bueren, E.; Wenzel, I.; De Reuver, M.; Salvati, L. Towards intelligently-sustainable cities? From intelligent and knowledge city programmes to the achievement of urban sustainability. *TeMA J. Land Use Mobil. Environ.* **2013**, *6*, 73–86.
86. La Rocca, R.A. The Role of Tourism in Planning the Smart City. *Tema J. Land Use Mobil. Environ.* **2014**, *7*, 269–284.
87. Gretzel, U.; Werthner, H.; Koo, C.; Lamsfus, C. Conceptual foundations for understanding smart tourism ecosystems. *Comput. Hum. Behav.* **2015**, *50*, 558–563. [CrossRef]
88. The Museum Register by the Ministry of Culture and National Heritage in Poland. Available online: <http://bip.mkidn.gov.pl/pages/rejstry-ewidencje-archiwa-wykazy/rejstry-muzeow.php> (accessed on 6 April 2020).
89. Naramski, M.; Herman, K. The Development of Mobile Tourism in the Upper Silesian Metropolitan Area of Poland. *Sustainability* **2020**, *12*, 44. [CrossRef]
90. Sprout Social, Social Media Demographics to Inform Your Brand's Strategy in 2020. Available online: <https://sproutsocial.com/insights/new-social-media-demographics/> (accessed on 15 June 2020).
91. The London School of Economics and Political Science, Social Media Platforms and Demographics. Available online: <https://info.lse.ac.uk/staff/divisions/communications-division/digital-communications-team/assets/documents/guides/A-Guide-To-Social-Media-Platforms-and-Demographics.pdf> (accessed on 15 June 2020).

Publisher's Note: MDPI stays neutral with regard to jurisdictional claims in published maps and institutional affiliations.



© 2020 by the author. Licensee MDPI, Basel, Switzerland. This article is an open access article distributed under the terms and conditions of the Creative Commons Attribution (CC BY) license (<http://creativecommons.org/licenses/by/4.0/>).

Article

An Analytical Model of Tourist Destination Development and Characteristics of the Development Stages: Example of the Island of Bornholm

Adam R. Szromek

Department of Organization and Management, Institute of Economy and Informatics, Silesian University of Technology, Akademicka 2A, 44-100 Gliwice, Poland; innowator@o2.pl; Tel.: +48-32-277-7336

Received: 8 November 2019; Accepted: 17 November 2019; Published: 7 December 2019

Abstract: This paper presents the basis of the tourism area life cycle (TALC) concept and its extension in the context of the implementation of sustainable development practices in the tourist business model. The author uses the logistic function to determine the level of tourist absorption and capacity. The empirical basis of the methods used was statistics on the development of the tourist industry on Bornholm. The objective of the paper is to determine the stage of development of the tourist area of Bornholm and the consequences of this stage for business models of tourist enterprises functioning there. The results of the analysis indicate that the range of tourist absorption was reached in the 1960s–1970s, and that it is currently getting closer to the upper threshold of that range. Tourism on Bornholm, in line with the TALC concept, is currently in the stabilization stage. Future tourist trends on Bornholm depend on many factors; however, if tourist development goes into the decline stage, the offered products may require transformation, in terms of both transport and the form and availability of tourist attractions. Perhaps this will involve a total transformation of the island into a facility with a specific entertainment, leisure, or business profile. The listed solutions will require entrepreneurs to react within the scope of a transformation of their business models into sustainable models of tourist business.

Keywords: sustainability; business model; logistic function; TALC

1. Introduction

Sustainable tourism, which has been developing rapidly for only a few decades, assumes that it is necessary to responsibly manage and use the natural and cultural resources made available for tourists. It is also a concept referring to the degradation of the natural and cultural environment caused by excessive tourist activity and the infrastructure established in tourist areas (currently defined as overtourism). Starting from the 21st century, this phenomenon has become an important element in running a tourist business, because, as researchers have noted [1] since 2002 in the academic literature, one can observe a specific kind of business model which is a sustainable business model, defined as a set of components in which the components and the stakeholders interact to create, provide, capture, and list sustainable value [2]. It is, therefore, a tool to include sustainable development rules in a company's value logic and the logic of value creation [3].

For many decades, scientists have been thinking about methods of identifying the stages of development of tourist destinations and studying the impact of tourist congestion on the inhabitants of these areas. Despite many proposals, it is still difficult to define a universal tool for identifying the current stage of development of a tourist destination. However, this is often only achieved after the fact. The most frequently confirmed approach by researchers, the concept of the tourism area life cycle (TALC) proposed by Butler [4], assumes the possibility of developing tourist areas in stages, which will result in exceeding the critical tourist capacity of the area, after which a reversal of the growing trend

of increasing numbers of tourists visiting the area and a slow disappearance of the tourist function will occur. In general, it is associated with the degradation of natural and cultural areas that previously encouraged tourists to visit the area and excessively expand the tourist industry.

This paper uses the logistic function to determine the level of absorption and tourist capacity. The empirical basis of the methods used was statistics on tourism development on Bornholm. The objective of the paper is, therefore, to determine the stage of development of the tourist area of Bornholm and determine the consequences of this stage for business models of tourist enterprises functioning there.

2. Theoretical Basis of the TALC Concept and Sustainable Tourism: Literature Review

The concept of the tourism area life cycle (TALC), published in 1980 [4], describes the process of tourist area development, dividing it into stages and describing each stage. According to Butler, the development of a tourist area takes the shape of an asymptotic curve that, when repeated during the course of occurrence, creates a cyclical image of changes, which is especially visible in the number of people visiting the tourist area annually. The diagram of the concept covers six stages of evolution of a tourist town: exploration, involvement, development, consolidation, stagnation, and decline or rejuvenation (defined jointly as a stage of dichotomy divergence) [5].

When distinguishing the evolutionary stages of the area, the symptomatic variable was used in the form of the number of tourists visiting a given town during the year. This is not the only variable representing this phenomenon, as Butler, when characterizing specific stages, also used other features, including spatial and economic ones [6,7].

The first stage is the exploration stage [8]. It is present when individual tourists start to appear in small numbers in a given area, attracted by natural or cultural aspects. These are the tourists who organize their stay independently and do not use common patterns of holidays, and they have a minimal influence on the lives of locals and the local economy. Next is the involvement stage, when tourists visit a given area more often and some locals begin to profit from accommodations, catering, medical services, etc. The engagement of locals takes place by participating in the economic activity envisaged for tourists or by directing services mainly or solely toward visitors. In a tourist town, expectations emerge for organized forms of leisure, and pressure can be felt to improve transportation and facilities for tourists.

The moment when tourism becomes one of the main sources of income in a given area and the number of tourists is equal to or exceeds the number of locals, the development stage begins. This is the stage that signifies that the tourist market is well-defined. Local services are replaced by tourist organizations outside of the tourist area, and as a result, modern and complex services and products appear, the locals lose control over the development of tourist functions, local engagement decreases, and even antagonism on the part of the locals emerges.

The consolidation stage means full development of the tourist function in a given area. This is characterized by a decrease in the growth rate of the number of tourists, and tourism becomes the main area of the local economy. Next, the separation of therapeutic and tourist functions (health resorts, hotels, restaurants) from social functions (for example, households) takes place in the city space. Attempts are made to extend the tourist season and expand the territory in which the services are rendered. Antagonism on the part of locals can intensify, along with an intensification of obstacles to carrying out business.

Next is the stagnation stage, which is characterized by a steady inhibition of the growth dynamics of increased numbers of tourists, achievement of a peak number of tourists in a given area, and then a resulting decrease in visitor numbers. The tourist infrastructure, excessively burdened by too many users based on its technical capacity, starts to malfunction, which leads to economic difficulties as well as social and ecological problems. The area has well-defined but old-fashioned offerings and its image does not match the region. The development has reached the outskirts, and properties change owners.

The last stage of the cycle can be twofold: the decline stage, which results in a total collapse of health resorts, or the rejuvenation stage, starting with stabilization during the stagnation stage,

which leads to re-expansion of tourist functions. In the literature on the subject, the last stage is defined in various ways. Butler calls it a stage of decline and rejuvenation. Agarwal [5] uses the term “post-stagnation”, as it takes place after the stagnation stage. At the same time, it is a stage of dichotomy divergence, as it is characterized by the divergence of two stages (decline and rejuvenation). Even though they can occur in the same cycle, they cannot occur at the same time.

If, however, the decline stage takes place, it is characterized by a decrease in the number of tourists and closure of unprofitable hotels and spas, transforming them to other entities (for example, nursing homes, private apartments). The area cannot compete for tourists with other, more attractive towns. The service offerings decrease, and the town becomes less attractive and attracts fewer tourists. If the town has a sufficiently large infrastructure, then weekend or one-day tourists start to arrive. Engagement of the locals emerges, this time often generating demand by purchasing services that are now available at more affordable prices. The decline stage can end with total or partial disappearance of the tourist function in a given area.

The town may, however, enter the rejuvenation stage, but this is not possible without sensible and complex activities that aim to expose features that determine the attractiveness of the area. Oppermann [9] cites (and confirms) Defert’s [10] opinion, dating back five decades, that a tourist area, despite the decline stage, can begin a new life cycle. This is possible, thanks to the town’s ability to adjust its advantages to the needs of tourists and improve the attractiveness of services (through product modification). Butler proposed two solutions: the first is based on introducing artificial attractiveness (for example, by transforming entities into casinos), and the second is based on using previously unused natural resources [11].

The concept also assumes a critical point of tourist absorption and capacity, which, once reached, results in development of the area in a steady direction toward decline. It is, therefore, a symbolic point of overcrowding of the tourist area that, once achieved, degrades the tourist area and its attractiveness and, as a result, its popularity.

The analysis of Butler’s [4] concept is consistent with two economic concepts, with sources in the model of cyclical economy development by Keynes: the concept of economic growth by Rostow [12] and the product life cycle by Kotler and Turner [13]. The TALC concept, from the moment it was published, was often criticized by researchers, but more often its development scheme was discovered in many parts of the world. Butler, participating in the process of supplementing his own concept two decades after it was published, added additional features characterizing this model [14]. In 2000, Butler added the characteristics of eight elements, on which the concept is based, and six years later he expanded the concept, collecting the experiences of other researchers working with his model [14,15]. The key supplementation was the reference to weak points and advantages that the literature identified in the course of two decades and the proposal of terms explaining the reasons for development, changes, limitations, and interference in the tourist area (Figure 1). Butler named eight issues [16]: (1) dynamism: change over time, one of the most characteristic features of tourist activity; (2) process: understood as a feature that characterizes the changes taking place in a tourist area, enabling a model-based view of development; (3) tourist absorption and capacity or development limitations: the model is based on the claim that if the number of visitors exceeds the tourist absorption and capacity, the quality of their experience will decline; (4) initiative factors: factors that cause change in a tourist area, e.g., innovation; (5) management: it is crucial to emphasize the management of a tourist area as a whole (comprehensively), because many components in this area lack management, even though they have separate resources and properties; (6) long-term perspective: this perspective needs to be considered when observing an area in the initial development phase; it is an indicator of both the effectiveness of actions that delay the onset of the decline phase and intervention actions that initiate rejuvenation immediately after stabilization, typical for stagnation; (7) spatial components: if the development in an area slows down, a locational shift of the tourist area is proposed to sites where development is starting from the beginning or is continuing; and (8) universal application: the model was designed for all tourist areas, including specialized areas such as spa resorts.

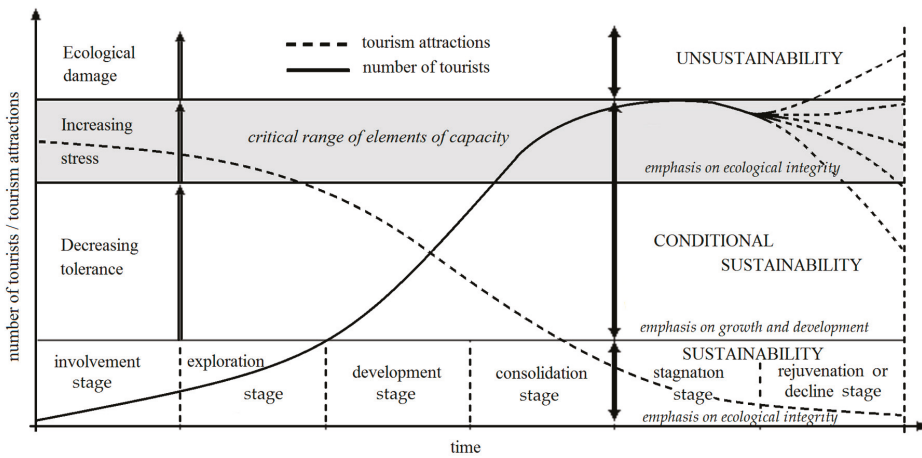

Figure 1. Sustainable development and the tourism area life cycle (TALC). Source: own work based on [4,17,18].

The literature also cites other developments of this concept, but due to the subject of this work, further discussions will focus on sustainable development issues. Within the basis of the TALC concept, one can distinguish the work by Boyd [18], who divided the cycle into several spheres. The first sphere overlaps with the first two stages in Butler’s model and is named the balance sphere, where the emphasis is placed on ecological integration as a state where ecological and biological processes of ecosystem communities achieve self-maintaining balance. The second is the sphere of conditional balance, divided into two subspheres. The first one concerns the development stage, where economic balance is desired (meaning improvement of the quality of life and the environment take place at the same time), but focuses on economic growth and development, and then (in the second subsphere) on a return to the maintenance of ecological integration. In the development stage, a decrease in environmental tolerance can be observed, and in the consolidation stage (the first stage of the critical range of tourist capacity of the area), the increased factors resulting in ecological tensions can be observed. The third sphere, located above the critical area, is the sphere of unbalance, where ecological destruction takes place.

Weaver and Lawton [19] found a gap in Butler’s [4] concept and Boyd’s proposal [18]. They assumed that the critical tourist capacity area does not change during the life cycle of a tourist area. Yet, along with the development of the area, its capacity increases when it comes to tourist absorption. This means that this sphere of tolerance, tension, and ecological damage, just like balance or its lack, does not have to be constant in the entire cycle. Weaver and Lawton [19] proposed two possible solutions for reaching a balance of supply and demand while maintaining critical capacity. The first one is about adjusting the supply to demand; along with increased visitors, the capacity to accommodate new tourists increases. It does not mean, however, that reaching a critical capacity is excluded, as it is possible that the rate of facilities’ capacity growth will not match the development pace, and that the area capacity limits will be reached. An alternative is to limit the demand to a defined supply size. Then, the critical capacity will remain unchanged, and when it is reached, balance will not be achieved, unless the gray market, which bypasses those restrictions, expands.

Weaver and Lawton [19] proposed the use of one or several of the following limitations:

- Introducing restrictions on the place or standards concerning the acceptable number of visitors
- Enforcing development standards
- Introducing limitations on the number of places and conditions for accommodation
- Introducing spheres that set limits on tourist activity development

- Introducing bans on infrastructure expansion, for example, airports, or increasing entrance fees to a tourist region (for example, visa charges), the amount of which depends on the desired demand reduction

It must be noted that in recent years, researchers and practitioners have more often developed complex solutions indicated by Weaver and Lawton. An example is the Global Sustainable Tourism Council (GSTC) [20], which developed criteria for sustainable tourism that focuses on four thematic areas: sustainable management, socioeconomic impact, cultural impact, and environmental impact (including resource consumption, pollution reduction, and biodiversity and landscape conservation). The GSTC criteria take into account guidelines and standards on environmental, social, cultural, economic, quality, human rights, health, safety, risk, and crisis management issues, as well as boost constant development. They were developed to ensure a common global understanding of “sustainable tourism” and represent a minimum that every tourist enterprise and tourist reception area should strive to achieve. Those criteria indicate what needs to be done in terms of implementation of sustainable tourism, but not how to implement it. The performance indicators are a complement to the criteria that allow determination of the level of the implementation of set goals.

Buhalis [21] noticed that destinations experience various environmental and sociocultural impacts during their development stages. He developed a set of features that characterize individual stages of development of a tourist area (according to Bull’s concept). Table 1 lists several groups of such features, and among them are:

- Destination characteristics
- Marketing response
- Economic impact
- Social impact
- Environmental impact

A decade later, Szromek [22] supplemented Buhalis’ table [21], indicating the compatibility of assigned properties of destinations with the concept of Plog [23,24], through the use of selected elements of both concepts and their reconstruction to make them useful in spa areas and extend their theoretical value, making them more utilitarian. Butler’s concept (TALC), which describes the phase development of tourist areas, uses a complex set of changes (in time) and economic characteristics that describe each phase of the tourist area for preliminary identification of the current phase of development. The second concept (Plog’s) explains the phase development of a tourist area by typological changes in the dominant group of tourists, taking into account the original typology of visitors (allocentrics, near-allocentrics, midcentrics, near-psychocentrics, and psychocentrics). Combining the scientific frameworks of these two concepts allowed an evaluation of the theoretical possibility of verifying both concepts, which would give them more importance because of not only the descriptive abilities post factum, but also the prospective feature by being able to identify the current phase of development. Ultimately, a set of features was obtained, and thus, symptoms that could help determine the various stages of development were specified. The results are presented in Table 1.

Table 1. Destination life cycle and tourism impacts according to the concept of Buhalis, supplemented by Szromek.

		Development Stages of the Tourist Area				
Plog/Butler	Exploration	Involvement	Development	Consolidation	Stagnation	Post-Stagnation
	Allocentrics					
Dominant Tourists	Near-allocentrics	Near-allocentrics				
	Midcentrics		Midcentrics			
	Near-psychocentrics			Near-psychocentrics		
	Psychocentrics					Psychocentrics
Features characterizing individual stages of tourist area development						
	Number of visitors	Few	Many	Too many	Many	Many
	Growth rate	Low	Fast growth	Fast growth	Slow growth	Declining
	Capacity of beds	Very low	Low	High	Very high	Very high
	Occupancy rate	Low	Very high	Very high	High	Low
	Service prices	High	Very high	High	Low	Very low
	Expenses per person	High	Very high	Very high	Low	Very low
	Visitor type	Drifters	Innovators	Innovators	Followers	Cheap mass market
	Brand and attractiveness	Low	Very high	High	Low	Very low
	Tourists are seen as:	Guests	Guests	Customers	Customers	Foreigners
	Marketing purpose	Awareness	Inform	Persuade	Persuade	Loyalty/new market
	Strategic focus	Expansion	Penetration	Defense	Defense	Reintroduce
	Marketing expenses	Growing	High	High	Falling	Consolidating
	Product	Basic	Improved	Good	Deteriorating	Decaying
	Promotion	Introduction	Advertising	Travel trade	Travel trade	Travel trade
	Price	High	High	Lower	Low	Below cost
	Distribution	Independent	Independent	Travel trade	Travel trade	Travel trade
		Independent	Independent	Travel trade	Travel trade	Travel trade
Marketing Response						

Table 1. *Cont.*

Development Stages of the Tourist Area						
Plog/Butler	Exploration	Involvement	Development	Consolidation	Stagnation	Post-Stagnation
Employment	–	Low	High	Very high	High	Low
Currency exchange	–	Low	Very high	Very high	High	Low
Profitability of private sector	–	Negative	Growing	Very high	High	Declining
Residents' income	–	Low	Very high	Very high	Low	Very low
Investments	–	Low	Very high	Very high	Low	Very low
National income and taxes	–	Low	Very high	Very high	Low	Very low
Economic structure	–	Balanced	Tourism oriented	Tourism dominant	Tourism dependent	Unbalanced and not set sufficient
Dependence on intermediaries	–	Negligible	Low	High	Overdependent	Overdependent
Import	–	Low	Very high	Very high	Very high	High
Inflation	–	Low	Very high	Very high	High	Low
Tourist type	Allocentric	Allocentric	Midcentric	Midcentric	Psychocentric	Psychocentric
Tourists' origin and locals	Nearby cities	Nearby cities	Region	Whole country	Country and abroad	Country and abroad
Relations between tourists and locals	–	Euphoria	Apathy	Irritation	Antagonism	Final
Social Impacts			Young settlers working in tourism; relative sustainability			Immigration due to no jobs Available and older residents
Tourist area demographics	–	Immigrants and existing residents		Balanced	Balanced	
Migrations in tourist area	–	Low	High	Very high	High	Low
Crime in tourist area	–	Low	High	High	Very high	Very high
Family structure	–	Traditional	Affected	Modern	Modern	Modern
Environment and views	Unspoiled	Unspoiled	Improved	No respect	Polluted	Damaged
Conservation and heritage	Unspoiled	Unspoiled	Improved	No respect	Decayed	Damaged
Ecological disturbance	Unspoiled	Unspoiled	Improved	No respect	Decayed	Damaged
Air pollution	Negligible	Negligible	Low	High	Very high	Very high
Water pollution	Negligible	Negligible	Low	High	Very high	Very high
Congestion and traffic jams	Low	Low	Low	Very high	Very high	Low
Erosion	Low	Low	High	Very high	Very high	Very high

Source: own work based on [21–24].

It must be noted that the measurement and identification of development stages of destinations are based on observations and experience. In the case of an island, it is also possible to refer to examples from other destinations, especially coastal tourist destinations. Therefore, previous experiences from various tourist destinations described in the literature, for example, Venice, Barcelona, Krakow, or even the Arctic [25], might provide interesting insights.

Trancoso González [26] looked at the problem of overtourism when analyzing congestion in Venice, a city that receives 30 million tourists per year and where tourists do not stop coming, also motivated by cruises (in 2017, 2.5 million people landed) [27]. However, the causes of the problem are noticed in tourism democratization, which has led to disproportionate use, not in excess but with bad management, even if increasing consumption was foreseen. In the case of the island's tourist traffic, it was proposed to shift tourists' attention to cruises.

Similar approaches were applied in other destinations. Examples include Barcelona and Palma de Mallorca. Huete and Mantecón presented an interesting analysis of these and other destinations, analyzing the phenomenon of "tourismophobia" in the scientific literature [28].

In the literature, there are many examples of the implementation of rescue or preventive solutions for excessive tourist traffic. Examples include the Biosphere Reserve in Rügen [29] and Wolin National Park in Poland [30] and many others, even global ones such as the World Network of Biosphere Reserves (669 biosphere reserves in 120 countries) [31]. Therefore, this problem is noticed in a context that goes beyond tourism, although it is very related to this human activity. Stoll-Kleemann and O'Riordan [32] described this issue in the context of biosphere reserves. They noticed that in the new era of the Anthropocene, characterized by planetary boundaries being exceeded, with negative consequences not only for "the environment" in an abstract sense, but also for humans themselves, there is an urgent need for innovative ways to showcase sustainable living practices in the light of dominant unsustainable patterns of growth and human consumption.

Even though the listed solutions for protecting the natural environment and local culture should be subjected to tourist impact analysis at every stage of tourist area development, there are tourist destination development stages where such activities should be more intense. Therefore, the TALC concept and its extensions can be useful tools for forecasting or diagnosing the situation.

A successful implementation of the proposed solutions to remedy the disappearance of the tourist function requires their constant use, to ensure that they are rooted in enterprise or community strategic goals. It is best to place them among elements creating a formal model of running a business.

Therefore, a business model is characteristic of the described business [33] or a description of relations between components in an organization that result in the creation of value for the organization [34]. In the majority of cases, it has the form of a tool used to run a business [35] or a story that explains how the enterprise works [33]. The business model is also defined as a theoretical construct that describes the activity of the business based on selected indicators [36]. One of the most accurate definitions of the business model is the one by Wit [37]. Wit states that the essence of a business model is a visual depiction of organizational functioning logic, its elements or ventures in the form of appropriately named interlinked elements of a template that, once populated with content, ensures logical understanding of the functioning, survival, and development of an organization. Visualization of this organization functioning logic requires the use of a specified concept of modeling. Among the most popular concepts is the template by Osterwalder and Pigneur [38]. This model takes into account nine interconnected and interacting elements: customer segments, value proposals, distribution channels, customer relations, revenue streams, key resources, key activities, key partners, and cost structure.

Each of these elements can have assumptions that will implement the sustainable development concept and delay the decline stage (the disappearance of the tourist function) or will make it possible to skip it by entering a new cycle. Examples of such solutions drawing from the Global Sustainable Tourism Council [20] are practices of limiting energy use, pollution, water use, and waste production. An important example of introducing sustainable tourism rules is encouraging contractors, especially

tourist enterprise suppliers, to use similar practices that support and protect the local culture and natural environment.

However, if the tourist area is in the stagnation or decline stage, pro-ecological practices are not enough, as entropy of the current local tourist industry system takes place. Then the enterprise is forced to introduce more radical actions and plans. These can be about changes in the scope of tourism product promotion or even transformation of the business activity.

3. Materials and Methods

The analysis of the intensity of tourist movement identified in a specific area is associated with several difficulties, enforcing the adoption of some assumptions. They aim to simplify the present conditions to develop a model that can explain a specific phenomenon or development mechanism. Therefore, one of the first difficulties is to quantify the tourist movement. Current attempts to describe tourist activity are limited mostly to the adoption of a specific symptomatic variable by which the size of tourist movement can be estimated, and thus approximately defined, taking into account deviation from the actual size of the movement. In the case of tourist reception areas, deviation concerning tourist movement intensity is associated with the inability to precisely measure the values that describe this phenomenon, meaning the number of visitors (including tourists), the length of their stay, etc. These values, even though they can be found in statistical reports, present movement that is registered by entrepreneurs and entities providing tourist services or by border patrols. They do not cover the total size of tourist movement, as tourists can make use of many alternatives (family or second-home stays, unregistered stays, gray market or one-day stays, etc.)

The special tourist area is, in this context, an island, where communication takes place only with the use of defined transportation channels, namely, maritime navigation and air transport. If the island does not have an airport, then visitors can only make use of water transport (ferries, ships, etc.). Due to the fact that there are specific and controllable transport channels, it is also possible to accurately capture tourist movement. It needs to be emphasized, however, that this is still an approximate number, as quite often the statistics do not differentiate tourists' from island residents' travel. Nevertheless, the observations made in such conditions allow for better approximation of the actual scale of the situation, therefore, the probability of error distorting the results is lower.

An example of such a specific tourist area is the Danish island Bornholm, which relies on passenger sea transport (with the use of several ferries) and, since 1982, air transport. The dominant means of transport is still the ferry that, for a decade, has handled more than 90% of total tourist movement [39]. This means that air traffic (with a capacity of 200,000 passengers per year) in this area will be considered marginal.

The Danish Statistics Office (Denmarks Statistik) [39] has registered passenger traffic associated with the island since 1912, and in some periods this research was extended with an additional category, passenger type (resident/visitor). This observation allowed them to notice the stability of these proportions in the years 1991–2009, when residents amounted to $30 \pm 1\%$ of passengers. Taking into account the fact that the resident population of Bornholm in the last century underwent slight fluctuations (increasing steadily until 1965 and then decreasing, on average, by 305 persons a year), the influence of this phenomenon on the proportion of residents and nonresidents was insignificant.

Therefore, taking into account the stability of the proportions of passenger groups in the studied period (1912–2018) and the probable (thanks to passenger movement control) high precision of tourist movement quantification in ferry transportation, it can be assumed that the image of the way this phenomenon was shaped (Figure 2) reflects its true status.

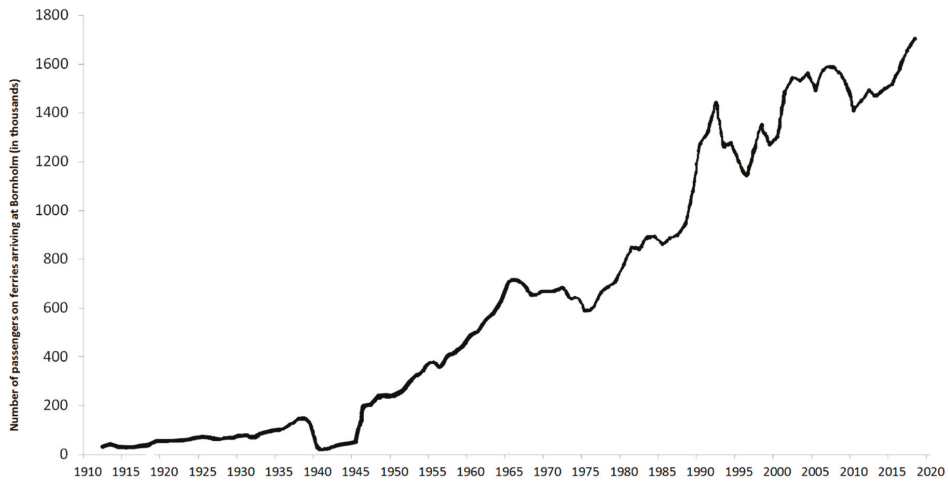

Figure 2. Amount of passenger traffic on Bornholm island, 1912–2018. Source: own study based on data from Denmarks Statistik [39].

Among important historical events that could have influenced the intensity of tourist movement on the island in the analyzed period, the following facts should be considered:

- World War II (1940–1945) significantly decreased transport movement to the island.
- There was a trend among Danish people to spend family vacations by the sea (1948–1972).
- The narrow-gauge railway that was functioning since 1900 closed in 1968; afterwards, reconstruction of internal transport took place.
- Denmark joined the EU in 1973.
- An airport was established on the island in 1982, which made it possible to offer air transport for passengers (in 1940–1968, the airport was used for other transport purposes).
- In 1999, in the whole EU, a new law was introduced that liquidated duty-free shops.
- A bridge opened in 2000 that shortened the journey from Sweden to Denmark and new, fast ferry connections decreased the travel time to Bornholm from 7 to 3 h.
- Denmark joined the Schengen Area in 2001.

Taking into account the development of tourism on Bornholm and the historical events of the area, it can be seen that this phenomenon takes the form of a logistic function (1):

$$y_t = \frac{k}{1 + be^{-at}} \quad (1)$$

where y_t is a variable determining the development of the analyzed phenomenon (explained variable); t is the time variable; a , b , k are parameters of the logistic function; and e is the base of the natural logarithm (mathematical constant; $e \approx 2.7182$).

The parameters for this logistic function were estimated by Hotelling [40,41]. According to this method, parametric estimation has two stages. First, the least squares method determines parameters a and k (transformed form of a linear function), then parameter b is estimated by performing the least squares estimation again.

The comparative analysis also uses the Pearson linear correlation coefficient r_{xy} and the determination coefficient R^2 to determine the quality of the quantitative model.

4. Results of Own Research: Logistics Analysis of Tourist Area Development

The analysis of the tourist movement development on Bornholm (possible thanks to long-term statistical reporting carried out on the island) shows that Bornholm is often used as a base to test Butler's concept of the tourist area life cycle [4]. Even though the world literature on the subject notes several cases when the concept was confirmed, it is very rare that one can analyze hundred-year-long periods that still have not reached the last stage.

Among the works that tested Butler's concept are works by Lundtorp and Wanhill [42], who, in 2001, estimated the logistic function as a mathematical reflection of the course of the development of Bornholm [42]. While a logistic function is a good model that can explain the development of many economic phenomena, its interpretation is not an easy task. Yet, Lundtorp and Wanhill undertook an estimation of the function and described its properties in the context of stages described by Butler, using data from the period 1912–1999. The result of their work was a logistic function developed for the period 1912–1967, as follows (2):

$$FB_{LW} = 35 + \frac{985}{1 + e^{-0.11(t-1960)}}. \quad (2)$$

The experiment was about verifying the function estimation correctness (LWF) of the described phenomenon based on a limited number of observations. Even though Lundtorp and Wanhill emphasized the exceptional usefulness of development modeling with the use of a logistic function, they also proved that it is useless if the first stages of the cycle are not fully formed. This thesis was confirmed in their paper from 2006 [43,44].

The logistic function (SFw) developed by the author with the use of data from the period 1912–2009 is slightly different (3):

$$SFw = \frac{1402.18}{1 + 635e^{0.12t}} \quad (3)$$

The above functions reveal a significant inconsistency when it comes to function maximum, and thus allow the error size B that results from the difference $SFw_{ma} - WLF_{max}$ to be shown. Thus, it was empirically confirmed that the model has prediction features only if the majority of stages are formed; moreover, it does not allow prediction of the last stage of the cycle (decline). Therefore, it acts as a function describing the phenomenon ex post.

However, it is worth analyzing one more possibility. Among the factors that can distort the course of tourist area development are military events and catastrophes. Undoubtedly, World War II significantly limited travel opportunities, which is evident from the statistics from that period. However, if we analyze the same time range while filling in probable sizes of tourist movement on the island (estimated with the use of linear interpolation), the function (SF) takes a completely different shape (4):

$$SF = \frac{1718.95}{1 + 71.92e^{-0.07t}}. \quad (4)$$

The logistic function SF , where the influence of World War II on the development of tourist movement on the island is limited, indicates a new maximum that is greater than the maximum of the previous functions SFw and LWF . At the same time, both functions (SF and SFw) indicate an equally good fit to the empirical data ($R^2 = 0.84$). However, the data obtained from the last decade significantly deviate from the SFw function, which indicates that the SF function is more reliable (Figure 3).

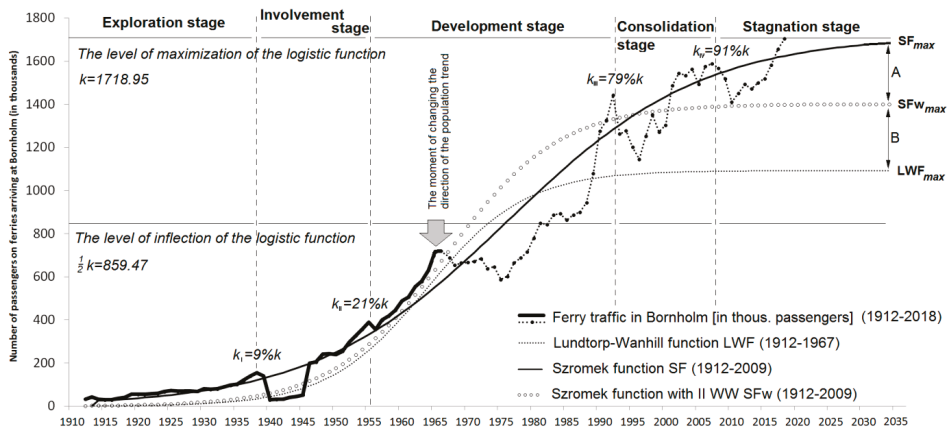

Figure 3. Logistic functions for passenger traffic of Bornholm island, 1912–2018. Source: own study based on data from Denmark's Statistik [39].

What Lundtorp and Wanhill also achieved is knowledge on the subject of the stage-division of a cycle that exceeds the so-called inflection point. Analyzing the function, and especially its characteristic points (calculating zero places with the use of subsequent derivatives), they established that a natural division resulting from the logistic function is in five stages: the first one covers the area from 0% to 9% of the maximum function value and the subsequent ones from 9% to 21%, 21% to 79%, and 79% to 91% of maximum (100%). Thus, proper estimation of the logistic function allows calculation of both the inflection point and the function maximum, which, in turn, makes it possible to determine particular stages of the model.

Lundtorp and Wanhill assumed that the stages resulting from logistics function properties and the mathematical division of the logistics function overlapped with the stages defined by Butler [4]. When analyzing the history of Bornholm and the events that could have influenced the changes in tourist movement on the island in the context of feature characteristics for subsequent TALC stages, it seems probable.

In line with this analysis, the exploration stage took place before 1940, therefore it can be assumed that the period 1912–1940 was when the island was visited only for the purpose of getting to know a new area, without any evident signs of tourist function in that area. It must be noted that because Denmark was neutral, the influence of the Great War on passenger movement in Bornholm ports cannot be observed.

The second stage of the island's tourist development (involvement stage) consists of the years 1940–1955. It can be divided into two important periods in the island's history. In 1940–1945, Denmark was occupied by Nazi troops. At that time, passenger movement was minimal. The postwar era was about further development of railway transport on the island and greater intensity of tourist movement, due to a trend among the Danish to spend family holidays on the seaside.

The growth stage shown in Diagram 3 in 1955–1994 was the time when the number of visitors increased. This growth was not regular but varied in specific moments of the island's history. An example is a breakdown in the growth trend in 1966–1976, when the means of internal transport underwent transformation. The growth trend continued along with the accession of Denmark to the EU, which probably increased the share of foreign tourists in the region (verifying this assumption is not possible).

After 1994, a consolidation of tourist areas took place: the growth trend of the number of tourists collapsed and took on a new shape, a result of inhibition of the increased number of visitors. It is therefore a signal that the area entered the stagnation stage.

The technical analysis indicates that the maximum number of visitors will be reached in the stagnation stage, and thus in the whole cycle (at the level of 1.7 million passengers), in the third decade of the 21st century. It does not mean, however, that carriers will not notice such numbers of passengers until that time, but this number may not be constant and stabilization at this level may take place after 2025.

It is worth noticing another characteristic of the change of the tourist area in the context of overtourism. The expansion of tourism and its intensification consequently led to the disappearance of local culture and displacement of locals residing in tourist areas. This can be proven by observing many cities that are intensely visited by tourists. This influence is particularly visible in the case of tourism on islands.

The analysis of the number of residents of Bornholm indicates that in the middle of the development stage and at the time of breaking the logistic function, a qualitative change in the population number trend took place. Whereas until 1966, the population of Bornholm was positively correlated with the number of visiting tourists ($r_{xy} = 0.787$), after that period, the correlation between these variables was negative and much higher ($r_{xy} = -0.885$). The conclusion, based on the above observation, indicates that the level of critical capacity and absorption of tourism of Bornholm started at the end of the 1960s (Figure 4).

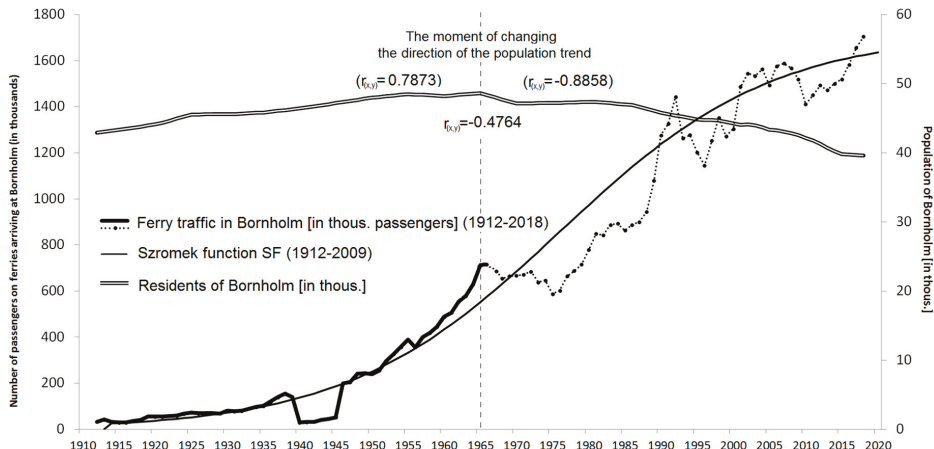

Figure 4. Comparison between the number of tourists on Bornholm and the population living on the island, 1912–2018. Source: own study.

The decline in the island's population is not surprising. The migration of tourist destinations caused by tourist congestion is found in many popular cities. It is possible to stop this trend. The solution may be to reduce congestion either by limiting tourist traffic (but also limiting income) or by expanding the tourist area, which can dissipate the excess tourists. An interesting solution to the problem of tourist congestion on the island of Bornholm is to introduce changes in transport (sea and air) and develop tourist offerings, limiting tourist traffic on land and increasing it in the form of cruises around the island.

5. Conclusions

The scientific value of this paper lies in the correction of previous research in this area, but also in providing a better tool for analyzing the stages of tourism development on Bornholm. The obtained analytical model, combined with the cited concepts of tourist destination development, make it possible to see the current phase of tourism development on the island and changes in the population of inhabitants.

The consequences of the observed changes concern not only the resident population but also enterprises operating on the island. The business model of a tourist enterprise, located in a tourist area that is in the involvement or exploration stage, will differ from the business model of an enterprise functioning in an area in the consolidation or stagnation stage. Due to the conditions faced by enterprises carrying out tourist activities at a time of excessive tourism movement, such a business model should also take defined elements into account.

In the case of Bornholm, the range of tourist absorption was reached in the 1960s–1970s, and currently it is getting closer to the upper threshold of that range. This means that if tourist enterprises functioning on Bornholm have not yet introduced remedial solutions to their business models, they should do so as quickly as possible. Referring to the concepts by Boyd [18], Butler [4], and Plog [24], the tourist area on Bornholm is entering the stage of unbalance, along with the consequences.

The future tourist trends on Bornholm depend on many factors; however, if tourist development goes into the decline stage, the offered products may require transformation, in terms of both transportation and the form and availability of tourist attractions. Perhaps it will become necessary to expand the airport near Ronne and increase tourist movement by plane. Another option is to transfer tourist movement from land to sea. Perhaps it will be total transformation of the island into a facility with a specific entertainment, leisure, or business profile. The listed solutions will require entrepreneurs to react regarding the scope of transformation of their business models into sustainable models of tourist business. This means that the solution to the described problem of island congestion may be to develop a proper approach to tourism management on the island that is focused on sustainable tourism. However, while sustainable tourism generally concerns protection of the natural environment, this time its basic task will be to protect the indigenous culture of the island.

Funding: This research received funding by the National Science Center in Poland.

Acknowledgments: This paper was published as part of the research project ‘A business model for health resort enterprises’, No. 2017/25/B/HS4/00301, supervised and financed by the National Science Center in Poland as part of statutory research No. 13/990/BK_19/0138 at the Silesian University of Technology, Faculty of Organization and Management.

Conflicts of Interest: The author declares no conflicts of interest. The funders had no role in the design of the study; in the collection, analysis, or interpretation of data; in the writing of the manuscript; or in the decision to publish the results.

References

1. Nosratabadi, S.; Mosavi, A.; Shamshirband, S.; Zavadskas, E.K.; Rakotonirainy, A.; Wing Chau, K. Sustainable Business Models: A Review. *Sustainability* **2019**, *11*, 1663. [[CrossRef](#)]
2. Geissdoerfer, M.; Bocken, N.M.; Hultink, E.J. Design thinking to enhance the sustainable business modelling process—A workshop based on a value mapping process. *J. Clean. Prod.* **2016**, *135*, 1218–1232. [[CrossRef](#)]
3. Abdelkafi, N.; Täuscher, K. Business models for sustainability from a system dynamics perspective. *Organ. Environ.* **2016**, *29*, 74–96. [[CrossRef](#)]
4. Butler, R.W. The Concept of the Tourism Area Cycle Evolution: Implications for Management of Resources. *Can. Geogr.* **1980**, *24*, 5–12. [[CrossRef](#)]
5. Agarwal, S. Restructuring seaside tourism. The resort lifecycle. *Ann. Tour. Res.* **2002**, *29*, 25–55. [[CrossRef](#)]
6. Szromek, A.R.; Kapczyński, A. Hypotheses concerning the development of Polish spas in the years 1949–2006. *Tour. Manag.* **2008**, *29*, 1035–1037.
7. Szromek, A.R.; Kruczek, Z.; Using, R.W. Butler’s Model to Interpret the Development of Tourist Attractions, Based on the Example of the Salt Mine in Wieliczka. *Folia Turistica* **2011**, *25*, 249–265.
8. Szromek, A.R. Cykliczność rozwoju uzdrowisk na przykładzie uzdrowisk polskich. In *Uzdrowiska i Ich Znaczenie w Gospodarce Turystycznej*; Szromek, A.R., Ed.; Proksenia: Kraków, Poland, 2010; pp. 17–40.
9. Oppermann, M. What is New with the resort cycle? *Tour. Manag.* **1998**, *19*, 181–183. [[CrossRef](#)]
10. Defert, P. Essai de localization touristique. *Tour. Rev.* **1954**, *9*, 119.
11. Szromek, A.R.; Model, R.W. Butlery, jako podstawa kreowania strategii rozwoju rynku polskich uzdrowisk XXI wieku. *Marketing i Rynek* **2006**, *5*, 36–39.

12. Rostow, W.W. Stages of economic growth. *Econ. Hist. Rev.* **1959**, *12*, 1–16. [CrossRef]
13. Kotler, P.; Turner, R.E. *Marketing Management*; Prentice-Hall: Scarborough, ON, Canada, 1993; pp. 3271–3397.
14. Butler, R.W. (Ed.) The Origins of the Tourism Area Life Cycle. In *The Tourism Area Life Cycle. Vol. 1. Applications and Modifications*; Channel View Publications: Cleveland, OH, USA, 2006; pp. 13–26.
15. Butler, R.W. The resort cycle two decades on. In *Reflections on Experience*; Cassell: London, UK, 2000; pp. 284–298.
16. Oreja, J.R.; Rodriguez Parra-Lopez, E.; Yanes-Estavez, V. The sustainability of island destinations: Tourism area life cycle and teleological perspectives. The case of Tenerife. *Tour. Manag.* **2008**, *29*, 53–65. [CrossRef]
17. Lundgren, J.O. An empirical interpretation of the TALC: Tourist Product Life Cycles in the Eastern Townships of Quebec. In *The Tourism Area Life Cycle. Vol. 1. Applications and Modifications*; Butler, R.W., Ed.; Channel View Publications: Toronto, ON, Canada, 2006; Volume 1, pp. 91–106.
18. Boyd, S.W. The TALC Model and its Application to National Parks: A Canadian Example. In *The Tourism Area Life Cycle: Applications and Modifications*; Butler, R.W., Ed.; Channel View Publications: Clevedon, UK; Buffalo, NY, USA; Toronto, ON, Canada, 2006; pp. 119–138.
19. Weaver, D.; Lawton, L. *Tourism Management*; John Wiley & Sons: Milton, Australia, 2006; p. 320.
20. Global Sustainable Tourism Council. GSTC Criteria for Hotels. GSTC Criteria for Tour Operators. GSTC Criteria for Destinations. Available online: <http://www.gstcouncil.org/gstc-criteria/> (accessed on 1 August 2019).
21. Buhalis, D. Marketing the Competitive Destination of the Future. *Tour. Manag.* **2000**, *21*, 97–116. [CrossRef]
22. Szromek, A.R. Development of Tourism and Spa Areas in the Concepts S.C. Plog and R.W. Butler. In *Research Bulletins of the Silesian University of Technology-Organisation and Management*; No. 54; Publishing House of the Silesian University of Technology: Gliwice, Poland, 2010; pp. 305–322.
23. Plog, S.C. Why Destination Areas Rise and Fall in Popularity. *Cornell Hotel Restaur. Adm. Q.* **1974**, *14*, 55–58. [CrossRef]
24. Plog, S.C. Why Destination Areas Rise and Fall in Popularity: An update of a Cornell Quarterly classic. *Cornell Hotel Restaur. Adm. Q.* **2001**, *42*, 13–24. [CrossRef]
25. Kruczek, Z.; Kruczek, M.; Szromek, A.R. Possibilities of Using the Tourism Area Life Cycle Model to Understand and Provide Sustainable Solution for Tourism Development in the Antarctic Region. *Sustainability* **2018**, *10*, 89. [CrossRef]
26. Trancoso González, A. Venice: The problem of overtourism and the impact of cruises. *Investig. Reg. J. Reg. Res.* **2018**, *42*, 35–51.
27. Responsible Travel. Available online: <https://www.responsibletravel.com/copy/overtourism-in-venice> (accessed on 22 October 2019).
28. Huete, R.; Mantecón, A. El auge de la turismofobia ¿hipótesis de investigación o ruido ideológico? *PASOS Rev. Tur. Patrim. Cult.* **2018**, *16*, 9–19. [CrossRef]
29. Monge-Ganuzas, M. Geological heritage in biosphere reserves. In Proceedings of the Actas del VIII Congreso de la Red Mundial de Reservas de la Biosfera Islas y Zonas Costeras, Menorca, Spain, 22–26 May 2018.
30. Wolin National Park. Available online: <http://www.wolinpn.pl/index.php?page=45> (accessed on 22 October 2019).
31. Roychoudhury, N.; Sharma, R.; Mishra, R.K. World Network of Biosphere Reserves. *Van Sangyan* **2017**, *4*, 51–52.
32. Stoll-Kleemann, S.; O’Riordan, T. Biosphere Reserves in the Anthropocene. In *The Encyclopedia of the Anthropocene*; Dominick, A.D., Michael, I.G., Eds.; Elsevier: Oxford, UK, 2018; Volume 3, pp. 347–353.
33. Magretta, J. Why business models matter? *Harv. Bus. Rev.* **2002**, *80*, 86–92.
34. Battistella, C.; Toni, A.; Zan, G.; Pessot, E. Cultivating business model agility through focused capabilities: A multiple case study. *J. Bus. Res.* **2017**, *73*, 65–82. [CrossRef]
35. Teece, D. *Business Models and Dynamic Capabilities*; Long Range Planning: London, UK, 2017; Volume 51, pp. 1–10.
36. Dworak, J. Modele biznesu współczesnych przedsiębiorstw. *Przedsiębiorstwo Współczesnej Gospodarki Teoria Praktyka* **2006**, *4*, 17–30.
37. Wit, B. *Ekologizacja w Systemie Zarządzania Odpadami Niebezpiecznymi*; Towarzystwo Naukowe Organizacji i Kierowania, Stowarzyszenie Wyższej Użyteczności DOM ORGANIZATORA: Toruń, Poland, 2016.

38. Osterwalder, A.; Pigneur, Y. *Business Model Generation: A Handbook for Visionaries, Game Changers, and Challengers*; John Wiley & Sons: Hoboken, NJ, USA, 2010.
39. Denmarks Statistik. Baza Urzędu Statystycznego Danii. Available online: <http://www.statbank.dk/statbank5a/default.asp?w=1024> (accessed on 22 October 2019).
40. Oliver, F.R. Methods of Estimating the Logistic Growth Function. *J. R. Stat. Soc. Ser. C (Appl. Stat.)* **1964**, *13*, 57–66. [[CrossRef](#)]
41. Skrobacki, Z. Selected methods for the estimation of the logistic function parameters. *Eksploracja Niezawodność* **2007**, *3*, 52–56.
42. Lundtorp, S.; Wanhill, S. The resort lifecycle theory. Generating Processes and Estimation. *Ann. Tour. Res.* **2001**, *28*, 947–964. [[CrossRef](#)]
43. Lundtrop, S.; Wanhill, S. Time Path Analysis and TALC Stage Demarcation. In *The Tourism Area Life Cycle: Conceptual and Theoretical Issues*; Butler, R.W., Ed.; Chanel View Publications: Toronto, ON, Canada, 2006; Volume 2, p. 146.
44. Moore, W.; Whitehall, P. The tourism area lifecycle and regime switching models. *Ann. Tour. Res.* **2005**, *32*, 112–126. [[CrossRef](#)]



© 2019 by the author. Licensee MDPI, Basel, Switzerland. This article is an open access article distributed under the terms and conditions of the Creative Commons Attribution (CC BY) license (<http://creativecommons.org/licenses/by/4.0/>).

Article

Winter Sports Resorts and Natural Environment—Systematic Literature Review Presenting Interactions between Them

Michał Żemła

Department of Tourism and Regional Studies, Pedagogical University in Cracow, 30-084 Cracow, Poland; michal.zemla@up.krakow.pl

Abstract: The systematic literature review method was adopted to analyze the content of papers published since 2001 that focused on interactions between winter sports resort operations and the natural environment. A total of 86 papers published in journals indexed in SCOPUS data base were analyzed. Three main groups of topics presented in analyzed papers were found: the environmental impact of winter sports resorts, the management of environmental impacts and sustainable development of winter sports resorts, and finally the impact of climate change on winter sports resort operations. The biggest number of publications were devoted to the latter topic, and interest in conducting research within this area has apparently grown during the last two decades. However, most conclusions reached by the authors of numerous studies are site-specific and difficult to extend to other resorts/destinations. Additionally, the conclusions presented in many papers are contrary to the results achieved in other publications. Several gaps in our contemporary scientific knowledge and directions of future research are suggested in addition to the abovementioned results of the analysis conducted in the presented paper as the final conclusion of the research.

Keywords: winter sports; winter sports resorts; climate change; ecological impact; sustainable development

Citation: Żemła, M. Winter Sports Resorts and Natural Environment—Systematic Literature Review Presenting Interactions between Them. *Sustainability* **2021**, *13*, 636. <https://doi.org/10.3390/su13020636>

Received: 18 December 2020

Accepted: 6 January 2021

Published: 11 January 2021

Publisher's Note: MDPI stays neutral with regard to jurisdictional claims in published maps and institutional affiliations.



Copyright: © 2021 by the author. Licensee MDPI, Basel, Switzerland. This article is an open access article distributed under the terms and conditions of the Creative Commons Attribution (CC BY) license (<https://creativecommons.org/licenses/by/4.0/>).

1. Introduction

“Ski resort” is not a term defined in the literature, and usually it is used to name a locality where an infrastructure for skiers is located [1]. Some authors use this term to define a set of lifts and slopes under common management and accessed with a common ticket [2]. Less controversial are the terms “ski area” and “ski field,” which are used almost only in the second stated possible meaning of “ski resort” [3,4]. The terms “ski resort,” “ski area,” and “ski field” are the traditional ones and have been commonly used for many decades, yet during this time several changes occurred. The most important one was the invention and growing popularity of snowboarding, usually using the same infrastructure that was prepared for alpine skiing. That was the reason why the terms underlying the word “ski” became insufficient, and “winter sports resort” or “winter sports destination” came into use. Contemporarily both terms “ski resort” and “winter sports resort” are used commonly to label the same entity. To keep the consistency of the text in the presented paper the term “winter sports resorts” is being used solely and is understood to be a tourist destination of a special kind, identified by the unique tourism infrastructure and how visitors spend their time there [4]. If it is agreed that a tourist destination is a place with physical, historical, and ethnographic features that differentiate it from others in such a way that it can attract non-residents and develop one or more different kinds of tourism [5], the winter sports resort or destination may be defined as a geographical, economic, and social unit consisting of all those firms, organizations, activities, areas, and installations that are intended to serve the specific needs of winter sports tourists [6]. This approach emphasizes the complex character of a ski resort with a clear indication of the role of supplementary services (hotels, gastronomy, entertainment) and environment. However, the presented

terms might be used with a different meaning in the papers analyzed here. It is clear that infrastructure in winter sports resorts nowadays embraces much more than ski lifts and slopes and can be connected also with other winter activities, including cross-country skiing, ski touring, sledges, toboggans, and ice skating [7]. However, this does not change the fact that in most of the cases lifts and slopes are the main reason to visit a resort [4]. Additionally, the problems presented in this paper concerning the relationship of winter sports resorts with the natural environment are visible mainly in the cases of alpine skiing and snowboarding infrastructure [8]. That is also the reason why most of the analyzed texts are focused on alpine skiing and snowboarding when we analyze “ski resorts” or “winter sports resorts.”

Winter sports resorts are a special type of tourist destination due to, among other things, the complex and two-way nature of their relationship with the natural environment. These resorts’ success depends on the specific features of the environment, the lay of the land, climate, and transport accessibility [7]. On the other hand, winter sports resorts are also often perceived as places where particular threats to nature occur [8]. This is due to the large-scale nature of investments that interfere with nature, the accumulation of a large number of tourists, and also the fact that they are usually established in mountain areas characterized by the highest value and sensitivity of ecosystems. All this is the reason why the interaction between the natural environment and winter sports resorts is the subject of multiple scientific studies conducted by representatives of various scientific disciplines. These studies have also been conducted for many years [7,9–12], but it should be noted that the subject of interest in this research has evolved over the years due to the increasing scope of scientific knowledge and due to new challenges that have arisen. Today, undoubtedly, an example of a challenge like this is global warming, which calls into question the presence of natural snow cover in many places where winter sports are traditionally played [13]. The relationship between winter sports resorts and the natural environment, and, in particular, the scale of the negative impact of the development of winter sports on the surrounding nature, are also the subjects of multiple and often very highly charged emotional debates of a political nature, dominated by catchy arguments based on far-reaching simplifications, used both by representatives of ecological and environmental organizations and by promoters of winter sports development.

Despite the significant increase in scientific research on the impact of winter sports resorts on the environment or on how the environment influences the way these resorts operate, the common scientific knowledge on this subject is highly fragmented. In many cases, highly specific issues are the subject of research—for example, the impact of the development of a winter sports resort on particular species of amphibians or grasses, which, in addition, are site-specific, while works that show in a more comprehensive way the relationship between nature and how the winter sports resorts operate are missing [14,15].

The research carried out according to the systematic approach to literature review methodology is an attempt to collect and structure the contemporary scientific achievements on the subjects of the relations between winter sports and the environment and of the sustainable development of winter sports resorts. The research took into account publications that were published during 2000–2020 in journals indexed in the SCOPUS database. This time span allowed not only to indicate the most interesting areas of scientific research, but also to observe how they have changed over the last 20 years.

2. Materials and Methods

Like many other review papers [16,17], this paper takes a systematic approach [16,18,19] to the literature review. A systematic review is a specific method that locates existing studies, selects and evaluates contributions, analyzes and synthesizes data and reports the evidence in such a way that it allows to reach reasonably clear conclusions about what is known and what is not [20].

The synthesis of the findings is the key point of all systematic reviews [21–23]. There are many methods to approach a systematic review. As the data for this review (the papers

collected) contain a combination of quantitative and qualitative research, pure quantitative analysis of the data is not appropriate. The aim of this review is not to assess all literature written on the sustainable development of winter sports resorts or on the interactions between winter sports and the natural environment, but rather to capture the current state of our scientific knowledge in the specific area.

The review seeks to create a comprehensive database of all tourism and hospitality journal articles published between January 2000 and April 2020 covering the issue of a relationship between the natural environment and the management of winter sports resorts. There are a number of different approaches to selecting databases to search for suitable publications, which let you use a different number and different kinds of databases, starting from scientific search engines (google.scholar.com) [24,25], through indexing bases (SCOPUS, Web of Science) [24–30], ending with full-text sources of references (e.g., EBSCOHost, Science Direct) [24,31]. It was decided to use the SCOPUS data set as a source. It is one of the most appreciated and complete indexing reference databases, which is a guarantee of the scientific quality of publications presented there. SCOPUS has been widely used so far as a sole data set for literature reviews [26,32–34]. According to Meho and Rogers [35] this data set is especially useful for literature reviews in the fields of life sciences and social sciences, which are the most important scientific disciplines dealing with the issues analyzed in the paper. However, SCOPUS does not provide full-text versions of indexed papers [26,28,29]. This choice required subsequently finding full-text versions of the selected papers in other sources.

Since the researched topic contained a set of different relations, a complicated search strategy was adopted. The key words: (ski OR “winter sports”) AND (sustainability OR climate OR environment OR green OR ecological) AND (management OR business) were used to search titles, keywords, and abstracts of publications. Additionally, the search was limited to scientific papers only and to finished publications. Additionally, to exclude papers that were not related to the area of the research, the results were limited to papers in environmental, social, and business sciences. Finally, the time span, i.e., 2001–2020, was set. The presented search strategy allowed to detect a group of 168 publications. The next step was to read carefully the abstracts of all selected papers and to reduce the list by skipping the papers that did not fit the topic. The final list of accepted papers was 86 items [36–121]. The reasons why some papers were skipped were diverse. Most frequently, these were the papers that presented a general idea of tourism development in a particular area and winter sports resorts were just one field of such a development, and an in-depth study was not made. Another group of papers we skipped contained articles dealing with cable cars or lifts but with those that were used for purposes other than winter sports. Finally, there were several articles that presented the general problems of nature conservation in a particular area, and winter sports were analyzed only as part of the environmental impact on nature and, again, an in-depth study was not made. As the last step, an in-depth study was made of all papers contained in the final list to analyze their methods and conclusion.

3. Results

3.1. Topic Covered

All selected papers were divided into three categories (however, one paper could have been put into two categories at the same time) regarding the topics analyzed in the article. Those topic categories were as follows: environmental impact of the construction and operation of winter sports resorts (“environmental impact”), management of the sustainable development of resorts (“management”), and impact of climate change on the operation of resorts (“climate change”). Finally, four papers were focused on other topics and were put into the fourth category that was labeled as “others.”

From among 86 scientific articles analyzed, as many as 51 were devoted to the issue of climate change, 30 were included in the “management” category, and 23 were included in the “environmental impact” category (Table 1). Moreover, four articles dealt with other issues, not related to any of the three subject groups mentioned above. They were: the

influence of the weather on the sale of ski-tickets; the impact of ecological uncertainty on the management of resorts; stakeholder cooperation in the ski region versus ecotourism region; and the perception of avalanche danger by skiers.

Table 1. Number of Papers Published Year by Year.

	Climate Change	Environmental Impact	Management	Others	Total
2020	3	0	0	0	3
2019	12	2	5	0	19
2018	3	1	2	1	7
2017	2	0	1	1	4
2016	4	3	2	1	10
2015	5	0	0	0	5
2014	6	1	2	0	9
2013	6	2	4	0	12
2012	0	6	4	0	10
2011	3	2	3	0	8
2010	1	1	0	0	2
2009	0	3	2	1	6
2008	2	0	1	0	3
2007	1	0	1	0	2
2006	2	0	1	0	3
2005	0	1	0	0	1
2004	0	0	1	0	1
2003	1	1	1	0	3
2002	0	0	0	0	0
2001	0	0	0	0	0
Total	51	23	30	4	108

The number of publications that dealt with the relations between the operation of winter sports resorts and the natural environment in the last two decades was highly variable, but it was clear that many more of them were created in the second decade than in the first decade of the century. During the first years of this decade (2011–2012), the number of publications on the “environmental impact” and “management” largely increased, while during the following years, the “climate change” subject became much more popular. As many as 42 out of 51 publications identified as addressing the “climate change” subject were created in the years 2013–2020. This was as much as 69% of publications published in those years. The authors’ growing interest in the “climate change” subject was also evidenced by the average age of the publications analyzed. Publications on this subject were, on average, 5.1 years old, while the average age of articles on the “environmental impact” was 7.7 years, and on “management” was 7.3 years. The increasing number of publications on climate change over the last decade should not be a surprise. This topic was not particularly popular in the public debate even at the end of the 20th century, not only in the debate on winter sports, while the second decade of the 21st century was a time of rapidly growing social awareness of the consequences of climate change. It was also the time when the problem of maintaining snow cover in the winter season more and more severely affected an increasing number of resorts.

Big and growing interest in the “climate change” subject was also reflected in the number of citations of the articles analyzed. Despite the fact that, on average, articles on “climate change” were more than two years younger than the other articles, they were cited most often—the average number of citations was 32, while in the case of “environmental impact” and “management,” it was 16 and 31, respectively. A clear difference between the number of citations of these two topics was also highly conspicuous, and the average number of citations for “environmental impact” was two times lower than for those for “management.” Seven publications among the analyzed ones were cited over 100 times, and the most frequently cited item was cited over 200 times (Table 2). From among the most frequently cited publications in Table 2, as many as four, and these are the four with

clearly the highest citation index, were works on the “climate change” subject. Moreover, all four articles were linked by the co-author, i.e., D. Scott. It is also worth noting that the publications listed in Table 2 clearly dominated over the others in terms of the number of citations. Only several works had more than 80 citations. It is also worth remembering that the average number of citations index in the case of publications issued over many years covers very large discrepancies between individual articles. Publications published in recent years have been cited very rarely so far; some of them have not yet been cited at all, which is natural. All the articles contained in Table 2 were published in the first decade of the century; items with only slightly fewer citations also came from the same period of time. In this context, it is worth paying attention to two articles that clearly broke out of this pattern. The first of them was Steiger et al. (2019) [43], which managed to be cited 44 times over the year, while all other publications from 2018–2020 were cited only 34 times in total. The second one of them was the article by J. Dawson and D. Scott, (2013) [87], which was the only one published after 2009 to have received more than 70 citations (86). It is worth noting that both of these items were on “climate change” (the article by Dawson and Scott (2013) was also on “management”).

Table 2. The Most Commonly Cited Articles.

Authors	Topic	Number of Citations
Scott, D., McBoyle, G., Mills, B. [120]	Climate change	219
Scott, D., McBoyle, G. [114]	Climate change	173
Scott, D., McBoyle, G., Minogue, A., Mills, B. [116]	Climate change	152
Scott, D., Dawson, J., Jones, B. [111]	Climate change	135
Rivera, J., de Leon, P. [119]	Management	123
Sharma, S., Aragón-Correa, J.A., Rueda-Manzanares, A. [113]	Management	112
Wipf, S., Rixen, C., Fischer, M., Schmid, B., Stoeckli, V. [118]	Environmental impact	108

3.2. People and Places

The issue of the relationship between the operation of winter sports resorts and the natural environment was taken up by researchers from almost all continents. Most often these were scientists affiliated with the USA (18 articles), Austria (16 articles), and Canada (11 articles). In addition, researchers affiliated with France, Spain, Italy, Germany, Switzerland, and Australia were also authors or co-authors of more than five articles. Among the scientists, there were also representatives of countries like Andorra, Serbia, Bulgaria, Finland, Japan, Iran, and Malaysia. By far, D. Scott, who was the co-author of all 11 publications affiliated with scientists from Canada, was the most active author. In addition, R. Steiger was co-author of seven publications while M. Pons was a co-author of five articles. It should be noted that all three authors often published articles jointly and all their presentations were focused on “climate change.” It is also worth noting that D. Scott was one of the precursors of research on the impact of climate change on winter sports resorts, and his publications were written during the entire period that was being analyzed—the oldest was written in 2003, the newest in 2020.

The analyzed articles were published in multiple journals of various profiles. This was very clearly shown by the fact that the most articles published in the same journal was eight. This applied to *Tourism Management* and to the *Journal of Sustainable Tourism*. Nevertheless, the next journals in this ranking were *Environmental Management* and *Journal of Outdoor Recreation and Tourism*, from which only four articles were taken. Most articles were published in journals dealing with the subject of tourism (apart from those mentioned, they were, among others, *Current Issues in Tourism* and *Tourism Review*), but they were

also published in journals devoted to issues of, broadly understood, ecology (apart from the aforementioned, these were also, among others, *WIT Transactions on Ecology and the Environment* and *Sustainability*), regional problems (*Policy Studies Journal*, *Revue de Géographie Alpine*), or, narrowly understood, climate issues (*Climate Change* and *Climate Research*).

The affiliations of the authors of the publications analyzed were reflected in the spatial scope of the research conducted. As many as 22 articles were devoted to the analysis of resorts located in the USA, moreover, 13 were located in Austria and eight in Canada. Some publications did not undertake research located in specific countries; in several other papers, the spatial scope covered multiple countries, in particular, those located in the same mountain range, e.g., the Alpine or Pyrenean countries. There were also cases of publications that made comparisons between countries or even continents.

3.3. Methods Used

Taking into account that the authors of the publications analyzed were researchers who represented various scientific disciplines, it was also obvious that in their research they used multiple and different research methods typical for a given discipline. Surveying methods were often used in the research, which are part of the broadly understood stream of social sciences. In 16 publications, surveys conducted among consumers or stakeholders in winter sports resorts were used, while in another six works, the method of in-depth interview was used. For representatives of natural sciences, it was more typical to collect and use the data on natural phenomena that were already available in a specific place (total of 24 publications). The development scenario analysis was used in 12 publications. Moreover, in 10 articles modeling methods and in eight regression methods or econometric models were used. Quite often, the considerations of individual authors were focused on conducting a comparative analysis (10 publications) or using the case study method (6 publications). In three articles, literature studies were the leading method of analysis.

3.4. Environmental Impact

The vast majority of works that dealt with the impact of winter sports resorts on the natural environment used approaches and methodologies typical of natural sciences. Most often, research was conducted to identify the impact of the operation of a winter sports resort, or a single aspect of it, on a specific element of the environment. Both the impact of building resorts as well as new ski runs [63,108], and the impact of the resort's operation on an ongoing basis [62,103] were considered separately. In the latter case, all works were dominated by papers that analyzed the maintenance of ski runs, i.e., snowmaking [42,97,100,107,118] and grooming [100,105,118]. It is worth noting that in most of the works, these two aspects of the resort's operation, i.e., snowmaking and grooming of ski runs, were indicated as the most harmful from the point of view of the natural environment. Also on the part of the natural environment, a specific fragment was analyzed more often than an aggregate. The elements of the natural environment analyzed in multiple studies were soils [44,100,103] and grassland [44,103] or, to put it more broadly, vegetation [94,96,100,118]. The influence of the resorts on the animal world was the subject of the analysis relatively less frequently. The article by Sato et al. [79] was an example that presented the threat posed by winter sports resorts to reptiles, and works by Brambilla et al. [63] and Caprio et al. [64] analyzed threats to birds. The attention was drawn to, among others, the need for intensive measures to revegetate ski runs. Although these actions would not restore bird species diversity to the state it was before the construction of ski runs, they would significantly improve this diversity [64]. However, Burt [94] indicated the right mixture of flora species that would allow to effectively revegetate ski runs. Still, restoration of grasslands on ski runs caused a recovery in the bird community, but not to the extent equivalent to a natural Alpine grassland community [64]. On the other hand, in the article by Kangas et al. [108] analyses of the impact of the operation of winter sports resorts on water quality were made, and it was indicated that the state of waters polluted by the resorts is similar to those polluted by agriculture and forestry; whereas

Vanham et al. [107] indicated how important for local water conditions is the demand for special reservoirs needed for snowmaking as a result of large seasonal water fluctuations. Completely different conclusions were also obtained in the work by Barrantes et al. [85]. In their research, these authors compared agricultural land and land used for ski runs and noticed that once the land used for grazing was converted to ski runs, its biodiversity increased. Due to the dominant methodology of analyzing data related to a specific place, a significant part of the results and conclusions could not be merely transposed in a simple way into analysis and management of resorts located in different natural conditions. On the other hand, it was noteworthy that the vast majority of studies showed a very strong and negative impact of the construction and operation of winter sports resorts on individual elements of the environment.

The work by Kuščer and Dwyer [41], where the scale of environmental impacts of various winter sports resorts was compared and where the ability to generate a smaller environmental impact per visitor in the case of large winter sports resorts than in the case of small resorts was indicated, was an example of a publication in which a slightly different perspective was adopted from those described above.

3.5. Climate Change

Climate change remains among the most important factors impacting operations of winter sports resorts worldwide as it influences snow conditions. According to Spandre et al. [61] the snow conditions are a major priority for ski resort operators to provide comfortable skiing conditions, to ski back down to the village, or even to connect with neighboring resorts. Multiple studies by climatologists that show the dramatic momentum of climate change and its potential consequences have now made climate warming one of the most important topics undertaken by policy makers, entrepreneurs, and scientists. One of the first observations related to the climate change was the observation that winter sports resorts can now operate on much smaller scales [116,120]. For many years, they have been indicated as one of the most typical examples of human economic activity that would be impaired as a result of these changes [84,87].

Works on the issue of the impact of climate change on the operation of winter sports resorts most often adopted one of the two research perspectives. The first of them, the more analytical one, predicted the impact of climate change on winter sports resorts in a selected area, depending on how these changes took place [36,37,51,87,116]. In this approach, detailed data contained in the climate change scenarios were used. With this approach, the scale of the impact of climate warming could be indicated at various points in time and dependent on how this change developed. This research was conducted in multiple regions of the world, starting from the USA and Canada [36,40,87,116], through the Alpine countries [37,46,112] and the Pyrenees [71,82], ending with Japan [55] and India [77]. It is worth noting that in different parts of the world, i.e., in different resorts, conclusions of the analyses were different from resort to resort. In some cases, even in the optimistic carbon dioxide emission scenario, the normal operation of the resorts was in danger as early as in the fourth decade of the century [46,51,77], while in other studies, even if the scenario was pessimistic, the resorts' operation could have only been restrained in the long term (second half of the century) [84,111]. In this context, the anticipated shortening of the season and the decrease in carnet sale revenues, e.g., in Slovak resorts, according to the study by Demiroglu et al. [72], should be treated in terms of an optimistic scenario. However, most studies showed a large difference in the prospects for the operation of winter sports resorts, depending on the carbon dioxide emission scenario that took place there [36,37,83,116]. Discrepancies between individual studies could also be seen in terms of how the climate warming affected the weather conditions in each place. The research by Dar et al. [77] indicated a very significant warming in the winter season and, as a result, a reduction of snow cover in Kashmir, while Fischer [74] indicated that in the case of Austrian Tirol, climate warming mainly applies to the summer season, and there are only slight temperature fluctuations in winter. Taking into account these quite significant differences

in the impact of climate warming on various resorts, in several research studies [71,82] attempts were made to group the resorts according to how seriously they were exposed to climate change. The most common factor that differentiated this impact on resorts located in one region was, quite obviously, the height above sea level.

The second thread of considerations taken up most often in publications on “climate change” was how the boards and stakeholders in winter sports resorts reacted [38,76,79,104]. It was not a surprise that the two main strategies considered in response were: extended use of artificial snowmaking of ski runs [55,76] and the resort’s “escape” to greater heights [82,99]. The implementation of each of these two strategies involved a significant increase in the operating costs of the resort. Moreover, for many resorts that already operated at the highest available heights, expansion to higher altitudes was impossible [82]. Therefore, how the global warming threat could be limited with the expansion of artificial snowmaking on ski runs was a matter of particular concern [55,61,83,86,120]. The results obtained in individual studies were quite significantly different. In some studies, the importance of artificial snowmaking was indicated as an effective response to climate warming. This allowed to make the risk as small as possible [116,120], or even to make it the only option to survive for resorts [55,111], while, in other resorts, a minor significance of this solution was indicated, as the one of minimum risk of no snow cover and that generates significant costs [83]. These discrepancies are mainly the result of two facts. The first and the obvious one is again the issue of conditions that are unique in the various regions of the world studied. The second, however, is the issue of an approach to artificial snowmaking itself and the technological progress that has already been made and will probably still be made in terms of the efficiency of technical infrastructure. In some studies, it was assumed that the temperature range slightly above 0 °C prevented the operation of snowmaking devices. However, devices are now available that make it possible to produce artificial snow at almost any temperature, but the problem is then undoubtedly the costs of purchasing and operating such devices, as this makes the resort’s operation unreasonable in terms of finance [73,83,104,120]. It is exactly what the efforts of researchers in this topic should be focused on in the near future, i.e., cost restrictions of artificial snow, its ecological consequences, as well as the problem of access to water and energy resources needed for snow production [89]. Spandre et al. [61] underlined that the access to the water volumes needed to produce machine-made snow is already unequal between resorts, most of them relying on water reservoirs, and any evolution of the need for additional snowmaking will require a proportionally higher water supply, storage, and related costs. An interesting area of scientific considerations and actions taken by decision makers in winter sports resorts were in this context also indicated by Weiss et al. [39]. They indicated the efficiency of snow storage as an effective strategy to reduce the scale of current production.

Occasionally, in the research on “climate change,” other threads were also included. Most often, they were devoted to research in the perception and behavior related to climate warming among various stakeholders of winter sports resorts, on both the demand and supply sides. In some works [47,48,76,115] the attitudes of people managing and/or participating in the development of winter resorts toward climate change were analyzed. They confirmed that the respondents were quite aware of these changes, but this awareness was not fully translated into specific long-term actions [69]. Resort managers adjusted to the annual fluctuations in the weather, rather than to a long-term change [69]. As a result, actions were often taken as a reaction to the changes that took place and were already seen, rather than those anticipated, and decision makers in resorts that were less exposed to climate warming threat were less inclined to implement adaptation measures [40]. There was widespread belief that artificial snowmaking on ski runs is effective [69]; in some cases, the need to diversify the resort’s activities and to increase the off-season revenues was also emphasized [78,89]. In the research by Trawöger, [75], four groups of stakeholders in Tyrolean winter sports resorts were distinguished based on their attitude toward climate change. These groups were characterized as: convinced planners, annoyed deniers, ambivalent optimists, convinced wait-and-seers. The insufficient number of actions taken by

decision makers in winter sports resorts were not only a result of their passive attitude, but also of insufficient resources of knowledge available to them, including research and scientific publications [114]. In managing winter sports resorts, weather variables were used far too seldom. They currently reflected the ongoing climate changes [102]. Another interesting conclusion was reached by Hoffman et al. [109] who found a positive influence of the awareness of possible climate change effects on the scope of corporate adaptation, but no significant influence of the vulnerability to climate change effects on the scope of adaptation could be found in their research.

Other interesting conclusions were drawn on the basis of the research on skiers and the analysis of their attitudes and behavior toward global warming [70,90]. As in the case of the supply-side research, in this case it was also found that relatively high awareness of changes was not associated with a significant modification of behavior [49,50]. Skiers who received information about problems with maintaining snow cover in a particular winter sports resort may make different choices depending on the market segment they represent. Generally, people who are more focused on skiing or snowboarding, are more likely in such a situation to choose another resort, while people who pay more attention to the experience of just staying in a specific place are more loyal to resorts more affected by climate warming [68,70]. Eventually, Gonseth [86] found that ski areas benefiting from sunny conditions tended to have more skier visits, which might suggest that additional impacts such as climate change may modify sunshine duration in mountain regions.

3.6. Management

The publications analyzed on this issue in large extent referred to management strategies and tools appropriate when faced with the situations presented like: “environmental impact” and “climate change.” Decisions on which directions and what methods will be developed by the resorts, which are taken at the level of the management boards of individual resorts, were often criticized for disregarding the principles of nature protection, including fundamental ones like the protection of plant and animal species under legal species protection [63,70]. According to Luthe et al. [91] it is necessary to take a comprehensive view of how the tools and activities are designed in winter sports resorts to assess their impact on nature and make it as little as possible. On the other hand, Krůčka et al. [53] called for allocating the profits from the operation of individual resorts to nature protection instead of further development of infrastructure.

A typical issue for this section of subjects was whether it made sense for individual winter sports resorts to participate in various types of voluntary programs for implementing sustainable development and eco-labeling and, if so, how to be motivated to do it [58]. According to Rivera and de Leon [119], resorts’ participation in these programs is motivated only by opportunistic reasons and may be forced by external pressure. Their findings indicated that participation in one of these programs by ski areas is a result of institutional pressures in the form of enhanced federal oversight and of higher state environmental demands exerted by state agencies, local environmental groups, and public opinion. George [121] was critical about one of the most popular programs of this type in the USA, i.e., sustainable slopes charter. On the basis of the survey research he conducted, he claimed that the program is perceived as a fig leaf, and its only positive effect is an increase in environmental awareness among the resort’s guests. How important the participation of winter sports resorts in voluntary environmental programs (VEPs) is as a management strategy and response to this external pressure from customers was also questioned in the research by Needham and Little [88]. The results of their research suggested that the majority of visitors to the resorts not only knew nothing about these programs, but they were not motivated by them in any way in making their decision about which resort to choose. On the other hand, research by Needham and Little [88] allowed to indicate the characteristics of the features of visitors who were motivated by these programs. Respondents who were motivated to visit Mt. Bachelor ski area in Oregon, USA, because of the voluntary environmental programs were more attached to this area

and biocentric or environmentally oriented. Critical comments about VEPs, in particular, those related to being unaware that they exist by all involved, were also expressed by Little and Needham [98] as well as Rivera et al. [117] in their articles. The involvement of winter sports resorts in eco-labeling programs was also critically assessed [58]. According to Sato et al. [58] so far they have not met the expectations of the resort's customers and are focused too much on by-products, while skiers expected the skiing environmental effects rather than general ones. On the other hand, Duglio and Beltramo [66] were less critical about eco-labeling winter sports resorts. They pointed out that eco-labeling can be used at both the winter sports resort and destination levels. However, its effectiveness and impact on the profits of individual resorts varies from resort to resort [65], while the use of eco-certificates improves some companies' results, at the same time it lowers other companies' results. In the context of the above critical remarks, the title question from the paper by Rivera et al. [117] "Is greener whiter yet?" does not seem to have a positive answer. On the other hand, it should be kept in mind that the main subject of research in the works cited was primarily the marketing effectiveness of the environmental practices used, while there is no detailed research on what extent the implementation of sustainable slopes charter and other VEPs have influenced the actual level of impact exercised by individual resorts on the state of the natural environment. Nevertheless, in the only article analyzed [117] that raised these issues, it was indicated that no evidence was found to conclude that ski areas that adopted the VEPs displayed performance levels that were superior to nonparticipants for the following areas of environmental protection: overall environmental performance, expansion management, pollution management, and wildlife and habitat management. VEP participants only appeared to show a statistically significant correlation with higher natural resource conservation performance rates. Not only is individual resort participation in VEPs of particular importance, but also the proper communication of environmental policy, which will help to create the desired marketing effects of this kind of resort involvement [92]. Spector et al. [92] indicated that the resorts belong to one of four groups in how they conduct and communicate their ecological policy: passive, exploiting, reactive, and proactive. Additionally, the need to examine the motivations behind ski resort publications on environmental communications and the likelihood of skiers selecting resorts based on the environmental communications posted on websites was underlined [92].

The negative impact of winter sports resorts on the natural environment was the source of multiple conflicts: those understood literally, i.e., conflicts of resorts' managers with nature protection organizations and institutions, and conflicts of values. The source of these conflicts could be both the operation of resorts as a whole and their individual actions. In addition, these conflicts were aggravated by the negative impact of climate warming, which made the resorts' managers operate under greater economic pressure, while nature presented an additional negative factor. The issue of managing these conflicts was often discussed in publications in the field of "management" [106]. The issue of access to the water resources necessary to intensify artificial snowing and how it is consumed [89] was an example of the conflict between nature and the operation of winter sports resorts that has become more and more serious in the conditions of global warming. According to Morrison and Pickering [89], this conflict can be solved only by cooperation of multiple stakeholders involved in this problem. On the other hand, Sharma et al. [113] indicated how important organizational capabilities are in managing conflicts related to nature conservation in the surroundings of winter sports resorts. There was no doubt that the use of ecological innovations in managing winter sports resorts [101] was an important strategy to mitigate conflicts related to nature protection. Smerecnik and Andersen [101] warned against, as it seems, simple diffusion of these innovations, which is not correct. Another conflict was analyzed by Bausch et al. [42]. They indicated that while fighting the effects of global warming extensively using artificial snowmaking, winter sports resorts do not meet the expectations of recipients. What is more, they do not meet these expectations for two different reasons. Firstly, it increases the operating costs of the resorts, and, as a

result, it increases the prices of tickets, and secondly, it causes the resorts to be perceived as anti-ecological, which in turn has a negative impact on guests' loyalty. On the other hand, Dornier and Mauri [54] indicated that regardless of what kind of the problems there are here, winter sports resorts will have to change the way they operate so that their operation is subject to the principles of sustainable development to the greatest extent possible.

4. Discussion and Conclusions

Although the number of publications concerning the relationship between the operation of winter sports resorts and the natural environment has significantly increased, it seems that the level of contemporary scientific knowledge about the phenomena in research is highly insufficient. One of the main issues noted in the conducted analysis of the publications, which allows to put forward a far-reaching thesis, is the significant inconsistency of conclusions resulting from individual studies. The obvious facts about the negative impact of climate warming on the operation of winter sports resorts and the negative impact of these resorts on the natural environment are undeniable conclusions that are not put into question in any way in any of the texts. However, the scale of these influences and ways to limit them remain a controversial issue. In most publications [42,46,61,97,100,104,107,118], the issue of artificial snowmaking was important. On the one hand, it was presented as the only or the most effective panacea for the effects of global warming [55,61,83,116,120], and, on the other, as an element particularly responsible for environmental degradation [42,97,100,107,118]. The significant number of publications on snowmaking of ski runs and the relative consistency of the conclusions drawn from these publications encourage further research on this issue, both in the context of climate change and in the context of nature degradation. Economic and environmental analysis of other possible climate change response strategies, such as "escape" to higher altitudes [82,99], is also an urgent issue. In the sources analyzed, there were no clear suggestions as to whether this could be an alternative to continue intensifying snowmaking of ski runs with sufficient efficiency, whether this alternative is financially attractive and, finally, whether it is less harmful to nature. Other, more "traditional" elements of the impact of winter sports resorts on nature, such as noise, deforestation, generation of garbage and sewage, etc., also require further analysis. Despite the fact that these elements were recognized as contributing to the significant negative impact of winter sports resorts on nature many years ago [1,3,8,9,122,123], in the last two decades these topics were practically not discussed at all, and it is hard to suppose that the knowledge available from publications from the twentieth century is fully up-to-date in the present conditions. The sustainable development perspective on winter sports resorts requires also more attention to the needs of local inhabitants, which seems to be in times of overtourism identified also in nature-based destinations [124,125] as a crucial direction of future research.

There was a relative consensus among the authors of individual publications [88,119,121] about whether the tools used today as a response of the winter sports resorts management to climate warming and to the growing awareness that it is necessary to limit the negative impact of these resorts on nature are sufficiently effective. However, the question remains unanswered whether voluntary environmental programs or eco-labeling programs are insufficient tools and whether it is necessary to search for more effective tools, or whether it is enough just to refine the way they are applied.

Relatively few publications [58,66,90] presented the role of consumers in the analysis of the winter sports resort–natural environment relationship. On the one hand, their mere presence, as well as specific behaviors, are part of the negative impact of a winter sports resort on the environment; on the other hand, it is often the choices they make as to the destination of their ski trips and about a ski trip in general that are the primary targets of all actions made by winter sports resort managements designed to make both the ecological impact of the resort and the impact of climate warming on this resort as little as possible [58,65]. Whereas the results of the few analyzed studies [88,98,117] that referred to

the role of the consumer in the topic discussed indicated, above all, that there is no effective communication about the actions taken and, as a result, customers are not aware of it.

There is no doubt that the attention of researchers today is more and more focused on the analysis of the current and future consequences of climate warming. This was clearly evidenced not only by the number of works on “climate change,” but also by how rapidly the number of these works has grown in recent years and the huge number of citations of most of these works. Scientific knowledge about climate change issues and their impact on the operation of winter sports resorts has undoubtedly been significantly developed in the last two decades, however, also in this case many gaps can still be seen. This is a challenge and a field for future, further research. At the moment, the most important of them seems to be the limitation of research and conclusions in most publications [36,37,40,46,55,71,87,112,116] to resorts located only in a specific smaller or larger region, with highly reduced possibilities of extending these results to other locations. There are no reviews that synthesize conclusions obtained in different regions, which would allow to identify key factors that affect the scale of threats in individual resorts. A set of factors like these would be relatively easily used in the analysis of future opportunities and threats for resorts for which a research like this has not so far been conducted.

To sum up, it can be concluded that the conducted analysis allowed to identify a surprisingly large number of gaps in contemporary scientific knowledge on the issues that have been the subject of research for many years. On the other hand, it is also true that the research area contains issues that are rapidly evolving in the contemporary world and issues that were previously not taken into account, such as the impact of global climate change. All this generates new challenges for the managers of winter sports resorts and, as a result, new fields of research and scientific analysis that still need to be filled with further research.

The scientific output of the presented paper is connected mainly with the detection of several gaps in contemporary knowledge and pointing out numerous directions of future research. All three topics identified in the literature review require urgent development. In the case of “climate change” and “environmental impact,” future research should be focused on the search for general, global rules, as most contemporary publications give insight only into the local/regional conditions of particular resorts. In the case of “management,” the most important direction of future research is an understanding of the reasons for the low effectiveness of VEPs and the establishment of new, more effective tools. Additionally, the ways of effectively using artificial snowmaking and making it less dangerous for the natural environment is another issue that requires extensive research in the future. Those implications related to the topic “management” might be perceived also as the most important managerial implications of the paper; however, in a paper dealing with a literature review the most important expected output is always theory development, and practical recommendations play only a supplementary role.

The limitations of the presented conclusions are partly a result of the specific method itself. Firstly, selecting the SCOPUS database as the basis for the search may seem controversial, just like any other alternative choice, and publications can be indicated that were published in the period analyzed and were involved in the issues analyzed, but were not included in the list because they were published in journals that were not indexed in SCOPUS. Nevertheless, the SCOPUS database is considered to be one of the most prestigious and one that contains the most influential scientific journals [25,28,29]. Hence, it can be assumed that publications that are not in journals contained in this database have a smaller impact on the development of the contemporary scientific knowledge [28]. Selection of the proper data set/data sets always remains the controversial part of any literature review, regardless of the choices made. This selection is always a compromise between the creation of a manageable set of papers and the inclusion of all papers having a significant scientific impact on future research [24]. The creation of a too wide set of papers might also be controversial as too much attention can be put on the papers having very little impact and too little attention on the most important ones. Among reasonable alternatives for using

SCOPUS, the Web of Science (WoS) database can be stated [29]. Contemporary literature offers arguments supporting the use of both of these databases solely and commonly, and none of them remains without questions.

Objections may also be raised to the scope and details of the search formula used, which allowed to select a manageable collection of publications. However, it cannot be ruled out that in the SCOPUS database there are also individual subsequent publications on the issues discussed that were not included in the selected list. Nevertheless, it seems that in this case it is not the issue of the detailed elements of its application that is the most important limitation of the method, but the problem is how to keep up with the rapidly developing scientific knowledge. In the list, articles published over the course of almost 20 years were analyzed. Equal attention has been paid to both older and newer publications. Whereas, what was known about causes, effects, and expected scenarios of global warming quickly evolved during that time. The natural conditions associated with the effects of this warming that could have been seen more and more clearly have also changed. Therefore, there is a risk that some of the results and conclusions drawn from the older publications may turn out to be at least partially out-of-date in the contemporary world. It may also be one of the reasons why the research results presented in various publications indicated in the text were different. It was necessary to close the list at a specific point in time, therefore, it was another limitation to the results of the analyses conducted. Certainly, between that moment and the moment this article is published, more articles on this subject matter will have been published. The numbers that show the level of citation of individual publications will have certainly changed, as well.

Funding: This research received no external funding.

Institutional Review Board Statement: Not applicable.

Informed Consent Statement: Not applicable.

Data Availability Statement: Data available in a publicly accessible repository.

Conflicts of Interest: The author declares no conflict of interest.

References

- Gill, A.; Williams, P. Managing growth in mountain tourism communities. *Tour. Manag.* **1994**, *15*, 212–220. [\[CrossRef\]](#)
- Tuppen, J. The Restructuring of winter sports resorts in the French Alps: Problems, processes and policies. *Int. J. Tour. Res.* **2008**, *2*, 327–344. [\[CrossRef\]](#)
- Williams, P. Sustainable Alpine tourism development: Towards a self improvement approach. In *Alpine Tourism. Sustainability Reconsidered and Redesigned*; Weiermair, K., Ed.; University of Innsbruck: Innsbruck, Austria, 1996; pp. 112–134.
- Żemła, M. The product quality of Polish ski-resorts: A case study of Silesian skiers' requirements, satisfaction and complaints. *Tourism* **2008**, *56*, 41–58.
- Goncalves, V.F.C.; Águas, P.M.R. The concept of life cycle: An application to the tourism product. *J. Travel Res.* **1997**, *35*, 12–22. [\[CrossRef\]](#)
- Flagestad, A.; Hope, C.A. Strategic success in winter sports destinations: A sustainable value creation perspective. *Tour. Manag.* **2001**, *22*, 445–461. [\[CrossRef\]](#)
- Hudson, S.; Hudson, L. *Winter Sport Tourism. Working in Winter Wonderlands*; Goodfellow Publishers: Oxford, UK, 2015.
- Hudson, S. The 'greening' of ski resorts: A necessity for sustainable tourism, or a marketing opportunity for skiing communities? *J. Vacat. Mark.* **1996**, *2*, 176–185. [\[CrossRef\]](#)
- Todd, S.E.; Williams, P.W. From White to Green: A Proposed Environmental Management System Framework for Ski Areas. *J. Sustain. Tour.* **1996**, *4*, 147–173. [\[CrossRef\]](#)
- Holden, A. Winter tourism and the environment in conflict: The case of Cairngorm, Scotland. *Int. J. Tour. Res.* **2000**, *2*, 247–260. [\[CrossRef\]](#)
- Hudson, S. *Snow Business: A Study of the International Ski Industry*; Cassell: London, UK, 2000.
- Williams, P.W.; Todd, S.E. Towards an Environmental Management System for Ski Areas. *Mt. Res. Dev.* **1997**, *17*, 75. [\[CrossRef\]](#)
- Elsasser, H.; Abegg, B.; Buerki, R. Climate change and winter sports: Environmental and economic threats. *Geogr. Bull.* **2006**, *38*, 26–40.
- Żemła, M. Failures in building partnership for success in the competitive market: The case of Polish ski resorts. *Manag. Glob. Trans.* **2008**, *6*, 421–444.
- Dansero, E.; Del Corpo, B.; Mela, A.; Ropolo, I. Olympic Games, conflicts and social movements: The case of Torino 2006. In *Olympic Games, Mega-Events and Civil. Societies*; Palgrave Macmillan: London, UK, 2012; pp. 195–218.

16. Mair, J.; Ritchie, B.W.; Walters, G. Towards a research agenda for post-disaster and post-crisis recovery strategies for tourist destinations: A narrative review. *Curr. Issues Tour.* **2016**, *19*, 1–26. [[CrossRef](#)]
17. Ratajczak, P.; Szutowski, D. Exploring the relationship between CSR and innovation. *Sustain. Account. Manag. Policy J.* **2016**, *7*, 295–318. [[CrossRef](#)]
18. Booth, A. Acknowledging a Dual Heritage for Qualitative Evidence Synthesis: Harnessing the Qualitative Research and Systematic Review Research Traditions. Ph.D. Thesis, University of Sheffield, Sheffield, UK, 2013.
19. Booth, A.; Sutton, A.; Papaioannou, D. *Systematic Approaches to Successful Literature Review*; SAGE Publications Ltd.: London, UK, 2016.
20. Bryman, A.; Buchanan, D.A. *The SAGE Handbook of Organizational Research Methods*; Sage: London, UK, 2011.
21. Mays, N.; Pope, C.; Popay, J. Systematically reviewing qualitative and quantitative evidence to inform management and policy-making in the health field. *J. Health Serv. Res. Policy* **2005**, *10*, 6–20. [[CrossRef](#)]
22. Greenhalgh, T.; Robert, G.; Macfarlane, F.; Bate, P.; Kyriakidou, O.; Peacock, R. Storylines of research in diffusion of innovation: A meta-narrative approach to systematic review. *Soc. Sci. Med.* **2005**, *61*, 417–430. [[CrossRef](#)]
23. Kannisto, K.A.; Koivunen, M.H.; Välimäki, M. Use of Mobile Phone Text Message Reminders in Health Care Services: A Narrative Literature Review. *J. Med. Int. Res.* **2014**, *16*, e222. [[CrossRef](#)] [[PubMed](#)]
24. Galvagno, M.; Dalli, D. Theory of value co-creation: A systematic literature review. *Manag. Serv. Qual. Int. J.* **2014**, *24*, 643–683. [[CrossRef](#)]
25. Popova, S.; Lange, S.; Bekmuradov, D.; Mihic, A.; Rehm, J. Fetal Alcohol Spectrum Disorder Prevalence Estimates in Correctional Systems: A Systematic Literature Review. *Can. J. Public Health* **2011**, *102*, 336–340. [[CrossRef](#)] [[PubMed](#)]
26. Oliveira, A.S.; de Barros, M.D.; de Carvalho Pereira, F.; Gomes, C.F.S.; da Costa, H.G. Prospective scenarios: A literature review on the Scopus database. *Futures* **2018**, *100*, 20–33. [[CrossRef](#)]
27. Chadegani, A.A.; Salehi, H.; Yunus, M.M.; Farhadi, H.; Fooladi, M.; Farhadi, M.; Ebrahim, N.A. A Comparison between Two Main Academic Literature Collections: Web of Science and Scopus Databases. *Asian Soc. Sci.* **2013**, *9*, 18. [[CrossRef](#)]
28. Osmani, M.; Weerakkody, V.; Hindi, N.M.; Al-Esmail, R.; Eldabi, T.; Kapoor, K.; Irani, Z. Identifying the trends and impact of graduate attributes on employability: A literature review. *Tert. Educ. Manag.* **2015**, *21*, 367–379. [[CrossRef](#)]
29. Wamba, S.F.; Akter, S. Big data analytics for supply chain management: A literature review and research agenda. In *Workshop on Enterprise and Organizational Modeling and Simulation*; Springer: Cham, Switzerland, 2015; pp. 61–72.
30. Hassan, S.-U.; Imran, M.; Gillani, U.A.; Aljohani, N.R.; Bowman, T.D.; Didegah, F. Measuring social media activity of scientific literature: An exhaustive comparison of scopus and novel altmetrics big data. *Scientometrics* **2017**, *113*, 1037–1057. [[CrossRef](#)]
31. Jaremen, D.E.; Nawrocka, E.; Zemla, M. Externalities of development of the sharing economy in tourism cities. *Int. J. Tour. Cities* **2020**, *6*, 138–157. [[CrossRef](#)]
32. Brzezinski, M. Power laws in citation distributions: Evidence from Scopus. *Scientometrics* **2015**, *103*, 213–228. [[CrossRef](#)] [[PubMed](#)]
33. Restall, B.; Conrad, E. A literature review of connectedness to nature and its potential for environmental management. *J. Environ. Manag.* **2015**, *159*, 264–278. [[CrossRef](#)] [[PubMed](#)]
34. Hassan, S.U.; Visvizi, A.; Waheed, H. The ‘who’ and the ‘what’ in international migration research: Data-driven analysis of Scopus-indexed scientific literature. *Behav. Inf. Technol.* **2019**, *38*, 924–939. [[CrossRef](#)]
35. Meho, L.I.; Rogers, Y. Citation counting, citation ranking, and h-index of human-computer interaction researchers: A comparison of Scopus and Web of Science. *J. Am. Soc. Inf. Sci. Technol.* **2008**, *59*, 1711–1726. [[CrossRef](#)]
36. Scott, D.; Steiger, R.; Knowles, N.; Fang, Y. Regional ski tourism risk to climate change: An inter-comparison of Eastern Canada and US Northeast markets. *J. Sustain. Tour.* **2019**, *28*, 568–586. [[CrossRef](#)]
37. Steiger, R.; Scott, D. Ski tourism in a warmer world: Increased adaptation and regional economic impacts in Austria. *Tour. Manag.* **2020**, *77*, 104032. [[CrossRef](#)]
38. Ballotta, L.; Fusai, G.; Kyriakou, I.; Papapostolou, N.C.; Poulialis, P.K. Risk management of climate impact for tourism operators: An empirical analysis on ski resorts. *Tour. Manag.* **2020**, *77*, 104011. [[CrossRef](#)]
39. Weiss, H.S.; Bierman, P.R.; Dubief, Y.; Hamshaw, S.D. Optimization of over-summer snow storage at midlatitudes and low elevation. *Cryosphere* **2019**, *13*, 3367–3382. [[CrossRef](#)]
40. Rivera, J.; Clement, V. Business adaptation to climate change: American ski resorts and warmer temperatures. *Bus. Strat. Environ.* **2019**, *28*, 1285–1301. [[CrossRef](#)]
41. Kušcer, K.; Dwyer, L. Determinants of sustainability of ski resorts: Do size and altitude matter? *Eur. Sport Manag. Q.* **2018**, *19*, 539–559. [[CrossRef](#)]
42. Bausch, T.; Humpe, A.; Gössling, S. Does Climate Change Influence Guest Loyalty at Alpine Winter Destinations? *Sustainability* **2019**, *11*, 4233. [[CrossRef](#)]
43. Steiger, R.; Scott, D.; Abegg, B.; Pons, M.; Aall, C. A critical review of climate change risk for ski tourism. *Curr. Issues Tour.* **2019**, *22*, 1343–1379. [[CrossRef](#)]
44. Bacchocchi, S.C.; Zerbe, S.; Cavieres, L.A.; Wellstein, C. Impact of ski piste management on mountain grassland ecosystems in the Southern Alps. *Sci. Total. Environ.* **2019**, *665*, 959–967. [[CrossRef](#)]
45. Gajdošíková, Z.; Gajdošík, T.; Kučerová, J. Slovak winter tourism destinations: Future playground for tourists in the Carpathians. *Tour. Hosp. Manag.* **2019**, *25*, 161–178. [[CrossRef](#)]

46. Spandre, P.; François, H.; Verfaillie, D.; George, E.; Morin, S. Winter tourism under climate change in the Pyrenees and the French alps: Relevance of snowmaking as a technical adaptation. *Cryosphere* **2019**, *13*, 1325–1347. [\[CrossRef\]](#)
47. Knowles, N.L.B. Can the North American ski industry attain climate resiliency? A modified Delphi survey on transformations towards sustainable tourism. *Eur. J. Sustain. Tour.* **2019**, *27*, 380–397. [\[CrossRef\]](#)
48. Cholakova, S.D.; Dogramadjeva, E.D. Climate change and the future of Pamporovo ski resort Bulgaria. the view of the local population. *Eur. J. Geogr.* **2019**, *10*, 56–76.
49. Cholakova, S.D.; Dogramadjeva, E.D. Climate change and ski industry in Pamporovo resort, Bulgaria: An exploratory study on the tourists' perceptions. *Eur. J. Tour. Res.* **2019**, *22*, 166–192.
50. Demiroglu, O.C.; Dannevig, H.; Aall, C. Climate change acknowledgement and responses of summer (glacier) ski visitors in Norway. *Scand. J. Hosp. Tour.* **2018**, *18*, 419–438. [\[CrossRef\]](#)
51. Chin, N.; Byun, K.; Hamlet, A.F.; Cherkauer, K.A. Assessing potential winter weather response to climate change and implications for tourism in the U.S. Great Lakes and Midwest. *J. Hydrol. Reg. Stud.* **2018**, *19*, 42–56. [\[CrossRef\]](#)
52. Gilani, H.R.; Innes, J.L.; De Grave, A. The effects of seasonal business diversification of British Columbia ski resorts on forest management. *J. Outdoor Recreat. Tour.* **2018**, *23*, 51–58. [\[CrossRef\]](#)
53. Krtička, L.; Tomčíková, I.; Rakytová, I. Development versus conservation: Evaluation of landscape structure changes in Demänovská Valley, Slovakia. *J. Mt. Sci.* **2018**, *15*, 1153–1170. [\[CrossRef\]](#)
54. Dornier, R.; Mauri, C. Overview: Tourism sustainability in the Alpine region: The major trends and challenges. *Worldw. Hosp. Tour. Themes* **2018**, *10*, 136–139. [\[CrossRef\]](#)
55. Suzuki-Parker, A.; Miura, Y.; Kusaka, H.; Kureha, M. Assessing the Sustainability of Ski Fields in Southern Japan under Global Warming. *Adv. Meteorol.* **2018**, *2018*, 1–10. [\[CrossRef\]](#)
56. Hallandvik, L.; Andresen, M.S.; Aadland, E. Decision-making in avalanche terrain—How does assessment of terrain, reading of avalanche forecast and environmental observations differ by skiers' skill level? *J. Outdoor Recreat. Tour.* **2017**, *20*, 45–51. [\[CrossRef\]](#)
57. Falk, M.T.; Vieru, M. Demand for downhill skiing in subarctic climates. *Scand. J. Hosp. Tour.* **2016**, *17*, 388–405. [\[CrossRef\]](#)
58. Sato, S.; Ko, Y.J.; Kellison, T.; Harada, M.; Bizen, Y. Do Snow-Based Sport Participants Intend to Purchase Products from Environmentally Friendly Companies? *J. Glob. Sport Manag.* **2017**, *2*, 182–195. [\[CrossRef\]](#)
59. Saiz, H.; Gartzia, M.; Errea, P.; Fillat, F.; Alados, C.L. Structure of Stockmen Collaboration Networks Under Two Contrasting Touristic Regimes in the Spanish Central Pyrenees. *Rangel. Ecol. Manag.* **2017**, *70*, 281–289. [\[CrossRef\]](#)
60. Rutty, M.; Scott, D.; Johnson, P.; Pons, M.; Steiger, R.; Vilella, M. Using ski industry response to climatic variability to assess climate change risk: An analogue study in Eastern Canada. *Tour. Manag.* **2017**, *58*, 196–204. [\[CrossRef\]](#)
61. Spandre, P.; François, H.; George-Marcelpoil, E.; Morin, S. Panel based assessment of snow management operations in French ski resorts. *J. Outdoor Recreat. Tour.* **2016**, *16*, 24–36. [\[CrossRef\]](#)
62. Fischer, A.; Helfricht, K.; Stocker-Waldhuber, M. Local reduction of decadal glacier thickness loss through mass balance management in ski resorts. *Cryosphere* **2016**, *10*, 2941–2952. [\[CrossRef\]](#)
63. Brambilla, M.; Pedrini, P.; Rolando, A.; Chamberlain, D. Climate change will increase the potential conflict between skiing and high-elevation bird species in the Alps. *J. Biogeogr.* **2016**, *43*, 2299–2309. [\[CrossRef\]](#)
64. Caprio, E.; Chamberlain, D.; Rolando, A. Ski-piste revegetation promotes partial bird community recovery in the European Alps. *Bird Study* **2016**, *63*, 470–478. [\[CrossRef\]](#)
65. Van Hoang, T.H.; Przychodzen, W.; Przychodzen, J.; Segbotangni, E.A. Does it pay to be green? A disaggregated analysis of U.S. firms with green patents. *Bus. Strat. Environ.* **2020**, *29*, 1331–1361. [\[CrossRef\]](#)
66. Duglio, S.; Beltramo, R. Environmental Management and Sustainable Labels in the Ski Industry: A Critical Review. *Sustainability* **2016**, *8*, 851. [\[CrossRef\]](#)
67. Tashman, P.; Rivera, J. Ecological uncertainty, adaptation, and mitigation in the U.S. ski resort industry: Managing resource dependence and institutional pressures. *Strat. Manag. J.* **2015**, *37*, 1507–1525. [\[CrossRef\]](#)
68. Cocolas, N.; Walters, G.; Ruhanen, L. Behavioural adaptation to climate change among winter alpine tourists: An analysis of tourist motivations and leisure substitutability. *J. Sustain. Tour.* **2015**, *24*, 846–865. [\[CrossRef\]](#)
69. Haanpää, S.; Juhola, S.; Landauer, M. Adapting to climate change: Perceptions of vulnerability of down-hill ski area operators in Southern and Middle Finland. *Curr. Issues Tour.* **2014**, *18*, 966–978. [\[CrossRef\]](#)
70. Rutty, M.; Scott, D.; Johnson, P.; Pons, M.; Steiger, R. Behavioural adaptation of skiers to climatic variability and change in Ontario, Canada. *J. Outdoor Recreat. Tour.* **2015**, *11*, 13–21. [\[CrossRef\]](#)
71. Pons, M.; López-Moreno, J.L.; Rosas-Casals, M.; Jover, È. The vulnerability of Pyrenean ski resorts to climate-induced changes in the snowpack. *Clim. Chang.* **2015**, *131*, 591–605. [\[CrossRef\]](#)
72. Demiroglu, O.C.; Kučerová, J.; Ozelebi, O. Snow reliability and climate elasticity: Case of a Slovak ski resort. *Tour. Rev.* **2015**, *70*, 1–12. [\[CrossRef\]](#)
73. Damm, A.; Köberl, J.; Prettenthaler, F. Does artificial snow production pay under future climate conditions?—A case study for a vulnerable ski area in Austria. *Tour. Manag.* **2014**, *43*, 8–21. [\[CrossRef\]](#)
74. Fischer, A. Snow flakes and fates: What hope is there for Alpine winter tourism? *Sustain. Tour. VI* **2014**, *187*, 293–305.
75. Trawöger, L. Convinced, ambivalent or annoyed: Tyrolean ski tourism stakeholders and their perceptions of climate change. *Tour. Manag.* **2014**, *40*, 338–351. [\[CrossRef\]](#)

76. Hopkins, D. The sustainability of climate change adaptation strategies in New Zealand's ski industry: A range of stakeholder perceptions. *J. Sustain. Tour.* **2014**, *22*, 107–126. [[CrossRef](#)]
77. Dar, R.A.; Rashid, I.; Romshoo, S.A.; Marazi, A. Sustainability of winter tourism in a changing climate over Kashmir Himalaya. *Environ. Monit. Assess.* **2013**, *186*, 2549–2562. [[CrossRef](#)]
78. Ghaderi, Z.; Khoshkam, M.; Henderson, J.C. From snow skiing to grass skiing: Implications of climate change for the ski industry in Dizin, Iran. *Anatolia* **2013**, *25*, 96–107. [[CrossRef](#)]
79. Hopkins, D.; Maclean, K. Climate change perceptions and responses in Scotland's ski industry. *Tour. Geogr.* **2014**, *16*, 400–414. [[CrossRef](#)]
80. Sato, C.F.; Schroder, M.; Green, K.; Michael, D.R.; Osborne, W.; Lindenmayer, D.B. Managing ski resorts to improve biodiversity conservation: Australian reptiles as a case study. *Ecol. Manag. Restor.* **2014**, *15*, 147–154. [[CrossRef](#)]
81. Ruttly, M.; Matthews, L.; Scott, D.; Del Matto, T. Using vehicle monitoring technology and eco-driver training to reduce fuel use and emissions in tourism: A ski resort case study. *J. Sustain. Tour.* **2013**, *22*, 787–800. [[CrossRef](#)]
82. Pons, M.; López Moreno, J.I.; Esteban, P.; Macià, S.; Gavalda, J.; García, C.; Rosas-Casals, M.; Jover, E. Climate change influence on winter tourism in the Pyrenees. Experience from the NIVOPYR research project. *Pirineos* **2014**, *169*, 169006.
83. Steiger, R.; Stötter, J. Climate Change Impact Assessment of Ski Tourism in Tyrol. *Tour. Geogr.* **2013**, *15*, 577–600. [[CrossRef](#)]
84. Hendrikx, J.; Zammit, C.; Hreinsson, E.Ö.; Becken, S. A comparative assessment of the potential impact of climate change on the ski industry in New Zealand and Australia. *Clim. Chang.* **2013**, *119*, 965–978. [[CrossRef](#)]
85. Barrantes, O.; Reiné, R.; Ferrer, C. Changes in Land Use of Pyrenean Mountain Pastures—Ski Runs and Livestock Management—Between 1972 and 2005 and the Effects on Subalpine Grasslands. *Arctic. Antarct. Alp. Res.* **2013**, *45*, 318–329. [[CrossRef](#)]
86. Gonseth, C. Impact of snow variability on the Swiss winter tourism sector: Implications in an era of climate change. *Clim. Chang.* **2013**, *119*, 307–320. [[CrossRef](#)]
87. Dawson, J.; Scott, D. Managing for climate change in the alpine ski sector. *Tour. Manag.* **2013**, *35*, 244–254. [[CrossRef](#)]
88. Needham, M.D.; Little, C.M. Voluntary environmental programs at an alpine ski area: Visitor perceptions, attachment, value orientations, and specialization. *Tour. Manag.* **2013**, *35*, 70–81. [[CrossRef](#)]
89. Morrison, C.; Pickering, C.M. Perceptions of climate change impacts, adaptation and limits to adaption in the Australian Alps: The ski-tourism industry and key stakeholders. *J. Sustain. Tour.* **2013**, *21*, 173–191. [[CrossRef](#)]
90. Pröbstl-Haider, U.; Haider, W. Tools for measuring the intention for adapting to climate change by winter tourists: Some thoughts on consumer behavior research and an empirical example. *Tour. Rev.* **2013**, *68*, 44–55. [[CrossRef](#)]
91. Luthe, T.; Kägi, T.; Reger, J. A systems approach to sustainable technical product design: Combining life cycle assessment and virtual development in the case of skis. *J. Ind. Ecol.* **2013**, *17*, 605–617. [[CrossRef](#)]
92. Spector, S.; Chard, C.; Mallen, C.; Hyatt, C. Socially constructed environmental issues and sport: A content analysis of Ski Resort Environmental Communications. *Sport Manag. Rev.* **2012**, *15*, 416–433. [[CrossRef](#)]
93. Kangas, K.; Vuori, K.-M.; Määttä-Juntunen, H.; Siikamäki, P. Impacts of ski resorts on water quality of boreal lakes: A case study in northern Finland. *Boreal Environ. Res.* **2012**, *17*, 313–325.
94. Burt, J.W. Developing restoration planting mixes for active ski slopes: A multi-site reference community approach. *Environ. Manag.* **2012**, *49*, 636–648. [[CrossRef](#)]
95. Ristić, R.; Kašanin-Grubin, M.; Radić, B.; Nikić, Z.; Vasiljević, N. Land Degradation at the Stara Planina Ski Resort. *Environ. Manag.* **2012**, *49*, 580–592. [[CrossRef](#)]
96. Keßler, T.; Cierjacks, A.; Ernst, R.; Dziock, F. Direct and indirect effects of ski run management on alpine Orthoptera. *Biodivers. Conserv.* **2011**, *21*, 281–296. [[CrossRef](#)]
97. Evette, A.; Peyras, L.; François, H.; Gaucherand, S. Environmental risks and impacts of mountain reservoirs for artificial snow production in a context of climate change. *Rev. Geogr. Alp.* **2011**, *99*, 2. [[CrossRef](#)]
98. Little, C.M.; Needham, M.D. Skier and Snowboarder Motivations and Knowledge Related to Voluntary Environmental Programs at an Alpine Ski Area. *Environ. Manag.* **2011**, *48*, 895–909. [[CrossRef](#)]
99. Steiger, R. The impact of snow scarcity on ski tourism: An analysis of the record warm season 2006/2007 in Tyrol (Austria). *Tour. Rev.* **2011**, *66*, 4–13. [[CrossRef](#)]
100. Roux-Fouillet, P.; Wipf, S.; Rixen, C. Long-term impacts of ski piste management on alpine vegetation and soils. *J. Appl. Ecol.* **2011**, *48*, 906–915. [[CrossRef](#)]
101. Smerecnik, K.R.; Andersen, P.A. The diffusion of environmental sustainability innovations in North American hotels and ski resorts. *J. Sustain. Tour.* **2011**, *19*, 171–196. [[CrossRef](#)]
102. Bank, M.; Wiesner, R. Determinants of weather derivatives usage in the Austrian winter tourism industry. *Tour. Manag.* **2011**, *32*, 62–68. [[CrossRef](#)]
103. Negro, M.; Isaia, M.; Palestini, C.; Schoenhofer, A.; Rolando, A. The impact of high-altitude ski pistes on ground-dwelling arthropods in the Alps. *Biodivers. Conserv.* **2010**, *19*, 1853–1870. [[CrossRef](#)]
104. Bark, R.H.; Colby, B.G.; Domínguez, F. Snow days? Snowmaking adaptation and the future of low latitude, high elevation skiing in Arizona, USA. *Clim. Chang.* **2009**, *102*, 467–491. [[CrossRef](#)]
105. Burt, J.W.; Rice, K.J. Not all ski slopes are created equal: Disturbance intensity affects ecosystem properties. *Ecol. Appl.* **2009**, *19*, 2242–2253. [[CrossRef](#)]

106. Arcuset, L. Possible paths towards sustainable tourism development in a high-mountain resort: The case of Valloire. *Rev. Geogr. Alp.* **2009**, *97*, 1–13. [\[CrossRef\]](#)
107. Vanham, D.; Fleischhacker, E.; Rauch, W. Impact of snowmaking on alpine water resources management under present and climate change conditions. *Water Sci. Technol.* **2009**, *59*, 1793–1801. [\[CrossRef\]](#)
108. Kangas, K.; Tolvanen, A.; Kälkäjä, T.; Siikamäki, P. Ecological Impacts of Revegetation and Management Practices of Ski Slopes in Northern Finland. *Environ. Manag.* **2009**, *44*, 408–419. [\[CrossRef\]](#)
109. Hoffmann, V.H.; Sprengel, D.C.; Ziegler, A.; Kolb, M.; Abegg, B. Determinants of corporate adaptation to climate change in winter tourism: An econometric analysis. *Glob. Environ. Chang.* **2009**, *19*, 256–264. [\[CrossRef\]](#)
110. Shih, C.; Nicholls, S.; Holecek, D.F. Impact of Weather on Downhill Ski Lift Ticket Sales. *J. Travel Res.* **2008**, *47*, 359–372. [\[CrossRef\]](#)
111. Scott, D.; Dawson, J.; Jones, B. Climate change vulnerability of the US Northeast winter recreation– tourism sector. *Mitig. Adapt. Strat. Glob. Chang.* **2007**, *13*, 577–596. [\[CrossRef\]](#)
112. Pröbstl, U.; Prutsch, A.; Formayer, H.; Landauer, M.; Grabler, K.; Kulnig, A.; Jesch, M.; Dallhammer, E.; Krajasits, C. Climate change in winter sport destinations—Transdisciplinary research for implementing sustainable tourism. *Sustain. Tour. III* **2008**, *115*, 165–173.
113. Sharma, S.; Aragón-Correa, J.A.; Rueda-Manzanares, A. The contingent influence of organizational capabilities on proactive environmental strategy in the service sector: An analysis of North American and European ski resorts. *Can. J. Adm. Sci.* **2007**, *24*, 268–283. [\[CrossRef\]](#)
114. Scott, D.; McBoyle, G. Climate change adaptation in the ski industry. *Mitig. Adapt. Strat. Glob. Chang.* **2006**, *12*, 1411–1431. [\[CrossRef\]](#)
115. Bicknell, S.; McManus, P. The Canary in the Coalmine: Australian Ski Resorts and their Response to Climate Change. *Geogr. Res.* **2006**, *44*, 386–400. [\[CrossRef\]](#)
116. Scott, D.; McBoyle, G.; Minogue, A.; Mills, B. Climate change and the sustainability of ski-based tourism in eastern North America: A reassessment. *J. Sust. Tour.* **2006**, *14*, 376–398. [\[CrossRef\]](#)
117. Rivera, J.; De Leon, P.; Koerber, C. Is Greener Whiter Yet? The Sustainable Slopes Program after Five Years. *Policy Stud. J.* **2006**, *34*, 195–221. [\[CrossRef\]](#)
118. Wipf, S.; Rixen, C.; Fischer, M.; Schmid, B.; Stoeckli, V. Effects of ski piste preparation on alpine vegetation. *J. Appl. Ecol.* **2005**, *42*, 306–316. [\[CrossRef\]](#)
119. Rivera, J.; de Leon, P. Is greener whiter? Voluntary environmental performance of Western Ski Areas. *Policy Stud. J.* **2004**, *32*, 417–437. [\[CrossRef\]](#)
120. Scott, D.; McBoyle, G.; Mills, B. Climate change and the skiing industry in southern Ontario (Canada): Exploring the importance of terms and conditions. *Clim. Res.* **2003**, *23*, 171–181. [\[CrossRef\]](#)
121. George, A. Managing ski resorts: Perceptions from the field regarding the sustainable slopes charter. *Manag. Leis.* **2003**, *8*, 41–46. [\[CrossRef\]](#)
122. Good, R. Ecologically Sustainable Development in the Australian Alps. *Mt. Res. Dev.* **1995**, *15*, 251–258. [\[CrossRef\]](#)
123. Holden, A. The use of visitor understanding in skiing management and development decisions at the Cairngorm mountains, Scotland. *Tour. Manag.* **1998**, *19*, 145–152. [\[CrossRef\]](#)
124. Peeters, P.M.; Gössling, S.; Klijs, J.; Milano, C.; Novelli, M.; Dijkmans, C.H.S.; Mitas, O. *Research for TRAN Committee-Overtourism: Impact and Possible Policy Responses*; European Parliament, Directorate General for Internal Policies, Policy Department B: Structural and Cohesion Policies, Transport and Tourism: Brussels, Belgium, 2018.
125. Dodds, R.; Butler, R. *Overtourism: Issues, Realities and Solutions*; De Gruyter: Berlin, Germany, 2019.

Article

A Model of the Sustainable Management of the Natural Environment in National Parks—A Case Study of National Parks in Poland

Piotr Oleśniewicz ¹, Sławomir Pytel ^{2,*}, Julita Markiewicz-Patkowska ³, Adam R. Szromek ⁴ and Soňa Jandová ⁵

¹ Faculty of Physical Education, University School of Physical Education in Wrocław, al. Ignacego Jana Paderewskiego 35, 51-612 Wrocław, Poland; piotr.olesniewicz@awf.wroc.pl

² Faculty of Life Sciences, University of Silesia in Katowice, ul. Będzińska 60, 41-200 Sosnowiec, Poland

³ Faculty of Finance and Management, WSB University in Wrocław, ul. Fabryczna 29–31, 53-609 Wrocław, Poland; jmarkiewicz@op.pl

⁴ Faculty of Organization and Management, Silesian University of Technology, ul. Roosevelta 26, 41-800 Zabrze, Poland; innowator@o2.pl

⁵ Technical University of Liberec, Faculty of Mechanical Engineering, Department of Applied Mechanics Studentská 2, 461 17 Liberec, Czech Republic; sona.jandova@tul.cz

* Correspondence: slawomir.pytel@us.edu.pl; Tel.: +48-323-689-213

Received: 30 January 2020; Accepted: 27 March 2020; Published: 30 March 2020

Abstract: This paper aimed to present a model of natural environment management in national parks in Poland in the context of increased tourist traffic. The research area comprised Polish national parks as they are characterized by barely altered nature, little human impact, and undisturbed natural phenomena. The methods involved the observational method, literature analysis and criticism, and the in-depth interview method employed in November 2019. The respondents included national park management staff. The questions were prepared in accordance with the Berlin Declaration principles of sustainable tourism development and were extended with the authors' own items. The questionnaire contained 17 questions, grouped in four parts: science and documentation; tourism; cooperation and education; environmental threats. The results indicate that in order for actions to prove efficient in a park, a conservation plan should be carefully developed. Its correctness requires monitoring the state of the environment, tourist traffic size and trends, and tourists' impact on the environment. An important condition for effective tourism management in parks is to increase the competences of the administering bodies and knowledge regarding individuals' responsibilities. Boards should be able to evaluate and modify conservation plans, spatial development plans, municipality development strategies, and projects for investments within the parks.

Keywords: sustainability; national park; management; tourism

1. Introduction

One of the basic contemporary problems is to maintain balance between tourism development and the need to preserve the valuable natural heritage. The only way to achieve the compromise is sustainable development, the principles of which are embedded in the strategies of all fields of the economy, including tourism. However, the low social awareness of threats, as well as the incomes from tourism for the inhabitants of regions attractive to tourists, significantly complicates the management of valuable natural areas.

The best known form of nature conservation, embracing areas of the most valuable nature and landscape, are national parks. Their idea dates back to the second half of the 19th century, when the first national park in the world, Yellowstone National Park, was established in 1872. Some researchers claim

that this form of nature conservation should actually be treated as an investment for future generations [1]. Therefore, proper management of a national park is important and should consist in proper planning, organizing, supervising, and controlling its activities [2]. Modern tourism is often oriented towards short-term income and thus contributes to the destruction of what it was originally supposed to profit from. This is caused by excessive concentration of tourist traffic, an improperly located tourist base, often in places of highest natural value, inappropriate forms of organizing recreation, and a lack of tourist culture. The introduction of pro-environmental measures in tourism may contribute to increasing the number of new jobs, while reducing the consumption of non-renewable resources. Planning actions for the sustainable development of human–nature systems requires integrated management and thinking. Two important elements in the management of the relationship between nature and the community are ecosystem services and community livelihoods [3]. Natural protected areas face the challenge of reconciling natural attractions with the satisfaction of different stakeholders without compromising their own resources. Appropriate management and marketing can play an important role in sustainable activities [4]. In terms of management, natural beauty can be a double-edged sword for a given area. Beautiful scenery is a magnet that attracts not only visitors but also second home owners. The latter can make a significant contribution to the local economy; a high demand for moving can increase the prices of local products and real assets, which in turn may affect the quality of life of local residents. On the other hand, the development of real assets may threaten the integrity of natural resources in the area. Therefore, a sustainable approach should be adopted in regions attractive in terms of their natural environment to prevent overtourism [5].

According to the World Commission on Protected Areas, the management of protected areas is now understood as the main element of the legal, political, institutional, and practical framework of conservation worldwide. The concept and its application remain a challenge for most countries. Countries are obliged to promote management diversity and to strengthen the relevant policies, practices, and capacities. The World Commission on Protected Areas (WCPA) has also prepared technical tools, such as the best practice guidelines for the management of protected areas. The Commission's objective is to increase the capacity, effectiveness, and efficiency of protected area managers, both decision makers and others, in relation to sustainable tourism, by learning, exchanging, and developing information and guidance. The presented article is an attempt to engage in the recommendations of the World Commission on Protected Areas.

According to Myga-Piątek and Jankowski [6], tourism is becoming a global social phenomenon, with a considerable anthropogenic impact on the environment. The development of mass commercial tourism, its penetration into all types of landscape, and its impact on various geosystem components are beginning to cause losses and destruction in natural systems, as well as modifications to the socio-cultural environment. The most radical transformations are observed in mountain ecosystems owing to, among others, year-round tourist traffic loads and the orographic specificity. Krupa [7] indicates that the process of tourism management should be holistic, which means that tourism development must be integrated with the development of other economic areas in the region or country. Managing the development of all forms of sustainable tourism, especially in areas of high environmental value, is to consist mainly in properly controlling tourist traffic in time and space, creating zones for different types of tourist penetration, and planning the necessary infrastructure adapted to the individual conditions of the protected area.

On the basis of the above, it was established that it was essential to create a model of natural environment management in national parks in Poland in the context of increased tourist traffic. This became the purpose of the presented paper.

There are many instruments of environmental management in Poland. As indicated by Mizgajski [8], management can be divided into ongoing and programmed environmental protection. The most important groups of current control instruments include legal and administrative procedures and solutions, financial and economic instruments, and sanctions. In the first group, the author enumerates administrative decisions of regulatory nature, administrative proceedings conducted with public participation. The financial and economic instruments of environmental management

involve, among others, charges for the use of the environment and administrative financial penalties, together with a mechanism for deferring and remitting them when investments are carried out, which eliminate exceeding the permissible levels of pollutant emissions, as well as public funding support for environmental conservation projects. There are also so-called soft instruments related to the market-based approach to environmental conservation by promoting environmentally friendly products. Mizgajski [8] also discusses the second vast sphere of environmental management, namely environmental conservation planning. It covers the whole range of issues related to preparing and evaluating programme documents, including those of a strategic character. All of them must begin with an environmental diagnosis involving an assessment of the state of the environment, anthropogenic impact, as well as the corrective actions taken. On its basis, future changes are projected and the scope of the programme implementation is defined.

However, the literature lacks descriptions of sustainable and comprehensive management. Therefore, it is justified to address the issue of model natural environment management in a sustainable manner, which can be completed by effective, sustainable, and comprehensive management.

2. Literature Review

Investigating the relationship between the natural environment and man is of interest to many scientific disciplines. In addition to the biological and geographical sciences that traditionally refer to it, the following should be mentioned: sociology, economics, spatial planning, landscape architecture, urban planning, political science, and law sciences. The scientific discourse is conducted on the basis of the assumptions of the sustainable development concept around the relationships among natural, cultural, and socio-economic values. Such a wide range of research into the relationship between nature and man has yielded a rich literature output.

Human–environment relations are an important research issue of physical and socio-economic geography and regional geography. Here, one can point at works on research methods and relationships between man and nature [9–12]. Moreover, the impact of the park and social dilemmas have been analysed [13–16], as well as major problems and trends in the relationship between the environment and man [17,18]. Regional geography has been discussed as a discipline and subject of research and teaching [19–23]. Human activity changes our natural environment and, in extreme cases, even leads to the exhaustion of biodiversity. Chemini and Rizzoli [24] have paid special attention to this, pointing out that biodiversity not only has ethical and cultural value but also plays a role in the functioning of ecosystems.

There is also a wealth of theoretical output in the field of research methods and the assessment of the human–environment relationship. A research methodology has been described [25–28], and modelling sustainable development by constructing theories and typologies has been dealt with [29–32]. Butler [33] reviewed the term ‘sustainable tourism,’ starting with a discussion on the confusion arising from imprecise and contradictory definitions of the concept and the need to distinguish between sustainable tourism and tourism development based on sustainable development principles.

Numerous studies have focused on quantitative methods and emphasized the economic aspects. The economic benefits of national parks were described [34,35], as well as park management and the costs and advantages of parks. Abel and Blaikie [36] present new ideas for wildlife conservation in Africa, indicating that they are inappropriate. A high proportion of the ideas do not address problems related to social conflicts. It is precisely these historical conflicts that can reveal much about the sources of contemporary ecological problems. The case study of the Luangwa Valley in Zambia demonstrates a method to remedy these weaknesses. In the first part of the article, the authors examine the role of Luangwa national parks in the context of the Zambian political economy and identify social groups competing for park resources. They then follow the historical origins of contemporary ecological changes. These analyses lead to a model of parks and their relationships with the national economy. Clough and Meister [37] point out that since resources are limited, there is greater pressure on those who manage them to share them in a way allowing to maximise the benefits to the society. In this

study, an attempt was made to do this for the Whakapapa ski field and a village in Tongariro National Park. The aim of the research was to provide information that would allow us to estimate the economic value of the Whakapapa ski field, both for the region and for the whole country. This entails the use of appropriate economic techniques which, although well known abroad, had been relatively rarely used in New Zealand. Trakolis [38] presented the local residents' perception of planning and management issues, as investigated in a national park in north-western Greece. The conflicts caused by the lack of the local community participation in the designation procedure and then in the decision-making process required research. The author verified the knowledge about the park and its objectives, the necessity of works and the quality of infrastructure, attitudes towards certain decisions, and the management pattern and effectiveness. Ferraro [39] focused on the fact that the long-term integrity of protected areas in low-income countries depended on the support of the neighbouring rural communities. He pointed out the need to understand the alternative costs of nature conservation, which are borne by the rural communities neighbouring the protected areas. The author stated that there were few analyses of the effects of establishing protected areas. Cihar and Stankova [40] collected opinions and attitudes towards nature conservation and tourism in the territory of a Czech national park that had been closed to the public for 40 years because of the Iron Curtain. The authors conducted a survey among visitors, residents, and representatives of local self-governments.

An important issue raised in the literature was the awareness of the need to involve local communities in the processes of managing natural resources and protected areas. The researchers pointed out that the condition of the coexistence of nature and people living in protected areas was proper social communication.

Another issue was the impact of the community on national parks. Jarvis [41] points out that land protection in parks is often perceived as a cost for the economic development of rural areas. However, the debate on the development of the Canyon Forest Village on the southern edge of the Grand Canyon suggested the opposite. It indicated that natural systems could be extremely valuable to rural economies and that national parks and rural area development could go hand in hand. According to Kideghesho et al. [42], attitude research is increasingly recognized as a tool for assessing public understanding and acceptance for protection. The results of the study were useful in guiding political interventions. The investigators found that attitudes were positively or negatively influenced by many factors. Factors triggering positive attitudes reinforce protection objectives, while those generating negative attitudes may adversely affect the objectives.

There is also research on social conflicts in national parks. Fortin and Gagnon [43] indicate that many national parks have been established around the world to protect nature, but not without consequences for the neighbouring communities. As the social and economic development of the population living around the park is increasingly recognized as essential to achieve protection objectives, the quality of park–community relationships has become a key issue. Burger [44] emphasizes the importance of the position of local people in the case of investments that may affect their lives. He claims that the participation of the local community in the course of park construction should be a significant element of the decision-making process. Królikowska [45], points to the so-called British concept of the relationship between the local population and the protected area, where people are perceived as an integral part of the landscape. The system of managing protected areas is as a rule focused more on sustainable development than on strict protection. This approach allows for the promotion of agricultural, forestry, or fishing activities within protected areas. Hibszer [46] referred to a key issue of the relationship between man and environment. The problem addressed in the study concerned the relationship between the national park and the local community. Its essence was to answer the question of how the population living in national parks or their vicinity perceived their relationship with their closest national park. The awareness of the need to maintain balance between the protection of natural and landscape values and the social and economic development of park communes, as declared by the authorities, is an important premise for verifying the relationships between this form of protected areas and local communities in Poland. According to Barker [47], further development of

mass tourism in the Alps burdens the landscape and the local communities. However, various forms of the development are observed. In the western Alps, ski resorts develop at high altitudes, outside local communities. In the eastern Alps, tourist facilities are concentrated around traditional communities. Congestion and pollution are obvious. Local and regional planning strategies adopted in response to changes in tourism in the Alps provide relevant experiences for other mountain regions.

Other social conflicts have also been described. Beltran [16], presented an interesting way of resolving conflicts between a national park and the population on the example of Sagarmatha National Park. The government of Nepal responded to international concerns about the environmental crisis by establishing Sagarmatha National Park. In many parts of the world, the formation of national parks displaced indigenous people and imposed a strict nature conservation policy to create 'wilderness'. Sagarmatha National Park, on the other hand, was a pioneering example of a new type of protected area, which recognized the rights of indigenous people to settle and provide for themselves. Bauer [48], on the example of Waza National Park in Cameroon, indicated complex interactions between the park and the surrounding population. The adopted management plan allowed for human cooperation, with a limited use of natural resources. In order to determine which resources were desirable and which represented commitments, interviews were conducted with people from the park vicinity. In their study, Bojórquez-Tapia et al. [49] recognize nature reserves as a category of land use that competes with other land uses. Therefore, one of the basic objectives of conservation planning is to design reserves that protect the most valuable areas. However, the complexity of conservation issues, as well as the urgent need to protect the key elements of biodiversity and a lack of data, forced planners to rely on expertise and public participation when developing projects. According to Colchester [50], nature protection through establishing 'national parks' in the USA violated the rights of indigenous people, causing their impoverishment and social problems. After many efforts, international rules finally acknowledge the rights of indigenous people, and the new protection policy allows them to own and manage protected areas. Nevertheless, field studies show that these new rules are not yet widely applied. Stern [51] presents a model based on empirical research explaining local objections to neighbouring protected areas. Analyses of data from 420 interviews with local residents and almost a year's observation of three national parks revealed that the assumptions concerning local residents motivated primarily by rational economic stimuli were at best incomplete.

Some research pointed at ways to resolve conflicts through appropriate resource management [52–55].

The tourist traffic in national parks has also been studied and described on numerous occasions. Many studies have been devoted to the sustainable development of tourism [56–60]. Debates on sustainable tourism were conducted, among others, by Hunter [61]. Paunović and Jovanović [62] tried to answer the question of what lay behind the efforts for sustainable tourism in the German Alps and what views on these processes were represented by various stakeholders in the tourism industry.

The issue of modern tourism business in local development was discussed by Mortensen et al. [63] and Mika [64]. Elmi and Perlik [65] decided to investigate the reappearance of residents in the Alps. Research carried out in previous years highlighted the depopulation of these areas, and now the authors have observed the phenomenon of a renewed influx of inhabitants. There are also theoretical references to the man–nature tourism impacts [66–69]. The benefits of tourism for natural resource management in parks have been described [70–75]. Gios et al. [76] measured the benefits of natural resources for tourism. They pointed out that measuring certain advantages made it possible to create appropriate development strategies. The researchers presented possible solutions for sustainable tourism in environmentally valuable areas.

Among the investigations on the attitude of local communities to national parks, the studies of many researchers stand out. They point to the objection of local communities to delimiting protected areas. Kaltenborn et al. [77] indicated that the community-based management of protected areas had become a strong political objective worldwide. Many African countries responded to this challenge, although with variable results. Tanzania, known for its abundant wildlife population in national parks, developed several projects aimed at improving the relationship between the park and people. So far,

however, there is little evidence that community-based programs have had any significant impact on management strategies, benefit distribution, or poverty alleviation. Von Ruschkowski [78] claims that the designation of protected areas (e.g., national parks) often leads to conflicts between local communities and the area administration. This phenomenon occurs all over the world and is probably as old as the very idea of a national park. These conflicts often affect both the protected areas and the local communities, as tense relationships entail the risk of disruption to park planning, conservation objectives, or regional economic development.

Researchers also determine the factors influencing acceptance. Raval [79] discussed investigations carried out to understand resource use and management issues, as perceived by the people living in the park vicinity. The study was conducted in the form of in-depth interviews, mainly with cattle breeders living in Gir National Park in India. Fiallo and Jacobson [80] pointed out that the economic and social problems faced by many developing countries threatened the existence of such parks. Similarly, other authors [81–83].

2.1. Sustainable Development

According to Piontek [84], more than 40 definitions of sustainable development are mentioned in the literature. They all draw attention to the different manifestations of the use, application, and understanding of these words. The notion of sustainable development was first publicly applied during the first United Nations Conference on Environment and Development in Stockholm in 1972. The first definition, in turn, appeared at the United Nations Environment Programme management body session in 1975 and described sustainable development as a course of inevitable and desirable economic development that did not significantly or irreversibly disturb the human environment, did not lead to biosphere degradation, and reconciled the laws of nature, economics, and culture. For the purposes of this study, the definition of sustainable development was adopted as the right to satisfy the development aspirations of the current generation without limiting the rights of future generations to satisfy their development needs [85]. This definition indicates that sustainable development does not constitute environmental conservation in its conventional meaning. Through the harmony of economic, natural, and social aspects, this development is safe and beneficial for man, the environment, and the economy. It does not hinder development but even stimulates it, it does not take place at the cost of destroying the environment, for the benefit of future generations, who will also have the right to develop. Weaver, D.B., and Lawton, L.J. [86] identify a deepening crisis of protected areas, which is affected by four factors. Firstly, relatively undisturbed natural habitats around the world continue to be destroyed and converted to serve other purposes as human populations increase, prosperity develops, and more natural resources are used. Secondly, the reduced government funding worldwide decreases their ability to fulfil key environmental functions. Thirdly, revenues are visitor-based and, as a result, a large part of them is spent on visitor satisfaction and not on environmental management. The fourth factor is the increasing demand for rural outdoor and nature-based recreation in the increasingly urbanized societies.

Leung, Y.F. [87] points out that protected area managers need a wide range of skills and expertise to manage the complexity of protected area systems. The IUCN best practice guidelines are designed to meet these needs, including the sharing of good practice experience around the world. Many protected areas are managed for tourism and visits as part of their objective, involving a wide range of stakeholders and the private sector. The rapidly growing demand for the development of tourism related to protected areas emphasizes the need to provide clear guidance that will contribute to sustainable tourism in line with the fundamental objectives of protecting valuable areas. From a conservation point of view, tourism and sightseeing represent a complex set of challenges. Protected area managers around the world are expected to make most of the areas accessible to visitors. Protected areas are a crucial element of any global conservation strategy. Tourism acts as an important way of connecting visitors and valuable protected areas.

Eagles, P.F., Bowman, M.E., and Tao, C.H. [88] elaborated on the ideas discussed above primarily for the planners and managers of parks and protected areas. It was designed to help park managers

think about the inflow of tourists into protected areas and to encourage them to consciously plan the management of the interaction between tourists and the environment. Effective planning allows different interest groups to maximize the potential positive effects of tourism while minimizing the negative ones. The document is an important and requested material for protected tourism in East Asia. It constitutes a valuable resource for park managers and other decision makers involved in park planning, supplementing current practices and theories applied by park authorities. The document contains information on best practices, guest management, education, stakeholder involvement, and other issues related to the protected area.

Mandić, A. [89] indicates that protected natural areas are often considered as areas of high recreational value; therefore, many of them are increasingly threatened by the development of tourism. The research was conducted in a socio-economic context to address the complexity of this global problem. The study is based on an inductive approach to highlight the need for eco-thinking. The paper provides an analysis of global and local factors that drive change. It concludes that the durability of nature-based tourism and the resilience of protected areas are not possible in the absence of a multi-level management system, monitoring, education, and community consent.

Mandić, A., and Petrić, L. [90] presented a study that analysed the economic effects of creating protected areas and indicated the implications for the public and private sectors. To this end, they applied the hedonic pricing method in order to take into account changes in hotel prices in relation to their location. The research results revealed a relationship between the unique environmental attributes of a site and hotel prices. Hotels located near the territory of a national park charge higher fees, while increasing the distance from the park territory reduces prices. The researchers found that protected areas were components of an integrated tourist product, influencing the prices of complementary tourist services, visitors' satisfaction, and the competitiveness of destinations.

2.2. Tourism in the Aspect of Sustainable Development

New needs and expectations of tourists are the basis for creating tourist products that are consistent with the principles of sustainable development. These principles are so crucial that the concept of sustainable tourism has developed, as defined in the Charter for Sustainable Tourism. The concept is the result of seeking dependencies and links between the economic, environmental, and social factors determining development with a balance among them [91]. Any attempt to introduce the concept of sustainable tourism development involves the need to relate it to a specific area with a specific tourism potential. In this case, these are national parks, where the values of the natural environment, the existing development, as well as tourist traffic and its consequences must be studied. This leads to a concept of sustainable tourism management in the region. Gałazka [91] implies that, in accordance with the definition presented by the European Federation of Natural and National Parks, sustainable tourism should be considered to be any form of development of tourist traffic, tourist activity, and management that maintains the ecological, social, and economic integrity of territories and preserves their natural and cultural resources for future generations. According to Para [92], the definition of sustainable tourism should acknowledge the environmental durability, relate to the economy concerned, and be socially and ethically adapted to the standards of the given community. These conditions can be met if all parties involved in tourism respect one another and cooperate. Sustainable tourism has been addressed by many researchers, who presented the understanding of and challenges for sustainable tourism development and the roles of stakeholders [93–96], as well as the problems of tourist indicators, sustainable development, environmental management, and measuring satisfaction with sustainable tourism [97–99]. An important role of research into new ways of describing sustainable tourism has been explored by McCool, S.F., and Bosak, K. (Eds.) [100]. Their investigation indicated that tourism is only one of many human activities that affects host communities. Their paper includes engaging case studies with realistic applications. The references contained in the book, as well as tools and techniques useful for tourism practitioners, suggest an innovative approach to marketing, management, and community development. The authors point out that sustainable development is

becoming a top priority, as tourist destinations try to maintain and increase their attractiveness to tourists. However, tourism is now an economic activity and an engine of global capitalism. For this reason, there is a tension between tourism and sustainable development. The researchers conduct an important discussion on how sustainable tourism can be reformulated with the use of the indicated set of tools.

2.3. The Essence of National Park Management

Environmental management is mainly the management of conservation and environment formation. It is based on the so-called Deming circle, in which the actions taken are grouped into planning, implementing the plan, checking (assessing the effectiveness of the actions), correcting shortcomings, and adapting the plan to the new circumstances. Therefore, the system of environmental management is grounded in cyclical activities aimed at continuous improvement [101].

As indicated in Article 8b Item 1 of the act on nature conservation [102], the responsibilities of national parks include in particular:

1. Carrying out conservation activities in the national park ecosystems, aimed at achieving the objectives referred to in Article 8 Item 2;
2. Providing access to the national park area in accordance with the principles set out in the conservation plan referred to in Article 18 or in the conservation responsibilities referred to in Article 22 and in the ordinances of the national park director;
3. Conducting activities related to nature education.

The management of a national park should be performed in at least three categories:

- The management of nature conservation;
- The management of a business entity;
- The management of a public institution.

Nature conservation and the negative effects of tourist traffic in national parks are enumerated both in the act on nature conservation [102] and in the ordinances of the national park director. In order to counteract these effects, the national park director determines, among others, the number of people who can stay in a given place at the same time or the amount of admission fees. An important role is also ascribed to conducting educational activity, aimed primarily at teaching the society how to use natural resources [100].

National parks are also business entities. Kunasz [103] specifies that the resources of national parks include:

- Tangible resources, such as natural resources, land, buildings, means of transport, machinery, and equipment;
- Human and organizational resources: national parks have their own organizational structures;
- Financial resources, understood as the possibility of obtaining the income characteristic of national parks, including special purpose grants, revenues related to providing access to the national park, and conducting educational activity, as well as income from timber sales.

National parks cannot be managed by economic instruments alone. These may only be used to supplement administrative and legal instruments. That is why the organizational and legal status of the park plays an important role in its management. As indicated by Ruśkowski and Salachna [104], a national park is a state legal entity; therefore, it can be a subject of civil law relations and can take credits and loans (up to 60% of the amount of income or 60% of costs), and the property of a national park entirely constitutes state property. In turn, the Act on public finance [105] in Article 9 Item 14 specifies that a national park is a public finance sector unit, managed by the park director, but supervised by the Minister of Environment. And it is the Minister of Environment who controls the operation of national parks.

Wasiuk [100] presented two main factors in national park management:

1. The factor distinguishing a national park from other entities: the legal regulations governing the activities of national parks, the management of a particular type of resources in national parks, and the dependence of the decisions taken on the needs of nature;
2. The factor differentiating national parks: the attractiveness of the national park for visitors, the significance of the park's nature for the society, the location and size of the park and its assets, budget size (including the amount of state funding and of so-called own revenues), and the number of employees.

The European Charter for Sustainable Tourism provides an important management model. It is an initiative of EUROPARC, which has long recognized the need to care for both the land and the people who live and work there. National parks are not only facing challenges and pressures arising from the visits to and misuse of the land that they manage; they also have the opportunity and potential to act as catalysts for change in sustainable development and lifestyle at the local, regional, and even national level. The European Charter for Sustainable Tourism in Protected Areas is a practical management tool that enables sustainable tourism development in protected areas. A key element of the charter is a common strategy for sustainable tourism and an action plan based on an in-depth analysis of the situation. The aim of all projects and actions of the charter is to protect the natural and cultural heritage and to continuously improve tourism in protected areas in terms of the environment, local people, and businesses, as well as visitors. Over 20 years of experience have shown that the charter is a useful and important tool that provides social, environmental, and economic benefits.

3. Material and Methods

The research involved 23 national parks owing to the prominence of the natural heritage that they have and make available to tourists. National parks are a sanctuary of wildlife, a place where protection is provided for entire ecosystems, i.e., all living organisms linked by interrelationships and inanimate elements of the environment in which they exist.

For this reason, the management of a national park is extremely difficult and requires model solutions to protect what is most valuable and at the same time to make it available to tourists.

3.1. Research Area

The research area comprised Polish national parks as they are characterized by barely altered nature, little human impact, and undisturbed natural processes and phenomena. Here, there is the last natural forest of the European Plain, the location of many unique and endangered species of fauna and flora, and the most famous bison habitat in the world.

In Poland, 23 national parks were created (Figure 1), which cover 1% of the country area. The parks operate on the basis of the act of April 16, 2004, on nature conservation. In accordance with Article 8 Item 1 of the act, a national park covers an area distinguished by specific natural, scientific, social, cultural, and educational values, with an area of not less than 1000 ha, where all nature and landscape values are subject to conservation. The internal organization, mode of operation, and manner of granting powers of attorney have been modified; since January 1, 2012, there is a regulation in force according to which the minister in charge of the environment, by way of an ordinance, grants a national park its statute, considering the need to ensure its efficient operation. A national park is managed by a director, appointed by the Minister of Environment, for a period of five years, from among the candidates selected by a competition.

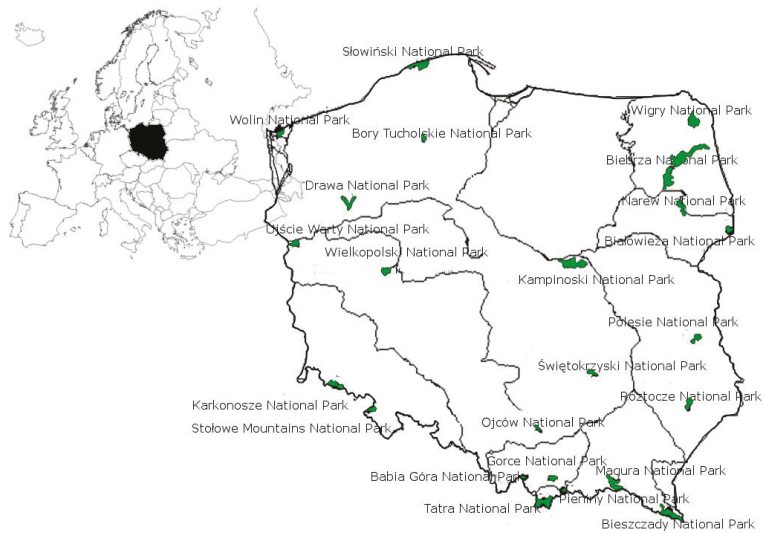

Figure 1. National parks in Poland against the background of Europe [106].

An important feature of the tourist traffic in national parks is the seasonality of visits, limiting the tourist traffic peak to 2–3 months. In most national parks, the tourist traffic is seasonal in nature, and the dependence on this factor has different significance in individual parks. Coast parks are burdened with a large number of visitors only during the holiday period. Mountain parks, where winter tourism is also practised, have more balanced numbers of visits. The number of days off from work (the so-called long weekends) also affects the increase in the number of park visitors: there are more individual trips and several-hour visits with own transport.

3.2. Research Methods

In the paper, the following research methods were used: the observational method, the method of analysis and criticism of literature, and the method of in-depth interviews. The observation method played a major role. Observation is among the oldest research methods, allowing to put forward a hypothesis, collect data, verify and select materials, clarify issues, formulate a thesis, establish contacts with the studied group. Its characteristic feature is cyclicity. Observation as a method must assume a selection of observations under predefined conditions. It must adopt an appropriate selection, the criterion being determined by the purpose of the observation. Observation is a research method when it considers all stages of research activities. As a method, it determines how to prepare and implement the research technique and tools, consolidate observations, compile observation protocols, and develop research results and scientific generalizations. The most characteristic feature of observation is its cyclic nature: it starts with facts and ends with them, and the facts ending one cycle begin the subsequent one [94].

Another method was that of literature analysis and criticism. With this method, one can determine what is known and what is not known, and what exists in the literature and what is not there yet. One can establish whether the problem addressed is original, different from the discoveries known so far. The method allows to demonstrate differences, similarities, relationships, dependencies, and substantial features in the existing theories. The results of studies based on this method lead to important discoveries concerning activities and creative works. This method is widely used in humanities but also in economic sciences. Its aim is also to establish relationships between products of creative activity. It is usually about determining the impact of one solution on another, for example,

one work on another, one theory on another. Since comparison is among the basic mental activities, it is an important component of most research methods [94].

An important role was played by the in-depth interview method. It consists in a conversation between a researcher and a respondent. The objective is to obtain detailed opinions and information from specific individuals who meet the sampling criteria defined by the investigator. The technique is also applied to explain the nature of the phenomenon under investigation, to get to the essence, and to obtain information that would be difficult to achieve with other methods. In a regular questionnaire, the respondent is usually confronted with a list of available answers to questions. In an in-depth interview, the emphasis is on freedom of expression. The interviewer directs the conversation in such a way that all topics are covered, but allows full freedom of expression on the part of the respondent. For this reason, the interview usually takes about 1 hour. In-depth interviews should be chosen when one wants to get to know the independent opinions of experts, discover the opinions of hardly accessible people, raise difficult issues. In-depth interviews allow us to well understand the opinions and attitudes of the interlocutors, describe the motives of actions, check the level of comprehension of ideas and materials, explore a brand image, determine the characteristics of a potential user, describe attitudes towards social phenomena, and determine the optimal level of changes proposed in the environment [94].

The research was conducted in November 2019 and followed the steps presented in Figure 2.

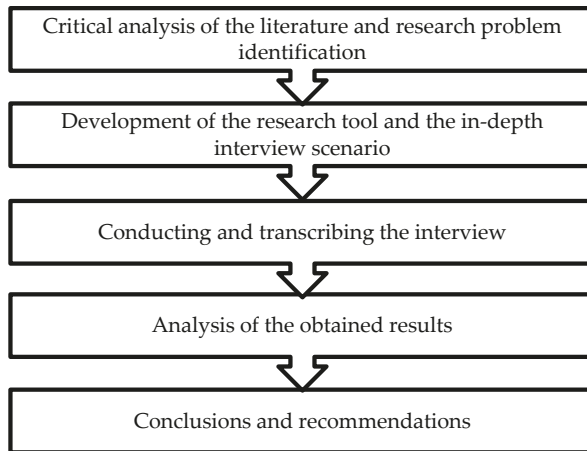

Figure 2. The study flowchart (source: own research).

In the initial phase, the authors gathered numerous literature references and, after exploring them, identified the research problem. The proposed problem was to provide strategic advice to the authorities of protected areas, the tourism industry, and other stakeholders on an optimal approach to planning, developing, managing, and monitoring tourism in protected areas. Further on, in accordance with the Berlin Declaration [107], the authors developed a research tool in the form of a questionnaire, which contained 17 questions and consisted of four parts. The next step was research conduction. For this purpose, all national parks in Poland were contacted and the management staff represented by directors, their deputies, or indicated persons were interviewed. After the results were obtained, their statistical processing was started, which consisted of elaborating the primary data into an acceptance index. In the last part, the authors analysed the obtained results and drew conclusions.

The respondents included national park management staff, such as directors, their deputies, or heads of departments. The questions were prepared in accordance with the Berlin Declaration [107] principles of sustainable tourism development and were extended with authors' own items.

The questionnaire contained 17 questions and consisted of four parts: science and documentation, tourism, cooperation and education, and environmental threats.

The statistical analysis consisted in processing the obtained primary data into an acceptance index (AI) ranging from 0 to 1, where 1 indicated full conformity with the analysed requirements. The answers were analysed with reference to all parks together and with the consideration of a distinction into two criteria. The first one was the park qualification as a United Nations Educational, Scientific and Cultural Organization (UNESCO) biosphere reserve or not, the other one constituted a division into five groups resulting from the park type (coast, lake district, lowland, upland, and mountain).

The national park managers were asked the following questions:

1. Does the park have a nature conservation plan?
2. Are environmentally friendly forms of tourist activity promoted?
3. Are there any limits on the number of visitors and people walking on the trails?
4. Are there any specified places where one can put up a tent?
5. Has tourism been identified as an existing or potential threat to the nature of the park?
6. Are environmental indicators for sustainable tourism planning taken into account?
7. Is the development of tourism restricted in areas that have been under greatest impact so far?
8. Is there a monitoring of the existing tourist traffic?
9. Is the environmental impact of tourism monitored?
10. Have the changes in the environmental impact of tourism development been assessed before?
11. Is the existing tourist infrastructure being modernized instead of building a new one?
12. Is ecological education run?
13. Have educational pathways been established?
14. Is there cooperation with local government units?
15. Have regulations been developed concerning the specific way of making the park available?
16. Is admission fee income received?
17. Does the director have a scientific council?

On the basis of a broad source base, an analysis of the current development of tourism in parks and plans in this respect was made. The Local Data Bank of Statistics Poland [108] and websites of parks and tourist organizations served to establish the number of park visitors. As a measure of tourist traffic in national parks, the indicator of tourist traffic intensity was applied, which is the quotient of the number of tourists (thousands) and the length of tourist trails (kilometres). The study also employed the Defert index, providing information on the number of tourists per 1 km² of a tourist area, which allows one to assess the population density in the studied area [109,110].

4. Results

4.1. Results of Secondary Sources Research

The main measure of the tourist function of a given area is the tourist traffic, defined as the movement of people for tourist purposes in the area. More than half of the total tourist traffic in Poland is generated by mountain parks; however, most of the tourist traffic is seasonal in nature. The exceptions are mountain parks, such as Karkonosze National Park and Tatra National Park, where winter tourism is also practised. Polish national parks are very popular among tourists, as evidenced by their high attendance. The creation of each new national park is associated with an influx of tourists. In the first half of the 1960s, when there were only 10 national parks in Poland, the number of visitors was between 4 and over 5 million per year, with a clear tendency to increase. Such high attendance involved company visits, school excursions, and individual tourism. In the 1970s, the number of visitors increased to over 11 million per year. At present, the attendance of visitors to particular national parks varies from 13 thousand people in Drawa National Park to over 3.7 million in Tatra National Park.

In nine parks, the annual number of tourists does not exceed 100 thousand (Table 1). In the following seven, it does not exceed 1 million. The attendance exceeded 1 million in only five parks.

Table 1. Number of tourists visiting Polish national parks in 2009–2017.

Park Name	Number of Tourists (in thousands)									
	2009	2010	2011	2012	2013	2014	2015	2016	2017	
Tatra National Park	2195	2002	2234	2947	2764	3092	3310	3683	3779	
Karkonosze National Park	2000	2000	2000	2000	2000	2000	2000	2000	2000	
Wolin National Park	1500	1500	1500	1500	1500	1500	1500	1500	1500	
Wielkopolski National Park	1200	1200	1200	1200	1200	1200	1200	1200	1200	
Kampinoski National Park	1000	1000	1000	1000	1000	1000	1000	1000	1000	
Pieniny National Park	838	603	710	770	734	719	815	931	898	
Stołowe Mountains National Park	366	319	335	350	347	367	480	286	515	
Bieszczady National Park	350	280	330	297	332	355	388	487	513	
Ojców National Park	400	400	400	400	400	400	400	428	430	
Stowiński National Park	386	311	317	312	309	304	319	323	317	
Białowieża National Park	190	170	134	121	119	120	133	163	249	
Roztocze National Park	100	100	100	120	120	120	134	187	203	
Świętokrzyski National Park	183	145	193	162	148	135	132	144	144	
Wigry National Park	120	110	110	110	110	115	110	125	125	
Gorce National Park	70	60	65	70	70	80	80	80	90	
Babia Góra National Park	67	54	75	63	81	76	81	114	83	
Magura National Park	50	50	45	40	50	40	40	50	50	
Polesie National Park	25	24	24	28	28	28	41	44	49	
Biebrza National Park	39	31	27	33	28	32	39	41	47	
Ujście Warty National Park	20	10	20	57	54	51	52	43	34	
Bory Tucholskie National Park	60	60	60	60	33	33	33	35	32	
Narew National Park	11	13	10	12	15	15	15	20	19	
Drawa National Park	24	22	48	26	19	18	22	16	13	

Source: own elaboration based on Statistics Poland [108].

Changes in attendance were most marked in Roztocze National Park and Polesie National Park, where the number of visitors increased by 100% in the examined period of 2009–2017. The most unfavourable situation was observed in Bory Tucholskie National Park and Drawa National Park, where the number decreased by a half (Table 1).

An important role is played by the length of the designated tourist trails, as it determines the possibility of dispersing tourists around the park area and not exerting excessive environmental impact by tourists. The length of trails is significantly varied and ranges between 16.7 km in Ujście Warty National Park to 550 km in Kampinoski National Park. There are over 200 km of trails in seven parks and over 100 km in five (Table 2).

In order to determine the tourist traffic impact on the nature of the park, in addition to the total number of visitors, it is important to establish their ‘density’ in the park area and along the tourist trails. Taking into account the number of tourists and the size of the park, one can more precisely estimate the impact and compare the parks.

Excessive concentration of tourist traffic or incorrectly located tourist base, as well as inappropriate forms of recreation management and a lack of tourist culture are the main reasons for threats. The development of tourism in protected areas is therefore highly limited. Any actions taken must be consistent with the principles of sustainable development, and the number of tourists visiting a park should be adjusted to the park area. The calculated Defert index implies that the highest density, 3.7 people per km², is in Pieniny National Park. Equally high density occurs in Karkonosze National Park. Tourists will find the most space in Biebrza National Park and Narew National Park (Table 3).

Table 2. Length of tourist trails in Polish national parks in 2009–2017.

Park Name	Tourist Trails (in kilometres)									
	2009	2010	2011	2012	2013	2014	2015	2016	2017	
Kampinoski National Park	560	560	560	550	550	550	550	550	550	
Biebrza National Park	474	464	464	493	498	498	524	499	499	
Bieszczady National Park	245	140	465	465	465	465	465	465	465	
Tatra National Park	275	275	275	275	275	275	275	275	275	
Wigry National Park	245	245	245	245	273	273	273	273	273	
Drawa National Park	160	170	164	170	170	241	241	241	241	
Wielkopolski National Park	215	215	215	215	215	215	215	215	233	
Gorce National Park	155	155	155	155	155	169	169	169	169	
Słowiński National Park	144	144	144	144	144	150	150	166	166	
Polesie National Park	76	136	136	136	114	114	114	114	127	
Karkonosze National Park	118	118	118	118	118	118	118	121	126	
Stołowe Mountains National Park	107	164	196	109	109	109	109	109	109	
Magura National Park	85	98	85	85	94	94	94	94	94	
Bory Tucholskie National Park	75	75	76	92	92	93	93	93	93	
Babia Góra National Park	53	53	55	55	55	55	55	49	55	
Narew National Park	55	55	55	55	55	55	55	55	54	
Wolin National Park	50	50	50	50	50	50	50	50	50	
Białowieża National Park	44	44	42	44	44	44	44	44	44	
Świętokrzyski National Park	41	38	38	38	38	41	41	41	41	
Ojców National Park	40	40	40	37	37	37	37	37	37	
Pieniny National Park	35	35	35	35	35	35	35	35	35	
Roztocze National Park	61	31	31	29	29	29	29	29	29	
Ujście Warty National Park	13	13	13	13	13	17	17	17	17	

Source: own elaboration based on Statistics Poland [108].

Table 3. Number of tourists visiting Polish national parks in 2009–2017 per 1 km²

Park Name	Number of Tourists (per 1 km ²)									
	2009	2010	2011	2012	2013	2014	2015	2016	2017	
Pieniny National Park	3.570	2.570	3.030	3.246	3.090	3.030	3.440	3.930	3.790	
Karkonosze National Park	3.580	3.580	3.580	3.584	3.580	3.580	3.580	3.360	3.360	
Ojców National Park	1.864	1.864	1.864	1.864	1.864	1.864	1.864	1.995	1.995	
Tatra National Park	1.030	0.080	1.050	1.390	1.300	1.459	1.561	1.740	1.780	
Wielkopolski National Park	1.582	1.582	1.580	1.582	1.580	1.580	1.580	1.580	1.580	
Wolin National Park	1.370	1.370	1.370	1.374	1.370	1.370	1.370	1.370	1.370	
Stołowe Mountains National Park	0.580	0.500	0.530	0.552	0.550	0.580	0.760	0.460	0.820	
Kampinoski National Park	0.260	0.260	0.260	0.259	0.259	0.259	0.259	0.295	0.295	
Babia Góra National Park	0.170	0.160	0.220	0.186	0.239	0.190	0.240	0.340	0.245	
Roztocze National Park	0.118	0.118	0.118	0.141	0.141	0.141	0.160	0.220	0.240	
Białowieża National Park	0.180	0.170	0.127	0.115	0.110	0.110	0.129	0.156	0.237	
Świętokrzyski National Park	0.240	0.190	0.254	0.212	0.195	0.177	0.173	0.189	0.189	
Bieszczady National Park	0.012	0.096	0.113	0.102	0.114	0.122	0.133	0.167	0.175	
Słowiński National Park	0.179	0.144	0.147	0.145	0.143	0.141	0.148	0.150	0.147	
Gorce National Park	0.100	0.086	0.092	0.100	0.100	0.110	0.110	0.110	0.129	
Wigry National Park	0.080	0.073	0.073	0.073	0.073	0.076	0.073	0.083	0.083	
Bory Tucholskie National Park	0.130	0.130	0.130	0.130	0.072	0.072	0.071	0.075	0.069	
Polesie National Park	0.025	0.025	0.024	0.029	0.029	0.029	0.042	0.045	0.050	
Ujście Warty National Park	0.025	0.012	0.025	0.070	0.067	0.063	0.065	0.053	0.043	
Magura National Park	0.026	0.026	0.023	0.021	0.026	0.020	0.020	0.026	0.026	
Drawa National Park	0.021	0.019	0.042	0.022	0.017	0.016	0.019	0.014	0.011	
Biebrza National Park	0.007	0.005	0.005	0.005	0.005	0.005	0.006	0.007	0.008	
Narew National Park	0.010	0.017	0.014	0.016	0.005	0.021	0.020	0.003	0.004	

Source: own elaboration based on Statistics Poland [108].

It should be emphasized that the tourist utilization of the parks is strongly determined by their degree of development, which allows for a legal penetration of the area along tourist trails. The analysis of the tourist traffic intensity on the trails reveals that the greatest number of tourists per trail kilometre is observed in Wolin National Park, where there are almost 30 thousand people per trail kilometre each year. There are over 25 thousand on the trails of Pieniny National Park and 15 thousand in Karkonosze National Park. The lowest tourist traffic intensity is reported for Biebrza National Park and Drawa National Park (0.1 thousand each) (Table 4).

Table 4. Number of tourists visiting Polish national parks in 2006–2017 in thousands per trail kilometre.

Park Name	Tourist Traffic Intensity (in thousands per 1 km of trail)											
	2006	2007	2008	2009	2010	2011	2012	2013	2014	2015	2016	2017
Wolin National Park	31.9	31.9	29.9	29.9	29.9	29.9	29.9	29.9	29.9	29.9	29.9	29.9
Pieniny National Park	22.0	23.0	21.5	23.8	17.2	20.3	22.0	21.0	20.5	23.3	26.6	25.7
Karkonosze National Park	17.0	17.0	17.0	17.0	17.0	17.0	17.0	16.9	16.9	16.9	16.5	15.9
Tatra National Park	9.7	8.1	7.6	8.0	7.3	8.1	10.7	10.1	11.2	12.0	13.4	13.7
Ojców National Park	17.4	8.6	9.8	10.1	10.1	10.1	10.7	10.7	10.7	10.7	11.4	11.5
Roztocze National Park	1.7	1.6	2.0	1.6	3.3	3.3	4.1	4.1	4.1	4.6	6.4	6.9
Białowieża National Park	6.2	3.7	2.1	4.3	3.9	3.2	2.7	2.7	2.7	3.0	3.7	5.6
Wielkopolski National Park	5.6	5.6	5.6	5.6	5.6	5.6	5.6	5.6	5.6	5.6	5.6	5.2
Stołowe Mountains National Park	1.8	2.1	2.0	3.4	1.9	1.7	3.2	3.2	3.4	4.4	2.6	4.7
Świętokrzyski National Park	5.0	4.3	5.1	4.5	3.9	5.2	4.3	4.0	3.3	3.2	3.5	3.5
Ujście Warty National Park	1.4	1.6	1.6	1.5	0.8	1.5	4.3	4.0	3.0	3.1	2.6	2.1
Słowiński National Park	2.5	1.9	1.9	2.7	2.2	2.2	2.2	2.1	2.0	2.1	2.0	1.9
Kampinoski National Park	2.8	2.8	2.8	1.8	1.8	1.8	1.8	1.8	1.8	1.8	1.8	1.8
Babia Góra National Park	1.5	1.2	1.0	1.3	1.0	1.4	1.1	1.5	1.4	1.5	2.3	1.5
Bieszczady National Park	1.0	1.4	1.1	1.4	2.0	0.7	0.6	0.7	0.8	0.8	1.0	1.1
Gorce National Park	0.5	0.6	0.6	0.5	0.4	0.4	0.5	0.5	0.5	0.5	0.5	0.5
Magura National Park	0.6	0.6	0.6	0.6	0.5	0.5	0.5	0.5	0.4	0.4	0.5	0.5
Wigry National Park	0.5	0.5	0.5	0.5	0.4	0.4	0.4	0.4	0.4	0.4	0.5	0.5
Polesie National Park	0.5	0.2	0.2	0.3	0.2	0.2	0.2	0.2	0.2	0.4	0.4	0.4
Narew National Park	0.1	0.1	0.1	0.2	0.2	0.2	0.2	0.3	0.3	0.3	0.4	0.4
Bory Tucholskie National Park	0.6	0.6	0.8	0.8	0.8	0.8	0.7	0.4	0.4	0.4	0.4	0.3
Biebrza National Park	0.1	0.1	0.1	0.1	0.1	0.1	0.1	0.1	0.1	0.1	0.1	0.1
Drawa National Park	0.2	0.1	0.2	0.1	0.1	0.3	0.2	0.1	0.1	0.1	0.1	0.1

Source: own elaboration based on Statistics Poland [108].

4.2. Primary Research

The research conducted in national parks indicates that park management is carried out in a conscious and responsible manner, with full respect for sustainable development principles. The directors of all the studied parks issued ordinances specifically regulating the way and scope of making the park available, as well as visitor limits, and seven parks had a conservation plan. In all parks, sightseeing was allowed on marked tourist trails, educational or walking paths, public roads, and other accessible areas. Everywhere, educational activity was carried out and educational pathways were established. In addition, regulations were developed concerning the specific way of making the park available.

4.2.1. Science and Documentation

A very important document for the proper operation and management of a park is the conservation plan. In accordance with Article 18 Item 2 of the act on nature conservation [102], a conservation plan for a national park should be created within five years after the park's establishment. Unfortunately, only seven parks have such a plan. Some of them have submitted drafts of the conservation plans to the Minister, while others are in the process of inventorying the natural resources and developing surveys. They are currently working on conservation tasks. In order to limit the negative effects of tourist traffic in national parks, the lists of restrictions to be observed by visitors are indicated. Moreover, park directors issue ordinances through which they shape the individual policy of making

the national park available. The ordinances determine, among others, the number of people who can stay in a given place at the same time or the amount of admission fees. In all parks, sightseeing was allowed on marked tourist trails, educational or walking paths, public roads, and other accessible areas. In addition, regulations were developed concerning the specific way of making the park available and use of particular places and facilities of the park.

In all parks, a scientific council was established, whose tasks included assessing the state of resources, formations, and components of nature, providing opinions on conservation plan and conservation task projects, assessing the conservation plan implementation, and providing opinions on research and scientific programmes in the field of nature conservation.

4.2.2. Tourist Issues

All the investigated parks promote environmentally friendly forms of tourist activity. The sites that may be made available and the maximum number of people who may simultaneously stay at these sites were defined in the conservation plan or, in the case of some parks, until the plan was developed, in the conservation tasks. Making a national park accessible is associated with ensuring safety for nature and visitors; therefore, visitor limits are introduced. The number of people visiting the park is usually estimated by the park employees on the basis of the number of sold tickets, maps, and publications about the park, by direct counting tourists crossing the park entrances, as well as with electronic sensors for monitoring tourist traffic.

In 21 parks, tourist traffic was monitored, the impact of tourism on the park nature condition was analysed and assessed, and, if necessary, measures were taken to minimize the traffic. All parks modernized their tourist infrastructure. However, not all parks introduced visitor limits, and the directors claimed that the traffic should not be restricted but educational activities should be undertaken to raise the culture of sightseeing. Camping was only allowed in 10 parks. In order to protect the most valuable resources from excessive tourist traffic, the trails were led in a way that avoided these places. Entry fees were collected in 16 parks. To reduce the impact of tourism on the environment, channelling and zoning principles were introduced, which mean that tourists can only move along established trails and stay in selected places. The zoning principle denotes the adjustment of tourist traffic intensity to the natural value of the area.

4.2.3. Educational Issues

As indicated in Article 8b Item 1 Points 2 and 3 of the act on nature conservation [102], making the park accessible and conducting activities related to nature education are among the tasks of national parks. These should be carried out in accordance with the rules set out in the conservation plan, conservation tasks, and the ordinances of the national park director, and only in a way that will not adversely affect the nature of the park (Article 12 Item 1). National park tasks also involve providing information on and promoting nature conservation, including running a nature museum, information and education centres, and publishing information and promotion materials. All parks implemented ecological education, established educational pathways, and cooperated with local government units. Educational activities were conducted in the form of field lessons, workshops, and lectures. The basic objectives of education were to shape appropriate attitudes to nature in children, youth, and all park visitors, to broaden the knowledge related to nature conservation, and to familiarize people with the principles of park accessibility.

4.2.4. Environmental Threats

The research carried out and the provisions included in the conservation tasks established by the Minister of Environment indicate that certain aspects of tourism in the parks have been identified as factors threatening or potentially threatening the parks' nature. However, in general, tourism itself is not a threat if it is well managed and when counter-measures are taken. The parks analyse the environmental impact of tourism in various ways. They implement projects, perform research, monitor

changes in the natural environment. Students and academics often conduct research as part of their master theses and scientific articles. On the basis of the analyses of threats related to the anthropogenic impact on the environment, water erosion, as well as the distribution and intensity of tourist traffic, the limits of people who can stay in a given place at a given time are defined. The conducted analyses of the impact of tourist traffic on the parks' nature often result in excluding routes from tourist traffic because of trampling plants by tourists.

Among the various types of research on the flora and fauna of the parks, the most common are the following:

- Soil condition monitoring;
- Monitoring the condition, quantity, and quality of surface water and groundwater;
- Meteorological monitoring;
- Monitoring at selected water stations;
- Monitoring of selected species or groups of plants and animals.

The analysis of the obtained results reveals the highest conformity in all investigated national parks in the following areas: creating regulations on making the park accessible, the presence of the park scientific council, undertaking promotion activities in the field of friendly forms of tourist activity, the modernization of the existing tourist infrastructure, ecological education, introducing educational pathways, cooperation with local government units, monitoring the impact of tourism on the environment, and assessing the impact of tourism on the environment.

All these issues have been identified as crucial in the implementation of strategic objectives for the conservation and development of parks (AI = 1.0) (Table 5).

The lowest AI was obtained in the field of natural environment conservation plan development (AI = 0.30) and tourism as a potential threat to parks' nature (AI = 0.39). The designation of camping areas was also rarely considered (AI = 0.43).

The division of the investigated parks into those that were UNESCO biosphere reserves and those that were not classified in this category allowed us to state that UNESCO biosphere reserves more often charged entrance fees (Δ AI = 0.32), more often developed natural environment conservation plans (Δ AI = 0.23), and more often considered tourism as an existing or potential threat for park nature (Δ AI = 0.27). Managers of UNESCO biosphere reserves less frequently introduced tourist traffic limits (Δ AI = -0.13) and less frequently designated camping areas (Δ AI = -0.17).

The differences observed in terms of the division of the investigated parks into coast, lake district, lowland, upland, and mountain ones revealed that nature conservation plans were more often developed in mountain parks (AI = 0.50). Similarly, revenues from admission fees were most often reported in mountain parks (AI = 0.88), and least frequently in coast parks (AI = 0.50). Camping areas were more often introduced in lake district parks (AI = 0.80), less frequently in mountain (AI = 0.38) and lowland parks (AI = 0.40). These restrictions were not applied in coast parks (AI = 0.00). Tourist traffic limits were more often noted in lake district (AI = 0.80) and upland parks (AI = 0.67) than in mountain parks (AI = 0.38). No tourist traffic limits were reported in coast parks (AI = 0.0).

Table 5. Acceptance index: research results.

Acceptance Index	Total	UNESCO Biosphere Reserve		Park Type				
		Yes	No	Coast	Lake District	Lowland	Upland	Mountain
1. Natural environment conservation plan	0.30	0.44	0.21	0.00	0.20	0.20	0.33	0.50
2. Regulations on making the park accessible	1.00	1.00	1.00	1.00	1.00	1.00	1.00	1.00
3. Scientific council	1.00	1.00	1.00	1.00	1.00	1.00	1.00	1.00
4. Promoting friendly forms of tourist activity	1.00	1.00	1.00	1.00	1.00	1.00	1.00	1.00
5. Tourist traffic limits	0.52	0.44	0.57	0.00	0.80	0.60	0.67	0.38
6. Restrictions on tourism development in areas under impact	0.65	0.67	0.64	0.50	0.60	0.80	0.67	0.63
7. Designated camping areas	0.43	0.33	0.50	0.00	0.80	0.40	0.33	0.38
8. Tourist traffic monitoring	0.91	0.89	0.93	1.00	1.00	0.80	0.67	1.00
9. Modernization of the existing tourist infrastructure	1.00	1.00	1.00	1.00	1.00	1.00	1.00	1.00
10. Revenues from admission fees	0.70	0.89	0.57	0.50	0.60	0.60	0.67	0.88
11. Ecological education	1.00	1.00	1.00	1.00	1.00	1.00	1.00	1.00
12. Educational pathways	1.00	1.00	1.00	1.00	1.00	1.00	1.00	1.00
13. Cooperation with local government units	1.00	1.00	1.00	1.00	1.00	1.00	1.00	1.00
14. Tourism as an existing or potential threat	0.39	0.56	0.29	0.00	0.40	0.00	0.67	0.63
15. Indicators for sustainable tourism planning	0.65	0.67	0.64	0.50	0.80	0.80	0.33	0.63
16. Monitoring the impact of tourism on the environment	1.00	1.00	1.00	1.00	1.00	1.00	1.00	1.00
17. Assessing the impact of tourism on the environment	1.00	1.00	1.00	1.00	1.00	1.00	1.00	1.00

Source: own elaboration.

5. Model of Environmental Management System

The study results allow us to create a model system of managing the natural environment in the park. It includes diagnosis, planning, responsibility allocation, documentation, monitoring, and measurement. Such management addresses environmental concerns. The system is a set of tools that allow us to apply environmental policy, which leads to minimizing the harmful impact on the environment in a way that is beneficial to both tourists and the environment (Figure 3).

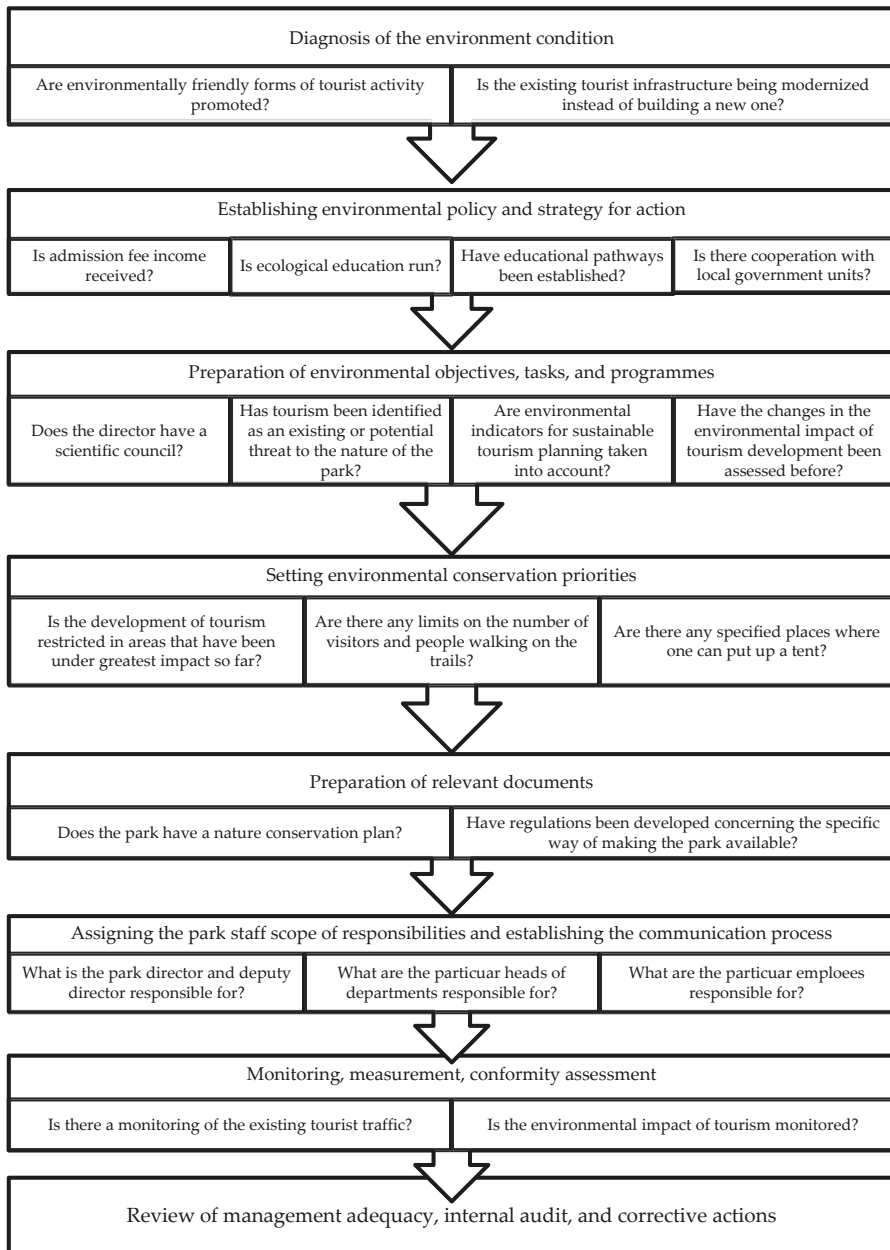

Figure 3. Model system of managing the natural environment in a national park; (source: own elaboration).

The model proposed by the authors consists of seven main parts:

1. The diagnosis of the environment condition. The most important issue is to diagnose the condition of the environment, i.e., to determine the environmental impact of any element that may threaten it. It is necessary to identify the environmental problems. This should be performed by means

of appropriate tools, such as questionnaire surveys, in-depth interviews, direct inspections and measurements, and random checks.

2. Establishing environmental policy and a strategy for action. The next step is to establish an appropriate policy, i.e., all intentions and ways of operating with regard to environmental activities. Environmental policy provides a framework for action and setting environmental objectives and tasks.
3. The preparation of environmental objectives, tasks, and programmes. The environmental objective should be measurable and consistent with the environmental policy. In turn, environmental tasks are detailed requirements for activity effects, resulting from the environmental objectives. Environmental objectives may, for example, include commitments to minimize all significant negative environmental impacts or to promote environmental awareness among young people and the local community.
4. Setting environmental conservation priorities. These are actions aimed at identifying priorities for action and quickly minimizing negative environmental impacts. They consist of managing key processes in the park related to important environmental aspects.
5. The preparation of relevant documents. The documentation should include environmental policy, objectives and tasks, the responsibilities and duties of employees, information on environmental aspects, records of monitoring the effects of environmental conservation activities, and the organization of training courses.
6. Assigning the park staff scope of responsibilities and establishing the communication process. This denotes indicating the park employees' tasks for which they will be responsible. The responsibilities may include, among others, the implementation, maintenance, and improvement of environmental conservation measures, coordination of teamwork, supervision of the identification and assessment of environmental aspects, ensuring monitoring, ensuring compliance with legal requirements, ensuring continuous improvement.
7. Monitoring, measurement, and conformity assessment. Inconsistencies may relate to the failure to meet the legal provisions on environmental conservation, deviations from environmental policy, and related environmental objectives and tasks, failure to meet the adopted criteria for particular activities and processes as revealed in the course of monitoring.

6. Discussion on the New Paradigm of National Park Management

National parks are characterized by high natural values, which make them attractive areas of tourist use. Therefore, the question is whether sustainable natural environment management can be carried out in national parks. Examples should be sought in similar environmentally valuable areas not only in Europe, but also in the world. Out of the 220 national parks in Europe, almost half are mountain parks; they are most numerous in the Scandinavian Mountains and the Carpathians. The tourist traffic in European mountain national parks is highly diversified; in Scandinavian parks, it is small, in contrast to Alpine parks where, owing to good transport accessibility and tourist infrastructure, visitors are numerous. The results obtained by the authors are in line with many foreign studies related to similar issues, although in other areas. The impact of human activity on our natural environment is remarkable. The environmental threats analysed by the authors are monitored in many countries. These problems were specifically referred to by Chemini and Rizzoli [24]. They conducted their research in the Alps; they pointed out that a large part of these mountains biodiversity was linked to the interaction between the natural environment and traditional human activity. Today, land-use transformations and other environmental and socio-economic processes, such as urbanization, tourism, or pollution, are significant forces for environmental change. The researchers indicated that mowing and the grazing of livestock were major factors inhibiting tree succession in many regions of the Alps. In turn, abandoning mountain fields and meadows causes the expansion of shrubs and forests and reduces the number of grass species. The environmental threats also result from the urbanization of the areas around the parks. Elmi and Perlik [65] performed research in the Alps too. They decided to investigate

the reappearance of residents in the mountainous parts of the Alps. They asked whether this influx was more than just a selective development of urban areas, and whether this could also be confirmed for peripheral areas. They also sought answers to the question about the driving forces behind this migration. The explanations are complex, as they need the consideration of the relationships between the permanent population and second home owners. On the basis of empirical data collected at the municipality level in five different provinces in the eastern Alps, the mentioned authors implied that the consistent settlement of new residents was only selective. This trend is focused on areas that can count on good transport accessibility, located mainly in urban and suburban municipalities. Similarly, Barker [47] raised the important issue of mass tourism expansion in various mountain regions of the world. He pointed at ski resorts and the emerging conflicts between environmental conservation and the desire to expand the resorts. In the USA, the effects were stronger than in Europe, where successful investments in tourism do not currently burden the landscape so much. The author investigated mass tourism, and the findings indicate solutions valuable for other mountain regions.

The presented paper is focused on tourism issues. The respondents indicated benefits and threats for the park resulting from tourism. They also highlighted investments in infrastructure and security. The advantages of natural resources for tourism were also studied by Gios et al. [111]. They specified that, in several Alpine regions, the transition to a tourism economy was due to major capital investment. However, the management of an environmentally valuable area does not allow for a high level of investment in hotels or guesthouses that would guarantee income from the use of natural resources; the only possible tourism is one compatible with maintaining high-quality natural environments. Unfortunately, this type of tourism has few benefits for local communities. In fact, tourists only degrade the land and infrastructure on which tourism itself is based. Car traffic damages unpaved roads, mountain bikes destroy paths and meadows, and infrastructure maintenance becomes a burden on the local community. Therefore, researchers are asking how to manage such an area, indicating that it is not an easy duty. However, an opportunity should be seen in the development of projects based on European Union programmes. A solution can also be to impose admission fees for visitors. At present, this seems impractical, even if it could be implemented in the future. In addition to the technical difficulties involved in collecting entrance fees, the sensitivity of tourists does not yet seem mature enough to accept payment. Another solution could be to create a network of lightweight infrastructure that would enable rational use of natural resources and attract tourists, and thus create jobs in the vicinity. Moreover, Gios et al. [111] pointed at interesting solutions for sustainable tourism that are possible to apply in Polish national parks. They also confirmed that a high level of investment in hotels or guesthouses, similar to in Poland, was not possible in such valuable natural areas. A similar subject was raised in relation to the German Alps by Paunović and Jovanović [62]. Their research focused on threats to sustainable development, tourism, as well as cross-border cooperation and stakeholder involvement. The findings imply that only a comprehensive approach to disseminating knowledge about sustainable development can be the basis for mountain tourism development. The implementation should focus on specific sustainable tourism flagship products. Cross-border cooperation and stakeholder involvement turned out to be crucial.

An important issue is the management process in the development of a tourist centre. The authors of the present study devoted a lot of attention to this matter. A similar subject was referred to by Bonzanigo et al. [112]. Their article presents the development and application of a management process for the local development of an Alpine tourist resort. The researchers pointed out that an efficient combination of modelling, decision making, and participatory processes could significantly improve decisions regarding sustainable development. They showed that such a combination of methods and tools allowed to manage the involvement of local actors and stimulate local debates on adaptation to climate changes and possible consequences for winter tourism. They also recommended encouraging creativity and mitigating potential conflicts. This contributed to the development of alternative sustainable tourism planning strategies. Moreover, various management methods are indicated that can be used in Polish national parks.

The aim of the article was to create a universal model of national park management, to develop a sustainable way of reconciling the increasing tourist traffic and nature conservation. A similar challenge was taken up by Coban and Yildiz [113]. The proposed model aims to make Cappadocia tourism more sustainable and competitive. The researchers implied that destination management organizations increased cooperation and coordination among stakeholders and contributed to the destination competitiveness. The authors interviewed stakeholders to identify problems in Cappadocia tourism and to suggest solutions. The main challenges were related to infrastructure, accessibility, human resources, sustainable development, and the environment. A well-prepared management system can help the region become more competitive, at the same time minimizing current problems. Cooperation and coordination were identified as key functions owing to the presence of several tourism management institutions in Cappadocia. The research provides a powerful input in the debate on a model approach to sustainable and competitive tourism. Directors of Polish national parks can take advantage of the recommendations presented in the study.

7. Conclusions and Recommendations

Managing the use, conservation, and formation of the natural environment is a very complex process. The principal objective is to ensure conservation and gain certainty that resources will remain available for future generations, as well as to improve the adverse effects of human activity and the overall state of the natural environment.

The purpose of the paper was to attempt to present a model of natural environment management in national parks in Poland in the context of increased tourist traffic. The assumed goal was achieved owing to in-depth interviews with the management staff of the parks. Their indications allowed us to create a comprehensive system of both nature conservation and making nature available to tourists.

Three issues are particularly important from the point of view of a national park activity. The first one is the competence of the management bodies, as they have the best knowledge of the problems occurring in the park and should be able to directly influence them. The second issue is the legal obligation of parks to provide environmental education, so important in the modern world. The third issue is a good environmental management system, essential for sustainable management. The obtained results can be grouped into the following three categories:

1. Administrative and management bodies In order for the activities to have an impact on the park area, a carefully developed conservation plan should be developed. The research indicates that only seven parks actually had such a plan; some have submitted draft conservation plans to the Minister, while others were in the process of inventorying the natural resources and developing surveys. Its correctness requires research monitoring the state of the environment, the size and trends of the tourist traffic, and tourists' impact on the environment. An important condition for a more effective tourism management in parks is to increase the competences of the administering bodies and the knowledge regarding individual responsibilities. Boards should be able to analyse, evaluate, and modify not only conservation plans, but also spatial development plans, municipality development strategies, and projects for investments planned within the parks. The sustainable development of tourism in parks is not possible without the involvement of local communities and their taking real advantages of tourism. From this point of view, the most favourable is the development of agritourism, which provides employment for the residents; therefore, cooperation with local governments plays a significant role.
2. Education The research reveals that all parks implemented ecological education, established educational pathways, and cooperated with local government units. These actions, however, are insufficient. More attention should be paid to education and the promotion of ecological behaviour among tourists and local communities. This is due to the diversified level of their culture and identification with the park area, which depends on the history of development and traditions of these communities. A widespread lack of awareness of the negative impact of human activity on the environment usually leads to the degradation of natural and landscape

values, which determine the attractiveness of the area. Economic instruments have the greatest contribution to the effective management of environmental resources, as they can influence or force reasonable actions for the natural environment.

3. Management system The research results obtained in Polish national parks indicate that their management is carried out in a non-accidental and reliable manner in relation to sustainable development principles. It was revealed that certain aspects of tourism in the parks were considered to be factors threatening or potentially threatening the nature of the park. However, in general, tourism itself is not a threat if it is well managed and if preventive measures are taken. The directors of the investigated parks try to include selected elements of the proposed model in the management process. However, only their comprehensive application can bring success. The proposed model of the system of natural environment management in a park may be implemented as a good practice in other state parks around the world. The modern management of the natural environment in such valuable areas as national parks can reconcile two very difficult issues, namely nature conservation and its simultaneous availability to tourists. In a national park, natural resources, i.e., ecosystems and their appropriate conservation, are always in the front line; however, wisely conducted tourism does not have to produce negative effects. In the future, the proposed concept of the park management system may also find wide application in other institutions and companies that prioritize environmental conservation.

The model proposed by the authors has been verified in state-run national parks and is addressed to them. Unfortunately, in private national parks, the model would have to be modified and adjusted to the needs of the park owner. Among the first owners of private national parks are Douglas Tompkins, Ted Turner, and Roxanne Quimby. Creating their policy of managing national parks, they have become leaders in the struggle to save the Earth for future generations.

Author Contributions: P.O. prepared the following elements of the article: the methodology, conclusions; S.P. prepared the following elements of the article: the methodology, conduct of research, developed the final contents of the article and proofread and revised it. J.M.-P. prepared the following elements of the article: the methodology, introduction, review of the literature. A.R.S. prepared the following elements of the article: the methodology, introduction and conclusions, conduct of research, calculations. S.J.—review and editing, data correction. All authors have read and agreed to the published version of the manuscript.

Funding: This research received funding by the National Science Center in Poland. The funders had no role in the design of the study; in the collection, analyses, or interpretation of data; in the writing of the manuscript, or in the decision to publish the results.

Acknowledgments: This paper was published as part of the research project ‘A business model for health resort enterprises’ No. 2017/25/B/HS4/00301, supervised and financed by the National Science Center in Poland and as part of statutory research No. BK-235/RÓZ-1/2020 (13/010/BK_20/0042) at the Silesian University of Technology, Faculty of Organization and Management.

Conflicts of Interest: The authors declare no conflict of interest.

References

1. Burchard-Dziubińska, M.; Rzeńca, A.; Drzazga, D. *Zrównoważony Rozwój: Naturalny Wybór*; Wydawnictwo Uniwersytetu Łódzkiego: Łódź, Poland, 2014.
2. Michalski, E. *Zarządzanie Przedsiębiorstwem: Podręcznik Akademicki*; Wydawnictwo Naukowe PWN: Warsaw, Poland, 2013.
3. Wei, Y.; He, S.; Li, G.; Chen, X.; Shi, L.; Lei, G.; Su, Y. Identifying nature–community nexuses for sustainably managing social and ecological systems: A case study of the Qianjiangyuan National Park pilot area. *Sustainability* **2019**, *11*, 6182. [[CrossRef](#)]
4. Luque-Martínez, T.; Faraoni, N.; Doña-Toledo, L. Auditing the marketing and social media communication of natural protected areas. How marketing can contribute to the sustainability of tourism. *Sustainability* **2019**, *11*, 4014. [[CrossRef](#)]
5. Deng, J.; Li, J. Segmentation of nature-based tourists in a rural area (2008–2009): A single-item approach. *Sustainability* **2019**, *11*, 2052. [[CrossRef](#)]

6. Myga-Piatek, U.; Jankowski, G. Wpływ turystyki na środowisko przyrodnicze i krajobraz kulturowy—Analiza wybranych przykładów obszarów górskich. *Probl. Ecol. Krajobr.* **2009**, *25*, 27–38.
7. Krupa, J. Działania proekologiczne w turystyce szansą na jej zrównoważony rozwój. *Zesz. Nauk. Tur. Rekr.* **2014**, *1*, 5–23.
8. Mizgajski, A. Zarządzanie środowiskiem i jego pozycja w badaniach geograficznych. *Przegl. Geogr.* **2008**, *80*, 23–37.
9. Ackerman, E. Where is a research frontier? *Ann. Assoc. Am. Geogr.* **1963**, *53*, 429–440. [[CrossRef](#)]
10. Hagerstrand, T. Geografia i badania zależności pomiędzy naturą a społeczeństwem. *Przegl. Zagr. Lit. Geogr.* **1979**, *4*, 35–46.
11. Bartkowski, T. *Zastosowania Geografii Fizycznej*; PWN: Warsaw, Poland, 1986.
12. Barbag, J. Przedmiot i zadania geografii regionalnej. *Przegl. Geogr.* **1959**, *31*, 495–515.
13. Zube, E.H. Local and extra-local perceptions of national parks and protected areas. *Landsc. Urban Plan.* **1986**, *13*, 11–17. [[CrossRef](#)]
14. Zube, E.H.; Busch, M.L. Park—People relationship: An international review. *Landsc. Urban Plan.* **1990**, *19*, 117–131. [[CrossRef](#)]
15. West, P.C.; Brechin, S.R. (Eds.) *Resident Peoples and National Parks: Social Dilemmas and Strategies in International Conservation*; University of Arizona Press: Tucson, AZ, USA, 1991.
16. Beltran, J. (Ed.) *Indigenous and Traditional Peoples and Protected Areas: Principles, Guidelines and Case Studies*; Best Practice Protected Areas Guidelines Series, No 4; WWF/IUCN: Gland, Switzerland, 2000.
17. Macgill, S.M. Environmental questions and human geography. *Int. Soc. Sci. J.* **1986**, *38*, 357–375.
18. Kantowicz, E.; Skotnicki, M. Główne problemy i tendencje w geografii regionalnej. In *Podstawowe Problemy Metodologiczne Polskiej Geografii*; Chojnicki, Z., Ed.; Wydawnictwo Naukowe UAM: Poznan, Poland, 1991; pp. 229–243.
19. Dumanowski, B. Geografia regionalna jako dyscyplina badawcza. *Przegl. Geogr.* **1981**, *53*, 87–94.
20. Kostrzewski, A. (Ed.) *Geografia Regionalna Jako Przedmiot Badań i Nauczania*; Bogucki Wydawnictwo Naukowe: Poznan, Poland, 2006.
21. Gocłowski, A.; Kałuski, S.; Kantowicz, E.; Walewski, A. Geografia regionalna. In *Historia Geografii Polskiej*; Jackowski, A., Liszewski, S., Richling, A., Eds.; Wydawnictwo Naukowe PWN: Warsaw, Poland, 2008; pp. 248–260.
22. Fraser, I.; Chisholm, T. Conservation or cultural heritage? Cattle grazing in the Victoria Alpine National Park. *Ecol. Econ.* **2000**, *33*, 63–75. [[CrossRef](#)]
23. West, P.; Igoe, J.; Brockington, D. Parks and peoples: The social impact of protected areas. *Ann. Rev. Anthropol.* **2006**, *35*, 251–277. [[CrossRef](#)]
24. Chemini, C.; Rizzoli, A. Land use change and biodiversity conservation in the Alps. *J. Mt. Ecol.* **2003**, *7*, 1–7.
25. Domański, R. Metody badania zbieżności układów przestrzennych. *Przegl. Geogr.* **1969**, *41*, 79–92.
26. Walewski, A. Badanie relacji między zmiennymi o wartościach grupowanych. Propozycja metodyczna. *Pr. Stud. Geogr.* **1997**, *19*, 49–54.
27. Walewski, A. Metody badania relacji przyroda-człowiek. *Pr. Stud. Geogr.* **2004**, *34*, 75–85.
28. Walewski, A.; Kantowicz, E. The relations between man and the natural environment as the methodological basis for delimitation of regions. *Misc. Geogr.* **2010**, *14*, 295–301. [[CrossRef](#)]
29. Domański, R. Konstruowanie teorii w geografii ekonomicznej. *Przegl. Geogr.* **1967**, *1*, 85–102.
30. Domański, R. *Systemy Ekologiczno-Ekonomiczne. Modelowanie Współzależności i Rozwoju*; PAN: Warsaw, Poland, 1992.
31. Kistowski, M. *Regionalny Model Zrównoważonego Rozwoju i Ochrony Środowiska Polski a Strategie Rozwoju Województw*; Bogucki Wydawnictwo Naukowe: Gdansk/Poznan, Poland, 2003.

32. Kistowski, M. Próba typologii sytuacji konfliktowych w relacjach „zagospodarowanie przestrzenne—środowisko przyrodnicze” na obszarze parków krajobrazowych nad Zatoką Gdańską. In *Między Ochroną Przyrody a Gospodarką—Bliżej Ochrony. Konflikty Człowiek-Przyroda W Obszarach Prawnie Chronionych w Polsce*; Hibszer, A., Partyka, J., Eds.; PTG Oddział Katowicki: Sosnowiec, Poland, 2005; pp. 18–31.
33. Butler, R.W. Sustainable tourism: A state-of-the-art review. *Tour. Geogr.* **1999**, *1*, 7–25. [[CrossRef](#)]
34. Pearce, D.G. *Westland National Park: Economic Impact Study*; University of Canterbury: Christchurch, New Zealand, 1982.
35. Kerr, G.N.; Sharp, B.H.; Gough, J.D. *Economic Benefits of Mt. Cook National Park*; University of Canterbury and Lincoln College: Christchurch, New Zealand, 1986.
36. Abel, N.; Blaikie, P. Elephants, people, parks and development: The case of the Luangwa Valley, Zambia. *Environ. Manag.* **1986**, *10*, 735–754. [[CrossRef](#)]
37. Clough, P.W.J.; Meister, A.D. *Benefit Assessment of Recreation Land: The Whakapapa Area, Tongariro National Park*; Massey University: Palmerston North, New Zealand, 1989.
38. Trakolis, D. Local people’s perceptions of planning and management issues in Prespes Lakes National Park, Greece. *J. Environ. Manag.* **2001**, *61*, 227–241. [[CrossRef](#)] [[PubMed](#)]
39. Ferraro, P.J. The local costs of establishing protected areas in low-income nations: Ranomafana National Park, Madagascar. *Ecol. Econ.* **2002**, *43*, 261–275. [[CrossRef](#)]
40. Cihar, M.; Stankova, J. Attitudes of stakeholders towards the Podyji/Thaya River Basin National Park in the Czech Republic. *J. Environ. Manag.* **2006**, *81*, 273–285. [[CrossRef](#)] [[PubMed](#)]
41. Jarvis, T.D. The Responsibility of National Parks in Rural Development. In *National Parks and Rural Development*; Machlis, G., Field, D., Eds.; Island Press: Washington, DC, USA, 2000; pp. 219–229.
42. Kideghesho, J.R.; Roskaft, E.; Kaltenborn, B.P. Factors influencing conservation attitudes of local people in western Serengeti, Tanzania. *Biodivers. Conserv.* **2007**, *16*, 2213–2230. [[CrossRef](#)]
43. Fortin, M.-J.; Gagnon, C. An assessment of social impacts of national parks on communities in Quebec, Canada. *Environ. Conserv.* **1999**, *26*, 200–211. [[CrossRef](#)]
44. Burger, T. Konflikt i współdziałanie. Świadomość ekologiczna i postawy społeczeństwa. In *Świadomość Ekologiczna i Społeczne Ruchy „Zielonych” w Polsce*; Mirowski, W., Ed.; IFiS PAN: Warsaw, Poland, 1999; pp. 35–55.
45. Królikowska, K. Między ochroną przyrody a rozwojem na obszarach górskich—konflikty i rozwiązania. *Czas. Geogr.* **2002**, *73*, 187–214.
46. Hibszer, A. *Parki Narodowe w Świadomości i Działaniach Społeczności Lokalnych*; Uniwersytet Śląski: Katowice, Poland, 2013.
47. Barker, M.L. Traditional landscape and mass tourism in the Alps. *Geogr. Rev.* **1982**, *72*, 395–415. [[CrossRef](#)]
48. Bauer, H. Local perception of Waza National Park, northern Cameroon. *Environ. Conserv.* **2003**, *30*, 175–181. [[CrossRef](#)]
49. Bojórquez-Tapia, L.A.; de la Cueva, H.; Diaz, S.; Melgarejo, D.; Alcantar, G.; Solares, M.J.; Grobet, G.; Cruz-Bello, G. Environmental conflicts and nature reserves: Redesigning Sierra San Pedro Martir National Park, Mexico. *Biol. Conserv.* **2004**, *117*, 111–126. [[CrossRef](#)]
50. Colchester, M. Conservation policy and indigenous people. *Environ. Sci. Policy* **2004**, *7*, 145–153. [[CrossRef](#)]
51. Stern, M. The power of trust: Toward a theory of local opposition to neighboring protected areas. *Soc. Nat. Resour.* **2008**, *21*, 859–875. [[CrossRef](#)]
52. Heinen, J.T. Park-people relations in Kosi Tappu Wildlife Reserve, Nepal: A socio-economic analysis. *Environ. Conserv.* **1993**, *20*, 25–34. [[CrossRef](#)]
53. Lewis, C. *Managing Conflicts in Protected Areas*; IUCN: Gland, Switzerland, 1996.
54. Odrowąż-Pieniążek, I.; Woźniak, J. Negocjacje jako strategia rozwiązywania konfliktów w sporach pomiędzy parkami narodowymi a samorządami. *Człow. Środ.* **1997**, *21*, 87–95.
55. Nepal, S.K. Linking parks and people: Nepal’s experience in resolving conflicts in parks and protected areas. *Int. J. Sust. Dev. World* **2002**, *9*, 75–90. [[CrossRef](#)]
56. Hunter, C.; Green, H. *Tourism and the Environment: A Sustainable Relationship?* Routledge: London, UK, 1995.
57. Hunter, C. Sustainable tourism as an adaptive paradigm. *Ann. Tour. Res.* **1997**, *24*, 850–867. [[CrossRef](#)]
58. Draper, D. Toward sustainable mountain communities: Balancing tourism development and environmental protection in Banff and Banff National Park, Canada. *Ambio* **2000**, *29*, 408–415. [[CrossRef](#)]

59. Sharpley, R. Tourism and sustainable development: Exploring the theoretical divide. *J. Sustain. Tour.* **2000**, *8*, 1–19. [[CrossRef](#)]
60. Saarinen, J. Traditions of sustainability in tourism studies. *Ann. Tour. Res.* **2006**, *33*, 1121–1140. [[CrossRef](#)]
61. Hunter, C. Sustainable tourism and the touristic ecological footprint. *Environ. Dev. Sustain.* **2002**, *4*, 7–20. [[CrossRef](#)]
62. Paunović, I.; Jovanović, V. Implementation of sustainable tourism in the German Alps: A case study. *Sustainability* **2017**, *9*, 226. [[CrossRef](#)]
63. Mortensen, T.L.; Leistritz, F.L.; Leitch, J.A.; Coon, R.C.; Ekstrom, B.L. Socioeconomic impact of the conservation reserve program in North Dakota. *Soc. Nat. Resour.* **1990**, *3*, 53–61. [[CrossRef](#)]
64. Mika, M. *Założenia i Determinanty Podtrzymywalności Lokalnego Rozwoju Turystyki*; Instytut Geografii i Gospodarki Przestrzennej Uniwersytetu Jagiellońskiego: Krakow, Poland, 2014.
65. Elmi, M.; Perlik, M. From tourism to multilocal residence? Unequal transformation processes in the Dolomites area. *J. Alp. Res.* **2014**, *102*. [[CrossRef](#)]
66. Pawlaczyk, P. Modele oddziaływań człowiek-przyroda jako podstawa określenia pojemności turystycznej parku narodowego. In *Użytkowanie Turystyczne Parków Narodowych. Ruch Turystyczny—Zagospodarowanie—Konflikty—Zagrożenia*; Partyka, J., Ed.; Instytut Ochrony Przyrody PAN, Ojcowski Park Narodowy: Ojców, Poland, 2002; pp. 23–36.
67. Wnuk, Z.; Ziaja, M. (Eds.) *Turystyka w Obszarach Natura 2000*; Uniwersytet Rzeszowski: Rzeszów, Poland, 2007.
68. Liszewski, S. Przestrzeń turystyczna parków narodowych w Polsce. In *Gospodarka i Przestrzeń*; Domański, B., Kurek, W., Eds.; Instytut Geografii i Gospodarki Przestrzennej UJ: Krakow, Poland, 2009; pp. 187–201.
69. Zajadacz, A. Koncepcja rozwoju rozwoju turystyki. In *Uwarunkowania i Plany Rozwoju Turystyki. Walory i Atrakcje Turystyczne. Potencjał Turystyczny. Plany Rozwoju Turystyki*; Seria Turystyka i Rekreacja—Studia i Prace; Naukowe UAM, Ed.; Adam Mickiewicz University: Poznań, Poland, 2009; Volume 3, pp. 93–130.
70. Butler, R.W. The concept of a tourist area cycle of evolution: Implications for management of resources. *Can. Geogr.* **1980**, *24*, 5–12. [[CrossRef](#)]
71. Brechin, S.R.; West, P.C.; Harmon, D.; Kutay, K. Resident Peoples and Protected Areas: A Framework for Inquiry. In *Resident Peoples and National Parks: Social Dilemmas and Strategies in International Conservation*; West, P.C., Brechin, S.R., Eds.; University of Arizona Press: Tucson, AZ, USA, 1991; pp. 5–30.
72. Eagles, P.; McCool, S.F. *Tourism in National Parks and Protected Areas: Planning and Management*; CABI: New York, NY, USA, 2002.
73. Pytel, S. Atrakcyjność turystyczna miejsc migracji seniorów z województwa śląskiego. *Ekon. Probl. Tur.* **2014**, *1*, 327–340.
74. Markiewicz-Patkowska, J.; Pytel, S.; Widawski, K.; Oleśniewicz, P. Turystyka senioralna w kontekście sytuacji materialnej polskich emerytów. *Ekon. Probl. Tur.* **2018**, *2*, 99–106.
75. Pytel, S.; Rahmonov, O. Migration processes and the underlying reasons: A study on pensioner migrants in Poland. *Popul. Space Place* **2019**, *25*, e2197. [[CrossRef](#)]
76. Stoll-Kleemann, S. Reconciling opposition to protected areas management in Europe: The German experience. *Environ. Sci. Policy Sust. Dev.* **2001**, *43*, 32–44. [[CrossRef](#)]
77. Kaltenborn, B.P.; Nyahongo, J.W.; Kidegesho, J.R.; Haaland, H. Serengeti National Park and its neighbours—Do they interact? *J. Nat. Conserv.* **2008**, *16*, 96–108. [[CrossRef](#)]
78. Von Ruskowski, E. Causes and Potential Solutions for Conflicts Between Protected Area Management and Local People in Germany. In *Rethinking Protected Areas in a Changing World: Proceedings of the 2009 George Wright Society Biennial Conference on Parks, Protected Areas, and Cultural Sites in Portland, Oregon*; Weber, S., Ed.; George Wright Society: Hancock, MI, USA, 2010; pp. 200–244.
79. Raval, S.R. Wheel of life: Perceptions and concerns of the resident peoples for Gir National Park in India. *Soc. Nat. Resour.* **1994**, *7*, 305–320. [[CrossRef](#)]
80. Fiallo, E.A.; Jacobson, S.K. Local communities and protected areas: Attitudes of rural residents towards conservation and Machalilla National Park, Ecuador. *Environ. Conserv.* **1995**, *22*, 241–249. [[CrossRef](#)]
81. Brandon, L.; Redford, K.H.; Sanderson, S.E. (Eds.) *Parks in Peril: People, Politics and Protected Areas*; Island Press: Washington, DC, USA, 1998.
82. Allendorf, T.D. A framework for the park-people relationship: Insights from protected areas in Nepal and Myanmar. *Int. J. Sust. Dev. World* **2010**, *17*, 417–422. [[CrossRef](#)]

83. Caldecott, J. *Designing Conservation Project*; Cambridge University Press: Cambridge, UK, 1995.
84. Piontek, F. *Kontrowersje i Dylematy Wokół Rozwoju Zrównoważonego i Trwałego. Ekonomia a Rozwój Zrównoważony*; Wydawnictwo Ekonomia i Środowisko: Białystok, Poland, 2001.
85. Toruński, J. Aspekty środowiskowe zrównoważonego rozwoju obszarów prawnie chronionych. *Zesz. Nauk. Akad. Podl. Siedl.* **2010**, *84*, 21–32.
86. Weaver, D.B.; Lawton, L.J. A new visitation paradigm for protected areas. *Tour. Manag.* **2017**, *60*, 140–146. [[CrossRef](#)]
87. Leung, Y.F. *Tourism and Visitor Management in Protected Areas: Guidelines for Sustainability*; Spenceley, A., Hvenegaard, G., Buckley, R., Groves, C., Eds.; IUCN: Gland, Poland, 2018.
88. Eagles, P.F.; Bowman, M.E.; Tao, C.H. *Guidelines for Tourism in Parks and Protected Areas of East Asia*; IUCN: Gland, Poland, 2001.
89. Mandić, A. Structuring challenges of sustainable tourism development in protected natural areas with driving force–pressure–state–impact–response (DPSIR) framework. *Environ. Syst. Decisions* **2020**, 1–17. [[CrossRef](#)]
90. Mandić, A.; Petrić, L. The impacts of location and attributes of protected natural areas on hotel prices: Implications for sustainable tourism development. *Environ. Dev. Sustain.* **2020**, 1–31. [[CrossRef](#)]
91. Gałązka, M. Turystyka zrównoważona w parkach narodowych w opinii turystów. *Stud. Mat. Cent. Eduk. Przyr. Leśn.* **2009**, *11*, 123–130.
92. Para, A.K. Zasady zrównoważonego rozwoju turystyki—Bariery i szanse dla branży turystycznej. *Zesz. Nauk. Tur. Rekr.* **2013**, *1*. [[CrossRef](#)]
93. McMinn, S. The challenge of sustainable tourism. *Environmentalist* **1997**, *17*, 135–141. [[CrossRef](#)]
94. Apanowicz, J. *Zarys Metodologii Prac Dyplomowych i Magisterskich z Organizacji i Zarządzania*; Wyższa Szkoła Administracji i Biznesu: Gdynia, Poland, 1997.
95. Byrd, E.T. Stakeholders in sustainable tourism development and their roles: Applying stakeholder theory to sustainable tourism development. *Tour. Rev.* **2007**, *62*, 6–13. [[CrossRef](#)]
96. Liburd, J.J.; Edwards, D. (Eds.) *Understanding the Sustainable Development of Tourism*; Goodfellow: Oxford, UK, 2010.
97. Mihalič, T. Environmental management of a tourist destination: A factor of tourism competitiveness. *Tour. Manag.* **2000**, *21*, 65–78. [[CrossRef](#)]
98. Ceron, J.P.; Dubois, G. Tourism and sustainable development indicators: The gap between theoretical demands and practical achievements. *Curr. Issues Tour.* **2003**, *6*, 54–75. [[CrossRef](#)]
99. Huete-Alcocer, N.; López-Ruiz, V.R.; Grigorescu, A. Measurement of satisfaction in sustainable tourism: A cultural heritage site in Spain. *Sustainability* **2019**, *11*, 6774. [[CrossRef](#)]
100. McCool, S.F.; Bosak, K. (Eds.) *Reframing Sustainable Tourism*; Springer: Dordrecht, The Netherlands, 2016.
101. Wasiuk, A. Rachunkowość w zarządzaniu parkiem narodowym. *Fin. Ryn. Fin. Ubezpiec.* **2016**, *80*, 207–214. [[CrossRef](#)]
102. Ustawa z Dnia 16 Kwietnia 2004 r. o Ochronie Przyrody, Dz.U. 2004 nr 92 poz. 880. Available online: <http://prawo.sejm.gov.pl/isap.nsf/download.xsp/WDU20040920880/O/D20040880.pdf> (accessed on 12 November 2019).
103. Kunasz, M. Zasoby przedsiębiorstwa w teorii ekonomii. *Gosp. Nar.* **2006**, *211*, 33–48. [[CrossRef](#)]
104. Ruśkowski, E.; Salachna, J.M. *Finanse Publiczne. Komentarz Praktyczny*; ODDK: Gdansk, Poland, 2014.
105. Government Republic of Poland. *The Act on Public Finance*; Government Republic of Poland: Warsaw, Poland, 2013.
106. Nasza Krajoznawczo Górska Przygoda. Available online: <https://www.naszakgp.pl/> (accessed on 12 November 2019).
107. Berlin Declaration. Biodiversity and Sustainable Tourism. In Proceedings of the International Conference of the Ministers of the Environment, Berlin, Germany, 6–8 March 1997.
108. Local Data Bank of Statistics Poland. Available online: www.stat.gov.pl (accessed on 12 November 2019).
109. Szromek, A.R. *Wskaźniki Funkcji Turystycznej. Koncepcja Wskaźnika Funkcji Turystycznej i Uzdrawiskowej*; Wydawnictwo Politechniki Śląskiej: Gliwice, Poland, 2012.
110. Szromek, A.R. Pomiar funkcji turystycznej obszarów za pomocą wskaźników funkcji turystycznej na przykładzie obszarów państw europejskich. *Stud. Ekon.* **2013**, *132*, 91–103.

111. Gios, G.; Goio, I.; Notaro, S.; Raffaelli, R. The value of natural resources for tourism: a case study of the Italian Alps. *Int J Tour Res* **2006**, *8*, 77–85. [[CrossRef](#)]
112. Bonzanigo, L.; Giupponi, C.; Balbi, S. Sustainable tourism planning and climate change adaptation in the Alps: A case study of winter tourism in mountain communities in the Dolomites. *J. Sustain. Tour.* **2016**, *24*, 637–652. [[CrossRef](#)]
113. Coban, G.; Yildiz, O.S. Developing a destination management model: Case of Cappadocia. *Tour. Manag. Perspect.* **2019**, *30*, 117–128. [[CrossRef](#)]



© 2020 by the authors. Licensee MDPI, Basel, Switzerland. This article is an open access article distributed under the terms and conditions of the Creative Commons Attribution (CC BY) license (<http://creativecommons.org/licenses/by/4.0/>).

Article

Carbon Footprint Evaluation Based on Tourist Consumption toward Sustainable Tourism in Japan

Yusuke Kitamura *, Yuki Ichisugi, Selim Karkour and Norihiro Itsubo

Graduate School of Environmental and Information Studies, Tokyo City University, Yokohama 224-8551, Japan; g1793102@tcu.ac.jp (Y.I.); g1893103@tcu.ac.jp (S.K.); itsubo-n@tcu.ac.jp (N.I.)

* Correspondence: g1893104@tcu.ac.jp; Tel.: +81-45-910-2930

Received: 18 February 2020; Accepted: 9 March 2020; Published: 12 March 2020

Abstract: The importance of the contribution of tourism to climate change has been noted by the United Nations World Tourism Organization (UNWTO). By combining a process-based life cycle assessment (LCA) and input–output analysis, several researchers have attempted to evaluate the impacts of the tourism industry, as well as its products and services. Indeed, the tourism sector has a wide range of industries, including travel and tours, transportation, accommodation, food and beverage, amusement, souvenirs, etc. However, the existing cases do not show a breakdown of the impact on climate change. In this paper, the carbon footprint (CFP) of the Japanese tourism industry was calculated based on tourist consumption, using the Japanese input–output table and the Japanese tourism industry. We demonstrate that the total emissions were approximately 136 million t-CO₂ per year. The contribution ratio of each stage is as follows: Transport 56.3%, Souvenirs 23.2%, Petrol (direct emissions) 16.9%, Accommodation 9.8%, Food and Beverage 7.5%, and Activities 3.0%. Then, in the breakdown, the impacts are in the following order: Air transport 24.7%, Petrol (direct emissions) 16.9%, Accommodation 9.8%, Food and Beverage 7.5%, Petrol 6.1%, Textile products 5.3%, Food items 4.9%, Confectionery 4.8%, Rail transport 3.9%, Cosmetics 1.9%, and Footwear 1.8%. In addition to transportation, this research also highlights the contribution from souvenirs, accommodation, and food and beverages.

Keywords: Life Cycle Assessment (LCA); Carbon Footprint (CFP); tourism

1. Introduction

According to the United Nations, more than three million people travel across the world every day, and approximately 1.2 billion people travel abroad every year. This includes not only personal travel, but also MICE [1] (Meetings, Incentives, Conferences, and Exhibitions,) which are international meetings (conventions) held, for example, by international organizations, academic societies, etc.

The year 2017 was designated as the “International Year of Sustainable Tourism for Development” to spread awareness of the role of tourism. One of the messages was, through contact with nature, to raise awareness of the challenges posed by the effective use of resources and the effect on climate change. Another intention was to increase awareness of global issues [2]. The United Nations World Tourism Organization (UNWTO) is still recognizing the impact of tourism on global warming as an important issue in the 21st century. UNWTO has defined sustainable tourism as “Tourism that takes full account of its current and future economic, social and environmental impacts, addressing the needs of visitors, the industry, the environment and host communities” [3,4]. The world tourism industry has also begun to implement “Tourism for SDGs”, aiming to contribute to the Sustainable Development Goals (SDGs). In the “SDG compass”, which shows the approach to the SDGs, the “life cycle assessment (LCA)” is introduced as one of the means to map the high-impact areas in the value chain in “Step 2 Determine priority issues”. Such international trends call for actions that include the concept of sustainability, not only in developing countries but also in developed countries.

In Japan, according to a survey by the Japanese Ministry of Land, Infrastructure, Transport, and Tourism (MLIT) [5], environmental efforts are one of the most important issues, regardless of the field of business. Today, in the field of tourism in Japan, there are a variety of local governments, residents, tourism industries, etc., that are making efforts to protect the environment. Establishing a cooperative system that goes beyond the initiative of a single entity has been strongly recognized as an option to tackle the issue. In addition, it has been shown that environmental conservation efforts are not only indispensable for the sustainable development of tourism but also greatly related to improving the attractiveness of tourist destinations.

According to the Japan Tourism White Paper (2017) [6], the gross domestic product (GDP) of the tourism sector, as defined by the UNWTO (2012), is approximately 8.5 trillion yen (about 78.6 billion US dollars), accounting for approximately 1.7% of the country's total GDP. Moreover, the growth rate of the tourism sector GDP is about 23%, which is higher than the growth rate for other industries. On the other hand, in a specific tourist area, a significant increase in visitors, for example, might result in a negative impact on the civic life, natural environment, landscape, etc., which could greatly reduce the level of satisfaction for travelers. Such tourism situations have become a major issue, referred to as "overtourism". The Japanese government has established the "Tourism Strategy Promotion Task Force" as part of the Japan Tourism Agency (JTA) (2018). The goal of this entity is to harmonize the increasing needs of tourists and the living condition of the residents in the tourist area. A system was developed to comprehensively examine and promote their coexistence. With these social issues in mind, the JTA is considering establishing an evaluation index for sustainable tourism in Japan.

In connection with overtourism, Martín Martín, JM et al. (2018) [7] analysed a study of the city of Barcelona (Spain) that found that citizens had a general aversion to tourism. We have determined that there is a negative economic effect due to the increase in the number of accommodations and demand for vacation rentals. The main effects are concerns about rising home rental prices and the move to higher priced tourism markets. Martín Martín, J. M. et al. (2019) [8] also point to the issue of tourism seasonality. They looked at the factors that make decisions by tourism entrepreneurs. The results show that entrepreneurs acknowledge the cost of shutting down during off-peak season. They also indicated that they placed great importance on the factors that justify closing the office for several months a year. These papers show that economic growth in the tourism sector has the potential to undermine other economies and change the style of the tourism sector.

Martínez, J.M.G. et al. (2019) [9] analysed the stability of rural tourism as a desirable condition for sustainable tourism in terms of the difference between rural tourism and urban tourism. The survey draws on major tourist attractions in Spain. The analysis concludes that the annual level of stability of rural tourism is not far from the stability of the most stable urban tourism, due to the much higher seasonality in coastal tourist destinations. Martínez, J.M.G. et al. (2020) [10] collected and analysed the individual preferences of the most representative stakeholder groups (farmers, business owners, governments, scientists). They calculated the conflict index between groups of stakeholders in this study. From here, the most favorable content to consider the target was shown. On the other hand, the most serious disagreements were found between farmers and scientists, and between farmers and governments. Thus, there are various issues concerning the sustainability of tourism, suggesting that targeting through stakeholder communication is important.

A life cycle assessment (LCA) can be an alternative solution for this situation, as it can identify the potential environmental impacts caused by the tourism sector within its different life cycle stages. From the viewpoint of LCA, there are two main methods for calculating the environmental impacts: Process-based LCA (focusing on the different processes constituting the scope of evaluation) and input-output based LCA (focusing on the monetary interaction between the different industrial sectors). Filimonau et al. (2016) [11] made a summary of the different LCA studies focusing on tourism (Appendix A, Table A1).

The process method, which is a method of examining the individual processes that make up the life cycle one by one and collecting and accumulating the environmental load data for each process, is often

targeted at specific product services such as holiday travel (including or excluding accommodation) and tourist accommodation (Appendix A, Table A1). On the other hand, the input–output method is based on the estimated consumption of energy and resources, as well as the environmental impacts of emitted substances by using an input–output table. The input–output is often targeted at evaluating industrial sectors, such as the local tourism sector and the national tourism industry.

Lenzen et al. (2018) [12] calculated the carbon footprint (CFP) of global tourism using multi-regional input–output (MRIO). The tourism industry is composed of a wide range of industries including travel, lodging, dining, amusement, souvenirs, etc., and is expected to grow at a global annual rate of 4%. The global GHG (greenhouse gas) emissions related to tourism were not well quantified until now. In this study, based on tourism-related data from 160 countries, the CFP for tourism was estimated to increase from 3.9 to 4.5 Gt CO₂eq between 2009 and 2013. This is about four times the previous estimate and accounts for about 8% of global GHG emissions. The authors commented on the high contribution of food and beverage in addition to travel and shopping.

In Japan, New Tourism Study Group of The Institute of Life Cycle Assessment, Japan (ILCAJ) has been studying the GHG emissions related to tourism since 2009 [13] to highlight their importance. In 2013, the calculation methods for tourism were examined, based on the works from Ito et al. (2011) [14], focusing on transportation, Tamari et al. (2011) [15], focusing on accommodation, and finally, Kazama et al. (2011) [16], focusing on food and beverage. In the same year, the product category rule (PCR) [17] for travel was also examined in the Carbon Footprint Communication Program (CFP Program). The bottom-up evaluation results were used for labeling, such as PCR for the CFP program and for the establishment of certification standards for Eco Mark (Type I label) [18,19].

Finally, Shimizu et al. (2015) [20] also examined 27 industrial sectors related to tourism in Japan and Korea using the input–output table approach, tourism statistics related to consumption, and various data on CO₂ emission intensities. In the future, while the production value of the tourism industry can be expected to increase, they noted that this is a possibility of increasing emissions of greenhouse gases, such as carbon dioxide (CO₂). However, for the domestic case, there is no breakdown that clarifies the degree of impact of “travel, lodging, amusement, souvenirs, etc.”, which are the key elements which compose tourism. Therefore, our study aims at clarifying this point.

In this study, we calculate the CFP for the entire Japanese tourism industry and quantitatively show the breakdown by the different categories that compose this industry (transportation, accommodation, food and beverage, souvenirs, activities, etc.).

2. Materials and Methods

2.1. Input–Output Table Approach

In this method, the evaluation is conducted retrospectively from the supply chain, so that a comprehensive evaluation is performed from the viewpoint of the life cycle of products and services. Therefore, this study uses the LCA method [21] in order to meet the objective of considering comprehensive evaluation by including the pre-tourism preparation stage and post-tourism stage, as well as the different stages occurring during travelling.

In this research, the Japanese input–output table is used. The principles of this method are based on the works from W.W. Leontief [22] and are often used in the LCA research field. The formula used in this method is

$$\text{Environmental loads} = d(I - A)^{-1}f \quad (1)$$

where d is the direct environmental impact and the environmental impact per production value. $(I - A)^{-1}$ is the Leontief inverse matrix and can be used to consider the direct and indirect economic ripple effect caused by the consumption of one type of goods. f is the amount of activity. This method helps to evaluate the entire supply chain. According to Hondo (2008) [23], it has the following advantages:

- Arbitrariness is not involved in the choice of system boundaries.

- There is a full understanding of the indirect environmental impact.
- Public statistics with excellent transparency and objectivity are used.
- It can evaluate all goods and services.

To sum up, it is possible to make an objective evaluation, and the existing limit to obtain the data for each process is overcome by using the input–output table. Therefore, the calculation following this approach was adopted in this study.

2.2. System Boundaries

As shown in Table 1, the system boundaries of this study follow the traditional approach adopted for tourism evaluation. Preparation (Pre-tourism), Inbound Tourism, Domestic Tourism, Outbound Tourism, and After (Post-tourism) are the different life stages. These cover consumptions related to movement and accommodation of tourists and the staff and participants of MICE events. However, these do not include the consumption of foreign tourists before/after travelling or items purchased by MICE organizers or the energy consumption at the venues.

Table 1. Scope of the evaluation data. The items evaluated in this study are displayed as “○”, and “N” means NOT applicable. “P” in the table is an abbreviation of preparation for travel, “W” means while traveling, and “A” means after travel.

Life cycle stage	Inbound Tourism			Domestic Tourism			Domestic Tourism			Domestic Tourism			Outbound Tourism		
	P	W	A	Overnight Stay			Day Trip			Transit			P	W	A
Travel agencies, tour operators and guide	N	○	N	N	○	N	N	○	N	N	○	N	N	○	N
Transport	N	○	N	N	○	N	N	○	N	N	○	N	N	○	N
Accommodation	N	○	N	N	○	N	N	N ²	N	N	○	N	N	○	N
Food and beverage	N	○	N	○	○	N	○	○	N	○	○	N	○	○	N
Souvenirs	N	○	N	○	○	N	○	○	N	○	○	N	○	○	N
Activities (including others ¹)	N	○	N	○	○	○	○	○	○	○	○	○	○	○	N

¹ This includes not only Cultural services, Recreation, and other entertainment services, but also other services. ² Day trips are not included for non-staying trips. ³ After is included in “for transit” of domestic tourism, “N” is set in this table.

The tourism statistics data “Internal and national tourism consumption, by timing of purchase and products” provided by the JTA [24] distinguish foreign visitors visiting Japan (referred to as inbound tourism in this study), domestic tourism, which includes also the travels within Japan of foreign visitors (e.g., flight connection), and finally Japanese nationals/Japan foreign residents overseas travel (referred to in this study as outbound tourism).

The items evaluated in this study are displayed as “○” in Table 1, and those that are not included are displayed as “Not applicable”. These data were provided by JPY (1\$ = 113 JPY (2017 Ave.)).

2.3. Calculation Method of CFP

As mentioned earlier in Section 2.1, this study calculates the CFP using the input–output approach. The calculation formula is shown below:

$$\sum_{k=1}^5 CFP_k = d_i(I - A)^{-1} f_i + DE_i \quad (i = 1, \dots, n) \tag{2}$$

where d_i is the direct GHG emission intensity provided for each sector by the Inventory Database for Environmental Analysis version 2” (IDEAv.2), as developed by the National Institute of Advanced Industrial Science and Technology (AIST). A is the direct input coefficient matrix: We used the 2011 waste input–output table (WIO) developed by Kondo et al. (2019) [25] to have a broad overview. I is an identity matrix, $(I - A)^{-1}$ is the Leontief inverse matrix, and f_i is the amount of activity obtained from the statistics of the JTA(2017), as detailed previously. It would be more effective to use data focusing

on the same year; however, the last waste input–output table available focuses only on 2011. DE_i is the direct emission from fuel combustion added to the calculation in order to cover the full cradle to grave aspects of products and services. Using this equation, the calculation was extended from cradle-to-gate to cradle-to-grave.

The tourism statistics data “Internal and National tourism consumption, by timing of purchase and products” [24], regularly surveyed by JTA, is calculated and aggregated based on Tourism Satellite Accounts (TSA). The items were aggregated to represent the total amount spent during or for travel, including amounts paid for souvenirs, for example. Here, travel is defined as “going away from the area of daily life regardless of the content of activities at destination” and is used synonymously with tourism. Business trips were included in the data; however, the organizer’s consumption/waste amount and direct environmental impact at MICE events were not included. The data are provided for 2017.

The statistical data are based on the Survey of Consumption Trends for Foreign Visitors to Japan [26] and the Survey of Travel and Tourism Consumption in Japan (Survey details and results are included in [24]).

Visitor data in the survey are foreign visitors to Japan who leave Japan, excluding transit passengers, crew members, and those staying for more than a year. The following three surveys were conducted. A national survey, which reveals the types of foreign visitors, travel content, and consumption content throughout Japan, a regional survey, which clarifies the type of foreign visitors, the content of travel, and the content of consumption for each visited place (prefecture), and a cruise survey, which clarifies the types of foreign visitors who obtained ship tourism-landing permission, as well as the content of travel and consumption. The survey was conducted with a target of approximately 140,000 votes per year, and the investigator asked foreigners visiting the departure lobby at the airport and seaport to be surveyed to cooperate. Therefore, the survey was conducted using a tablet terminal or a paper questionnaire while listening.

Domestic traveler’s data measure the number of tourism trips and tourism consumption of domestic tourism and outbound tourism in 2017 by JTA. According to the result report, the survey target is residents in Japan. It targets about 25,000 people extracted based on the basic ledger. As for the survey method, JTA distributed questionnaires to the survey subjects. The reporter (the person being surveyed) or a proxy fills out the questionnaire and returns it. It is the tourist consumption amount estimated and totaled by multiplying the number of trips by the linear estimation multiplication factor from the answer result.

As shown in Table 2, it can be seen that spending for “Accommodation services” and “Food and beverage serving services” is important, and for “Passenger transport services”, the amount of spending is higher for planes (sum of domestic and international flights) and Shinkansen (Japanese bullet train).

Table 2. The amount of consumption for items subject to evaluation. The input–output table (I/O) classification codes corresponding to each Tourism Satellite Accounts (TSA) inventory item were applied. See Appendix A, Tables A2 and A3 for details.

Category of Products and Services	Inbound Tourism	Domestic Tourism	Domestic Tourism	Domestic Tourism	Outbound Tourism	Total (B-JPY)	Rate (%)
		Overnight Stay	Day Trip	Transit			
Travel agencies, tour operators, and guides	22	225	33	159	27	466	1.6%
Transport	748	5320	2128	852	1041	10,090	33.6%
Accommodation	1077	4148	0	18	883	6125	20.4%
Food and beverage	766	2077	646	26	400	3914	13.0%
Souvenirs	1418	3587	1583	250	397	7234	24.1%
Activities	115	1151	641	128	150	2185	7.3%
Total (Billion-JPY)	4146	16,508	5031	1432	2897	30,015	100.0%
Rate (%)	13.8%	55.0%	16.8%	4.8%	9.7%	100%	-

Table 2 and Appendix A, Table A2 detail the spending (top 3) of consumable items for each travel type. In the case of inbound tourism, the largest spending is represented by accommodation and food and beverage expenses, followed by medicines and cosmetics. Domestic sightseeing (overnight stay): Accommodation, food and drinks, and Shinkansen expenses are the largest expenses. Domestic sightseeing (day trip): Eating and drinking, Shinkansen, and gasoline costs are the largest expenditures. For domestic tourism (for transit), flight expenses (international flights) are the highest spending amounts in most cases. Finally, for outbound tourism, accommodation, flight (international flights), and food and beverages are the greatest amounts.

In this article, each product/service item is associated with an input–output table (I/O) classification code. Some major items such as “Travel agencies, tour operators, and tourist guide services” do not include detailed sub-items but still correspond to I/O classification codes. See Appendix A, Table A2 for each inventory item and I/O classification correspondence.

3. Results

3.1. CFP of Tourism

The CFP was calculated as shown below (Figure 1) and was found to be 136 million t-CO₂eq. The contribution ratio of each stage is as follows: transport 56.3%, souvenirs 23.2%, petrol (direct emissions) 16.9%, accommodation 9.8%, food and beverage 7.5%, and activities 3.0%.

Then, in the breakdown, the impact was in the following order: air transport 24.7%, accommodation 9.8%, food and beverage 7.5%, petrol 6.1%, textile products 5.3%, food items 4.9%, confectionery 4.8%, rail transport 3.9%, cosmetics 1.9%, and footwear 1.8%.

Table 3 shows a summary of the top contributors of each travel type, ranking the items in GHG emissions. The top five rankings for inbound tourism are as follows: air transport, accommodation, cosmetics, food and beverage, and food items. For overnight stays of domestic tourism, they are as follows: petrol (direct emissions), air transport, accommodation, food and beverage, and petrol. For day trips of domestic tourism, they are as follows: petrol (direct emissions), petrol, food items, food and beverage, and confectionery. For transit overseas of domestic tourism, they are as follows: air transport, textile products, footwear, petrol (direct emissions), and confectionery. For outbound tourism, they are as follows: air transport, accommodation, food and beverage, textile products, and confectionery.

Table 3. A summary of the top contributors of each travel type, ranking the items in terms of GHG emissions. From the results in Figures 2–6., the top five highest contributions in each stage are displayed.

	Inbound Tourism	Domestic Tourism	Domestic Tourism	Domestic Tourism	Outbound Tourism
		Overnight Stay	Day Trip	Transit	
1	Air transport	Petrol (direct emissions)	Petrol (direct emissions)	Air transport	Air transport
2	Accommodation	Air transport	Petrol	Textile products	Accommodation
3	Cosmetics	Accommodation	Food items	Footwear	Food and beverage
4	Food and beverage	Food and beverage	Food and beverage	Petrol (direct emissions)	Textile products
5	Food items	Petrol	Confectionery	Confectionery	Confectionery

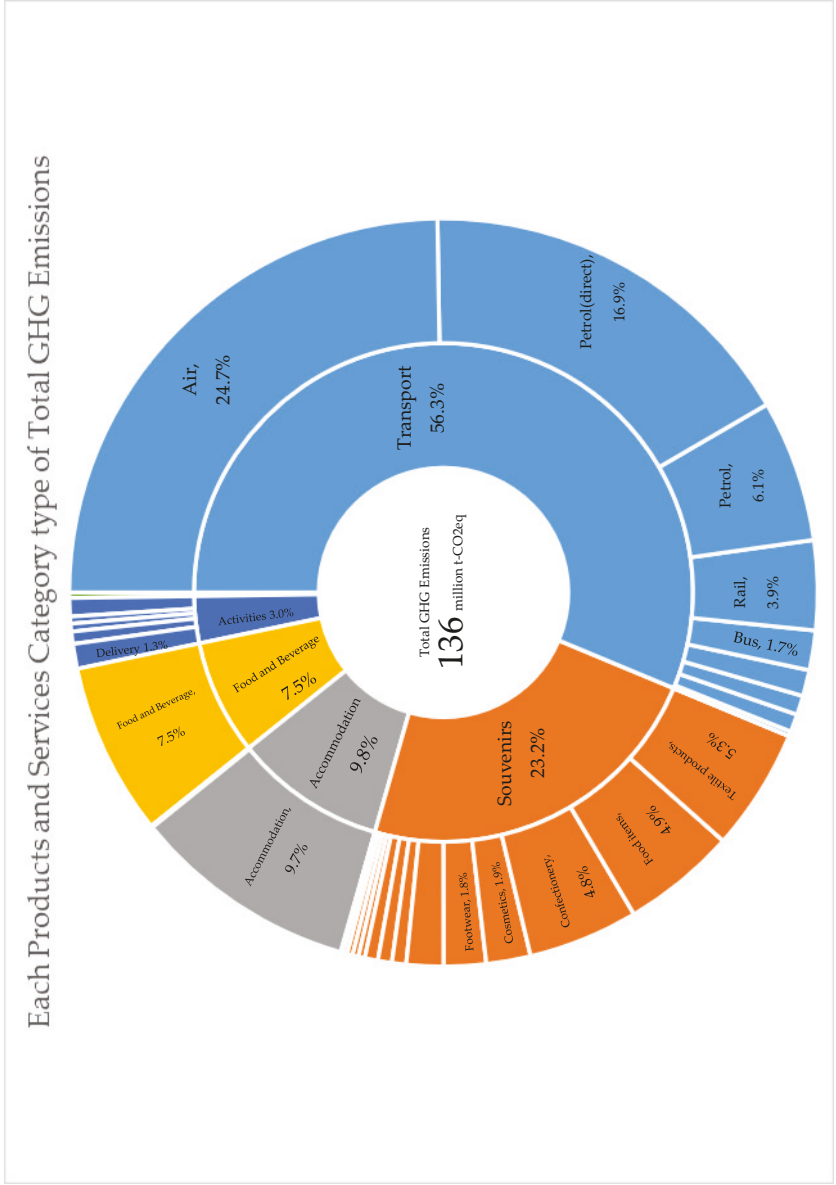

Figure 1. Breakdown of the carbon footprint (CFP) by each life cycle stage. The above figure shows the greenhouse gas (GHG) emissions and shows the contribution of the impact in each life stage. Table A4 shows the CFP calculation results for the items of each product service.

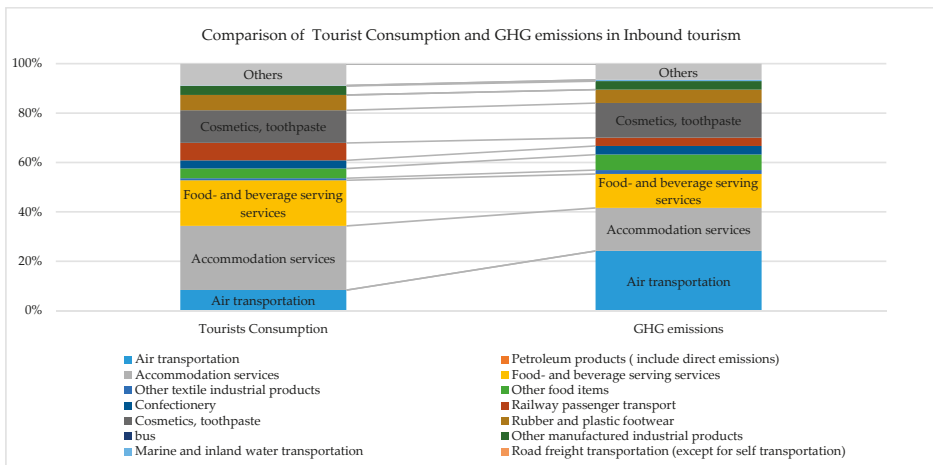

Figure 2. Comparison of traveler’s consumption and the GHG emissions of inbound tourism.

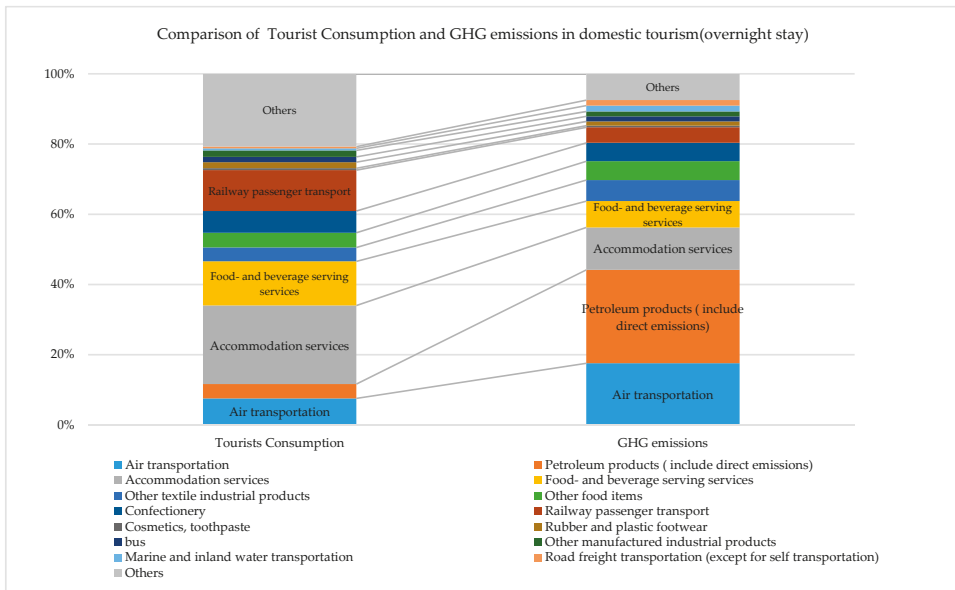

Figure 3. Comparison of traveler’s consumption and the GHG emissions of domestic tourism (overnight stay).

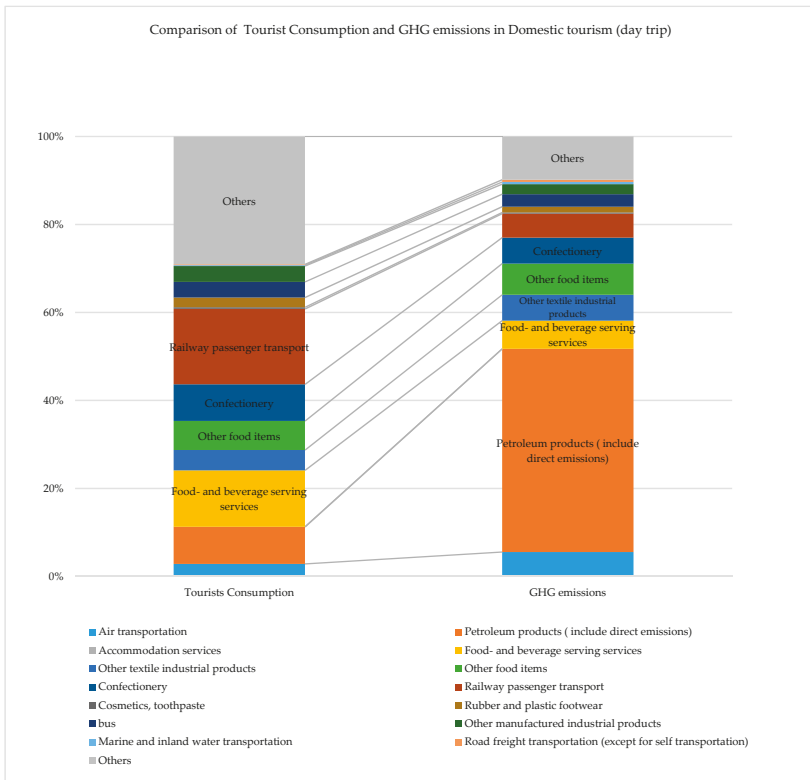

Figure 4. Comparison of traveler’s consumption and the GHG emissions of domestic tourism (day trip).

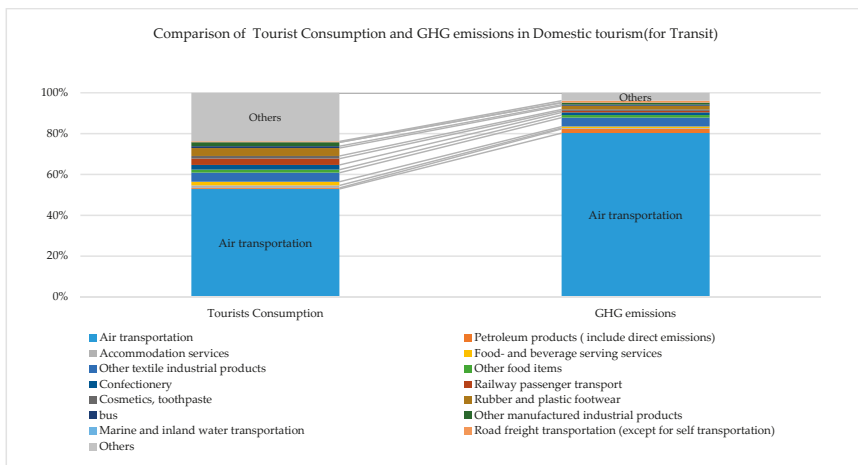

Figure 5. Comparison of traveler’s consumption and the GHG emissions of domestic tourism (for Transit).

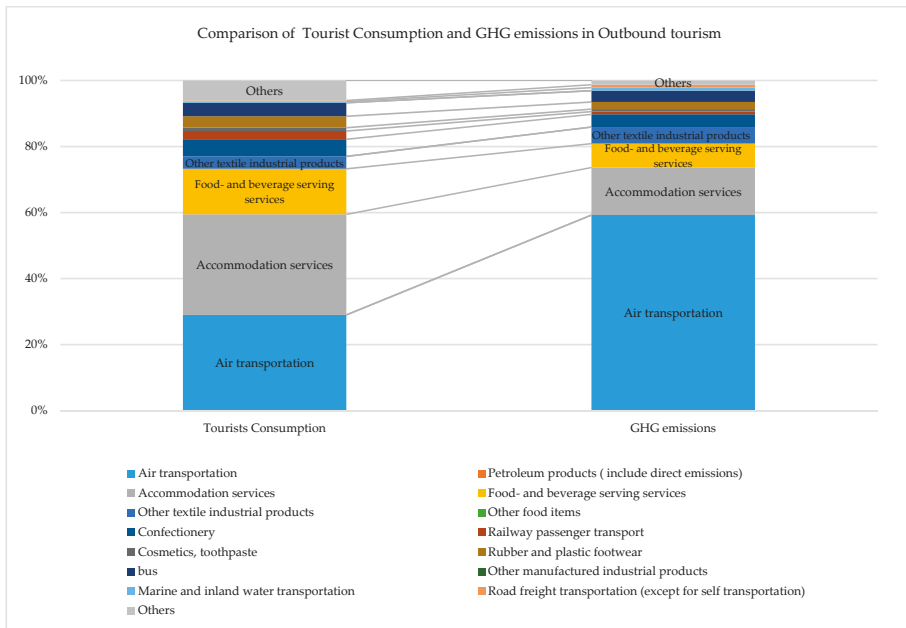

Figure 6. Comparison of traveler’s consumption and the GHG emissions of the outbound tourism stage.

From these results, the impact of transport is important, not only due to the transportation directly but also due to the contribution from souvenirs, accommodation, and food and beverage.

The following sub-parts 3.2 to 3.4 show the detailed breakdown by stage.

3.2. Inbound Tourism

Figure 2 shows the comparison of travelers’ consumption and GHG emissions of the inbound tourism stage. Travelers spend a great deal on accommodation, food and beverage, and cosmetics, and the GHG emissions show similar tendencies. It can also be seen that air transport has a higher impact than others.

3.3. Domestic Tourism

3.3.1. Overnight Stay

Figure 3 shows the comparison of travelers’ consumption and GHG emissions of domestic tourism (overnight stay). Travelers spend a great deal on accommodation, food and beverage, and railway transport, and the GHG emissions share similar tendencies. Certainly, petroleum products (include direct emissions) have a higher impact than others. Air transportation also has the fourth highest impact in this stage.

3.3.2. Day Trip

Figure 4 shows the comparison of travelers’ consumption and GHG emissions of the domestic tourism (day trip) stage. Travelers spend a lot on railway transport and food and beverage, and the GHG emissions show similar tendencies. Certainly, petroleum products (include direct emissions) have a higher impact than others.

3.3.3. For Transit Overseas

Figure 5 shows the comparison of travelers' consumption and GHG emissions of domestic tourism (for Transit). Travelers spend a great deal on air transport, and the GHG emissions show a similar tendency. Certainly, air transport has a higher impact than others. On the other hand, the ratio of rail transport is lower.

3.4. Outbound Tourism

Figure 6 shows the comparison of travelers' consumption and the GHG emissions of the outbound stage. Travelers spend a great deal on air transport, and the GHG emissions have a similar tendency. Certainly, air transport has a higher impact than others. On the other hand, the ratio of rail transport is lower.

4. Discussion

4.1. Comparison with Existing Research

The GHG emissions of Japan in 2017, as announced by the Ministry of the Environment, were 1292 million t-CO₂eq [27]. Therefore, according to the results developed in this study, tourism in Japan accounts for about 10.5% of the national CFP (Table 4).

Table 4. Comparison between the results of this study and the annual total CO₂eq emissions in Japan. This article is based on the Japan Tourism Agency (JTA) statistical data [24] compiled from January to December, and the Ministry of the Environment's published values [27] are compiled from April to March. A comparison was made for confirming the contribution from the tourism sector.

Case	GHG emission of Japan (Fixed Report) in FY 2017	This Case Result (Data of 2017)
Object	The whole of Japan	Tourism consumption of Japan
Amount of emission million t-CO ₂ eq	1292	136
Ratio (%)	100	10.5

According to the estimation from the JTA [6], the tourism GDP in 2017 was 10.7 trillion yen which is about 2.0% of Japan's nominal GDP (545.1 trillion yen) (Table 5).

The tourism policy of the Japanese government is aimed at stimulating both inbound demand and domestic consumption; it can be estimated that the economic effects will increase further in the future [28]. Based on the results of this study and the following references, we should closely monitor the relationship between economic activity and changes in GHG emissions.

Table 5. Comparison between Japan's gross domestic product (GDP) and the tourism GDP (United Nations World Tourism Organization (UNWTO) standard).

Case	GDP	Japan Tourism Agency (JTA)
Object	The whole of Japan (2017)	Tourism consumption of Japan (2017)
Amount of GDP trillion-JPY	545.1	10.7
Ratio (%)	100	2.0

Shimizu et al. (2014) [20] stated that, in the future, the tourism industry should actively consider measures to reduce greenhouse gases, as one of the leading industries in the world. However, there are only a few certification registrations in the CFP program [17] and Eco Mark [18,19] that are used to label systems for businesses in Japan. Lenzen et al. (2018) [12] noted that the majority of CFP is emitted by travelers from high-income countries inside or outside their countries. Their results show about 8% of global GHG emissions. In addition, the surge in tourism demand is becoming an urgent issue that far exceeds the decarbonization systems of tourism-related technologies. Figure 7 shows the relationship

between the GHG emissions and tourism consumption. The larger the vertical value, the higher the GHG emissions and therefore the higher the environmental impacts. The larger the horizontal value, the greater the tourism consumption and the higher the economic effects. Therefore, products and services with low GHG emissions that are largely consumed by the tourism sector can be said to be products and services that contribute to both the environment and economy. For example, it could be confirmed that accommodation and eating and drinking services have a lower environmental impact and better economic effects than air transportation. If focusing on transportation only, the economic effects of air transportation and railway passenger transport are similar; however, it can be seen that air transportation is superior in terms of the environmental burden. In addition, it can be seen that sweets related to souvenirs, other foodstuffs, and other textile industry products certainly have a small environmental impact but also a small economic effect.

Appendix A Figures A1–A6 show Figure 7 in detail. In each figure, the items for each product category are displayed in text. For example, Appendix A, Figure A5 shows text in the figure to indicate only Souvenir items. Most items are above the linear approximation. Appendix A, Figure A6 shows text in the figure to indicate only Activity items. Many items are below the linear approximation. Thus, activities have less environmental impact than souvenirs and contribute to the economic impact. However, the Accommodation in Figure 3 is only Accommodation services and Vacation home ownership (imputed). No difference is shown here for the type of accommodation or set plan. Furthermore, the Food and beverage in Figure 4 has only one item and cannot show different types of meals.

For this reason, in Japan, it is necessary to consider measures to reduce GHG emissions for each product and service that compose tourism, such as accommodation, *Food and beverage, and souvenirs, etc.* In addition, it is necessary to educate the relevant operators to identify the environmental issues and actively work on reducing GHG emissions. Finally, we believe that it is an urgent issue to develop products and services that can be selected by travelers based on environmental labeling and other labeling systems. In recent years, the tourism trend has shifted from consumption of goods to experiences. The study found that it is also beneficial to increase experiential consumption to aim for a sustainable tourism style. After this, we plan to assess the environmental and economic impact of individual travel as a case study to see if this is sustainable tourism.

Filimonau et al. (2016) [11] expects that many of the LCA evaluation examples for tourism shown in the book can educate tourists to choose sustainable tourism. In Japan, there are only a few applications based on LCA methods (particularly process-based LCA) to evaluate the different components of tourism. In other countries, for example, the input–output LCA approach is used to evaluate the hotel industry by focusing not only on climate change but also on other environmental impacts (Appendix A, Table A1: Rosenblum et al. (2000)).

4.2. Limitations and Future Investigations

As an issue related to these results, it is necessary to expand the products and services that constitute tourism, from the viewpoint of evaluation with higher extensibility and comprehensiveness. In particular, this article does not include procurement, direct energy, waste, etc., of the MICE organizers. In addition, as the results differ depending on the setting of the boundary range (ex: inbound tourism/domestic tourism, local consumption, etc.), examining how to use the results is also necessary.

In the future, it is necessary to study the close link between the economic expansion and the several environmental impacts (climate change, land use, and water use, for example) of the different products and services which are consumed in the tourism industry, not only air transportation but also other services, for example, accommodation and souvenirs. Moreover, not only a mid-range view is profitable but also a long-term assessment to track the possible evolutions compared with the past.

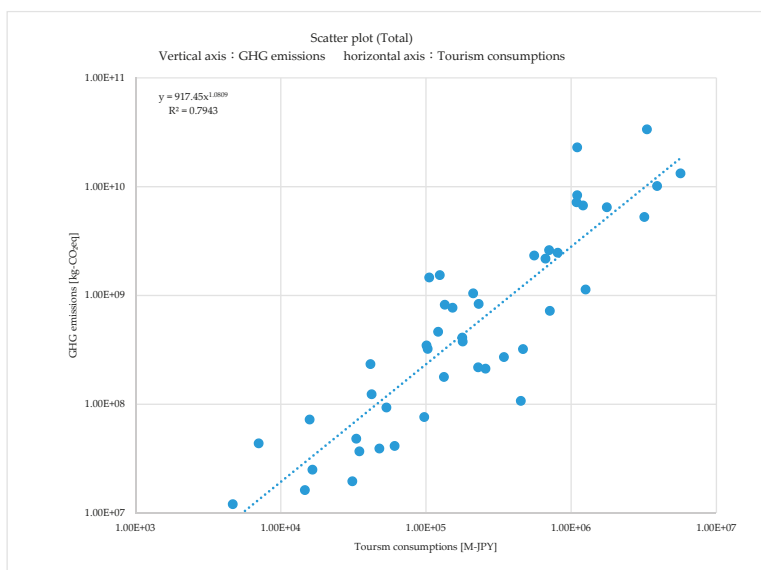

Figure 7. Scatter plot of the total GHG emissions and tourism consumption. Appendix A Figures A1–A6 shows plots of details for each product and service (e.g., tour operators and guides, transport, accommodation, food and beverage, souvenirs, activities).

5. Conclusions

We have established a procedure to quantitatively view the Japanese tourism industry's CFP. In this study, we calculated the CFP, and it was found to be 136 million t-CO₂eq (Figure 1). The contribution ratio of each stage was as follows: Transport 56.3%, Souvenirs 23.2%, Accommodation 9.8%, Food and Beverage 7.5%, Activities 3.0%. Then, in the breakdown, the impact had the following order: Air transport 24.7%, Petrol (direct emissions) 16.9%, Accommodation 9.8%, Food and Beverage 7.5%, Petrol 6.1%, Textile products 5.3%, Food items 4.9%, Confectionery 4.8%, Rail transport 3.9%, Cosmetics 1.9%, and Footwear 1.8%.

From the results of this study, we have shown that tourism can generate GHG emissions that contribute to climate change and to the environmental burden. In addition, we showed the tendencies of the characteristics of tourism and tourist consumption. The breakdown regards the use of air transportation and accommodation services, which are indispensable for transportation and stay, and also the contribution of food services, souvenirs, and confectionery. Through considering different types of movements (domestic and global), we were able to confirm a high contribution from the purchase and consumption of pharmaceuticals, cosmetics, shoes, and bags.

In addition, if the tourism industry is prosperous, despite a great economic effect advantage, there is a drawback, as the environmental burden increases. It is then important for travelers to be able to select products and services with a lower environmental impact.

In this study, priority was given to showing the whole of CFP in tourism and finding significant contributions other than transportation. We need to know about low-carbon consumption of products and services and changes in consumption styles over the medium to long term and consider alternatives to reduce significant contributions. However, it is necessary to thoroughly examine and discuss whether changes in travel styles will contribute to GHG reduction. It is also necessary to conduct evaluation studies on whether new travel styles contribute to sustainable tourism from the perspectives of the environment, economy, and society, including CFP evaluation.

Author Contributions: Conceptualization, Y.K. and N.I.; methodology, Y.I. and N.I.; writing—original draft preparation, Y.K. and S.K.; supervision, N.I. All authors have read and agreed to the published version of the manuscript.

Funding: This research received no external funding.

Acknowledgments: We would like to express our gratitude to Haruo Suzuki for his generous support for our study.

Conflicts of Interest: The authors declare no conflict of interest.

Appendix A

Table A1. Existing case study and paper. The following table was added by the author based on V. Filimonau et al. 2016 [11].

Study	Object of Analysis	Primary environmental Impacts Assessed	Geographical Scope
Process-based LCA			
Castellani and Sala (2012) [29]	Holiday travel, Including accommodation	A range of impacts	Italy
Filimonau et al. (2011a) [30]			UK
Filimonau et al. (2014) [31]			UK and France
El Hanandeh (2013) [32]	Religious travel, Including accommodation	Climate change	Saudi Arabia
Pereira et al. (2015) [33]	Holiday travel, Excluding accommodation		Brazil
Filimonau et al. (2013) [34]	Holiday package		UK and Portugal
Kuo et al. (2005) [35]	Tourist catering		Taiwan
Michailidou et al. (2015) [36]		A range of impacts	Greece
König et al. (2007) [37]			Portugal
Sára et al. (2004) [38]			
De Camillis et al. (2008) [39]	Tourist accommodation		Italy
Cerutti et al. (2014) [40]			
Filimonau et al. (2011b) [41]			UK
Roselló-Batle et al. (2010) [42]		Climate change	Spain
Li et al. (2010) [43]			China
Input–output LCA			
Scheepens et al. (2015) [44]	Sector of regional tourism		The Netherlands
Berners-Lee et al. (2011) [45]	Large tourism business		UK
Patterson and McDonald (2004) [46]	National tourism industry	Climate change	New Zealand
Cadarso et al. (2015) [47]			Spain
Zhong et al. (2015) [48]			China
Qin et al. (2015) [49]	Tourist destination		
Manfred Lenzen (2018) [12]	Global tourism		160 countries
Rosenblum et al. (2000) [50]	National hotel industry	A range of impacts	USA

Table A2. Internal and national tourism consumption, by timing of purchase and products (CY2017, Unit: Billion JPY).

Products	Inbound	Domestic			Outbound	Total
		Overnight Stay	Day Trip	TRANSIT		
Travel agencies, operators, and guides						
Travel agencies, tour operators, and tourist guide services	22	225	33	159	27	466
Transport						
Airplane (domestic, local)	19	1244	143	32	127	1565
Airplane (international flight)	326	0	0	726	713	1765
Bullet train	292	1443	595	22	0	2353
Railways (excluding bullet train)	0	453	255	22	72	802
Bus	0	248	178	13	118	558
Taxi	61	112	33	5	0	212
Ships (inner service, local)	6	97	10	0	11	125
Ships (outbound)	1	0	0	4	0	5
Car rental fee	43	256	45	0	0	345
Gasoline cost	0	672	424	7	0	1,103
Parking lot, toll road charge (except for highway charge)	0	175	104	13	0	291
Highway charge	0	618	341	8	0	967
Accommodation						
Accommodation services	1077	3,697	0	18	883	5674
Vacation home ownership (imputed)	0	451	0	0	0	451
Food and beverage						
Food and beverage serving services	766	2077	646	26	400	3914
Souvenirs						
Agricultural products	0	97	82	0	0	179
Agricultural processed products	0	65	38	0	0	103
Marine products	0	93	42	0	0	135
Fisheries processed products	0	105	48	0	0	153
Confectionery	137	1022	419	33	150	1762
Other food items	163	691	333	21	0	1208
Fiber products	35	652	232	63	109	1091
Shoes, bags	257	285	111	56	101	810
Ceramics and glass products	0	33	9	0	0	42
Publication	18	50	24	9	0	101
Wood products and paper products	0	23	18	0	0	42
Medical supplies and Cosmetics	549	89	20	19	29	705
Film	0	5	1	1	0	7
Electrical equipment and related products	107	71	25	21	8	231
Camera, glasses, watch	80	101	25	22	0	229
Sports equipment · CD · stationery	0	124	109	5	0	238
Other manufactured products	72	80	48	0	0	199
Activities						
A day spa-warm-bathing facility-beauty salon	0	83	39	0	0	121
Museums, museums, zoos and gardens, aquariums	26	105	47	0	0	178
Watching sports and Art appreciation	9	82	93	0	44	228
Amusement parks and expositions	47	232	151	0	55	486
Sports Facilities	0	53	80	0	0	132
Ski lift fee	0	27	13	0	0	40
Camp site	0	0	1	0	0	1
Exhibition and convention participation fee	0	16	16	0	0	31
Tourist farm	0	7	8	0	0	16
Fishing boat	0	20	14	0	0	33
Guide fee	0	20	12	0	0	32
Rental charge	10	64	12	13	0	97
Massage	0	32	3	0	0	35
Photo shoot fee	0	10	4	0	0	15
Mail and communication charges	0	11	2	1	2	17
Home delivery	0	80	10	6	9	105
Travel insurance · Credit card admission fee	0	27	3	32	0	61
Passport application fee	0	0	0	41	0	41
Visa application fee	0	0	0	0	7	7
Hairdresser/Barber	0	155	64	11	0	229
Develop and print photos	0	31	14	5	0	49
Laundry service	0	38	13	3	0	53
Other	22	61	43	17	33	176
Total	4146	16,508	5031	1432	2897	30,015

Table A3. Sector row code table of the input–output table items by sector, as applied in this study.

Products	Input–Output Table (I/O) Items	
	Row Code	Sector
Travel agencies, operators, and guides		
Travel agencies, tour operators, and tourist guide services	5789090	Travel and other transportation incidental services
Transport		
Airplane (domestic, local)	5751010	Air transportation
Airplane (international flight)	5751010	Air transportation
Bullet train	5711010	Railway passenger transport
Railways (excluding bullet train)	5711010	Railway passenger transport
Bus	5721010	Bus
Taxi	5721020	Taxi
Ships (inner service, local)	5742010	Marine and inland water transportation
Ships (outbound)	5741010	Ocean transportation
Car rental fee	6612010	Car rental business
Gasoline cost	2111010	Petroleum products
Parking lot, toll road charge (except for highway charge)	5789010	Road transport facility provided
Highway charge	5789010	Road transport facility provided
Accommodation		
Accommodation services	6711010	Accommodation services
Vacation home ownership (imputed)	5531010	Vacation home ownership (imputed)
Food and beverage		
Food and beverage serving services	6721010	Food- and beverage serving services
Souvenirs		
Agricultural products	116090	Other non-food crops
Agricultural processed products	1116020	Agro-preserved food products (except bottles and cans)
Marine products	172001	Inland fishery and aquaculture
Fisheries processed products	1113090	Other seafood
Confectionery	1115-030	Confectionery
Other food items	1119090	Other food items
Fiber products	1519090	Other textile industrial products
Shoes, bags	2229-010	Rubber and plastic footwear
Ceramics and glass products	2312020	Bags, bags and other leather products
Publication	5951030	Publication
Wood products and paper products	1649090	Other pulp, paper and paper products
Medical supplies and Cosmetics	2081020	Cosmetics, toothpaste
Film	2083010	Photosensitive material
Electrical equipment and related products	3321020	Consumer electrical appliances (except air conditioners)
Camera, glasses, watch	3919090	Other manufactured industrial products
Sports equipment · CD · stationery	3919090	Other manufactured industrial products
Other manufactured products	3919090	Other manufactured industrial products
Activities		
A day spa-warm-bathing facility-beauty salon	6731040	Bathing
Museums, museums, zoos and gardens, aquariums	6312010	Social education (public)
Watching sports and Art appreciation	6741020	Office space (except movie theaters) and entertainment companies
Amusement parks and expositions	6741020	Office space (except movie theaters) and entertainment companies
Sports Facilities	6741040	Sports facility offer work, park, amusement park
Ski lift fee	5711010	Railway passenger transport
Camp site	6741040	Sports facility offer work, park, amusement park
Exhibition and convention participation fee	6699090	Other business services
Tourist farm	131020	Agricultural services (except for veterinary services)
Fishing boat	6741090	Other entertainment
Guide fee	6799090	Other personal services
Rental charge	6611010	Goods rental business (excluding rental cars)
Massage	6411050	Medical (other medical services)
Photo shoot fee	6799010	Photography
Mail and communication charges	5791010	Postal and letter mail
Home delivery	5722010	Road freight transportation (except for self-transportation)
Travel insurance · Credit card admission fee	5312010	Life insurance
Passport application fee	6112010	Government (local)
Visa application fee	6112010	Government (local)
Hairdresser/Barber	6731030	Beauty industry
Develop and print photos	6799090	Other personal services
Laundry service	6731010	laundry service
Other	6799090	Other personal services

Table A4. CFP calculation result of I/O items of each product service in this study (Unit: kg-CO₂eq).

I/O Items	Inbound	Domestic			Outbound	Total
		Overnight Stay	Day Trip	TRANSIT		
Transport	4.37E+09	3.84E+10	1.63E+10	8.02E+09	9.21E+09	7.64E+10
Air transportation	3.48E+09	1.25E+10	1.44E+09	7.64E+09	8.47E+09	3.36E+10
Petroleum products	0.00E+00	5.07E+09	3.20E+09	5.10E+07	0.00E+00	8.33E+09
Railway passenger transport	4.80E+08	3.16E+09	1.42E+09	7.27E+07	1.19E+08	5.25E+09
Bus	0.00E+00	1.03E+09	7.42E+08	5.45E+07	4.91E+08	2.32E+09
Marine and inland water transportation	7.47E+07	1.20E+09	1.27E+08	4.75E+06	1.32E+08	1.53E+09
Road transport facility provided	0.00E+00	7.13E+08	3.99E+08	1.86E+07	0.00E+00	1.13E+09
Taxi	2.99E+08	5.55E+08	1.64E+08	2.55E+07	0.00E+00	1.04E+09
Car rental business	3.38E+07	2.02E+08	3.56E+07	0.00E+00	0.00E+00	2.71E+08
Ocean transportation	1.98E+06	0.00E+00	0.00E+00	1.00E+07	0.00E+00	1.20E+07
Petroleum products (direct emissions)	0.00E+00	1.40E+10	8.80E+09	1.45E+08	0.00E+00	2.29E+10
Souvenirs	5.39E+09	1.62E+10	7.00E+09	1.09E+09	1.71E+09	3.14E+10
Other textile industrial products	2.29E+08	4.29E+09	1.53E+09	4.17E+08	7.17E+08	7.18E+09
Other food items	9.01E+08	3.83E+09	1.84E+09	1.18E+08	0.00E+00	6.69E+09
Confectionery	5.03E+08	3.75E+09	1.53E+09	1.22E+08	5.50E+08	6.46E+09
Cosmetics, toothpaste	2.02E+09	3.30E+08	7.25E+07	6.88E+07	1.07E+08	2.60E+09
Rubber and plastic footwear	7.83E+08	8.68E+08	3.38E+08	1.70E+08	3.07E+08	2.47E+09
Other manufactured industrial products	4.97E+08	9.97E+08	5.92E+08	8.81E+07	0.00E+00	2.17E+09
Consumer electrical appliances (except air conditioners)	3.87E+08	2.56E+08	8.84E+07	7.48E+07	2.76E+07	8.34E+08
Inland fishery and aquaculture	0.00E+00	5.64E+08	2.55E+08	0.00E+00	0.00E+00	8.19E+08
Other seafood	0.00E+00	5.27E+08	2.42E+08	0.00E+00	0.00E+00	7.69E+08
Other non-food crops	0.00E+00	2.04E+08	1.72E+08	0.00E+00	0.00E+00	3.76E+08
Publication	6.33E+07	1.72E+08	8.16E+07	2.97E+07	0.00E+00	3.46E+08
Agro-preserved food products (except bottles and cans)	0.00E+00	2.03E+08	1.19E+08	0.00E+00	0.00E+00	3.22E+08
Other pulp, paper and paper products	0.00E+00	1.31E+08	1.03E+08	0.00E+00	0.00E+00	2.33E+08
Bags, bags and other leather products	0.00E+00	9.59E+07	2.73E+07	0.00E+00	0.00E+00	1.23E+08
Photosensitive material	0.00E+00	3.12E+07	7.51E+06	4.90E+06	0.00E+00	4.36E+07
Accommodation	2.51E+09	8.73E+09	0.00E+00	4.13E+07	2.06E+09	1.33E+10
Accommodation services	2.51E+09	8.62E+09	0.00E+00	4.13E+07	2.06E+09	1.32E+10
Vacation home ownership (imputed)	0.00E+00	1.07E+08	0.00E+00	0.00E+00	0.00E+00	1.07E+08
Food and Beverage	1.98E+09	5.37E+09	1.67E+09	6.61E+07	1.03E+09	1.01E+10
Food- and beverage serving services	1.98E+09	5.37E+09	1.67E+09	6.61E+07	1.03E+09	1.01E+10
Cultural, Recreation, Entertainment, etc.	1.43E+08	2.56E+09	9.74E+08	1.86E+08	2.63E+08	4.13E+09
Road freight transportation (except for self-transportation)	0.00E+00	1.11E+09	1.33E+08	8.70E+07	1.27E+08	1.46E+09
Office space (except movie theaters) and entertainment companies	5.67E+07	3.17E+08	2.47E+08	0.00E+00	1.00E+08	7.21E+08
Bathing	0.00E+00	3.14E+08	1.48E+08	0.00E+00	0.00E+00	4.62E+08
Social education (public)	6.06E+07	2.40E+08	1.08E+08	0.00E+00	0.00E+00	4.09E+08
Beauty industry	0.00E+00	1.47E+08	6.05E+07	1.04E+07	0.00E+00	2.18E+08
Other personal services	1.83E+07	9.18E+07	5.69E+07	1.77E+07	2.71E+07	2.12E+08
Sports facility offer work, park, amusement park	0.00E+00	7.05E+07	1.07E+08	0.00E+00	0.00E+00	1.78E+08
laundry service	0.00E+00	6.52E+07	2.34E+07	4.41E+06	0.00E+00	9.30E+07
Goods rental business (excluding rental cars)	7.67E+06	4.95E+07	9.01E+06	9.83E+06	0.00E+00	7.60E+07
Agricultural services (except for veterinary services)	0.00E+00	3.37E+07	3.84E+07	0.00E+00	0.00E+00	7.21E+07
Other entertainment	0.00E+00	2.84E+07	1.97E+07	0.00E+00	0.00E+00	4.81E+07
Life insurance	0.00E+00	1.81E+07	1.79E+06	2.14E+07	0.00E+00	4.13E+07
Government (local)	0.00E+00	0.00E+00	0.00E+00	3.37E+07	5.33E+06	3.91E+07
Medical (other medical services)	0.00E+00	3.39E+07	2.91E+06	0.00E+00	0.00E+00	3.68E+07
Postal and letter mail	0.00E+00	1.60E+07	3.65E+06	1.78E+06	3.49E+06	2.49E+07
Other business services	0.00E+00	9.82E+06	9.72E+06	0.00E+00	0.00E+00	1.95E+07
Photography	0.00E+00	1.13E+07	4.90E+06	0.00E+00	0.00E+00	1.62E+07
Travel agencies, tour operators and guide services	1.54E+07	1.54E+08	2.29E+07	1.09E+08	1.88E+07	3.21E+08
Travel and other transportation incidental services	1.54E+07	1.54E+08	2.29E+07	1.09E+08	1.88E+07	3.21E+08
Total	1.44E+10	7.15E+10	2.60E+10	9.52E+09	1.43E+10	1.36E+11

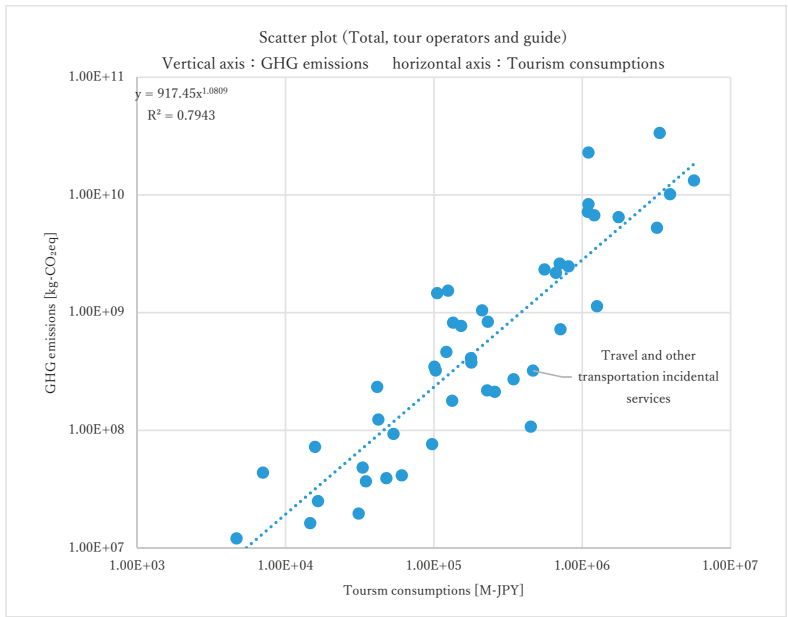

Figure A1. Scatter plot by product category (details of Figure 7 Scatter plot of the total GHG emissions and tourism consumption). The text in the figure indicates only the Tour operator and guide items.

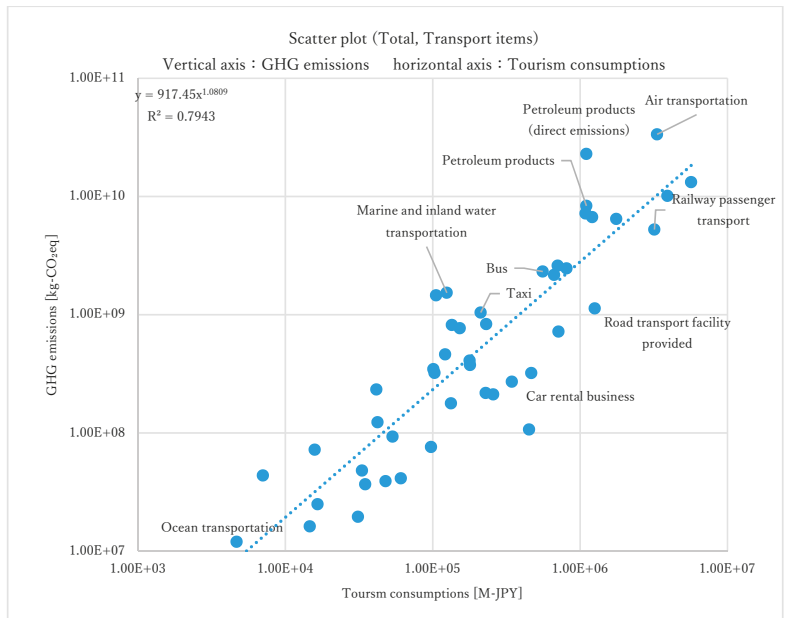

Figure A2. Scatter plot by product category (details of Figure 7 Scatter plot of the total GHG emissions and tourism consumption). The text in the figure indicates only the Transport items.

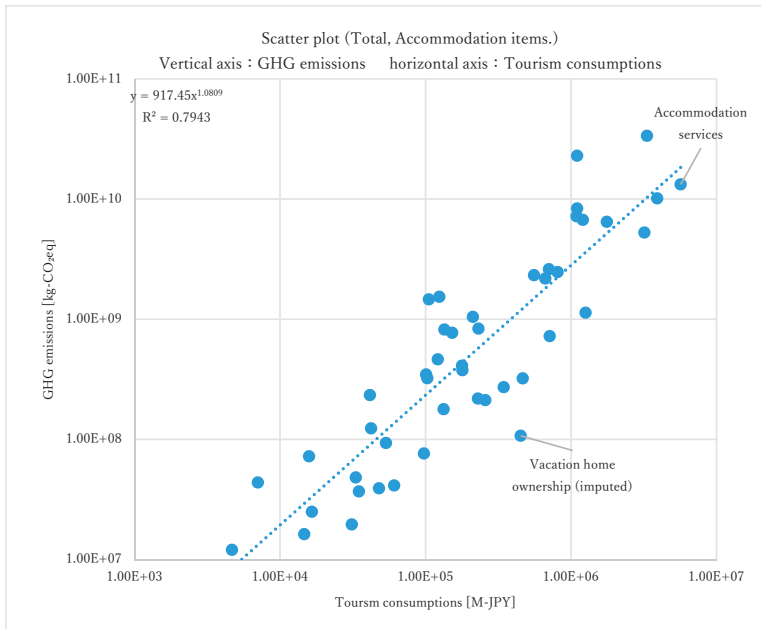

Figure A3. Scatter plot by product category (details of Figure 7 Scatter plot of the total GHG emissions and tourism consumption). The text in the figure indicates only the Accommodation items.

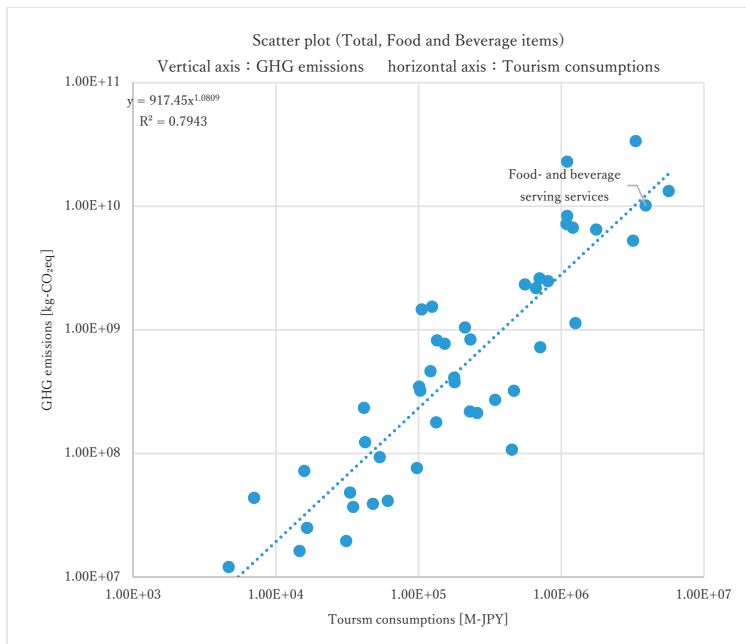

Figure A4. Scatter plot by product category (details of Figure 7 Scatter plot of the total GHG emissions and tourism consumption). The text in the figure indicates only the Food and Beverage items.

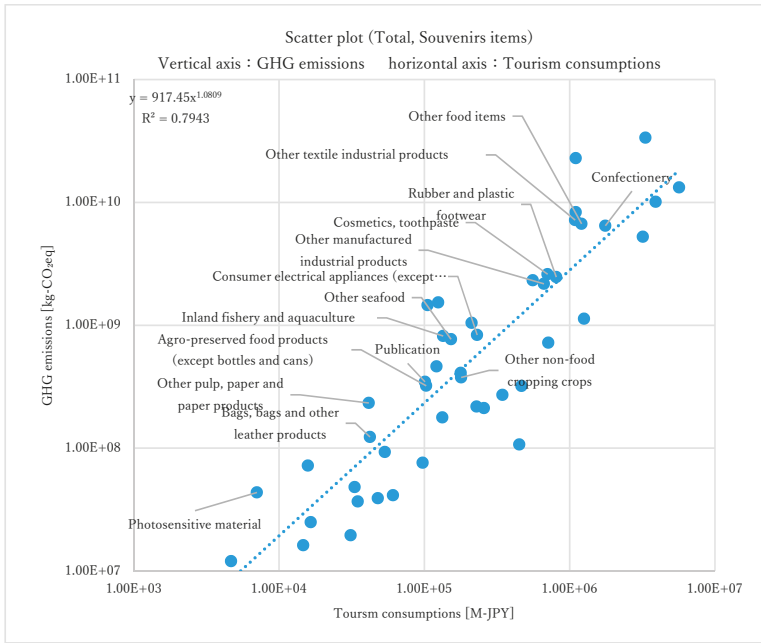

Figure A5. Scatter plot by product category (details of Figure 7 Scatter plot of the total GHG emissions and tourism consumption). The text in the figure indicates only the Souvenir items.

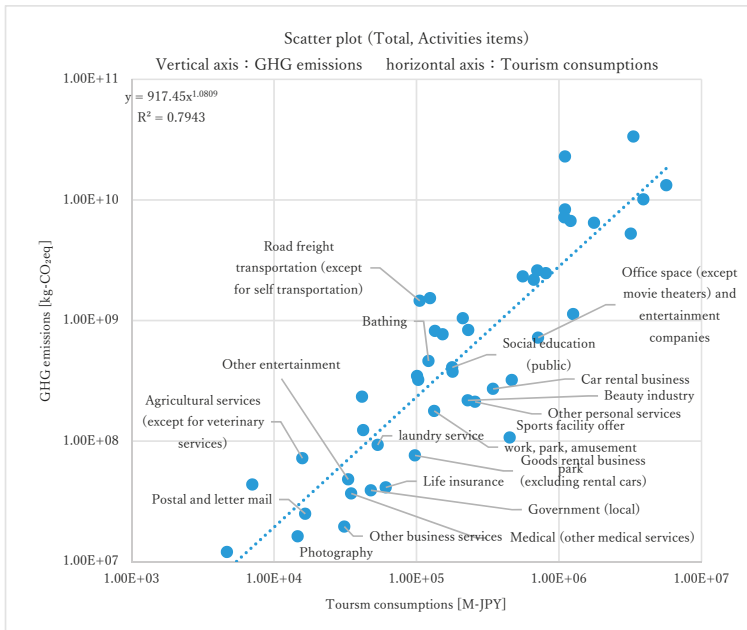

Figure A6. Scatter plot by product category (details of Figure 7 Scatter plot of the total GHG emissions and tourism consumption). The text in the figure indicates only the Activities items.

References

1. Japan Tourism Agency (JTA). Promotion of Attracting and Holding MICE. Available online: <http://www.mlit.go.jp/kankochu/shisaku/kokusai/mice.html> (accessed on 13 August 2019).
2. United Nations World Tourism Organization (UNWTO). Definition. Available online: <https://unwto-ap.org/why/tourism-definition/> (accessed on 13 August 2019).
3. 2017 International Year of Sustainable Tourism for Development. Available online: <http://www.tourism4development2017.org/about/> (accessed on 14 August 2019).
4. United Nations World Tourism Organization (UNWTO). *Sustainable Tourism for Development Guidebook—Enhancing capacities for Sustainable Tourism for Development in Developing Countries*; UNWTO: Madrid, Spain, 2013.
5. Ministry of Land, Infrastructure, Transport and Tourism (Japan). Survey on Tourism and Environment. 2008. Available online: <https://www.mlit.go.jp/common/000059329.pdf> (accessed on 14 August 2019).
6. Japan Tourism Agency. The Japan Tourism White Paper (2017). (Announcement 12 June 2019). Available online: <http://www.mlit.go.jp/common/001237338.pdf> (accessed on 14 August 2019).
7. Martín Martín, J.M.; Guaita Martínez, J.M.; Salinas Fernández, J.A. An analysis of the factors behind the citizen's attitude of rejection towards tourism in a context of overtourism and economic dependence on this activity. *Sustainability* **2018**, *10*, 2851. [CrossRef]
8. Martín, J.M.M.; Martínez, J.M.G. Entrepreneurs' attitudes toward seasonality in the tourism sector. *Int. J. Entrep. Behav. Res.* **2019**. [CrossRef]
9. Martínez, J.M.G.; Martín, J.M.M.; Fernández, J.A.S.; Mogorrón-Guerrero, H. An analysis of the stability of rural tourism as a desired condition for sustainable tourism. *J. Bus. Res.* **2019**, *100*, 165–174. [CrossRef]
10. Martínez, J.M.G.; Martín, J.M.M.; Fernández, J.A.S. Innovation in the Measurement of Tourism Competitiveness. In *Analyzing the Relationship Between Innovation, Value Creation, and Entrepreneurship*; IGI Global: Valencia, Spain, 2020; pp. 268–288.
11. Filimonau, V. *Life Cycle Assessment (LCA) and Life Cycle Analysis in Tourism*; Springer International Publishing: Cham, Switzerland, 2016.
12. Lenzen, M.; Sun, Y.; Faturay, F.; Ting, Y.; Geschke, A.; Malik, A. The carbon footprint of global tourism. *Nat. Climate Chang.* **2018**, *8*, 522–528. [CrossRef]
13. New Tourism Study Group of The Institute of Life Cycle Assessment, Japan. Available online: <https://www.ilcaj.org/lcahp/kenkyukai-2.php> (accessed on 14 August 2019).
14. Ito, Y.; Morimoto, R.; Shibahara, N.; Kato, H. CO₂ Emission Factor of Transport Systems for Carbon Footprint in Tourism. In Proceedings of the 6th Meeting of the Institute of Life Cycle Assessment, Sendai, Japan, 2 March 2011; pp. 32–33.
15. Tamari, Y.; Morimoto, R.; Inaba, A. The Estimation Method of CO₂ Emission for Hotel Accommodation in the Tourism. In Proceedings of the 6th Meeting of the Institute of Life Cycle Assessment, Sendai, Japan, 2 March 2011; pp. 36–37.
16. Kazama, R.; Morimoto, R.; Inaba, A. The Estimation Method of CO₂ Emission for Meal in the Tourism. In Proceedings of the 6th Meeting of the Institute of Life Cycle Assessment, Sendai, Japan, 2 March 2011; pp. 38–39.
17. Japan Environmental Management Association for Industry. *Certified Carbon Footprint Communication Program CFP-PCR:PA-DO-01*; Japan Environmental Management Association for Industry: Tokyo, Japan, 2014.
18. Japan Environment Association Eco Mark Office. *Product Certification Standards "Service": Hotel/Ryokan (Ver.2.0)*; Japan Environment Association Eco Mark Office: Tokyo, Japan, 2019.
19. Japan Environment Association Eco Mark Office. *Product Certification Standards "Service": Restaurant (Ver.1.0)*; Japan Environment Association Eco Mark Office: Tokyo, Japan, 2017.
20. Shimizu, T.; In, S. Estimation of CO₂ Emission Volume by Japanese and Korean Tourism Industries. *Int. J. Tour. Sci.* **2015**, *8*, 71–79.
21. International Standard, ISO 14044: 2006(E). *Environmental Management—Life Cycle Assessment—Requirements and Guidelines*, 1st ed.; ISO: Geneva, Switzerland, 2006.
22. Leontief, W.W. *Input–Output Economics*, 2nd ed.; Oxford University Press: New York, NY, USA, 1986.
23. Hondo, H. Application of input–output table in LCA. *J. Econ. Struct.* **2008**, *16*, 5–15.

24. Japan Tourism Agency (JTA). Research study on economic impacts of tourism in Japan (2017 Edition). 2019. Available online: <http://www.mlit.go.jp/kankocho/siryou/toukei/shouhidoukou.html#cp3> (accessed on 14 August 2019).
25. Kondo, Y. Estimation of 2011 Waste Input–output Table for Japan. *J. Life Cycle Assess. Jpn.* **2019**, *15*, 33–41. [[CrossRef](#)]
26. Japan Tourism Agency (JTA). Survey of Consumption Trends for Foreign Visitors to Japan (Part 3) (2017 Edition). 2018. Available online: <http://www.mlit.go.jp/kankocho/siryou/toukei/syouthityousa.html> (accessed on 14 August 2019).
27. Ministry of the Environment Government of Japan. Calculation Results of Greenhouse Gas Emissions 2016. Available online: <https://www.env.go.jp/earth/ondanka/ghg-mrv/emissions/results-h28.html> (accessed on 14 August 2019).
28. Japan Tourism Agency (JTA). Press/interview (Announcement 30 March 2016). Available online: https://www.mlit.go.jp/kankocho/news08_000281.html (accessed on 14 August 2019).
29. Castellani, V.; Sala, S. Ecological Footprint and Life Cycle Assessment in the sustainability assessment of tourism activities. *Ecol. Indic.* **2012**, *16*, 135–147. [[CrossRef](#)]
30. Filimonau, V.; Dickinson, J.; Robbins, D.; Reddy, M.V. A critical review of methods for tourism climate change appraisal: Life cycle assessment as a new approach. *J. Sustain. Tour.* **2011**, *19*, 301–324. [[CrossRef](#)]
31. Filimonau, V.; Dickinson, J.; Robbins, D. The carbon impact of short-haul tourism: A case study of UK travel to Southern France using life cycle analysis. *J. Clean. Prod.* **2014**, *64*, 628–638. [[CrossRef](#)]
32. El Hanandeh, A. Quantifying the carbon footprint of religious tourism: The case of Hajj. *J. Clean. Prod.* **2013**, *52*, 53–60. [[CrossRef](#)]
33. Pereira, R.P.T.; Glydston, M.B.; Filimonau, V. The carbon implications of local visitor travel in Brazil: A case of the Rio de Janeiro and São Paulo itinerary. *J. Clean. Prod.* **2017**, *141*, 256–266. [[CrossRef](#)]
34. Filimonau, V.; Dickinson, J.; Robbins, D.; Reddy, M.V. The role of ‘indirect’ greenhouse gas emissions in tourism: Assessing the hidden carbon impacts from a holiday package tour. *Transp. Res. Part A* **2013**, *54*, 78–91. [[CrossRef](#)]
35. Kuo, N.W.; Hsiao, T.Y.; Lan, C.F. Tourism management and industrial ecology: A case study of food service in Taiwan. *Tour. Manag.* **2005**, *26*, 503–508. [[CrossRef](#)]
36. Michailidou, A.V.; Vlachokostas, C.; Maleka, D.; Feleke, E.; Moussiopoulos, N. Life cycle impact approach to promote sustainable tourism: A case study from Greek hotels. In Proceedings of the 14th International Conference on Environmental Science and Technology, Rhodes, Greece, 3–5 September 2015.
37. König, H.; Schmidberger, E.; de Cristofaro, L. Life cycle assessment of a tourism resort with renewable materials and traditional techniques. Presented at the ‘Portugal SB07, Sustainable Construction, Materials and Practice—Challenge of the Industry for the New Millennium’ Conference, Lisbon, Portugal, 12–14 September 2007.
38. Sára, B.; Raggi, A.; Petti, L.; Scimia, E. Implementation of LCA to services: Case studies in the hospitality industry. In Proceedings of the 6th International Conference on EcoBalance, Tsukuba, Japan, 25–27 October 2004.
39. De Camillis, C.; Petti, L.; Raggi, A. LCA: A key-tool for Sustainable Tourism? In Proceedings of the 8th International Conference on EcoBalance, Tokyo, Japan, 10–12 December 2008.
40. Cerutti, A.K.; Beccaro, G.L.; Bruun, S.; Donno, D.; Bonvegna, L.; Bounous, G. Assessment methods for sustainable tourism declarations: The case of holiday farms. *J. Clean. Prod.* **2016**, *111*, 511–519. [[CrossRef](#)]
41. Filimonau, V.; Dickinson, J.E.; Robbins, D.; Huijbregts, M.A.J. Reviewing the carbon footprint analysis of hotels: Life Cycle Energy Analysis (LCEA) as a holistic method for carbon impact appraisal of tourist accommodation. *J. Clean. Prod.* **2011**, *19*, 1917–1930. [[CrossRef](#)]
42. Rosselló-Batlle, B.; Moia, A.; Cladera, A.; Martínez, V. Energy use, CO₂ emissions and waste throughout the life cycle of a sample of hotels in the Balearic Islands’. *Energy Build.* **2010**, *42*, 547–558. [[CrossRef](#)]
43. Li, P.; Huang, J.H.; Mo, Y.F.; Yang, G.H. Carbon footprint calculation and analysis of accommodation services in four-star hotels of Kunming. *Tour. Trib.* **2010**, *25*, 27–34.
44. Scheepens, A.E.; Vogtländer, J.G.; Brezet, J.C. Two life cycle assessment (LCA) based methods to analyse and design complex (regional) circular economy systems. Case: Making water tourism more sustainable. *J. Clean. Prod.* **2016**, *114*, 257–268. [[CrossRef](#)]

45. Berners-Lee, M.; Howard, D.C.; Moss, J.; Kaivanto, K.; Scott, W.A. Greenhouse gas footprinting for small businesses—The use of input–output data. *Sci. Total Environ.* **2011**, *409*, 883–891. [[CrossRef](#)]
46. Patterson, M.G.; McDonald, G. *How Clean and Green is New Zealand Tourism? Lifecycle and Future Environmental Impacts*; Manaaki Whenua Press: Lincoln, New Zealand, 2004.
47. Cadarso, M.-Á.; Gómez, N.; López, L.-A.; Tobarra, M.-Á.; Zafrilla, J.-E. Quantifying Spanish tourism’s carbon footprint: The contributions of residents and visitors: A longitudinal study. *J. Sustain. Tour.* **2015**, *23*, 922–946. [[CrossRef](#)]
48. Zhong, Y.; Shi, S.; Li, S.; Luo, F. Empirical research on construction of a measurement framework for tourism carbon emission in China. *Chin. J. Popul. Resour. Environ.* **2015**, *13*, 240–249. [[CrossRef](#)]
49. Qin, Y.; Li, X.; Rong, P. Urban tourism carbon accounting based on improved EIO-LCA model: A case study of Kaifeng City in Henan Province. *Prog. Geogr.* **2015**, *34*, 132–140.
50. Rosenblum, J.; Horvath, A.; Hendrickson, C. Environmental implications of service industries. *Environ. Sci. Technol.* **2000**, *34*, 4669–4676. [[CrossRef](#)]



© 2020 by the authors. Licensee MDPI, Basel, Switzerland. This article is an open access article distributed under the terms and conditions of the Creative Commons Attribution (CC BY) license (<http://creativecommons.org/licenses/by/4.0/>).

MDPI
St. Alban-Anlage 66
4052 Basel
Switzerland
Tel. +41 61 683 77 34
Fax +41 61 302 89 18
www.mdpi.com

Sustainability Editorial Office
E-mail: sustainability@mdpi.com
www.mdpi.com/journal/sustainability



MDPI
St. Alban-Anlage 66
4052 Basel
Switzerland

Tel: +41 61 683 77 34
Fax: +41 61 302 89 18

www.mdpi.com



ISBN 978-3-0365-0889-4