

Talam, Camilla C.; Maru, Lucy

**Working Paper**

## The greening of Kenya's banking sector: Macro-financial stability implications of a low carbon transition

KBA Centre for Research on Financial Markets and Policy Working Paper Series, No. 65

**Provided in Cooperation with:**

Kenya Bankers Association (KBA), Nairobi

*Suggested Citation:* Talam, Camilla C.; Maru, Lucy (2023) : The greening of Kenya's banking sector: Macro-financial stability implications of a low carbon transition, KBA Centre for Research on Financial Markets and Policy Working Paper Series, No. 65, Kenya Bankers Association (KBA), Nairobi

This Version is available at:

<https://hdl.handle.net/10419/271526>

**Standard-Nutzungsbedingungen:**

Die Dokumente auf EconStor dürfen zu eigenen wissenschaftlichen Zwecken und zum Privatgebrauch gespeichert und kopiert werden.

Sie dürfen die Dokumente nicht für öffentliche oder kommerzielle Zwecke vervielfältigen, öffentlich ausstellen, öffentlich zugänglich machen, vertreiben oder anderweitig nutzen.

Sofern die Verfasser die Dokumente unter Open-Content-Lizenzen (insbesondere CC-Lizenzen) zur Verfügung gestellt haben sollten, gelten abweichend von diesen Nutzungsbedingungen die in der dort genannten Lizenz gewährten Nutzungsrechte.

**Terms of use:**

*Documents in EconStor may be saved and copied for your personal and scholarly purposes.*

*You are not to copy documents for public or commercial purposes, to exhibit the documents publicly, to make them publicly available on the internet, or to distribute or otherwise use the documents in public.*

*If the documents have been made available under an Open Content Licence (especially Creative Commons Licences), you may exercise further usage rights as specified in the indicated licence.*



**KENYA BANKERS**  
ASSOCIATION

One Industry. Transforming Kenya.

WPS/02/23

# The Greening of Kenya's Banking Sector: Macro-Financial Stability Implications of a Low Carbon Transition

Camilla C, Talam & Lucy Maru

April 2023

KBA Centre for Research on Financial Markets and Policy®  
Working Paper Series

65



**KENYA BANKERS**  
ASSOCIATION

One Industry. Transforming Kenya.

## Working Paper Series

### Centre for Research on Financial Markets and Policy

The Centre for Research on Financial Markets and Policy® was established by the Kenya Bankers Association in 2012 to offer an array of research, commentary, and dialogue regarding critical policy matters that impact on financial markets in Kenya. The Centre sponsors original research, provides thoughtful commentary, and hosts dialogues and conferences involving scholars and practitioners on key financial market issues. Through these activities, the Centre acts as a platform for intellectual engagement and dialogue between financial market experts, the banking sector and the policy makers in Kenya. It therefore contributes to an informed discussion that influences critical financial market debates and policies.

The Kenya Bankers Association (KBA) *Working Papers Series* disseminates research findings of studies conducted by the KBA Centre for Research on Financial Markets and Policy. *The Working Papers* constitute “work in progress” and are published to stimulate discussion and contribute to the advancement of the banking industry’s knowledge of matters of markets, economic outcomes and policy. Constructive feedback on the *Working Papers* is welcome. *The Working Papers* are published in the names of the author(s). Therefore their views do not necessarily represent those of the KBA.

The entire content of this publication is protected by copyright laws. Reproduction in part or whole requires express written consent from the publisher.

© Kenya Bankers Association, 2023

# The Greening of Kenya's Banking Sector: Macro-Financial Stability Implications of a Low Carbon Transition

Camilla C, Talam & Lucy Maru

## Abstract

*Against the backdrop of climate-mitigation and green growth policies as well as regulations to account for climate-related risks in the financial sector, this study employs the Computable General Equilibrium model and Merton's Distance to Default model to study the implications of Kenya transitioning to a low carbon economy through introduction of a carbon tax on a carbon intensive sector. The study finds that a carbon tax would result in rise in general prices, and lower investment to GDP. These adverse effects are offset by a rise in real GDP and narrower fiscal and current account balances supported by a rise in government revenue and higher exports in low-carbon intensive sectors. A carbon tax policy would have adverse effects of declining output and income of firms in carbon intensive sectors. These adverse effects are varied which hedges the probability of default of a bank portfolio and allows for natural diversification to mitigate the adverse effects of such a policy for the banking sector. The carbon tax may also increase resilience in low carbon intensive firms where a bank may have exposures thus mitigating the environmental risks for these banks' exposures. From the findings, the paper persuades policymakers to consider a carbon tax rather than an emission trading system as a key carbon mitigation policy.*

**Key words:** Green finance, Transition Risks, Carbon Pricing, Probability of Default

## 1.0 Introduction

**T**he United Nations Environmental Programme (UNEP) defines green finance as financial flows from financial institutions, public and private actors towards addressing environmental and social risks. A narrower definition of green finance as guided by the World Economic Forum (WEF) includes any financing activity that contributes positively to environmental outcomes. This study adopts the narrower definition that green finance is funds towards climate adaptation and mitigation strategies. The scope of this study refers to green finance to support climate-mitigation strategies.

Kenya is geographically placed in an area with varying climatic conditions ranging from highlands to plains to arid regions. 84 percent of the country is classified as semi-arid and arid and 23 out of the 47 administrative units lie in semi-arid and arid areas (Nyanjom, 2014). Thus, climate change has led to unpredictable weather changes and frequent adverse weather conditions that have impacted the economy and the financial sector. The agricultural sector, that contributes one-fifth of the economy's output is the main economic sector directly vulnerable to physical climate risks. Manufacturing and Service sectors are indirectly impacted by these climate risks through their linkage with the agricultural sector, they contribute to the adverse climate changes through their use of inputs that increase GHG emissions. More importantly, manufacturing and service sectors are exposed to transition risks which emerge from climate mitigation policies such as carbon pricing.

Although Kenya contributes only 0.05 percent of global Greenhouse Gas Emissions (GHG), the Kenyan economy has been affected by climate change that has resulted in about 4 percent loss in GDP annually over the past decade and indirect effects from lower agricultural productivity and rising food prices over the past five years. Additionally, floods and drought contribute to 2 – 2.8 percent decline in GDP each year, while drought in the last five years has led to 8 percent GDP loss (GOK, 2018).

The banking sector faces two main climate risks, physical and transition risks. Physical risks arise when an adverse climate event occurs that affects the bank

directly and or indirectly through its counterparties. Physical risks affect banks' collateral and/or its main income through, its counterparties loan repayment. Transition risks arise from an economy moving away from high carbon emission inputs and/or processes to lower carbon emission inputs and/or processes. Transition affects banks' mainly through the cash flows and credit worthiness of its counterparties. Other climate-related risks that banks are continually exposed to include liability risks, litigation risks, reputational risks, and transition risks.

Climate change increases banking sector risks mainly through counterparties. Lower sectoral productivity and output strains firms' cash flows which may lead to greater loan defaults and rising non-performing loans. For banks, the rise in loan defaults leads to a higher migration rate of performing portfolios to nonperforming, which increase loan loss provisions and lower banks' profits. As the banks continually get exposed to these events, the combination of elevated credit risk and lower profitability increase banks' vulnerability to liquidity and solvency risks.

To combat these anticipated effects of climate change, Kenya committed to adopt climate-mitigation policies to reduce its emissions by 30 percent by 2030 in the second National Determined Contribution 2020 (NDC, 2020). In 2011, Kenya launched Africa's first climate exchange, named the Africa Carbon Exchange (ACX). In May 2021, the Kenyan government announced plans to introduce an emissions trading scheme through an announcement by the Cabinet secretary

for the Ministry of Finance during the EU Green Diplomacy webinar (Nyabira et al, 2022). This move is a step in advancing the development of carbon trade market in Africa with Kenya leading the carbon pricing progress in Sub-Sahara Africa except for South Africa. In addition to the emissions trading system., the amendment number 22 of 2022 to Kenya Finance Act introduced carbon tax incentives through a decline in corporate tax for firms operating in the carbon market exchange. The corporate rate for such firms declined from 30 percent ordinary tax rate to 15 percent (Wambua and Gitonga, 2022). Additionally, the banking sector is also taking steps to address these climate risks as they are susceptible to these risks and have a unique financing and resource allocation role to play to mitigate climate-related risks.

Chief among the climate-change mitigation policies is transitioning to a low carbon economy through either a carbon tax or an emissions trading system. Both carbon pricing measures introduces macroeconomic and financial sector risks in the short-term with greater anticipated benefits of minimizing adverse climate change impacts in the long-term. This paper aims to investigate and bring out the macroeconomic and financial stability effects of implementing a carbon tax to persuade policy makers to consider a carbon tax rather than an emission trading system, while taking stock of implementation and status of green finance commitments in the banking sector.

The paper is organized as follows; the introduction provides the context, motivation for the study and

the research objective, the status and trends of green section presents the current status and tracks the progress of climate change policy commitments by banks, the literature review section discusses studies on transition risks and implications for financial stability, the data and methodology section presents the mixed methods applied in the study, the results section presents the results from both methods and summarizes the findings, the paper concludes with recommendations.

### 1.1 Context of Climate Change in Kenya

Temperatures in Kenya have been rising by 1° Celsius over the past 70 years from an average of 24.27° Celsius between 1951 – 1980 to an average of 25.30° Celsius between 1971-2020 (Figure 1). Similarly,

maximum temperatures have risen, and distribution has narrowed (Figure 2). The highest number of days with a high heat index has been observed in the past five years with the most recent incident observed in 2020 (Figure 3). Finally, precipitation has been on a declining trend over the past 70 years with volatility observed in the past two decades (Figure 4). All these indicate that climate change has been occurring in Kenya and its occurrence is becoming more ubiquitous in more recent times. Climate change is increasingly affecting Kenya's economy evidenced by greater incidence of agricultural shocks resulting in more volatile agricultural output that has resulted in a 3-5 percent socio-economic GDP loss annually over the past decade, as the economy derives one-fifth of its output from agriculture as of 2020.

**Figure 1: Mean-Temperature per Decade**

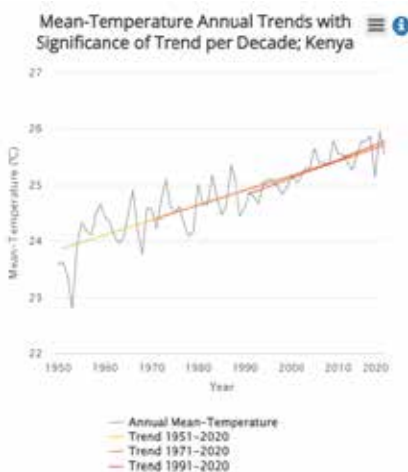

**Figure 2: Change in Distribution of Mean-Temperature**

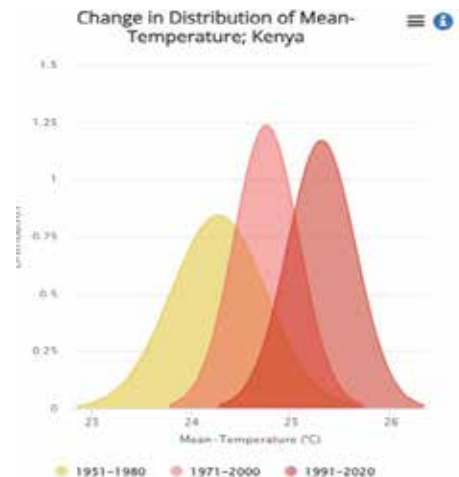

**Figure 3: Days with Heat Index >35°C**

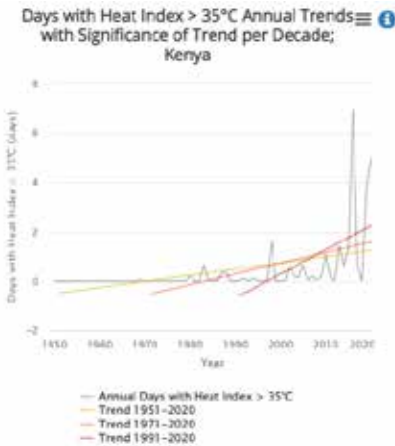

**Figure 4: Precipitation Annual Trends per Decade**

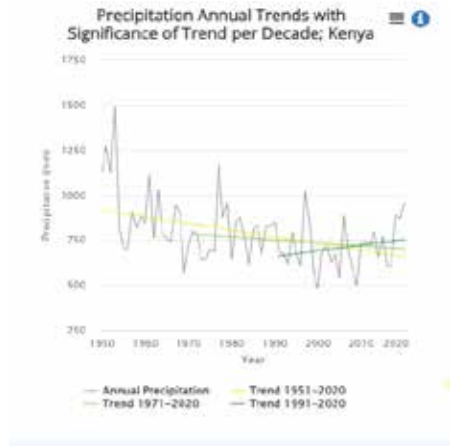

Source: World Bank, Climate Change Knowledge Portal

Between 2020 and 2021, rainfall declined on average by 28 percent, resulting in lower agricultural output. Over a similar period, food inflation doubled from 5.4 percent in the third quarter of 2020 to 10.6 percent in the third quarter of 2021 due to poor rainfall and unfavorable weather conditions, while food vulnerability increased. Macroeconomic data suggests that changing weather conditions observed in the recent past are directly (climate related shocks) or indirectly (inflation and food inflation) increasing incidence of economic shocks (OCHA, 2022; Kogo & Koeh, 2021).

Kenya contributes a very small proportion of Greenhouse Gas (GHG) emissions accounting for 0.05 percent of total global greenhouse gas emissions as of 2020. However, Kenya's GHG emissions have been rising substantially over the past 20 years since 2000 (**Appendix I**). Nonetheless, it is encouraging that Kenya's GHG emissions are mainly consumption driven by oil imports, as cement and coal represent a small proportion of GHG emissions (**Appendix II**). Notable, is the downward trend of the country's annual and per capita emissions driven by lower production-based emissions between 2019 and 2020 (**Appendix II**).



**Figure 8: Greenhouse Gas Emissions by Sector, 2018**

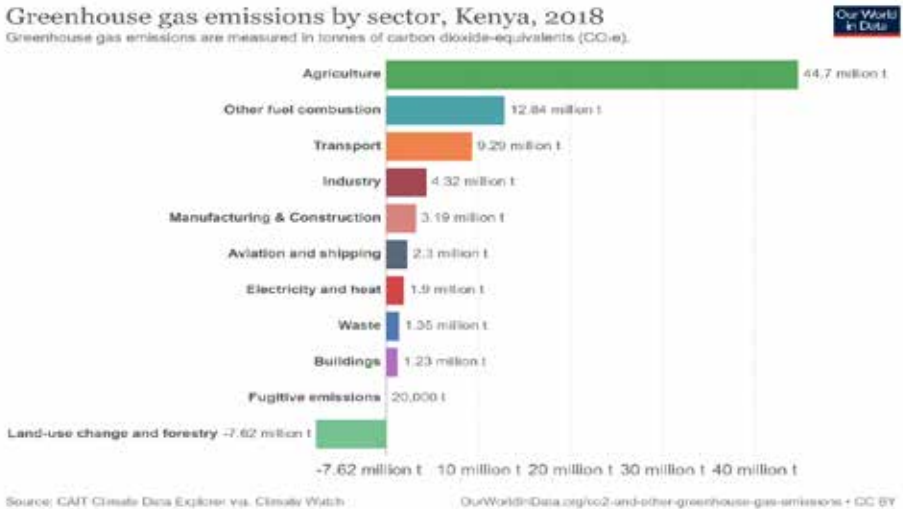

Source: Our World in Data, Global Carbon Project

Distilling into Kenya's GHG emission reveals that majority of GHG emissions have been driven by five main sectors, agriculture, fuel combustion, transport, industry and manufacturing and construction (Figure 8). Agriculture accounts for over half of the country's GHG emissions. The main drivers of high emissions in agriculture are livestock enteric fermentation, fertilizer application and deforestation. Although, fuel emissions are the second highest, their trend is the most concerning as the uptick is driven by oil imports used as inputs in economic activity (NDC, 2020)

Kenya's GDP growth is coupled with its emissions,

and this is reflected in the sectoral contribution to growth where agriculture contributes a fifth of the country's GDP, while the other high emission sectors together with agriculture contribute to over 70% of GDP over the past five years (Figure 8). To achieve Kenya's climate goals as outlined in the National Determined Contribution (NDC), Kenya aims to reduce its emissions by 30 percent by 2030.

To this aim, climate adaptation requires substantial financing (IPCC, 2018) calling for the banking sector to play a role to finance climate-friendly projects with a view to supporting a green economic recovery. Yujun,

Sean, Olaf and Haiying (2018) determined that the financial sector can both promote and hinder a cleaner economy due to the role the financial sector plays in funding all the sectors of the economy. Financial institutions and financial markets exert a dominating influence on the economy (Helleiner 2011) as was evident in the Global Financial Crisis of 2008–2009, prompting the focus on the impact of financial sector on the society and sustainability (Weber 2014).

Currently, the banking sector directs about 27 percent of total credit to these emission intensive sectors as of February 2022. IPCC requires countries globally to decouple growth from carbon intensive sectors to realize global net-zero emissions. This requirement has implications for climate financing that may affect banks in several ways, chief of them being the credit market, asset quality and profitability.

The adverse effects of climate change including loss of life and economic output loss are likely to translate into financial losses with systemic adverse implications for the financial sector. The Financial Stability Oversight Council's 2021 report on climate-related financial risks flags loss of physical assets, property losses, damage to firms and household balance sheets, increased credit defaults and financial sector distress as the key risks likely to occur due to climate change.

To align greening of the economy with the financial sector, the Economic Commission proposed the Green Supporting Factor (GSF) policy on banks by financial sector regulators globally to encourage lower capital

requirements on green investments, which also has implications for climate risks impact on the banking sector (Dombrowskis, 2018). Banks impact the environment through their internal operations and externally through the actions of their borrowers (counterparties), posing physical, transitional and liability risks, therefore, they have an incentive to understand the environmental implications/risks of their lending decisions (Thompson & Cowton 2004). For example, the Comprehensive Environmental Response Compensation and Liability Act (CERCLA) in USA 1980, banks were held responsible for the environmental pollution of their clients (counter parties) and had to pay penalties for the remedial measures. The equator principles also encourage banks to increase the amount of green loans, reduce interest and extend the term of the loans (Wang, Yang, Reisner & Liu 2011).

A key policy to aid in realizing the global net zero emissions to limit global warming to 1.5 °C is carbon pricing (IPCC 2018, IMF 2019). Carbon pricing will have varying effects on firms, sectors, and economic growth. It acts as a form of tax on high carbon intensive goods, changing consumer preferences and thus ideally reducing the demand for carbon intensive goods. Lower demand and higher costs of producing carbon intensive goods disincentivize production of carbon intensive goods and finally lower their supply (Stiglitz et al, 2017). This may result in lower profitability and lower ability of carbon intensive sectors to service their loans. This is likely to result in higher credit risk and possibility of default for banks



exposed to such firms (Dunz et al, 2019; BCBS, 2021). Transitioning to a low carbon economy will also lead carbon intensive assets stranded resulting in higher credit risk and probability of default in the affected sectors (Mo et al, 2021; Coffel and Mankin, 2021). Due to these two effects, banks that are exposed to these firms are likely to face higher credit risk and lower profitability due to higher provisions to account for adverse loan migration and higher asset monitoring costs (Carney, 2015, Lane 2019).

In the banking sector lies unforeseeable risks due to unforeseeable challenges which are economic and environmental in nature, (Dikau and Voltz 2020), therefore credit managers, ought to have the knowledge of the risks associated with green finance and application of green credit risk models in issuing green finance (Krosinsky & Purdom, 2016). As noted by Merton (1989), in the trade of financial intermediation, bundling and unbundling risks is a key feature. Some risks, however, can be identified and avoided through business practices such as under writing standards and due diligence procedures (Allen and Santomero 1998). Banks as intermediators can influence the risk behaviors of their clients (Bowman 2011). Since environmental and financial performance is often seen as a tradeoff, understanding the effects of green lending practices on environmental risk is important.

Therefore, this paper contributes to policy discussion on green finance as well as adding to the body of knowledge on financial stability risks of transitioning

to a low carbon economy in three main ways. Firstly, in terms of the policy discussion, this paper aims to deepen the policy discussion on green finance by tracking the progress that Kenya has made towards green financing. Secondly, this paper aims to encourage policy makers to consider a carbon tax instead of an emissions trading system. Thirdly, this paper aims to contribute to empirical literature by filling a gap on the impact of climate mitigation policies in small open economies. Empirical literature has focused on the climate change effects on economies that significantly contribute to emissions (Noth and Schuwer, 2017; Strobl, 2011; Ullah et al, 2022) and energy exporting economies (Charfeddine and Barkat, 2020; Cosmas, et al., 2019, Kouton, 2019). Studies on developing economies that are impacted indirectly by climate change is limited (Sisay and Kotosz, 2020). This paper aims to fill this gap in the empirical literature on macro-financial stability risks of a low carbon transition from the perspective of a developing economy that is mainly indirectly impacted by climate change and climate change policies despite its minimal contribution. The study aims to provide valuable insights on the effects of a transition risks of climate change and its link to the distance to default of firms, thus aid in the climate-mitigation policy implementation.

## 1.2 Research Objective

The purpose of this study is to determine the macro-financial stability effects of transitioning to a low carbon economy while tracking the status and trends in the uptake of green finance and sustainable finance

in the banking sector in Kenya. The study simulates a direct transition shock via the introduction of a carbon tax on a carbon intensive sector using a Computable General Equilibrium (CGE). The study traces the effect on distance to default of the counter parties as measured using the Merton Model simulating distance to default on key sectors of the economy.

The main research objectives are as follows:

1. To establish the status and trends in the uptake of green finance and sustainable finance in the banking sector in Kenya.
2. To simulate a climate shock on a model of Kenya's baseline economy using the CGE Model.
3. To establish the distance to default of the counter parties due to transition risks as measured using the Merton Model Distance to Default (DD).

## 2.0 The Status and Trends of Green and Sustainable Finance

**T**he sustainability agenda can be traced back to the 1972 Stockholm conference on human environment. This was followed by the Brundtland commission of 1983, which addressed the natural resources depletion and deterioration of the natural environment. The Rio/Earth Summit (held in 1992 in Rio De Janeiro) saw the establishment of the United Nations Framework Convention on Climate Change (UNFCCC) and Agenda 21 and a pivotal global agreement where over 190 countries committed to address climate change. In 1997, the Kyoto Protocol was established during the third conference of parties (COP 3) with the objective of setting limits on greenhouse gas emissions through a legally binding global agreement. The 2015 Paris Agreement brought countries together to commit to non-legally binding agreements via nationally determined contributions toward carbon neutrality to limit temperature raise to below 2 degrees Celsius.

The progress to the global net -zero carbon is uneven. Various countries are at different stages of adopting climate-friendly policies and in particular carbon pricing, and disclosure of climate risks in financing, policies are likely to impact the financial sector. In 2021, World Bank's Carbon Pricing dashboard, indicates that in 2021, 45 countries had adopted either a carbon tax or an Emission Trading System (ETS) to price emissions beyond a certain level or to cap emissions produced. The implication for Kenya is mainly through trade which will feed into economic performance.

The Kyoto Protocol was the first global effort to recognize the role of the banking sector in meeting climate objectives. The 2015 Paris Agreement required that

developed countries channel finance to developing economies to assist in climate mitigation and adaptation. In line with the Paris agreement of 2015, global financial entities made commitments to slow global warming through minimizing GHG emissions. Financial sectors globally committed to the net zero agenda in 2015. As 2020, the implementation progress has been slow. The Climate Policy Initiative (CPI) report estimated Africa would require climate financing of about USD 250 billion between year 2020–2030. However, by 2020, climate financing mobilized to Africa amounted to USD 29.5 billion leaving a significant climate financing gap (Blocher et al 2020). Though there are great opportunities in tapping climate finance funds through new business models and finance products, some of the greatest barriers include, governance barriers, skills, implementation costs, and absence of laws and regulations and a general lack of capacity.

In Kenya, there is consistent effort for climate finance preparedness through appropriate policies and institutional frameworks (Kiremu et al 2021). Further to the efforts to adopt environmental and social governance in Kenya, the Kenyan constitution upholds climate justice and states that every person has a right to a clean environment (GOK 2019). Nevertheless, there still exists a gap in tapping funds for climate mitigation and adaptation as existing mobilization strategies detailed in the National Climate Change Action plan (NCCAP)-2013–2017 are focused more on clean development mechanism. This implies that there is an untapped opportunity for banks to

come up with strategies and financial instruments geared up for mitigation and adaptation finance. Such institutional models and strategies will act as catalysts toward an increased uptake of mitigation and adaptation finance. As noted by Agrawal (2018), local institutions are of great influence in the uptake and use of resources. However, there is still lack of standardization in the policies, budgetary allocation and financial instruments that would be instrumental in the adaptation and mitigation process.

A UNEP 2015 report on green finance in Kenya, highlighted the country's commitment to adopting green finance and green growth, and noted policy gaps that need to be addressed for Kenya to progress in its goal of promoting green investment and green growth. The first step in the policy discussion on green finance and implications of low-carbon transition must begin by taking stock of Kenya's progress in adopting green finance and then tracing out the effects of the transition on the economy and the banking sector.

In the Kenyan market, there is a notable trend in the adoption of sustainable finance. Structured finance and capital market instruments have been introduced in market such as Kenya, South Africa, and Egypt (Blocher et al. 2022). Some financial institutions in Kenya are at an advance stage in floating the Green Bond, through the Kenya Green Bond program, where KBA, NSE, Climate Bonds Initiative (CBI), Financial Sector Deepening (FSD) Africa, FMO-Dutch Development Bank are members.



The Sustainable Finance Institutions (SFI) was established in 2012. The SFI guiding principles and minimum standards were set in December 2015. Notably, SFI is also endorsed by CBK and CMA. To this end, KBA developed an online course on sustainability which was taken by staff across the banks. Banks have also adopted some sustainable development goals. To encourage the Kenyan banking sector in the progress towards adoption of SFI standards, the Kenya Bankers association organized Catalyst Awards to encourage adoption of the principals and standards.

Environmental, social, and corporate governance (ESG) framework was embedded into the Kenyan banking sector in 2012. A baseline survey on ESG adoption in Kenya reveals that in the last five years, 74 percent of financial institutions, majority of which are banks received international funding for ESG. These institutions focused their ESG investments to financing to the manufacturing (68 percent) and service sectors (53 percent). Majority of financial institutions reports that their move to commit to the ESG framework was driven by legislation and regulation as well as pressure from stakeholders. The financial benefits to be accrued in the long-term from adopting the ESG framework also drove some financial institutions to embed ESG into their operations. Legislation served both as a driver and a constraint to ESG integration by financial institutions especially where existing regulation was inadequate and further guidance would be required for practical implementation of the ESG framework. Lack of capacity in terms of skills and commitment

were also reported to constrain ESG implementation. Nonetheless, financial institutions have not only committed to ESG framework but over half of the financial institutions have integrated Environmental and Social management system into their investment strategy. Majority of financial institutions also screened for ESG risks in their corporate loan portfolio in the appraisal stage. In response to limited capacity and knowledge of ESG framework, over half of the respondents trained at least half of their staff on managing Environmental and Social risks.

Notably several banks in Kenya have recently signed the net-zero agreement and have pledged their commitment to implement Article 2C of COP 26. Other notable trends include embracing the use of technology in transactions thus promoting green operations and green products, a minimalist approach in the use of resources through promoting strategies to reduce, reuse and recycle, and re-imagining bank products and processes. Banks have also adopted sustainability reports and integrated reports whose purpose is to provide an account of their environment and social governance actions as they carry out their core business. However, the banking sector requires a targeted approach to climate-mitigation and to determine the role of its stakeholders. Since banks are highly regulated and compliant, the necessary guidelines through a green policy framework will be a key tool in the implementation process of green lending.

## 3.0 Literature Review

**T**he financial sector plays the important role of intermediating between the supply of money and demand for funding by economic agents. When the financial sector is constrained of funds, there is a lower accelerator effect that may limit consumption, production, and the expansion of the economy. The effect may exacerbate into a financial crisis when demand is depressed, and liquidity is withheld/constrained by corporates and households. A climate change mitigation policy to lower emissions may induce a recession and increase the uncertainty of financial sector operations thus raising financial stability concerns (Allen et al., 2012; Fontana and Sawyer 2016; Stern and Taylor 2007).

Climate change may pose financial stability risks emanating from depressed demand, (Aglietta and Espagne, 2016; Batten et al., 2016) and specifically through transition risks (Carbon Tracker Initiative, 2011; Johnson, 2012; Battiston et al., 2017; Stolbova et al., 2018; Trinks et al., 2018).

Specifically, carbon pricing leads to lower demand and higher costs of producing carbon intensive goods which disincentivizes production of carbon intensive goods and finally lowers their supply (Stiglitz et al, 2017). This may result in lower profitability and lower ability of carbon intensive sectors to service their loans and is likely to result in higher credit risk and possibility of default (Dunz et al, 2019; BCBS, 2021). Banks exposed to these firms are likely to face higher credit risk and lower profitability due to higher provisions to account for adverse loan migration and higher asset monitoring costs (Carney, 2015, Lane 2019). As carbon pricing effects are economy wide/sector-side they may result in systemic risks that raise financial stability concerns.

In its intermediation role, the banking sector faces various types of risks. While some of the risks are diversifiable, other risks are systemic and not diversifiable. Such risk which are external affect the activities of the banks directly and indirectly





through their counterparties. Notably such risks may not be hedged through portfolio diversification and therefore the banks are called to rethink their internal processes and the products they offer to reduce the effect of such risks on their profitability and stability.

To assess the effects of climate policies on the financial stability, majority of empirical studies apply macroeconomic models including, Stock Flow Consistent (SFC) models (Dunz et al, 2018; Dafermos et al 2017; Comerford and Spignati 2016), microfounded stress tests (Battison et al, 2017, ECB, 2021), value at Risk models and other asset price focused models. SFC models rely on comprehensive info on financial sector flows, asset prices and availability of firms and household balance sheets. However, the interactions of the macroeconomy and the financial sector in these models is explicit thus not endogenous. Micro-founded stress tests that use network approach (Battison et al, 2017) and the traditional top-down stress tests (ECB, 2021) leverage on the interlinkages in the financial sector. While these are extensive as they provide portfolio level output, they rely on scenarios and satellite models developed outside of the stress test.

Empirical studies on climate mitigation policies have relied on a macroeconomic model to tease out the effects of climate mitigation on the macroeconomy. The Computable General Equilibrium (CGE) model has been popular in the climate change literature.

### 3.1 Theoretical literature

#### Financial Intermediation Theory

Traditional theories of intermediation are based on asymmetric information (Allen and Santomero 1998), however new markets for financial futures and options are difficult to reconcile with traditional financial intermediation theories. As noted by Allen & Gordon 1993, stock prices may reflect economic fundamentals, nevertheless, if intermediaries make decisions on behalf of their investors, bubbles can exist. The existence of a mortgage collateral bubble in 2008 created a financial crisis that resulted in a contagion affecting all sector of the economy. Through the intermediation process, banks are exposed to risk of default through the actions of their counterparties. Athanasogbu et al 2008 stated that banks face lower profitability through loan loss provisions, thus credit risk is measured through loan loss provisions. This proposition is also supported by (Tan and Floros 2012) who stated that there is a negative relationship between banks profitability and credit risk. Therefore, for banks to determine their profitability and stability from time to time, the banks would have in place the tools that would allow them to measure the level of exposure based on the credit risk. According to Adusei 2015, Loan to Asset ratio refers to Credit Risk. When the loan to Asset ratio is high, the bank is indeed exposed to credit risk and therefore a bank's credit risk will have a negative influence on the bank's stability.

## **Stake holder Theory**

A study conducted by Muhamad Ali, Chin, Hong & Pzah (2018), states that the external factors influencing the banks performance include Macro economic factors and the industry specific factors. These factors include tax rate, GDP (Gross Domestic Product) growth, inflation rate, term structure of interest rates and stock market capitalization. As established Roman Daruletius (2013), banks profitability is affected by both banks specific and the external factors. The factors may be classified as the endogenous factors and the exogenous factors. Among the exogenous factors are the factors that affect the full employment of the factors of production in any economy. Climate change as an exogenous factor poses risks which may be broadly classified as physical risks, liability risks and transition risks. Climate risks usually affects the investments and the portfolios of the counterparties that banks usually deal with.

In analyzing transition risks, the assessments include creating what if scenarios. Creating what if scenarios is accepted by the Bank of England and the European Central Bank. Such scenarios would find out the effect of an external shock on the performance and cash flows in the different sectors of the economy.

Based on McKinsey report 2019, banks can look at 5C's in structural analysis which include, company, customer, competitors, and climate. While addressing the 5C's in structural analysis, the banks may conduct a SWOT (strengths, weaknesses, opportunities, and threats). In addressing climate, the banks can post

what if scenarios to determine the effect of a climate related shock on the profitability and cash flows of their counter parties and how this would influence the ability to honor their debt obligation.

## **Theory of adoption**

The theory was developed by E. M. Rogers in 1962. The theory explains how an idea or product gains momentum and diffuses through a specific population or social system. In the banking system, the theory is applicable in confirming how the green lending and sustainable finance practices are diffusing into the different banks to bring about adoption of green lending products, practices and innovations. Being at the apex of the financial system, banks can play the role of innovators in the diffusion process of climate finance by innovatively coming up with new/ innovative green lending products, which can be diffused into the financial system. The theory looks at how institutions adopt to new ways of doing things.

According to a report by Deloitte, banks can address transition risks starting with strategy, underwriting of loans, portfolio management, reporting and disclosures. Banks can also influence their stake holders in the process of transitioning to green processes and technology that enhances the road map to net zero by 2050. Notably, some banks have already adopted PACTA (Paris Agreement Capital Transition Assessment), which assists in the assessment of corporate lending relating to issues around ESG (environmental social and governance).



Based on the empirical studies available, there are several measures that can be used to gauge the risk of default that banks face from time to time. These measures may be classified as either qualitative or quantitative which also are referred to as ordinal scales or cardinal scales. While the standard ratings for corporates can be done through application of scores

such as those provided by Standard and Poor, Moody's and Fisch, most of these measures apply historical data and arrive at a z-score to provide probability of default. The study will be inclined to the use of the Merton Model as a measure of distance to default due to its ability to make use of the projected future outlook of a company.

## 4.0 Research Methodology

**T**he CGE model helps in simulating macro-economic shocks and the influence that such shocks can have on various sectors, economic agents, and key macroeconomic variables. The distance to default is a quantitative measure of the probability of default and thus a useful tool which can provide early signals of financial distress and fragility on different sectors of the economy. Through the application of the two models, policy makers and financial institutions will be better placed to influence the speed and intensity of the transition process to carbon neutral actions and implications on the economy and banking sector. Through careful analysis of the results in the two models the financial institutions may churn a climate related bubble in certain sectors and the emerging climate-oriented sectors of the economy. The study will be useful to the financial institutions in helping them to anticipate policy changes and their macro-financial stability implications.

To derive the benefits of grounding a model in micro foundations, preserving the interlinkages in the economy and across the key economic sectors likely to be impacted by a carbon pricing policy the Computable General Equilibrium (CGE) model is to the preferred model. The CGE model has also been the preferred model in the literature for studying macroeconomic effects of climate change. A further motivation for using the CGE model is the use of readily available information on the macroeconomy i.e. from national accounts where comprehensive balance sheets on the household and corporate sector are unavailable. A further benefit of the use of the CGE model is to examine the effects of climate mitigation on the, counterparties of banks, households and corporates which are the direct channel through which the banking sector is affected.

Although the CGE is useful to assess the macroeconomic effects of climate change, it is deficient in defining an endogenous banking sector, though some studies have modelled a financial sector (Dunz et al 2019). Given the incipient nature of Kenya's banking sector and the related data limitations and the limited price

channel transmissions in the economy, the CGE may not accommodate a banking sector. Drawing from the results of the CGE model on the banking sector's counter parties, Merton's Distance to Default model enables the examination of how climate mitigation policies impact the banking sector through the effect of the counterparties that is captured by the CGE model.

As a result of a carbon tax, carbon intensive sector's output declines by a certain percent. The decline in output is reflected in the firms' operating in the affected sector. Firm x asset prices decline reflecting the lower expected future output, this affects its distance to default and ultimately its probability of default. In the banking book.

### The Computable General Equilibrium Model

To address the second objective, a CGE model is developed to model the baseline Kenyan economy. The CGE will enable the study of the sectoral effects and interlinkages of transition risks to the Kenyan economy through simulating a low carbon transition shock. While Kenya does not have an explicit carbon pricing mechanism, Kenya has adopted excise on fuel products that acts in a similar manner as a carbon price. The CGE model simulates an increase in import duties by increase the tax rate on import by 50 percent. This will be instrumental in enabling analysis of the implication of carbon pricing which is a key effect of the transition.

**Figure 9: Schematic representation of the CGE Model**

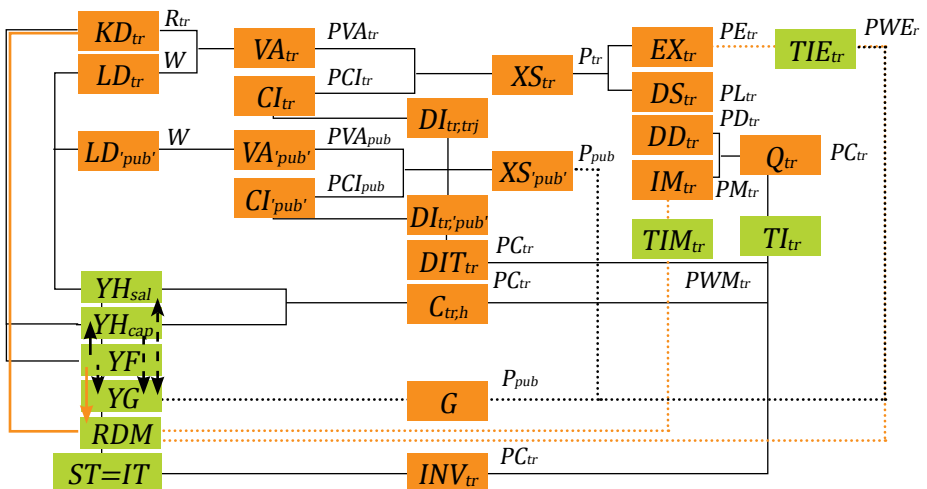

Following the work of Dunz et al, 2019 and Wing 2014, assuming Kenya's excise on fuel to a type of carbon price on fuel, this paper will attempt to track the effects of a carbon price on key sectors to trace out the effect of the carbon price on sectoral output.

The CGE model is a simplified representation of Kenya's economy. National accounts data for 2019 sourced from Kenya Bureau of Statistics is used as the base year for the CGE model. The data is presented in a Social Accounting Matrix (SAM) which provides a simplified profile of the Kenya economy in 2019 at equilibrium. The SAM presents the economy as a baseline, that is, a picture of the Kenyan economy in a typical year that would be considered normal year.

The mathematical model consists of 118 equations, 118 endogenous variables, 23 parameters and 10 exogenous variables (Annex I). The equations explain the behaviour of each flow of income and expenditure in the Kenyan economy that is presented in the SAM. The SAM consists of variables expressed in values, while the CGE model will provide prices and volumes are indices, where only variations relative to one another are important.

The model comprises of four economic agents, i.e. households, firms, government, and the rest of the world. Households are categorized into two, labourers and capitalists, labours provide labour for compensation, while capitalists rent capital. There are two markets, one for goods and services and another factors of production. Two factors of production are used, labour and capital. Four types of goods and

services are produced, and they mirror the four main economic sectors, namely, Agriculture, Manufacturing, Services and Public administration. There four commodities produced (agricultural, manufactures, services and public administration) domestically and three commodities (agricultural, manufactures and services) traded with the rest of the world.

The model features several assumptions about the behavior of the four economic agents that is denoted by the respective parameters. The model assumes a Cobb-Douglas production function in the first level of production, denoted by the parameter alpha, and a Leontief function in the second level of production that tracks the intermediate consumption of inputs between and across the four sectors denoted by the parameters,  $a_{ij}$  and  $i_o$  and the valued added of intermediate production is denoted by parameter  $v$ . The model assumes a proportion of exports out of total output with CET and AE parameters, AE, and a related elasticity for exports to total production with parameters  $\rho_E$  and  $\sigma_E$ . Similarly, the model assumes a proportion of imports to total output, with CES and AM parameters, and a related elasticity for imports to total production with parameters  $\rho_M$  and  $\sigma_M$ . A further assumption is based that households have a propensity to save denoted by  $\mu$ , and households allocate spending on different commodities based on parameter gamma. Capitalist households are assumed to earn income from renting capital denoted by parameter lambda for domestic capitalists and  $\lambda_R$  for capitalists in the rest of the world. The model assumes that the government



taxes exported commodities with a tax rate denoted by parameter  $t_e$ , while imports are charged duties with the tax rate denoted by  $t_m$ . The government also obtains income from imposing indirect taxes on commodities, at a rate denoted by  $t_x$ , while firms and households pay direct income tax to the government denoted by parameters,  $t_{yh}$  and  $t_{yf}$ , respectively.

Parameters values are calibrated and are expected to be consistent with values in the SAM. The mathematical model aims to match the variables with the equations specified to derive results that provide baseline overview of the economy based on the variables provided in the model. Simulations are shocks that are applied to the baseline model to tease out the effects of a shock on the economy.

The Kenyan economy CGE baseline model output including the calibrated parameters are presented in Annex II. Although Kenya does not have an explicit carbon tax or a carbon emission trading system, Kenya has implemented tax on petroleum products at the rate 8 percent.

A shock of 50 percent on imported manufactures is applied to mirror a carbon tax, as fuel and petroleum products are considered manufactures. Kenyan imports all its fuel products hence the shock is applied on the import duty. A robustness test is undertaken using variations of the shock and testing it with monte-carlo testing and range testing to ensure the results in terms of percentages are replicated.

There are five main transmission channels through which the shock would affect the economy. Firstly, the price channel, where an increase in tax rate and import, duties is expected to increase the prices of domestic commodities. Imported manufactured commodities will be more expensive than domestic commodities and relatively more costly than other imported commodities, thus demand for imported manufactures is expected to decline. The price effect maybe muted if the elasticity for imports is price inelastic and if there are no alternatives for imported manufactures e.g., oil. The second transmission channel is production which is expected to decline as input costs rise thus lower demand for manufactured inputs or lower production with the same level inputs. The third channel is income and savings, where income of firms is expected to decline while government income is expected to rise, the final effect depends on the magnitude of other agents' income variations. The fourth effect is total demand and the fiscal impact, where a rise in import tax is expected to increase government revenue. Depending on where the revenue is channeled in terms of government expenditures, the revenue may increase gross output. If the government revenue increases at a rate higher than the rise in government expenditure, holding all other factors constant, the government budget deficit may be reduced. The final channel is the effect on trade and the current account balance where the reduction in imports is expected to lead to a rise in the imports of other imported commodities or a rise in exports to keep the trade account balanced.

**The Merton's Distance to default Model**

The Merton's Model proposed by Robert Merton in 1974 states that the value of a firm may be assessed from the ability of the firm to meet its obligations when they fall due. The Merton Model takes the firms stocks as a European call option---c. The Model also assumes that no dividends are paid out and that the share prices adopt a Brownian motion/Stochastic process. The model also assumes that the prices of the stock do not go below zero. The model checks the distance between the call and the strike. According to the Merton's DD model, assets are equal to liabilities and owner's equity as in equation i. When Assets are greater than liabilities, the model prescribes that an investor should walk away from the option. Assets are assumed to follow a log normal distribution. Shares are assumed to strictly positive, thus the value of the firm is assumed to be strictly positive. In the DD model, the value of the firm is equal denoted by formula ii. At is the value of the firm,  $F(A, T, t)$  is the book value of debt owed by the firm and  $f(A, t)$  is the value of the company's shares.

$$A=L+E$$

$$Assets = Liabilities + Owner's Equity \dots\dots\dots \text{Equation (i)}$$

$$A_t = F(A, T, t) + f(A, t) \dots\dots\dots \text{Equation (ii)}$$

In the Merton's distance to Default model, the shares of the company are treated as a call option on the

outstanding debt at time  $t$ . One of the assumptions of the Merton's Distance to default model is that stock prices follow a random walk/Brownian motion/stochastic process.

Presented arithmetically, the stochastic process or the Brownian motion is presented as follows.

$$dA = \mu AAdt + \sigma AAdz \quad \text{Equation (vii)}$$

The correct value of the share is appropriated for the risk ( $\sigma$ ) and the return ( $\mu$ ). The risk of the share which is also known as the volatility is measured using the standard deviation. The return on the share is the risk-free rate which is obtained from the Central Bank data. The risk-free rate for this case will be the 91-day Treasury bill for each year. This rate was obtained from the Central Bank of Kenya (CBK) bank supervision annual report. The volatility/standard deviation on the shares is calculated using the stock return over a period of 12 months average daily volatility for each year under study.

The stock price will be taken as the average value for the 12 months for each of the years under the study. It will be derived from the market high price and the market low price for each of the stocks under study for each trading days. The above information was sourced from the Nairobi securities exchange.

Default Barrier based on the Merton's distance to





default model is the strike price on the Black Scholes model and therefore where the shares value falls below the value of the debt, the company will easily go into default. The default point also known as the default barrier is firm specific. To calibrate the Merton Model, company books of accounts were obtained from the African financials' website. The audited books provided the company's assets and liabilities. The information derived from the calculated Distance to Default may be used to infer the effect of external economic shocks in a sector with the assumption that all the endogenic factors are constant. Exception is for certain sectors such as the real estate sector where the companies are highly leveraged due to the nature of their business.

Banks can use the Merton Model to conduct annual reviews of their corporate customers as this ensures that the effects of a shock on the sector can be projected early enough to allow banks employ the necessary measure to avert loan loss.

$$E = V_t N(d_1) - Ke^{-r\Delta T} N(d_2)$$

$$d_1 = \frac{\ln \frac{V_t}{K} + \left( r + \frac{\sigma_v^2}{2} \right) \Delta T}{\sigma_v \sqrt{\Delta T}}$$

$$d_2 = d_1 - \sigma_v \sqrt{\Delta T}$$

Where:  $E$  is the theoretical value of the firm,  $t$  is the value of the Company's assets at time  $t$ ,

$K$  is the value of the company's debt,  $t$  denotes the current time period,  $T$  denotes a future time period,  $r$  is the risk-free rate,  $N$  is the cumulative standard normal distribution,  $e$  is the exponential term and  $\sigma$  denotes standard deviation.

## 5.0 CGE Model Findings

**F**ive main results are observed due to a 50 percent shock on manufactures import duty. Firstly, general prices almost doubled, a pass through from imported inflation. Import prices doubled, intermediate producer prices rose by 10 percent, while the rise in import prices was fully passed through to domestic prices which doubled. Secondly, there a net positive effect on intermediate consumption which rose by an average of 50 percent and offset the 10 percent decline in total intermediate consumption. Thirdly, firms' income declined eightfold, and government revenue doubled narrowing the fiscal balance significantly.

The government revenue increase was supported a rise of over 100 percent in import duty and a rise in export taxes by 63 percent. The fourth effect was a tenfold rise in domestic absorption, that offset the threefold decline in household consumption. Finally, international trade expanded as agricultural exports rose, while manufactures and service imports remained the same leading to a 7 percent widening of the current account.

**Figure 10: CGE Model Simulation Results**

Definition	Symbol	Initial value	Simulation	Variation (%)
<b>Indirect shock of carbon tax</b>				
Import duty on Manufacturing	tm('MAN')	0.1	0.15	50
<b>Intermediate consumption price index</b>				
Agriculture	PCI_agr	1.01	1.01	0.09
Manufacturing	PCI_man	1.01	1.01	0.08
Services	PCI_ser	1.01	1.01	0.12
Public administration	PCI_pub		1.01	
<b>Price of imports (including taxes)</b>				
Agriculture	PM_agr	2.55	2.34	(8.12)
Manufacturing	PM_man	1.12	1.14	1.38
Services	PM_ser	2.45	2.45	



Definition	Symbol	Initial value	Simulation	Variation (%)
<b>Price of local sales (including taxes)</b>				
Agriculture	PD_agr	1.03	1.05	1.95
Manufacturing	PD_man	1.02	1.03	1.59
Services	PD_ser	1.00	1.00	
<b>PRODUCTION AND FACTORS</b>				
<b>Total intermediate consumption</b>				
Agriculture	CI_agr	479.00	478.56	(0.09)
Manufacturing	CI_man	2,656.12	2,654.04	(0.08)
Services	CI_ser		3,348.39	
Public administration	CI_pub	326.76	326.43	(0.10)
<b>Intermediate consumption</b>				
Agriculture	DI_agr,agr	109.65	111.60	1.78
	DI_man,agr	615.40	627.40	1.95
	DI_ser,agr	-	792.04	
Manufacturing	DI_agr,man	74.28	75.76	1.99
	DI_man,man	90.16	90.80	0.71
	DI_ser,man	505.99	510.48	0.89
Services	DI_agr,ser	-	644.43	
	DI_man,ser	61.08	61.64	0.92
	DI_ser,ser	279.19	275.16	(1.44)
Public administration	DI_agr,pub	1,534.74	1,515.16	(1.28)
	DI_man,pub	-	1,910.93	
	DI_ser,pub	191.40	189.03	(1.24)

Definition	Symbol	Initial value	Simulation	Variation (%)
<b>INCOME AND SAVINGS</b>				
<b>Income</b>				
Workers	YH_sal	9,132.55	9,132.55	-
Capitalists	YH_cap	9,132.55	9,132.55	-
Firms	YF	3,486.45	526.08	(84.91)
Government	YG	1,386.12	1,498.72	8.12
<b>Receipts from import duties</b>				
Agriculture	TIM_agr	155.86	230.32	47.77
Manufacturing	TIM_man	1,422.48	147.28	(89.65)
Services	TIM_ser	393.16	571.20	45.29
<b>Receipts from export taxes</b>				
Agriculture	TIE_agr	186.76	187.20	0.23
Manufacturing	TIE_man	1,453.39	1,422.48	(2.13)
Services	TIE_ser	393.16	393.16	-
<b>Savings</b>				
Workers	SH_sal			
Capitalists	SH_cap	1,238.48	1,238.48	-
Firms	SF			
Government	SG	(790.26)	(697.12)	(11.79)
<b>DEMAND</b>				
<b>Salaried households - Consumption</b>				
Agriculture	C_agr,sal	323.67	293.86	(9.21)
Manufacturing	C_man,cal	1,945.47	1,927.11	(0.94)
Services	C_ser,sal	3,424.48	3,309.82	(3.35)
Total budget	CTH_sal	8,739.11	8,739.11	-



Definition	Symbol	Initial value	Simulation	Variation (%)
<b>Domestic absorption</b>				
Agriculture	Q_agr	2,831.93	9,040.08	219.22
Manufacturing	Q_man	3,504.38	8,557.01	144.18
Services	Q_ser	6,723.21	21,987.30	227.04
<b>INTERNATIONAL TRADE</b>				
<b>Imports</b>				
Agriculture	IM_agr	155.86	187.20	20.11
Manufacturing	IM_man	1,422.48	1,422.48	-
Services	IM_ser	393.16	393.16	-
<b>Exports</b>				
Agriculture	EX_agr	230.32	230.32	-
Manufacturing	EX_man	147.28	147.28	-
Services	EX_ser	571.20	571.20	-
<b>Current account balance</b>				
CAB	CAB	656.66	657.11	0.07

**Source:** Researchers calculations from GAMS CGE model output

The findings corroborate literature on implications of carbon pricing for various countries globally including Australia, Canada, Ireland and South Africa (Siriwardan et al, 2011; Hamilton and Cameron, 1994; Liu et al 2018; Wissema and Dellick, 2007; Devarajan et al 2011). The rise in general prices supports findings by various studies on carbon tax including Siriwardana et al 2011 on carbon taxes in Australia, who found a 0.75 percent rise in prices, McDougall 1993 on the short run effects of a carbon tax in the same country found a great increase in prices by 1.9 percent, which

mirrors the magnitude in this study. Whereas majority of the literature found a decline in output ranging from 0.68 percent to 1 percent, mainly through a decline in consumption, this study found a 0.5 percent rise in GDP supported by government. The decline in consumption ranging from 2-2.4 percent from empirical literature was comparable to our findings of 3.4 percent consumption decline. The empirics found increase in government revenue which corroborates our findings.

**Figure 11: Macroeconomic Implication of a Carbon Tax**

Definition	Symbol	Initial value	Simulation	Variation (%)
Real GDP - Expenditure approach	GDP_FDO	7,342.00	7,379.36	0.51
<b>INCOME AND SAVINGS</b>				
Government Revenue to GDP	YG/GDP_FDO	18.88	20.31	7.58
Government Spending to GDP	G/GDP_FDO	24.02	23.90	(0.51)
Fiscal balance to GDP	SG/GDP_FDO	(10.76)	(9.45)	(12.23)
<b>DEMAND</b>				
<b>Consumption to GDP</b>				
Consumption to GDP	CO/GDP_FDO	77.55	74.95	(3.35)
<b>Investment to GDP</b>				
Investment to GDP	INVO/GDP_FDO	29.38	29.21	(0.58)
Net Savings to GDP	IT/GDP_FDO	(19.71)	(18.35)	(6.88)
<b>INTERNATIONAL TRADE</b>				
Exports to GDP	EX/GDP_FDO	12.92	12.86	(0.51)
Imports to GDP	IM/GDP_FDO	26.85	27.14	1.08
Current Account Balance to GDP	CAB/GDP_FDO	(8.94)	(8.90)	(0.44)

**Source:** Researchers calculations from CGE Model output

From the CGE model, the impact of a carbon tax affects four main macroeconomic variables, namely, real GDP, government deficit to GDP, investment to GDP and current account balance to GDP. As a result of the 50 percent rise in import duty on manufactures imports, real GDP rose by half a percentage. The fiscal balance narrowed by 12 percent supported by a 7,5 percent rise in government revenue. Investment to GDP narrowed marginally as demand for investment in carbon intensive sectors declined due to the carbon tax. The current account balance to GDP narrowed

marginally supported by the rise in exports in low-carbon intensive sectors.

### 5.1 Merton's Distance to Default Model Findings

The data that was analyzed was data sourced from the Stocks exchange and company books of accounts. The sectors of interest in this analysis were the agricultural and manufacturing sectors. To calibrate the DD and PD for the studied companies, the time period(t) was taken as 1 year. The findings are presented below.



**Figure 12: Distance to Default of a Large Manufacturing Sector firm (EABL LTD)**

Measure Year	Mean Price of stock	Volatility ( $\sigma$ )	RF ( $r$ )	T	Ln(A/L)	DD	PD
2018	197.42	17.35	7.76	1	0.284	9.137	0
2019	189.18	19.59	6.92	1	0.276	10.16	0
2020	163.95	10.93	6.85	1	0.123	6.1	0.001
2021	159.62	15.92	6.96	1	0.211	8.41	0

**Figure 13: Distance to Default of a Manufacturing Sector firm (BAT LTD)**

Measure Year	Mean Price of stock	Volatility ( $\sigma$ )	RF ( $r$ )	T	Ln(A/L)	DD	PD
2018	648.16	73.74	7.76	1	0.45	36.9	0
2019	532.82	56.41	6.92	1	0.699	28.34	0
2020	371.24	62.24	6.85	1	0.940	31.25	0
2021	445.05	24.92	6.96	1	0.931	12.77	0

NB: - The risk free rate ( $r$ ) is taken from the CBK bank supervision reports for the years 2018,2019,2020 and 2021.

The output from the secondary data that was collected from the daily stocks and the company books of accounts is presented for two significant firms in the manufacturing sector (EABL and BAT). The mean prices for the three years for both firms have been declining since 2018. 2020 depicts a global shock that affected both firms value and is comparable to a carbon tax due to its adverse economic effect. A carbon tax that would lead to an eightfold decline in manufacturing sector output is likely to lower output of key firms such as EABL and BAT resulting in lower profits, and lower expected future profits reflected by lower share values. The trend within the sector has

some level of uniformity in the upswings and down swings in the market highs and lows in the daily stock prices. Therefore, the findings may be inferred to other players within the sector even if they are not publicly listed.

However even sectoral shocks have asymmetric effects on firms as seen by the volatility and decline in share values of the two firms. Thus a carbon tax is likely to impact each firm uniquely. The adverse effect of a carbon tax is likely to be diversified across firms thus likely to hedge the default risk on banks' sectoral portfolios.

**Figure 14: Distance to Default of an Agricultural Sector firm (KAKUZI LTD)**

Measure Year	Mean Price of stock	Volatility ( $\sigma$ )	RF (r)	T	Ln(A/L)	DD	PD
2018	334	25	7.76	1	0.799	13.04	0
2019	340	38	6.92	1	0.791	19.31	0
2020	349	30	6.85	1	0.577	15.36	0
2021	381	21	6.96	1	0.544	10.65	0

**Figure 15: Distance to Default of an Agricultural Sector firm (KAPCHORUA LTD)**

Measure Year	Mean Price of stock	Volatility ( $\sigma$ )	RF (r)	T	Ln(A/L)	DD	PD
2018	76.4	8.99	7.76	1	0.483	3.59	0.001
2019	74.24	7.65	6.92	1	0.556	4.1	0.001
2020	78.45	5.44	6.85	1	0.577	4.1	0.001
2021	88.56	6.15	6.96	1	0.544	4.3	0.001

The output from the secondary data that was collected from the daily stocks and the company books of accounts is presented on figure 14 and 15 above, for two significant Agricultural sector firms, Kapchorua and Kakuzi. Both firms share values have been rising over the past four years since 2018. Even considering the COVID shock in 2020, both firms remained resilient, with their share prices gaining value. Both firms had a low distance to default thus pose a low probability of default to banks who may

have exposures to them. This is illustrative of a positive effect of a low carbon transition, where low carbon intensive firms are likely to face higher demand which may prompt higher production and thus higher output and profits, reflected in higher share prices. Although the agricultural sector is vulnerable to the physical effects of climate change, climate smart solutions may increase its resilience, enabling it to benefit from a low carbon transition.



## 6. Conclusion

**T**he implications of a carbon tax as a policy towards moving Kenya to a low-carbon economy are a rise in general prices through imported inflation, and lower investment to GDP. These adverse effects are offset by a marginal rise in real GDP and narrower fiscal and current account balances supported by a rise in government revenue and higher exports in low-carbon intensive sectors.

A rise in demand and intermediate production as demand for low carbon intensive goods increase due a substitution effect. International trade expanded driven by a rise in exports, assuming increased government revenue is channeled to support the low-carbon intensives such as the agricultural sector. The agricultural sector may have benefitted from increasing productivity and output due to its competitive advantage. Although a carbon tax may not lower carbon tensive imports for goods such as oil which have limited alternatives, Kenya's economy benefits from lower twin deficits and greater trade and an expanded economy.

The Merton formula is useful when modelling the distance between the company's value(assets) and the default barrier which is the total exposure of the company in terms of its debt. The model can be used in analysis when increasing the company's debt, increasing the interest rate, or introducing a sectoral policy. This would assist in determining the risk appetite in banks' lending in terms of exposure and sector concentration in the different sectors of the economy. From the findings, the Merton's distance to default indicates that a carbon tax policy would have adverse effects on firms in carbon intensive sectors, though the effects are varied which hedges the probability of default of a portfolio and allows for natural diversification to mitigate the adverse effects of such a policy. The tax may also increase resilience in low carbon intensive firms which a bank may have exposures to thus mitigating the environmental risks of such a portfolio.

Based on the findings, it is evident that external shocks have an influence on the performance of companies but does not influence the sectors in a similar manner. The findings reveal that the volatility on the company assets differ which implies that even within the same sector, *ceteris paribus*, there are other internal fundamentals that determine a company's resilience to systemic shocks. Since the identification of probability of default on counterparties is key to lenders, the DD model by Merton may be used to predict probability of default and anticipate financial difficulties for a period of between 1-1.5 years. DD can also be used to simulate situations when additional debt is applied, when assets are devalued due to anticipated climate shocks, when there is an increase in the cost of factors of production and presence of stranded assets.

This study recommends that policy makers the positive and adverse effects of a low carbon transition and use scenarios in economic policy formulation e.g. determine how scenarios would impact monetary policy in stabilizing anticipated rise in general prices, how fiscal sustainability scenarios could be impacted by a windfall from lower fiscal deficit, *ceteris paribus* and the effect on allocating spending to climate-smart sectors to realize the benefits of a low carbon transition. Additionally, based on the findings from the Merton's model, this study recommends that banks undertake deeper analysis on the effects of a carbon tax on their unique portfolios to identify risks of a low carbon transition, for disclosure and risk management.



## REFERENCES

1. Allen F. & Santomero A. (1998) The theory of financial intermediation *Journal of Banking and Finance*, Vol. 21 1461-1485
2. Basel Committee on Banking Supervision (BCBS). (2021). Climate-related risk drivers and their transmission channels.
3. Batten, S., Sowerbutts, R., & Tanaka, M. (2016). Let's talk about the weather: the impact of climate change on central banks.
4. Battiston, S., Mandel, A., Monasterolo, I., Schütze, F., & Visentin, G. (2017). A climate stress-test of the financial system. *Nature Climate Change*, 7(4), 283-288.
5. Bowman M. (2010). The Role of Banking Industry in Facilitating Climate Change Mitigation and the Transition to a Low Carbon Global Economy *Environmental and Planning Law Journal* Vol.27
6. Carney, Mark J. (2015). Breaking the tragedy of the horizon – climate change and financial stability. Speech at Lloyd's of London, 29 September 2015.
7. Charfeddine, Lanouar and Barkat, Karim, (2020), Short- and long-run asymmetric effect of oil prices and oil and gas revenues on the real GDP and economic diversification in oil-dependent economy, *Energy Economics*, 86, issue C.
8. Chatterjee S. (2015). Centre for Central Banking Studies. *Modelling Credit Risk*. Bank of England.
9. Coffel, E.D. and Mankin, J.S. (2021), "Thermal power generation is disadvantaged in a warming world", *Environmental Research Letters*, Vol. 16 No. 2, pp. 40-43.
10. Cosmas, N.C., Chitedze, I. and Mourad, K.A. (2019). An econometric analysis of the macroeconomic determinants of carbon dioxide emissions in Nigeria. *Science of the Total Environment*, Vol. 675, pp. 313-324.
11. Dafermos, Y., Nikolaidi, M., & Galanis, G. (2017). A stock-flow-fund ecological macroeconomic model. *Ecological Economics*, 131, 191-207.
12. Dikau S. & Volz U. (2019). Central bank mandates sustainability objectives and the promotion of green finances.
13. Dombrovskis, V. (2018). Speech by Vice-President Dombrovskis at the High-Level

- Conference on Financing Sustainable Growth. URL: [http://europa.eu/rapid/press-release\\_SPEECH-18-2421\\_en.htm](http://europa.eu/rapid/press-release_SPEECH-18-2421_en.htm).
14. Dunz, Nepomuk & Naqvi, Asjad & Monasterolo, Irene. (2019). "Climate Transition Risk, Climate Sentiments, and Financial Stability in a Stock-Flow Consistent approach." *Ecological Economic Papers* 23, WU Vienna University of Economics and Business.
  15. Eric Strobl. (2011). The Economic Growth Impact of Hurricanes: Evidence from U.S. Coastal Counties. *The Review of Economics and Statistics* 2011; 93 (2): 575–589.
  16. Government of Kenya (2018). National Climate Change Action Plan (Kenya): 2018–2022. Nairobi: Ministry of Environment and Forestry.
  17. Helleiner E. (2011). Understanding the 2007–2008 Global Financial Crisis: Lessons for Scholars of International Political Economy. *Annual Review of Political Science*, Vol 14 67–87
  18. International Monetary Fund (IMF). (2019). *Fiscal Monitor*, October 2019: How to Mitigate Climate Change.
  19. Intergovernmental Panel on Climate Change (IPCC). (2018). *Global Warming of 1.5°C*. Geneva: IPCC. International Energy Agency (IEA).
  20. Johnson, V. (2012). *Unburnable carbon: rational investment for sustainability*. The New Economics Foundation, London.
  21. Krosinsky C. & Purdom S. (2016). *Introduction: the future of investing is sustainable*. Sustainable Investing
  22. Kogo, B. K., Kumar, L., & Koech, R. (2021). Climate change and variability in Kenya: a review of impacts on agriculture and food security. *Environment, Development and Sustainability*, 23(1), 23–43.
  23. Kouton, Jeffrey. (2019). The asymmetric linkage between energy use and economic growth in selected African countries: Evidence from a nonlinear panel autoregressive distributed lag model. *Energy Economics*, Elsevier, vol. 83(C), pages 475–490.
  24. Lane, Philip R. (2019). Climate Change and the Irish Financial System. *Economic Letter*, Vol. 2019, No. 1.
  25. Leaton, J. (2011). Unburnable Carbon—Are the World's Financial Markets Carrying a Carbon Bubble?. *Carbon Tracker Initiative*, 6–7.
  26. McDonald J. & Stokes H. (2013). Monetary policy, mortgage rates and the housing bubble *Economics and Finance Research* Vol. 1(1) 82–91



27. Merton, R.C., 1989. On the application of the continuous-time theory of finance to financial
28. intermediation and insurance. *Geneva Papers on Risk and Insurance Theory* 14, 225–261.
29. Mo, J., Duan, H., Fan, Y. and Wang, S. (2018), "China's energy and climate targets in the Paris agreement: integrated assessment and policy options", *Economic Research Journal*, Vol. 53 No. 9, pp. 168–181.
30. Nationally Determined Contribution. (2020): Kenya Submission to United Nation Framework of Climate Change (UNFCCC) Secretariat.
31. Ng T. Lye C. Chan K. Lim Y. & Lim S. (2020). Sustainability in Asia: The role of financial development in environmental social governance (ESG) performance. *Social Indicators research* Vol 150(17–44)
32. Noth, Felix and Schüwer, Ulrich, (2017), Natural disasters and bank stability: Evidence from the U.S. financial system, VFS Annual Conference 2017 (Vienna): Alternative Structures for Money and Banking, Verein für Social politik / German Economic Association.
33. Nyabira, B., Muigai J. and Wanjiku A. (2022). Why the emissions trading system is crucial for Kenya. DLA Piper Africa
34. Nyanjom, O. (2014). Remarginalising Kenyan pastoralists: the hidden curse of national growth and development. *African study monographs. Supplementary issue.*, 50, 43–72.
35. Office for the Coordination of Humanitarian Affairs (2022). Kenya – Arid and Semi-Arid Lands Drought Response Dashboard (January 2021 – March 2022). Reliefweb
36. Pyle D. (1971). On the Theory of financial intermediation, *The Journal of Finance* Vol. 26 (3) 737–747
37. Rifat et al. (2016). The role of commercial banks in green lending adoption: a Bangladesh perspective. *International Journal of Green Economics*, Vol 10(3/4) 226–251
38. Sisay Demissew Beyene & Balázs Kotosz (2020) Testing the environmental Kuznets curve hypothesis: an empirical study for East African countries, *International Journal of Environmental Studies*, 77:4, 636–654
39. Stiglitz, J., Stern, N., Duan, M., Edenhofer, O., Giraud, G., Heal, G., Lebre la Rovere, E., Morris, A., Moyer, E., Pangestu, M., Shukla, P., Sokona, Y., & Winkler, H. (2017). Report of the High-Level Commission on Carbon Prices. Technical Report. Carbon Pricing Leadership Coalition.

40. Stolbova, V., Monasterolo, I., & Battiston, S. (2018). A financial macro-network approach to climate policy evaluation. *Ecological Economics*, 149, 239-253.
41. Thompson P. & Cowton C. J. (2004). Bringing the environment into bank lending: Implications for environmental reporting *British Accounting Review* Vol.36(2) 197-218
42. Trinks, A., Scholtens, B., Mulder, M., & Dam, L. (2018). Fossil fuel divestment and portfolio performance. *Ecological economics*, 146, 740-748.
43. Ullah, S., Ali, K., Shah, S.A. et al. (2022). Environmental concerns of financial inclusion and economic policy uncertainty in the era of globalization: evidence from low & high globalized OECD economies.
44. United Nations Environment Program (UNEP). (2015). *Aligning Kenya's Financial System with Inclusive Green Investment*.
45. Wambua C. and Gitonga K. Robert (2022). *Ready for take-off: Kenya introduces a tax incentive for carbon trading*. Kieti Law LLP, Kenya.
46. Wang F. Yang S. Reisner A. & Liv N. (2019). Does green credit policy work in China? The correlation between green credit and corporate environmental information disclosure quality *Sustainability* Vol 11(3)
47. Weber O. & Feltmate B. (2016) *Sustainable banking-Managing the social and environmental impact of financial institutions*. University of London Press.
48. Wing, I (2004). *Computable general equilibrium models for the analysis of energy and climate policies*. International Handbook on the Economics of Energy, Cheltenham, United Kingdom: Elgar.
49. Yannis Dafermos, Maria Nikolaidi, Giorgos Galanis, *Climate Change, Financial Stability and Monetary Policy*, *Ecological Economics*, Volume 152, 2018, Pages 219-234, ISSN 0921-8009
50. Yildirim C. (2002). Evolution of banking efficiency within an unstable macroeconomic environment: the case of Turkish Commercial Banks *Applied Economics* Vol. 34(18) 2289-2301
51. Yujun C. et al. (2018). The impact of green lending on credit risk in China. *Sustainability*, Vol. 10(6)



# APPENDICES

## Appendix 1: Kenya's Annual CO<sub>2</sub> Emissions, 1950 - 2020

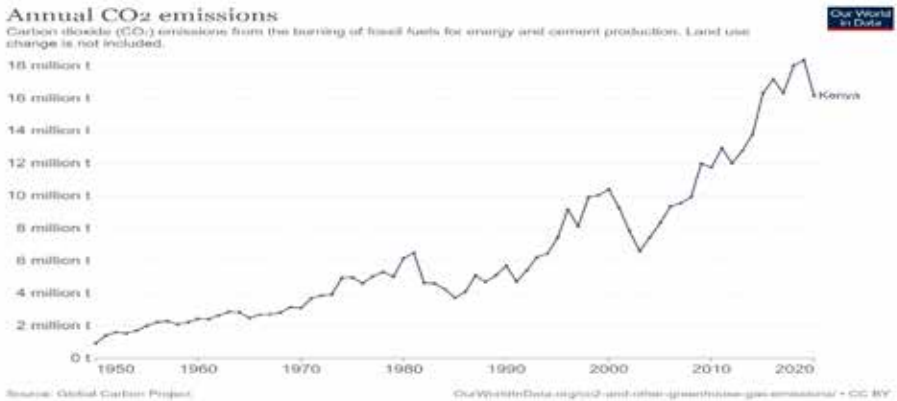

Source: Our World in Data, Global Carbon Project

## Appendix 2: Production vs Consumption base CO<sub>2</sub> Emissions, 1950 - 2020

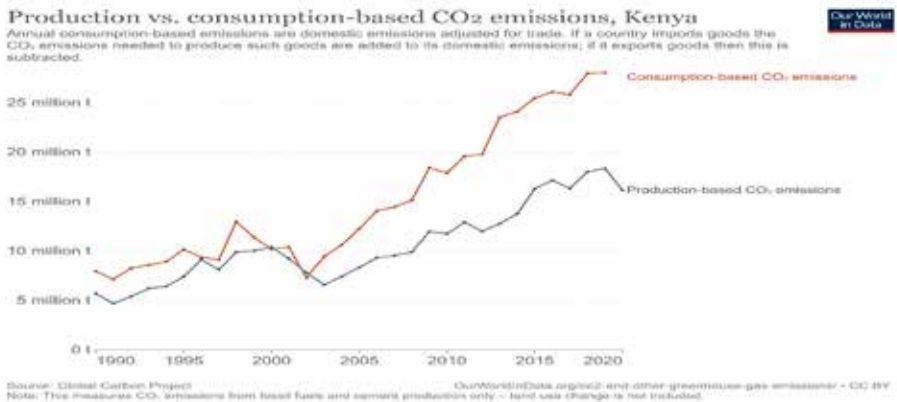

Source: Our World in Data, Global Carbon Project

### Appendix 3: CO2 Emissions by fuel type, 1950 - 2020

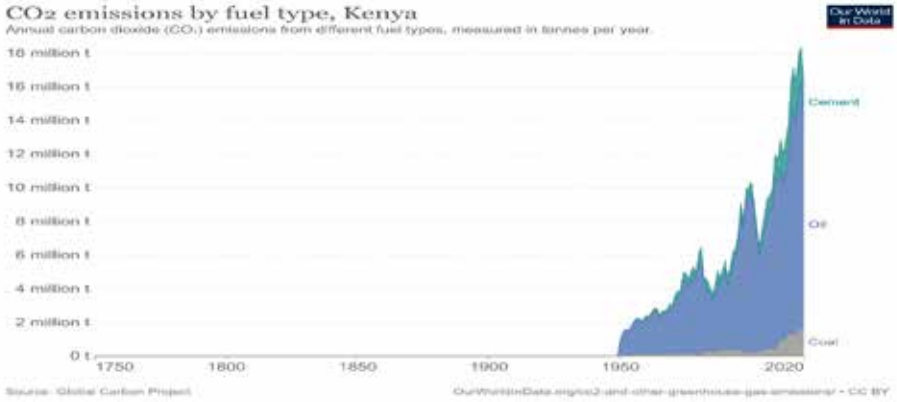

Source: Our World in Data, Global Carbon Project

### Appendix 4: Merton's Distance to Default Random Walk Trend of Share Prices

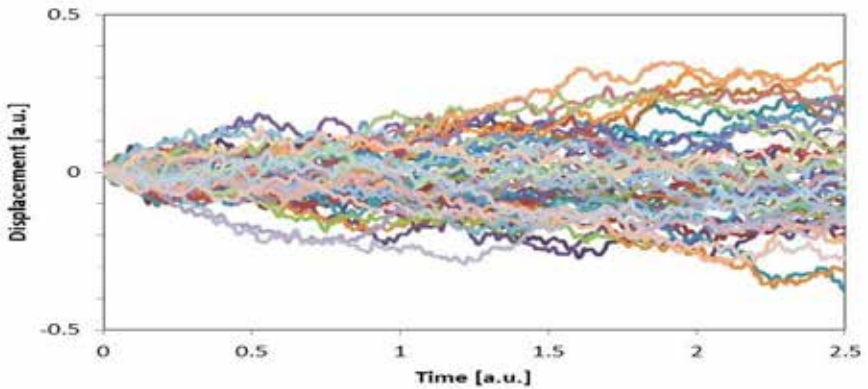





### Appendix 5: Agricultural Sector Stock Prices Trend

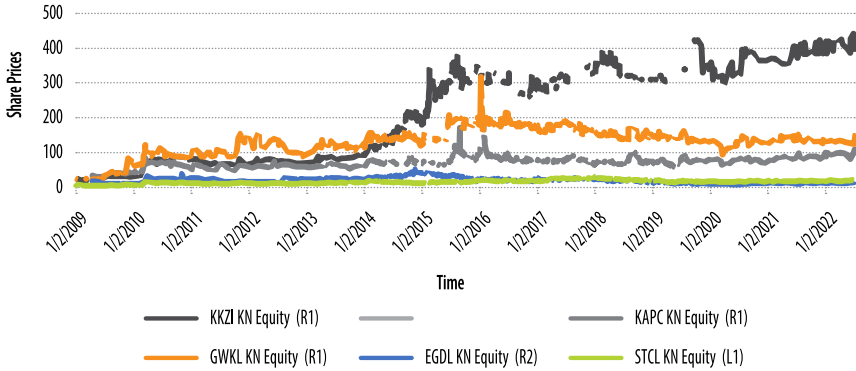

### Appendix 6: Manufacturing Sector Stock Prices From Jan 2009 – July 2022

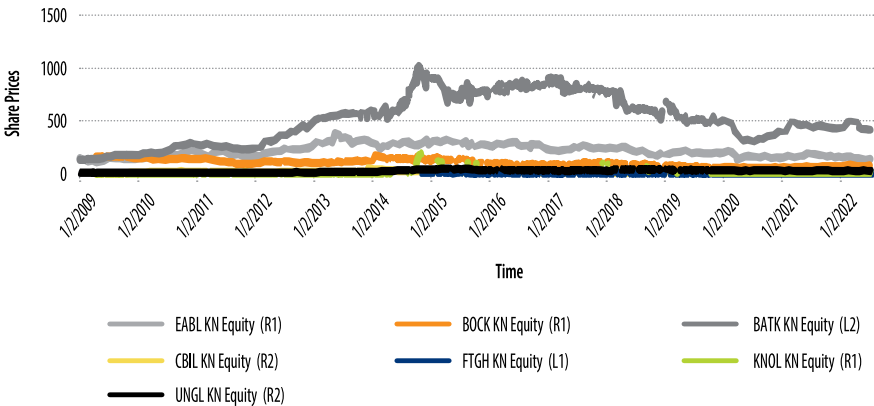

## Annex I

### The Mathematical model

1.  $VA_j = v_j XS_j$
2.  $CI_j = iO_j XS_j$
3.  $VA_{tr} = A_{tr} LD_{tr}^{\alpha_{tr}} KD_{tr}^{1-\alpha_{tr}}$
4.  $LD_{tr} = (\alpha_{tr} PVA_{tr} VA_{tr}) / W$
5.  $KD_{tr} = ((1-\alpha_{tr}) PVA_{tr} VA_{tr}) / R_{tr}$
6.  $LD_{PUB} = VA_{PUB}$
7.  $DI_{ij} = a_{ij} CI_j$
8.  $yH_{SAL} = w * \sum_j DI_{ij} + TG$
9.  $yH_{CAP} = \lambda * \sum_{tr} R_{tr} KD_{tr} + DIV$
10.  $yDH_h = yH_h - DTH_h$
11.  $SH_h = \psi_h yDH_h$
12.  $CTH_h = yDH_h - SH_h$
13.  $YF = (1 - \lambda - \lambda^R) * \sum_{tr} R_{tr} * KD_{tr}$
14.  $SF = YF - DIV - DIV^R - TDF$
15.  $YG = \sum \{TI_{tr} + TIM_{tr} + TIE_{tr}\} * \sum DTH_h + DTF$



16.  $TI_{tr} = tx_{tr} \{ PL_{tr} * DD_{tr} + (1 + tm_{tr}) * e * PWM_{tr} * IM_{tr} \}$
17.  $TIM_{tr} = tm_{tr} * e * PWM_{tr} * IM_{tr}$
18.  $TIE_{tr} = te_{tr} * PE_{tr} * EX_{tr}$
19.  $DTH_h = tyH_h * yH_h$
20.  $DTF = tyf * yF$
21.  $SG = yG - G - TG$
22.  $C_{tr,h} = (Y_{tr,h} CTH_h) / PC_{tr}$
23.  $INV_{tr} = (\mu_{tr} IT) / PC_{tr}$
24.  $DIT_{tr} = \sum_j DI_{tr,j}$
25.  $XS_{tr} = A_{tr}^E [\beta_{tr}^E * EX_{tr} \wedge (\rho_{tr}^E) + (1 + \beta_{tr}^E) * DS_{-tr} \wedge (\rho \wedge (E_{tr})) ] \wedge (1 / (\rho_{tr}^E))$
26.  $EX_{tr} / DS_{tr} = [(PE_{tr} / PL_{tr}) * ((1 - \beta_{tr}^E) / (\beta_{tr}^E))] \wedge (\sigma_{tr}^E) \quad \text{where } \sigma_{tr}^E = 1 / (\rho_{tr-1}^E) > 0$
27.  $Q_{-tr} = A_{tr}^m [\beta_{tr}^m * IM_{tr}^{-\rho_{tr}^m} + (1 - \beta_{tr}^m) * DD_{tr}^{-\rho_{tr}^m}]^{-1 / \rho_{tr}^m}$
28.  $IM_{tr} / DD_{tr} = [(PD_{tr} / PM_{tr}) * ((\beta_{tr}^m) / (1 - \beta_{tr}^m))] \wedge (\sigma_{tr}^m) \quad \text{where } \sigma_{tr}^m = 1 / (1 + \rho_{tr}^m) > 0$
29.  $CAB = e \sum_{tr} PWE_{tr} * EX_{tr} - e \sum_{tr} PWM_{tr} * IM_{tr} - \lambda^R \sum_{tr} R_{tr} * KD_{tr} - DIV^R$
30.  $PVA_{PUB} = W$
31.  $PCI_j = (\sum_{tr} PC_{tr} DI_{tr,j}) / CI_j$
32.  $P_j = (PVA_j VA_j + PCI_j CI_j) / XS_j$

$$33. PD_{tr} = PL_{tr} * CI + tx_{tr}$$

$$34. PM_{tr} = e * PWM_{tr} * (1 + tm_{tr}) * (1 + tx_{tr})$$

$$35. PC_{tr} = (PD_{tr} * DD_{tr} + PM_{tr} * IM_{tr}) / Q_{tr}$$

$$36. PE_{tr} * (1 + te_{tr}) = e * PWE_{tr}$$

$$37. P_{tr} = (PL_{tr} * DS_{tr} + PE_{tr} * EX_{tr}) / XS_{tr}$$

$$38. PINDEX = (\sum_j PVA_j * VA_j^o) / (\sum_j PVA_j^o * VA_j^o)$$

$$39. Q_{bns} = \sum_h C_{h,bns} + DIT_{bns} + INV_{bns}$$

$$40. XS_{bns} = h / P_{PUB}$$

$$41. DS_{tr} = DD_{tr}$$

$$42. LD = \sum_j LD_j$$

$$43. KS_{tr} = KD_{tr}$$

$$44. IT = \sum_h SH_h + SF + S_h - CAB$$



## ANNEX II: Social Accounting Matrix

		F	F	AG	AG	AG	AG	AG	I	I
		LD	LD	SAL	CAP	FIRM	GOV	ROW	AGR	MAN
F	LD								182.36	691.18
F	LD								1,953.35	1,042.12
AG	SAL	2,960.37					75.89	375.21		
AG	CAP		6,637.66							
AG	FIRM						251.39	274.69		
AG	GOV			333.44		235.29	104.70	45.50		
AG	ROW					290.79				
I	AGR									
I	MAN									
I	SER									
I	PUB						1,763.86			
J	AGR			264.47						
J	MAN			1,939.36						
J	SER			3,351.33						
J	PUB			385.21						
X	AGR							230.32		
X	MAN							147.28		
X	SER							571.20		
OTH	ACC				1,238.48		(697.12)	649.44		
OTH	TOT	2,960.37	6,637.66	6,365.82	1,238.48	526.08	1,498.72	1,498.72	2,135.71	1,733.30

I	I	J	J	J	J	X	X	X	OTH	OTH
SER	PUB	AGR	MAN	SER	PUB	AGR	MAN	SER	ACC	TOT
1,674.54	412.29									2,960.37
3,513.11	129.08									6,637.66
										3,411.46
										6,637.66
										526.08
		79.73	54.04	272.32	34.56	30.84	183.38	64.92		1,498.72
						187.20	1,422.48	393.16		2,293.62
		112.83	633.22	799.32	76.44				513.90	2,135.71
		91.57	513.91	648.71	62.03				417.07	1,733.30
		279.19	1,534.74	1,935.47	191.40				1,246.85	5,187.65
		30.01	161.92	204.03	20.79				124.62	2,305.22
										296.47
										1,939.36
										3,351.33
										385.21
										230.32
										147.28
										571.20
										1,190.80
5,187.65	541.37	593.33	2,898.4	3,89.85	385.21	218.04	1,605.87	245.07	2,302.44	

**Kenya Bankers Association**

13th Floor, International House, Mama Ngina Street

P.O. Box 73100– 00200 NAIROBI

Telephone: 254 20 2221704/2217757/2224014/5

Cell: 0733 812770/0711 562910

Fax: 254 20 2221792

Email: [research@kba.co.ke](mailto:research@kba.co.ke)

Website: [www.kba.co.ke](http://www.kba.co.ke)



**KENYA BANKERS**  
ASSOCIATION

One Industry. Transforming Kenya.