

Will, Christian et al.

Working Paper

Can electric vehicle charging be carbon neutral? Uniting smart charging and renewables

Working Paper Series in Production and Energy, No. 69

Provided in Cooperation with:

Karlsruhe Institute of Technology (KIT), Institute for Industrial Production (IIP)

Suggested Citation: Will, Christian et al. (2023) : Can electric vehicle charging be carbon neutral? Uniting smart charging and renewables, Working Paper Series in Production and Energy, No. 69, Karlsruhe Institute of Technology (KIT), Institute for Industrial Production (IIP), Karlsruhe,
<https://doi.org/10.5445/IR/1000158369>

This Version is available at:

<https://hdl.handle.net/10419/271091>

Standard-Nutzungsbedingungen:

Die Dokumente auf EconStor dürfen zu eigenen wissenschaftlichen Zwecken und zum Privatgebrauch gespeichert und kopiert werden.

Sie dürfen die Dokumente nicht für öffentliche oder kommerzielle Zwecke vervielfältigen, öffentlich ausstellen, öffentlich zugänglich machen, vertreiben oder anderweitig nutzen.

Sofern die Verfasser die Dokumente unter Open-Content-Lizenzen (insbesondere CC-Lizenzen) zur Verfügung gestellt haben sollten, gelten abweichend von diesen Nutzungsbedingungen die in der dort genannten Lizenz gewährten Nutzungsrechte.

Terms of use:

Documents in EconStor may be saved and copied for your personal and scholarly purposes.

You are not to copy documents for public or commercial purposes, to exhibit the documents publicly, to make them publicly available on the internet, or to distribute or otherwise use the documents in public.

If the documents have been made available under an Open Content Licence (especially Creative Commons Licences), you may exercise further usage rights as specified in the indicated licence.

Can electric vehicle charging be carbon neutral? Uniting smart charging and renewables

Christian Will, Daimler Truck AG, Florian Zimmermann, IIP, KIT, Axel Ensslen, E-Star Trading GmbH, Christoph Fraunholz, IIP, KIT, Patrick Jochem, DLR, Dogan Keles, DTU

No. 69 | February 2023

WORKING PAPER SERIES IN PRODUCTION AND ENERGY



Can electric vehicle charging be carbon neutral?

Uniting smart charging and renewables

Christian Will, Florian Zimmermann, Axel Ensslen, Christoph Fraunholz, Patrick Jochem, Dogan Keles

Chair of Energy Economics, Institute for Industrial Production (IIP) at the Karlsruhe Institute of Technology (KIT),
Herzstr. 16, building 06.33, 76187 Karlsruhe,
email: christian.will@partner.kit.edu

Abstract

Growing numbers of plug-in electric vehicles in Europe will have an increasing impact on the electricity system. Using the agent-based simulation model PowerACE for ten electricity markets in Central Europe, we analyze how different charging strategies impact price levels and production- as well as consumption-based carbon emissions in France and Germany. The applied smart charging strategies consider spot market prices and/or real-time production from renewable energy sources.

While total European carbon emissions do not change significantly in response to the charging strategy due to the comparatively small energy consumption of the electric vehicle fleet, our results show that all smart charging strategies reduce price levels on the spot market and lower total curtailment of renewables. Here, charging processes optimized according to hourly prices have the strongest effect. Furthermore, smart charging strategies reduce electricity purchasing costs for aggregators by about 10% compared to uncontrolled charging. In addition, the strategies allow aggregators to communicate near-zero allocated emissions for charging vehicles. An aggregator's charging strategy expanding classic electricity cost minimization by limiting total national PEV demand to 10% of available electricity production from renewable energy sources leads to the most favorable results in both metrics, purchasing costs and allocated emissions. Finally, aggregators and plug-in electric vehicle owners would benefit from the availability of national, real-time Guarantees of Origin and the respective scarcity signals for renewable production.

Can electric vehicle charging be carbon neutral? Uniting smart charging and renewables

Christian Will^{1,2}, Florian Zimmermann¹, Axel Ensslen^{1,5}, Christoph Fraunholz¹, Patrick Jochem^{1,3}, Dogan Keles⁴

1 Karlsruhe Institute of Technology (KIT), Institute for Industrial Production (IIP), Chair of Energy Economics, Hertzstr. 16, 76187 Karlsruhe, Germany

2 Daimler Truck AG, Fasanenweg 10, 70771 Leinfelden-Echterdingen, Germany

3 German Aerospace Center (DLR), Institute of Networked Energy Systems, Department of Energy Systems Analysis, Curiestr. 4, 70563 Stuttgart, Germany

4 Technical University of Denmark (DTU), Produktionstorvet B424, 2800 Kgs. Lyngby, Denmark

5 E-Star Trading GmbH, Albert-Nestler-Str. 19, 76131 Karlsruhe, Germany

Highlights

- Agent-based simulation of ten European electricity markets in Central Europe
- Simulating millions of EV under four different smart charging strategies by 2030
- Impacts of prices, curtailment, production- and consumption-based emissions
- All charging strategies reduce spot market prices and total renewable curtailment
- Charging with renewables in real-time minimizes purchasing costs for aggregators

Abstract

Growing numbers of plug-in electric vehicles in Europe will have an increasing impact on the electricity system. Using the agent-based simulation model PowerACE for ten electricity markets in Central Europe, we analyze how different charging strategies impact price levels and production- as well as consumption-based carbon emissions in France and Germany. The applied smart charging strategies consider spot market prices and/or real-time production from renewable energy sources.

While total European carbon emissions do not change significantly in response to the charging strategy due to the comparatively small energy consumption of the electric vehicle fleet, our results show that all smart charging strategies reduce price levels on the spot market and lower total curtailment of renewables. Here, charging processes optimized according to hourly prices have the strongest effect. Furthermore, smart charging strategies reduce electricity purchasing costs for aggregators by about 10% compared to uncontrolled charging. In addition, the strategies allow aggregators to communicate near-zero allocated emissions for charging vehicles. An aggregator's charging strategy expanding classic electricity cost minimization by limiting total national PEV demand to 10% of available electricity production from renewable energy sources leads to the most favorable results in both metrics, purchasing costs and allocated emissions. Finally, aggregators and plug-in electric vehicle owners would benefit from the availability of national, real-time Guarantees of Origin and the respective scarcity signals for renewable production.

Keywords

Energy system analysis; Electric mobility; Smart charging; Electricity markets; CO₂ emissions; Renewable energies

1. Introduction

Transport is responsible for about 23% of total energy-related CO₂ emissions worldwide. Its emissions will continue to grow until 2030 under announced policies, overshooting the goal towards a net-zero approach by 2050 by almost 30% (IEA, 2021). In Europe, transportation is the only sector where emissions have increased between 1990 and 2018 (EEA, 2020). Consequently, road transport as the main source of emissions within the transport sector must contribute to a large extent to the emission reductions by, for instance, shifting from fossil fuels to electric-drive vehicles, i.e., plug-in electric vehicles (PEV, both purely electric and plug-in hybrid) (Creutzig et al., 2015). Globally, fast PEV-adoption could lead to the best use of the remaining carbon budget (Märtz et al., 2021).

However, shifting road transport-specific CO₂ emissions from transport to the power sector might increase CO₂ emissions in the power sector. Consequently, generation from renewable electricity sources (RES) must increase in stride with growing PEV sales. Strategies need to be developed with regard to how PEV could be integrated effectively and efficiently into competitive electricity markets in order to support decarbonization of the system (Parag and Sovacool, 2016). As a first step, e.g., Germany and Austria tied public funding schemes for charging infrastructure to the exclusive use of renewable electricity (BMK, 2020; BMVI, 2021). This is facilitated through well-established renewable electricity contracts: Energy suppliers buy electricity and Guarantees of Origin (GoO) from the wholesale market to create a “green electricity contract”. Such solutions have often been criticized for intransparency (e.g., Herbes et al., 2020), which gives rise to further considerations on differentiation and quality of green electricity contracts (Salah et al., 2017; Will et al., 2017b; Fabianek et al., 2020).

One component of green electricity contracts may be the provision of renewable electricity in real-time. While GoO bear a time-stamp of their creation, most classic green electricity contracts balance consumption and provision over an entire year. Real-time contracts limit the viability of GoOs to only the hour they were generated, creating a closer tie between the availability and consumption of renewables. If consumption and generation of renewable electricity coincide, no emissions are being relayed to other consumers. At the same time, scarcity signals for renewable supply are communicated to market actors much more tangibly (Will et al., 2017a). Therefore, Eurelectric (2022) has initiated a task force for the increased use of real-time renewable electricity supply in the industry and first market platforms for real-time electricity certificates have been defined and initialized¹. Meanwhile, the US federal government pursues half of its direct electricity consumption to be serviced pollution-free and in real-time by 2030 (White House, 2021). Furthermore, companies such as Mercedes-Benz, Google, or Microsoft, have already contracted real-time renewable electricity for their European operations (Douglas and Hunt, 2021).

The challenge with real-time supply of renewable electricity is how to cover demand in times of low production from volatile sources like photovoltaic (PV) and wind (Gohla-Neudecker et al., 2011). To counteract this volatility, flexible consumers may shift their consumption to times of high RES supply, therefore more actively minimizing their contribution to carbon emissions. Simulating and shifting hourly PEV charging processes according to different charging strategies fuels a discussion on isolated, national, and international effects of this real-time coupling. E.g., such charging strategies could help avoid curtailment of RES generation. Conversely, the strategies could be harmful if emissions are shifted to other hours, i.e. if increased generation from fossil-fueled power plants or imports are used to charge the PEV. In addition to comparing emissions from a system perspective, we also show in how far aggregators may justify claims of carbon neutrality for their real-time electricity contracts.

¹ www.energytag.org/

Meanwhile, how exactly emissions from fossil electricity generation should be allocated to PEV consumption is subject to political and academic debate (e.g., Xu et al., 2020; Kessler, 2021), as it is fundamental to the role that PEV play in climate change mitigation and respective preventative regulation. The literature applies various allocation methods, differing in approach, temporal, spatial, or physical parameters. For example, in addition to the emissions from national generation facilities, more consumption-centric approaches include the cross-border effects of electricity export and import flows. This consumption-centric perspective promises a better understanding of different stakeholders' roles, e.g., the significance of PEV. Ultimately, PEV users may help integrate renewables and, therefore, further reduce emissions.

The overarching goal of this paper is to understand the impact of smart charging strategies on the entire power system, especially on electricity prices and on related emissions. Based on the example of the French and German electricity system, it particularly investigates how PEV charging exclusively from real-time RES generation would impact the electricity market and the overall system emissions. The study also compares the effects of charging strategies under consideration of various emission allocation approaches.

Following these research objectives, in this article, the following research questions are answered:

RQ1: What are the impacts of different PEV charging strategies on electric power systems?

RQ2: What are the impacts of different PEV charging strategies on CO₂ emissions?

RQ3: Can charging PEV, facilitated by an aggregator, be carbon neutral?

The paper is structured as follows: Section 2 discusses related work and derives the research questions. Section 3 introduces the applied simulation framework, PEV scheduling algorithms and considered measures for carbon emissions. Section 4 discloses base data and key assumptions for the simulation. Simulation results are shown in two subsections in Section 5, respectively, for the energy market and carbon emissions. How far PEV can be considered carbon-neutral is comprehensively discussed in Section 6. Section 7 concludes and motivates fields for future research.

2. Related work

Several studies quantifying the environmental impacts of PEV have been carried out in recent years (e.g., Bekel and Pauliuk, 2019; Xia and Li, 2022). The resulting emission factors vary considerably depending on methodological and spatial framework conditions (Ryan et al., 2016). Particular in focus were life cycle analyses (LCA) of PEV usage in Europe (Hawkins et al., 2013) or individual countries, e.g., Australia (Sharma et al., 2013), Belgium (Rangaraju et al., 2015), England and California (Ma et al., 2012), Germany (Bickert et al., 2015), Greece (Chatzikomis et al., 2014), Italy (Donateo et al., 2015), France, Poland and Portugal (Faria et al., 2013), as well as Scotland and Slovenia (Muneer et al., 2015). Meanwhile, many studies focus on PEV-specific use phase-CO₂ emissions and distinguish between different measurement methods: (1) the annual average emission mix, (2) the time-dependent average electricity mix, (3) the marginal electricity mix, and (4) balancing emissions from electricity generation with other CO₂ emission reductions. Most studies focusing on use phase-emissions – as well as most carbon mitigation policies – take average values for one year of a specific energy mix (Doucette and McCulloch, 2011; Plötz et al., 2017; Woo et al., 2017). Others use time-dependent average emissions (Robinson et al., 2013; Ensslen et al., 2017; van Fan et al., 2022) or marginal emissions (Ma et al., 2012; Jochem et al., 2015; Kamiya et al., 2019). An increasing number of authors are pointing to the importance of accounting for marginal emissions from electricity systems (e.g., Yuksel et al., 2016; Li et al., 2017; Khan, 2018) and specifically for evaluating PEV (Tamayao et al., 2015).

Significant differences between countries' carbon intensity of PEV charging can be observed based on the carbon intensity of the electricity mix. Usually, CO₂ emissions are calculated based on emissions at the national level. Exchange flows between countries are mostly not considered. However, potential imports from high-emitting neighboring countries might considerably affect emissions the importing country is responsible for. In fact, production- and consumption-based CO₂ emissions deviate significantly for some OECD countries (Soimakallio and Saikku, 2012; Barrett et al., 2013), potentially linked to differing energy efficiency in electricity generation or import rates (Franzen and Mader, 2018). Following Peters (2008), however, consumption-based inventories provide considerable insight into the effects of climate policy and mitigation, and consumption-based national emission indicators could play an increasing role in future climate policy. According to Barrett et al. (2013), consumption-based emissions are an essential reminder of the global challenge of climate change, i.e., that individual actions have large implications in interconnected systems. Going further, Olkkonen and Syri (2016) identify marginal electricity generation units and, subsequently, the marginal CO₂ emissions of electricity in the Northern European energy system focusing on Finland, Sweden, Norway and Denmark up to 2030. Their results show that marginal generation in isolated national systems is becoming outdated in the integrated European electricity market. They conclude that the marginal electricity generation in the larger international system should also be considered. Furthermore, they recommend using long-term perspectives when estimating marginal consequences of demand-side interventions that might influence the energy system in the long-term. Similar results can be found in the interconnected market of the United States (Graff Zivin et al., 2014; Tamayao et al., 2015). Smart charging of PEV is one such demand-side intervention and in the following we compare marginal production- and consumption-based emissions under different charging strategies. This research builds on a larger body of environmental multi-region input-output accounting (e.g., Turner et al., 2007; Wiedmann et al., 2007; Wiedmann, 2009; Vetóné Móznér, 2013; Malik et al., 2018).

While the carbon-free generation of fluctuating RES, such as wind and PV, decreases electricity carbon intensity, high-penetration RES scenarios are challenging power systems. Meanwhile, too many PEV charging simultaneously can significantly strain low-voltage grids (Haider and Schegner, 2021). Reviews on PEV interacting with smart grids and RES under various charging strategies are provided by Mwasilu et al. (2014) and Richardson (2013). Different smart charging strategies for efficiently integrating PEV into the power system, including RES², are tested in different regions: Dallinger and Wietschel (2012) and Juul and Meibom (2011) apply cost-minimizing charging strategies for Germany and Denmark. Heinrichs and Jochem (2016) discuss the benefits of smart charging for the German energy system until 2030. Bellekom et al. (2012) deploy different load management strategies concerning shapes of charging power, intending to integrate wind energy in the Netherlands better. Ekman (2011) maximizes the utilization of wind power for the case of Denmark by charging when wind power production minus power consumption is highest or when there is excess wind power. Faria et al. (2014) minimize load peaks by flattening the load profile while minimizing the environmental impacts in Portugal. Peças Lopes et al. (2009) discuss different charging strategies to integrate as many PEV as possible into the Portuguese power system. In 2050, PEV with uni- and bidirectional charging throughout the EU could reduce transport LCA emissions by 40% or 51%, respectively (Xu et al., 2020). With a more local focus, Pearre and Swan (2016) use a charging strategy intending to avoid the usage of transmission capacities for the case of Digby, Nova Scotia, Canada. Similarly, Doluweera et al. (2020) focus on the state of Alberta, Canada. Overall, the studies show that introducing PEV supports better usage of RES and can potentially increase the amount of fluctuating RES capacities installed in regional or national electricity systems. Furthermore, PEV can absorb excess energy production of fluctuating

² For an overview of charging scheduling algorithms cf. Wang (2022), Hu et al. (2016), Huber et al. (2019), García-Villalobos et al. (2014), or Unterluggauer et al. (2022).

RES that would otherwise be wasted or curtailed (Peças Lopes et al., 2009; Ekman, 2011; Bellekom et al., 2012; Dallinger and Wietschel, 2012; Faria et al., 2014). Specifically, Gnann et al. (2018) estimate the excess renewable electricity that can be integrated through PEV smart charging at 25-30%. In the following we go further and compare multiple charging strategies: uncontrolled, (spot) price-based as well as two strategies based on the hourly availability of RES.

In this context, the role of intermediaries might support the pooling of distributed flexibilities from PEV charging (Nielsen and Alkemade, 2016; Ringler et al., 2016). Demand response provides a perfect opportunity for PEV aggregation agents to use smart charging to reduce costs (Gonzalez Vaya and Andersson, 2015) and, therefore, increase aggregator profits (Shafie-khah et al., 2016). Several case studies support this result for different regions of the world: Schill (2011) studies the effect of PEV on an imperfectly competitive German electricity market and shows that consumers benefit from PEV if excess battery capacity can be used for grid storage. Perez-Diaz et al. (2018) propose coordination and payment mechanisms for PEV aggregators, substantially reducing bidding costs in a case study of the Iberian Peninsula. Ensslen et al. (2018) develop a load shift-incentivizing electricity contract for PEV users. Their case study for French and German electricity markets shows that the contract is suitable for incentivizing vehicle users to provide load flexibilities. This consequently increases aggregators' contribution margins.

Many of these studies on smart charging consider PEV a flexible load that can freely respond to the needs of the distribution grid or environmental goals. For example, Huber et al. (2021) apply a forecast of marginal carbon emission factors for the smart scheduling of PEV charging, which, if adhered to, can lead to emission savings in Germany between 1-10%. While early adopters of PEV appear to be motivated to respond to such "communal incentives" (Will and Schuller, 2016), it could be challenging to convince less involved customer groups to restrict their mobility behavior (cf. Will et al., 2022). Since direct control of charging processes at home through a central planner may be perceived as invasive, research on approaching differentiated customer groups with attractive smart charging services is gaining more attention. Salah et al. (2017) provide a general overview of energy services for the differentiation of power products, e.g., specification of power source or a direct coupling of volatile production and demand through balancing real-time power consumption. Based on this categorization and drawing from established literature on green electricity contracts, Will et al. (2017b) characterize and discuss a range of quality attributes for green charging services. They evaluate two particular services: a reactive balancing service and an active balancing service, i.e., utilizing smart charging. Both strongly focus on the hourly balancing of supply and demand by an aggregator controlling PEV charging events through financial steering signals.

However, the question remains if such services create benefits when aggregated on the system level. Considering consumers' low involvement in electricity purchase (e.g., Watson et al., 2002) and the resulting lack of awareness of differentiated sustainability criteria (Lehmann and Beikirch, 2020; Will et al., 2022), facilitating the coupling of RES provision and PEV demand requires a simple, transparent metric. At the same time, the dynamics of RES supply and PEV demand must be honored. Therefore, we investigate different charging strategies, one of which targets the availability of RES. It remains to be seen if the aggregate response of individual PEV to the availability of RES production impacts carbon emissions on a national or supra-national scale. To the best of our knowledge, we are the first to combine in equal parts analysis of future PEV-specific CO₂ emissions focusing on production- and consumption-based calculations of national emission factors derived from different PEV charging strategies. Following the recommendations of Olkkonen and Syri (2016), we consider the effects on CO₂ emissions from the long-term effects of smart PEV charging in closely interconnected European electricity markets. We report the findings for the cases of France and Germany as the largest economies with fundamentally different power plant portfolios but similar PEV ramp-up. Furthermore,

no studies have been published tackling whether carbon-neutral charging of national electric vehicle fleets is possible mid-term, i.e., in 2030.

3. Research design

The agent-based approach can be used to model individual actors who, on the one hand, make individual decisions and, on the other hand, interact with each other via markets (e.g., Tesfatsion, 2002). Therefore, agent-based modelling and simulation can deliver valuable insights into agent interaction and resulting effects in a complex system, such as the electricity market, under consideration of economic, technical and social context factors (Ringler et al., 2016). Over the runtime of the simulation, agents may learn from the experience gained, improve their decisions and adapt these to the changing conditions within the simulation framework (Ventosa et al., 2005). Comprehensive reviews on agent-based models for electricity markets are provided by Sensfuß et al. (2007), Weidlich and Veit (2008), and Guerci et al. (2010). Therefore, agent-based simulations are a good tool for our analysis (Section 3.1). Section 3.2 describes the applied charging strategies, and Section 3.3 shows how we assess CO₂ emissions.

3.1. Simulation framework for electricity markets

In this work, the day-ahead markets are simulated with the agent-based electricity market simulation model PowerACE. The simulation is carried out in hourly time steps for each year from 2015 to 2030. The market participants are modeled as separate agents and are active on the spot market (Genoese, 2010): Large generation companies are represented by individual agents and, therefore, characterize the structure in their respective market areas. Electricity demand and generation from RES are modelled in aggregated form as one respective agent for each market area. In addition to short-term trading activities on the spot market, generation agents carry out investment planning for flexible power plants (Zimmermann et al., 2021). Mainly for this investigation, PEV-specific demand is modelled with an individual agent per market area (Ensslen et al., 2018). The PowerACE model encompasses the following ten interconnected market areas: France, Germany, Austria, Belgium, Czech Republic, Denmark, Italy, Netherlands, Poland, and Switzerland.

The simulation in PowerACE takes place stepwise in discrete events. After initializing the model, a daily auction is performed on the spot market. All market participants submit hourly bids according to their demand profile and production costs. The volumes and prices offered result from power plant capacities, marginal costs, expected residual loads and start-up costs of individual power plants (Bublitz et al., 2015). Similar to the real-world market clearing algorithm EUPHEMIA, supply and demand bids are matched such that the total welfare across all modelled market areas is maximized, subject to the constrained transfer capacities between the market areas. The auction results are then stored so the information is available to all market participants.

More specifically, the spot market simulation consists of the following four steps: (i) price forecast, (ii) bidding, (iii) market clearing and (iv) dispatch.

(i) Price forecast: Based on expected hourly residual loads, supply traders carry out price forecasts for all hours of the following day. Furthermore, they consider electricity exchange expectations between coupled market areas in the price estimated centrally by multiple linear regression (cf. Fraunholz, 2021).

(ii) Bidding: The supply traders prepare bids for all their power plants for the following day. Thereby, the variable costs of the power plants and, if applicable, startup costs and markups are considered in bid price calculations. Additional price inelastic bids concerning RES feed-in, static demand, flexible demand of PEV, as well as bids for pumped storage are placed (cf. Keles et al., 2016).

(iii) Market clearing: All bids are submitted to the market coupling operator matching supply and demand in the market clearing process across all market areas in a welfare-maximizing linear optimization subject to the limited interconnector capacities between all simulated market areas (cf. Ringler et al., 2017).

(iv) Dispatch: All supply traders calculate their hourly load curve and determine a dispatch of their dispatchable power plants based on technical limits.

If demand cannot be fully met by the available production capacity, interruptible capacities are activated with market prices at 700 EUR/MWh (e.g., Paulus and Borggrefe, 2011). However, if interruptible load capacities are insufficient to balance supply and demand, there will be a deficit in satisfying electricity needs. The market price is set at the maximum permissible price for the day-ahead wholesale market of 3,000 EUR/MWh (EPEX Spot, 2021). If the market cannot be cleared adequately, the strategic reserve (if implemented in the respective market area) or the reserve market might provide additional energy to avoid black- or brownouts. However, the request of the reserve markets is not modeled. Only the required capacity for reserve markets is reserved and, therefore, not offered at the spot market.

Contrary, hours can occur in which RES can meet the electricity demand fully. In this case the market price is assumed to be 0 EUR/MWh.

At the end of each simulation year, the investment planning module calculates the expected net present values (NPV) of agents' flexible power plant options. The generation companies then decide which conventional power plants to add in case of a positive NPV (Fraunholz et al., 2019; Zimmermann et al., 2021; Zimmermann and Keles, 2022). However, to isolate the effect of shifting charging on emissions, we decided to apply the same power plant park to all charging scenarios. This means that the mechanism described above is applied with uncontrolled PEV charging (cf. Table 1). This endogenously developing power plant park is used for all simulations with the other charging strategies.

Active market coupling is assumed (Ringler et al., 2017; Ringler, 2017) with further market areas of southern and central-western Europe, i.e., Austria, Belgium, Italy, Netherlands, Switzerland, Denmark, Poland and the Czech Republic. Furthermore, capacity remuneration schemes introduced in several countries are considered in the modelling approach (Bublitz et al., 2015; Keles et al., 2016; Kraft, 2017; Zimmermann et al., 2017; Bublitz et al., 2019).

3.2. Scheduling of PEV loads

For the simulation of PEV on the spot market, it is assumed that there is exactly one charging manager agent (or aggregator) per market area, steering the total PEV-specific energy demand. The methods used in this paper to model PEV charging are based on Ensslen et al. (2018), who focused on the effects of charging managers in uncoupled electricity markets in France and Germany. We focus our analyses of simulation results in Section 5 on the German and the French market areas due to their similar vehicle fleet and comparable PEV ramp-up. Nevertheless, all ten market areas are coupled and have modelled PEV fleets. Thus, PEV charging is a full-fledged part of the energy system simulation in our model. To lower the simulation load, we apply the sample size reduction algorithm developed by Ensslen et al. (2019).

To recharge its customers' PEV, the aggregator purchases electricity on the spot market and acts as the energy supplier for the charging processes. In practice, the aggregator guarantees fully charged vehicles at the departure time and shifts the charging times according to the respective charging

strategy. His goal is to minimize electricity purchasing costs (scenarios *Opt Price* and *Opt RES*) and/or to meet restrictions on real-time RES provision (scenarios *Opt RES* and *Max RES*).

The PowerACE model is used to simulate the effects of an increasing number of PEV and different charging strategies of the charging manager on spot electricity markets. The different scenarios and corresponding charging strategies considered in this paper are summarized in Table 1 and described in further detail in the following. The table uses symbols and abbreviations in correspondence with Eq. (2)-(14).

Table 1: Overview of considered scenarios

Scenario	Description	Consideration of penalty function in the objective function	Optimization problem
No PEV (baseline)	Market simulation without PEV	n/a	n/a
Uncontrolled	Direct PEV charging	n/a	n/a
Opt Price	Expenditure minimizing PEV charging	$\vartheta_t^{penalty} = 0$	Objective function (2), subject to Eq. (3)-(8)
Opt RES	Expenditure minimizing PEV charging with RES limit	$\vartheta_t^{penalty}$ with $PROD_t^{tech} = 0.1 PROD_t^{RES}$	Objective function (2), subject to Eq. (3)-(8)
Max RES	Minimizing excess demand above RES limit	$p_{i,t}^{price\ forecast} = 0$ and $\vartheta_t^{penalty} = 1$ with $PROD_t^{tech} = 0.1 PROD_t^{RES}$	Objective funct. (12), subject to Eq. (3)-(8) and (13)-(14)

The charging manager allocates bids on the spot market using the following steps: First, the charging manager makes a price forecast for the 24 hours of the following day before the day-ahead auction takes place. The forecast is based on a merit order model for the respective market area and is prepared using the information available to the agent. With *Uncontrolled* charging, all PEV charge as soon as possible, irrespective of the price forecast. In all other PEV scenarios, an iterative method takes load shift potentials into account in the price forecast. The agent's goal is to shift the demand of PEV charging into hours with the lowest possible forecast spot prices (Figure 1, scenarios *Opt Price* and *Opt RES*) and in scenarios *Opt RES* and *Max RES* to not exceed the hourly power limit set by $PROD_t^{tech}$.

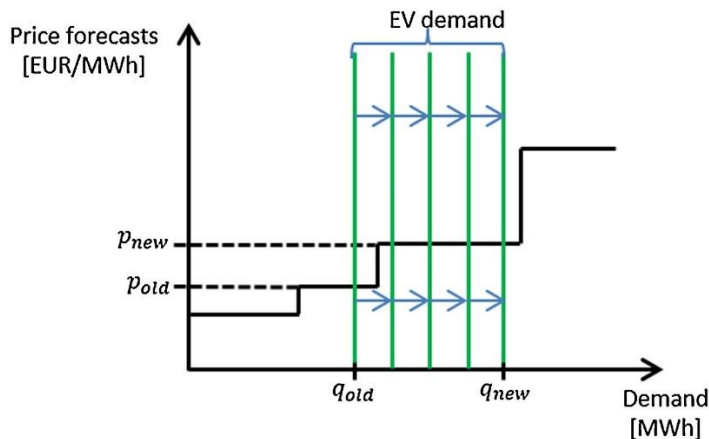

Figure 1: Schematic representation of the iterative disposition of PEV-specific charging loads by the aggregator (Ensslen et al., 2018).

In order to promote the use of RES, we specify $PROD_t^{tech} = \alpha PROD_t^{RES}$ for scenarios *Opt RES* and *Max RES*, as an incentive to limit hourly PEV-demand to a specified share α of domestic RES-generation in this hour. This model corresponds to the aggregator sourcing the electricity supplied to its customers

in real-time and exclusively from national RES, thereby increasing demand for such GoO³. Growing demand and correspondingly increasing prices could lead to incentives for additional investments in RES, especially with hourly balancing (Will et al., 2017b). As RES generation is included exogenously in the model, investigations of the described mechanism are the subject of future work. In this paper, we investigate in how far shifting PEV demand under different target functions can lead to advantages concerning domestic and supra-national carbon emissions. While *Max RES* disregards economic aspects to minimize excess demand by PEV (cf. (12)), a sizeable financial penalty in *Opt RES* incentivizes limiting PEV demand to the energy available from RES as well as focusing on the lowest available prices.

The energy to be charged in a charging event x , including corresponding potentials for load shifting, is calculated by subtracting the battery's maximum state of charge SoC_x^{max} from the state of charge when the vehicle arrives $SoC_x^{arrival}$, if the plug-in time of the vehicle is sufficient. Otherwise, the PEV are charged during the time they are plugged-in $d_{t,x}$ at maximum power P_x^{max} (Eq. (1)):

$$Q_x^{demand} = \min \left\{ SoC_x^{max} - SoC_x^{arrival}, P_x^{max} \sum_{t=1}^{24} d_{t,x} \right\} \quad \forall x \quad (1)$$

Subsequently, the charging manager begins with the iterative, incremental, expenditure-minimizing disposition ($i = 1 \dots I$) of the energy to be charged. $p_{i,t}^{price\ forecast}$ represents the iteration-specific price forecast, $e_{i,t,x}$ the charging event-specific demand during hour t , and $\vartheta_t^{penalty}$ the penalty costs considered in *Opt RES*. The penalty $\vartheta_t^{penalty}$ applies when PEV-specific hourly demand cannot be covered entirely by RES⁴ (in case $PROD_t^{tech} = PROD_t^{renewables}$) or CO₂-neutral electricity (in case $PROD_t^{tech} = PROD_t^{renewables\ and\ nuclear}$). We set the penalty to 3001 EUR/MWh, just above the price cap on the day-ahead market (cf. 3.1), to force the aggregator to prioritize adherence to RES-availability over the lowest price.

After energy amount $\frac{i}{I} \cdot Q_x^{demand}$ was scheduled in iteration i , the price forecast is updated under consideration of the scheduled loads of the last iteration i . The updated price forecast $p_{i,t}^{price\ forecast}$ is used to plan the incremental energy quantity within iteration $i + 1$. After this step, the energy amount $\frac{i+1}{I} \cdot Q_x^{demand}$ including the increment $i + 1$ is scheduled. After all energy to be charged has been scheduled, i.e., $i > I$, the heuristics stops. The linear optimization problem solved in each iteration i is formulated as follows (Eq. (2)-(8)):

³ Obviously, the RES production allocated to PEV is not available to any other consumers, leading to increased allocated emissions for these consumers.

⁴ Since renewable production is exogenous to the model, its availability for the following day and years are known to all market actors. This simplification eliminates the uncertainty of production and puts the analytic focus on the system impact of flexible PEV demand.

$$\min \sum_{t=1}^{24} \left(\sum_{x=1}^X p_{i,t}^{price\ forecast} \cdot e_{i,t,x} + \vartheta_t^{penalty} \cdot \max \left(0; \sum_{x=1}^X e_{t,x} - PROD_t^{tech} \right) \right) \quad (2)$$

s.t.

$$\sum_{t=1}^{24} e_{i,t,x} = \frac{i}{I} \cdot Q_x^{demand} \quad \forall i \forall x \quad (3)$$

$$e_{t,x} \leq P_x^{max} \cdot d_{t,x} \quad \forall t \forall x \quad (4)$$

$$e_{t,x} \geq 0 \quad \forall t \forall x \quad (5)$$

$$\sum_{x=1}^X e_{i,t,x} \geq \sum_{x=1}^X e_{i-1,t,x} \quad \forall i \forall t \quad (6)$$

$$t \in \{1, \dots, 24\} \quad (7)$$

$$x \in \{1, \dots, X\} \quad (8)$$

The charging manager schedules the charging events x as an expenditure-minimizing problem (2) (for *Opt Price* and *Opt RES*). Since $\vartheta_t^{penalty} > 0$ in scenario *Opt RES*, penalty costs are added if PEV-specific loads cannot be allocated to hours with sufficient amounts of RES. The first constraint of the optimization problem (Eq. (3)) ensures that the energy balance is maintained during each charging event, taking into account the respective driving data. The second and third constraints ensure that specific charging capacity constraints are met (Eq. (4)), and that energy flow is always unidirectional (Eq. (5)). The fourth constraint (Eq. (6)) ensures that the energy charged in iteration i , cannot fall below the energy charged in the previous iteration $i - 1$. The fifth and sixth constraints (Eq. (7) and Eq. (8)) make sure that all charging events are scheduled during the hours of a day.

The price forecast in iteration i is identical for all PEV and is updated in each iteration. Consequently, potential PEV-specific demand-response avalanche effects are avoided (cf. Kühnbaach et al., 2021). Furthermore, the iterations can be interpreted as I aggregators sequentially active in the same market. Aggregators place day-ahead bids on the market as price-independent bids, so PEV-specific demand is covered as planned by the charging manager. The calculations are based on the assumption that complete information is available to the charging manager, so there is no reason for additional market balancing mechanisms, such as an intraday market or balancing energy markets.

For modeling purposes, the maximum term in the objective function is linearized with the help of the auxiliary variable z_t . This changes the model according to the following, while Eq. (3)-(8) remain in place unchanged:

$$\min \sum_{t=1}^{24} \left(\sum_{x=1}^X (p_{i,t}^{price\ forecast} \cdot e_{t,x}) + \vartheta_t^{penalty} \cdot z_t \right) \quad (9)$$

s.t.

$$z_t \geq \sum_{x=1}^X e_{t,x} - PROD_t^{tech} \quad \forall t \quad (10)$$

$$z_t \geq 0 \quad \forall t \quad (11)$$

Constraints Eq. (3)-(8) remain unchanged.

In consequence, the auxiliary variable z_t will only be chosen as greater than 0 if the hourly PEV-specific consumption exceeds the specified production mix for that hour. Note that this linearization only works because the objective function is minimized, therefore exerting no “upward pressure” on z_t beyond the lack of specified production $PROD_t^{tech}$.

The optimization in scenario *Max RES* ignores the price forecast ($p_{i,t}^{price\ forecast} = 0 \forall i \forall t$) and $\vartheta_t^{penalty}$ is irrelevant and therefore fixed to 1. This scenario aims to investigate the effects of extreme attention to RES availability without accounting for hourly electricity prices. Without a price forecast, however, the aggregator lacks a signal for when to allocate PEV load in the case of insufficient provision of $PROD_t^{tech}$. Here, in order to avoid arbitrary optimization behavior, constraint Eq. (13) forces the algorithm to exceed $PROD_t^{tech}$ as little as possible, therefore distributing excess PEV load across all hours of the day. It uses a similar linearization approach as described above. $\varepsilon > 0$ is a small number, e.g., 10^{-4} . The objective function (12) for this scenario, therefore, can be reduced as follows:

$$\min \left\{ \left[\sum_{t=1}^{24} \max \left(0; \sum_{x=1}^X e_{t,x} - PROD_t^{tech} \right) \right] + \varepsilon \cdot v \right\} \quad (12)$$

s.t.

$$v \geq \sum_{x=1}^X e_{t,x} - PROD_t^{tech} \quad \forall t \quad (13)$$

$$v \geq 0 \quad (14)$$

Constraints Eq. (3)-(8) remain unchanged.

3.3. Assessment of CO₂ emissions

Due to the additional electricity demand of PEV, their charging strategy impacts the carbon intensity of electricity provision. Assessing this impact in coupled electricity markets requires delimiting production- and consumption-based emissions. In the following, we briefly show how we calculate CO₂ emissions under consideration of different market areas with different electricity production technologies varying in specific CO₂ emissions. Based on Peters (2008), a more detailed discussion of our approach can be found in Appendix A.

The amount of electricity produced in a market area must be equal to the amount consumed. However, in the application of multi-regional input-output analysis, when electricity is exported, domestic production is increased, while when electricity is imported, domestic production is decreased (Peters and Hertwich, 2009). Every market area's export must be imported into another market area.

In the strongly interconnected European market, this happens constantly and dynamically. Consequently, emissions are caused by a market area importing electricity while the amount of emissions is tracked in the exporting market area. We call the latter *production-based (PB) emissions* calculated by allocating fuel-based emission factors to every kWh produced domestically. *Consumption-based (CB) emissions* are equal to the produced and the imported emissions reduced by exported emissions. Since the net exchange flows of electricity are known ex-post in our model, we can build a linear system of equations for all market areas and then solve for consumption-based emissions for each hour. The approach is based on Tranberg et al. (2019). Losses (e.g., transmission, self-consumption) are neglected. Further, we do not keep track of storage charging and discharging emissions.

Having outlined the fundamental dimensions for emissions and demand, we define three approaches for determining emission factors, each using a PB and a CB approach, aggregated for single hours and over the entire year studied:

- (1) Energy mix-specific CO₂ emissions factor (EF)
- (2) Marginal PEV-specific CO₂ emission factor (MEF)
- (3) Allocated PEV-specific CO₂ emission factor (AEF)

The different factors are described in detail below:

(1) The first approach calculates *energy mix-specific CO₂ emissions*. Average annual PB and CB CO₂ emission factors (EF^{PB} , EF^{CB}) as well as average hourly CO₂ emission factors (EF_t^{PB} , EF_t^{CB}) are calculated as described below and in Eq. (15) and Eq. (16).

$$EF_t^{PB} = \frac{E_t^{prod}}{PROD_t} \quad \forall t \quad (15)$$

$$EF_t^{CB} = \frac{E_t^{cons}}{CONS_t} \quad \forall t \quad (16)$$

EF_t^{PB} and EF_t^{CB} are calculated for every hour in the year considered (Eq. (15) and Eq. (16)). EF^{PB} is then calculated by aggregating the CO₂ emissions due to electricity generation in the market area considered E_t^{prod} for all hours $t \in \{1, \dots, T\}$ with $T = 8760$ and dividing by the annual energy produced within the market area considered $\sum_{t \in T} PROD_t$. EF^{CB} is calculated by considering CB CO₂ emissions. In order to determine EF^{CB} , the aggregated CB CO₂ emissions are divided by the annual electricity consumption within the market area considered $\sum_{t \in T} CONS_t$.

(2) The second approach calculates *marginal PEV-specific CO₂ emission factors*. Unlike empirical approaches by, e.g., Hawkes (2010) or Braeuer et al. (2020), we can utilize the knowledge available from our simulation and compare the additional emissions from a system with PEV to one without them. We allocate the additional emissions caused by PEV in the power system directly to the marginal demand of PEV. Annual marginal PB and CB CO₂ emission factors (MEF^{PB} , MEF^{CB}) and hourly marginal CO₂ emission factors (MEF_t^{PB} , MEF_t^{CB}) are calculated as described in Eq. (17) and Eq. (18).

$$MEF_t^{PB} = \frac{\Delta E_t^{prod}}{CONS_t^{PEV}} \quad \forall t \quad (17)$$

$$MEF_t^{CB} = \frac{\Delta E_t^{cons}}{CONS_t^{PEV}} \quad \forall t \quad (18)$$

MEF_t^{PB} and MEF_t^{CB} are calculated for every hour (Eq. (17) and Eq. (18)). Hourly marginal PEV-specific domestic CO₂ emissions ΔE_t^{prod} are calculated by subtracting total hourly domestic and exported CO₂

emissions produced in the baseline scenario $E_t^{prod\ base}$ from total hourly domestic and exported CO₂ emissions produced in the PEV-specific scenario $E_t^{prod\ scen}$, i.e., $\Delta E_t^{prod} = E_t^{prod\ scen} - E_t^{prod\ base}$. MEF^{PB} is then calculated by dividing aggregated annual marginal CO₂ emissions of electricity produced $\sum_{t \in T} \Delta E_t^{prod}$ by annual energy production allocated to PEV $\sum_{t \in T} CONS_t^{PEV}$ with $CONS_t^{PEV} = \sum_{x=1}^X e_{t,x}$. Hourly marginal CB PEV-specific CO₂ emissions ΔE_t^{cons} are calculated by subtracting total hourly CO₂ emissions in the baseline scenario $E_t^{cons\ base}$ from total hourly CO₂ emissions in the PEV-specific scenario $E_t^{cons\ scen}$, i.e., $\Delta E_t^{cons} = E_t^{cons\ scen} - E_t^{cons\ base}$ and dividing by the aggregated annual PEV-specific electricity consumption $\sum_{t \in T} CONS_t^{PEV}$. MEF^{CB} is calculated by considering aggregated annual marginal CB CO₂ emissions.

(3) The third approach *allocates, if possible, PEV-specific loads to national carbon-neutral electricity generation technology*, i.e., RES certificates or GoOs available within each market area are used for attributing CO₂-free electricity to PEV charging. PEV-specific electricity consumption being covered by GoO $CONS_t^{PEV,CN}$ is represented by the minimum of market area-specific production with GoOs $PROD_t^{GoO}$ and PEV-specific demand $CONS_t^{PEV}$ (cf. Eq. (19)).

$$CONS_t^{PEV,CN} = \text{Min}\{CONS_t^{PEV}; PROD_t^{GoO}\} \quad (19)$$

Consequently, the share of PEV-specific production covered by GoOs is calculated as described in Eq. (20).

$$\rho_t^{PEV,GoO} = \frac{CONS_t^{PEV,CN}}{CONS_t^{PEV}} \quad (20)$$

Adjusted hourly PB (CB) PEV-specific CO₂ emission factors AEF_t^{PB} (AEF_t^{CB}) are calculated by multiplying the CO₂ emission factor EF_t^{PB} (EF_t^{CB}) with the share of PEV demand that cannot be covered by GoOs $1 - \rho_t^{PEV,GoO}$ and multiplying with a correction factor $\frac{PROD_t}{PROD_t - CONS_t^{PEV,CN}}$ ($\frac{CONS_t}{CONS_t - CONS_t^{PEV,CN}}$). This permits full allocation of corresponding CO₂ emissions to the share of electricity production (consumption) not being covered by GoOs. Corresponding adjusted annual PB and CB PEV-specific CO₂ emission factors are calculated analogously: The factors consider annual average CO₂ emission factors EF^{PB} and EF^{CB} , annual averages of the share of PEV-specific production covered by GoOs and annually aggregated production, consumption and PEV-specific consumption being covered by GoOs (cf. Eq. (21)-(24)).

The PB and CB CO₂ emission factors of carbon-neutral allocation of PEV-specific loads (AEF^{PB} , AEF^{CB}) and corresponding hourly CO₂ emission factors (AEF_t^{PB} , AEF_t^{CB}) are calculated as described in Eq. (21)-(24).

$$AEF^{PB} = EF^{PB} \cdot \left(1 - \frac{\sum_{t \in T} \rho_t^{PEV,GoO}}{T}\right) \cdot \frac{\sum_{t \in T} PROD_t}{\sum_{t \in T} PROD_t - \sum_{t \in T} CONS_t^{PEV,CN}} \quad (21)$$

$$AEF^{CB} = EF^{CB} \cdot \left(1 - \frac{\sum_{t \in T} \rho_t^{PEV,GoO}}{T}\right) \cdot \frac{\sum_{t \in T} CONS_t}{\sum_{t \in T} CONS_t - \sum_{t \in T} CONS_t^{PEV,CN}} \quad (22)$$

$$AEF_t^{PB} = EF_t^{PB} \cdot (1 - \rho_t^{PEV,GoO}) \cdot \frac{PROD_t}{PROD_t - CONS_t^{PEV,CN}} \quad \forall t \quad (23)$$

$$AEF_t^{CB} = EF_t^{CB} \cdot (1 - \rho_t^{PEV,GoO}) \cdot \frac{CONS_t}{CONS_t - CONS_t^{PEV,CN}} \quad \forall t \quad (24)$$

4. Data and assumptions

Generally, the PowerACE model relies on different types of exogenous input data. Time series data typically have an hourly resolution. Mainly publicly available sources are used, e.g., scenario data is based on European Commission (2016) or ENTSO-E (2017) for historical data – therefore, the impacts of the war in Ukraine on the electricity sector are not considered. Table 2 provides an overview of key input data types and sources, also used in Zimmermann et al. (2021).

Table 2: Overview of key input data and sources

Input data type	Resolution	Main data sources
Conventional power plants	Plant/unit level, various techno-economic characteristics	Platts (2016)
Fuel-specific CO ₂ emission factors	Average values per fuel	UBA (2021a, 2021b)
Feed-in from RES	Hourly feed-in, aggregated for each market area	Hourly profiles from ENTSO-E (2017), yearly capacity and production quantity development from European Commission (2016), for Switzerland: Prognos AG (2012) (scenario C&E), Swissgrid (2015)
Demand	Hourly load, aggregated for each market area	Hourly profiles from ENTSO-E (2018b) (ENTSO-E, 2018b), yearly capacity and production quantity development from European Commission (2016), for Switzerland: Prognos AG (2012) (scenario C&E) and Swissgrid (2015)
Fuel and carbon spot market prices	Daily/yearly	European Commission (2016)
Investments	New flexible power plants	Schröder et al. (2013)
Transmission capacity	Yearly	ENTSO-E (2018a), NEP (2019)
Mobility data	Daily trip profiles	infas (2008) and MEEDDM (2008)

Bass diffusion models are used to model PEV diffusion in all seven market areas (Ensslen, 2019). A PEV stock of 55,900 vehicles is used as a starting point for France and 48,300 for Germany in 2015. Based on initial political targets⁵, six million PEV respectively are assumed for France and Germany in 2030, i.e., a fleet share of 19% and 13%, respectively (BMW et al., 2011; Bourbon, 2017). Households adopting PEV within the representative mobility datasets are identified by applying a binary logit model. This model yields probabilities for purchasing PEV to substitute old cars of households (Ensslen et al., 2014; Ensslen et al., 2016).

PEV-specific electricity demand and load shift potentials are derived from the PEV stock data and the vehicle operation data from infas (2008) and MEEDDM (2008). We assume that the charging managers can actively control the charging processes of PEV during the time they are parked at home or the workplace. These are the places PEV are parked most frequently and are likely to have the most extended idle times (Schäuble et al., 2017). We assume that all charging facilities are equipped with smart devices permitting controlled charging.

We assume that there is one central charging manager in each market area. The energy volume allocated by the charging managers is equal to the total PEV-specific energy demand in the different market areas. The calculations concerning the electricity consumption of PEV are based on a PEV-specific consumption of 0.2 kWh/km, a battery capacity of 60 kWh, and a maximum charging power of 3.7 kW. Since this battery capacity is insufficient for some trips, we assume that any remaining distance is covered by gasoline (i.e., by plug-in hybrid or range-extended electric vehicles). This approximation

⁵ While these political targets have since diversified, we use the initial targets for comparability between the core markets of the analysis.

of the vehicles is tolerable due to the national scale of the simulation and the necessity to focus on the aggregate effect of the fleet on the system rather than individual vehicle's behavior.

Based on these assumptions, within the simulated time frame between 2015 and 2030, the total annual energy demand from PEV grows from 246 GWh to 22.2 TWh in France and from 317 GWh to 21.9 TWh in Germany across all PEV scenarios. As the vehicles have the same mobility and energy requirements every day, these values are annual aggregates of the respective daily demands of 673 MWh in 2015 to 60.8 GWh in 2030 in France and 870 MWh to 60.0 GWh in Germany.

Finally, we specify $\alpha = 0.1$ for scenarios *Opt RES* and *Max RES* as an incentive to limit hourly PEV-demand to 10% of domestic RES generation in this hour. The value of 0.1 is exemplary but derived from the share of domestically generated GoO used in Germany, which amounted to roughly 10% in 2017 (AIB, 2021).

5. Results: Effects of different charging strategies...

We discuss the simulation results in the following two subsections for the energy market outcome (Section 5.1), i.e., PEV charging patterns, power-plant dispatch, and market prices, and resulting carbon emissions (Section 5.2) with a focus on curtailment and total system emissions.

5.1. On the electricity system (RQ1)

5.1.1. PEV charging patterns

Central to our analysis, we first describe the PEV load profiles as scheduled by the aggregators of France and Germany, as well as how these loads impact dispatch of flexible power plants, spot prices and PEV aggregators' electricity costs.

Details on the PEV-specific load distribution in 2030 can be found in Figure 2. It shows the average RES output available for PEVs as limited to 10% of hourly RES production in scenarios *Opt RES* and *Max RES*. Evening peaks for *Uncontrolled* charging are clearly visible in both markets, even though in these hours, traditionally, the prices are the highest. Since our model allows for charging at work, a sizeable peak is also visible in the morning and in France around noon. Considering the charging behavior under the controlled charging scenarios, the model clearly successfully shifts demand to low-price periods at midnight and the early morning, especially in scenario *Opt Price*. The solar generation peak at noon reduces prices considerably in both market areas and the system load reacts accordingly. Average PEV load stays more reliably below 10% RES production in *Opt RES* and *Max RES* than in *Opt Price*. The notably higher demand in the early morning hours indicates that RES energy supply is, on some days, insufficient to cover PEV demand, and the aggregator is forced to exceed the RES limit. In fact, PEV demand exceeds the allotted RES limit made available in scenarios *Opt RES* and *Max RES* on 64% of days in France (*cf.* Figure 10 in Appendix B). The maximum daily demand excess is above 30 GWh for both markets, while Germany experiences excess demand for about 30% of the year.

a) Germany

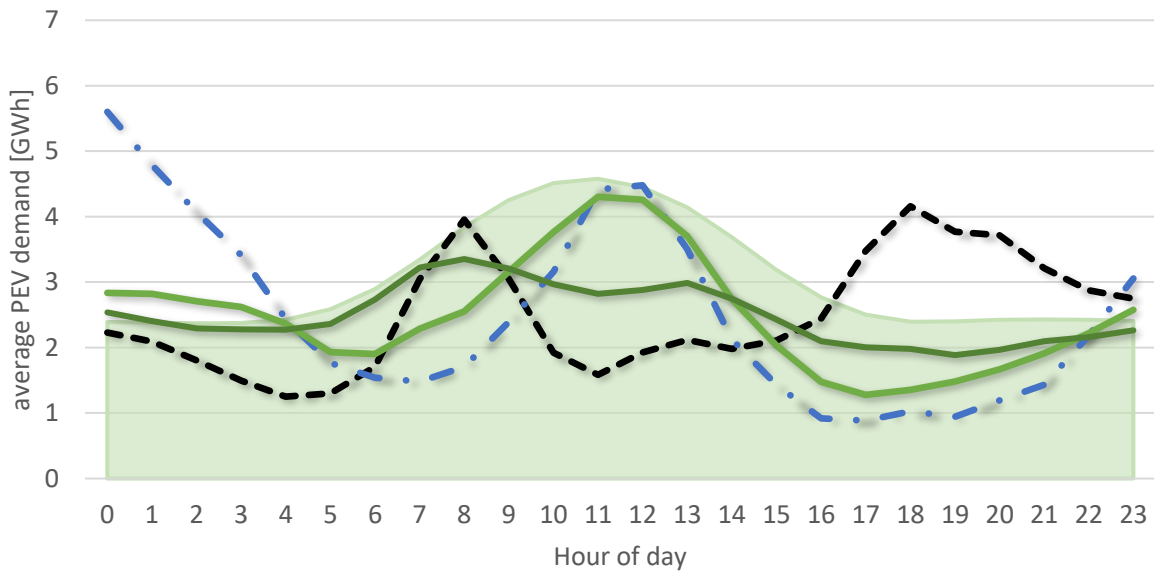

b) France

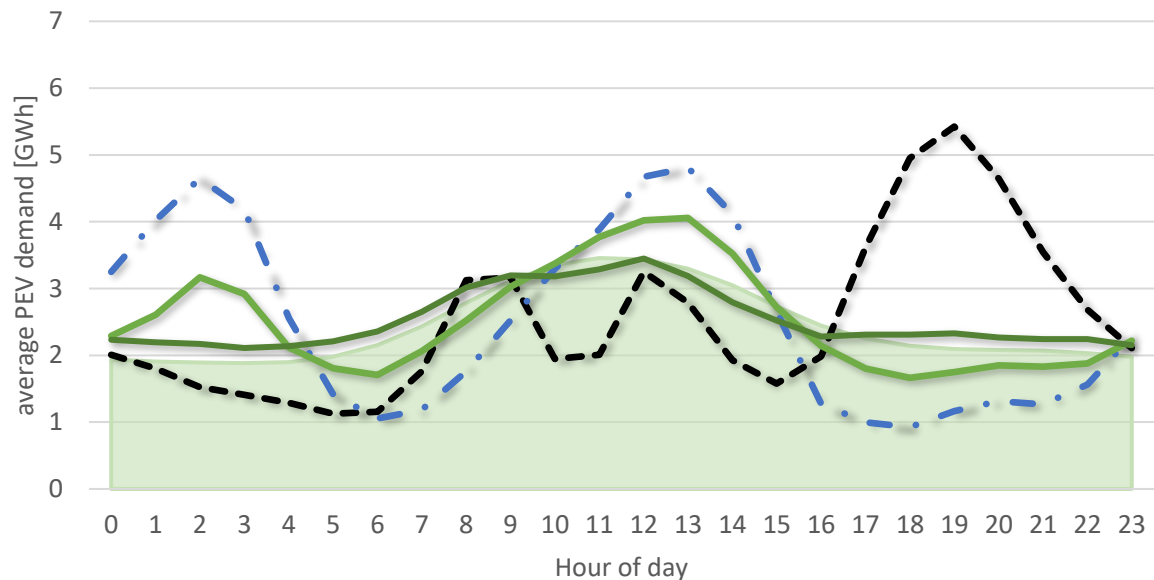

RES prod. (10%) Uncontrolled Opt Price Opt RES Max RES

Figure 2: Average PEV-demand (lines) and RES provision (area) for a) Germany and b) France in 2030

Furthermore, Table 3 shows statistics for hourly demand from PEV in 2030. It is noticeable that *uncontrolled* charging leads to a fairly balanced hourly PEV load, while especially scenarios *Opt Price* and *Opt RES* produce more extreme hourly PEV demand. Since the total allocated energy is constant across all scenarios, the mean demand from PEV is 2.50 GW in Germany and 2.53 GW in France.

Table 3: Statistics for PEV demand in Germany and France in 2030 (all values in MW)

Scenario	Min		Median		Max		Std. dev.	
	GER	FR	GER	FR	GER	FR	GER	FR
Uncontrolled	1,241	1,124	2,202	2,000	4,160	5,425	858	1,186
Opt Price	321	319	1,721	2,393	12,169	10,366	1,936	1,828
Opt RES	343	310	2,200	2,257	9,081	10,174	1,380	1,220
Max RES	986	1,197	2,375	2,421	6,060	4,575	755	596

5.1.2. Generation capacities

Since PEV charging behavior under a charging strategy impacts the load curve and market outcomes and, subsequently, hourly emissions, it also impacts investment decisions by conventional power plant operators in the long-term. The simulation model was used to determine power plant expansion based on the *uncontrolled* charging scenario. For all other scenarios, the generation capacity development was taken directly from the uncontrolled charging scenario so that an identical power plant development was fixed to guarantee the comparability of other results between the scenarios. The fixed capacities imply that investments are made with the agents' expectation that PEV always charge as soon as possible and without taking price levels or RES production into account.

Investments in gas combined-cycle turbines (CCGT) and open-cycle gas turbines (OCGT) are possible in the model applying the cost assumption from Schröder et al. (2013). As described in Section 4, the German phase-out of nuclear power plants (until end 2022) and the phase-out of coal-fired power generation in Germany (until end 2038) and France (until end 2022) were taken into account. Thus investments in coal-fired power plants were not allowed in all modelled countries, and investments in nuclear power plants were not allowed in Germany, leading to a decrease in capacities for these power plant technologies. Furthermore, power plants will be decommissioned after reaching their technical lifetime, e.g., hard coal and gas power plants after 45 years. Investments in RES are exogenously given due to political targets and cannot be performed by the model. In addition, investments in market-scale battery storage were neglected since no substantial installation is expected by 2030 due to still comparably high battery costs (cf. Fraunholz et al., 2021).

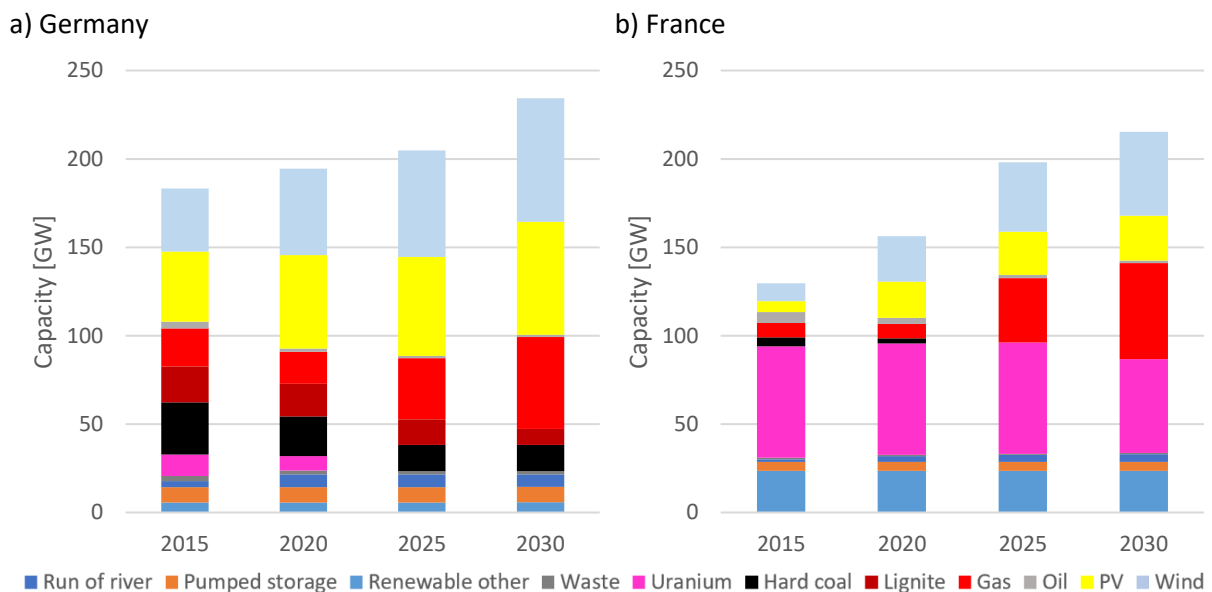

Figure 3: Capacity development identical for all scenarios based on the uncontrolled charging scenario in a) Germany and b) France

Figure 3 shows Germany's and France's resulting capacity developments in 5-year steps. The results show that between 2023 and 2030, large CCGT capacities will be added in Germany (30.4 GW). France invests in both OCGT power plants (32.8 GW) and CCGT (13.6 GW). Due to the French capacity remuneration mechanism, the increase in new capacity in France is considerably higher than in Germany. The French mechanism also causes OCGTs to be more economical than other options due to the comparatively low investment expenditures for gas turbines.

Towards the end of the simulation period, German capacity grows strongly, which is justified and accounted for by the assumed increasing PEV demand, especially in the years after 2030. Increasing

demand cannot be compensated through the increasing generation of RES only but by new investments in flexible power plants.

5.1.3. Power plant dispatch and spot market prices

Figure 4 shows the electricity generation specified by fuel type in Germany and France over the simulated time span with *uncontrolled* charging.

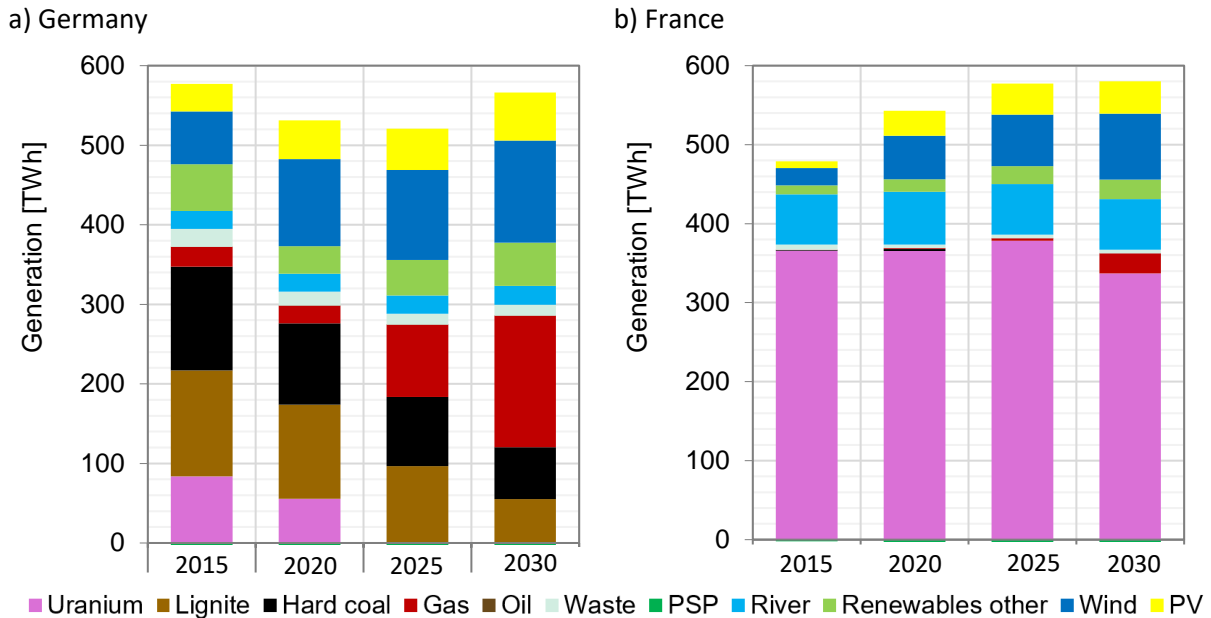

Figure 4: Technology-specific generation in a) Germany and b) France with uncontrolled charging⁶

It can be seen that increasingly large shares of generation will be provided by RES, especially wind and PV. In France, a major share of generation continues to be provided by nuclear power plants. Germany has a clear shift in generation from coal to gas. In total, generation in France also increases due to the added capacity, and France will become a net electricity exporter in 2030. Germany meanwhile transitions to a net electricity importer. Generation decreases until 2025 and increases slightly in 2030, almost to the initial level. These trends are stable across all PEV charging scenarios for either Germany or France.

⁶ Since grid restrictions are only modelled for international transfer capacities to selected countries deviations from historical production volumes are possible.

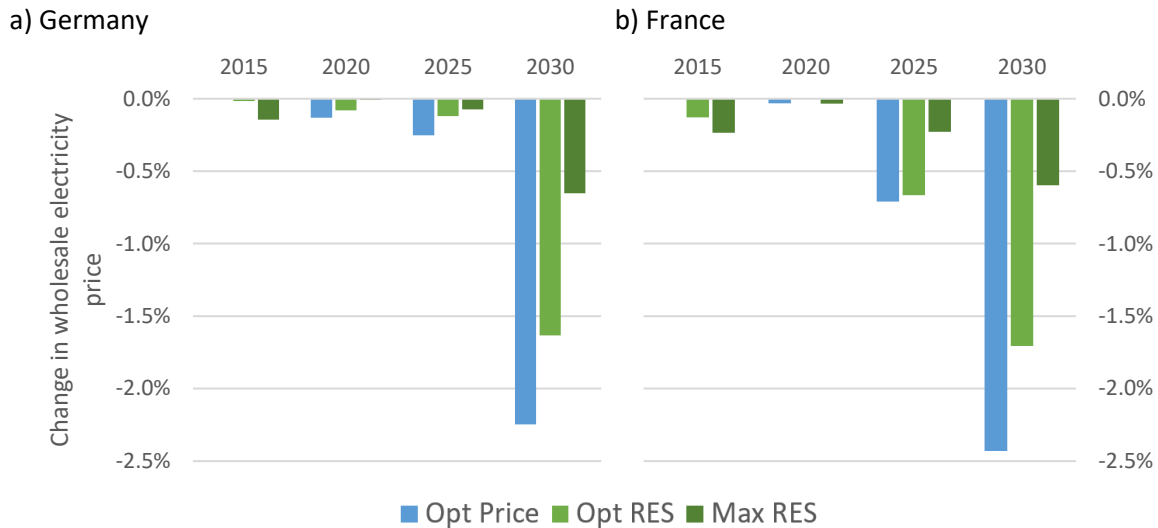

Figure 5: Arithmetic average spot market electricity prices in the smart charging scenarios in a) Germany and b) France across simulated timeframe relative to scenario "Uncontrolled".

We use the average price as the first indicator of the system impacts of PEV charging strategies. Figure 5 shows that *Opt Price* has the most considerable lowering impact on the price level compared to the scenario *Uncontrolled*. *Opt RES* (*Max RES*) is less (not at all) reactive to price, leading to smaller price differences. It must be noted that annual PEV demand for electricity represents only around 4% of the annual total electricity demand in Germany in 2030, but PEV charging behavior still influences the price level in an integrated European energy market. This is due to fewer restarts of power plants at the higher end of the merit order and, therefore, lower start-up costs. For the *Uncontrolled* scenario, the nominal prices in Germany increase from around 33 EUR/MWh⁷ in 2015 (36 EUR/MWh in France) to 85 EUR/MWh in 2030 (79 EUR/MWh in France).

5.1.4. Aggregators' electricity costs

Multiplying the scheduled PEV demand with the associated simulated hourly price, the aggregators' electricity expenditures for PEV charging can be calculated. Please note that, for the sake of comparability, Figure 6 does not include the penalty payments for scenarios *Opt RES* and *Max RES*. Scenarios *Opt price*, and *Opt RES* tend to have the lowest charging costs, while *Max RES* leads to slightly increased costs. However, all smart charging schemes yield considerable cost reductions for the aggregators, in total around 140 Mio EUR in Germany and 180 Mio EUR in France.

⁷ All nominal prices in EUR₂₀₁₃.

a) Annual aggregator electricity costs 2030

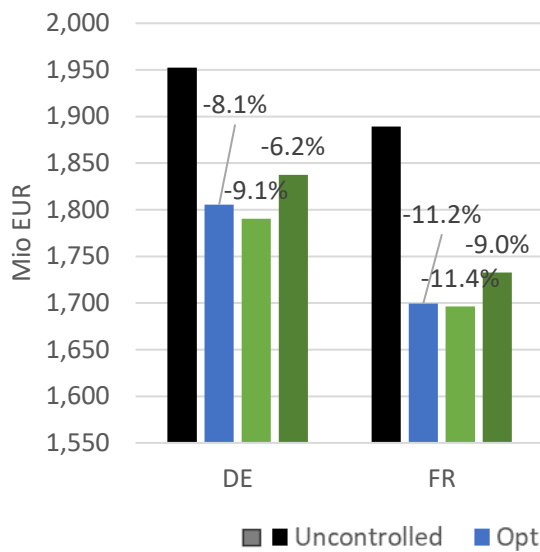

b) Distribution of hourly electricity costs (DE)

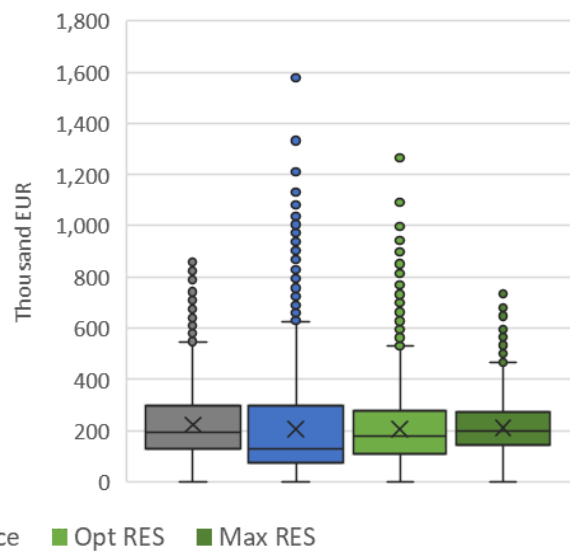

Figure 6: Electricity costs (without penalty in “Opt RES”) for a) aggregators in Germany and France in 2030 and b) distribution of hourly electricity costs in Germany

Unintuitively, *Opt Price* generates slightly higher electricity costs for the German aggregator than the *Opt RES* charging strategy. The lower average price level and lower median load with *Opt Price* cannot compensate for the substantial impact of the strategy’s rare but high load spikes. Furthermore, Table 3 shows statistics for PEV demand in 2030. It is noticeable that *uncontrolled* charging leads to a reasonably balanced hourly PEV load, while especially scenarios *Opt Price* and *Opt RES* produce more extreme PEV demand. Since the total allocated energy is constant across all scenarios, the mean demand from PEV is 2.50 GW in Germany and 2.53 GW in France.

In fact, the large load potential shifted by the aggregator can lead to peak prices in the spot market at other times, leading to extremely costly hours for the aggregator. As an indicator of the increased volatility due to price-based load shifting, the standard deviation of hourly electricity costs for *Opt Price* is 28% higher than in *Opt RES*.

In reality, aggregators would likely sooner adjust to this avalanche effect (i.e., to the high impact of PEV load on price levels) and avoid such self-inflicted price spikes. The results can also be interpreted in the context of market power: As soon as aggregators manage a large pool of vehicles with considerable load, they may be able to exploit their impact on prices to their benefit. However, the significance of the effect may be overestimated by simulating a single aggregator for each market area. An iterative approach of splitting PEV demand into 20 sequential segments shows that this effect can be mitigated.

5.2. On carbon emissions (RQ2)

5.2.1. Curtailment

Due to the strong expansion of RES capacity in some countries, RES production can sometimes outpace total electricity demand on very sunny or windy days. Grid balance may have to be maintained by curtailing production from inflexible RES. The results in Figure 7 indicate that smart PEV charging strategies, compared to uncontrolled charging, can help mitigate curtailment across Europe in 2030, improving economic efficiency. In fact, the additional demand from PEV leads to an additional 200 GWh of green electricity being used in the 2030 system. Smart charging leads to further curtailment reductions, particularly with the *Opt Price* strategy (by almost 30%) and *Opt RES* strategy (by around 27% compared to *Uncontrolled*). Charging with *Max RES* also reduces up to 16% of RES

electricity curtailment, but compared with *Opt Price* and *Opt RES*, it takes less advantage of RES oversupply due to its smaller demand spikes.

Considering individual market areas, the vast majority of curtailment occurs in Denmark due to its large wind capacity and restricted connection to Germany⁸. Smart charging eliminates all curtailment in Germany and almost halves curtailment in Italy and the Netherlands. It must be noted that our model only considers energy flows between markets. However, curtailment could also be caused due to domestic grid congestion, which is neglected in our model. Ried (2021) shows that PEV can reduce curtailment within a country.

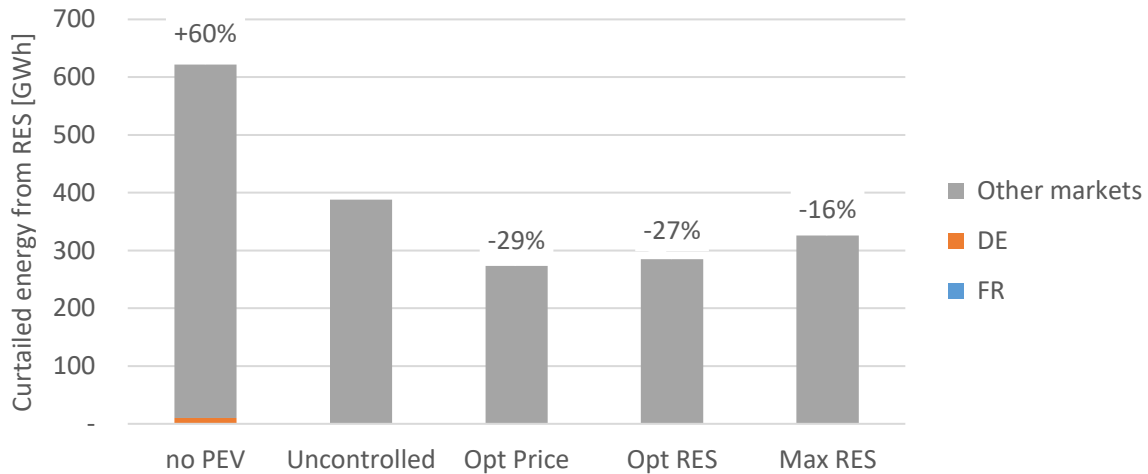

Figure 7: Cumulative curtailment of RES across all simulated markets under the different scenarios in 2030. Percentages relative to Uncontrolled.

5.2.2. Emissions

The time-varying power demand affected by the charging strategies directly impacts the electricity production required from fossil fuels and, in consequence, impacts carbon emissions. In order to analyze the effects that different charging scenarios have on emissions, we discuss below both annual absolute emissions as well as the emission factors introduced in Section 3.3.

Across all charging strategies (incl. *No PEV*), CB emissions are higher than PB emissions, indicating that France and Germany are markets exporting carbon-neutral energy (e.g., at times of high RES production) and importing more carbon-intensive electricity (Figure 8). The additional demand from PEV leads to rising emissions compared to the *No PEV* scenario, particularly in France⁹ (Figure 8a). While in Germany, total emissions are fairly stable in both the PB and CB perspectives, the French PEV have some impact on total emissions: Relatively small changes in demand appear to have a sizeable effect on more polluting power plants being in the market. This is likely due to the smaller share of RES in the French electricity generation mix, and in consequence, excess demand is covered by fossil power plants and more carbon-intensive imports (nuclear energy is carbon-neutral but not regarded as RES in this paper). Price-optimized charging (*Price Opt*) leads to the lowest emissions in France, followed by *Opt RES* and *Max RES*. On average, smart charging saves up to 5%-points compared to *uncontrolled* charging or more than 400,000 t_{CO2} of CB carbon emissions between France and Germany in 2030.

⁸ It must be considered, that we do not simulate interconnection to Sweden and Norway, which would likely further reduce the absolute amount of curtailed energy.

⁹ With exogenous RES growth, increasing net demand cannot be met with accelerated RES expansion but only more fossil fueled power plants.

Taking the sum over all simulated markets, emissions remain stable for all charging scenarios, both for PB and CB emissions.

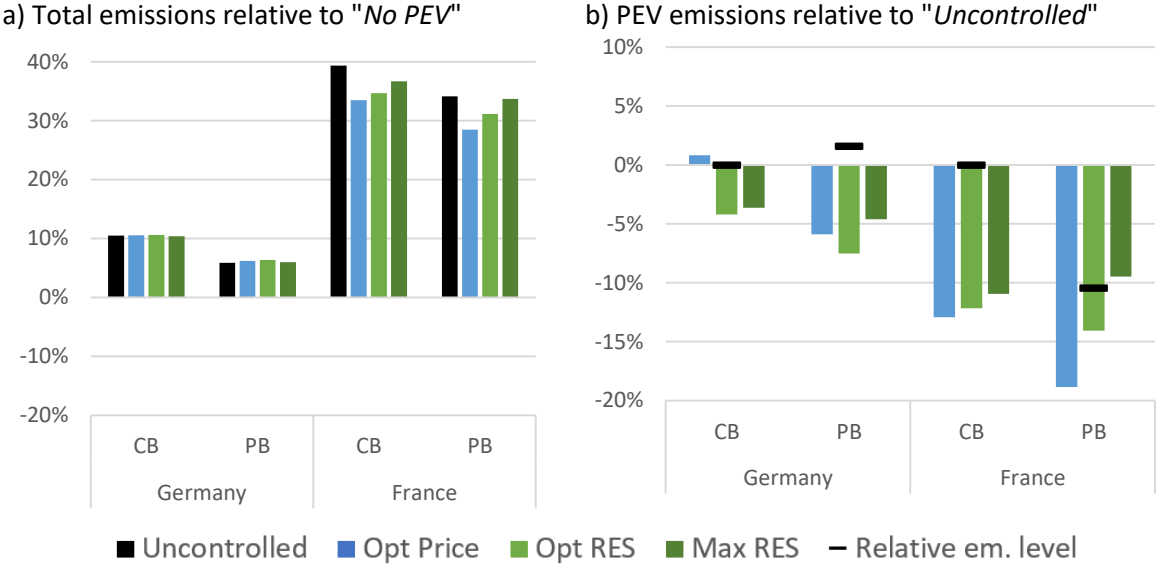

Figure 8: a) Total annual emissions in Germany and France relative to scenario No PEV for 2030 and b) total emissions attributed to PEV charging according to the traditional emission factor (Equations (15) and (16)) in 2030. The horizontal black dash shows the relative difference between PB and CB, i.e. $\frac{(PB-CB)}{CB}$.

Figure 8b shows emissions directly caused by PEV charging according to each scenario relative to *Uncontrolled*. Emissions are allocated to PEV by multiplying hourly PEV demand with the traditional emission factor EF^{CB} and EF^{PB} as defined in Equations (15) and (16). Consequently, the best charging strategies for reducing emissions caused by PEV charging are *Opt RES* in Germany and *Opt Price* in France. *Max RES* lowers emissions the least as this strategy does not appear to take advantage of frequent occurrences of large oversupplies of RES.

The chosen methodology does not consider RES production of neighboring countries in national PEV charging dispatch, which influences the results of *Opt RES* and *Max RES*. However, neighbors' RES production impacts the PEV CB emissions in case of import flows in the importing market. Due to the lack of information on the expected exchange flows prior to market clearing, PEV charging agents only optimize for the best results in PB emissions. Therefore, the desired effects of PEV charging strategies on CB emissions are likely to be lower than on PB emissions if charging strategies are not formulated with care and, e.g., do not consider international synchronization effects.

Table 4: Average CO₂ emission factors [kg/MWh] for France and Germany according to Equations (15)-(18) and (21)-(24).

Scenario [factors in kg _{CO2} /MWh]	Country	Year	Average mix emission factor		Marginal emission factor		Emission factor allocating PEV-specific consumption to carbon-neutral production	
			EF^{PB}	EF^{CB}	MEF^{PB}	MEF^{CB}	AEF^{PB}	AEF^{CB}
No PEV (baseline)	France	2015	10	22	n/a	n/a	n/a	n/a
		2030	15	17	n/a	n/a	n/a	n/a
	Germany	2015	470	471	n/a	n/a	n/a	n/a
		2030	290	275	n/a	n/a	n/a	n/a
Uncontrolled	France	2015	10	22	88	253	0	0
		2030	19	23	128	142	3	4
	Germany	2015	471	472	1566	1589	0	0
		2030	294	293	422	731	41	41
Opt Price	France	2015	10	22	2	40	0	0
		2030	18	22	107	121	3	4
	Germany	2015	471	472	2533	1649	0	0
		2030	293	293	447	732	36	35
Opt RES	France ¹⁰	2015	9	22	-187	-22	0	0
		2030	19	22	117	125	1	2
	Germany	2015	470	472	1209	1421	0	0
		2030	294	293	457	737	12	12
Max RES	France	2015	9	22	-74	239	0	0
		2030	19	23	126	132	2	3
	Germany	2015	471	472	323	1725	0	0
		2030	294	292	429	723	19	19

The previous results for total emissions are mirrored in the two columns of Table 4 dedicated to the average mix emission factor (EF): Due to the different fuel mixes (large coal generation in Germany, large nuclear generation in France), Germany experiences much higher emission factors than France. At the same time, German emissions fall from 2015 to 2030 due to the strong growth of renewable generation, while the French production-based emission factor (EF^{PB}) increases for all scenarios due to increased generation from natural gas in 2030. Consumption-based average mix emission factors (EF^{CB}) remain stable, indicating that the increase in carbon-intensive domestic production is compensated through less carbon-intensive imports. The impact of charging strategies on total emissions is negligible, reflected in the average mix emission factor.

Aggregators of PEV charging are likely to focus their communication on allocated emission factors, i.e., utilization of green electricity reporting using GoOs. As described in Sections 3.2 and 3.3, aggregators in *Opt RES* and *Max RES* buy up to 10% of domestic, time-specific GoOs to cover PEV electricity consumption. PEV charging is then scheduled according to the different scenarios in order to stay below the GoO availability. Any PEV consumption above the 10% of renewables available at the respective hour then causes emissions according to EF^{CB} . The results in Table 4 show how successful all smart charging strategies are at lowering Germany's allocated emission factors (AEF) compared to *Uncontrolled* charging. AEF for *Opt Price* is also lower than *Uncontrolled* by around a third. Despite excess PEV demand occurring in most hours for French aggregators (cf. Figure 10 in Appendix B), their allocated emission factors remain relatively stable and are at a very low level due to the lower emissions of the French electricity mix.

When comparing marginal emission factors (MEF), result interpretation becomes more complex. Comparing 2015 and 2030 values, the trend towards lower factors in Germany and higher factors in

France remains unchanged or is even amplified¹⁰ (e.g., MEF^{PB} in Germany with *Opt Price* charging). For Germany, under consideration of PB emissions, more and higher demand peaks in *Opt Price* and *Opt RES* allow more carbon-intensive power plants to run as opposed to in the more balanced scenarios *Uncontrolled* and *Max RES*. In France, the effect appears reversed and *Opt Price* shows the lowest MEF^{PB} . The trend continues for CB emissions on a slightly higher level, hinting at similar and compounding mechanisms in export markets. For Germany, MEF^{CB} appears to be more stable across scenarios but at a much higher level due to domestic production and additional imports from carbon-intensive Polish coal production in times of excess demand. Notable are the higher MEF in Germany for *Opt RES*. Under the considered CO₂ prices, power plants at the lower end of the Merit order tend to have higher emission factors, i.e., coal power plants compared to gas turbines. A higher focus on RES by PEV optimization leads to intersections of demand and supply lower down in the Merit order, thus at power plants with higher emission factors. A similar effect occurs in France, where the more extreme charging strategies lead to comparatively lower MEF than the more balanced scenarios *Uncontrolled* and *Max RES*. With baseload supplied mainly by nuclear power plants, hard coal power plants are often price-setting in times of medium load. Higher demand peaks from PEV under *Opt Price* or *Opt RES* at night lead to further use of lower-emitting gas power plants.

6. Discussion

The holistic nature of the market simulation leads to complex results, which are discussed in detail below. Section 6.1 explores the sensitivity of the results in response to changes in the availability of RES production for the aggregator. Section 6.2 then summarizes and discusses all results and reaches a synopsis of research question RQ3. The limitations of our approach are discussed in Section 6.3.

6.1. Sensitivity: RES availability

One of the core premises of the simulation is the reservation of 10% of renewable production for PEV charging in the scenarios *Opt RES* and *Max RES*. Below, Figure 9 shows how selected result metrics change in response to variations of the 10%-quota (x-axis).

¹⁰ The negative values for France in 2015 indicate that PEV allow an improved utilization of less polluting powerplants such as nuclear power plants. For example, increased PEV charging under *Opt RES* at midday due to peak PV generation, when the generally high system load also requires generation from fossil-fueled power plants, leads to higher emissions than if charging remained at night. However, this only works if nuclear units are not running at full power at night.

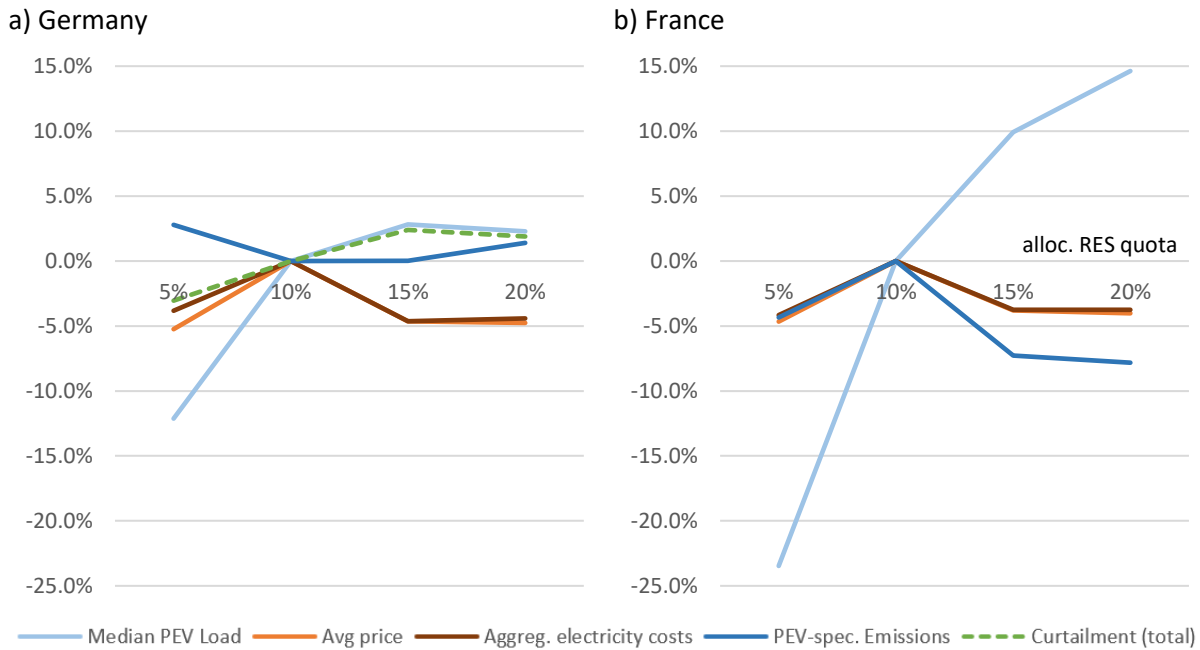

Figure 9: Sensitivity of results (y-axis) in response to deviations from 10% allocated RES for Opt RES (x-axis) for a) Germany and b) France. Panel a) also shows results for the total curtailment across all markets (green dashed line).

With less limitations on power demand, i.e., increased allocated RES quota, the PEV load becomes more eccentric, and the median PEV load increases. The effect is more dramatic in France, where less RES is available in total and therefore represents a tighter boundary condition for PEV scheduling. The average prices and aggregated electricity costs are similar for both markets and around 5% lower than the base case at the 10%-RES quota. In France, PEV-specific emissions decrease by around 8% with growing RES-shares for PEV charging, while in Germany, PEV emissions are stable or increase slightly when deviating from the 10%-RES quota. Finally, total curtailment across all markets appears to increase with a higher allocated RES quota, indicating that excess RES availability leaves room for a stronger focus on price optimization and less forced use of, e.g., the lunch solar peak or imports from Danish wind power plants. At 10% RES availability, the optimization model appears to be at an inflection point between heavy price and some RES focus.

The most sensitive result parameter is the hourly PEV load. Its standard deviations dramatically increase when deviating from the 10%-share, especially in France, where less RES are available (cf. Table 5 in Appendix B). This implies that additional gains for aggregators are possible with country-specific adaptations to their load scheduling algorithms. In the long run, this could lead to increased competition among aggregators. Meanwhile, more extreme PEV demand exposes aggregators to greater price risk. At the same time, results on electricity costs in Figure 9 indicate that these more extreme load schedules are beneficial as they help reduce peak loads (and therefore peak prices) throughout the system, at least under the strategy *Opt RES*. As the largest standard deviation occurs in France, with 5% of RES made available to PEV, this can be interpreted as restricted RES availability leading to more erratic responses from market participants, such as PEV. If flexible demand is to take advantage of real-time RES availability, there must be sufficient RES production to reliably provide enough RES – but also provide tangible incentives for market participants. Such incentives could also motivate aggregators (and consumers) without sustainability goals to respond to RES availability and decrease PEV-specific emissions. Real-time RES supply is a tool to increase RES usage in the transitional period towards fully renewable energy systems.

6.2. Synopsis: Can charging PEV be carbon neutral? (RQ3)

The question of carbon-neutral PEV charging within the complex, traditionally fossil fuel-based European electricity system, can be approached from multiple angles:

Firstly, when considering our results on total emissions (cf. Section 5.2.2), the notion of carbon-neutrality for PEV must be viewed with scepticism: Under exogenous (i.e., politically desired and supported) RES-expansion levels, additional demand from PEV causes additional emissions – and different charging strategies barely change that outcome. While PEV can cause substantial demand peaks, their total energy consumed remains relatively small until 2030 compared to, e.g., Germany's overall energy demand. In France, the charging strategy has a more substantial impact due to the currently low level of emissions, especially considering that less energy from RES is available, which often restricts the optimization. Nevertheless, both the transport and energy sector are in a transitional period, and with more RES and functional markets, both sectors can work towards decarbonization.

On top of that, curtailment was successfully reduced in our simulation through the application of different charging strategies, indicating a better inclusion of RES. However, the effect is too small to register in the total amount of European emissions by 2030, potentially also due to the exclusive consideration of international curtailment instead of curtailment caused by grid bottlenecks within countries. For example, Germany curtailed almost 6.5 TWh of renewables in 2019 due to transmission and distribution grid restrictions (BNetzA, 2021), ten times the total curtailment in all market areas exhibited in this simulation (cf. Figure 7). However, our results still indicate that PEV charging under consideration of availability of RES may help mitigate such inefficiencies in the future.

Conversely, the results can be interpreted from a different perspective: Instead of carving out 10% of RES for the use of PEV, we conclude that with an additional 10% of RES, most power demand from PEV can be covered in 2030, rather than mandating construction of new conventional power plants. If PEV were to drive additional demand for RES, investors may be incentivized to expand RES capacity. Additional RES capacity contributes to higher RES shares and, therefore, a more sustainable overall electricity mix. Even if the power balance of RES and PEV consumption is not part of the premise set, additional RES capacity will be built if RES is the cheapest technology. According to our results, covering daily PEV charging demand with 100% renewables on 98% of days would require an additional 19% / 17% of energy provided from RES in Germany / France. The higher share of flexible hydropower production in the French electricity mix leads to the lower value, as for this calculation, we assumed that all RES technologies scale in parallel.

Drastic reductions of overall carbon emissions will require a more fundamental overhaul of the electricity system with considerably more carbon-free production and storage solutions. For PEV charging scheduling to have a significant effect, the flexibility potential of PEV has to be increased, i.e., the amount of energy that can be shifted over a specific time frame. Beyond higher PEV numbers, shifting charging events from one day to the next would be beneficial. In addition, PEV could be utilized as storage through bidirection charging flows. However, this could not be considered in our investigation.

Secondly, stepping away from total emission and taking the perspective of an aggregator or smart charging service provider shows the true strength of the different charging strategies. As seen in Section 5.2.2, different charging strategies have a remarkable impact on the emissions allocated to PEV and, therefore, the emissions the aggregator can communicate to their service customers. As a result, the correct charging strategy can benefit product marketing and economics (cf. Section 5.1.4). We showed that a mixed strategy, *Opt RES*, is the most beneficial, and if enough RES (and adequate infrastructure) are available, national real-time provision for PEV charging is possible.

We also show that smart charging approaches lead to lower total demand peaks and also slightly lower market price levels (cf. Section 5.1.3). Given appropriate market mechanisms, e.g., carbon pricing, a more efficient system could also be achieved with lower pollution levels. The promising results for curtailment show a clear trend, but further analysis is necessary to scale these results to real market levels correctly.

In conclusion, green charging can be achieved in 2030 from the vantage point of aggregators marketing charging services with allocated emissions (as is common practice today). Both AEF^{CB} and AEF^{PB} approach zero in 2030 with increasing RES availability. The real-time RES provision enables service providers to demonstrate the positive impact of their charging scheduling on the energy system and reassert their customers in their contribution to sustainable transport through PEV.

The interpretation from the service perspective has further implications: With only an additional 10% of RES, the total additional energy consumption of PEV can be fully compensated using real-time GoOs. Our simulation shows transparently how the service perspective and system benefits may align. This discussion could inform policy decision-making and stakeholder dialogues on PEV and, in the long run, leads to coupling between the energy and transport sector.

Our results on aggregator costs also indicate that aggregators may have market power (cf. Section 5.1.3): *Opt Price* aggregators have higher electricity costs than with *Opt RES* at a lower average price level, indicating that their bidding behavior increases the price excessively (due to limitations in the endogenous price prognosis). Large aggregators could learn to adapt their bidding behavior and use such effects to their benefit. As stated in Section 3.1, our simulation uses a single aggregator per market area. However, PEV charging demand is allocated 1/20th at a time to mitigate synchronization effects and excessive peak load. This allocation could also be interpreted as 20 aggregators per market area bidding sequentially into the market. The final aggregator to bid anticipates all other aggregators' bidding behavior.

6.3. Limitations

Due to runtime limitations, we implemented active market coupling only between selected European countries with a strong focus on the German market. This leads to a limitation for the French case as interconnections with Spain and the UK are not explicitly modelled. The integration of further market areas could influence the results but would also drastically increase computation time and likely not influence the main conclusions of this paper. Furthermore, we use one set of base data for the development of demand, market penetration of RES, development of carbon prices and different technology options. The set is consistent and has been used for many other publications (e.g., Fraunholz et al., 2021; Zimmermann et al., 2021) so that our results can build on the literature. While an update of the data set in future work could be possible, newer RES scenarios are often even more ambitious. This indicates our results represent a more conservative development.

In terms of model results, we can assume that the investments in flexible power plants will not take place to the modeled extent in reality and are subject to model-related restrictions since the model, in particular, cannot invest in additional RES. However, it remains uncertain whether additional RES can be added at a rate sufficient to meet the additional PEV demand. Also, emission assessments may be estimated too low as the partial operation of power plants is only considered rudimentarily and higher inefficiencies at ramp-up and -down are likely in reality.

The modeling of PEV is limited in multiple ways: First, the ramp-up of vehicle numbers is based on national objectives, as our focus is on determining the charging behavior of the users rather than delving into adoption research. Here, a fundamental assumption is that household mobility behavior does not change when conventional cars are substituted with PEV, and that average daily driving

behavior is constant throughout the year. In addition, we use the same average parametrization for all PEV (consumption: 0.2 kWh/km; range 300 km; 60 kWh batteries; 3.7 kW chargers) in order to simplify the model. For the same reason, all markets except France use the same mobility patterns as Germany, and as stated previously, optimization happens only within one day and not in preparation for the following day. However, the use of averages and the listed abstractions for the simulation is justified because the focus of this paper is to assess the impacts of charging strategies of PEV fleets on the energy sector rather than modeling individual mobility behavior.

Arguably, electrification of the European transport sector is not associated with any additional emissions during the use phase of PEV due to the EU Emission Trading Scheme (Jochem et al., 2015). However, doubts concerning the efficiency of the scheme are expressed repeatedly (Paltsev et al., 2018). For example, savings can be achieved more cheaply in other sectors than in road transport (Heinrichs et al., 2014). As a result (and if carbon contracts for difference are not available), energy-intensive industries might migrate to regions with lower emission standards.

Aspects under only limited consideration in our market simulation are national grid restrictions. As seen above, PEV charging may lead to new load peaks, which combine national prices and renewable availability but pays no heed to the localization of grid connections, decentralized RES production or PEV demand. In practice, aggregators will have to consider restrictions imposed by grid operators, e.g., load limitations.

Overcoming the methodological limitations above would add further complexity to the simulation without necessarily improving the answers to the research questions. We are confident to have derived significant and robust findings.

7. Conclusions and future work

With rising numbers of plug-in electric vehicles (PEV) in Europe, their impact on the energy system will become more and more apparent. In this paper, we analyzed how different charging strategies considering spot market prices and real-time production from renewable energy sources (RES) impact price levels and production- and consumption-based carbon emissions in France and Germany. We use the agent-based simulation model PowerACE covering ten electricity markets in Central Europe. Total European carbon emissions do not change significantly in response to the charging strategy since the total energy volume charged by electric vehicles in 2030 remains comparatively small. Nevertheless, our results show that all smart charging strategies reduce price levels on the spot market and lower total curtailment of renewables, with charging processes optimized according to hourly prices having the strongest effect. However, the total amount of reduction in curtailment of RES is relatively small compared to total system demand and therefore does not noticeably impact total annual emissions. This effect is likely underrepresented as we only consider international grid congestion, while most curtailment is due to national and regional bottlenecks.

Compared to uncontrolled charging, smart charging strategies reduce electricity purchasing costs by about 10% for flexibility aggregators operating the charging service. In addition, the strategies allow for communication of deeper decarbonization due to lower allocated emission factors. A charging strategy expanding on classic price optimization by limiting total national PEV demand to 10% of available RES (*Opt RES*) leads to the most advantageous results in both metrics. Aggregators and PEV owners would benefit from the availability of national, real-time Guarantees of Origin and the respective scarcity signals for renewable production.

Finally, our results indicate that in the medium term, it is essential for regulators to incentivize enough RES to reduce the system's total carbon emissions and potential investments in flexible power plants.

Moreover, as the share of RES generation increases, the effects of smart charging will become more critical.

Future work could simulate and analyze a day-ahead market for time-specific Guarantees of Origin to understand the market dynamics under consideration of different technologies. Flexible RES production and market-scale storage would be an instrument to balance production from RES in such a system and are likely price-setters. A deeper investigation of how storages impact emissions could also be considered. Furthermore, it would be interesting to consider how bidirectional charging, i.e., vehicle-to-grid, could increase flexibility potential by PEV.

CRedit authorship contribution statement

Christian Will: Conceptualization, Methodology, Software, Formal analysis, Investigation, Data Curation, Writing – Original Draft, Writing – Review & Editing, Visualization, Project administration.

Florian Zimmermann: Conceptualization, Methodology, Software, Validation, Formal analysis, Investigation, Data Curation, Writing – Original Draft, Writing – Review & Editing, Visualization. **Axel**

Ensslen: Conceptualization, Methodology, Software, Writing – Original Draft, Writing – Review & Editing. **Christoph Fraunholz:** Methodology, Software, Writing – Review & Editing. **Patrick Jochem:**

Conceptualization, Supervision, Writing – Review & Editing. **Dogan Keles:** Conceptualization, Supervision, Writing – Review & Editing.

Acknowledgements

The research was made possible as part of the BDL [grant number 01MV18004H], MODEX-EnSAves project [grant number 03ET4079D], and VerSEAS [grant number 03EI1018A], all funded by the German Federal Ministry for Economic Affairs and Climate Action, and the Profilregion Mobilitätssysteme Karlsruhe funded by the Ministry of Science, Research and the Arts Baden-Württemberg (MWK).

Appendix A: Detailed carbon calculation

CO₂ emissions of a market area, which are embodied in PEV-specific consumption, are calculated based on the following accounting balance of power flows for each market area $r \in R$ in hour t (Eq. (25)):

$$PROD_{r,t} = CONS_{r,t} + EXP_{r,t} - IMP_{r,t} \quad \forall t, \forall r \quad (25)$$

The amount of electricity produced in a market area ($PROD$) must be equal to the consumed amount of electricity ($CONS$). However, in the application of multi-regional input-output analysis, when electricity is exported (EXP), domestic production is increased, while when electricity is imported (IMP), domestic production is decreased (Peters and Hertwich, 2009). Every particular market area's export must be imported into another market area.

In Europe, electricity is generated predominantly in flexible thermal power plants burning fossil fuels. As a result, CO₂ is emitted in the market areas where the power plant is located, but the electricity demand may originate in another market area. In order to perform a market area-specific analysis of the emissions, it is necessary to allocate the emissions to the individual market areas based on causation because the highly interconnected and coupled markets in Europe lead to a permanent exchange of electricity.

Therefore, we develop a demand-based allocation approach for the electricity market model based on Tranberg et al. (2019): All emissions produced must be equal to the consumed emissions (Eq. (26)). Losses (e.g., grid, self-consumption) are neglected. Further, we do not keep track of storage charging and discharging emissions.

$$\sum_{r \in R} E_{r,t}^{cons} = \sum_{r \in R} E_{r,t}^{prod} \quad \forall t \quad (26)$$

Additionally, the energy as well as the emissions that are exported or imported, must be balanced. Consequently, the consumed emissions in a market area must be equal to the produced and the imported emissions reduced by exported emissions (Eq. (27)).

$$E_{r,t}^{cons} = E_{r,t}^{prod} + E_{r,t}^{imp} - E_{r,t}^{exp} \quad \forall t, \forall r \quad (27)$$

A neighboring (interconnected) market area m can export electricity to or import from the domestic market area r that leads to an account for emissions according to the substitutes for import and export in Eq. (28). All exports of market area r are imports in other market areas. Analogously, the imports are the sum of exports from other market areas into market area r . In case of no flows in the considered direction, the emission value for this flow is zero:

$$E_{r,t}^{cons} = E_{r,t}^{prod} + \sum_{m \in R \setminus \{r\}} E_{m \rightarrow r,t}^{exp} - \sum_{m \in R \setminus \{r\}} E_{r \rightarrow m,t}^{imp} \quad \forall t, \forall r \quad (28)$$

Meanwhile, the consumption-based emissions $E_{r,t}^{cons}$ can be calculated from specific emissions $CO2_{r,t}^{spec}$ (in metric tons per MWh) and electricity demand $CONS_r$ (in MWh) in a specific market area r . Therefore, the result is the absolute CO_2 emissions in metric tons (Eq. (29)).

$$E_{r,t}^{cons} = CONS_{r,t} \cdot CO2_{r,t}^{spec} \quad \forall t, \forall r \quad (29)$$

The respective flows multiplied by the specific emission factor increase or decrease the local emissions by the resulting absolute value E^{exp} or E^{imp} . Therefore, the emissions can be calculated for exchange flows (export flows from market area r to m , Eq. (30), as well as import flows from market area m to r , Eq. (31)). The specific emission factors must be taken from the area where the energy flow originates. For exports, the flow originates in the domestic area (market area r); for imports, the flow originates from market area m .

$$E_{r \rightarrow m,t}^{exp} = FLOW_{r \rightarrow m,t} \cdot CO2_{r,t}^{spec} \quad \forall t, \forall r \quad (30)$$

$$E_{m \rightarrow r,t}^{imp} = FLOW_{m \rightarrow r,t} \cdot CO2_{m,t}^{spec} \quad \forall t, \forall r \quad (31)$$

The absolute emissions of generated electricity $E_{r,t}^{prod}$ in area r can be measured as a result of power plant dispatch within the model. Eq. (29)-(31) are inserted into Eq. (28).

$$CONS_{r,t} \cdot CO2_{r,t}^{spec} = \frac{E_{r,t}^{prod} + \sum_{m \in R \setminus \{r\}} FLOW_{m \rightarrow r,t} \cdot CO2_{m,t}^{spec} - \sum_{m \in R \setminus \{r\}} FLOW_{r \rightarrow m,t} \cdot CO2_{r,t}^{spec}}{CO2_{r,t}^{spec}} \quad \forall t, \forall r \quad (32)$$

After the reorganization of Eq. (32) (to $E_{r,t}^{prod}$) a linear system of equations for all market areas r can be built to solve ex-post for every hour t . Known are all exchange flows $FLOW_{r \rightarrow m,t}$, the demand $CONS_{r,t}$ and the emissions emitted $E_{r,t}^{prod}$ as hourly results of the model or given input data. This allows the calculation of the specific emissions $CO2_{r,t}^{spec}$ of each market area r for all hours t . Eq. (33) shows the resulting $n \times n$ -matrix for the example of Germany ($r = DE$):

$$\begin{pmatrix} CONS_{DE,t} + \sum_{m \in R \setminus \{r\}} FLOW_{DE \rightarrow m,t} & \cdots & -FLOW_{n \rightarrow DE,t} \\ \vdots & \ddots & \vdots \\ -FLOW_{DE \rightarrow n,t} & \cdots & CONS_{n,t} + \sum_{m \in R \setminus \{r\}} FLOW_{n \rightarrow m,t} \end{pmatrix} \forall t \quad (33)$$

$$\cdot \begin{pmatrix} CO2_{DE,t}^{spec} \\ \vdots \\ CO2_{n,t}^{spec} \end{pmatrix} = \begin{pmatrix} E_{DE,t}^{prod} \\ \vdots \\ E_{n,t}^{prod} \end{pmatrix}$$

Appendix B: Supplementary information on the market outcome

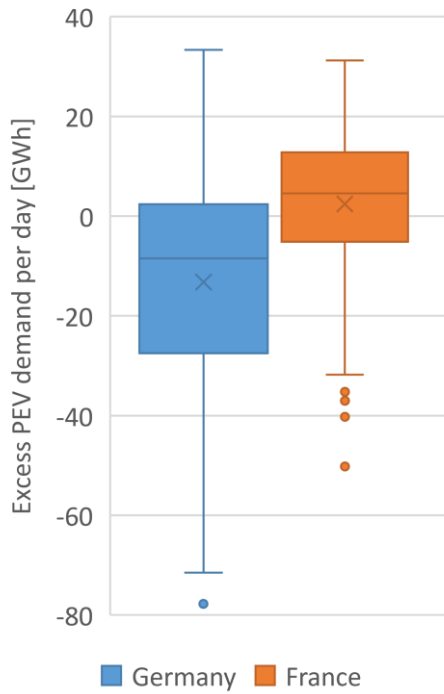

Figure 10: Excess PEV demand (positive values) above 10% RES-availability per day for Germany and France in 2030 for all scenarios

Table 5: Descriptive statistics for hourly PEV-demand $\sum_x e_{t,x}$ in Germany and France in 2030 in response to different RES allocations. Median values are shown in Figure 9.

RES allocation	Min		Median		Max		Std. dev.	
	GER	FR	GER	FR	GER	FR	GER	FR
5%-quota	34.07%	83.68%	-12.13%	-23.47%	49.71%	1.57%	21.50%	44.62%
10%-quota	0%	0%	0%	0%	0%	0%	0%	0%
15%-quota	-0.36%	-15.33%	2.82%	9.92%	-8.89%	-21.30%	15.91%	17.33%
20%-quota	-6.37%	-15.33%	2.30%	14.63%	5.19%	-11.75%	23.48%	34.15%

References

- AIB, 2021. Facts | Market information | Activity statistics | Statistics - to end March 2021 v1. Association of Issuing Bodies. <https://www.aib-net.org/facts/market-information/statistics/activity-statistics-all-aib-members>. Accessed 19 April 2022.
- Barrett, J., Peters, G., Wiedmann, T., Scott, K., Lenzen, M., Roelich, K., Le Quéré, C., 2013. Consumption-based GHG emission accounting: A UK case study. *Climate Policy* 13, 451–470.
- Bekel, K., Pauliuk, S., 2019. Prospective cost and environmental impact assessment of battery and fuel cell electric vehicles in Germany. *The International Journal of Life Cycle Assessment* 24, 2220–2237.
- Bellekom, S., Benders, R., Pelgröm, S., Moll, H., 2012. Electric cars and wind energy: Two problems, one solution? A study to combine wind energy and electric cars in 2020 in The Netherlands. *Energy* 45, 859–866.
- Bickert, S., Kampker, A., Greger, D., 2015. Developments of CO₂-emissions and costs for small electric and combustion engine vehicles in Germany. *Transportation Research Part D: Transport and Environment* 36, 138–151.
- BMK, 2020. E-Mobilitätsoffensive: Förderungen werden 2021 fortgesetzt. Bundesministerium Klimaschutz, Umwelt, Energie, Mobilität, Innovation und Technologie. https://www.bmk.gv.at/service/presse/gewessler/20201127_e_offensive.html. Accessed 19 January 2022.
- BMVI, 2021. Bekanntmachung der Richtlinie über den Einsatz von Bundesmitteln im Rahmen des BMVI-Programms „Ladeinfrastruktur vor Ort“. Bundesministerium für Verkehr und digitale Infrastruktur. Accessed 19 January 2022.
- BMW, BMVBS, BMU, BMBF, 2011. Regierungsprogramm Elektromobilität. https://www.bmwk.de/Redaktion/DE/Downloads/P-R/regierungsprogramm-elektromobilitaet-mai-2011.pdf?__blob=publicationFile&v=6. Accessed 28 December 2022.
- BNetzA, 2021. Monitoringbericht 2020. Bundesnetzagentur, Bonn. https://www.bundesnetzagentur.de/DE/Sachgebiete/ElektrizitaetundGas/Unternehmen_Instituten/DatenaustauschundMonitoring/Monitoring/Monitoring_Berichte_node.html. Accessed 13 July 2021.
- Bourbon, J.-C., 2017. Le développement des voitures électriques met le réseau sous tension. La-Croix.com.
- Brauer, F., Finck, R., McKenna, R., 2020. Comparing empirical and model-based approaches for calculating dynamic grid emission factors: An application to CO₂-minimizing storage dispatch in Germany. *Journal of Cleaner Production* 266, 121588.
- Bublitz, A., Keles, D., Zimmermann, F., Fraunholz, C., Fichtner, W., 2019. A survey on electricity market design: Insights from theory and real-world implementations of capacity remuneration mechanisms. *Energy Economics* 80, 1059–1078.
- Bublitz, A., Ringler, P., Genoese, M., Fichtner, W., 2015. Agent-Based Simulation of Interconnected Wholesale Electricity Markets: An Application to the German and French Market Area. In: Duval, B., van den Herik, J., Loiseau, S., Filipe, J. (Eds.) *Agents and Artificial Intelligence*. Springer International Publishing, Cham.
- Chatzikomis, C.I., Spentzas, K.N., Mamalis, A.G., 2014. Environmental and economic effects of widespread introduction of electric vehicles in Greece. *Eur. Transp. Res. Rev.* 6, 365–376.
- Creutzig, F., Jochem, P., Edelenbosch, O.Y., Mattauch, L., van Vuuren, D.P., McCollum, D., Minx, J., 2015. Energy and environment. Transport: A roadblock to climate change mitigation? *Science (New York, N.Y.)* 350, 911–912.

- Dallinger, D., Wietschel, M., 2012. Grid integration of intermittent renewable energy sources using price-responsive plug-in electric vehicles. *Renewable and Sustainable Energy Reviews* 16, 3370–3382.
- Doluweera, G., Hahn, F., Bergerson, J., Pruckner, M., 2020. A scenario-based study on the impacts of electric vehicles on energy consumption and sustainability in Alberta. *Applied Energy* 268, 114961.
- Donateo, T., Licci, F., D’Elia, A., Colangelo, G., Laforgia, D., Ciancarelli, F., 2015. Evaluation of emissions of CO₂ and air pollutants from electric vehicles in Italian cities. *Applied Energy* 157, 675–687.
- Doucette, R.T., McCulloch, M.D., 2011. Modeling the CO₂ emissions from battery electric vehicles given the power generation mixes of different countries. *Energy Policy* 39, 803–811.
- Douglas, B., Hunt, H., 2021. A Timely Match - White paper. Accelerating power system decarbonisation by moving towards 24/7 matching in corporate renewable electricity (RES-E) sourcing and market integration. RE-Source; Eurelectric. <https://247res.eurelectric.org/>. Accessed 21 March 2022.
- Ekman, C.K., 2011. On the synergy between large electric vehicle fleet and high wind penetration – An analysis of the Danish case. *Renewable Energy* 36, 546–553.
- Ensslen, Will, Jochem, 2019. Simulating Electric Vehicle Diffusion and Charging Activities in France and Germany. *WEVJ* 10, 73.
- Ensslen, A., 2019. Gesteuertes Laden von Elektrofahrzeugen in Frankreich und Deutschland. Phd thesis, Karlsruhe.
- Ensslen, A., Paetz, A.-G., Babrowski, S., Jochem, P., Fichtner, W., 2016. On the Road to an Electric Mobility Mass Market—How Can Early Adopters be Characterized? In: Fornahl, D., Hülsmann, M. (Eds.) *Markets and Policy Measures in the Evolution of Electric Mobility*. Springer International Publishing, Cham, pp. 21–51.
- Ensslen, A., Ringler, P., Dörr, L., Jochem, P., Zimmermann, F., Fichtner, W., 2018. Incentivizing smart charging: Modeling charging tariffs for electric vehicles in German and French electricity markets. *Energy Research & Social Science* 42, 112–126.
- Ensslen, A., Ringler, P., Jochem, P., Keles, D., Fichtner, W., 2014. About business model specifications of a smart charging manager to integrate electric vehicles into the German electricity market, in: *Proceedings of the 14th IAEE European Conference*. 14th IAEE European Conference, Rome, Italy. October 28-31.
- Ensslen, A., Schücking, M., Jochem, P., Steffens, H., Fichtner, W., Wollersheim, O., Stella, K., 2017. Empirical carbon dioxide emissions of electric vehicles in a French-German commuter fleet test. *Journal of Cleaner Production* 142, 263–278.
- ENTSO-E, 2017. Consumption Data. <https://www.entsoe.eu/data/data-portal/consumption/Pages/default.aspx>.
- ENTSO-E, 2018a. Ten-Year Network Development Plan (TYNDP) 2018. <https://www.entsoe.eu/Documents/TYNDP%20documents/TYNDP2018/Scenarios%20Data%20ets/Input%20Data.xlsx>. Accessed 5 June 2021.
- ENTSO-E, 2018b. Transparency Platform. <https://transparency.entsoe.eu/>. Accessed 5 June 2021.
- EPEX Spot, 2021. Market Data. <https://www.epexspot.com/en/market-data>. Accessed 5 June 2021.
- Eurelectric, 2022. A Timely Match: 24/7 renewable electricity for corporates.
- European Commission, 2016. EU reference scenario 2016: Energy, transport and GHG emissions: trends to 2050. Publications Office, Luxembourg, 1 online resource (217).
- European Environment Agency, 2020. Annual European Union greenhouse gas inventory 1990-2018 and inventory report 2020: Submission to the UNFCCC Secretariat.

- https://www.eea.europa.eu/ds_resolveuid/e77e158988914876a5ece9475b246b7c. Accessed 10 April 2022.
- Fabianek, P., Will, C., Wolff, S., Madlener, R., 2020. Green and regional? A multi-criteria assessment framework for the provision of green electricity for electric vehicles in Germany. *Transportation Research Part D: Transport and Environment* 87.
- Faria, R., Marques, P., Moura, P., Freire, F., Delgado, J., Almeida, A.T. de, 2013. Impact of the electricity mix and use profile in the life-cycle assessment of electric vehicles. *Renewable and Sustainable Energy Reviews* 24, 271–287.
- Faria, R., Moura, P., Delgado, J., Almeida, A.T. de, 2014. Managing the Charging of Electrical Vehicles: Impacts on the Electrical Grid and on the Environment. *IEEE Intell. Transport. Syst. Mag.* 6, 54–65.
- Franzen, A., Mader, S., 2018. Consumption-based versus production-based accounting of CO₂ emissions: Is there evidence for carbon leakage? *Environmental Science & Policy* 84, 34–40.
- Fraunholz, C., 2021. Market Design for the Transition to Renewable Electricity Systems. Dissertation. Karlsruhe Institut für Technologie (KIT), Karlsruhe, Germany.
- Fraunholz, C., Keles, D., Fichtner, W., 2019. Agent-Based Generation and Storage Expansion Planning in Interconnected Electricity Markets, in: *EEM19 Proceedings. 16th International Conference on the European Energy Market (EEM)*, Ljubljana, Slovenia. 18.-20.09.2019. IEEE, Piscataway, NJ, USA, pp. 1–6.
- Fraunholz, C., Keles, D., Fichtner, W., 2021. On the role of electricity storage in capacity remuneration mechanisms. *Energy Policy* 149, 112014.
- García-Villalobos, J., Zamora, I., San Martín, J.I., Asensio, F.J., Aperribay, V., 2014. Plug-in electric vehicles in electric distribution networks: A review of smart charging approaches. *Renewable and Sustainable Energy Reviews* 38, 717–731.
- Genoese, M., 2010. *Energiawirtschaftliche Analysen des deutschen Strommarkts mit agentenbasierter Simulation*, 1st ed. Nomos, Baden-Baden, 1 p.
- Gnann, T., Klingler, A.-L., Kühnbach, M., 2018. The load shift potential of plug-in electric vehicles with different amounts of charging infrastructure. *Journal of Power Sources* 390, 20–29.
- Gohla-Neudecker, B., Kuhn, p., Hamcher, T., Wagner, U., 2011. Sustainable Mobility - Modelling a Cost-Efficient Supply of Renewables for EVs, in: *2011 International Conference on Clean Electrical Power (ICCEP). International Conference on Clean Electrical Power*, Ischia, Italy. 14.-16.06.2011, pp. 189–195.
- Gonzalez Vaya, M., Andersson, G., 2015. Optimal Bidding Strategy of a Plug-In Electric Vehicle Aggregator in Day-Ahead Electricity Markets Under Uncertainty. *IEEE Trans. Power Syst.* 30, 2375–2385.
- Graff Zivin, J.S., Kotchen, M.J., Mansur, E.T., 2014. Spatial and temporal heterogeneity of marginal emissions: Implications for electric cars and other electricity-shifting policies. *Journal of Economic Behavior & Organization* 107, 248–268.
- Guerci, E., Rastegar, M.A., Cincotti, S., 2010. Agent-based Modeling and Simulation of Competitive Wholesale Electricity Markets. In: Rebennack, S., Pardalos, P.M., Pereira, M.V.F., Iliadis, N.A. (Eds.) *Handbook of Power Systems II*. Springer Berlin Heidelberg, Berlin, Heidelberg, pp. 241–286.
- Haider, S., Schegner, P., 2021. Simulating the Impacts of Uncontrolled Electric Vehicle Charging in Low Voltage Grids. *Energies* 14.
- Hawkes, A.D., 2010. Estimating marginal CO₂ emissions rates for national electricity systems. *Energy Policy* 38, 5977–5987.
- Hawkins, T.R., Singh, B., Majeau-Bettez, G., Strømman, A.H., 2013. Comparative Environmental Life Cycle Assessment of Conventional and Electric Vehicles. *Journal of Industrial Ecology* 17, 53–64.

- Heinrichs, H., Jochem, P., Fichtner, W., 2014. Including road transport in the EU ETS (European Emissions Trading System): A model-based analysis of the German electricity and transport sector. *Energy* 69, 708–720.
- Heinrichs, H.U., Jochem, P., 2016. Long-term impacts of battery electric vehicles on the German electricity system. *Eur. Phys. J. Spec. Top.* 225, 583–593.
- Hu, J., Morais, H., Sousa, T., Lind, M., 2016. Electric vehicle fleet management in smart grids: A review of services, optimization and control aspects. *Renewable and Sustainable Energy Reviews* 56, 1207–1226.
- Huber, J., Lohmann, K., Schmidt, M., Weinhardt, C., 2021. Carbon efficient smart charging using forecasts of marginal emission factors. *Journal of Cleaner Production* 284, 124766.
- Huber, J., Schaule, E., Jung, D., Weinhardt, C., 2019. Quo Vadis Smart Charging? A Literature Review and Expert Survey on Technical Potentials and User Acceptance of Smart Charging Systems. *WEVI* 10, 85.
- IEA, 2021. Tracking Transport 2021. International Energy Agency, Paris, France. <https://www.iea.org/reports/tracking-transport-2021>. Accessed 22 May 2022.
- infas, 2008. Mobilität in Deutschland. infas. <http://www.mobilitaet-in-deutschland.de/mid2008-publikationen.html>. Accessed 28 June 2018.
- Jochem, P., Babrowski, S., Fichtner, W., 2015. Assessing CO₂ emissions of electric vehicles in Germany in 2030. *Transportation Research Part A: Policy and Practice* 78, 68–83.
- Juul, N., Meibom, P., 2011. Optimal configuration of an integrated power and transport system. *Energy* 36, 3523–3530.
- Kamiya, G., Axsen, J., Crawford, C., 2019. Modeling the GHG emissions intensity of plug-in electric vehicles using short-term and long-term perspectives. *Transportation Research Part D: Transport and Environment* 69, 209–223.
- Keles, D., Bublitz, A., Zimmermann, F., Genoese, M., Fichtner, W., 2016. Analysis of design options for the electricity market: The German case. *Applied Energy* 183, 884–901.
- Kessler, M., 2021. Kampagne gegen das E-Auto? zdf heute.
- Khan, I., 2018. Importance of GHG emissions assessment in the electricity grid expansion towards a low-carbon future: A time-varying carbon intensity approach. *Journal of Cleaner Production* 196, 1587–1599.
- Kraft, E., 2017. Analysis and Modelling of the French Capacity Mechanism. Springer Fachmedien Wiesbaden, Wiesbaden.
- Kühnbach, M., Stute, J., Klingler, A.-L., 2021. Impacts of avalanche effects of price-optimized electric vehicle charging - Does demand response make it worse? *Energy Strategy Reviews* 34, 100608.
- Lehmann, N., Beikirch, P., 2020. Eco-Labeling of green energy tariffs - analysis of the influence of eco-labels on consumer behavior, in: EEM20 Proceedings. 17th International Conference on the European Energy Market (EEM), Stockholm, Sweden. 16.-18.09.2020. IEEE, Piscataway, NJ, USA, pp. 1–8.
- Li, M., Smith, T.M., Yang, Y., Wilson, E.J., 2017. Marginal Emission Factors Considering Renewables: A Case Study of the U.S. Midcontinent Independent System Operator (MISO) System. *Environmental science & technology* 51, 11215–11223.
- Ma, H., Balthasar, F., Tait, N., Riera-Palou, X., Harrison, A., 2012. A new comparison between the life cycle greenhouse gas emissions of battery electric vehicles and internal combustion vehicles. *Energy Policy* 44, 160–173.
- Malik, A., McBain, D., Wiedmann, T.O., Lenzen, M., Murray, J., 2018. Advancements in Input-Output Models and Indicators for Consumption-Based Accounting. *Journal of Industrial Ecology* 3, 175.
- Märtz, A., Plötz, P., Jochem, P., 2021. Global perspective on CO₂ emissions of electric vehicles. *Environ. Res. Lett.* 16.

- MEEDDM, 2008. Enquête nationale transports et déplacements 2008. Ministère de l'Environnement, de l'Energie et de la Mer. <http://www.statistiques.developpement-durable.gouv.fr/transports/s/transport-voyageurs-deplacements.html>. Accessed 28 June 2018.
- Muneer, T., Milligan, R., Smith, I., Doyle, A., Pozuelo, M., Knez, M., 2015. Energetic, environmental and economic performance of electric vehicles: Experimental evaluation. *Transportation Research Part D: Transport and Environment* 35, 40–61.
- Mwasilu, F., Justo, J.J., Kim, E.-K., Do, T.D., Jung, J.-W., 2014. Electric vehicles and smart grid interaction: A review on vehicle to grid and renewable energy sources integration. *Renewable and Sustainable Energy Reviews* 34, 501–516.
- NEP, 2019. Szenariorahmen für die Netzentwicklungspläne Strom 2030 (Version 2019): Entwurf der Übertragungsnetzbetreiber. https://www.netzentwicklungsplan.de/sites/default/files/paragraphs-files/%C3%9CNB-Entwurf_Szenariorahmen_2030_V2019.pdf. Accessed 5 June 2021.
- Nielsen, E., Alkemade, F., 2016. How is value created and captured in smart grids?: A review of the literature and an analysis of pilot projects. *Renewable and Sustainable Energy Reviews* 53, 629–638.
- Olkkonen, V., Syri, S., 2016. Spatial and temporal variations of marginal electricity generation: The case of the Finnish, Nordic, and European energy systems up to 2030. *Journal of Cleaner Production* 126, 515–525.
- Paltsev, S., Henry Chen, Y.-H., Karplus, V., Kishimoto, P., Reilly, J., Löschel, A., Graevenitz, K. von, Koesler, S., 2018. Reducing CO₂ from cars in the European Union. *Transportation* 45, 573–595.
- Parag, Y., Sovacool, B.K., 2016. Electricity market design for the prosumer era. *Nat. Energy* 1, 16032.
- Paulus, M., Borggrefe, F., 2011. The potential of demand-side management in energy-intensive industries for electricity markets in Germany. *Applied Energy* 88, 432–441.
- Pearre, N.S., Swan, L.G., 2016. Electric vehicle charging to support renewable energy integration in a capacity constrained electricity grid. *Energy Conversion and Management* 109, 130–139.
- Peças Lopes, J.A., Soares, F.J., Almeida, P.M., Moreira da Silva, M., 2009. Smart Charging Strategies for Electric Vehicles: Enhancing Grid Performance and Maximizing the Use of Variable Renewable Energy Resources, in: *EVS24 Proceedings*. EVS24, Stavanger, Norway. May 13-16.
- Perez-Diaz, A., Gerding, E., McGroarty, F., 2018. Coordination and payment mechanisms for electric vehicle aggregators. *Applied Energy* 212, 185–195.
- Peters, G.P., 2008. From production-based to consumption-based national emission inventories. *Ecological Economics* 65, 13–23.
- Peters, G.P., Hertwich, E.G., 2009. The Application of Multi-regional Input-Output Analysis to Industrial Ecology. In: Tukker, A., Suh, S. (Eds.) *Handbook of Input-Output Economics in Industrial Ecology*, vol. 23. Springer Netherlands, Dordrecht, pp. 847–863.
- Platts, 2016. World Electric Power Plants Database: Global Market Data and Price Assessments - Platts. S&P Global. <https://www.platts.com/products/world-electric-power-plants-database>. Accessed 28 June 2018.
- Plötz, P., Funke, S.Á., Jochem, P., 2017. Empirical Fuel Consumption and CO₂ Emissions of Plug-In Hybrid Electric Vehicles. *Journal of Industrial Ecology* 39, 1617.
- Prognos AG, 2012. Die Energieperspektiven für die Schweiz bis 2050: Energienachfrage und Elektrizitätsangebot in der Schweiz 2000-2050. www.bfe.admin.ch/bfe/de/home/politik/energiestrategie-2050/dokumentation/energieperspektiven-2050.exturl.html/aHR0cHM6Ly9wdWJkYi5iZmUuYWwRtaW4uY2gvZGUvcHVibGJlYX/Rpb24vZG93bmxvYWQvNjczNw==.html.

- Rangaraju, S., Vroey, L. de, Messagie, M., Mertens, J., van Mierlo, J., 2015. Impacts of electricity mix, charging profile, and driving behavior on the emissions performance of battery electric vehicles: A Belgian case study. *Applied Energy* 148, 496–505.
- Richardson, D.B., 2013. Electric vehicles and the electric grid: A review of modeling approaches, Impacts, and renewable energy integration. *Renewable and Sustainable Energy Reviews* 19, 247–254.
- Ried, S., 2021. Gesteuertes Laden von Elektrofahrzeugen in Verteilnetzen mit hoher Einspeisung erneuerbarer Energien - Ein Beitrag zur Kopplung von Elektrizitäts- und Verkehrssektor.
- Ringler, P., 2017. Erzeugungssicherheit und Wohlfahrt in gekoppelten Elektrizitätsmärkten: Untersuchungen mithilfe eines agentenbasierten Simulationsmodells für die Region Zentralwesteuropa. Phd thesis, Karlsruhe.
- Ringler, P., Keles, D., Fichtner, W., 2016. Agent-based modelling and simulation of smart electricity grids and markets – A literature review. *Renewable and Sustainable Energy Reviews* 57, 205–215.
- Ringler, P., Keles, D., Fichtner, W., 2017. How to benefit from a common European electricity market design. *Energy Policy* 101, 629–643.
- Robinson, A.P., Blythe, P.T., Bell, M.C., Hübner, Y., Hill, G.A., 2013. Analysis of electric vehicle driver recharging demand profiles and subsequent impacts on the carbon content of electric vehicle trips. *Energy Policy* 61, 337–348.
- Salah, F., Flath, C.M., Schuller, A., Will, C., Weinhardt, C., 2017. Morphological analysis of energy services: Paving the way to quality differentiation in the power sector. *Energy Policy* 106, 614–624.
- Schäuble, J., Kaschub, T., Ensslen, A., Jochem, P., Fichtner, W., 2017. Generating electric vehicle load profiles from empirical data of three EV fleets in Southwest Germany. *Journal of Cleaner Production* 150, 253–266.
- Schill, W.-P., 2011. Electric vehicles in imperfect electricity markets: The case of Germany. *Energy Policy* 39, 6178–6189.
- Schröder, A., Kunz, F., Meiss, J., Mendeleevitch, R., Hirschhausen, C. von, 2013. Current and Prospective Costs of Electricity Generation until 2050. https://www.diw.de/documents/publikationen/73/diw_01.c.424566.de/diw_datadoc_2013-068.pdf. Accessed 5 June 2021.
- Sensfuß, F., Ragwitz, M., Genoese, M., Möst, D., 2007. Agent-based simulation of electricity markets – A literature review, Karlsruhe.
- Shafie-khah, M., Heydarian-Forushani, E., Golshan, M., Siano, P., Moghaddam, M.P., Sheikh-El-Eslami, M.K., Catalão, J., 2016. Optimal trading of plug-in electric vehicle aggregation agents in a market environment for sustainability. *Applied Energy* 162, 601–612.
- Sharma, R., Manzie, C., Bessedé, M., Crawford, R.H., Brear, M.J., 2013. Conventional, hybrid and electric vehicles for Australian driving conditions. Part 2: Life cycle CO₂-e emissions. *Transportation Research Part C: Emerging Technologies* 28, 63–73.
- Soimakallio, S., Saikku, L., 2012. CO₂ emissions attributed to annual average electricity consumption in OECD (the Organisation for Economic Co-operation and Development) countries. *Energy* 38, 13–20.
- Swissgrid, 2015. Energieübersicht Schweiz 2015. <https://www.swissgrid.ch/de/home/operation/grid-data.html>.
- Tamayao, M.-A.M., Michalek, J.J., Hendrickson, C., Azevedo, I.M.L., 2015. Regional Variability and Uncertainty of Electric Vehicle Life Cycle CO₂ Emissions across the United States. *Environmental science & technology* 49, 8844–8855.
- Tesfatsion, L., 2002. Agent-based computational economics: Growing economies from the bottom up. *Artificial life* 8, 55–82.

- Tranberg, B., Corradi, O., Lajoie, B., Gibon, T., Staffell, I., Andresen, G.B., 2019. Real-time carbon accounting method for the European electricity markets. *Energy Strategy Reviews* 26, 100367.
- Turner, K., Lenzen, M., Wiedmann, T., Barrett, J., 2007. Examining the global environmental impact of regional consumption activities — Part 1: A technical note on combining input–output and ecological footprint analysis. *Ecological Economics* 62, 37–44.
- UBA, 2021a. Treibhausgas-Emissionen. Umweltbundesamt.
<https://www.umweltbundesamt.de/themen/klima-energie/treibhausgas-emissionen>. Accessed 28 June 2021.
- UBA, 2021b. Vorjahreschätzung der deutschen Treibhausgas-Emissionen für das Jahr 2020. Umweltbundesamt.
https://www.umweltbundesamt.de/sites/default/files/medien/361/dokumente/2021_03_10_trendtabellen_thg_nach_sektoren_v1.0.xlsx. Accessed 28 June 2021.
- Unterluggauer, T., Rich, J., Andersen, P.B., Hashemi, S., 2022. Electric vehicle charging infrastructure planning for integrated transportation and power distribution networks: A review. *eTransportation* 12.
- van Fan, Y., Jiang, P., Klemeš, J.J., Ocloń, P., 2022. Minimum environmental footprint charging of electric vehicles: A spatiotemporal scenario analysis. *Energy Conversion and Management* 258, 115532.
- Ventosa, M., Baíllo, Á., Ramos, A., Rivier, M., 2005. Electricity market modeling trends. *Energy Policy* 33, 897–913.
- Vetóné Móznér, Z., 2013. A consumption-based approach to carbon emission accounting – sectoral differences and environmental benefits. *Journal of Cleaner Production* 42, 83–95.
- Wang, Z., 2022. Optimization methods for developing electric vehicle charging strategies. Dissertation. Karlsruher Institut für Technologie (KIT), Karlsruhe, Germany.
- Watson, A., Viney, H., Schomaker, P., 2002. Consumer attitudes to utility products: a consumer behaviour perspective. *Marketing Intelligence & Planning* 20, 394–404.
- Weidlich, A., Veit, D., 2008. A critical survey of agent-based wholesale electricity market models. *Energy Economics* 30, 1728–1759.
- White House, 2021. FACT SHEET: President Biden Signs Executive Order Catalyzing America’s Clean Energy Economy Through Federal Sustainability, Washington D.C., USA.
- Wiedmann, T., 2009. A review of recent multi-region input–output models used for consumption-based emission and resource accounting. *Ecological Economics* 69, 211–222.
- Wiedmann, T., Lenzen, M., Turner, K., Barrett, J., 2007. Examining the global environmental impact of regional consumption activities — Part 2: Review of input–output models for the assessment of environmental impacts embodied in trade. *Ecological Economics* 61, 15–26.
- Will, C., Jochem, P., Fichtner, W., 2017a. Defining a day-ahead spot market for unbundled time-specific renewable energy certificates, in: EEM17 Proceedings. 14th International Conference on the European Energy Market, Dresden, Germany. 6.-9.06.2017. IEEE, Piscataway, NJ, USA.
- Will, C., Jochem, P., Pfahl, S., Fichtner, W., 2017b. Economic and sustainability-potential of carbon-neutral charging services for electric vehicle customers, in: EVS30 Symposium Proceedings. Electric Vehicle Symposium, Stuttgart, Germany. 9.-11.10.2017.
- Will, C., Lehmann, N., Baumgartner, N., Feurer, S., Jochem, P., Fichtner, W., 2022. Consumer understanding and evaluation of carbon-neutral electric vehicle charging services. *Applied Energy* 313, 118799.
- Will, C., Schuller, A., 2016. Understanding user acceptance factors of electric vehicle smart charging. *Transportation Research Part C: Emerging Technologies* 71, 198–214.

- Woo, J., Choi, H., Ahn, J., 2017. Well-to-wheel analysis of greenhouse gas emissions for electric vehicles based on electricity generation mix: A global perspective. *Transportation Research Part D: Transport and Environment* 51, 340–350.
- Xia, X., Li, P., 2022. A review of the life cycle assessment of electric vehicles: Considering the influence of batteries. *The Science of the total environment* 814.
- Xu, L., Yilmaz, H.Ü., Wang, Z., Poganietz, W.-R., Jochem, P., 2020. Greenhouse gas emissions of electric vehicles in Europe considering different charging strategies. *Transportation Research Part D: Transport and Environment* 87.
- Yuksel, T., Tamayao, M.-A.M., Hendrickson, C., Azevedo, I.M.L., Michalek, J.J., 2016. Effect of regional grid mix, driving patterns and climate on the comparative carbon footprint of gasoline and plug-in electric vehicles in the United States. *Environ. Res. Lett.* 11, 44007.
- Zimmermann, F., Bublitz, A., Keles, D., Fichtner, W., 2021. Cross-border Effects of Capacity Remuneration Mechanisms: The Swiss Case. *The Energy Journal* 42.
- Zimmermann, F., Keles, D., 2022. State or Market : Investments in New Nuclear Power Plants in France and Their Domestic and Cross-border Effects.
- Zimmermann, F., Keles, D., Fichtner, W., 2017. Agentenbasierte Analyse der Auswirkungen des französischen Kapazitätsmarkts, in: 10. Internationale Energiewirtschaftstagung (IEWT). IEWT, Wien. 15. - 17.02.2017.

Working Paper Series in Production and Energy

recent issues

- No. 68** Anthony Britto, Emil Kraft, Joris Dehler-Holland: Steelmaking Technology and Energy Prices: The Case of Germany
- No. 67** Anthony Britto, Joris Dehler-Holland, Wolf Fichtner: Wealth, Consumption, and Energy-Efficiency Investments
- No. 66** Martin Hain, Tobias Kargus, Hans Schermeyer, Marliese Uhrig-Homburg, Wolf Fichtner: An Electricity Price Modeling Framework for Renewable-Dominant Markets
- No. 65** Martin Klarmann, Robin Pade, Wolf Fichtner, Nico Lehmann: Energy Behavior in Karlsruhe and Germany
- No. 64** Florian Zimmermann, Dogan Keles: State or Market: Investments in New Nuclear Power Plants in France and Their Domestic and Cross-border Effects
- No. 63** Paul Heinzmann, Simon Glöser-Chahoud, Nicolaus Dahmen, Uwe Langenmayr, Frank Schultmann: Techno-ökonomische Bewertung der Produktion regenerativer synthetischer Kraftstoffe
- No. 62** Christoph Fraunholz, Kim K. Miskiw, Emil Kraft, Wolf Fichtner, Christoph Weber: On the Role of Risk Aversion and Market Design in Capacity Expansion Planning
- No. 61** Zoe Mayer, Rebekka Volk, Frank Schultmann: Evaluation of Building Analysis Approaches as a Basis for the Energy Improvement of City Districts
- No. 60** Marco Gehring, Franziska Winkler, Rebekka Volk, Frank Schultmann: Projektmanagementsoftware und Scheduling: Aktuelle Bestandsaufnahme von Funktionalitäten und Identifikation von Potenzialen
- No. 59** Nico Lehmann, Jonathan Müller, Armin Ardone, Katharina Karner, Wolf Fichtner: Regionalität aus Sicht von Energieversorgungs- und Direktvermarktungsunternehmen – Eine qualitative Inhaltsanalyse zu Regionalstrom in Deutschland
- No. 58** Emil Kraft, Marianna Russo, Dogan Keles, Valentin Bertsch: Stochastic Optimization of Trading Strategies in Sequential Electricity Markets
- No. 57** Marianna Russo, Emil Kraft, Valentin Bertsch, Dogan Keles: Short-term Risk Management for Electricity Retailers Under Rising Shares of Decentralized Solar Generation
- No. 56** Anthony Britto, Joris Dehler-Holland, Wolf Fichtner: Optimal Investment in Energy Efficiency as a Problem of Growth-Rate Maximisation

The responsibility for the contents of the working papers rests with the author, not the institute. Since working papers are of preliminary nature, it may be useful to contact the author of a particular working paper about results or caveats before referring to, or quoting, a paper. Any comments on working papers should be sent directly to the author.

Impressum

Karlsruher Institut für Technologie

Institut für Industriebetriebslehre und Industrielle Produktion (IIP)
Deutsch-Französisches Institut für Umweltforschung (DFIU)

Hertzstr. 16
D-76187 Karlsruhe

KIT – Universität des Landes Baden-Württemberg und
nationales Forschungszentrum in der Helmholtz-Gemeinschaft

Working Paper Series in Production and Energy
No. 69, February 2023

ISSN 2196-7296