

Aspalter, Katharina Gerlinde

Research Report

WaSH safety plans and their application in rural growth centres in Uganda: Analysis of the development of WaSH safety plans

ÖFSE-Forum, No. 57

Provided in Cooperation with:

Austrian Foundation for Development Research (ÖFSE), Vienna

Suggested Citation: Aspalter, Katharina Gerlinde (2013) : WaSH safety plans and their application in rural growth centres in Uganda: Analysis of the development of WaSH safety plans, ÖFSE-Forum, No. 57, ISBN 978-3-902906-04-5, Südwind-Verlag, Wien, <https://www.oefse.at/publikationen/oefse-forum/detail-oefse-forum/publication/show/Publication/Wa-SH-Safety-Plans-and-their-Application-in-Rural-Growth-Centres-in-Uganda/>

This Version is available at:

<https://hdl.handle.net/10419/268139>

Standard-Nutzungsbedingungen:

Die Dokumente auf EconStor dürfen zu eigenen wissenschaftlichen Zwecken und zum Privatgebrauch gespeichert und kopiert werden.

Sie dürfen die Dokumente nicht für öffentliche oder kommerzielle Zwecke vervielfältigen, öffentlich ausstellen, öffentlich zugänglich machen, vertreiben oder anderweitig nutzen.

Sofern die Verfasser die Dokumente unter Open-Content-Lizenzen (insbesondere CC-Lizenzen) zur Verfügung gestellt haben sollten, gelten abweichend von diesen Nutzungsbedingungen die in der dort genannten Lizenz gewährten Nutzungsrechte.

Terms of use:

Documents in EconStor may be saved and copied for your personal and scholarly purposes.

You are not to copy documents for public or commercial purposes, to exhibit the documents publicly, to make them publicly available on the internet, or to distribute or otherwise use the documents in public.

If the documents have been made available under an Open Content Licence (especially Creative Commons Licences), you may exercise further usage rights as specified in the indicated licence.



WaSH Safety Plans and their Application in Rural Growth Centres in Uganda

Analysis of the Development of
WaSH Safety Plans

Katharina Gerlinde Aspalter

Diplomarbeit

Preface

Water, Sanitation and Hygiene (WaSH) are very important factors for the health status of every country all over the world. Project and programme interventions in the area of hygiene and health care have high impacts on health indicators in developing countries. Nevertheless international donors and donor organizations support mostly hardware – i.e. water pipes, waste water systems, water treatment plants and others – and their management. The support of hygiene is seen as a further tool which is linked to education and other skills. Therefore the author of the thesis takes the deficits of the Water Safety Plan of the World Health Organization and shows in her thesis that health objectives can be reached if hygiene activities are taken in combination with new concepts of the water sector. Most challenging is the interference of technical and health and sector political aspects.

Taking into consideration that as well Uganda as the water sector are priorities of the Austrian Development Cooperation (OEZA) since decades the thesis with its empirical study of six rural developmental centers is of specific interest of the OEZA. The author shows with her empirical research that the implementation of the WaSH Safety Plans in rural areas makes sense. This approach is a wider approach of water supply and water management which takes into account more intensive the impact of project and programme intervention. Therefore the thesis of Katharina Gerlinde Aspalter fits very well in the series of ÖFSE Forum.

Michael Obrovsky
Head of Research Department



universität
wien

DIPLOMARBEIT

Titel der Diplomarbeit

“WaSH Safety Plans and their Application in Rural Growth Centres in Uganda

Analysis of the Development of WaSH Safety Plans”

Verfasserin

Katharina Gerlinde Aspalter

angestrebter akademischer Grad

Magistra (Mag.)

Wien, 2012

Studienkennzahl lt. Studienblatt:

A 057 390

Studienrichtung lt. Zulassungsbescheid:

Internationale Entwicklung

Betreuer:

Dipl. Ing. Helmut Jung

Danksagung

Herzlich bedanken möchte ich mich bei...

... Helmut Jung durch den diese Diplomarbeit erst möglich geworden ist. Danke für die Betreuung und die spannenden und hilfreichen Diskussionen die damit verbunden waren.

... Hans Schattauer für die großartige Unterstützung in Uganda, diese Unterstützung machte die Feldforschung erfolgreicher und meine Eingewöhnung in Uganda leichter.

... Charles Niawagaba von der Makerere University, Felix Twinomucunguzi Leiter der WSDF-Central, Herbert Nuwamanya Leiter der WSDF-SW, Julius Byamugisha Manager der swUws, Stacy Natukunda und Shivan Kebirungi meiner Assistentin. Viel Dank gebührt auch allen Interviewpartnern die sich die Zeit genommen haben ihr Wissen mit mir zu teilen.

... Sophie Liddell durch deren großartige Hilfe meine Arbeit grammatikalisch wie auch inhaltlich besser geworden ist.

... bei meinen Freundinnen, Lisa, Maria, Viki und Moni sowohl für die Ideen zur Diplomarbeit wie auch für die Ablenkungen von dieser und die großartige Unterstützung über die ganze Studienzeit.

... meinen Eltern Cäzilia und Franz die mich auf meinem bisherigen Werdegang immer unterstützt haben. Dafür, dass sie es mir ermöglicht haben zu studieren, mich bei meinen Entscheidungen gefördert und immer an mich geglaubt haben.

... meinen Schwestern Christa, Manuela und Irene für viele spannende Diskussionen, für all ihre Hilfe und Unterstützung die sie mir während der ganzen Zeit gegeben haben. Sowie für die vielen aufbauenden Worte wenn es mal nicht so gut lief.

... Christoph der diese Arbeit inhaltlich und sprachlich sinnvoll gemacht und mich in Diskussionen immer wieder auf neue Ideen gebracht hat. Der mir dabei geholfen hat nicht zu verzweifeln, mich immer wieder motiviert hat und in schwierigen Zeiten immer für mich da war.

Ich danke Euch!

Abstract

Water supply, sanitation and hygiene are directly linked to health. The greatest impacts on public health are provided through actions that include improvements in sanitation and hygiene. Despite having this knowledge donors tend to provide water supply projects and generally support hardware. Software such as hygiene promotion is treated as an ‘add-on’. However, close examination of the *F-Diagram*, a diagram showing the faecal-oral transmission routes of diseases, makes it obvious that basic sanitation as well as hygiene act as primary and secondary barriers to interrupt transmission routes. This topic is of tremendous relevance regarding the fact that diarrhoeal diseases are globally the major cause of death amongst children.

The model of Water Safety Plans, developed by the World Health Organization (WHO) tends to prevent the water supply chain against contamination from catchment to consumer. This excellent risk and hazard management tool is limited to water supply, without taking sanitation and hygiene directly into account. Due to that fact and the great impact of sanitation and hygiene on health, health-based targets cannot be achieved in the long run. The reason for this is that disease transmission takes place due to insufficient sanitation or faecal contaminated hands or environment. This weak point of the water safety plan approach initiates the idea of adapting and extending the model with the components water and sanitation and thus creating a so-called *WaSH – Water, Sanitation and Hygiene – Safety Plan*.

In Uganda a decentralized structure for water supply and sanitation is used. *Water and Sanitation Development Facilities* as well as *Umbrella Organisations* provide these services for small towns and rural growth centres. The aim of the structure is to manage water supply and sanitation on a regional level by water supply and sanitation boards. My field research in the south west of Uganda analyses six rural growth centres and shows that such *WaSH Safety Plans* are appropriate and reasonable for these rural centres. The analysis examines the structure for water supply as well as the sanitation situation and based on these results possible roles and responsibilities for an implementation of *WaSH Safety Plans* are developed.

Abstract auf Deutsch

Trinkwasserversorgung, Basissanitäreinrichtungen und Hygiene haben einen direkten Einfluss auf die Gesundheit. Bei Interventionen im Bereich der Hygiene und Sanitärversorgung ist der gesundheitsfördernde Effekt sogar noch höher. Trotz dieser Erkenntnis tendieren internationale Geberinstitutionen zur Förderung von Wasserversorgungsprojekten sowie generell zur Bereitstellung von Hardware. Software, wie z.B. Hygieneförderung, wird als Zusatz mitbehandelt. Bei näherer Betrachtung des *F-Diagrammes*, ein Diagramm das fäkal-orale Übertragungswege von Krankheiten zeigt, ist erkennbar, dass Basissanitäreinrichtungen sowie Hygienemaßnahmen Primär- und Sekundärbarrieren bilden, die diese Übertragungswege unterbrechen. Dieses Thema ist von außerordentlicher Brisanz in Anbetracht der Tatsache, dass Durchfallerkrankungen weltweit betrachtet die häufigste Todesursache bei Kindern darstellen.

Das Modell des *Water Safety Plans*, entwickelt von der Weltgesundheitsorganisation (WHO), dient dem Zweck Verunreinigungen in der Trinkwasserversorgung unmittelbar und in jedem Schritt der Aufbereitung, von der Quelle bis zum Endverbraucher, entgegenzuwirken. Diese ausgeklügelten Pläne zum Risiko- und Gefahrenmanagement beschränken sich jedoch auf Wasser ohne direkte Einbindung von Sanitärversorgung und Hygiene. Durch den großen positiven Einfluss der beiden Komponenten auf die Gesundheit können so aber nur schwer langfristige gesundheitsbasierte Ziele erreicht werden. Diese Schwachstelle der *Water Safety Plans* veranlasst zur Idee den Ansatz zu adaptieren und auszubauen um ein Konzept zu entwickeln welches alle drei Komponenten beinhaltet, einen sogenannten *WaSH – Water, Sanitation and Hygiene – Safety Plan*.

In Uganda wird mit einer dezentralen Struktur in der Trinkwasser- und Sanitärversorgung gearbeitet. Durch sogenannte *Water and Sanitation Development Facilities* und *Umbrella* Organisationen wird die Versorgung von Kleinstädten und ländlichen Entwicklungszentren gewährleistet. Diese Struktur zielt darauf ab lokale Gremien mit dem Management der Trinkwasser- und Sanitärversorgung zu betrauen um somit die Dienstleistung regional zu halten. Meine Feldforschung im Südwesten Ugandas, bei der sechs sogenannte ländliche Entwicklungszentren untersucht wurden zeigt, dass *WaSH Safety Plans* für diese ländlichen Gebiete angebracht und sinnvoll sind. Die Analyse legt die dortige Struktur der Trinkwasser-

versorgung sowie die Sanitärsituation näher dar, um darauf aufbauend mögliche Rollen und Verantwortlichkeiten für eine Implementierung herauszukristallisieren.

Table of Contents

Danksagung	iii
Abstract	v
Abstract auf Deutsch	vi
List of Abbreviations	xi
List of Figures	xiii
List of Pictures	xiv
List of Tables	xiv
1. Introduction	1
1.1 Problem Statement.....	1
1.2 Objective of the Thesis and Research Questions	4
1.3 Outline of the Thesis	5
1.4 Research Limitations	6
2. Method	8
2.1 Literature Research.....	8
2.2. Field Research	8
2.2.1 Selection of Research Area.....	9
2.3 Used Tools in the Field Research.....	11
2.3.1 Grounded Theory	11
2.3.2 Semi-Structured Interviews	14
2.4 Realisation in the Field.....	15
3. Uganda – Background Information and Context	18
3.1 Geographical Characteristics.....	18
3.2 Political History of the Country.....	20
3.3 Socio-political Characteristics.....	21
3.4 Socio-economical Characteristics	24
3.5 History of Development Cooperation	25

4. Water Supply and Sanitation in Uganda	27
4.1 Institutional Structure and Responsibilities	27
4.1.1 National Level.....	29
4.1.2 District Level	32
4.1.3 Community Level	33
4.2 Water and Sanitation Development Facility – South Western Branch	34
4.3 South Western Umbrella of Water and Sanitation	36
5. Rural Growth Centres	38
5.1 Water Supply Scheme	40
5.1.1 Scheme Operator.....	42
5.1.2 Water Committee/Water Board	43
5.1.3 Connections and People supplied	45
5.1.4 Problems within the Schemes	46
5.2 Sanitation Situation	47
5.2.1 Sanitation Facilities.....	48
5.2.2 Waste Management.....	59
5.3 Health Issue	60
5.3.1 Health Worker.....	61
5.3.2 Health Education.....	62
5.3.3 Health Problems.....	63
5.4 Responsibilities in Sanitation and Hygiene	65
5.5 Communication and Cooperation	65
6. Water Safety Plan Framework	67
6.1 Hazard Analysis and Critical Control Points.....	70
6.2 Multiple Barrier Approach	70
6.3 System Assessment	71
6.3.1 Risk Assessment and Risk Management	72
6.3.2 Control Measures	75
6.4 Operational Monitoring	76
6.5 Management Plans, Documentation and Communication	77
6.6 Verification and Surveillance	79
6.7 The Kampala Water Safety Plan	81

6.7.1 Challenges in Implementation and Lessons Learned	81
6.7.2 Problems of Dissemination of the Approach.....	82
7. The WaSH Components.....	85
7.1 Sanitation.....	85
7.2 The Effect of Sanitation Systems on Hygiene.....	87
7.2.1 On-site Sanitation	89
7.2.2 Off-site Sanitation.....	93
7.3 Hygiene and Hygiene Promotion	93
7.4. The Effect of Hand-washing.....	94
8. WaSH Safety Plan Approach.....	96
8.1 Implementation of a WaSH Safety Plan.....	97
8.1.1 System Assessment for a WaSH Safty Plan	98
8.1.2 Critical Points and Control Measures in WaSH	99
8.2 Roles and Responsibilities of Different Actors	100
8.2.1 Hardware.....	102
8.2.2 Software	103
8.3 Verification.....	104
9. Conclusion.....	105
References	107
Appendices.....	115
Appendix A: List of Interviewees	116
Appendix B: Curriculum Vitae	117

List of Abbreviations

ADA	Austrian Development Agency
AWO	Assistant Water Officer
CBO	Community Based Organisation
DFID	Department for International Development
DWD	Directorate of Water Development
DWO	District Water Office (or Officer)
DWRM	Directorate of Water Resource Management
DWSCC	District Water and Sanitation Co-ordination Committee
EHD	Environmental Health Department
GoU	Government of Uganda
HACCP	Hazard Analysis and Critical Control Points
HDI	Human Development Index
LC	Local Council
LG	Local Government
LRA	Lord's Resistance Army
MDG	Millennium Development Goals
MoES	Ministry of Education and Sports
MoH	Ministry of Health
MoLG	Ministry of Local Government
MoU	Memorandum of Understanding
MWE	Ministry of Water and Environment
NGOs	Non-Government Organisations
NWSC	National Water and Sewerage Cooperation
O&M	Operation and Maintenance
ODA	Official Development Assistance
RGSs	Rural Growth Centres
SSP	Sanitation Safety Plan
STs	Small Towns
SWTWS	South Western Towns Water and Sanitation
SWUSW	South Western Umbrella of Water and Sanitation

UBOS	Uganda Bureau of Statistics
UGX	Uganda Shilling
UN	United Nations
UNDP	United Nations Development Programme
UO	Umbrella Organization
UWASNET	Uganda Water and Sanitation Non-Government Organisation Network
VHT	Village Health Team
WaSH	Water Sanitation and Hygiene
WEDC	Water, Engineering and Development Centre
WHO	World Health Organization
WSC	Water and Sanitation Committee
WSDF-SW	Water and Sanitation Development Facility – South West
WSP	Water Safety Plan
WSSB	Water Supply and Sanitation Board
WSSCC	Water Supply and Sanitation Collaborative Council

List of Figures

- Figure 1.1 The F-diagram of disease transmission and control (quoted by Wagner and Lanoix 1958 adapted from Water Supply & Sanitation Collaborative Council, World Health Organization, 2005: 10)
- Figure 2.1 Districts of analysed RGCs (adapted from Ministry of Water and Environment, 2010: 365)
- Figure 3.1 Map of Uganda (United Nations, 2003)
- Figure 4.1 Structures of Policy Levels
- Figure 5.1 Sketch of a Rural Growth Centre
- Figure 5.2 The “Umbrella” Service Delivery Model (Koestler, Van Lieshout, 2012: 3)
- Figure 5.3 Traditional Pit Latrine (Brikké, Bredero, 2003: 105)
- Figure 5.4 Ventilated Improved Pit Latrine (Tilley et al., 2008: 55)
- Figure 5.5 Pour Flush Toilet (Tilley et al., 2008: 43)
- Figure 5.6 Cistern Flush Toilet (Tilley et al., 2008: 45)
- Figure 5.7 Urine Diversion Dry Toilet with composting vaults (Tilley et al., 2008: 63)
- Figure 5.8 Distribution of Households with Hand-washing Facilities (Uganda Bureau of Statistics, 2010: 121)
- Figure 6.1 “Catchment to Consumer”-Approach to Risk Management in Drinking-Water Supply (Medema et al., 2003: 22)
- Figure 6.2 Overview of the Steps in Developing a Water Safety Plan (adapted from World Health Organization, 2011b: 48)
- Figure 7.1 Points of Exposure in the Sanitation Chain (Barrenberg, Stenström, 2010: 6)
- Figure 7.2 Transmission pathways due to poorly managed sanitation (Prüss et al., 2002: 538)
- Figure 8.1 Risk Management-Approach of the Safety of Water, Sanitation and Hygiene (adapted from Medema et al., 2003: 22)
- Figure 8.2 Actors involved in Implementation

List of Pictures

Picture 1 Public Water Kiosk with Tap Attendant

Picture 2 Pedestal and Squatting Pan Urine Diversion User Interface (Austin, 2006; Fu, 2010: 31)

List of Tables

Table 5.1 General Scheme Information

Table 5.2 Numbers of people supplied and types of connections

Table 5.3 Type of Toilet Facilities in Households in 2009/2010 (%) (adapted from Uganda Bureau of Statistics, 2010: 120)

Table 5.4 Health Care System and Administrative Structure (Health Action International et al., 2002)

Table 6.1 Example for a semi-quantitative risk matrix approach (adapted from Bartram et al., 2009: 32)

Table 6.2 Examples of definitions of likelihood and severity categories that can be used in risk scoring (World Health Organization, 2008: 55)

Table 7.1 Example of Exposure Points (adapted from Barrenberg, Stenström, 2010: 7)

Table 8.1 Critical Points for Hygiene, Sanitation and Water

1. Introduction

1.1 Problem Statement

Water supply, sanitation and hygiene are directly linked to health (World Bank, 2003: 1). The greatest impacts on health are provided through actions that include improvements in sanitation and hygiene (Esrey et al., 1991: 617). “However, donor interventions have tended to be dominated by improvements in water supply and pay less attention to improving sanitation and hygiene.” (Clark, Gundry, 2004: 157) Interventions have been focused mostly on hardware in water supply and improved sanitation and hygiene promotion has received relatively low priority. Reasons for this are inter alia that public demand as well as the political support for water supply outperforms the one for sanitation and hygiene promotion “and the greater attractiveness of community as opposed to household interventions.” (Howard et al., 2006a: 276) Furthermore, sanitation improvements are often treated like an ‘add-on’ to water supply interventions and are not receiving required resources and timeframe. In addition, in many societies sanitation is associated with distaste, embarrassment and is a taboo subject (Clark, Gundry, 2004: 160). Handling the issue of sanitation has changed over the last few decades and the Millennium Development Goals, published by the United Nations (UN) in 2000, have a goal formulated for water supply and basic sanitation. But the goals aim “only to reduce by half those without access to these services” (Cairncross et al., 2010: 2) That means if the goals are to be achieved “a quarter of the world’s population will still be without access to even a basic toilet and one in ten will be without access to an improved water source.” (Cairncross et al., 2010: 2) For hygiene no target has been set, “but reference is made to the promotion of ‘safe hygiene practices’ as an action for achieving the sanitation target.” (Clark, Gundry, 2004: 161) Sadder still is the fact that many countries will not achieve these goals, especially the one for sanitation (Cairncross et al., 2010: 2). However, hygiene promotion as well as sanitation improvements have not only the greatest impacts on health but “are among the most cost-effective public health interventions available to developing countries.” (Mara et al., 2010: 5)

That means hygiene and sanitation have long been neglected topics but play a substantial role in achieving health-based targets. It is therefore essential to consider these issues in water supply programmes otherwise the aim of improving health will not be reached for the long term.

Sanitation refers to the safe collection, storage, treatment and disposal, re-use or recycling of human excreta, which is faeces and urine, as well as solid waste management of rubbish, hazardous wastes like hospital or chemical wastes and industrial waste products. Furthermore sanitation includes drainage and disposal, re-use or recycling of household wastewater, also referred to as greywater, and drainage of storm water. Sanitation systems pursue the target of protecting and promoting human health (Stenström et al., 2011: 1; World Health Organization et al., 2008: 1). *Hygiene* means various behaviours and measures to break the chain of infection transmission. That means the burden of infectious diseases is reduced through hygiene measures. Hygiene measures are hand hygiene, personal hygiene, respiratory hygiene as well as food hygiene, and general hygiene, which include laundry, surfaces, toilets, baths and sinks. Furthermore, a very important hygiene measure is to ensure safe water at “point of use” as well as safe disposal of faeces and solid waste. Hygiene measures also include control of wastewater and rainwater (Peal et al., 2010: 2).

The characteristic of interventions in sanitation and hygiene is that they are preventive and can avoid diseases, especially diseases caused by faecal contamination like diarrhoea. These measures create barriers between the environment and pathogens living in human excreta (Clark, Gundry, 2004: 158) Poor sanitation and hygiene is directly linked to diseases like ascariasis, diarrhoeal diseases, dracunculiasis, hookworm infection, schistosomiasis and trachoma (Esrey et al., 1991: 609) but also diseases like eye infection or skin infection are related to poor hygiene (Peal et al., 2010: 3). In order to stop the spreading of disease these faecal-oral transmission routes have to be intermitted through protective barriers like illustrated in Figure 1. This diagram is known by the name *F-Diagram*.

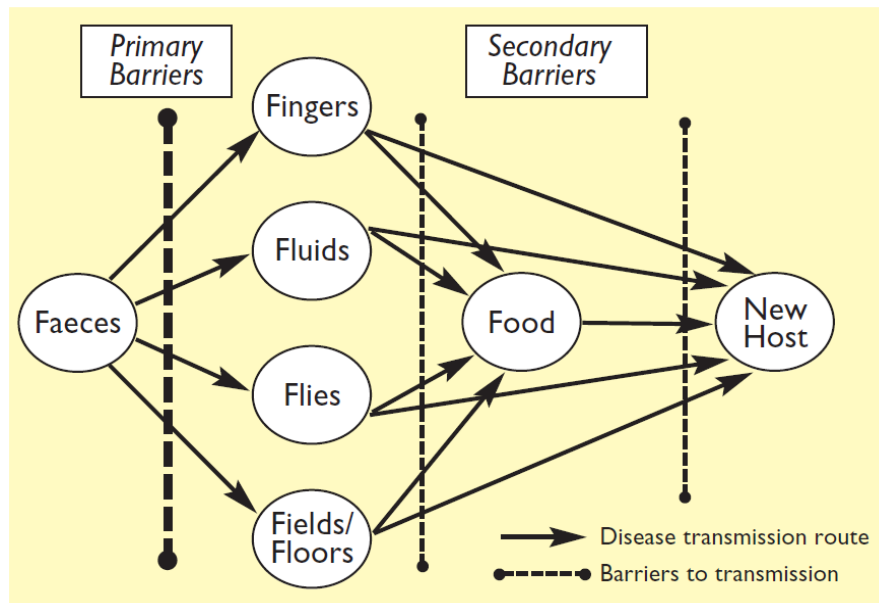

Figure 1.1 The F-diagram of disease transmission and control (quoted by Wagner and Lanoix 1958 adapted from Water Supply & Sanitation Collaborative Council, World Health Organization, 2005: 10)

The figure presents that “[s]anitation, with good hygiene, acts as a fundamental ‘primary barrier’ to isolate fecal matter from the general environment. Once fecal matter is in the environment, however, it can easily be spread directly to hosts, and indirectly to food, through finger, flies, fluids, and in fields or floors.” (World Bank, 2008) If the primary barrier fails and infectious organisms got into the environment it needs further barriers to be sure that the public is protected. These barriers are termed secondary barrier and “are hygienic practices that stop faecal pathogens that have got into the environment in stools or on hands, from multiplying and reaching new hosts.” (Curtis et al., 2000: 25) An essential secondary barrier is good hygiene practice, especially hand-washing with soap. Essential is that hardware alone (toilets and taps) is not the key to health and has just limited impact. “For health to improve changes in hygiene behavior are also needed to break the cycle of disease transmission.” (World Bank, 2008)

The Water Safety Plan (WSP), developed by the World Health Organization (WHO) also works with barriers, since water is a non-replaceable food. Here multiple barriers are established to save water from contamination from catchment to consumer. The Water Safety

Plan can be seen as a system and risk analysis, which examines the overall system of water supply for possible sources of health risks to meet health-based standards. This approach assesses and manages risks over the entire water supply chain and makes the end product testing obsolete due to the reason that end product testing has a big disadvantage, because “the fact that testing of water immediately prior to, or within, distribution [...] can only highlight a potential health problem after the water has been consumed [...]” (Davison et al., 2005: 5) In order to provide safe drinking water all the time it is important to have an inclusive risk management, which covers all different steps in the water supply chain from catchment to consumer (Davison et al., 2005: 6; Drinking Water Inspectorate, 2005: 2). This model is a great development for ensuring safety through the whole process. But a weakness of the model is that it only focuses on water supply and sanitation and hygiene improvements are also seen as such ‘add-ons’. This limitation of the WSP creates the idea of developing a Water, Sanitation and Hygiene Safety Plan, abbreviated WaSH Safety Plan, which concerns and includes explicitly all three components.

1.2 Objective of the Thesis and Research Questions

The central objective of my thesis is to analyse the feasibility of applying the manual for Water Safety Plans also for WaSH Safety Plans, in the context of rural growth centres in the south west of Uganda, in order to ensure that health-based targets are achieved. The assumption I make is that Water Safety Plans, which are a very good management tool, will not meet health-based targets in a long term, if hygiene is not taken into account.

The main questions that have to be answered to reach this objective are:

- How and to what extent is it possible to combine the WSP model with hygiene?
- Is it feasible to create instruments according to the structure of the WSP so that it is possible to speak of a WaSH Safety Plan?

Further questions which arise as a consequence and which have to be addressed:

- How are the legal structures organized and which institutions are responsible for water supply and sanitation?
- Is there need for a certain kind of political structure to implement a Safety Plan?
- To what extent is hygiene responsible for achieving health-based targets?

1.3 Outline of the Thesis

My thesis will be structured in nine chapters. The first one after the introduction will deal with the methodology, the used tools and the realization in the field. In this chapter and its subchapters the methodology of grounded theory and its use will be explained. Also the tool of semi-structured interviews is described. Afterwards I explain how I used it in the field.

The third chapter will be about Uganda, a brief outline including the geographical, the historical, the political and the economical characteristics. Furthermore the history of development cooperation is briefly explained. This outline is given in order to provide a more general overview of the country. Some indicators presented in this chapter are also important for the situation in the water and sanitation sector.

Chapter four will discuss water supply and sanitation in Uganda. The different policy levels are explained to illustrate actors and their responsibilities at various levels. In addition the most crucial actors are briefly characterized. Also the Water Supply and Sanitation Facility Southwest (WSDF-SW) and the South Western Umbrella of Water and Sanitation (SWUWS) are described in more detail because they are key actors in this analysis and important for the water supply in rural growth centres in the south west of Uganda. The aim of this chapter is to analyse the structural and administrative situation, and to clarify responsibilities. This will be needed to answer the question of how an implementation of a WaSH Safety Plan could work.

Chapter five and its subchapters will be about rural growth centres and how these centres are structured. A description of how these centres work, of common economic activities and of living conditions is given. In addition the water supply schemes of the analysed RGCs are explained in detail. Also the health situation and structure will be addressed. Here the most commonly used toilet systems are explained in order to know the advantages and disadvantages and risks which may arise. The toilet systems are explained in short in order to connect the sanitation situation with the hygiene situation.

Chapter six will be about the concept of Water Safety Plans. It will analyse what this approach means and therefore the most important components and central points will be

elaborated. Furthermore, the Hazard Analysis and Critical Control Points (HACCP) as well as the multiple barrier approach will be carried out. Due to the fact that in my thesis the principles of the Water Safety Plan approach are described, the basic reference will be the “Guidelines for Drinking-water Quality” rather than the “Water Safety Plan Manual“ which is a practical guidance. This creates the basis for a discussion of adaption of the WSP to a WaSH Safety Plan.

In chapter seven the WaSH components will be examined carefully together with its aims and functions. Here the sanitation will be discussed with the focus on the effects of different toilet systems on hygiene and the health situation. Furthermore I give an explanation about hygiene promotion and what effect hand-washing has on health. The chapter explains the importance of sanitation and hygiene for health.

Chapter eight will present a possible solution for expanding the Water Safety Plan approach with sanitation and hygiene. Furthermore instruments used in the WSP will be created for the WaSH Safety Plan to show that an adaption of the most crucial points is feasible and reasonable. A possible solution for an implementation of such a plan for rural growth centres in the south west of Uganda is discussed.

The last chapter will comprise a conclusion, which summarizes the main points followed by the references.

1.4 Research Limitations

Due to the objective of my diploma thesis and limited space, the topic of water is restricted to Water Safety Plans. The subject of sanitation is discussed with the focus on different types of toilet systems and their effect on the hygiene situation. Sanitation in all its components of safe handling of excreta, vector control, drainage, solid waste management and sewerage will not be debated and presented in detail because this thesis does not claim to be a technical support paper for sanitation systems. Rather it is scientific research on the impact of hygiene. Detailed examples of possible hazards and risks in the different steps of the water supply systems will not be outlined, because these are beyond the scope of this thesis. The focus lies in analysing

the effect of hygiene on health-based targets, and in characterizing the approaches of Water Safety Plans and hygiene and conflating them. A short explanation of different toilet systems is given for a better understanding of the situation in the RGCs. Furthermore, it is necessary to analyse which influence toilet types have on hygiene.

Detailed information about specific hazards and risks in water supply can be looked up in the “Water Safety Plan Manual”. Detailed information about sanitation systems can be found inter alia in Tilley et al. 2008 as well as in Brikké and Bredero 2003 and for solid waste management, for instance, in Zurbrügg 2002.

The research is characterized by some limitations in both the literature research and the field research. Gathering data about the water and sanitation sector in Uganda was possible through internet portals of the Ministry of Water and Environment and the Ministry of Health in different quality and quantity. Getting data from Local Governments was more difficult and little in quantity. For specific data of the socio economic and health situation in rural growth centres it was problematic to get qualitative data and also the quantity was very little.

The biggest limitation of my diploma thesis was time. The field research took only ten weeks and therefore I could only visit a limited number of rural growth centres and also the numbers of interviews was restricted by this fact.

A further limitation was transport and I used only public transport to get into the field; thereby only easily reachable rural growth centres could be visited.

Another limitation or rather influence results from the fact that I am a foreigner from Europe only visible through the colour of my skin. That means it was immediately obvious that my cultural background is different as well as my language therefore people approached me differently.

2. Method

The methodology of this thesis consists of two parts; the first one is the literature research in Austria carried out to gain an overview of a state of the art research and the present situation in Uganda. The second part is the field research in Uganda for 10 weeks, partly in rural areas in the south west and the capital town Kampala. The framework of grounded theory, a qualitative approach, was chosen to provide the theoretical background of the field research. There are two reasons for choosing this approach. First, what is appropriate for the topic and second, with which method can I personally work. The tools which have been realized in the field are semi-structured interviews with experts and participant observation.

2.1 Literature Research

The literature research contains the analytical review of scientific papers during which the topics sanitation, hygiene and the model of water safety plans have been examined. Scientific literature about the model of WSP has been analysed especially by analysing papers published by the World Health Organization (WHO). In particular, the chapter “Water safety plans” of the 4th edition of “Guidelines for Drinking-water Quality” published by the World Health Organization was the major source. Literature about sanitation and hygiene has been taken especially from the Water Supply and Sanitation Collaborative Council (WSSCC), Cairncross, Curtis as well as the World Health Organization. Also literature about Uganda has been analysed especially with regard to the governmental structures handling water supply, sanitation and hygiene. The main source of information has been the Government of Uganda in particular the Ministry of Water and Environment as well as the Ministry of Health. Here especially sector performance reports have been an important source.

2.2 Field Research

At the beginning of my field research I stayed the first week in Kampala. There I had close contact with the Austrian Development Agency (ADA), in particular with the programme officer for water & sanitation who helped me to get in contact with local water and sanitation

organisations. During my stay I had the possibility to work with the Water and Sanitation Development Facility-South West (WSDF-SW) and the South Western Umbrella of Water and Sanitation (SWUWS). Insight was gained through a one week stay in Kabale working with the SWUWS. After organizing collected data and deepening the existing contact to the Makerere University, the preparation of the interview guidelines started. For conducting the interviews, a two week stay in Mbarara took place. There I stayed with the WSDF-SW and worked together with my assistant Shivan Kebirungi who organized our visits to the RGCs. The visits were done in the following two weeks. In this time we interviewed scheme operators from 6 different RGCs and the health workers from there. We also visited the District Water Officer from Ntungamo District. During my stay in Mbarara and the work with WSDF-SW I participated in the everyday life of the office and got an insight in how the organisation works. In the last weeks of the research stay I interviewed experts in Kampala from the Ministry of Water and Environment, one member from the Ministry of Health and academic staff of the Makerere University and the Kyambogo University.

2.2.1 Selection of Research Area

In Uganda there is a very interesting and well-functioning structure established for water supply and sanitation. Water and Sanitation Development Facilities (WSDF) support small towns and rural growth centres to “get access to piped safe water and improved sanitation systems.” (Ministry of Water and Environment, 2011e) Operation and maintenance for these small towns and rural growth centres is supported by umbrella organizations. This well-established structure was one of the reasons why I chose Uganda for my diploma thesis. A further reason is the fact that Kampala, the capital town of Uganda, was the first African city where a Water Safety Plan was developed (Davison et al., 2005: 27). Additionally, an important reason for choosing this country was that my supervisor, Helmut Jung, worked and works in Uganda for some time and therefore connections to key persons were established. Furthermore a reason was that Uganda and Austria share a long connection, as Uganda is a priority country of the Austrian development cooperation since 1993 with a strong focus on water supply. Thus, it became easier to get in contact with important organizations.

In the south west of Uganda the first Water and Sanitation Development Facility (WSDF) was established in 2006. This branch already had the capacity to help me carry out my study, which is the reason why I chose the south west of Uganda. Additionally, I could make use of the opportunity to stay with the South Western Umbrella of Water and Sanitation (SWUWS) for a week.

The selection of rural growth centres was based on two conditions. Firstly, they had to have a water supply scheme developed by the WSDF-SW as well as a membership of the SWUWS. Secondly, the RGCs had to be easily accessible within a day because of the fact that my assistant and I used public transport to get there. With the exception of one visit, we always went back to Mbarara to stay overnight. Due to these facts three of the six RGCs were on the main road from Mbarara to Kabale, one to two hours away from Mbarara. Two of them were located about 5 kilometres away from the main road but accessible in the same time. One was in the hilly area of Kisoro where an overnight stay was necessary. This one has been chosen in order to address the question whether there is a difference between RGCs in easy reachable plane areas and hilly areas which are not so easily accessible.

The examined RGCs are situated in the districts Ntungamo, Kabale and Kisoro. In Figure 2.1 the location of the districts is shown. The RGCs have been elected by the WSDF-SW to get a piped water supply system. Criteria for being elected are described in chapter 4.2.

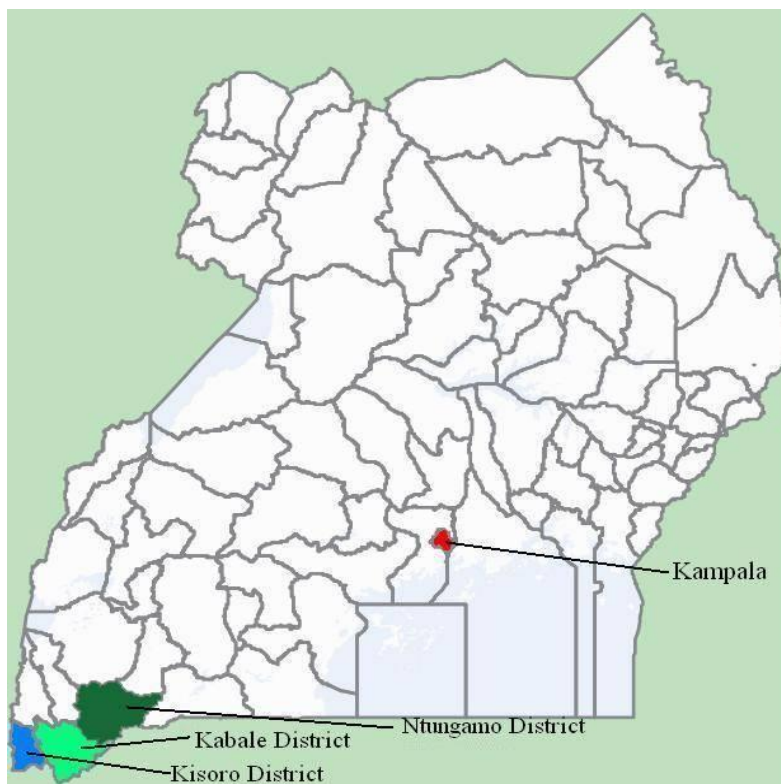

Figure 2.1 Districts of analysed RGCs (adapted from Ministry of Water and Environment, 2010: 365)

2.3 Used Tools in the Field Research

Grounded theory provides the opportunity to go into the field research without being fixed on a preconceived hypothesis, which is the basic idea of grounded theory. Hypothesis and theory are generated in the research process (Meinefeld, 2010: 268). Since I did not know the real situation in Uganda, especially the sanitation and hygiene situation in the RGCs, it was important to be unbiased and to work out the hypothesis during the research. This approach needs supporting data collection methods. Semi-structured interviews enable the interviewer to have prepared topics but give also the opportunity to look which issues are brought up by the interviewees themselves.

2.3.1 Grounded Theory

Grounded theory is a method of qualitative-interpretative social research. More precisely it is a qualitative research method which uses a systematic series of techniques to get an

inductively derived grounded theory from data (Strauss, Corbin, 1998; Strübing, 2008: 8). The basic position of Glaser and Strauss, who developed this method, “is that generating grounded theory is a way of arriving at theory suited to its supposed uses.” (Glaser, Strauss, 2008: 3) The authors have the view that the adequacy of a theory cannot be separated from the process in which it gets developed. Furthermore inductively developed theories meet criteria such as logical consistency, clarity, parsimony, density, scope, integration, as well as their fit and their ability to work. “Generating a theory from data means that most hypotheses and concepts not only come from the data, but are systematically worked out in relation to the data during the course of the research.” (Glaser, Strauss, 2008: 5).

Meanwhile it is not possible to talk about “the” grounded theory since Glaser and Strauss developed two different variants of the process. One developed by Anselm Strauss and partly also with his colleague Juliet Corbin and the other one established by Barney Glaser. Although there are many essentials of the original grounded theory in both approaches there are also some differences (Strübing, 2008: 9). In this diploma thesis the version of the approach further developed by Anselm Strauss and Juliet Corbin is used.

Important in grounded theory is the temporal parallelism and alternately functional relationship between the processes of data collection, data analysis and the construction of theory. This iterative cyclical process is called theoretical sampling, the generation of theory while collecting data and analysing data. There is not a theory at the beginning that has to be verified, it is the research field and the process that defines what will be essential. None of these processes is ever seen as completed and finished and the construction of a theory is not the endpoint of the research process. Theory is produced continuously during the whole process and does not have an endpoint (Strauss, Corbin, 1999: 8; Strübing, 2008: 14f). “The value of the methodology [...] lies in its ability not only to generate theory but also to ground that theory in data.” (Strauss, Corbin, 1998: 8) Like in interpretative social research also here the general idea is that researchers are never neutral observers but inevitably interpreters of data and decision-makers of the way theoretical argumentation is done. Researchers are also always subjects of the research process which is a fundamental idea in grounded theory. The guideline from Strauss and Corbin of how a theory can be developed is presented in the book “Basics of Qualitative Research”. These essentials are asking questions and making

comparison (Strauss, Corbin, 1998: 73) and also coding and writing of analytical memos (Strübing, 2008: 16). To apply a constructed grounded theory to a phenomenon the theory has to meet four crucial criteria: correlation, comprehensibility, generality and control (Strauss, Corbin, 1999: 88). Coding is the central activity in analysing data and consists of a series of activities.

Open coding is defined as “[t]he analytic process through which concepts are identified and their properties and dimensions are discovered in data.” (1998: 101) The central idea of the coding process is the constant comparative method of data (Strübing, 2008: 18). That means to break it into discrete parts and closely examine and compare it for similarities and differences. “Events, happenings, objects, and actions/interactions that are found to be conceptually similar in nature or related in meaning are grouped under more abstract concepts termed ‘categories’.” (Strauss & Corbin, 1998: 102) An important aspect to keep in mind for analytical purposes is “that classified objects, events, acts, and actions/interactions have attributes and that how one defines and interprets those attributes (or the meanings given to them) determines the various ways in which concepts are classified.” (Strauss & Corbin, 1998: 104f)

The following step is **axial coding**. Axial coding means “[t]he process of relating categories to their subcategories, termed ‘axial’ because coding occurs around the axis of a category, linking categories at the level of properties and dimensions.” (Strauss & Corbin, 1998: 123) The fractured data from open coding are reassembled and relationships between categories and subcategories are established to form more precise explanations about phenomena. Although the purposes of open coding and axial coding are different, they do not have to be sequential analytic steps. “One does not stop coding for properties and dimensions while one is developing relationships between concepts. They proceed quite naturally together”. (Strauss & Corbin, 1998: 136) In axial coding the researcher looks at a phenomenon with the questions of why, how come, where, when, how and with what results with the purpose of contextualizing. Also the questions of who, when, where, why, how and with what consequence will be asked for the purpose of relating to the process (Strauss & Corbin, 1998: 127)

The next step is **selective coding** which describes “[t]he process of integrating and refining the theory.” (Strauss & Corbin, 1998: 141) Depending on the evolving research question typically one or two theoretical concepts prove as pivotal for the developing theory. The aim of selective coding is the integration of hitherto developed theoretical concepts in relation to these core categories. That means that big parts of the data will be recoded to define the relationships of different concepts to the core categories and to cause a theoretical saturation (Strübing, 2008: 20). Theoretical saturation means “[t]he point in category development at which no new properties, dimensions, or relationships emerge during analysis.” (Strauss & Corbin, 1998: 143) In the integration process the first step is to decide what the central or core category is. On the one hand this represents the main research theme and on the other hand it evolves from the research. “[I]t too is an abstraction. In an exaggerated sense, it consists of all the products of analysis condensed into a few words that seem to explain what ‘this research is all about’.” (Strauss & Corbin, 1998: 146) The core category has analytic power which derives from “its ability to pull the other categories together to form an explanatory whole.” (Strauss & Corbin, 1998: 146) It can emerge from existing categories or being found afterwards because none of the existing categories capture the whole story completely. Then a new term is needed which combines all the other categories (Böhm, 2010: 482).

Writing memos is an important and obligatory action in discovering theory. Memos are written records which “contain the products of analysis or directions for the analyst. They are meant to be analytical and conceptual rather than descriptive” (Strauss & Corbin, 1998: 217) and can vary in type and form (Strauss & Corbin, 1998: 219). Memos are based on the codes and on its comprehensive connections. They help to get a dissociation from the data and therefore to go beyond a descriptive work (Böhm, 2010: 477). They should support both the writing process and aspects like securing research results or securing accompanying thoughts and ideas (Strübing, 2008: 34f).

2.3.2 Semi-structured Interviews

Semi-structured interviews are chosen when the researcher can interview a person only once. In this case, a guideline facilitates the interview while leaving enough space for unexpected topics, ideas and questions. For this reason semi-structured interviews were chosen in the

present research project. The interview guideline also provides security for the interviewer (Schlehe, 2008: 126f). Semi-structured interviews – also named guided interviews – have predetermined topics and a list of questions. This guideline includes questions which have to be answered from the interviewee, but the formulation and the order can be changed by the interviewer during the interview, depending on the course of the conversation. It is also possible to ask ad hoc questions which are not included in the interview guide. This type of interview is normally used for interviews with experts (Gläser & Laudel, 2009: 42).

2.4 Realisation in the Field

The conducted semi-structured interviews have been done in English and can be classified as interviews with experts, because all of the interviewees had specific knowledge about the research field. 25 persons have been interviewed and can be divided into three groups, namely members from the ministries and research institutions, scheme operators from water supply systems in RGCs and health workers from the same RGCs. The first group was interviewed in the last weeks of the field research, after the interviews with the people in the RGCs, in the capital town called Kampala. The reason for this approach was to get an insight into the field before interviewing and discussing with experts from government and universities. In each of these six RGCs the scheme operator of the water supply system and also a health worker were interviewed. The interviews in the RGCs were supported by my assistant Shivan Kebirungi. She handled language problems and substantially contributed in making people more confident and talkative.

The data was recorded on a digital audio recorder and transcribed by myself using the open source program F4. Data management and analysis were performed using ATLAS.ti 6.2 according to grounded theory.

The interview guideline for interviews with scheme operators can be divided into three parts. The first part of questions deals with the water supply scheme and also contains technical questions. It includes questions such as what the scheme operators think about the sanitation and hygiene situation in the RGC, how the decision-making process is working in the RGC, who is involved and how the community is participating. Furthermore, questions about the

budget, the person responsible, and whether there is money for sanitation improvement and hygiene are included. The second part is about the model of Safety Plans. After a short explanation the scheme operators have been asked about their opinion. Questions like whether such a model can be expanded with sanitation and hygiene, where they see hazards and risks or who could be responsible for an implementation, have been asked. The third part deals with questions about the socio-economic context, about the living conditions and standards, and about the main economic activity and income source.

After the scheme operator had been interviewed we visited the health centre and talked with a health worker. Here the topics were the health status of the people in the RGC and the sanitation and hygiene situation. We asked which diseases are very common in the centre or if they had problems with waterborne diseases. Furthermore we asked if and how the health workers mobilize people to change sanitation and hygiene behaviour. Most of the time it was very difficult to get a conversation started with the health workers. These interviews were short, on average talking about 10 minutes.

The group interviewed last were people working at the Ministry of Water and Sanitation (MWE), at the Ministry of Health (MoH), at the National Water and Sewerage Cooperation (NWSC), at the Ministry of Local Government (MoLG) at District Level, at the Makerere University, at Kyambogo University and at the World Bank. These interviews were conducted in Kampala by me without my assistant. The questions can be divided into two parts. The first part consists of questions about the sanitation situation in Uganda, especially in RGCs, and where you can obtain data and information about it. I asked what these people at government or research level think about the division of sanitation into three ministries and how the cooperation is working between them. The second part of questions started with an interactive part in which the interviewee and I developed together a picture of a rural growth centre and its water and sanitation system. The main focus here was on how such a system could look like and where these experts see risks and hazards. Furthermore, questions about WSPs were asked, their opinion, if they see the possibility of expanding the model by adding sanitation and hygiene and who could be responsible for an implementation. Compared to the interviews in the RGCs, at this level it was much easier to get information and data. In general, the interviewees in Kampala were more communicative but equally friendly. Sometimes it was

not so easy to get an appointment but in the end it worked quite well and except one person with whom I had a telephone interview, I met all the others personally. With one person from the Ministry of Education and Sports (MoES), which is also responsible for sanitation according to the MoU, I could not get in contact because there was no functioning email address on the homepage.

3. Uganda – Background Information and Context

Uganda is one of the smaller East African countries and is situated directly on the equator next to Lake Victoria. The official state name is Republic of Uganda and the history of this country is very turbulent and ranges from colonization via dictatorship to a multi-party political system. In the next subchapters an outline about geographical, socio-political and socio-economic characteristics will be given. Also the history of the country and the history of the development cooperation will be delineated. This should give a basic knowledge about Uganda and its geographical and social situation.

3.1 Geographical Characteristics

Uganda is one of the smaller African countries with an area of 241,551 km², 41,743 km² of this area are inland waters (Munzinger Online, 2010a). It is located directly on the equator in East Africa and fondly called “Pearl of Africa” by Winston Churchill (Bauer, 2006: 6). It is bordered by South Sudan in the north, by Kenya in the east, by the United Republic of Tanzania in the south, by Rwanda in the southwest and by the Democratic Republic of the Congo in the west. Uganda is situated between the central and the east African rift valley on the east African plateau. Although landlocked it is one of the water-richest countries in East Africa. It belongs to the Nile states and to the Great Lakes region and contains many large lakes beside Lake Victoria, Lake Albert, Lake Edward, Lake George, Lake Kyoga and Lake Bisina (Munzinger Online, 2010a; Österreichische Forschungsstiftung für Internationale Entwicklung, 2009).

Figure 3.1 shows a map of Uganda from the year 2003. Since the 9th of July 2011 the neighbour in the north is named Republic of South Sudan after the separation from Sudan (Government of Southern Sudan, 2011). It is also important to mention that in Uganda there is a decentralization program and in the last years the numbers of districts increased enormously from 56 in 2000 to 114 in 2012. Although the map shows not the newest district developments it has been chosen, because it is from a serious source, the UN, and shows the most important aspects.

the west. Uganda is characterized by a fascinating landscape with many National Parks (Munzinger Online, 2010a; Österreichische Forschungsstiftung für Internationale Entwicklung, 2009).

3.2 Political History of the Country

Due to its landlocked position there has not been a pre-colonial penetration of the country. There have existed several feudal states since the 14th and 15th century in the south and in the west of Uganda, the most important are the kingdoms Buganda, Bunyora – Kitara, Ankole and Toro. The kingdom Buganda situated in the south at Lake Victoria has been the most influential one and substantial social and political institutions were already there which the British colonial government utilized for their form of control of “indirect rule”. The first British colonial administration in Buganda started in 1890 and in 1894 Uganda became British protectorate under the dominance of Buganda. The former Buganda, the city Kampala as well as the southern region of the country became the economic and cultural focus of the whole protectorate. The north, which has already been affected by low yield soils and armed conflicts, has been neglected (Österreichische Forschungsstiftung für Internationale Entwicklung, 2009).

In the first half of 1960 the Uganda People’s Congress (UPC) was founded under Milton Obote and in the second half of the year there has been a unilateral declaration of independence of Buganda. 1962 the UPC won the election and Milton Obote became prime minister. On the 9th of October 1962 Uganda became independent. Obote abrogated the constitution, banished the king and implemented a single-party system. 1971 General Idi Amin Dada took over power and established a reign of terror with a pogrom of Asians and members of the opposition. In 1979 Idi Amin was dislodged with help from the Tanzanian army. After this military act an interim government by the Uganda National Liberation Front (UNLF) lead the country, but there was instability and in 1980 Obote took over power for the second time through controversial elections. In 1981 Yoweri Kaguta Museveni started a guerrilla war with a rebel group named National Resistance Army (NRA) and conquered Kampala in 1986. Since 29th of January 1986 Museveni officially took over power and one year later the International Monetary Fund (IMF) and the World Bank started their structural

adjustment policy. In 2005 Museveni repealed the law that says each prime minister can only have two legislative periods of five years each time and was re-elected in 2006 (Bauer, 2006: 251f; Österreichische Forschungsstiftung für Internationale Entwicklung, 2009).

Museveni's way to democracy and his fight against poverty in Uganda was unprecedented and was a model for many other African states. But in the current legislative period the party faces pressure from the international community to solve internal political and cross-border conflicts. Furthermore his politics are more and more perceived as repressive which makes a democratic development more difficult (Österreichische Forschungsstiftung für Internationale Entwicklung, 2009).

For more than 21 years there has been a conflict in the north of the country between the Ugandan national army and the Lord's Resistance Army (LRA). The LRA is a rebel group lead by Joseph Kony, which fights against Museveni and his regime. Nowadays the LRA is banished in Uganda and has relocated its activities to neighbouring countries like Sudan or Democratic Republic of the Congo. The LRA however is still a danger for the civilian population and the stability of the country (Munzinger Online, 2012; Österreichische Forschungsstiftung für Internationale Entwicklung, 2009).

3.3 Socio-political Characteristics

In 2010 the estimated population of Uganda was 33.42 million of which 13.3 percent lives in urban areas. The population growth rate for 2010 is estimated at 3.56 percent and the median age is 15.7. In the list of human development by the UNDP Uganda is on position 161 of 187 with a value of 0.446 out of 1.0, which classifies Uganda as a Low Human Development Country. The Human Development Index (HDI) is composed of life expectancy at birth, mean years of schooling, expected years of schooling and the gross national income per capita. The value for the Multidimensional Poverty Index is 0.367, which means 36.7 percent of the population suffered from multidimensional deprivations in the year 2006. The index uses micro data from household surveys and identifies deprivations at the individual level in standard of living, health and education. In 2009 the poverty headcount ratio was 24.5 percent calculated by the World Bank, which means that 24.5 percent of the population lived below

national income poverty line. The poverty headcount ratio for rural population in 2009 was 27.2 percent (Munzinger Online, 2010a; United Nations Development Programme, 2011: 129ff; World Bank, 2012a).

Armed conflicts temporarily made more than two million people into refugees and displaced persons especially in the north of the country due to the war of the Lord's Resistance Army (LRA). At the beginning of 2010 there were officially 8,463 Ugandan refugees and asylum seekers abroad. 446,300 internally displaced persons and 138,896 foreign refugees have been recorded in Uganda. In 2005/06 the Ugandan-Diaspora consisted of 154,747 people according to a scientific review. 61,370 thereof in Great Britain, 36,190 in Tanzania, 13,433 in the United States, 11,839 in Canada and 5,399 in Ruanda. In Uganda there were 518,158 foreigners mainly from Sudan, Ruanda, Burundi, the Democratic Republic of the Congo, Tanzania and Kenya (Munzinger Online, 2010a).

In the whole country there are up to 56 **ethnic groups**. About 66 percent of these are Bantu groups mainly in the south of the country; the biggest Bantu groups are Baganda with 17 percent. The western Nilotic group of Luo consists among others of Acholi, Langi and Alur in the north and amount to 15 percent. Twelve percent are east Nilotic groups in the north east including Iteso and Karamojong and 5 percent are Sudanese groups particularly Lugbara in the far northwest. In addition there are minorities such as the Kuliak people Ik, Soo, Nyanji in the east of the country. The official languages are English and Swahili, but Luganda, Runyakitara, Lusoga, Luo and Ateso serve as lingua franca. According to the Ugandan National Household Survey of 2009/2010 population consists mainly of 40.5 percent Catholics, 34.7 percent Protestants, 12.1 percent Muslims and 9.0 percent Pentecostals. Traditional African religions are about 0.4 percent (Munzinger Online, 2010a; Uganda Bureau of Statistics, 2010: 125).

The **educational system** is characterized by the British system and has been quite good compared to other African states when the country gained independence. Uganda had the first university in East Africa with Makerere University. Due to long lasting political unrest and the repressive systems of Obote and Amin the quality decreased enormously. The education system consists of primary school which takes seven years, a secondary school with four

years level one and two years level two and tertiary education. Investments have been high in the last ten years in the education sector. Due to a governmental initiative compulsory education was introduced in the constitution of Uganda and there exists an exemption of school fees. But the government is confronted with the challenge to maintain the quality of education despite deteriorated basic conditions. It also has to minimize high dropout rates in schools and the brain drain of academics (Munzinger Online, 2010b; Österreichische Forschungsstiftung für Internationale Entwicklung, 2009). The adult literacy rate is 73.2 percent among the age of 15 and older. Gross enrolment ratio in primary school is 121.6 percent¹, in secondary school 27.4 percent and in tertiary education 4.1 percent. In primary education the pupil-teacher ratio is 49.3 pupils per teacher. 89.4 percent of teachers are trained to teach and the percentage of public expenditure on education is 8.2 percent of GDP according to the Human Development Report 2011 (United Nations Development Programme, 2011: 160).

The **health sector** in Uganda has to face the challenge of a low life expectancy at birth, 48 years for male and 57 years for female, and a high maternal mortality ratio of 310 per 100,000 live births for the year 2010 (Österreichische Forschungsstiftung für Internationale Entwicklung, 2009; World Health Organization, 2012: 1). According to the Human Development Report of 2011 published by UNDP 988 people out of one million are dying “due to diarrhoea attributable to poor water, sanitation or hygiene.” (United Nations Development Report, 2011: 152) Data about hand-washing with soap is outlined in chapter 5.2.1. The extended family as well as village community and the religious community are very important social networks in Uganda and can use the National Social Security Fund. There exist provisions for minimum wage, accidents at work, diseases, against child and forced labour and old-age or for widows but the implementation of laws and their regulations is a challenge (Munzinger Online, 2010b). In the country there are disparities in healthcare between urban and rural areas and different parts of the country. The health adjusted life expectancy for 2007 was 42 years, that means the “[a]verage number of years that a person can expect to live in ‘full health’ taking into account years lived in less than full health [...]”

¹ This is the number reported by the UNDP Human Development Report 2011. It means that 121.6 percent “of the official school-age population” for the primary school is actually enrolled in this level of education (p.160).

(United Nations Development Programme, 2011: 161) The mortality rate of children under the age of five is 128 per 1,000 live births and the adult mortality ratio is 348 per 1,000 people for female and 539 per 1,000 for male. The adult mortality ratio is the “probability that a 15-year-old person will die before reaching age 60.” (United Nations Development Programme, 2011: 161) On the countryside the density of health personal is still very low and beyond WHO recommendations. There was one doctor for 27,687 persons and one nurse for 3,540 persons (Ministry of Health, 2011: 22). The ratio between free hospital beds per people is 5:10,000 (World Health Organization, 2011a). The top five causes of morbidity among all ages in the years 2009/10 to 2010/11 are malaria with 36 percent, no pneumonia-cough or cold 19 percent, intestinal worms 5 percent, skin diseases 3 percent and diarrhoea-acute also 3 percent. A big challenge for the country is a high prevalence of AIDS and HIV, with 6.5 percentage of the population living with HIV (Ministry of Health, 2011: 12ff; Munzinger Online, 2010b; World Bank, 2010).

3.4 Socio-economical Characteristics

Uganda is classified as a low-income country by the World Bank. Low-income countries have a gross national income (GNI) per capita of 1,005 US\$ or less using the atlas method of the World Bank (World Bank, 2012b). The gross domestic product (GDP) in Uganda is 17.01 US\$ billions and the GNI per capita using the atlas method is 500 US\$ calculated for the year 2010. The annual growth rate of GDP is 5.2 percent in 2010 and has been declining in the last years from 8.7 in 2008. The country has to fight against a high inflation rate of 9.1 percent and external debt stocks for 2010 were 2,994 million US\$ (World Bank, 2010). Public expenditure on health was 9.0 percent of the GDP and a per capita total expenditure on health of 47 US\$ in 2010 (World Health Organization, 2011a). “External resources for health as a percentage of total expenditure on health” (World Health Organization, 2011a) was 25.9 percent in 2010.

In 2010 agriculture added 24 percent of value of GDP, industry 25 percent and 50 percent value was added by services. Regarding import and export in 2010, 34 percent of GDP of goods and services were imported and 24 percent were exported. Exported agricultural commodities include coffee which has not been processed, raw sugar, maize and tea.

Imported agricultural commodities are inter alia wheat, palm oil and refined sugar (Food and Agricultural Organization, 2011; World Bank, 2010).

The importance of agriculture as economic sector has been declining in recent years in relation to the industry or services sector. But it is still the most important employment market involving about 80 percent of the working population. 75 percent of the area is agriculturally usable but it is not entirely accessible. The second most important economic sector is the local administration sector followed by external trade. Mining of gold and ores is getting more and more important for the export sector and also for the manufacturing sector which is again increasing slowly (Österreichische Forschungsstiftung für Internationale Entwicklung, 2009).

Economic activity is regional concentrated in the south of the country due to better climatic conditions in agriculture as well as extended urbanization of this area. The north and the west of Uganda were affected and characterized by instability and activities of rebel forces especially in border areas. This area is still economically disadvantaged. Macroeconomic progress achieved by the government was to a significant part donor-financed which creates dependence from these donors and limits the freedom to act for government (Österreichische Forschungsstiftung für Internationale Entwicklung, 2009).

Data about development cooperation and the official development assistance (ODA) received by Uganda is presented in the next subchapter.

3.5 History of Development Cooperation

Uganda is one of the countries receiving international bilateral as well as multilateral official development assistance (ODA). The country is classified as a Least Developed Country (LCD) by the UN and as Heavily Indebted Poor Country (HIPC) by the International Monetary Fund and World Bank. The dependency of foreign aid remains at a high level and programmatically poverty reduction is the ultimate ambition of the government and international donors. The strategy is formulated in the Poverty Eradication Action Plan (PEAP). Every cooperation programme is subordinated to poverty eradication. All programmes for this ultimate ambition have a very high priority, especially the ones that help

the poorer and disadvantaged section of the population. In the rural development sector particular focus is laid on agriculture because 80 percent of the population is working in this sector. Another framework is the Millennium Development Goals by the UN which also serves to reduce poverty. One of the most important multilateral donors is the International Development Association (IDA) of the World Bank Group that supports Uganda since 1963 (Munzinger Online, 2010c; Österreichische Forschungsstiftung für Internationale Entwicklung, 2009).

According to OECD statistics Uganda received a net ODA of 1,730 US\$ millions in 2010 which is a net ODA/GNI of 10.3 percent. The top ten donors in 2009-2010 have been the United States, IDA, United Kingdom, EU Institutions, the African Development Fund (AfDF), Denmark, Norway, Japan, Ireland and the Global Fund. Regarding Austrian development relations Uganda is a priority country since 1993 and relationships date back to 1985 when the 10-point program of the National Resistance Movement was developed in Lower Austria. The Austrian development cooperation is focused on water supply and sanitation and justice law and order with the overall ambition of poverty eradication. At the beginning of the 1990s Austria has maintained an office in Kampala where also a programme officer for water & sanitation is present. In general the Austrian Development Cooperation in Uganda has a special focus on water supply (Österreichische Forschungsstiftung für Internationale Entwicklung, 2009).

4. Water Supply and Sanitation in Uganda

“Uganda has embarked on a water sector reform [...] mainly for water and to a lesser extent for sanitation.” (Water Supply & Sanitation Collaborative Council, 2011) For water supply the competencies are clarified and the Ministry of Water and Environment (MWE) is the leading governmental agency. For sanitation it is much more complicated and there is no line or leading ministry, on the contrary sanitation is in the area of responsibility of three different ministries. The water and sanitation sub-sector is one of two sub-sectors in the water and environment sector and “comprises water resources management, rural water supply and sanitation, urban water supply and sanitation, and water for production.” (Ministry of Water and Environment, 2011d: 8) This is under the Ministry of Water and Environment (MWE), but sanitation and hygiene consists of much more and therefore not only the MWE is responsible. In the following chapter and its subchapters the structures as well as the responsibilities of the most crucial actors for this thesis for Water and Sanitation are presented in more detail.

4.1 Institutional Structure and Responsibilities

Sanitation in Uganda belongs to a large extent to three different Ministries, the first one is the MWE as already mentioned, the second one is the Ministry of Education and Sports (MoES) and the third one is the Ministry of Health (MoH). The responsibilities are regulated through the Memorandum of Understanding (MoU) that was signed by MoH, MoES and MWE in 2001 (Ministry of Water and Environment, 2011a). The Sanitation Memorandum of Understanding (MoU) of 2001 “is a statement of institutional responsibility [...] with respect to sanitation and hygiene.” (Ministry of Water and Environment, 2009b: 274) In this document it is specified that the MoH is responsible for household hygiene and sanitation at all levels through the Environmental Health Division (EHD). School latrine construction and hygiene education is the duty of MoES. The planning for investments in sewerage services, development of public sanitary facilities in small towns (STs) and RGCs as well as promotion of good hygiene and sanitation practices in STs and RGCs is also a role of the MWE (Ministry of Water and Environment, 2009b: 10ff, 2011a).

The Memorandum of Understanding (MoU) also presents problems because it is not linked with clear financing mechanisms, and actors at government level which play an important role are not included in the MoU (Poonam, Mutono, n. d.: 8).

“That is the one, [MoU] it cares out the responsibilities of the different three Ministries but it leaves out the financing part of it which now makes collaboration and coordination a bit difficult and even in that Memorandum of Understanding some actors were left out like Ministry of Local Government they are partners in implementation, Ministry of Labour, Gender and Social Development they were left out but has been advised and we are waiting for the advised version and take up the new recommendations that were put in that version.” (I 9 Institutions)

On the other hand problems arise through the division of sanitation into three ministries, which are already divided into several departments. Thereby the communication and coordination seems difficult between them. An interviewee explained:

„You know we have got the issue it’s all about mandate there is a Ministry of Health, you have the Ministry of Education and then Ministry of Water. All of these three have a component in sanitation so who spear heads what and who budgets for what? And until that thing is sorted out where does sanitation lay?” (I 3 Institutions)

In addition to the roles and responsibilities in Sanitation regulated by the MoU there are other actors involved in water and sanitation. Figure 4.1 presents the structures of policy levels. It has been developed during an interview with a person working at the regional level and was extended with information from the reports of the MWE and the Government of Uganda (GoU) as well as information from other interviews.

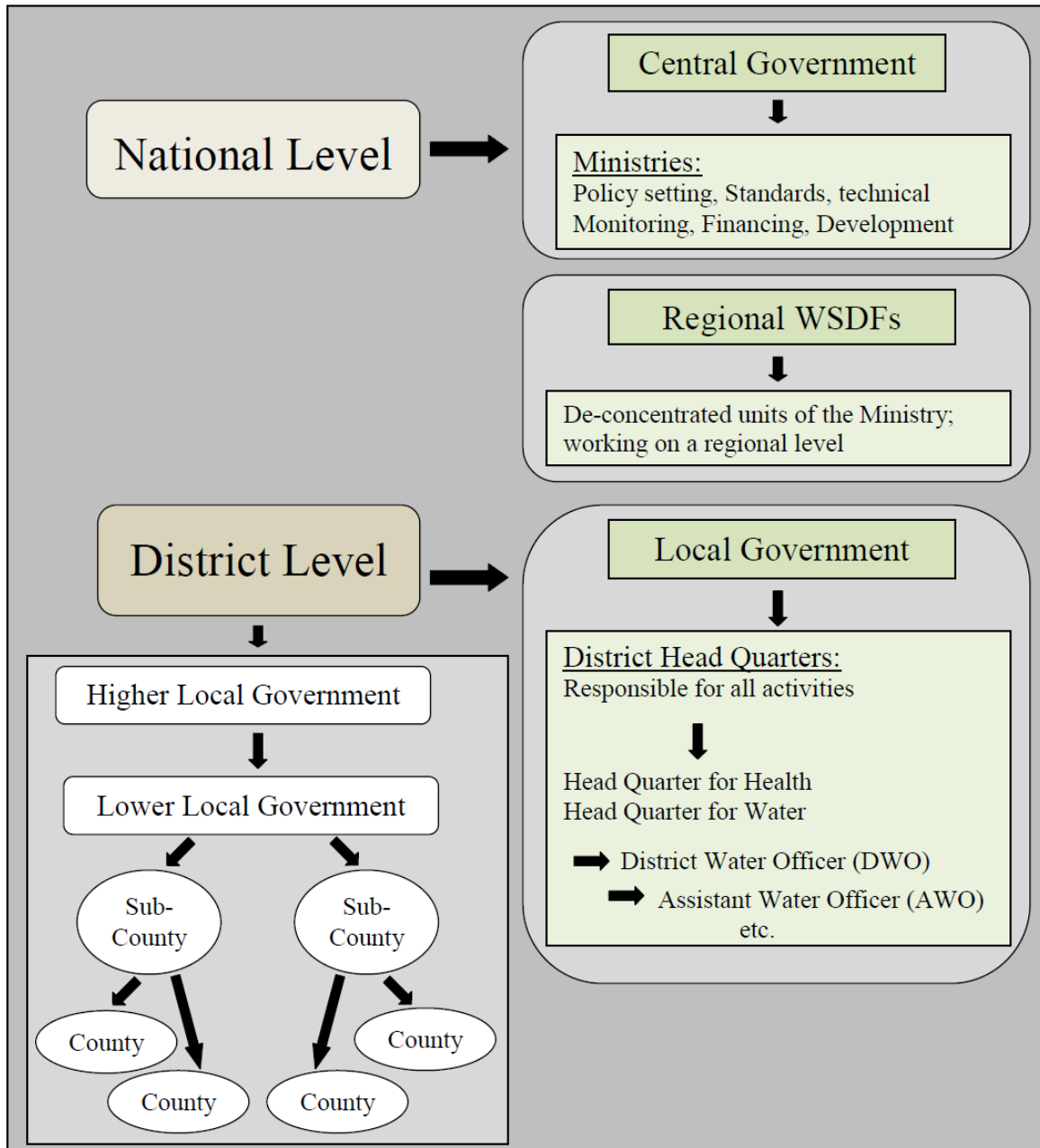

Figure 4.1 Structures of Policy Levels

This figure should give an insight before the different levels and crucial actors are presented briefly below.

4.1.1 National Level

At national level different ministries as well as the National Water and Sewerage Cooperation (NWSC) and NGOs are responsible for sanitation. To coordinate all the different actors a

“Sector Wide Approach (SWAP) was adopted in 2002 to enable the government and development partners to follow a single policy and expenditure programme.” (Water Supply & Sanitation Collaborative Council, 2011)

The Water and Sanitation Sector Working Group (WSSWG) “meets at least every quarter and provides policy and technical guidance for sector development in the country” (Government of Uganda et al., 2007: 6) The working group is permanently chaired by the MWE and consists of representatives from other key ministries, development partners and NGOs (Government of Uganda et al., 2007: 6). A sub-group is the National Sanitation Working Group (NSWG) which was set up in 2003. The aim of this group is the coordination of sector activities, lobbying and the support of policy development (Water Supply & Sanitation Collaborative Council, 2011).

The National Water and Sewerage Corporation (NWSC) is an important actor in urban water and sanitation. The Corporation is a parastatal that operates in 23 large urban centres and provides water and sewerage services. “NWSC’s activities are aimed at expanding service coverage, improving efficiency in service delivery and increasing labour productivity.” (Ministry of Water and Environment, 2011d: 10) It is not directly responsible for rural areas and for STs or RGCs, but it implemented the first Water Safety Plan in Uganda for the capital city Kampala in cooperation with the Makerere University and is therefore important to be listed here (I 12 Institutions).

MoH’s and MoES’s responsibilities are regulated through the Sanitation Memorandum of Understanding of 2001. A part of the responsibilities of the MWE is stipulated through the MoU but the MWE is also responsible for the national water infrastructure and laws regarding water resources.“ (Ministry of Water and Environment, 2011d: 9) Furthermore the MWE has to ensure efficiency and effectiveness in service delivery and therefore monitors and evaluates sector development programmes (Government of Uganda et al., 2007: 9).

The Ministry of Water and Environment consists of three directorates. For water supply and sanitation the Directorate of Water Resources Management (DWRM) and the Directorate of Water Development (DWD) are important (Ministry of Water and Environment, 2011a). The

Directorate of Water Resources Management (DWRM) was established in 2007. It “is responsible for developing and maintaining national water laws, policies and regulations; managing, monitoring and regulation of water resources through issuing water use, abstraction and wastewater discharge permits.” (Ministry of Water and Environment, 2011d: 9) Due to the fact that Uganda belongs to the Nile Basin riparian countries and is also a Lake Victoria riparian country, the MWE coordinates the participation in joint management of cross-border water resources (Ministry of Water and Environment, 2011d: 9). The Directorate of Water Development (DWD) consists of three Departments, the rural water supply and sanitation, the urban water supply and sanitation and water for production. It is “responsible for regulation of water services and for providing the overall technical oversight for the planning, implementation and supervision of the delivery of urban and rural water and sanitation services across the country”. (Ministry of Water and Environment, 2009b: 10) Furthermore the department “is responsible for regulation of provision of water supply and sanitation and the provision of capacity development and other support services to local governments, private operators and other service providers”. (Ministry of Water and Environment, 2011d: 9)

Not only ministries or ministry related institutions are dealing with water supply and sanitation, there are also around 200 NGOs working in this sector. The coordination is done by the Uganda Water and Sanitation NGO Network named UWASNET which is a national network organization. UWASNET was established in 2000 and its aim is to strengthen the contribution of NGOs and Community Based Organisations (CBOs) in the water and sanitation sector to achieve the sector goals (Ministry of Water and Environment, 2011d: 10). In order to guarantee a better cooperation between local governments and NGOs, a strategic framework is elaborated which guides these actors “on how to jointly plan and implement community mobilization/software activities with respect to water and sanitation.” (Ministry of Water and Environment, 2011d: 10f)

Problems that occur at the national level are on the one hand financing, though recently the importance of sanitation and hygiene is more and more recognized. There is a concern that more money has to go to districts for sanitation to increase prioritization for sanitation and

this is done through the district water and sanitation conditional grant but still a lot needs to be done (Government of Uganda et al., 2007: 107).

4.1.2 District Level

Since the Local Governments Act of 2000 Local Governments – districts, town councils or sub-counties – are empowered to provide water services. District Water Offices are established to “manage water and sanitation development and oversee the operation and maintenance of existing water supplies in the District”. (Ministry of Water and Environment, 2011d: 11) They closely cooperate with water users (Government of Uganda et al., 2007: 8).

The financing of local governments (LGs) partly occurs through conditional grants from central government. For water and sanitation this is the District Water and Sanitation Development Conditional Grant (DWSDCG). For a better collaboration and coordination at district level, in almost all districts District Water and Sanitation Coordination Committees (DWSCCs) have been established. The committee is composed of administrative and political leaders, technocrats and NGO/CBO representatives. Tasks of them are to monitor the implementation of water supply and sanitation programmes and strengthen the above mentioned collaboration and coordination with other important stakeholders in the implementation and follow-up of those schemes (Government of Uganda et al., 2007: 8; Ministry of Water and Environment, 2011d: 11).

The situation is not the same across the whole country and capacities vary significantly between districts and sub-counties. Due to this fact it is important that further development is stimulated in LGs, for instance “clustering of water authorities beyond district boundaries.” (Government of Uganda et al., 2007: 8) Where “Water Supply and Sanitation Boards (WSSB), acting on behalf of Water Authorities, of small towns’ and RGCs’ schemes have associated themselves into an umbrella organisation, which provides back-up and O&M [operation and maintenance] support to its members”. (Government of Uganda et al., 2007: 8)

The district level also has to fight against problems; a major one is under-staffing. The MoH states that environmental health meets gaps in staffing at all levels which causes inefficiencies

in service delivery. At districts “only 10 percent of ADHOs [Assistant District Health Officers] in charge of Environmental Health positions have been filled [...]” (Ministry of Health, 2011: 83) Also the MWE reports about low staffing levels in District Water Offices.

“The structure is supposed to have a district water officer minutely under the district water officer is supposed to have four assistants. One in water, one for mobilization, then one for sanitation and then there is another one for planning. But how many districts have filled this structure. Now we have been told we can recruit on contract these positions the ones you fill. But at the same time we are limited you can’t employ all this because now the amount of money, you have to do other things, reduces. So you find that matters. Ideally you were supposed to have all these assistants, we don’t have them. Like in my case here I don’t have any of these.” (I 3 Institutions)

This under-staffing affects implementation of water programmes with the consequence of poor sector performance. Especially newly created districts are affected, where 90 percent of staffs are under-qualified for an effectively and efficiently implementation of water activities (Ministry of Water and Environment, 2011d: 170).

4.1.3 Community Level

“[C]ommunities are responsible for demanding, planning, contributing a cash contribution to capital cost, and operation and maintaining rural water supply and sanitation facilities.” (Ministry of Water and Environment, 2011d: 12) In order to better perform these tasks a Water User Committee (WUC), sometimes also named Water and Sanitation Committee (WSC) should be established for each water point. The contribution to capital costs of investment is very small and water users cover only a part of operation and maintenance costs. According to the policy, operation and maintenance costs should be covered fully by water users because at the moment there are no subsidies budgeted (Government of Uganda et al., 2007: 8; Ministry of Water and Environment, 2011d: 12). It is intended that thereby “[o]n a long perspective, communities will strongly demand good services from private and public service providers and will opt for greater voice during the investment and operation planning process”. (Government of Uganda et al., 2007: 8f)

4.2 Water and Sanitation Development Facility – South Western Branch

The establishment of the Water and Sanitation Development Facility (WSDF) was a long term aim of the Water Sector Reforms in Uganda since the early 2000s and “is a funding mechanism of the Ministry of Water and Environment for water and sanitation investments at community level through a demand responsive approach.” (Ministry of Water and Environment, 2009a: i) The “concept was built on the experience developed since 1996 under the two successive phases of the South Western Towns Water and Sanitation (SWTWS) Project.” (Ministry of Water and Environment, 2011d: 120) During these two phases appropriate mechanisms and standards have been developed for the specific requirements and conditions in RGCs and STs (Ministry of Water and Environment, 2011d: 120).

It is also considered as an instrument to channel funding and technical support directly to the service providers which are the local governments in the STs and RGCs whereby transition costs are reduced and efficiency increased (Ministry of Water and Environment, 2011c, 2011d: 120). Funded activities by the WSDF include on the one hand water supply infrastructure development which comprises new investments, rehabilitations and major extensions and on the other hand comprehensive software and programs which aim to promote sanitation in STs and RGCs (Ministry of Water and Environment, 2009a: i).

District local governments in cooperation with facility staff identify and prioritise RGCs and STs which are benefiting from infrastructure development through a public open call for application (Ministry of Water and Environment, 2009a: i). Afterwards RGCs and Small Towns have to apply for water and sanitation services. They have to prepare the application which is submitted to the Local Council and to the Steering Committee. The Steering Committee comprises staff from the Department of Water Development, the WSDF branch manager and representatives of the participating districts, the Water and Sanitation Committee/Water and Sanitation Board and of relevant NGOs/CBOs (Ministry of Water and Environment, 2009a: 3). Then the application is further submitted to the WSDF. The WSDF evaluates and ranks the RGCs and STs, with the aid of consultants, and submits this to the Steering Committee. Afterwards the list of successful applicants is displayed on district notice boards (Ministry of Water and Environment, 2009a: 14ff).

The first WSDF was the south-western branch and was launched in July 2006 by the Government of Uganda with support from Development Partners under the Directorate of Water Development (DWD) an arm of the Ministry of Water and Environment. At this time it was a pilot structure with the task of identifying STs and RGCs for getting “access to piped safe water and improved sanitation [...] [and] funds production of designs and actual construction of the systems, and sets up Operation and Maintenance structures”. (Ministry of Water and Environment, 2011c)

The overall objective of WSDF is to improve the living situation, the socio-economic situation and the opportunities of people living in STs and RGCs. This should be achieved through “the provision of safe, adequate, reliable and accessible water supply [and] the promotion of sanitation facilities.” (Ministry of Water and Environment, 2009a: 4) A further objective is to reduce water-borne diseases through the improvement of general health conditions in targeted STs and RGCs. Due to the decentralized and participatory characteristic of the WSDF and its bottom up approach an empowerment of communities, a high degree of community organization is promoted. In addition, appropriate technologies like renewable solar energy and ecological sanitation are used for water and sanitation interventions to contribute to environmental protection. The objective of WSDF is also to address the gender issue and empower women in a way that both sexes are involved in the decision making process (Ministry of Water and Environment, 2009a: 4). A very important element of the WSDF approach is “a follow-up support to communities for Operation and Maintenance (O&M) through umbrella organisations and private sector operators.” (Ministry of Water and Environment, 2011d: 120)

In the whole country there are four facilities, named WSDF-North, WSDF-East, WSDF-Central and WSDF-South West. The South West branch is located in Mbarara and according to the “Sector Performance Report” of 2011 responsible for 24 Districts, including Ntungamo, Kisoro and Kabale (Ministry of Water and Environment, 2011d: 121).

4.3 South Western Umbrella of Water and Sanitation

The South Western Umbrella of Water and Sanitation (SWUWS) is a water board association for water and sanitation schemes developed to coordinate and support member small towns and rural growth centres in operation and maintenance in the south west of the country. “The idea is to pool resources and address all those issues that cannot be handled economically by any single one of the schemes.” (Ministry of Water and Environment, 2009c: 23) In the whole country there exist five umbrella organisations, which are registered as non-profit organisations. They are

“limited by guarantee with membership of selected small towns, rural growth centres and rural large gravity flow schemes to assist member schemes carry out operation and maintenance functions and share services that would otherwise be too costly for individual schemes such as water quality monitoring, technical inputs to expansions and system repairs, monitoring of service delivery and operational audits.” (Ministry of Water and Environment, 2011d: 122)

In Uganda a decentralization policy in the water and sanitation sector is prevalent and also service delivery is decentralized (Pinfold, 2006: 95), meaning it needs structures to provide backup support. In this case the RGCs and STs do not have all the necessary experience and knowledge to run the water supply scheme and therefore the umbrella organisations are providing them with services like “technical backstopping; assistance with legal, tariff, procurement and contractual issues; building of managerial and financial management capacities [...]; procurement of non-standard spare parts; water quality monitoring (including operation of a regional water laboratory) and supervision of rehabilitation and extension works.” (Ministry of Water and Environment, 2009c: 23)

Due to large operational areas, which necessitate extensive staff movements, their logistical operational costs are very high. Despite the support from the umbrella organisation, there are still challenges regarding the management of operation and maintenance for provision of services and system sustainability. On the basis of these umbrella organisations the operation and maintenance service has greatly improved in these towns although the organisations are still handicapped by limitations in logistics. Therefore effective support in operation and maintenance in the member schemes is restricted. Recently the SWUWS has been supporting

77 member water supply and sanitation schemes (Ministry of Water and Environment, 2011d: 122; South Western Umbrella of Water and Sanitation, 2011: 2).

5. Rural Growth Centres

During my research in Uganda I visited 6 RGCs in the south west of the country. These are Kagarama, Muhanga, Rubaare, Rubuguri, Rwenanura and Rwentobo. The RGCs are some of the ones elected by the WSDF-SW that have planned piped water supply systems. All of these water schemes are members of the South Western Umbrella of Water and Sanitation (SWUWS). After a scheme is handed over to the water board and to the scheme operator they, including the community, are responsible, with help and support from the SWUWS. In the present case five of the six analysed RGCs were handed over and one scheme was still in the construction phase and therefore under the WSDF-SW.

According to the Ministry of Water and Environment rural growth centres are settlements with a population between 500 and 5,000 people, whereas definitions vary (Jung et al., n. d.; Ministry of Water and Environment, 2009a: 76, 2011b). These centres are located in rural areas and are getting more and more important for development cooperation. RGCs have a certain infrastructure including mostly schools, a health centre and little shops. In some RGCs there is one market day per week and the centre forms an important traffic junction as well as the basis for economic development and the establishment of small industries. In order to stimulate this development, infrastructure regarding water supply and sanitation as well as hygiene must be present. RGCs have a central role in development and inhibit migratory pressure to large cities (Friedrich, 2010). They are still rooted in rural areas and farming is one of the most common economic activities, as it is in Uganda in general. Most of the time it is subsistence farming which means that people produce to feed their own family. In rural Uganda for 50.4 percent subsistence farming is the main economic activity (Uganda Bureau of Statistics, 2010: 96). In 2002 82 percent of the population in the district of Kabale lived on subsistence farming, in the district of Kisoro 89 percent and in the district of Ntungamo 83 percent (Uganda Bureau of Statistics, 2002a: 6, 2002b: 6, 2002c: 6). Mostly the agricultural activity comprises crop and livestock farming. Livestock farming is restricted to goats, cattle, pigs and poultry. Grown crops are inter alia bananas, Irish potatoes, sweet potatoes, sorghum (e.g. I 3 Scheme Operators; Kisoro District Local Government, 2008: 7; Natamba et al., 2010: 4).

Most of the time extended families are living in one house. According to the Uganda National Household Surveys Report 2009/2010 the mean household size for rural areas is 5.2 (Uganda Bureau of Statistics, 2010: 9). According to the scheme operators, in general houses are small but there is enough space for each person. It can be the case that a person of the family is working in the RGC but the family is still in the village and he or she is commuting every week (I 3 Scheme Operators). Animals are accommodated in separate rooms, so there is no danger of animal faeces (e.g. I 1 Scheme Operators).

The visited six rural growth centres have same characteristics and during my research stay I made sketches together with interview partners from the Ministry and the Universities. Figure 5.1 shows the result of these drawings.

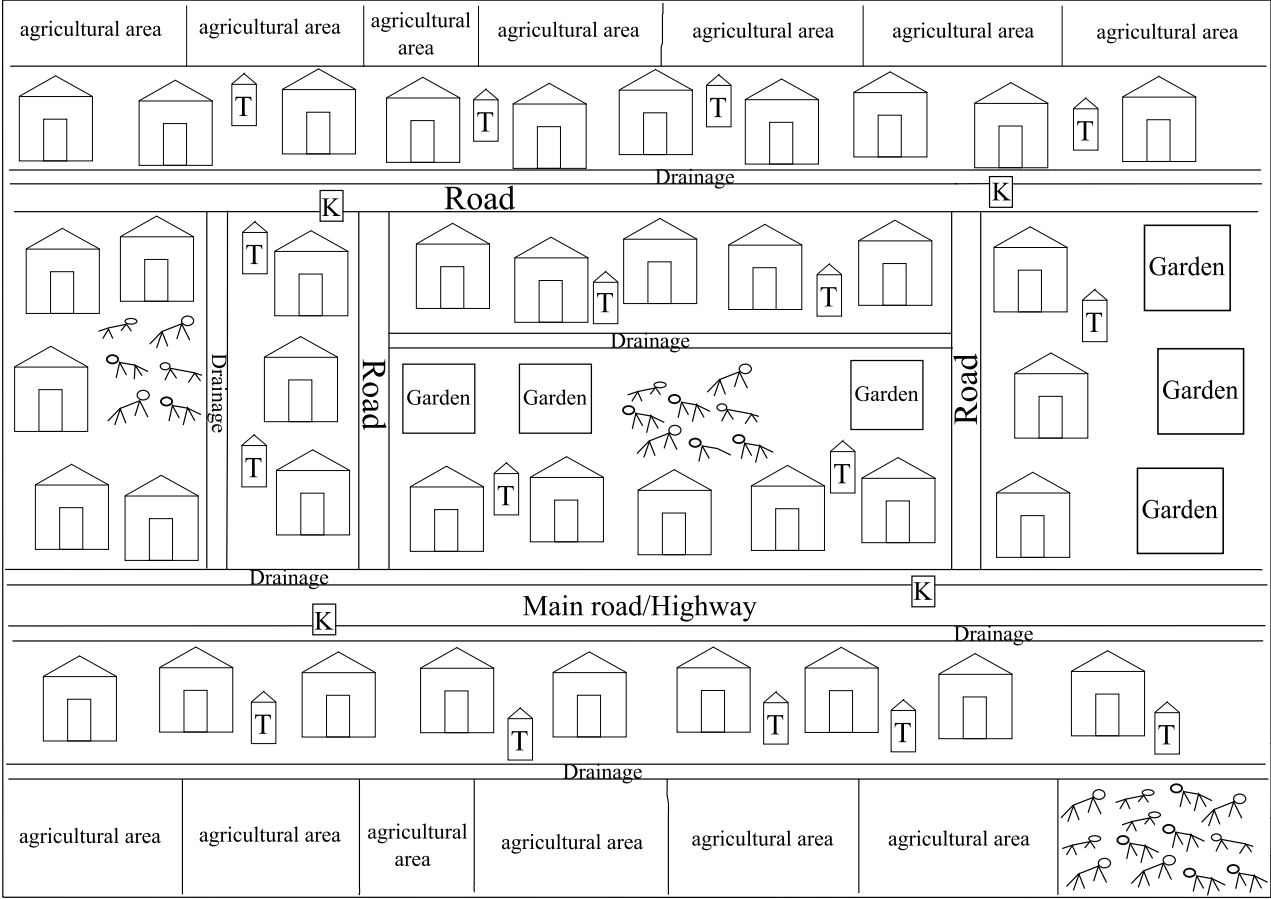

K – Public Water Kiosk; T – Toilet

Figure 5.1 Sketch of a Rural Growth Centre

As shown in the sketch there is a main road or highway, for instance three, of the six RGCs (Muhanga, Rubaare and Rwentobo) are located along the Kabale-Mbarara Road. As I have seen, mostly there are fields and gardens behind the houses where people are cultivating. Some people have animals or little shops. In the visited RGC there is a piped water supply system, some inhabitants have private connections and others buy water at public water kiosks. Behind houses or next to roads there are drainage channels. The centre of the RGC is most of the time densely populated and outward a bit more scattered. The public water kiosks are distributed in the RGC and the number of kiosks varies depending on how big the centres are. The toilet situation is slightly more difficult and it is not possible to say if every home has a toilet or not but there is not a hundred percent sanitation. In the south-western region of Uganda, where these RGCs are located, it is much better than in the north-east. The Annual Health Sector Performance Report of 2011 states that the latrine coverage in households for the district of Kabale is 92 percent, for the district of Kisoro it is 55 percent and for the district Ntungamo it is 88 percent (Ministry of Health, 2011: 210ff).

5.1 Water Supply Scheme

Five of the six analysed RGCs are in operation, only one is not handed over yet. The oldest scheme, Muhanga, started operation in 1998 and was the first scheme under the South Western Umbrella of Water and Sanitation. The other schemes are in operation since 2000, 2007, 2008 and 2010. To be members of the South Western Umbrella of Water and Sanitation the schemes pay membership fees (Interviews Scheme Operators).

In the RGCs of these three districts mainly gravity-flow schemes are used, such as those presented in the Uganda Water Supply Atlas of 2010 (Ministry of Water and Environment, 2010: 320ff) Gravity flow water supply systems are systems “in which the water falls due to its own weight, from a source above, to end-users below. The energy used in the process is the potential energy the water has due to its elevation.” (Arnalich, 2010: 2) But there is also the possibility of pumped piped water supply systems where the water is pumped from the water source up on a higher altitude to a reservoir. The type of energy used for pumping can vary. In Table 5.1 general information of the schemes is given. The distribution of water from the reservoir is accomplished by gravity.

Table 5.1 General Scheme Information

RGC	Starting Year	Type of Energy	Water Tariffs (per jerry can)
Kagarama	not handed over	electricity + stand-by generator	100 UGX
Muhanga	1998	gravity	initially 25 UGX now 50
Rubaare	2007, extension 2010	electricity	50 UGX
Rubuguri	2000	gravity	25 UGX
Rwenanura	2010	solar panels	50 UGX
Rwentobo	2008	electricity + stand-by generator	private connections 50 UGX, kiosks 100 UGX

Water costs vary from scheme to scheme and in these specific RGCs costs are between 25 Uganda Shilling (UGX) and 100 UGX per jerry can. 100 UGX are, depending on the exchange rate, between 0.03 and 0.04 Euro. Some schemes raised the costs after some time because maintenance was not possible with relatively low revenues. At the time scheme number four was in negotiation about raising costs from 25 UGX to 50 UGX because of insufficient revenues (I 4 Scheme Operator). For private connections people have to pay initially to be connected. Most of the time people can afford water but there are defaulters and some are complaining (e.g. I 5 Scheme Operators).

The water source is a very important link in the water supply chain and has to be fenced to be protected from all kinds of contamination. The community has to buy the land so the area can be properly fenced (Ministry of Water and Environment, 2009a: 5). This is the case most of the time, but in some RGCs the materials are quite old and should be renewed. Some water sources have a caretaker who cleans. Mostly only the caretaker and the scheme operator are allowed to enter the source area (e.g. I 5 Scheme Operators). In the RGCs which are along the highway, the source was not too far but in remote areas it can be some kilometres away. For instance in one visited RGC, named Rubuguri which is located in the hilly area in the district of Kisoro, water is distributed over 60 kilometres. This fact makes maintenance and repair much more difficult than for other schemes and can become a problem (I 4 Scheme Operator). Often the water scheme is not only supplying the RGC, but also villages around with

extensions. Or like in one case, the scheme is supplying the whole sub-county (I 5 Scheme Operator).

Water quality monitoring is conducted every three months by the umbrella organisation. They have a laboratory, all the equipment for doing water testing and microbiological examination and a chemist. Water samples are taken from the water tank, from the kiosks and from one of the water users with private connection. Normally water quality of these systems is no problem (e.g. I 3 Scheme Operator). Only the scheme of Kagarama is problematic, there is no water running right now because of bursting of pipes and therefore people have to use other water sources where the water quality is insufficient. In this scheme also the water quantity is a problem (I 1 Scheme Operators). All the other schemes have enough water.

In the water supply schemes there are public EcoSan toilets, most of the time these toilets are in the office building of the scheme. In the newest scheme there is also a public bathroom (I 5 Scheme Operator).

5.1.1 Scheme Operator

The scheme operator of the water supply scheme is responsible for operation and maintenance under the leadership of the water board, with support from the SWUWS. They receive specific training before becoming scheme operator. At this training candidates for this position participate and afterwards one is selected. After planning and construction is finished the scheme is handed over to the water board, but the scheme is still in possession of the government. The Ministry of Water and Environment has a performance contract with the water board. Based on this contract the water board has to appoint a scheme operator with whom it has a management contract. That means the scheme operators are appointed by the water boards. The contract is signed for three years and can be terminated if work is not fulfilled, but it can also be renewed. Scheme operators have to keep books of water meter readings and collected money. These books are examined every month by an auditor from the sub-county, and after six months by one from the SWUWS who checks that the books are kept correctly. Meter readings for private connections are collected every month and for the public water kiosks every evening. The salary of the scheme operator is 40 percent of the

collected money from water sales, which varies between dry season and rainy season. The scheme operator is the one responsible for repair, if there are just little problems. When there is no other option the umbrella is helping with technical knowledge and support. If needed, it can also give loans for investments. The aim of this structure is that support needed by schemes from the SWUWS is decreasing over time (e.g. I 3 Scheme Operators).

5.1.2 Water Committee/Water Board

The water board is a very important organ and is managing the water supply scheme. The water board has a performance contract with the ministry where activities and responsibilities are defined. The water board is appointed by the sub-county and normally there are between five and seven board members depending on the location of the RGC (Directorate of Water Development, n. d.: 3; Ministry of Water and Environment, 2011d: 122 e.g. I 6 Scheme Operators). For instance one scheme is located in two sub-counties with a board of seven members. If it is one sub-county there are five members. A scheme operator explained:

“We have board members, there are five board members, three are water users that are the chairman, the treasurer and the secretary and we have a representative from the sub-county council that is a councillor in charge of health. So he is one of the board members and another one is a local government representative, those are civil servants by the government. In most cases we work with the sub-county chief. So those people are elected by the council, with the help of the south-western umbrella.” (I 3 Scheme Operators)

There are regular meetings and board members get allowance for these meetings (e.g. I 3 Scheme Operators).

The water board is under the local government which is in this case the sub-county council. The board members are the ones who appoint the scheme operator in coordination with SWUWS and they can choose to renew the contract or not. If something has to be done in the scheme, such as repair or extension, the water board together with the scheme operator submit a report to the sub-county and one to the umbrella. The board gives the sub-county options for example for extensions and the sub-county decides what to do (e.g. I 3 Scheme Operators).

For a better understanding the structure of this system figure 5.2 illustrates the relationship between the different actors of a running water supply system in a RGC.

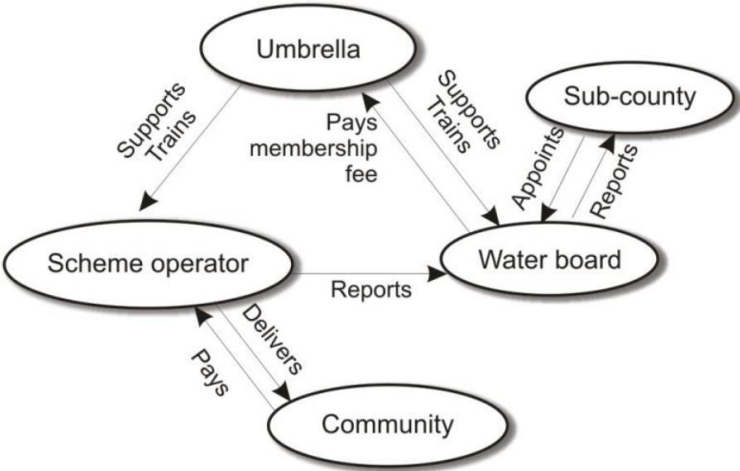

Figure 5.2 The “Umbrella” Service Delivery Model (Koestler, Van Lieshout, 2012: 3)

The water board is the one who is making decisions together with the scheme operator for the water supply scheme. For big decisions the sub-county is responsible and also the umbrella organization is included in such decisions. Water users are integrated into the board by three board members who are the chairman, the treasurer and the secretary. If there are problems with the chairperson or other board members, the LC III (Local Council III) which is the sub-county, can release them. That means if board members are not acting correctly the sub-county chief can change them. Responsibilities are defined in the contracts (I 5 Scheme Operators).

The water board is among other things responsible for the budget as well as for monitoring the work of the scheme operator. The scheme operator prepares the budget every financial year and submits it to the board members. Here it is discussed and amendments are included and afterwards it is submitted to the sub-county and at this level it will be approved. When it is approved the budget will be implemented by the water board and the scheme operator. The budget includes expenditure for water supply but not for sanitation. So actually the scheme does not have any money for sanitation and hygiene improvements. The earned money from the public water kiosks and private connections is collected by the scheme operator and after

deduction of his salary and the money for operating costs it is brought to the treasurer who is responsible for banking (e.g. I 5 Scheme Operators).

5.1.3 Connections and People supplied

In general there are public kiosks with tap attendants and also private connections directly into houses or institutions like schools. After a scheme is opened for some years it is often only possible to give rough estimations about current population, because the last census was 10 years ago and the next national population and housing census will be in August 2012 by the Uganda Bureau of Statistics (Uganda Bureau of Statistics, 2012). In some RGCs there are many institutions that gather people from villages during the day, e.g. schools, and therefore the number of people supplied is much more than the population of the RGC. Table 5.1 shows how many people the individual RGCs are supplying. Also information about public kiosks, private connections and institutions is given if available. The information has been collected during the interviews with the scheme operators (Interviews Scheme Operators, Ministry of Water and Environment, Directorate of Water Development, 2006: 10).

Table 5.2 Number of people supplied and types of connections

RGC	People Supplied	Public Kiosks	Private Connections	Institutions
Kagarama	above 400	4	55	-
Muhanga	about 5,000	8	-	-
Rubaare	6,739	5	200	11
Rubuguri	3,874	13	28	7
Ruwenanura	about 1,200	-	60	-
Rwentobo	about 9,000	4	99	13

At public water kiosks a tap attendant sells. He or she gets paid by the scheme operator from the scheme operators own salary. It is a percentage of collected money from water sale. The tap attendant is responsible that used jerry cans are clean; otherwise they have to confiscate the container or send him or her away. The tap attendant is the one who inspects the containers. In some cases he or she puts posters at the kiosk area in local language to inform that people must have clean jerry cans to get water (e.g. I 3 Scheme Operators). Picture 1 shows a public water kiosk with a tap attendant and the typically used water containers named jerry cans.



Picture 1 Public Water Kiosk with Tap Attendant

A public water kiosk can look like this or it can be a little house with a tap outside. Normally the tap attendants use an upper part of a plastic bottle as funnel.

5.1.4 Problems within the Schemes

Water supply schemes have to deal with problems in different areas like problems with management, operation or technical ones. The ones I outline here are of those kinds that endanger the health situation which means in particular problems deteriorating hygiene. Important to consider is that these problems are from the point of view of scheme operators.

According to scheme operators a big problem is the fast development of RGCs without spatial planning and development of infrastructure. People are coming from villages to these centres and RGCs make a development from rural to urban which is a big challenge, especially for the sanitation situation. Space for toilets is becoming rare and latrine coverage is decreasing. If people are not practising safe excreta disposal water can get contaminated by faeces leading to severe impacts on health (e.g. I 3 Scheme Operators).

Scheme operators indicate the main problems in water supply schemes as bursting of pipes because of old or faulted materials or because of vandalism. It can happen that people vandalise pipes to take water for free. As a result there are water losses and also losses in money. For instance one scheme has not had water for four months because of bursting of pipes, therefore they do not sell water and there is no money. Due to the fact that there is no safe water from the source at the kiosks people use alternative water sources which are not safe and that results in a major risk for health (I 1 and I 4 Scheme Operators).

In some schemes the water sources are not fenced properly which can lead to source water pollution and to unsafe water which is consumed (I 2 Scheme Operator).

Some schemes face the problem of landslides which damage pipes. Also erosion and wet areas are a big problem because pits can collapse or can get filled with water and as a result groundwater and surface can be polluted (I 4 Scheme Operators). This requires pits which are built out of bricks, EcoSan toilets or other alternatives to ensure safe excreta disposal.

5.2 Sanitation Situation

The sanitation situation is assessed by some scheme operators as poor and by others as good (e.g. I 2 and I 6 Scheme Operators). The different views are caused on the one hand by different characteristics of RGCs and on the other hand by different perceptions of the scheme operators. Also most of the interviewees from the Ministries assess the sanitation situation in RGCs as poor (e.g. I 2 Institutions). The different perceptions show that there are no defined standards and regulations. However all of them see an improvement of sanitation through the new water supply scheme and previous assessments and community mobilization (I 4 Scheme Operators). Often sanitation and hygiene is associated by scheme operators with clean water containers and safe storage of water because that is in their area of responsibility (I 5 Scheme Operators).

For scheme operators it was important to underline the fact that before a water supply scheme is opened “basic sanitation coverage must be ranked at 100%. This percentage is described at a level where each household in the target town has at least a pit latrine for safe excreta

disposal.” (Ministry of Water and Environment, 2011f) This is the common procedure of the WSDf but there are also exceptions where schemes have been opened without 100 percent coverage (I 4 Scheme Operators). However, solely through this approach an improvement is achieved. Despite this fact one of the biggest problems in sanitation is operation and maintenance and therefore latrine coverage is very often decreasing (e.g. I 6 Scheme Operators). Reasons for this include pits which are filled up and not replaced by new latrines because of construction costs or lack of space. Population density is increasing and as a consequence free space is decreasing. “Sometimes they are willing to construct them, but they don’t have space where to construct those toilets.” (I 3 Scheme Operators)

Furthermore change of behaviour is a big challenge in RGCs. People do not see the benefit and effectiveness compared with the costs and therefore changing behaviour is very difficult. “We all know that sanitation is good, but very few people are concerned. [...] So people’s willingness to participate is very low.” (I 3 Scheme Operators)

Health workers share the opinion of scheme operators and according to them the reason why people are not practicing hand-washing or miss some other hygiene measures is disinclination. Knowledge already exists but realization is a problem. On the one hand it can also happen that for example no water is available and therefore hand-washing is not possible (e.g. I 1 Health Workers). On the other hand people often have very little money and therefore priorities are different. Of course sensitization is still very important. “You know people, the communities they take a lot of time to change, behaviour change takes some time and actually some messages have to be on going, yea. They have to be going on. There are people who are young who need to hear this information.” (I 1 Health Workers)

5.2.1 Sanitation Facilities

The most common toilet in Uganda is the pit latrine which is also the case in the visited RGCs in the south west. Table 5.4 gives further information about the different types used in the country and about differences in urban and rural areas as well as specific information for the western region.

Table 5.3 Type of Toilet Facilities in Households in 2009/2010 (%) (adapted from Uganda Bureau of Statistics, 2010: 120)

Residence	Pit Latrine	VIP	Flush	Bush/no toilet	Total
Uganda	85.5	3.7	2.2	8.7	100
Rural	86.8	2.5	0.3	10.3	100
Urban	80.0	8.6	10.2	1.3	100
Western Region	95.7	1.2	0.8	2.3	100

As the table illustrates the most commonly used toilet is the pit latrine. Furthermore VIP latrines – ventilated improved pit latrines – and flush toilets are used. The table shows that a high percentage of households still do not have a toilet and use the bush or other alternatives like plastic bags. This is also referred to as open defecation.

For a better understanding of the situation, as well as the problems, which can arise, these different types of toilets are described briefly. Due to the fact that EcoSan toilets are “among the safest options from the perspective of ground water contamination” (Sugden, 2006) and the fact that the SWUWS and the WSDF are promoting the EcoSan toilet this type is also described (Ministry of Water and Environment, Directorate of Water Development, 2006: 6). These descriptions do not claim to include all aspects and do not aim to be a technical support paper. The objective of the descriptions is to better understand the situation and the problems and risks that can result from sanitation facilities.

The technical term user interface means “the part of the toilet with which the user interacts.” (Tilley et al., 2008: 35) This part is connected to the collection system and to the storage or treatment system. There are different systems of user interfaces. In general one can distinguish between pedestal systems where the user can sit on and squat pans where the user is squatting over (Tilley et al., 2008: 35).

Sanitation systems can be differentiated into on-site systems and off-site systems. On-site methods include septic tanks and all forms of pit latrines where “the wastes are stored at the point of disposal and usually undergo some degree of decomposition on site.” (ARGOSS, 2001: 17) Here emptying or the construction of new facilities is needed periodically. Off-site

methods comprise “different forms of sewerage where faecal and household wastes are carried away from the household.” (ARGOSS, 2001: 17) In the latter systems treatment occurs at treatment plants and not at the household (ARGOSS, 2001: 17).

The very common toilet system of **pit latrines** works with two different processes, namely leaching and degradation. “Urine and anal cleansing water percolate into the soil through the bottom of the pit and wall while microbial action degrades part of the organic fraction.” (Tilley et al., 2008: 53) In general pit latrines consist of a superstructure and a single covered pit by a slab which includes a drop hole. Slabs can be made out of wood, which can be covered with mud, or out of concrete. Shelter and privacy for users is given by a superstructure. A pit latrine should have the following characteristics. First of all, an adequate foundation that prevents the slab and the superstructure from damage. Furthermore, a tight-fitting lid that covers the drop hole which reduces smells and hinders insects entering the pit. For flood prevention the floor should be raised at least 0.15 m above ground level. To prevent the pit from collapsing, it should be adequately lined, especially when soil is unstable; if soil is stable it need not be lined. In order to facilitate the process of leaching, the bottom of the pit should remain unlined. The pit is usually 1.0-1.5 metres wide and 3 to 5 metres deep, depending on soil and groundwater conditions. If a pit exceeds 1.5 metres the risk of collapsing increases. The recommended distance between pits and drinking water sources varies, in general “[t]he greater the distance between the latrine and the water point, the lower the risk of contamination.” (Sugden, 2006) In scientific literature data varies, i.e. Brikké and Bredero write about 15-30 metres and the WHO recommends at least 30 metres (World Health Organization, 1996: 18). “The actual distance will depend on local hydrogeological conditions, such as soil characteristics, and groundwater depth and flow.” (Brikké, Bredero, 2003: 105) A high groundwater table or a firm floor can require a latrine which is raised above ground level. There are two possibilities to handle a filled pit. The first one is to build a new latrine, take the superstructure of the first one and cover the old pit with enough soil to hygienically seal it off. The second possibility can be to empty the pit mechanically or manually and remove and transport the faecal sludge to further treatment (Brikké, Bredero, 2003: 105; Tilley et al., 2008: 17ff).

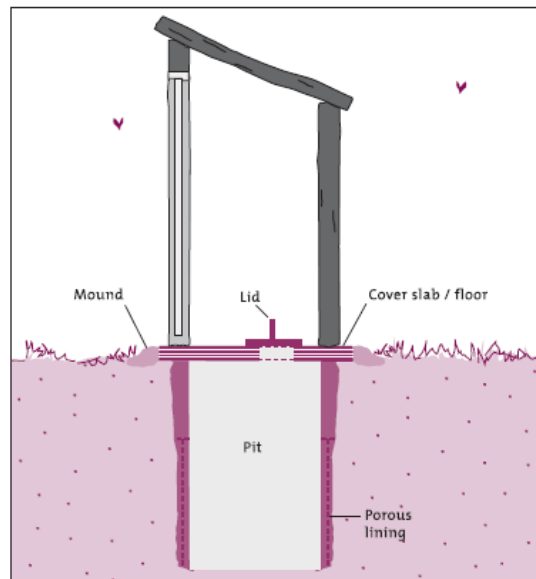

Figure 5.3 Traditional Pit Latrine (Brikké, Bredero, 2003: 105)

The main advantage of this type is that it is one of the least expensive ones regarding construction costs. Furthermore operation and maintenance is quite simple and comprises cleaning the slab, putting the lid back after every usage, checking the slab for cracks and also check the superstructure of any kind of damage. As well as this, it requires little or no infrastructure. Another advantage is that solid cleansing materials, e.g. toilet paper or stones, can be put into the pit as well as anal cleansing water. If the pit is filled it can be emptied or the superstructure can be reused for a new pit. A further advantage is that it does not need a source of water (Brikké, Bredero, 2003: 105; Stockholm Environment Institute, 2008: 1; Tilley et al., 2008: 17ff).

Disadvantages are that if soil and groundwater conditions are not appropriate, groundwater and consequently drinking water can be polluted due to leachate. Furthermore, problems can arise with the construction of the slab if it is constructed poorly or inadequate materials are used. The pit can also be emptied but this is often connected with costs and also risks if there is no possibility for further treatment. Normally, there are flies and odours. In many households pit latrines are not replaced or emptied if they are filled up and therefore latrine coverage is decreasing. Another problem is pollution of water resources because of pit latrines, which are not built properly. Furthermore in areas afflicted by landslides and soil erosion as well as in wetlands pit latrines are not appropriate. In addition pit latrines are not

suited for rocky or compacted soils, because digging is too difficult (Brikké, Bredero, 2003: 105; Tilley et al., 2008: 53).

The **ventilated improved pit latrine**, shortly named VIP latrine, is very similar to the common pit latrine and an improvement of this type. The difference between a traditional pit latrine and this type of toilet is a vent pipe that is covered with a fly screen. The ventilation pipe reduces two problems, on the one hand bad odours and on the other hand insect proliferation. The reason is that “[w]ind blowing across the top of the vent pipe creates a flow of air which draws out odours from the pit. As a result, fresh air is drawn into the pit through the drop hole and the superstructure is kept free of smells.” (Brikké, Bredero, 2003: 108) The pipe plays also an important role in fly control. The latrine has to be suitably dark inside and due to the fact that flies are attracted by light, they fly up the ventilation pipe and die of dehydration because of the fly screen. Female flies, which are searching for an egg-laying site, are attracted by the odour from the pipe and are prevented from entering the pipe because of the fly screen (Brikké, Bredero, 2003: 108).

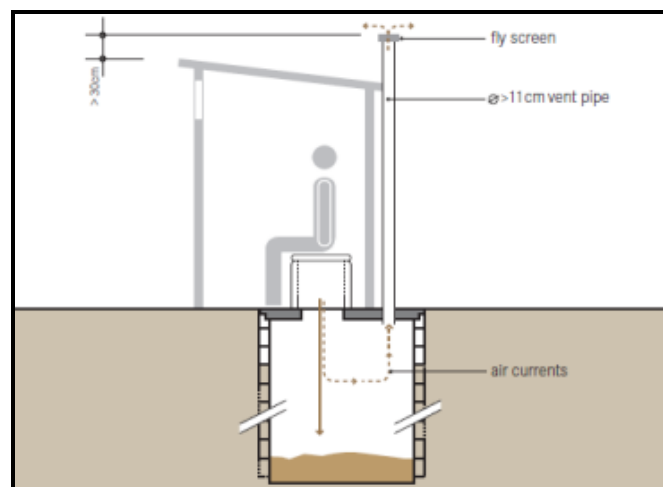

Figure 5.4 Ventilated Improved Pit Latrine (Tilley et al., 2008: 55)

Operation and maintenance of a VIP latrine is quite simple and similar to the traditional pit latrine. Differences are that the VIP latrine should be dark inside and therefore the door has to be closed. A further difference is that for VIP latrines the drop hole should never be covered because this would impede the air flow. As with the common pit latrine the superstructure as

well as the slab should be checked for damage. Here also the ventilation pipe and the fly screen have to be checked and repaired if necessary (Brikké, Bredero, 2003: 109).

Advantages here are that operation and maintenance is simple as well as smells being reduced through the ventilation pipe. Construction costs are relatively low. Furthermore the fly screen reduces the risk of transmitting diseases by flies (Brikké, Bredero, 2003: 108f).

Problems that can arise are with poorly constructed slabs which can break down. Furthermore “inferior quality fly screens are easily damaged by the effects of solar radiation and foul gases.” (Brikké, Bredero, 2003: 110) A further challenge can be that children are afraid of going inside the toilet because of the darkness. In addition the construction costs for this type of toilet are higher compared to a common pit latrine. As with the traditional pit latrine the pit can be emptied, but only manually because the content is too solid, or the superstructure can be reused for a new pit (Brikké, Bredero, 2003: 110; Tilley et al., 2008: 56).

Flush toilets are not very common in rural areas and also not in the south western region of Uganda. According to table 5.3, only 0.8 percent of toilet facilities in the western region and 0.3 percent in rural areas are flush toilets. This toilet system can look like the one depicted in figure 5.5, a pour flush toilet where water is poured by the user, or like the one illustrated in figure 5.6, a cistern flush toilet. This type has a cistern which the water comes from. The function of both is the same and every cistern flush toilet can become a pour flush toilet if water supply is not continuous. This type of toilet, whatever design, has a water seal. For the pour flush mode both designs, pedestals and squatting pans, can be used. Both designs need a constant source of water. Approximately 2 to 3 litres are needed for the pour flush toilet, whereas the cistern flush toilet needs 3 to 20 litres (Tilley et al., 2008: 43ff).

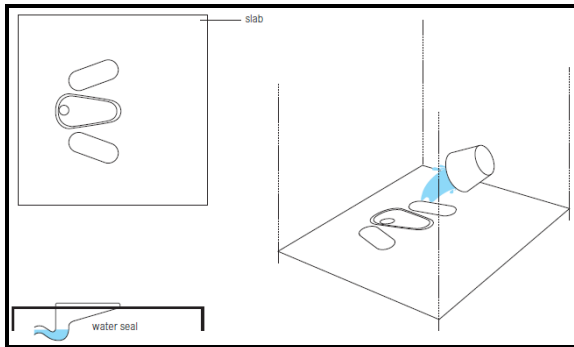

Figure 5.5 Pour Flush Toilet
(Tilley et al., 2008: 43)

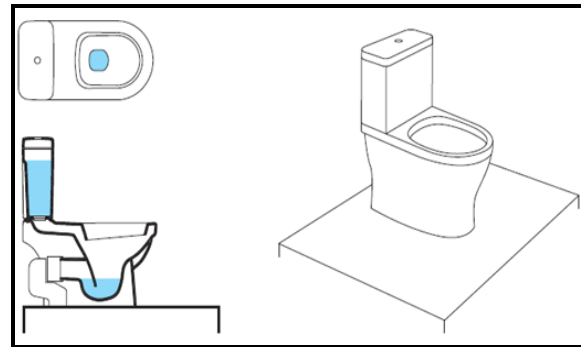

Figure 5.6 Cistern Flush Toilet
(Tilley et al., 2008: 45)

At figure 5.6 the user interface is a pedestal. This type of toilet is adequate for almost all climates and normally, operation and maintenance is simple. If there is little water used for flushing, dry cleaning materials should be collected separately to prevent the toilet from clogging. Both designs have to be cleaned regularly; importantly the bowl should be scrubbed. Both rarely require repair. This type of toilet is well accepted (Tilley et al., 2008: 43f).

Advantages are that users do not see or smell excreta of previous users because of the water seal. If it is kept clean, than it is a safe toilet with no odour which is suitable for almost all climates. It is appropriate for people using toilet paper as well as for people using water for washing (Tilley et al., 2008: 43ff).

Disadvantages are the need of a constant water source as well as the need of further treatment. That means a sewerage system, a septic tank or other kind of storage and treatment technology is required. But for instance septic tanks are not appropriate in areas afflicted by floods or areas with a high groundwater table (Tilley et al., 2008: 68). Compared to other systems a flush toilet has high construction costs and also operation costs are higher depending on the price for water. A septic tank has to be emptied every 1 to 5 years with a vacuum tanker or other emptying system which makes operation and maintenance costs higher. If liquid effluent disposal is inadequately considered many problems can arise (Brikké, Bredero, 2003: 118f; Tilley et al., 2008: 43ff). “[C]ontrol of the final sludge is essential. Uncontrolled, illegal emptying or dumping of sludge into the environment may

represent a significant risk to groundwater.” (Howard et al., 2006b: 612) A furthermore disadvantage is that the system requires skilled workers (Brikké, Bredero, 2003: 118).

Normally, in RGCs elected by the WSDF and the umbrella organisation (SWUWS), there are also public **EcoSan toilets** provided by these organisations. The term EcoSan – ecological sanitation – comprises toilet systems in which the use of water is reduced and nutrients are recycled so that artificial fertilisers are replaced. The toilet systems vary but the output is more or less the same for each kind of system. The output is compost, referred to as EcoHumus, which is the result of decomposing organic matter and is rich in nutrients. In Uganda the term EcoSan toilet refers to a Urine Diverting Dry Toilet (UDDT) with composting or dehydration vaults. UDDT refers to the user interface of a toilet system, but not to the storage and/or treatment. For the urine diversion toilet a pedestal or a squat slab can be used, like picture 2 illustrates. The EcoSan toilets constructed by the SWUWS are facilitated with a squatting pan. The chambers which are connected with the user interface are needed for collection, storage and composting. The complete system is often named EcoSan toilet but also other terms such as ‘double-vault compost latrine’ can be found in literature. Figure 5.7 shows a sketch of such a toilet consisting of a UDDT and composting vaults (Brikké, Bredero, 2003: 111; Tilley et al., 2008: 12ff).

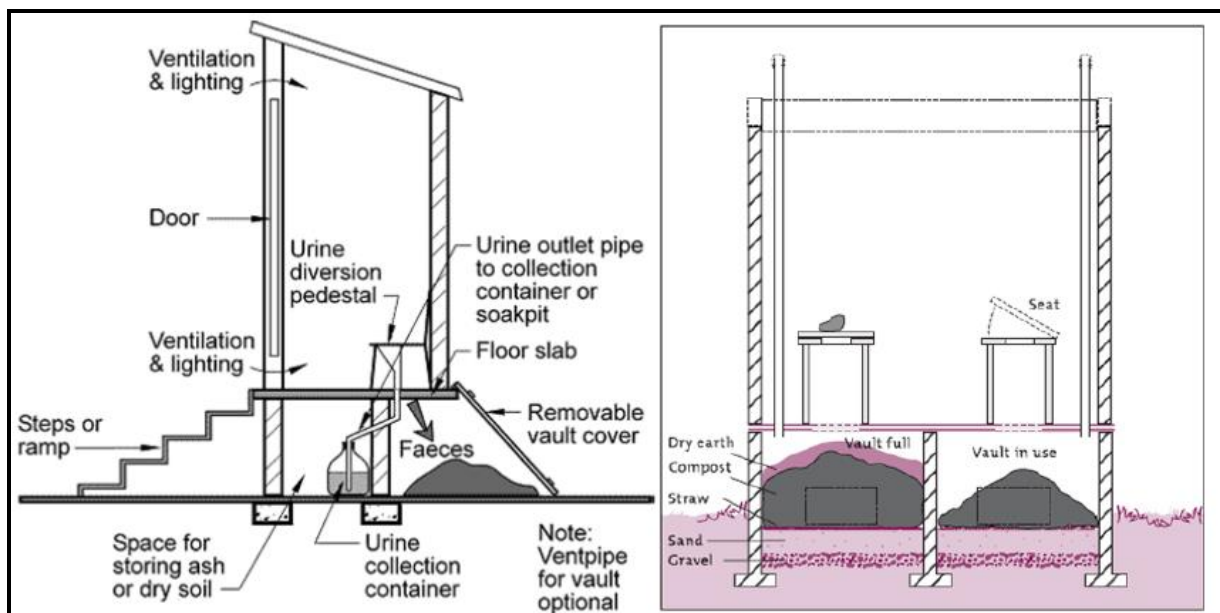

Figure 5.7 Urine Diversion Dry Toilet with composting vaults (Brikké, Bredero, 2003: 111; Fu, 2010: 11)

This system is a dry toilet that means it operates without water and with the urine diversion user interface urine and faeces are stored separately. This type of “toilet is built such that urine is collected and drained from the front area of the toilet, while faeces fall through a large chute (hole) in the back.” (Tilley et al., 2008: 39) It is very important that the two sections are well separated, faeces should not fall into the urine collection area and clog it and urine should not splash into the dry area. “Initially, a layer of absorbent organic material is put in the vault, and after each use the faeces are covered with ash (or sawdust, shredded leaves or vegetable matter) to reduce smells and soak up excessive moisture.” (Brikké, Bredero, 2003: 111) The organic matter is not only important to reduce smell and moisture but also to ensure that sufficient nitrogen is retained and as a result that it become a good fertilizer. The system works in the way that if the first one of the two chambers is three quarters full it is filled “with dry, powdered earth and sealed, and the contents allowed to decompose anaerobically.” (Brikké, Bredero, 2003: 111) Now the second vault is used until it is three quarters full and then the first one can be emptied and the content used as fertilizer. It is very important that the faeces become pathogen-free, meaning that the vaults must be big enough that they can be used for at least two years. To keep the aerobic system active a ventilation pipe is used as illustrated in figure 5.7 (Brikké, Bredero, 2003: 111; Tilley et al., 2008: 37ff). Operation and maintenance is more complex than for a pit latrine or a VIP latrine because after every use or whenever possible, wood ash or and organic material have to be added. When a vault is full it has to be levelled with a stick and the other vault emptied. Regularly the floor as well as the superstructure should be checked of any kind of damage (Brikké, Bredero, 2003: 111f).

Urine is collected in separate containers, in the RGCs these are most of the time jerry cans. Important is that it should be out of plastic, fibreglass or concrete. Metal materials should be avoided because due to the high pH of urine metal will easily corrode. Urine should be stored for at least one month but the longer the storage takes place the better for sanitization. In general the risk of transmitting diseases through urine is low, especially with an extended storage time. Due to the high pH of urine it should be diluted when it is used as fertilizer (Tilley et al., 2008: 51f). “Urine varies depending on diet, gender, climate and water intake among other facts, but roughly 80% of nitrogen, 60% of potassium and 55% of phosphorus that is excreted from the body is excreted through urine.” (Tilley et al., 2008: 129) If crops lack nitrogen urine is especially beneficial (Tilley et al., 2008: 129).



Picture 2 Pedestal and Squatting Pan Urine Diversion User Interface (Austin, 2006; Fu, 2010: 31)

Usually, one or two public EcoSan toilets are constructed at the water scheme office, where people have to pay a little fee for usage. In some RGCs 7 households were selected for receiving an EcoSan toilet each in order to introduce this type of sanitation facility. The public EcoSan toilet facilities are important for markets and market days. These toilets are in the area of responsibility of the scheme operator. However in one scheme there is an attendant who is responsible (e.g. I 3 Scheme Operator).

The biggest advantage of this type of toilet is that it is an ecological loop. Ecological sanitation “is an approach that seeks to protect public health, prevent pollution and at the same time return valuable nutrients and humus to the soil. This recycling of nutrients helps to ensure food security.” (WASTE, 2005) Further advantages of this type of toilet and its storage and treatment are that it is appropriate and suitable for almost every climate and also for every type of user, sitter or squatter. Flies and odours are normally no problem and it does not need a constant source of water (Tilley et al., 2008: 38ff) Through the use of urine artificial nitrogen fertilizer can be substituted.

If there are problems with soil erosion, landslides or wet areas, which some RGCs face, pit latrines are not appropriate, because pits can collapse or fill up with water. “Most people don’t

prefer EcoSan toilets unless there is a problem. So here it's soil erosion so they feel EcoSan is the best alternative." (I 6 Scheme Operators)

According to scheme operators pit latrines are preferred in contrast to EcoSan toilets especially for public toilets. "But, okay, at household level they are working but on public level it doesn't work." (I 3 Scheme Operators) One reason is that the use of the toilet is not self-explanatory and it is too complex and time-consuming explaining it to everybody. A further reason is that people are disgusted of seeing excreta of someone else and do not want to use ash or other desiccants. Nevertheless, some households in the RGCs built this type of toilet at their own expense with support from SWUWS. In general WSDF-SW and SWUWS are promoting EcoSan toilets because this technology is elaborated and appropriate especially for these areas.

In addition another disadvantage of EcoSan toilets are that it "is slightly more difficult to keep clean compared to other toilets because of both the lack of water and the need to separate the solid faeces and liquid urine." (Tilley et al., 2008: 39) Furthermore the use is not immediately obvious which results in the occurrence of mistakes. Awareness raising projects are inevitable also for achieving good acceptance. Further problems are their comparatively high investment costs. In return, problems with EcoSan toilets, e.g. collapse of pits or pollution of groundwater are not possible and their sustainability is much higher than the one of pit latrines. In addition people do not see excreta as a valuable resource nor do they consider using manure for agriculture or as economic commodity or a benefit. On the contrary, people are afraid that they lose social status in society when they handle with human manure. As a result people are not motivated to use human excreta as fertilizer which is also a problem (Brikké, Bredero, 2003: 111f).

Sanitary facilities include not only toilets but also hand-washing facilities. In the survey of the Uganda Bureau of Statistics all households with toilet facilities have been asked to indicate if they have also a hand-washing facility. Figure 5.8 presents the results of this question.

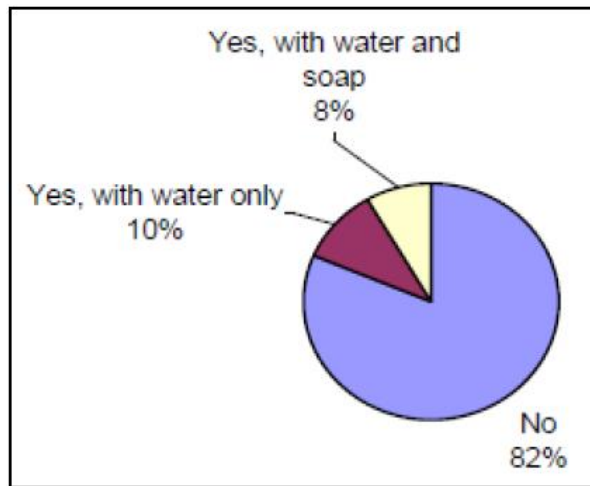

Figure 5.8 Distribution of Households with Hand-washing Facilities (Uganda Bureau of Statistics, 2010: 121)

According to these figure only 8 percent are practising safe hygiene after using a toilet. 82 percent do not have hand-washing facilities at all. These findings are consistent with the statements of health workers and my own observations. This fact is alarming because investigations of Burton et al. demonstrate that the existence of bacteria is substantially reduced by washing hands. An analysis after self-contamination revealed that without washing hands 44 percent bacteria are remaining, by washing hands with water 23 percent remain and by washing hands with soap 8 percent remain. That means the reduction of bacteria after contamination is further reduced by 36 percentage points if hands are washed with soap (Burton et al., 2011: 100) A more detailed analysis of the effect of hand-washing is provided in chapter 7.4.

5.2.2 Waste Management

Waste management is also a part of sanitation. In RGCs the solid waste comprises solid wastes from houses, streets and public places, shops, offices, and hospitals. In most of the RGCs it is a big challenge, especially for those directly on the main road. A reason is that many people buy things when they are passing through and at these places waste accumulates. Most of the time there is no person in charge and government (at this level it is the sub-county) does not take responsibility. Therefore people have different strategies to handle household waste. Often they put garbage to compost pits, rubbish pits or burn it on

plantations. It is important to say that according to scheme operators a big part of solid waste is organic waste and therefore biodegradable. This part is usually composted (e.g. I 5 Scheme Operator). A not inconsiderable part of the waste is not collected and “is dumped indiscriminately in the streets and in drains, so contributing to flooding, breeding of insect and rodent vectors and the spread of diseases.” (Zurbrügg, 2002: 1) The problem is not only uncollected waste, also collected waste, often put into uncontrolled dumpsites and/or burnt, which can pollute water resources and air (Zurbrügg, 2002: 1).

In five of the analysed RGCs there is no waste management and people are managing it for themselves. In only one (Rubaare) is there a waste management service and the centre, which is quite big, is separated into two different zones. Each zone has a zone leader who collects a fee of 1,000 UGX per collection of rubbish. This rubbish is put on a trolley and is brought to a central place. Here also the health inspector is the one responsible and can, as with latrine defaulters, imprison people for not paying the collection fee. This RGC also has an incinerator, but unfortunately it has never been finished (e.g. I 3 Scheme Operator).

5.3 Health Issue

It is already well known that sanitation and hygiene measures have a direct impact on health, especially the prevention of diarrhoeal diseases, which is probably the most significant impact (Water Supply & Sanitation Collaborative Council, World Health Organization, 2005: 1). This is the reason why the Ministry of Health is one of the lead ministries in the implementation of good sanitation and hygiene practices. According to the Memorandum of Understanding, the Ministry of Health is responsible for household hygiene and sanitation at all levels (Ministry of Water and Environment, 2009b: 11). That means that the health inspectors as well as the health workers play an important role for sanitation and hygiene.

Due to the fact that there are many different levels in the health service in Uganda, Table 5.4 briefly presents the hierarchical structure of health centres and the specific levels.

Table 5.4 Health Care System and Administrative Structure (Health Action International et al., 2002)

Administrative Structure		Corresponding Health
Description	Local Council Level	Structure
Village	I	Health Centre I
Parish	II	Health Centre II
Sub-County	III	Health Centre III
County as sub-district or constituency	IV	Health Centre IV
District	V	District/General Hospital

In the RGCs there are small health centres where people can go to get treatment and medication. However the health centres, which are within the RGCs, are very small and equipped with a nurse. In some cases I visited the health centre at the sub-county which is named Health Centre III, because it is sub-county level. This health centre was more like a hospital with a doctor and better equipment.

5.3.1 Health Worker

Very important for the promotion of sanitation and hygiene in RGCs are the health inspector and health workers. They are sensitizing and mobilizing people to push the issue forward. The position of a health inspector has much power and different possibilities to handle inhabitants without proper sanitation facilities. Possibilities range from admonishing to arresting people. When they arrest people they make an agreement about when the toilet has to be finished and afterwards the health inspector goes there to check it. Therefore the situation in the different RGCs depends also on the health inspector and whether he or she is very strict or not and also if he or she can motivate people. It is supposed that at sub-county level there is one health inspector and a health assistant (I 6 Health Workers).

One visited Health Centre III is working with village health teams (VHT). “The VHT Strategy represents the commitment of Government of Uganda to promote Primary Health Care in the communities in line with the 1978 WHO Alma Ata Declaration.” (Ministry of Health, 2011: 62) The declaration of Alma-Ata on Primary Health Care declared that primary health care

should be accessible for everybody especially for those most in need, “relies, at local and referral levels, on health workers, including physicians, nurses, midwives, auxiliaries and community workers as applicable.” (World Health Organization, 1978: 2) The health workers should be socially and technically suitably trained to respond to the expressed health needs of the community (World Health Organization, 1978: 2). These teams are local people who are volunteering and carry out a range of disease prevention and health promotion activities to help their communities. Since 2010/2011 this village health team structure is fully implemented in 69 of 112 districts, which corresponded to 62 percent in the year 2010/2011. According to a health worker the number of village health team workers depends on the number of households and one team member is responsible for 20 households. These volunteers are supported by the health assistant and participate in workshops at the sub-county. The VHTs assess the sanitation and hygiene situation and hand over a report to the sub-county. This report is then submitted to the district by the health assistant. Very often, however, village health team members neglect to submit these reports. Very often they complain that they do not have writing materials and no office where they can work. The biggest problem here is financial shortcomings which results in insufficient facilitation and hinders implementation (I 5 Health Workers; Ministry of Health, 2011: 63).

5.3.2 Health Education

The link between hygiene and health is already well known. As a result the importance of washing hands at key junctures is receiving more attention in Uganda. “Hands to be proud of” is a national hand-washing campaign hosted at Africare and supported by the Government of Uganda. After a pilot phase in 2007 to 2008 an implementation took place in 2010 in 30 districts. The district of Kabale was one of the five focus districts for pilot phase and in the district of Ntungamo the campaign was implemented. The focal point officer of this National Hand Washing Campaign was the district health inspector who carried out monitoring and supervision. Immediate supervisors have been “Health Assistants and Inspectors at the county and sub county level.” (Africare, n. d.)

Due to the fact that medical doctors do not have the time to go out to households or schools for teaching, health assistants are the persons in charge of this task. Physicians also train

people, but just at the health centres when people come for treatment. Here the problem is that this education is at a time when people are already sick. Beside health assistants and doctors also village health teams are very important actors, who play a big part in health education and awareness building. Furthermore health assistants who go out to immunize pupils, especially pupils at primary schools, are also educating them in good hygiene behaviour. Immunization is given inter alia against Hepatitis A and B, Whooping-cough, Diphtheria, Tetanus, Polio and Measles (e.g. I 1 Health Workers).

5.3.3 Health Problems

As mentioned in the sub-chapter Socio-political Characteristics, malaria is the most frequent disease in Uganda and according to reports from health workers also in RGCs. A big problem here is that people cannot afford to buy mosquito nets, which would be a good prevention (e.g. I 2 Health Workers). However not only is malaria a problem but there are also diarrhoea cases, skin infections, eye infections, respiratory infections and intestinal worms, but in a normal range, which are also linked with poor hygiene. A greater problem with diarrhoea is found in Kagarama the scheme where there has been no water for four months and people are using unsafe water sources. The health centres struggle with the problems that there are too few health staff, too little medical products and too many patients (e.g. I 1 Health Workers).

According to health workers the problem is also, as with sanitation, not lack of knowledge but unwillingness to change behaviour and therefore people do not prioritize the building of latrines or hand-washing facilities. One health worker stated:

Yes, I think there is poor hygiene among the people in the community. Because some of them don't even have a latrines in their homes, they use the bushes. Some don't have hand-washing facilities in their homes so they don't wash hands before eating and some don't even boil water, so they drink unboiled water." (I 3 Health Workers)

The problem is that people do not see the benefits of behaviour change because they are not sick nor do they link health problems with poor hygiene. It is often mentioned by health workers that if you go there and tell them that they should change behaviour, they will tell you that their relatives, e.g. father or grandfather, did the same without getting sick (I 1 Institutions). So they see no reason for changing their behaviour. "There are some things they

grew up doing which are very difficult to change” (I 1 Institutions) Apart from that, sometimes, there is just not enough water in the homes for hygiene. According to health workers, most of the time personal hygiene is poor (e.g. I 6 Health Workers).

Village health teams are a very efficient structure for health education but due to the big problem of financing they are not implemented in each district and are equipped poorly. These teams brought improvement but “sometimes of course when the supervision is not much because of the shortage of resources of course the implementation of such activities becomes a problem.” (I 6 Health Workers) For example people relax in practising hand-washing if they are not visited and supervised.

One of the biggest problems is facilitation and staffing also at sub-county level. As a result the health assistant sometimes cannot go out to teach people because there is no motorcycle or fuel as a result of too little money. Furthermore there is just one assistant and the sub-county is too big to reach everyone. A suggested solution given by a doctor at LC III was one health assistant per parish. In this specific sub-county there was one for five parishes that means one for 33,000 people.

“We, the health workers, we are supposed to teach them. But unfortunately now we are somehow understaffed, we are few of us. Sometimes you find we are just two to three, like we are now only five at this health centre. So if you have been called for a workshop you find the health docs may not go.” (I 5 Health Workers)

At these health centres there are very few doctors and they have too many other tasks and therefore they do not have the possibility to go out for teaching. For that reason health assistants are supposed to do those jobs instead of doctors. However they face the problem of not having transportation and one health assistant stated that this is the main problem “otherwise I would go every day.” (I 6 Health Workers) In a nutshell, due to lack of money there is a shortage in manpower or staffing as well as in facilitation and transportation and all levels are affected to varying degrees.

5.4 Responsibilities in Sanitation and Hygiene

In general the responsibilities for sanitation and hygiene activities are, like at the national level and also at this level, clarified through the Memorandum of Understanding. The responsibility of scheme operators for sanitation in rural growth centres consists of management of public toilets like the EcoSan toilets at the offices. Also the cleanliness of the offices and source areas as well as the area around public water kiosks is in the area of responsibility of the scheme operator. The sanitation coverage has to be 100 percent and if sanitation is getting very poor in a specific area a scheme operator can close a public water kiosk in agreement with the water board (I 6 Scheme Operator). The scheme operator is also the one who puts information sheets on how to use them at public EcoSan toilets. Some scheme operators also sensitize people, mainly people with private connections, towards sanitation and hygiene issues. “So me the sanitation I carry out just lays in form of the water users, to use clean containers. Then I go on and inform those people who have EcoSan dry toilets, the way they should use them such as they can maintain them clean.” (I 5 Scheme Operators) Except for these activities, the sanitation and hygiene issue is a task of the sub-county. “Now we divided this, we divided the responsibilities, we have health inspectors around. So they are the people who make the budget, from the sub-county treasure they come around they organize people, for example we have sanitation weeks, [...] they are the people who fund those activities.” (I 3 Scheme Operators) The counterpart of the district water officer is the district health officer who is in charge of sanitation and hygiene.

Health inspectors and health workers are very important. Depending on the individual person they can really push the issue forward and sensitize and mobilize people.

5.5 Communication and Cooperation

The water board or the scheme operator does not communicate much with the community. Decisions about the scheme and water supply are their task in cooperation with the sub-county. Water users or the community are included in the decision making process through three water users who are board members. When it is necessary they use opinion leaders to legitimatise decisions. They talk with the inhabitants about sanitation, especially giving advice about EcoSan toilets. However, this task is also mainly the work of health workers

(e.g. I 3 Scheme Operators). Health workers of course communicate much more with the community. But due to understaffing and poor facilitation there is not much time for them to go out in the community and teach people about safe sanitation and hygiene behaviour. The link between the scheme, which means the scheme operator and the water board, and the health worker is the sub-county chief. He or she is a water board member and also the head of the health workers. In some RGCs the communication with health workers or the health inspector is better than in others. Sometimes they design programmes together for waste management or to motivate people to practise safe hygiene and sanitation. There are also RGCs where the scheme operator and the health worker do not really cooperate. Here the problem is sometimes an allowance, because if the scheme operator wants the health worker to come to a meeting in some places, he also has to pay him or her an allowance (I 5 Health Workers and e.g. I 4 Scheme Operators).

6. Water Safety Plan Framework

In order to provide overall control of microbial and chemical quality of drinking-water, management plans should be developed and implemented which build the basis for system protection and process control to ensure safe drinking-water. These management plans for water are named Water Safety Plans (WSPs) (World Health Organization, 2011b: 22).

The Water Safety Plan framework is deemed to be “a comprehensive risk assessment and risk management approach that encompasses all steps in water supply from catchment to consumer” (World Health Organization, 2011b: 45) to provide safe drinking water. It is a systematic and integrated management approach that aims at identifying and prioritizing potential threats to water quality and has been developed by the World Health Organization (WHO). The approach of WSPs encompasses the whole system of the water supply and can be seen as an evolution of sanitary surveys and vulnerability assessments.

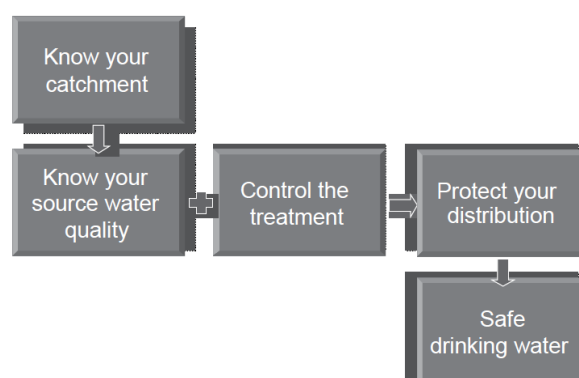

Figure 6.1 “Catchment to Consumer”-Approach to Risk Management in Drinking-Water Supply (Medema et al., 2003: 22)

The principles of hazard analysis and critical control points, the multiple-barrier principle and other systematic management approaches build the basis of a WSP (World Health Organization, 2011b: 22).

The overall goal of WSPs is to ensure safe drinking water, which is guaranteed through three key components: system assessment, effective operational monitoring and management.

These components are guided by health-based targets. Primary objectives are consequentially “the prevention or minimization of contamination of source water, the reduction or removal of contamination through treatment processes and the prevention of contamination during storage, distribution and handling of drinking-water.” (World Health Organization, 2011b: 46) Irrespective of size or complexity the aforementioned objectives are applicable to and appropriate for all water supply chains but vary in complexity, which is a great advantage of this approach. Furthermore, there is not only one way of implementing the WSP approach. Ideally, for each individual water supply system a WSP should be developed. Due to the fact that it may be quite challenging for very small supplies, a generic or model Water Safety Plan for small supply chains which are similar in nature can be used. It should be developed “by a statutory body or accredited third-party organization” (World Health Organization, 2011b: 46) These generic or model WSPs should be linked with guidance on application to individual systems and could be based on similar technologies. Apart from an existing good water supply management practices, hazard identification, risk assessment and management form an integral part of WSPs (Bartram et al., 2009: 1; Centers for Diseases Control and Prevention, 2011; Drinking Water Inspectorate, 2005: 2).

It is important to mention that financial support as well as encouragement of senior management is needed for an implementation of a WSP in the utility. Financial and resource requirements will be necessary and have to be addressed at the beginning of the project. At the same time it should be considered that a proper implementation of such a plan can save money and resources in the long term (Bartram et al., 2009: 1f).

In the development of a WSP different steps need to be implemented one after another. The different steps are illustrated in Figure 6.1. The figure includes and adapts the Hazard Analysis and Critical Control Points approach which was originally developed for food and adapted for Water Supply. The approach is described in more detail in chapter 6.1. As depicted in Figure 6.1, the initial step in developing a WSP is to assemble a team to prepare the WSP. The reason for this step is the fact that one person alone cannot understand and manage such a complex system and therefore a “team of individuals needs to be identified that will have the collective responsibility for identifying risks and barriers from contamination source to the point of exposure.” (Deere et al., 2001: 267) The team should be

multidisciplinary and should have a thorough understanding of the drinking-water system. The leader of the team should be the supplier. “Teams could include engineers, catchment and water managers, water quality specialists, environmental or public health or hygiene professionals, operational staff and representatives of consumers or from the community.” (World Health Organization, 2011b: 49) The first step in system assessment is the detailed documentation and description of the system. Then the following steps of operational monitoring, verification and management, documentation and communication can start.

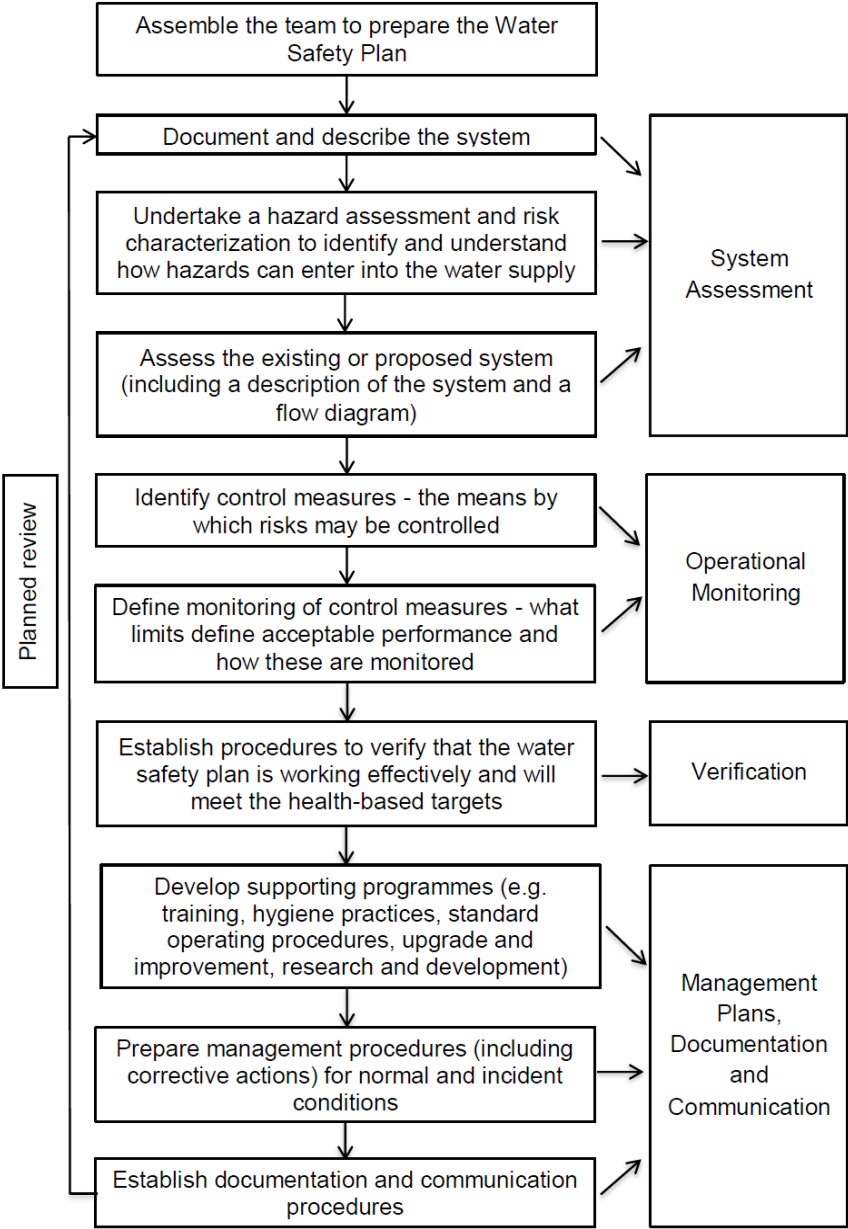

Figure 6.2 Overview of the Steps in Developing a Water Safety Plan (adapted from World Health Organization, 2011b: 48)

The key player in implementation and realization of a WSP is the water supplier, but also other stakeholders have important and significant roles. That means if there is a defined entity responsible for the drinking-water supply it should also be responsible for the preparation and implementation of the WSP (Drinking Water Inspectorate, 2005: 2). “This plan should normally be reviewed and agreed upon with the authority responsible for protection of public health to ensure that it will deliver water of a quality consistent with the defined targets”. (World Health Organization, 2011b: 47) It will hardly be possible to fully establish a WSP at once, but the first steps of development and implementation, which are mapping of the system, identification of hazards and assessment of risks should be possible. Thereby a framework will be developed which helps to prioritize actions as well as identify the requirements for continuing improvement (World Health Organization, 2011b: 49).

6.1 Hazard Analysis and Critical Control Points

The Water Safety Plan framework works with the principles and steps of the Hazard Analysis and Critical Control Points approach, shortly named HACCP, which is a preventive risk management system. It has been developed to provide food safety but it has turned out that the HACCP is also an acceptable and appropriate framework for water supplies and for guiding the process of risk management in that. The HACCP was developed “in the 1970s as a universal, scientifically based framework to assure safe food production.” (Havelaar, 1994: 145) The focus and basis of this approach is on controlling hazards as close to their source as possible (Deere et al., 2001: 257ff). The HACCP approach comprises a sequence of five initial steps and seven further steps which are the principles of HACCP. These steps are more or less the same as illustrated in Figure 6.1 but the ones of the figure are in an adapted form for drinking-water supply. If possible an assessment of risk from each hazard should be made and based on this assessment, prioritization of potential risk can take place (Deere et al., 2001: 267ff).

6.2 Multiple Barrier Approach

Not only is it important to consider the absence or presence of a risk, but also the magnitude of its effects and the probabilities of its occurrence. Consequently, the aim of risk

management is to think about and take into account mitigating factors – barriers to risk. “The objective is to reduce the risk to an acceptable level and/or to minimise risk by optimising the risk reduction throughout the system and by optimising the available barriers.” (Deere et al., 2001: 263) There are two levels where the use of multiple barriers works. Firstly, in most cases the barriers reduce the risk rather than completely eliminating it. Due to the fact that events are linked, multiple levels of protection are provided by multiple barriers that act together. The reduction of total risk achieved thereby is more than by any one barrier. Secondly, if a barrier is working ineffectively a reduction of risk is maintained through the presence of other barriers throughout the failure (Deere et al., 2001: 262f).

These approaches – HACCP and Multiple Barriers, are included in the WSP and affect the key components.

6.3 System Assessment

System assessment is the first of the three key components of a safety plan and determines if a drinking-water supply chain has the conditions to deliver water of a quality which meets health-based targets. A very important step is the assessment and evaluation of the water supply system. To enhance the assessment an accurate system description, which should include a flow diagram, should be performed. A systematic representation should be visualised including possible sources of contamination and transfer pathways of contamination to the end-user and possible barriers. The reason for doing this is that it is important that such a complex system is clear and well understood (Deere et al., 2001: 268; World Health Organization, 2011b: 46ff). The description of the system gives an overview, “including characterization of the source, identification of potential pollution sources in the catchment, measures for resource and source protection, treatment processes, storage and mechanisms for distribution” (World Health Organization, 2011b: 50) Due to the fact that only an accurate description of the system can ensure that no potential and significant hazard is overlooked, the system description should be validated. Besides the very detailed description of the drinking-water system, hazards and risks are identified in the system assessment, which is described in more detail in the following chapter (World Health Organization, 2011b: 50).

6.3.1 Risk Assessment and Risk Management

In order to implement effective risk management, hazards and risks need to be identified. For this reason it is important that the essential and different terms hazard, hazardous event and risk are defined for this context (World Health Organization, 2011b: 50). According to the “Guideline for drinking-water quality”:

“a **hazard** is a biological, chemical, physical or radiological agent that has the potential to cause harm; a **hazardous event** is an incident or situation that can lead to the presence of a hazard (what can happen and how); **risk** is the likelihood of identified hazards causing harm in exposed population in a specified time frame, including the magnitude of that harm and/or the consequences.” (World Health Organization, 2011b: 50)

The term risk can be defined in a broader way or more specifically, like the definition above. The term risk assessment describes “the process to evaluate whether there is a risk and, if so, how severe it is. Risk management incorporates understanding, evaluating and prioritizing risks for a given system and then implementing appropriate risk reduction strategies.” (Deere et al., 2001: 258) To ensure public health of consumers in drinking-water supply risk assessment as well as risk management are essential components (Deere et al., 2001: 258).

Classical risk assessment comprises four conceptual steps: hazard identification, exposure assessment, dose-response assessment and risk characterization. “Hazard identification is the identification of the constituents [...] [(i.e. for drinking water or wastewater reuse)] or whatever that may have the potential to cause harm to the user.” (Deere et al., 2001: 258) The source of hazard, the entry point, as well as the events that result from the contamination needs to be considered and identified for each step in the water supply chain (Drinking Water Inspectorate, 2005: 4). Exposure assessment includes identification of entry points, determination of people exposed to the hazard and the exposure route as well as the concentration. Furthermore, the quantity and the period of time of exposure to a specific hazard need to be assessed. Dose-response assessment determines the impact for the population of a hazard. The fourth conceptual step in risk assessment is risk characterization, which “is the consolidation of information from exposure assessment and dose-response assessment. Characterising risk is determining the likelihood of an adverse effect from exposure to the specific hazard.” (Deere et al., 2001: 259) Furthermore, the significance of a

risk is assessed as well as if it is acceptable, and actions to reduce or eliminate the risk are determined. This step is on the one hand time-consuming and on the other hand subject to uncertainty. The assessment should take into consideration and analyse all steps in the drinking-water system for real or potential hazards or hazardous events that could result in contamination or interruption of supply (Deere et al., 2001: 258f; World Health Organization, 2011b: 51).

Risk management includes “the control measures, monitoring and incident and emergency plans and the associated documentation for each stage in the water supply chain.” (Drinking Water Inspectorate, 2005: 2) For waterborne disease it also involves in its most simple form the identification of potential sources of contamination and the management of barriers to prevent end-users from contamination. Due to the fact that the understanding of the arrangement of waterborne contamination is very complex and the fact that barriers are rarely absolute barriers, simplistic approaches to risk management will be ineffective. Furthermore, because of complex arrangements and the requirement of multiple individuals and stakeholders to be involved in identifying contamination scenarios and managing barriers, a system to manage risk is necessary. In the WSP framework this is done with HACCP as well as with the multiple barrier approach (Deere et al., 2001: 266f).

The next step after hazard identification is the one of characterising risk and the results of this step are used in risk management. In order to do this the likelihood and the severity of hazards or hazardous events are taken into account. Because of this consideration hazards and hazardous events will be compared and prioritized. This prioritization is important for risk management because “not every hazard or hazardous event will require the same degree of attention.” (World Health Organization, 2011b: 51) Some risks can be simply ignored, which makes the whole risk management exercise easier. Others with significance to public health can be focused on as the first priority. Furthermore, the aim of risk prioritization is to distinguish between considerable and less considerable hazards or hazardous events. This can happen in different ways but typically involves a semi-quantitative matrix such as the one depicted in Table 6.1 (Deere et al., 2001: 267ff; World Health Organization, 2011b: 51).

Table 6.1 Example for a semi-quantitative risk matrix approach (adapted from Bartram et al., 2009: 32)

	Severity of Consequences Rating				
Likelihood Rating	Insignificant 1	Minor 2	Moderate 3	Major 4	Catastrophic 5
Almost certain 5	5	10	15	20	25
Likely 4	4	8	12	16	20
Moderate likely 3	3	6	9	12	15
Unlikely 2	2	4	6	8	10
Rare 1	1	2	3	4	5
Risk scoring Risk rating	< 6 Low	8-9 Medium	10-15 High	>15 Very High	

The preparation of such a matrix applies technical information from guidelines and scientific literature as well as practical experience and expertise. Furthermore, expert opinion regarding public health is important. Because definitions of likelihood and severity can vary, it is important to define these categories in order to rank risks consistently and usefully. Table 6.2 illustrates an example of possible likelihood and severity definitions (Drinking Water Inspectorate, 2005: 6; World Health Organization, 2011b: 51).

Table 6.2 Examples of definitions of likelihood and severity categories that can be used in risk scoring (adapted from World Health Organization, 2008: 55)

Item	Definition
<i>Likelihood categories and Rating</i>	
Almost certain – Rating 5	Once per day
Likely – Rating 4	Once per week
Moderately likely – Rating 3	Once per month
Unlikely – Rating 2	Once per year
Rare – Rating 1	Once every years
<i>Severity categories and Rating</i>	
Catastrophic – Rating 5	Potentially lethal to large population
Major – Rating 4	Potentially lethal to small population
Moderate – Rating 3	Potentially harmful to large population
Minor – Rating 2	Potentially harmful to small population
Insignificant – Rating 1	No impact or not detectable

Due to the fact that each drinking-water system is unique, the scoring is specific for each system. But “[w]here generic WSPs are developed for technologies used by small drinking-water systems, the scoring will be specific to the technology rather than the individual drinking-water system.” (World Health Organization, 2011b: 51) By using the risk matrix risks are ranked relative to their significance, and by following this ranking control measures can be prioritized (World Health Organization, 2011b: 51f)

6.3.2 Control Measures

After prioritizing risks control measures have to be put in place. What applies in this regard is that the level of control of a hazard depends on the associated risk. In general in this context “[c]ontrol measures are activities or processes within the drinking-water supply used to eliminate or significantly reduce the occurrence of a water safety hazard. These measures are applied collectively to ensure that drinking-water consistently meets health-based targets” (World Health Organization, 2011b: 52) Control measures are assessed and planned with the objective that thereby health-based targets will be met. Therefore hazard identification and risk assessment form the basis for assessing and planning control measures. The number and

identity of control measures is specific for each system and also related to the number and nature of hazards and hazardous events and the dimension of associated risks. Identification as well as implementation should be realized on the basis of the multiple barrier approach (World Health Organization, 2011b: 52ff). “The strength of this approach is that a failure of one barrier may be compensated by effective operation of the remaining barriers, thus minimizing the likelihood of contaminants passing through the entire system and being present in sufficient amounts to cause harm to consumers.” (World Health Organization, 2011b: 52) Some measures help to control more than one hazard while some hazards need more than one control measure for appropriate control (World Health Organization, 2011b: 52).

By assessing control measures important tasks are involved and thus existing control measures are identified from catchment to consumer for each important hazard or hazardous event. Furthermore, the assessments evaluates whether the control measures are effective and risks are reduced to an acceptable level. If this is not the case and improvement is required the assessment will bring information about alternative and additional control measures that could be put in place instead. Operational requirements on control measures are that they can be measured and monitored as well as corrective actions being put in place. Control measures are analysed and assessed in operational monitoring (World Health Organization, 2011b: 52).

6.4 Operational Monitoring

Operational monitoring is used to analyse whether control measures continue to work effectively and is a planned and routine set of activities. The objective of operational monitoring is to ensure an effective system management as well as that the health-based targets are achieved. It is in the area of responsibility of the water supplier who monitors all of the control measures in a timely manner. Operational monitoring can use parameters which are measured but also observational activities (World Health Organization, 2011b: 61f). “The parameters selected for operational monitoring should reflect the effectiveness of each control measure, provide a timely indication of performance, be readily measured and provide the opportunity for an appropriate response.” (World Health Organization, 2011b: 62) Examples of possible variables are inter alia turbidity, colour or ultraviolet absorbency for source water,

pH or disinfectant concentration for treatment and chlorine residuals, turbidity or the presence of heterotrophic bacteria for the distribution system. It is important that control measures have a defined limit for operational acceptability, which is termed the operational limit. All parameters should have a defined operational limit for each control measure (World Health Organization, 2011b: 62f). “If monitoring shows that an operational limit has been exceeded then predetermined corrective actions [...] need to be applied. The detection of the deviation and implementation of corrective action should be possible in a time frame adequate to maintain performance and water safety.” (World Health Organization, 2011b: 63)

6.5 Management Plans, Documentation and Communication

Effective management is a very important factor for providing safe water and implies definitions of actions which are realized in different operational conditions. That means actions necessary for normal operation are defined, as are situations which could be accompanied by loss of control and unforeseen (emergency) situations. These “[m]anagement procedures should be documented alongside system assessment, monitoring plans, supporting programmes and communication required to ensure safe operation of the system.” (World Health Organization, 2011b: 69) Management plans for incidents and emergency situations are very important because in incident situations “there is reason to suspect that water being supplied for drinking may be, or may become, unsafe.” (World Health Organization, 2011b: 69) An emergency situation may expand the possibilities and responsibilities of the water supplier and may require the resources of other organisations, especially the ones of public health authorities (World Health Organization, 2011b: 69).

The two situations require specific response or management plans. The one for incident situations typically comprises:

- “accountabilities and contact details for key personnel, often including several organizations and individuals;
- lists of measurable indicators and limit values/conditions that would trigger incidents, along with a scale of alert levels;
- clear description of the actions required in response to alerts;
- location and identity of the standard operation procedures and required equipment;
- location of backup equipment;

- relevant logistical and technical information;
- checklist and quick reference guides.” (World Health Organization, 2011b: 70)

To handle such incidents effectively and quickly staff should be trained periodically and standby rosters, effective communication systems, as well as documentation should be present. After an incident or emergency occurs, an investigation should be undertaken involving all concerned staff. This investigation should address the questions of “the cause of the problem; how the problem was first identified or recognized; the most essential actions required; any communication problems that arose [...]; the immediate and longer-term consequences [and] how well the emergency response plan functioned.” (World Health Organization, 2011b: 71) The reason for this is that the water supplier should learn as much as possible from this situation to be better prepared for the next incident or emergency. It can also be possible that such a situation requires an amendment of the WSP (World Health Organization, 2011b: 71).

Due to the fact that some scenarios might be unforeseen or considered too unlikely to be identified in the incident response plans, a general incident response plan should also be developed. For this task a lot of experience, judgment and skill are essential to make this plan a success (World Health Organization, 2011b: 71f).

In addition to the management plans, emergency plans should also be developed. In this context emergencies are natural disasters, accidents, but also damage. As for the incident response plan, these ones should include responsibilities for coordinating measures to be taken. But also “a communication plan to alert and inform users of the drinking-water supply and plans for providing and distributing emergency supplies of drinking-water.” (World Health Organization, 2011b: 72) Key agencies and authorities should also be involved in the development of these plans. Emergency response plans should include:

- “response actions, including increased monitoring;
- responsibilities of authorities internal and external to the organization;
- plans for emergency drinking-water supplies;
- communication protocols and strategies, including notification procedures (internal, regulatory body, media and public);
- mechanisms for increased public health surveillance.” (World Health Organization, 2011b: 72)

Also supporting programmes should be documented in a WSP; these are actions which do not directly affect the drinking-water quality but ensure the safety of the drinking-water supply. This could be for example training or educational programmes for staff involved in the drinking-water supply or codes of good management practice and hygienic working practice. Usually these actions belong almost entirely to the everyday work of water suppliers and normal operation (World Health Organization, 2011b: 73)

A crucial part of the Water Safety Plan is that all the points outlined above are documented. Documentation should include all steps of the WSP. These are the description and assessment of the whole water supply system, including also programmes for existing supply systems for an improvement or upgrade. “The plan for operational monitoring and verification of the drinking-water system [...]; water safety management procedures for normal operation, incidents (specific and general) and emergency situations [...], including communication plans; and description of supporting programmes [...]” (World Health Organization, 2011b: 75)

Besides documentation, communication is also an integral part. Strategies for communication should be in place and should include “procedures for promptly advising of any significant incidents within the drinking-water supply, including notification of the public health authority.” (World Health Organization, 2011b: 76) Furthermore information should be available for consumers, for example through annual reports, because it is a fundamental right of consumers to be able to access information (World Health Organization, 2011b: 76).

6.6 Verification and Surveillance

The final check whether safe drinking-water is being supplied to the consumer and whether the performance of the supply chain is safe is provided by verification. It is an additional action to operational monitoring and is used to reassure safe operation of the water supply system. This process is performed by the surveillance agency, but the water supplier should also realize internal verification programmes. It can also be done by combination of these two parties; this can be different from country to country and depends on the given administrative

regime (World Health Organization, 2011b: 64f). “It typically includes testing for faecal indicator organisms and hazardous chemicals, as well as auditing that WSPs are being implemented as intended and are working effectively.” (World Health Organization, 2011b: 65) The consideration of benefits and costs as well as of obtaining information should be reflected in the frequencies of sampling. Usually, sampling frequency is based on the number of people supplied or the volume of water delivered. Microbial contamination is more often the case than chemical contamination and therefore testing is required more frequently. Where testing should take place will depend on the specific water supply system and is individually determined (World Health Organization, 2011b: 65ff). It is important that plans are developed to respond if water quality targets are not met and “should include investigation of the cause of non-compliance and, where necessary, corrective action, such as boil water advisories. Repeated failure to meet targets should lead to review of the WSP and development of improvement plans.” (World Health Organization, 2011b: 65)

In verification the surveillance agency is a very important actor because, besides internal verification, external verification should also be performed. It is important that the surveillance authority has the competence and authorization to evaluate and determine if a water supplier is achieving its obligations. Agencies responsible for surveillance can differ from country to country, but mostly it is in the area of responsibility of “the ministry of health (or public health) and its regional or departmental offices. In some countries, it may be an environmental protection agency; in others, the environmental health departments of local government may have some responsibility.” (World Health Organization, 2011b: 9)

Surveillance has the aim of preventing problems and correcting faults, and is achieved through a systematic programme that consists “of surveys, which may include auditing, analysis, sanitary inspection and/or institutional and community aspects”. (World Health Organization, 2011b: 9) Sometimes surveillance agencies have to work with penalties to ensure safety and therefore needs to be supported by enforceable legislation. Despite these legal instruments the surveillance agency and the water supplier should develop a friendly and supportive relationship and penalties should be used as a last resort (World Health Organization, 2011b: 9).

6.7 The Kampala Water Safety Plan

Water Safety Plans are nothing new for Uganda and “Kampala was the first water supplier in Africa to develop a water safety plan, which was achieved with technical assistance from the Water, Engineering and Development Centre (WEDC) UK and funding from the Department for International Development (DFID) UK through their Knowledge and Research programme.” (Davison et al., 2005: 24) In 2002 the research work between WEDC and NWSC started and the WSP was implemented. In January 2004 the new system replaced the old one (Timbatemwa et al., 2004: 641). The implementation of the WSP was a co-operation between NWSC, WEDC and the Makerere University.

The system is a piped water supply system and the “entire network covers more than 871 kilometres of pipeline with over 40,000 household connections. Based on previous assessments of numbers of people served with household connections and of water source use by households without a household connection, it is estimated that the network serves 700,000 people.” (National Water and Sewerage Corporation, 2003: 2)

6.7.1 Challenges in Implementation and Lessons Learned

During implementation of the WSP difficulties were faced. For example the NWSC worked with private operators for the distribution network and the work was regulated through a contract. In this original contract WSPs were not included. Because of this it was difficult to get the private operator involved. The solution was an addendum to the original contract (Timbatemwa et al., 2004: 642)

Furthermore, staff movement was quite challenging. In the old system staff went out to do sampling but this did not occur as often in the new system. The availability of a vehicle was not always ensured and this lack proved to be a setback (Timbatemwa et al., 2004: 642).

In addition to administrative problems and equipment challenges, it was difficult for staff workers to change their work mentality and to feel comfortable in the new working system. “In the historical method, samples were taken for verification in the laboratory without much emphasis on the sanitary integrity of the system. In contrast the WSP involves sanitary

inspection in addition to field measurements.” (Timbatemwa et al., 2004: 642) Some had the feeling that now more is expected from them and therefore there was initial resistance (Timbatemwa et al., 2004: 642f).

A further problem was that the project was limited to three years and after this period only a few people followed up the approach. This problem is shown in the fact that almost no information is available of how the WSP works a few years later. According to NWSC data is there but availability is a problem. “So that’s an area where we need to improve to make sure that whatever development we do we review our documents we put the updates on the internet for the general public to know.” (I 7 Institutions)

The preparation and implementation of the WSP in Kampala shows that also for developing countries the approach of Water Safety Plans is appropriate. A thorough knowledge of the network was thereby developed, which causes a “more focused way of water quality monitoring and control as emphasis is placed on the most significant parts of the system.” (Timbatemwa et al., 2004: 643) But it is important that all staff members are working together and also the top management is involved. It is important to realize that quality control staff are not solely responsible for an effective risk assessment and risk management, but that operational staff are also required to perform these tasks successfully (Timbatemwa et al., 2004: 643).

According to the NWSC, prior to the new system the work and the staff had been separated into technical staff and quality control staff. Since the WSP has been implemented, these two groups are working closely together. This can be seen as an improvement and also that monitoring costs are reduced through the approach. The reasoning for this is “before you just look at population sizes and basically putting sampling points almost everywhere so you are able to cut back the sampling points to those ones which are critical” (I 6 Institutions)

6.7.2 Problems of Dissemination of the Approach

Although Uganda was the first African country to implement a WSP, only a few people are informed of this approach and its use in Kampala. The dissemination is not really working.

Right now only the National Water and Sewerage Corporation (NWSC) is implementing this approach. One of the experts involved in implementation explained that they did not continue after the project ended, which was limited to three years. “So the knowledge ended up getting to a small, a limited number of people, we didn’t won utility company and even spread beyond.” (I 12 Institutions) In addition he explained that sometimes there is only little communication between different agencies, which is a problem. After the interviews I can say that for me one of the reasons why only few people know about this approach is the separation of responsibilities:

“National Water is responsible for water supply in towns only in the bigger towns and the Ministry is dealing with the rural areas you know small towns, rural growth centres and all this. So sometimes they tend to discredit each other on the method of work. And so you will find there is not a strong interest for somebody in DWD to learn something that National Water is implementing unless they are directly involved. So in my view that is that’s what conclude that the project was first of all three years in duration and limited you know area of implementation. And then it dealt with some few people within the utility company. Even though I know that we organised some workshops but some few people come (laughing) others don’t come.” (I 12 Institutions)

We can also see that one problem is missing ownership. Very often projects are donor funded with a defined period of time and after this period, mostly 3 years, the project as well as funding is over and that is where it stops. The beneficiaries do not see the importance of and the improvements from the projects and therefore there is no interest in follow-up.

Also the information received from NWSC heads in this direction and points out that communication is a problem:

“So that in its self-created blocks that don’t talk to each other and nobody is really responsible for spear heading (laughing) Water Safety Plans cause NWSC will say it’s for us it’s for our towns and they will not take on the responsibility at national level. So I think what is missing is a national strategy and once that is done and sited in the right place than you will have this trickling down even to the lowest schemes, yea.” (I 6 Institutions)

However, it is worth emphasising that there are people in the country and in the Ministry of Water and Environment who know about WSP and are really trying to promote this model. There is one staff member of the ministry who is promoting this approach in the water policy

committee. “To raise their awareness and also get their support before the concept can be scaled up.” (I 5 Institutions) And these people are very important to prepare the way for a national strategy.

7. The WaSH Components

WaSH consists of the components water, sanitation and hygiene, and a lack of only one of them presents a severe threat to health. Nowadays it is well recognized that sanitation and hygiene play a bigger part in improving health, especially in preventing diarrheal diseases, than interventions in safe water supply alone (Esrey et al., 1991: 609). Due to this fact sanitation and hygiene have to become an integral part of safety plans.

Before this can be done the subjects of sanitation and hygiene are discussed more thorough to analyse what creates the risk. Regarding sanitation human excreta disposal is examined, and in the field of hygiene, hand hygiene is highlighted.

7.1 Sanitation

Appropriate and improved sanitation acts as a primary barrier and isolates human excreta from the environment. First ideas and a concept about sanitation safety plans were already made, strongly influenced by the WSP approach. As for water, in sanitation all steps in the chain have to be considered and a system and exposure assessment realized. An example of a sanitation chain is illustrated in Figure 7.1 (Barrenberg, Stenström, 2010: 2ff).

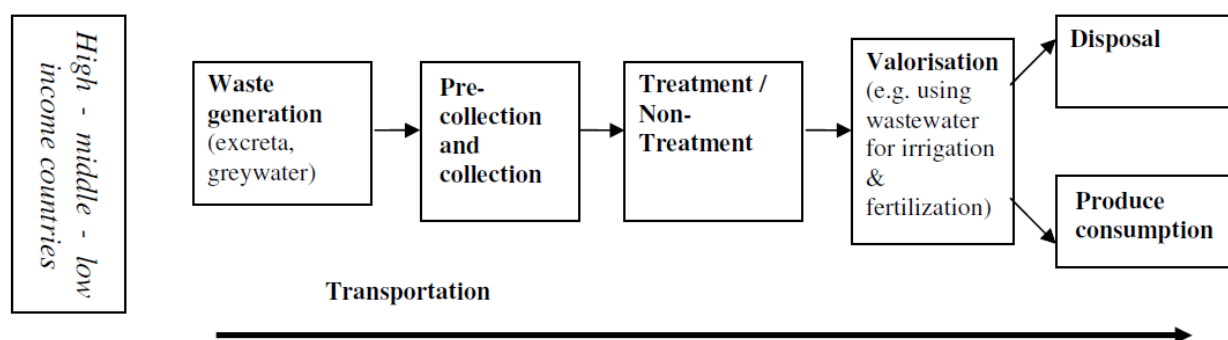

Figure 7.1 Points of Exposure in the Sanitation Chain (Barrenberg, Stenström, 2010: 6)

The sanitation chain has multiple points of exposure and “[f]or every element in the chain there may be several options, mainly determined by the given setting’s level of development.”

(Barrenberg, Stenström, 2010: 6) Table 7.1 provides examples of multiple exposure points for the different steps in the sanitation chain.

Table 7.1 Example of Exposure Points (adapted from Barrenberg, Stenström, 2010: 7)

Waste generation	<ul style="list-style-type: none"> - Dry latrines- improved/unimproved - Flush toilets - Ecological loop toilets
Transportation	<ul style="list-style-type: none"> - Manually - Motorized - Sewerage-System
Pre-collection and collection	<ul style="list-style-type: none"> - Buckets - Septic tanks - Pre-collection sites
Treatment/Non-treatment	<ul style="list-style-type: none"> - Waste stabilization ponds - Constructed wetlands - Sedimentation - Filtration - Coagulation/Flocculation - Disinfection - Pathogen-die-off
Valorisation	<ul style="list-style-type: none"> - Irrigation - Fertilization - Fodder for livestock production
Disposal	<ul style="list-style-type: none"> - Reintegration into aquatic cycle
Produce consumption	<ul style="list-style-type: none"> - Food trade - Food preparation - Food consumption

The actual components of a sanitation system vary and are very much dependent on the region and the social context. The sanitation situation in Uganda as well as in the western region of the country is characterized by pit latrines (85.5%/95.7%), followed by VIP latrines (3.7%/1.2%) and flush toilets (2.2%/0.8%). The percentage of people not having a toilet at all and using the bush or other alternatives is 8.7 percent for the whole country and 2.3 percent for the western region.

According to WHO and UNICEF sanitation facilities can be ranked in four categories. Open defecation, which refers to the unsafe disposal of human excreta in the environment; unimproved sanitation, where hygienic disposal of excreta cannot be ensured; shared sanitation facilities, where an acceptable type of toilet is used from more than one household;

and improved sanitation facilities which ensure “hygienic separation of human excreta from human contact.” (World Health Organization, United Nations International Children’s Emergency Fund, 2008: 6) The improved sanitation facilities category includes systems like flush or pour flush toilets connected to a piped sewer system, a septic tank or a pit latrine; VIP latrines, pit latrines with a slab and composting toilets. Public Toilets are defined as shared toilets and do not belong to improved sanitation systems (World Health Organization, United Nations International Children’s Emergency Fund, 2008: 6). The reason for this is that many of shared facilities “fail to ensure hygienic separation of human excreta from human contact. Serious concern has also been expressed about the actual accessibility of such facilities throughout the day and about the security of user, especially at night.” (World Health Organization, United Nations International Children’s Emergency Fund, 2008: 14)

Sanitation systems have already been explained in chapter 5.2.1 and will not be explained in more detail but the effect of sanitation on health is analysed in the following chapter.

7.2 The Effect of Sanitation Systems on Hygiene

Due to already mentioned transmission routes human excreta has an impact on our health and different sanitation systems have a different effect on the environment and consequently on the population. Transmission can take place through different pathways including via carriers, which means infection and excretion happen without clinical symptoms. “A large range of pathogenic organisms of viral, bacterial, parasitic protozoan and helminths origins may be present in faeces. Few are excreted with urine.” (Stenström et al., 2011: 2) Due to the fact that all infectious organisms are normally contained in faeces, anal cleansing and ablution water can also be contaminated. The main risk of urine and greywater is related to faecal cross-contamination and only a few pathogens are excreted through urine. Most of the time infections take place through accidental contact with contaminated areas transmitted in minute quantities to the mouth (Stenström et al., 2011: 2f). Some infections occur through contact with skin, such as hookworm and schistosomiasis “or through inhalation of contaminated aerosols or particulate material” (Stenström et al., 2011: 3) Depending on the sanitation systems also groundwater can be polluted through “faecal material leaching into the sub-surface contains pathogens excreted by infected individuals.” (Howard et al., 2006a: 277)

Badly planned or constructed as well as poorly managed or maintained sanitation systems facilitate transmission pathways of faecal-oral diseases (Water Supply & Sanitation Collaborative Council, World Health Organization, 2005: 10). Prüss et al. analysed faecal-oral transmission routes for specific sanitation systems and divided into dry sanitation with reuse, e.g. EcoSan toilets but also pit latrines with a reuse of pits, waterborne sewerage and non-recycling latrines and included the transmission routes in the F-Diagram as depicted in Figure 7.2.

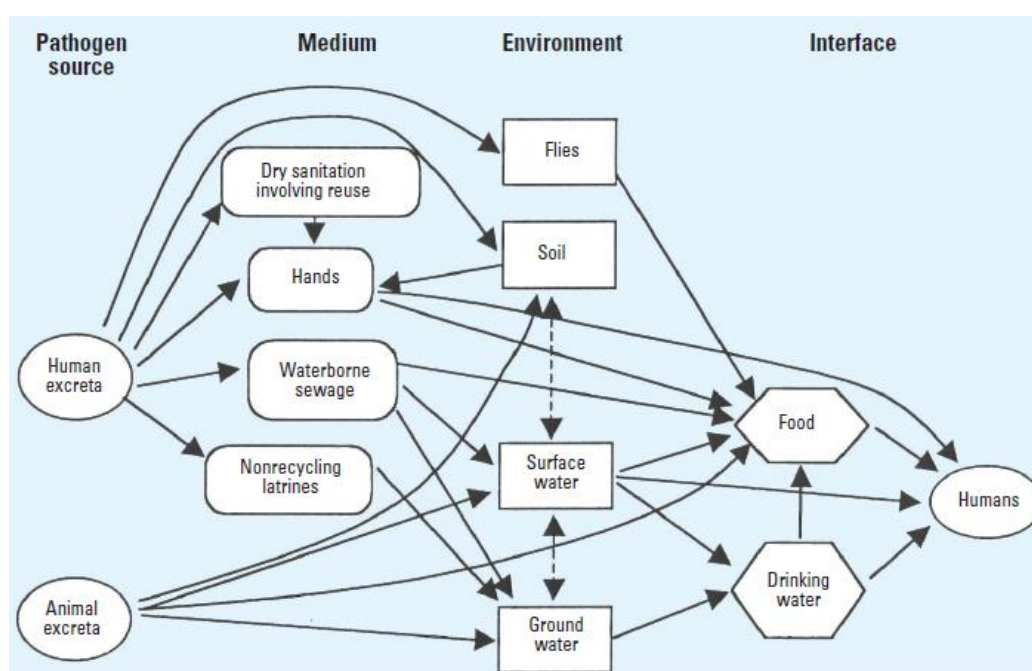

Figure 7.2 Transmission pathways due to poorly managed sanitation (Prüss et al., 2002: 538)

Keeping in mind the sanitation chain, there are different points where an exposure may occur. The access for users to a sanitation system is provided through the user interface technology, which is the first point where exposure may happen, followed by collection, storage/treatment and conveyance (Stenström et al., 2011: 13ff).

In my thesis not all sanitation systems and their impact are analysed, mainly those which are very common in the western part of Uganda and in the visited rural growth centres. As a result improved on-site sanitation and open defecation are highlighted but also the effect of

sewer technology is shortly described. This short insight is not exhausting and a more detailed view is especially given by Stenström et al. 2011. For groundwater pollution due to sanitation systems a more detailed analysis is given for example in ARGOSS 2001 or Howard et al. 2006.

7.2.1 On-site Sanitation

Traditional pit latrines consist of a dry toilet user interface which can be a pedestal or a squat pan. Exposure pathways are affected by individual habits, “due to contact by the user and soiling of surfaces by earlier users.” (Stenström et al., 2011: 14) Sitting on a pedestal does not by itself create a greater exposure to excreta than squatting but may lead to direct contact. Hot spots for transmitting disease are poorly kept pedestals or squatting pans, touching by hands and later contact with the mouth by contaminated hands or through soiled floors. If toilets are used barefoot also hookworm can be transmitted due to soiled areas. Cleaning becomes more difficult if toilet floors are rough and make it easier for faeces to remain which increases the likelihood of contamination. The superstructure of pit latrines can attract flies which can breed inside or act as a mechanical vector for transmitting diseases. Instable or improperly built toilet slabs can collapse or crack which exposes users to a greater health hazard. Further transmission to the home environment can happen through soiled feet or shoes. The health risk of traditional pit latrines depends on both individual behaviour and the cleanliness of the toilet. People cleaning and maintaining the facilities are at risk of infection but this risk is also related to the degree of contact and washing afterwards. The cleanliness of the facility as well as of the individual is a central mitigating factor. If toilets are dirty the level of risk is higher for users, when toilets are clean and hand-washing afterwards is practiced the level of risk is low.

The risk of flooding or collapsing of pits is more likely if pits are built in flood-prone or low-lying areas. Furthermore, the surroundings can be contaminated if pits overflow and the contents spread. Such incidents also threaten surface water (Stenström et al., 2011: 14ff). A high risk of groundwater contamination is also given by pit latrines, especially if the groundwater table is high. The liquid part in pit latrines is called hydraulic load and where these hydraulic loads exceeds the natural attenuation potential of the sub-surface groundwater

can be contaminated (ARGOSS, 2001: 19) Groundwater is mainly polluted with bacteria and viruses but there is also a risk of nitrate contamination which depends upon geo-hydrological conditions and seasonality. Pits can also become breeding places for vectors such as houseflies or organisms causing diarrhoeal diseases. (Stenström et al., 2011: 29)

VIP latrines are very similar to traditional pit latrines but an improvement. Due to the same user interface as traditional pit latrines people are exposed to similar risks, but flies and odour are reduced compared to traditional pit latrines, and due to better aeration, the reduction of pathogens is faster and better, if used correctly. Typical malfunctions as well as exposure pathways are the same as for pit latrines except for the fact that pathogen transmission by flies is significantly reduced through a fly screen. Periodical cleaning as well as proper maintenance of the vent pipe is a must (Stenström et al., 2011: 31f).

The user interface of **EcoSan toilets** used in Uganda is a urine diverting dry toilet and does not require water for flushing. Here also the same exposure pathways as for pit latrines or VIP latrines are given due to a similar user interface. For this type also “the likelihood of touching soiled toilets or other surfaces in the toilet room [is the same]. As with the dry toilet user-interface technology, users’ defecation habits dictate the risk of exposure for subsequent users.” (Stenström et al., 2011: 16) The risks from flies or other insects to transmit diseases are low, except for poorly maintained toilets which can also attract flies. Urine from this type of toilet can contaminate other areas through splashing. The represented risk to health is characterised by individual behaviour and cleanliness of the toilet. An important mitigation factor is the correct use of the toilet, which needs user education. Ash or lime has to be added after every use to make the material more alkaline and dry. The chambers or vaults connected to the user interface have to be used in an alternating fashion and no water, anal cleansing water or cleaning water should enter the toilet. Furthermore they have to be watertight so that pathogen survival is not prolonged. After 6-12 months a considerable reduction of bacteria and viruses is achieved and viable protozoa and helminths are totally reduced. The level of risk through bacterial pathogens, viruses and parasitic protozoa falls dramatically if a storage time of 1.5 to 2 years is met (Stenström et al., 2011: 16ff). In general, users are hardly put at risk and “[e]xposure to flies and other vectors is normally not of concern if the material is properly covered and the pit is vented.” (Stenström et al., 2011: 36) Contamination or

transmission of diseases can also happen during emptying, especially through spill over of material on the surrounding environment (Stenström et al., 2011: 56).

Pour flush toilets and **flush toilets** also need further collection and storage or treatment systems like a septic tank or a pit. For pour flush and flush toilets as for other toilet types, individual behaviour and cleanliness characterise the related health risks. An effective barrier for disease transmission through flies and mosquitos is the water-seal, but if water for pour flushing or anal cleansing is not covered then mosquito breeding places are enhanced. “If contaminated water like greywater is used for flushing its quality determines if there is an additional risk due to accidental contact and ingestion.” (Stenström et al., 2011: 18) Unclean toilets put subsequent users at risk which is increased further by using contaminated water or contaminated greywater for flushing. In flush toilets contamination can also occur through aerosols as well as by ingesting “pathogens by touching the seats, cistern handle and lid of the toilet bowl with [...] hands and transfer these to the mouth.” (Stenström et al., 2011: 20) If an adequate amount of water cannot be assured then faeces can accumulate in the bowl. Contamination of the surface can happen due to overflow from the toilet. In communal flush toilets subsequent users can be exposed because of users who squat on a pedestal because of fear of being infected. This practice may contaminate floor, seat and toilet lid. The risk of hookworm infection is the same as for other user interface technologies which may occur through poorly maintained or soiled squatting slabs. Risks can be mitigated through the use of rainwater instead of greywater and by regular cleaning of seat or slab with disinfectant (Stenström et al., 2011: 18ff).

Septic tanks consist of watertight chambers where blackwater and sometimes also greywater is stored and treated. “The settling of particles and anaerobic degradation that will occur reduce the solids and organics content, but only moderately affect the microbial reduction. [...] Regular desludging of the tank is critical for proper functioning.” (Stenström et al., 2011: 44) Septic tanks also can handle dry anal cleansing material and optimally 80 percent of suspended solids will undergo further degradation by anaerobic digestion. Temperature increases the rate of digestion; as 35 °C a maximum rate is reached. “Removal of pathogens varies and largely depends on the removal of suspended solids” (Stenström et al., 2011: 44) The liquid part is normally discharged into a soakaway pit. “In well-designed septic tanks, the

solid matter does not represent a significant hazard [to groundwater], but the soakaway pits may cause both microbiological and chemical contamination.” (ARGOSS, 2001: 19) Septic tanks have to be watertight and tank joints properly sealed so no leachate or groundwater can infiltrate. If the capacity is too small, treatment efficiency is reduced or blackwater flows out without settling or undergoing any treatment. In theory exposure is low and affects mainly the emptying process or technical factors such as failures because of overloading, poor construction or poor maintenance (Stenström et al., 2011: 45ff). Groundwater contamination and resulting disease outbreaks have been associated with septic tanks which may also serve as breeding places for mosquitos. A significant infection risk may result from accidental ingestion of influents or effluents. Burying septic tanks mitigates risks and there should be as little contact with the tank as possible, with contact occurring only during desludging (Stenström et al., 2011: 44ff).

Open defecation is not part of any sanitation system and different practices are covered by this term. Examples are the “flying latrine” where faeces are placed in a bag or paper and thrown away or the “cat latrine” where a shallow hole serves as latrine which is buried afterwards. The latter type is a safer practice but still referred to as open defecation. Mostly open defecation takes place in designated areas e.g. bushes/forest, river/stream shores, beaches and on non-economic waste lands. It “is the most significant environmental factor in the transmission of excreta related diseases [...] Various transmission and exposure pathways are associated with this.” (Stenström et al., 2011: 25) Transmission through direct contact or by contaminated drinking water sources, crops or soils is likely. The risk that drinking water is contaminated is more likely in rainy season. Furthermore open defecation areas serve as breeding sites for disease transmitting vectors. Depending on population density the degree of exposure varies. Open defecation puts humans on a high infection risk and should always be replaced through a more secure sanitation system. Children are of a higher risk than adults to get in contact with contaminated soils (Stenström et al., 2011: 24f). The risk of groundwater contamination depends on local conditions. In rural areas the highest risk of groundwater contamination is at the onset of the rains when the concentration of microbial contamination is often seen to be highest. During the remaining wet season and also in dry season the concentration of microbial contamination declines (Howard et al., 2006a: 281). “The build-up

of faecal matter that is readily washed into groundwater sources may provide a plausible explanation of this phenomenon.” (Howard et al., 2006a: 281)

7.2.2 Off-site Sanitation

Flush or pour flush toilets can be connected with a **sewer** which is considered to be an off-site technology. Because effects on health of flush and pour flush toilets have already been explained, I will only briefly describe the sewer technology. Here different technologies exist and I will focus on the conventional gravity sewer technology. This consists of “large networks of underground pipes that convey blackwater, greywater and stormwater from individual households to a centralized treatment facility using gravity (and pumps where necessary).” (Stenström et al., 2011: 62) Here no pre-treatment or storage is required. Usually sewer technology is maintained by specialized workers and proper management limits risks. Misusing the sewer for dumping waste and overflow in rainy season are big risks. Community members should not come into contact with the sewer system and therefore only rats and other vermin can be a secondary transmitter. Cross-contamination can occur via leaking sewer lines, contributing significant microbiological and nitrate loads. Leakages are more likely during floods or maintenance work. If sewers are deficient, health hazards for the population are higher compared to the health hazards of simple but clean latrines (ARGOSS, 2001: 28; Stenström et al., 2011: 62f). Regarding groundwater contamination “[o]n-site systems are point sources and therefore will be expected to exert the greatest impact in their vicinity, although where there are large numbers of on-site systems the overall impact may be widespread.” (Howard et al., 2006a: 280) Off-site sanitation systems “represent more diffuse pollution and risks to groundwater may be found along the sewer lines, at the treatment works and from the final effluent discharged to the environment.” (Howard et al., 2006a: 280)

7.3 Hygiene and Hygiene Promotion

A definition of hygiene is already given in the introduction of my thesis. As mentioned there, hygiene consists of several measures to break the chain of infection transmission. Measures are inter alia hand hygiene, personal hygiene, food hygiene and safe disposal of faeces, but very often hygiene is only associated with hand-washing. The reason for that may lie in the

fact that there is a “general consensus that hygiene promotion programmes are more likely to be successful in changing behaviour if they focus on a small number of activities at a time.” (Peal et al., 2010: 2) Furthermore many of diseases are transmitted by contaminated hands (e.g. diarrhoea, eye infection, helminth infection) which makes hand-washing a major issue.

Hygiene promotion is defined as “a planned approach to preventing diarrhoeal diseases through the widespread adoption of safe hygiene practices. It begins with, and is built on what local people know, do and want.” (United Nations International Children’s Emergency Fund, 1999: 10) The main risky hygiene practices as well as conditions are reduced through effective hygiene promotion (Appleton, Sijbesma, 2005: 5). Due to the fact that one of the most effective measures to improve health is hand-washing, the effect of this is highlighted in the following chapter.

7.4 The Effect of Hand-washing

Hand-washing is an important measure to interrupt several transmission routes as visible in the F-Diagram. Hand-washing can be considered as a measure which acts as a primary barrier, to remove faecal matter after contact with stools, and also as a secondary barrier procedure, before preparing food, handling fluids, feeding and eating (Curtis et al., 2000: 26). Especially after and before the aforementioned key points hand-washing is essential. It would not be reasonable to expect people to wash their hands with soap on every conceivable occasion, due to additional water use, time expenditure and costs for soap. Therefore “[h]ygiene promotion programmes thus have to make a choice as to when hand-washing is most needed for health protection” (Curtis et al., 2000: 26) An important factor for hand-washing is water quantity and “a convenient water supply makes hand-washing easier to practice and hence more likely.” (Cairncross, 2003: 677) Even more, the presence of enough water encourages people to practice better hygiene in general (Curtis et al., 2000: 27).

The effect of hand-washing with soap has been determined by Curtis and Cairncross on the risk of diarrhoeal diseases based on a systematic review analysis. The result shows that “[o]n current evidence, washing hands with soap can reduce the risk of diarrhoeal diseases by 42-47% and interventions to promote handwashing might save a million lives.” (Curtis,

Cairncross, 2003: 275) Furthermore, the risk of severe intestinal infections and of shigellosis is reduced through hand hygiene by about 48 percent and 59 percent respectively (Curtis, Cairncross, 2003: 275) The results of Burton et al.'s experiment held in 2009 "demonstrate that handwashing with non-antibacterial soap is much more effective in removing bacteria from hands (eight percent bacteria remaining) than handwashing with water only (23 percent bacteria remaining). [But also] [...] handwashing with water alone reduced the presence of bacteria on hands substantially [...]" (Burton et al., 2011: 102)

It is reasonable to suggest that hand-washing not only reduces diarrhoea cases but could also be a cost-effective intervention to prevent acute respiratory infections (ARIs). These two groups of diseases, diarrhoeal diseases and ARIs, are the most important causes of child mortality and the latter is also responsible for significant adult mortality (Cairncross, Valdmanis, 2006: 785f) This should be considered for the reason "that the pathogens which cause diarrhoea can also cause respiratory symptoms. [...] [And on the other] that both respiratory and enteric pathogens are often transmitted on surfaces and that the surface we most often use to inoculate ourselves with infection is the skin of our hands." (Cairncross, 2003: 678)

8. WaSH Safety Plan Approach

The fact that sanitation and hygiene has to be an integral part of a safety plan which aims at achieving health-based targets is obvious and well illustrated in the F-Diagram. This idea is not completely new and a WaSH Safety Plan including a trial was published in 2011 by Sanderson and McKenzie. Their context, however, was a different one. The trial of the WaSH Safety Plan approach was implemented in Nepal with a small community of 31 households and 175 inhabitants. Furthermore the trial was developed to deal with a decentralized water supply system without a water supplier (Sanderson, McKenzie, 2011: 8). The questions arising now are how this can be done and whether it would be appropriate in the context of the visited rural growth centres in Uganda.

If hygiene is not practiced the health objectives of the water and sanitation systems cannot or only partially be achieved. This is because if there is no appropriate hygiene behaviour then a primary and secondary barrier is missing. That means we have to consider water, sanitation and hygiene to achieve the overall objective of public health. On the other side these infrastructural systems are the basis for hygiene behaviour. Figure 8.1 illustrates the three components and all its individual steps in a broader sense with the objective to achieve health-based targets.

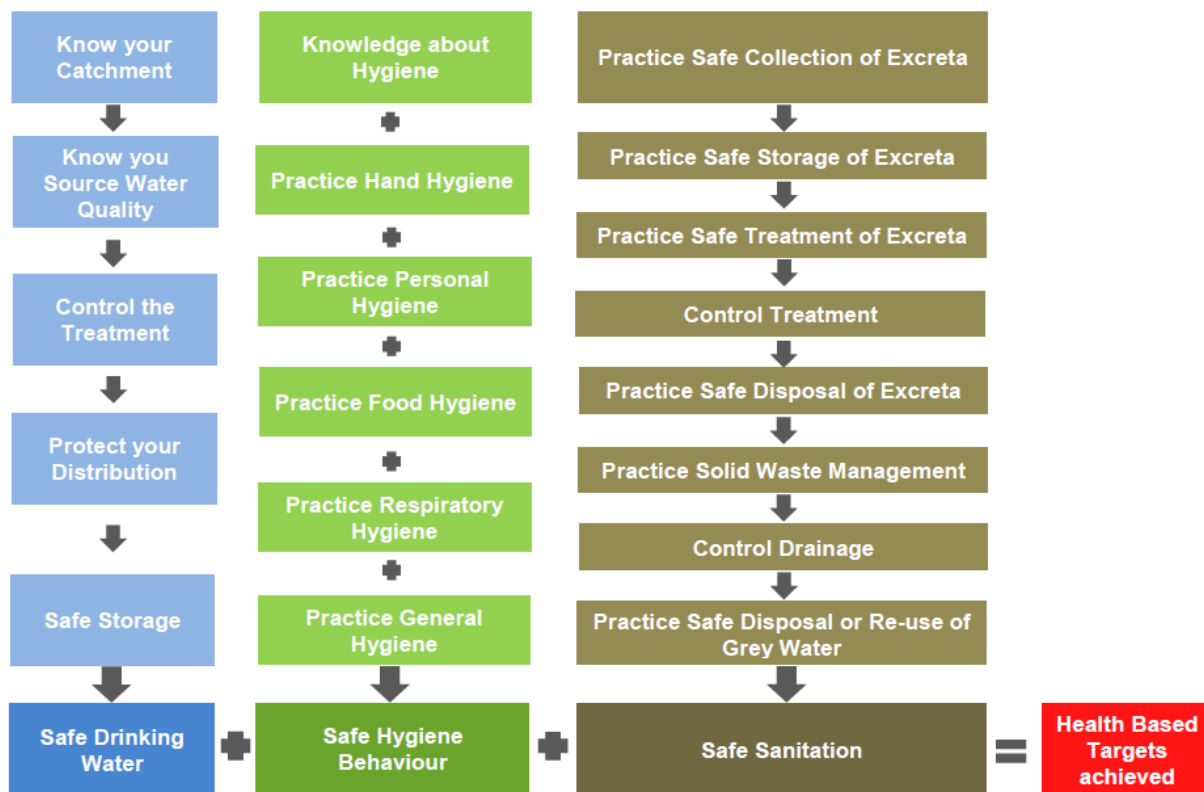

Figure 8.1 Risk Management-Approach of the Safety of Water, Sanitation and Hygiene (adapted from Medema et al., 2003: 22)

The blue part of the figure describes a safe chain from catchment to consumer for water and is adapted from Medema et al. (2003). The green part in the centre presents safe hygiene behaviour in all its parts and the brown part illustrates the sanitation system in its individual steps. The steps derive from the definitions of sanitation and hygiene that are given in the introduction.

8.1 Implementation of a WaSH Safety Plan

The Water Safety Plan is an ideal model to be adapted and extended to a WaSH Safety Plan. The reasons for this are that on the one hand, it is appropriate to integrate hygiene and sanitation, and on the other hand many steps contained in the WSP can be used for the WaSH Safety Plan to ensure a holistic strategy of preventing people from faecal-oral transmitted diseases. For example, before an implementation can take place a system assessment, as in the WSP, must be carried out. One of the first tasks is to develop a multidisciplinary team which includes all stakeholders. This is more complicated for the WaSH Safety Plan because all

three parts, water, sanitation and hygiene, need to be considered and all stakeholders have to be involved. Furthermore the system assessment includes the description and documentation of the system and therefore data collection is necessary, followed by a hazard assessment and risk characterisation. Afterwards control measures have to be identified and monitored (World Health Organization, 2011b: 48). As mentioned for the WSP, especially for small water suppliers, as well as for the WaSH Safety Plan it would be almost impossible to fully implement such a plan immediately, but first steps should be feasible. These steps are mapping of the system, hazard identification and assessment of risks.

8.1.1 System Assessment for a WaSH Safety Plan

As described in chapter 6.3 a system assessment has to be performed not only for the WSP but also for the WaSH Safety Plan. For the latter an assessment has to be carried out for all three components. So it is important to know how the water supply is working and which risks may arise, and the same must be done for sanitation and hygiene. It is important to know details of the latrine coverage, the types of toilets that are used as well as the coverage of hand-washing facilities. Before a scheme developed by the Water and Sanitation Development Facility starts to operate, a baseline study is conducted that includes data and information about water supply, sanitation status, environmental status, gender and previous projects in the area (Ministry of Water, Lands and Environment, Directorate of Water Development, 2002: 6ff). This baseline study was “done through house to house surveys physically by the interim Water and Sanitation Committee members and the project staff.” (Ministry of Water, Lands and Environment, Directorate of Water Development, 2002: 7) Also the Uganda Bureau of Statistics provides data and information about subjects such as household conditions, used water sources, toilet facilities, income and health (Uganda Bureau of Statistics, 2010) that can complete the other data and be used for the system assessment.

Possible hazards have to be identified from the system assessment. This should also be performed by the former build team. These steps are also included in the WSP and can be used for the WaSH Safety Plan. A more detailed description is given in chapter 6.3.1. In short, all hazards that may cause harm to the system and to the population have to be considered. As for the WSP, here the source of hazard, the entry point as well as the events that result of the

contamination need to be taken into account and identified (Drinking Water Inspectorate, 2005: 4). The risk characterisation determines the likelihood and the severity of a risk (Deere et al., 2001: 259). This is important for the step of ranking risks, due to the fact that not all hazards and hazardous events need control measures.

8.1.2 Critical Points and Control Measures in WaSH

As the WSP model uses the risk management approach of Hazard Analysis and Critical Control Points it is also important to identify these points for the WaSH Safety Plan. “Barriers are Control Points [...], that is, points that control the risk by reducing or eliminating the transfer of pathogens to end-users. To ensure an appropriate prioritisation some of these points can be singled out as the most significant and can be termed Critical Control Points.” (Deere et al., 2001: 271) For water, critical points and operational limits are defined and in some systems monitoring is done online (Bartram et al., 2009: 63). For hygiene and sanitation is not so easy to develop critical points and operational limits than for water supply. One reason for this is that sanitation and hygiene is happening at household level whereas water supply is on a higher level, mainly municipality. Furthermore regulations and standards are not yet established for sanitation and hygiene. Possible critical points for all WaSH components are given in the following table.

Table 8.1 Critical Points for Hygiene, Sanitation and Water

Hygiene	Sanitation	Water
<ul style="list-style-type: none"> - before eating - before preparing food - before feeding children - after defecation - after contact with child faeces 	<ul style="list-style-type: none"> - point of excretion - collection/storage - treatment - conveyance - further treatment - use/disposal 	<ul style="list-style-type: none"> - source/catchment - treatment - storage - distribution - consumption
(Curtis et al., 2000: 2)	(adapted from Stenström et al., 2011: 105)	(adapted from World Health Organization, 2008: 53ff)

To make it possible to manage critical points, critical limits have to be developed so that incidents can be identified. For sanitation and hygiene a possible critical limit could be a certain amount of microbiological or chemical pollution of groundwater supply points (wells

and springs) or increased occurrence of diarrhoeal diseases or other hygiene and sanitation related diseases.

Identified critical points and critical limits are linked to control measures. In the context of WSPs control measures are defined as “activities or processes [...] to eliminate or significantly reduce the occurrence of [...] hazards.” (World Health Organization, 2008: 52) Control measures for faecal contaminated groundwater could be building a proper new pit because the old one causes groundwater pollution, as described in chapter 7.2.1, or carrying out hygiene promotion because source water is contaminated due to open defecation.

8.2 Roles and Responsibilities of Different Actors

According to the “Guidelines for drinking water quality” (2011) the teams implementing and managing a WSP “include engineers, catchment and water managers, water quality specialists, environmental or public health or hygiene professionals, operational staff and representatives of consumers or from the community.” (World Health Organization, 2011b: 49) This statement is also appropriate for WaSH Safety Plans and based on it possible actors are presented below. Based on the results of the interviews and the analysis for the WaSH Safety Plan and the context of the visited RGCs in the south west of Uganda it is advisable to divide the components into hardware and software. Figure 8.2 illustrates in what actors and responsibilities this division results.

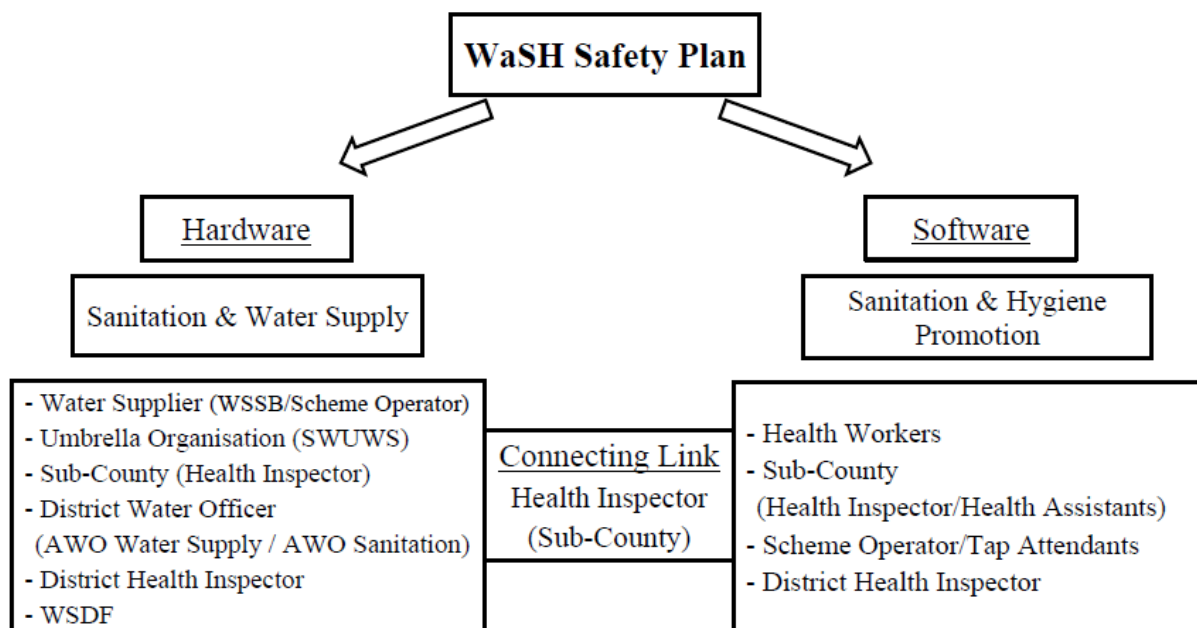

Figure 8.2 Actors involved in Implementation

The reason why the division in hardware and software is advisable is the fact that these two areas require different skills and knowledge. Some actors, however, play a role in both due to certain responsibilities. The structure includes actors from the regional and local level – district, sub-county and rural growth centre. Due to the fact that experts are needed to develop such a plan it does not make sense to work only on the level of rural growth centres because it is not possible to have all the experts and experienced staff there. The districts and sub-counties already face the problem that very often positions are not filled e.g. the Ministry of Health states that only 10 percent of Assistant District Health Officers (ADHO) in charge of Environmental Health are in place. The figure shows that many actors are involved in an implementation of such a plan. The lead agency or actor should be the water supply and sanitation board in cooperation with the scheme operator. The water board consists of members from the local government. In addition to water users, the sub-county councillor in charge of health and the sub-county chief are members of the board (e.g. I 5 Scheme Operator). That means the local government is integrated but it is still very closely connected to the RGC.

In the following sub-chapters roles and responsibilities of the actors involved are presented. This includes responsibilities which they already hold and possible responsibilities which they could assume.

8.2.1 Hardware

Hardware pertains to the construction of water supply schemes and sanitation infrastructure.

The **water supplier**, which is the Water Supply and Sanitation Board, play a very important part in developing and implementing a WaSH Safety Plan. In particular, the scheme operator is of importance because he has a lot of knowledge about the scheme. Furthermore the water board is managing and the scheme operator is operating the scheme, so they are responsible for the day to day activities. They are responsible for monitoring according to the performance and management contracts.

The **Umbrella Organisation** (for this part of the country it is the South Western Umbrella of Water and Sanitation) has the responsibility of supporting the water and sanitation schemes with know-how but also with spare parts. Furthermore they carry out water quality tests and are responsible for “mentoring, training [and] water quality monitoring.” (Ministry of Water and Environment, 2009a: 7) They should provide support and supervise EcoSan construction works. Training for scheme operators about EcoSan toilets and how to construct them should be provided.

The local government, e.g. **sub-county** or **district**, are of great importance because here ordinances and by-laws can be put in place in order to enact environmental sanitation (Ministry of Health, 2011: 82). The staff, especially the **health inspector** and the **health assistants**, are responsible for monitoring whether these laws are met. The **District Water Officer** (DWO) as well as the health assistants are responsible for sanitation on regional level. The health inspector at the district is a very important person, he has the right to admonish people for not building a proper latrine or can even arrest them (I 6 Scheme Operator).

The **Water and Sanitation Development Facility** (WSDF) plans and finances the water supply scheme. The WSDF has an engineering specialist who has to “[maintain water resources data and developments in the region” (Ministry of Water and Environment, 2009a: 25) as well as developing and/or reviewing technical plans and reports, procurement of contractors and supervision of construction works. Due to this, the WSDF has specific knowledge about the construction projects. Furthermore the WSDF is working with an environmental sanitation specialist who has to “[e]valuate the Environmental sanitation situation in the target RGCs at the time of application” (Ministry of Water and Environment, 2009a: 25) and has to identify necessary interventions to improve sanitation. The environmental sanitation specialist is responsible for preparing sanitation activities as well as developing sanitation related monitoring and evaluation tools with key stakeholders (Ministry of Water and Environment, 2009a: 25). That means the WSDF has good knowledge about the situation in the RGCs before schemes are opened and are therefore important in the system assessment process.

8.2.2 Software

Software in this context is related to tasks such as hygiene promotion and sanitation promotion where social skills are very relevant. Software forms an integral part in ensuring the safety of all components.

The **health inspector** as well as **health assistants** and **health workers** play a very important role for sanitation and hygiene. They are inter alia responsible for sanitation and hygiene promotion and are involved in sensitising and mobilising people (I 6 Health Workers). The health inspector is located at the district level. Health assistants are at the sub-county level and health workers are also in rural growth centres. Their responsibility is to encourage people to practice safe sanitation and hygiene behaviour.

The **Scheme operator** and **tap attendants** also play a part in software. They have direct contact with the community and can sensitise the inhabitants. They promote EcoSan toilets and advise the people how to use them. Furthermore it is their task to check that water users have clean jerry cans (I 3 Scheme Operators). In addition, one scheme operator told me that

he also sensitizes people with private connections about sanitation and hygiene issues (IS Scheme Operator). This should be done by all scheme operators.

8.3 Verification

“On completion of the [...] [implementation of a WaSH Safety Plan] [...] it is necessary to conduct a review to verify that the [WaSH Safety] plan was effective in reducing the risks and identifying which areas still require further improvement, if any.” (Sanderson, McKenzie, 2011: 7) This can be also important for the government or district to see if the investment was worthwhile (Sanderson, McKenzie, 2011: 7). Normally external verification should be performed. That means verification should be provided by an actor who was not involved in the process and therefore it has to be the central government, a private organisation or NGO because both the district and the sub-county are involved. If verification is done by a NGO funding has to be considered which could pose a problem. A possibility could be the Environmental Health Division of the Ministry of Health but I am not sure if they have enough resources to provide this task.

9. Conclusion

As presented at the beginning of my thesis, sanitation and hygiene have long been neglected topics. Donor interventions tend to improve water supply and to provide hardware. The great improvements achieved through interventions in sanitation infrastructure and hygiene have been ignored and interventions received relatively low priority. Reasons for this are inter alia the greater attractiveness of community interventions as opposed to household interventions and also distaste and embarrassment about the topic of sanitation. But to make improvements in public health and to achieve health-based targets hygiene and basic sanitation has to be considered.

The great impact of hygiene and sanitation interventions on health makes it obvious to include these components in the Water Safety Plan model. Due to the fact that the Water Safety Plan and the interventions in WaSH both aim at achieving health-based targets, it is reasonable and possible to adapt and expand the WSP with sanitation and hygiene. Furthermore, it is not only possible to include sanitation and hygiene but it is also a necessity, because a lack of only one of the components of WaSH presents a severe threat to health. The reason for this is that water supply and sanitation have health-based targets which cannot be achieved without hygiene. On the other hand hygiene also has health-based targets which in turn cannot be met if water supply and sanitation are missing, because the water and sanitation infrastructural systems are the basis for hygiene behaviours. Evidence of the importance of such a holistic and elaborate model is provided by the F-Diagram, also called faecal-oral transmission routes, which sets out very clearly how primary and secondary barriers – sanitation and hygiene – interrupt the transmission of faecal-oral diseases. Furthermore it is possible and feasible to create instruments according to the WSP for the WaSH Safety Plan. That means the individual steps developed for the implementation of a WSP can be used and adapted for WaSH Safety Plans.

Important is that for implementing a WaSH Safety Plan an infrastructure is needed. This means not only the infrastructure for the service delivery, but also for monitoring, setting laws and regulations and executing these laws and regulations. In Uganda sanitation and hygiene

belongs to three different ministries and is regulated through the Memorandum of Sanitation of 2001 in which responsibilities are defined. This division imply difficulties and problems, e.g. communication between the ministries as well as funding. Despite these problems the infrastructure in Uganda, and particularly in the visited rural growth centres, can be used and adapted for an implementation of WaSH Safety Plans. More effort is needed to ensure that the actors involved in sanitation and hygiene accept their responsibilities. Furthermore, it is important to create a public discussion about the issue and to set laws and regulations. A legal basis for hygiene must be established to ensure that hygiene practices are safe and that people commit to the regulations and abide by the rules. A legal framework for hygiene is also important for implementing actions in order to improve the situation and for monitoring.

As mentioned for WSPs, it will not be possible to implement all at once and enough time will be needed. Important is that lessons are learned from the Kampala Water Safety Plan and that the appropriate conclusions are drawn. This means coordination and cooperation between different institutions and actors is necessary and has to be improved. Furthermore the dissemination of the approach is important and needs more effort. All actors have to be informed about the approach and its benefits in all dimensions to support the model. It should not be realized as a donor driven concept.

Finally, to achieve the goals and expected results of a WaSH Safety Plan awareness raising and educational work is needed. In addition one of the first steps has to be the development of regulations and standards otherwise there is no legal basis to work with. Furthermore research is needed to behavioural changes and how people can be stimulated to improve their hygiene and sanitation practices. The reason for this is that a WaSH Safety Plan alone will not lead to any improvements, unless all the people concerned are willing to implement this plan.

References

- Africare (n. d.): „About The National Handwashing Campaign“. *Hands to be proud of*.
<http://www.handwashing.ug/about.html> (accessed 18.04.2012)
- Appleton, Brian; Sijbesma, Christine (2005): „Hygiene Promotion: Thematic Overview Paper“. IRC.
- ARGOSS (2001): *Guidelines for Assessing the Risk to Groundwater from On-Site Sanitation*.
British Geological Survey Commissioned Report.
- Arnalich, Santiago (2010): *Gravity Flow Water Supply: Conception, design and sizing for Cooperation projects*. Santiago Arnalich Castaneda. — ISBN: 8461432770
- Austin (2006): *Guidelines for the Design, Operation and Maintenance of Urine-Diversion Sanitation Systems*. Republic of South Africa. — ISBN: 1770054561
- Barrenberg, Eva; Stenström, Thor-Axel (2010): „Concept Note Sanitation Safety Plans (SSP): A vehicle for guideline implementation“. In: *Information Kit on the WHO Guidelines for Safe Use of Wastewater, Excreta and Greywater in Agriculture and Aquaculture*. 2nd Ed. Geneva: WHO.
- Bartram, Jamie; Corrales, Lana; Davison, Annette; et al. (2009): *Water Safety Plan Manual: Step-by-step risk management for drinking-water suppliers*. Geneva: World Health Organization.
- Bauer, Dolores M. (2006): *Mein Uganda: Ein demokratiepolitisches Modell? Reportagen - Impressionen - Gespräche*. Wien: Mandelbaum Verlag.
- Böhm, Andreas (2010): „Theoretisches Codieren: Textanalyse in der GroundedTheory“. In: *Flick, Uwe; Von Kardorff, Ernst; Seineke, Ines: Qualitative Forschung: Ein Handbuch*. 8th Ed. Reinbek bei Hamburg: Rowohlt, 475 – 485.
- Brikké, Francols; Bredero, Maaren (2003): *Linking technology choice with operation and maintenance in the context of community water supply and sanitation*. Geneva: World Health Organization.
- Burton, Maxine; Cobb, Emma; Donachie, Peter; et al. (2011): „The Effect of Handwashing with Water or Soap on Bacterial Contamination of Hands“. In: *International Journal of Environmental Research and Public Health*. 8, 97–104, DOI: 10.3390/ijerph8010097.
- Cairncross, Sandy (2003): „Handwashing with soap - a new way to prevent ARIs?“. In: *Tropical Medicine & International Health*. 8 (8), 677–697, DOI: 10.1046/j.1365-3156.2003.01096.x.

- Cairncross, Sandy; Bartram, Jamie; Cumming, Oliver; et al. (2010): „Hygiene, Sanitation, and Water: What Needs to Be Done?“. In: *PLoS Medicine*. 7.
- Cairncross, Sandy; Valdmanis, Vivian (2006): „Water Supply, Sanitation, and Hygiene Promotion“. In: *Disease Control Priorities in Developing Countries*. 2nd Ed. Washington DC: World Bank.
- Centers for Diseases Control and Prevention (2011): „Environmental Health Services (EHS) - Water Safety Plans“. <http://www.cdc.gov/nceh/ehs/GWASH/wsp.htm> (accessed 03.04.2012)
- Clark, Rebecca; Gundry, Stephen W. (2004): „The prominence of health in donor policy for water supply and sanitation: a review“. In: *Journal of Water and Health*. 2 (3), 157–169.
- Curtis, Val; Cairncross, Sandy (2003): „Effect of washing hands with soap on diarrhoea risk in the community: a systematic review“. In: *THE LANCET Infectious Diseases*. 3 (5), 275–281.
- Curtis, Valerie; Cairncross, Sandy; Yonli, Raymond (2000): „Domestic hygiene and diarrhoea - pinpointing the problem“. In: *Tropical Medicine & International Health*. 5 (1), 22–32.
- Davison, Annette; Howard, Guy; Stevens, Melita; et al. (2005): *Water Safety Plans: Managing drinking-water quality from catchment to consumer*. Geneva: WHO Geneva.
- Deere, Dan; Stevens, Melita; Davison, Annette; et al. (2001): „Management strategies“. In: *Water Quality: Guidelines, Standards and Health: Assessment of risk and risk management for water-related infectious disease*. London: WHO, IWA Publishing, 257–288. — ISBN: 924154533X
- Directorate of Water Development (n. d.): „Memorandum of Understanding: Water and Sanitation Development Facility, District Local Government and WSC/WSSB“.
- Drinking Water Inspectorate (2005): „A Brief Guide to Drinking Water Safety Plans“.
- Esrey, S A; Potash, J B; Roberts, L; et al. (1991): „Effects of improved water supply and sanitation on ascariasis, diarrhoea, dracunculiasis, hookworm infection, schistosomiasis, and trachoma“. In: *Bulletin of the World Health Organization*. 69 (5), 609–621.
- Food and Agricultural Organization (2011): „FAOSTAT“. <http://faostat.fao.org/desktopdefault.aspx?pageid=342&lang=en&country=226> (accessed 14.02.2012)
- Friedrich, Henriette Pauline (2010): *Rural Growth centres in Sothwest-Uganda: Development in the eyes of people*. VDM Verlag Dr. Müller. — ISBN: 978-3-639-23068-0

- Fu, Naishin (2010): „User Experience and Drivers for Adoption of Ecological Sanitation Toilets in Kisoro and Kabale, Uganda“. (Thesis) Boston: Harvard School of Public Health.
- Glaser, Barney G.; Strauss, Anselm L. (2008): *The Discovery of Grounded Theory: strategies for qualitative research*. 3rd paperback print. New Brunswick, NJ: Aldine Transaction.
- Gläser, Jochen; Laudel, Grit (2009): *Experteninterviews und qualitative Inhaltsanalyse: als Instrumente rekonstruierender Untersuchungen*. 3rd Ed. Wiesbaden: VS Verlag für Sozialwissenschaften.
- Government of Southern Sudan (2011): „At a Glance“. *Welcome to the Official Website of Government of the Republic of South Sudan*. <http://www.goss-online.org/magnoliaPublic/en/about/atagance.html> (accessed 20.01.2012)
- Government of Uganda; AfDB; ADA; et al. (2007): „Joint Water and Sanitation Sector Programme Support (2008-2012): Programme Document“.
- Havelaar, Arie H. (1994): „Application of HACCP to drinking water supply“. In: *Food Control*. 5 (3), 145–152.
- Health Action International; World Health Organization; Ministry of Health (2002): „Uganda Pharmaceutical Sector Baseline Survey“.
- Howard, Guy; Jahnel, Jutta; Frimmel, Fritz; et al. (2006a): „Human excreta and sanitation: Potential hazards and information needs“. In: *Protecting Groundwater for Health: Managing the Quality of Drinking-water Sources*. London, Seattle: WHO, IWA Publishing, 275–308. — ISBN: 92 4 154668 9
- Howard, Guy; Reed, Brian; McChesney, Dennis; et al. (2006b): „Human excreta and sanitation: Control and protection“. In: *Protecting Groundwater for Health: Managing the Quality of Drinking-water Sources*. London, Seattle: WHO, IWA Publishing, 587–612. — ISBN: 92 4 154668 9
- Jung, Helmut; Knapp, Andreas; Kobusingye, Elisabeth; et al. (n. d.): „South Western Umbrella of Water & Sanitation“.
- Kisoro District Local Government (2008): „Kisoro District: The State of Environment Report for Kisoro District 2007/2008“.
- Koestler, Lucrezia; Van Lieshout, René (2012): „Piped schemes: evolution of management models require improved accountability while rural communities in Uganda climb the ladder of rural drinking water services“.
- Mara, Duncan; Lane, Jon; Scott, Beth; et al. (2010): „Sanitation and Health“. In: *PLoS Medicine*. 7 .

- Medema, Gertjan J.; Payment, Pierre; Dufour, Alain; et al. (2003): „Safe Drinking Water: An ongoing Challenge“. In: *Assessing Microbial Safety of Drinking Water: Improving Approaches and Methods*. Padstow, Cornwall: WHO, 11–45. — ISBN: 1843390361
- Meinefeld, Werner (2010): „Hypothesen und Vorwissen in der qualitativen Sozialforschung“. In: *Flick, Uwe; Von Kardorff, Ernst; Seineke, Ines: Qualitative Forschung: Ein Handbuch*. 8th Ed. Reinbek bei Hamburg: Rowohlt, 265 – 275.
- Ministry of Health (2011): „Annual Health Sector Performance Report. Financial Year 2010/2011“.
- Ministry of Water and Environment (2011a): „MWE Administration & Management“. *Republic of Uganda: Ministry of Water and Sanitation*. (accessed 24.11.2011)
- Ministry of Water and Environment (2009a): „Operations Manual for the Water and Sanitation Development Facility“.
- Ministry of Water and Environment (2011b): „Small Towns Water Supply & Sanitation“. *Republic of Uganda: Ministry of Water and Sanitation*. http://www.mwe.go.ug/index.php?option=com_content&view=article&id=118&Itemid=132 (accessed 19.03.2012)
- Ministry of Water and Environment (2009b): „Strategic Sector Investment Plan for the Water and Sanitation Sector in Uganda“.
- Ministry of Water and Environment (2009c): „Sustainable O&M of Piped Water Supplies through Umbrella Organisations“. In: *Water and Environment News*. (1).
- Ministry of Water and Environment (2010): „Uganda Water Supply Atlas 2010“.
- Ministry of Water and Environment (2011c): „Water & Sanitation Development Facilities“. *Republic of Uganda: Ministry of Water and Sanitation*. http://www.mwe.go.ug/index.php?option=com_content&view=article&id=112&Itemid=130 (accessed 16.03.2012)
- Ministry of Water and Environment (2011d): „Water and Environment Sector Performance Report 2011“.
- Ministry of Water and Environment (2011e): „WSDF - Western Region“. *Republic of Uganda: Ministry of Water and Sanitation*. http://www.mwe.go.ug/index.php?option=com_content&view=article&id=120&Itemid=135 (accessed 14.03.2012)
- Ministry of Water and Environment (2011f): „WSDF-SW Activities“. *Republic of Uganda: Ministry of Water and Sanitation*. http://mwe.go.ug/index.php?option=com_content&view=article&id=126:wsdf-sw-activities&catid=65 (accessed 04.05.2012)

- Ministry of Water and Environment; Directorate of Water Development (2006): „SWTWS II End of Project Report“.
- Ministry of Water, Lands and Environment; Directorate of Water Development (2002): „South Western Towns Water and Sanitation Project: End of Phase I Project Report“.
- Munzinger Online (2010a): „Uganda - Grunddaten, Geographie, Bevölkerung“. www.munzinger.de/document/03000UGA000 (accessed 01.12.2011)
- Munzinger Online (2012): „Uganda - Politik“. www.munzinger.de/document/03000UGA000 (accessed 21.01.2012)
- Munzinger Online (2010b): „Uganda - Soziales und Bildung“. <https://univpn.univie.ac.at/+CSCO+dh756767633A2F2F6A6A6A2E7A68616D76617472652E7172++/search/document?index=mol-03&id=03000UGA040&type=text/html&query.key=SXRWf8Lb&template=/publikationen/laender/document.jsp&preview=> (accessed 21.01.2012)
- Munzinger Online (2010c): „Uganda - Wirtschaft“. www.munzinger.de/document/03000UGA000 (accessed 21.01.2012)
- Natamba, Edward F; Myamba-Tamale, Lillian; Ssemakula, Eugene Gerald; et al. (2010): *Local Government Councils Performance and the Quality of Service Delivery in Uganda: Ntungamo District Council Score-Card 2008/2009*. Kampala: ACODE (ACODE Policy REsearch Paper Series No. 39,2010).
- National Water and Sewerage Corporation (2003): „Kampala Water Safety Plan Case Study“.
- Österreichische Forschungsstiftung für Internationale Entwicklung (2009): „Länderinformation Uganda“. <http://www.oefse.at/publikationen/laender/uganda.htm> (accessed 03.12.2011)
- Peal, Andy; Evans, Barbara; Van der Voorden, Calolin (2010): *Hygiene and Sanitation Software: An Overview of Approaches*. Geneva: Water Supply & Sanitation Collaborative Council.
- Pinfold, John (2006): „Uganda: Assessing Performance of the Water and Sanitation Sector“. In: *Emerging Good Practice in Managing for Development Results: Source Book*. Washington DC: OECD-DAT Joint Venture on Managing for Development Results, 95–100.
- Poonam, Pillai; Mutono, Sam (n. d.): „Scaling up sanitation and hygiene in Uganda“.
- Prüss, Annette; Kay, David; Fewtrell, Lorna; et al. (2002): „Estimating the Burden of Disease from Water, Sanitation, and Hygiene at a Global Level“. In: *Environmental Health Perspectives*. (5) 110 , 537–542.
- Sanderson, R; McKenzie, N (2011): „WaSH Safety Plans: A Risk-Based Approach to Protecting Public Health“. In: *Water Practice and Technology*. 6 (2).

- Schlehe, Judith (2008): „Formen qualitativer ethnographischer Interviews“. In: *Beer, Bettina: Methoden ethnologischer Feldforschung*. 2nd Ed. Berlin: Dietrich Reimer, 119 – 142.
- South Western Umbrella of Water and Sanitation (2011): „SWUWS“.
- Stenström, Thor Axel; Seidu, Razak; Ekane, Nelson; et al. (2011): *Microbial Exposure and Health Assessments in Sanitation Technologies and Systems*. o.V. — ISBN: 9789186125363
- Stockholm Environment Institute (2008): „Factsheet 2: The Main Features of Ecological Sanitation“.
- Strauss, Anselm L.; Corbin, Juliet (1998): *Basics of Qualitative Research: Techniques and Procedures for Developing Grounded Theory*. 2nd Ed. Thousand Oaks: SAGE.
- Strauss, Anselm L.; Corbin, Juliet (1999): *Grounded Theory: Grundlagen Qualitativer Sozialforschung*. Weinheim: Beltz, Psychologie-Verl.-Union.
- Strübing, Jörg (2008): *Grounded Theory: Zur sozialtheoretischen und epistemologischen Fundierung des Verfahrens der empirisch begründeten Theoriebildung*. 2nd Ed. Wiesbaden: VS Verlag für Sozialwissenschaften.
- Sugden, Steven (2006): „WELL FACTSHEET The microbiological Contamination of Water Supplies“. *WELL*. <http://www.lboro.ac.uk/well/resources/fact-sheets/fact-sheets-htm/Contamination.htm> (accessed 10.08.2012)
- Tilley, Elizabeth; Lüthi, Christoph; Morel, Antoine; et al. (2008): *Compendium of Sanitation Systems and Technologies*. Swisserland: Eawag Aquatic Research.
- Timbatemwa, Sarah; Nabasirye, Lillian; Godfrey, Sam (2004): „Implementing water safety plans: Experience from Uganda“. In: *People-centred Approaches to Water and Environmental Sanitation*. Vientiane, Lao PDR: WEDC: Loughborough University, 641–644. — ISBN: 9871843800781
- Uganda Bureau of Statistics (2002a): „2002 Uganda Population and Housing Census: Kabale District Report“.
- Uganda Bureau of Statistics (2002b): „2002 Uganda Population and Housing Census: Kisoro District Report“.
- Uganda Bureau of Statistics (2002c): „2002 Uganda Population and Housing Census: Ntungamo District Report“.
- Uganda Bureau of Statistics (2012): „The 2012 Uganda Population and Housing Census“. *Census 2012: Counting for Planning and Improved Service Delivery*. <http://www.ubos.org/UgCensus2012/> (accessed 03.04.2012)
- Uganda Bureau of Statistics (2010): „Uganda National Household Survey 2009/2010: Socio-Economic Module“.

- United Nations (2003): „Uganda: Map No. 3862“. <http://www.un.org/Depts/Cartographic/map/profile/uganda.pdf> (accessed 02.12.2011)
- United Nations Development Programme (2011): *Human Development Report 2011. Sustainability and Equity: A Better Future for All*. Basingstoke, Hampshire: Palgrave Macmillan.
- United Nations Development Report (2011): *Human Development Report 2011- Sustainability and Equity: A better Furture for All*. New York.
- United Nations International Children’s Emergency Fund (1999): *A Manual on Hygiene Promotion: Towards better programming. Water, Environment and Sanitation Technical Guidelines Series No. 6*. New York: UNICEF.
- WASTE (2005): „What is Ecological Sanitation or Ecosan? Short on Ecological Sanitation“. *WASTE - Solutions on urban environment and development*. <http://www.ecosan.nl/page/447> (accessed 04.05.2012)
- Water Supply & Sanitation Collaborative Council (2011): „Uganda - WASH sector at a glance“. <http://www.wsscc.org/countries/africa/uganda/wash-sector-glance> (accessed 04.04.2012)
- Water Supply & Sanitation Collaborative Council; World Health Organization (2005): *Sanitation and Hygiene Promotion: Programming Guidance*. Geneva: WHO Press.
- World Bank (2010): „Data Profile - Uganda“. http://ddp-ext.worldbank.org/ext/ddpreports/ViewSharedReport?&CF=&REPORT_ID=9147&REQUEST_TYPE=VIEWADVANCED (accessed 14.02.2012)
- World Bank (2012a): „Data: By Topic“. <http://data.worldbank.org/topic> (accessed 14.02.2012)
- World Bank (2012b): „How we Classify Countries“. <http://data.worldbank.org/about/country-classifications> (accessed 14.02.2012)
- World Bank (2008): „Sanitation, Hygiene and Wastewater Resource Guide: Health Benefits“. <http://web.worldbank.org/WBSITE/EXTERNAL/TOPICS/EXTWAT/EXTTOPSANHYG/0,,contentMDK:21226306~menuPK:3747741~pagePK:64168445~piPK:64168309~theSitePK:1923181~isCURL:Y,00.html> (accessed 17.04.2012)
- World Bank (2003): „Water, sanitation & hygiene at a glance“.
- World Health Organization (1978): „Declaration of Alma-Ata: International Conference on Primary Health Care, Alma-Ata, USSR, 6-12 September 1978“.
- World Health Organization (1996): „Fact Sheets on Environmental Sanitation“. http://www.who.int/water_sanitation_health/hygiene/emergencies/envsanfactsheets/en/index2.html (accessed 01.05.2012)

- World Health Organization (2011a): „Global Health Observatory Data Repository“. *World Health Organization*. <http://apps.who.int/ghodata/?vid=20300&theme=country> (accessed 01.05.2012)
- World Health Organization (2008): *Guidelines for Drinking-water Quality*. 3rd Ed. Geneva: World Health Organization. — ISBN: 9789241547611
- World Health Organization (2011b): *Guidelines for Drinking-water Quality*. 4th Ed. Geneva: WHO. — ISBN: 9789241548151
- World Health Organization (2012): „Uganda: health profile“. <http://www.who.int/gho/countries/uga.pdf> (accessed 09.02.2012)
- World Health Organization; United Nations International Children’s Emergency Fund (2008): *Progress on Drinking Water and Sanitation: Special Focus on Sanitation*. New York and Geneva: WHO, UNICEF. — ISBN: 9879280643138
- World Health Organization; United Nations International Children’s Emergency Fund; Water Supply & Sanitation Collaborative Council (2008): „10 Things You Need to Know About Sanitation“.
- Zurbrügg, Christian (2002): „Solid Waste Management in Developing Countries: Solid waste management includes all activities that seek to minimise the health, environmental and aesthetic impacts of solid wastes“.

Appendices

Appendix A:

List of Interviewees

Scheme Operator

- I1: Ntungamo District
- I2: Kabale District
- I3: Ntungamo District
- I4: Kisoro District
- I5: Ntungamo District
- I6: Ntungamo District

Health Worker

- I1: Ntungamo District
- I2: Kabale District
- I3: Ntungamo District
- I4: Kisoro District
- I5: Ntungamo District
- I6: Ntungamo District

Staff from Ministries, Universities, NWSC, WB

- I1: AWO (Ministry)
- I2: AC (Ministry)
- I3: DWO (Ministry)
- I4: AWO (Ministry)
- I5: IL (Ministry)
- I6: KR (NWSC)
- I7: KC (NWSC)
- I8: KJ (Ministry)
- I9: MD (Ministry)
- I10: MI (University)
- I11: MS (WB)
- I12: NC (University)
- I13: TA (Ministry)

Appendix B:

CURRICULUM VITAE

PERSONAL INFORMATION

Name: Katharina Aspalter
Date and Place of Birth: March 7th, 1987, Scheibbs, Austria
Address: Zehethof 32; 3261 Steinakirchen, Austria
Phone: 0043 664 14 80 136
E-Mail: katharina_aspalter@yahoo.de
Nationality: Austrian



EDUCATION

10/2010: Begin of diploma thesis. Title: “WaSH –Water, Sanitation and Hygiene – Safety Plans and their Application in Rural Growth Centres in Uganda. Analysis of the Development of WaSH Safety Plans”

Since 10/2007: Studies in Environment and Bio-Resources Management at the University of Natural Resources and Life Sciences, Vienna.
Bachelor thesis 1: Communication for sustainable Water Use.
Bachelor thesis 2: The Water Framework Directive – Institutional deployment in the context of the Austrian water politics.

Since 10/2006: Studies in International Development, University of Vienna, Austria.

Major Fields of Study:

- Development Cooperation and Development Planning
- Environment and Development
- Water and Sanitation
- Qualitative Development Research
- African History

16th June, 2005: Matura (Austrian baccalaureate/high school leaving exam)

11/2005 – 06/2006: Participation in the WWOOF Program at farms in Mexico und Costa

Rica, during a trip from Mexico to Panama.

09/2001-06/2010: High School in Scheibbs, Austria

SCHOLARSHIP/STIPENDIENSHIP

12/2010 Leistungsstipendium from the University of Natural Resources and Life Science, Vienna

2009 TOP scholarship of the Lower Austrian Government

SCIENTIFIC WORK EXPERIENCE

06/2011-08/2011 10 weeks research stay in Uganda for data collection for the diploma thesis – realization of semi-structured interviews and expert interviews as well as participant observation.

09/2010 Internship at the Francisco Josephinum:
Biomass-Logistics-Technology, Wieselburg, Austria;
working in the project EUBIONET III

MEETINGS AND CONFERENCES

07/2012 54th International Congress of Americanists (ICA) in Vienna, AUT

OTHER SKILLS

10/2006 – 03/2007: Spanish language studies at the University of Vienna, Department for Romance Studies

Since 02/2004 till present: Voluntary emergency paramedic at the Austrian Red Cross

Since 2009 till present: Water and Sanitation Training at the Austrian Red Cross

06/2011: WatSan in Emergency Training / ERU WatSan International Workshop (Module M40)

07/2012 ERU WatSan International Workshop Mass Sanitation MSM20

Foreign Languages: English (fluent in written and spoken),
Spanish (fluent in written and spoken)