

Müllegger, Elke

**Research Report**

## REuse REduce REcycle

ÖFSE-Forum, No. 20

**Provided in Cooperation with:**

Austrian Foundation for Development Research (ÖFSE), Vienna

*Suggested Citation:* Müllegger, Elke (2003) : REuse REduce REcycle, ÖFSE-Forum, No. 20, ISBN 3-900592-81-0, Südwind-Verlag, Wien,  
<https://www.oefse.at/publikationen/oefse-forum/detail-oefse-forum/publication/show/Publication/R-Euse-R-Educe-R-Ecycle/>

This Version is available at:

<https://hdl.handle.net/10419/268104>

**Standard-Nutzungsbedingungen:**

Die Dokumente auf EconStor dürfen zu eigenen wissenschaftlichen Zwecken und zum Privatgebrauch gespeichert und kopiert werden.

Sie dürfen die Dokumente nicht für öffentliche oder kommerzielle Zwecke vervielfältigen, öffentlich ausstellen, öffentlich zugänglich machen, vertreiben oder anderweitig nutzen.

Sofern die Verfasser die Dokumente unter Open-Content-Lizenzen (insbesondere CC-Lizenzen) zur Verfügung gestellt haben sollten, gelten abweichend von diesen Nutzungsbedingungen die in der dort genannten Lizenz gewährten Nutzungsrechte.

**Terms of use:**

*Documents in EconStor may be saved and copied for your personal and scholarly purposes.*

*You are not to copy documents for public or commercial purposes, to exhibit the documents publicly, to make them publicly available on the internet, or to distribute or otherwise use the documents in public.*

*If the documents have been made available under an Open Content Licence (especially Creative Commons Licences), you may exercise further usage rights as specified in the indicated licence.*

Diplomarbeit

## **F O R U M 20**

**Elke Müllegger**

**REuse REDuce REcycle**

# **ÖFSE F O R U M**



**Elke Müllegger**

**REuse REduce REcycle**

**Mai 2002**

1. Auflage 2003

© Österreichische Forschungsstiftung für Entwicklungshilfe (ÖFSE)

A-1090 Wien, Berggasse 7, Telefon (+43 1) 317 40 10, Fax: (+43 1) 317 40 15

e-mail: office@oefse.at, internet: www.oefse.at

Für den Inhalt verantwortlich: Elke Müllegger

Cover: Grieder Graphik

Druck: Facultas Wien

Südwind-Verlag 3-900592-81-0

Bibliografische Information Der Deutschen Bibliothek

Die Deutsche Bibliothek verzeichnet diese Publikation in der Deutschen Nationalbibliographie;  
detaillierte bibliographische Daten sind im Internet über <http://dnb.ddb.de> abrufbar.

Gefördert aus den Mitteln des BMA – Bundesministerium für auswärtige Angelegenheiten

 Österreichische  
Entwicklungszusammenarbeit

Universität für Bodenkultur Wien

Institut für Wasserversorge,  
Gewässerökologie und Ab-  
fallwirtschaft Abteilung  
für Siedlungswasserbau,  
Industriewasserwirtschaft  
und Gewässerschutz

# **REuse REduce REcycle**

Diplomarbeit  
zur Erlangung des akademischen Grades  
Diplomingineur

eingereicht von: Elke Müllegger

Matr.Nr. 9540230

Mai, 2002

Mein Studium mit dieser Arbeit in Uganda abzuschließen war nur unter Zusammenarbeit vieler Menschen möglich – bei all jenen möchte ich mich bedanken. Den Mitarbeitern und Mitarbeiterinnen der Abteilung für Siedlungswasserbau, Industrielwasserwirtschaft und Gewässerschutz, thanks to my team in Uganda, meinen Freunden und Freundinnen, sowie meiner Familie für ihre Unterstützung.

# TABLE OF CONTENTS

<b>1. Einleitung - Introduction</b>	<b>1</b>
<b>1.1. Ein persönlicher Standpunkt</b>	<b>1</b>
<b>1.2. Zielsetzungen und Fragestellungen</b>	<b>2</b>
<b>1.3. A Personal View of the Historical Background</b>	<b>3</b>
<b>1.4. Aims and Scientific Questions</b>	<b>4</b>
<b>1.5. Outline</b>	<b>5</b>
<b>2. Regional Background</b>	<b>6</b>
<b>2.1. Uganda</b>	<b>6</b>
2.1.1. History	6
2.1.2. Physical Characteristics	8
2.1.3. Demographic Characteristics	8
2.1.4. Socio - economic Characteristics	9
<b>2.2. Kisoro District</b>	<b>12</b>
2.2.1. Physical Characteristics	12
2.2.2. Demographic Characteristics	15
2.2.3. Socio - economic Characteristics	16
2.2.4. Agriculture	18
<b>2.3. Kisoro Case Study</b>	<b>20</b>
2.3.1. Background Information	22
2.3.1.1. Kisoro within the South Western Town Water and Sanitation Project (swTws)	22
2.3.1.2. Kisoro Town Council Water and Sanitation Office (KITOWASO)	22
<b>3. Planning Methodes</b>	<b>24</b>
<b>3.1. Material Flux Analysis</b>	<b>24</b>
<b>3.2. The Household-centred Approach</b>	<b>26</b>
<b>3.3. Analysis of the Social System</b>	<b>30</b>
3.3.1. Rapid Rural Appraisal (RRA)	30
3.3.2. Participatory Rural Appraisal (PRA)	30
3.3.3. Tools of RRA and PRA	31
3.3.4. Limitations	32
<b>4. Ecological Sanitation</b>	<b>33</b>
<b>4.1. Background Information</b>	<b>33</b>
4.1.1. Drop-and-Store	33
4.1.2. Flush-and-Discharge	35
4.1.3. Sanitise-and-Reuse	35
<b>4.2. Urine and Faeces</b>	<b>37</b>
4.2.1. Urine	37
4.2.2. Faeces	39
<b>4.3. The Main Principles of EcoSan Facilities</b>	<b>43</b>
4.3.1. The Design	43
4.3.2. Dehydration	44
4.3.3. Decomposition	45
<b>4.4. Reuse of Human Excreta</b>	<b>46</b>
<b>4.5. The EcoSan Project in Kisoro</b>	<b>48</b>
4.5.1. Types of Excreta Disposal	48
4.5.2. Implementation	52

<b>5. Evaluation of Field Findings</b>	<b>54</b>
<b>5.1. Evaluation of Questionnaires</b>	<b>55</b>
5.1.1. EcoSan Toilets in Use	55
5.1.2. EcoSan Toilets not in Use	56
<b>5.2. Evaluation of Checklists</b>	<b>58</b>
<b>5.3. Potential of Reuse in Kisoro</b>	<b>59</b>
5.3.1. Return of Nutrients to the Soil	59
5.3.2. How much can be given back to Nature?	59
5.3.3. Questionnaire Outcomes	60
5.3.3.1. Household EcoSan Units	60
5.3.3.2. Public EcoSan Units	60
5.3.3.3. Results	61
<b>5.4. Nutrient Flow and Input-Output Analysis</b>	<b>62</b>
5.4.1. Sub-system Food	62
5.4.2. Sub-system Water	64
5.4.3. Conclusions	65
<b>6. Possible Measures</b>	<b>66</b>
<b>6.1. What Happens with the Sanitised Material?</b>	<b>66</b>
<b>6.2. Advantage of a Decentralised Solution</b>	<b>70</b>
6.2.1. The Role of the Household-centred Approach in Kisoro	70
<b>6.3. Further Steps Forward</b>	<b>72</b>
6.3.1. Education and Information	72
6.3.2. Demonstration Plots	72
6.3.3. EcoSan for Everybody	72
<b>7. Summary and Conclusions</b>	<b>74</b>
<b>8. References</b>	<b>77</b>
<b>9. Annexes</b>	<b>A1</b>
<i>Annex A: Questionnaires</i>	<b>A2</b>
<i>Annex B: Check lists</i>	<b>A31</b>
<i>Annex C: Interviews</i>	<b>A42</b>
<i>Annex D: Protocols of two farmers who are willing to use the toilet products</i>	<b>A52</b>



## INDEX OF TABLES

Table 1: Demographic indicators (SWI, 2001).	8
Table 2: Deprivation in rural and urban areas (UNDP, 1998).	10
Table 3: Land cover in Kisoro District (Norplan, 1997).	14
Table 4: District human poverty profile (UNDP, 1998).	15
Table 5: Evaluation of Kisoro Town population between 1991-1996 (TBW, 1999).	20
Table 6: Forecast of Kisoro Town population between 1997-2015 (TBW, 1999).	21
Table 7: Daily average amount of human excreta world-wide per person (Pieper, 2001).	37
Table 8: Daily average amount of selected components in human excreta per person (Otterpohl, 2001).	37
Table 9: Distribution of households and household population by toilet facilities (Norplan, 1997).	48
Table 10: Household sanitation survey (TBW, 1999).	49
Table 11: EcoSan units in Kisoro (April 2001).	52
Table 12: Number of interviewed respondents with composting units.	55
Table 13: Number of interviewed respondents with dehydrating units.	55
Table 14: Reuse of sanitised excrements - household units.	60
Table 15: Reuse of sanitised excrements - public units.	61

## INDEX OF FIGURES

Figure 1: Map of Uganda (UN, 1998).	7
Figure 2: HDI separated for male, female, urban and rural population (UNDP, 1998).	10
Figure 3: Location of the project area.	12
Figure 4: Map of Kisoro Town Centre.	21
Figure 5: System analysis of a region (Binder, 1996).	25
Figure 6: The Household-centred Environmental Sanitation – the main principles (Schertenleib, 2000).	27
Figure 7: Decision-making systems (Schertenleib, 2000).	29
Figure 8: Three basically ways for managing human excreta (Winblad, 1997).	33
Figure 9: The main principles of a pit latrine and a VIP.	34
Figure 10: The contribution of urine, faeces and greywater to nitrogen, phosphorus and potassium.	38
Figure 11: Closing the nutrient cycle with urine (Esrey et al., 2001).	39
Figure 12: Closing the nutrient cycle with sanitised faeces (Esrey et al., 2001).	40
Figure 13: The F-diagram: the main ways diarrhoea is spread (Esrey et al., 1998).	41
Figure 14: Basic design of an EcoSan dehydration toilet (Esrey et al., 1998).	43
Figure 15: Sub-system food.	63
Figure 16: Sub-system water.	64
Figure 17: The 5 solutions based on the Household-centre Approach.	71
Figure 18: A new hygienic and prestigious toilet (Brandberg, 1997).	73

## INDEX OF PICTURES

Picture 1: People and animals sharing one spring.	17
Picture 2: Local market in Kisoro Town.	19
Picture 3: The urban centre of Kisoro Town.	20
Picture 4: Public water kiosk – old market and new market Kisoro Town.	23
Picture 5: Model of a squatting slab.	44
Picture 6: Example of a composting toilet in Kisoro.	50
Picture 7: Examples of dehydration toilets in Kisoro.	51
Picture 8: Toilet sub structure.	53
Picture 9: Data collection by house to house visits.	54

## ABBREVIATIONS

a. s. l.	Above Sea Level
DFID	Department for International Development (United Kingdom)
DUS	Decentralised Urban Sanitation
EcoSan	Ecological Sanitation
e.g.	for example
g	gram
GDP	Gross Domestic Products
HCA	Household-centre Approach
HDI	Human Development Index
HCES	Household-centre Approach for Environmental Sanitation
HH	Household
HIPC	Heavily Indebted Poor Countries
HPI	Human Poverty Index
Hrg./Ed.	Herausgeber/Editor
EL/DC	Entwicklungsland/Developing country
IL/IC	Industrieland/Industrialised countries
IRC	International Water and Sanitation Centre (the Netherlands)
Jerrycan	20 litre water container
K	Potassium
kg/p/year	Kilogram/Person/Year
KITOWASO	Kisoro Town Water and Sanitation Office
MFA	Material Flux Analysis
N	Nitrogen
NRM	National Resistance Movement
OEFSE	Österreichische Forschungsstiftung für Entwicklungshilfe
OEZA	Österreichische Entwicklungszusammenarbeit
P	Phosphorous
PRA	Participatory Rural Appraisal
RRA	Rapid Rural Appraisal
SKAT	Swiss Centre for Development Co-operation in Technology and Management
sp. km	Square kilometre
SWI	Österreichische Stiftung für Weltbevölkerung und Internationale Zusammenarbeit
swTws	South Western Towns Water and Sanitation Project
TBW	Technisches Büro Weidl
Ugh. Shilling	Uganda Shilling
UN	United Nations
UNDP	United Nations Development Programme
VIP	Ventilated Improved Pit Latrine
WHO	World Health Organisation
WSSCC	The Water Supply and Sanitation Collaboration Council

# 1. EINLEITUNG - INTRODUCTION

## 1.1. Ein persönlicher Standpunkt

Seit den sechziger Jahren wird global über Umweltverschmutzung, Ausbeutung und Begrenztheit der natürlichen Ressourcen gesprochen. Die Aufnahmekapazität und Überbeanspruchung der Umwelt für Emissionen und Abfall sind in weiten Bereichen zum Diskussions-thema geworden, da die Folgen und Auswirkungen durch die massive Ausbeutung der natürlichen Ressourcen immer offensichtlicher werden.

Ein hoher Grad an Umweltverschmutzung und in der Folge gesundheitsschädliche Lebensbedingungen fordern ihr Tribut: Jedes Jahr sterben 3.3 Millionen Menschen an vermeidbaren Durchfallerkrankungen. Alleine in Afrika sind 80 Millionen Menschen jährlich von Cholera bedroht sowie weitere 16 Millionen Fälle von Typhus resultieren aus mangelhaften Sanitär-anlagen und verschmutztem Trinkwasser (WHO, 1996). Jede fünfte Person hat keinen Zugang zu sauberem und erschwinglichem Trinkwasser, sogar jeder zweiten Person mangelt es am Zugang zu sicheren sowie ausreichenden sanitären Einrichtungen (Larsson, 2001).

Vor allem in den Ländern des Südens stellt die rasche Urbanisierung im Zusammenhang mit dem rapiden Wachstum der Bevölkerung und der Landflucht eine wachsende Herausforderung dar. Besonders für Probleme, wie gesicherte Wasserversorgung und Siedlungshygiene, Ernährungssicherheit, steigende Umweltverschmutzung, um nur einige zu nennen, wird nach passenden Lösungen und Strategien gesucht.

Der „Stoffwechsel“ von Städten ist geprägt von einem hohen Materialdurchfluss, in Form von Lebensmitteln, Wasser, Energie, etc. Diese Stoffflüsse gelangen aus der umgebenden Landschaft in die Stadt und verlassen diese nach Gebrauch bzw. Verbrauch meist wieder in Form von Abfall (Esrey, 2001). Mit Fäkalien belastetes Abwasser, das weltweit zu 90% ungeklärt in die Umgebung abgegeben wird, gelangt in den natürlichen Wasserkreislauf und verschlechtert somit enorm die Qualität der Umwelt. Damit geht auch eine erhebliche Verschlechterung der hygienischen und gesundheitlichen Bedingungen der urbanen Bewohner und Bewohnerinnen einher. Familien müssen unter oft unzulänglichen Bedingungen ums Überleben kämpfen. Vor allem Frauen und Kinder fallen unter die Opfer und Betroffenen. Eine rasch wachsende Bevölkerung und ein schwer kontrollierbares Expandieren der Städte erhöht den Bedarf an einer sicheren, nachhaltigen und erschwinglichen Siedlungshygiene in Ländern des Südens. Vor allem ärmere Bevölkerungsschichten in urbanen, peri-urbanen sowie ländlichen Gegenden profitieren kaum von der öffentlichen Versorgung mit sauberem Wasser oder der Bereitstellung von sanitären Einrichtungen.

Auf der Suche nach globalen, allgemein gültigen Lösungsmustern um diese Herausforderungen der Zukunft zu lösen, wurden Konzepte und Strategien in diesem Sinne entwickelt. Jedoch erweisen sich Modelle, die eine allgemeine Gültigkeit versprechen, immer wieder als ungeeignet. Modernisierungskonzepte für sogenannte Entwicklungsländer verfolgen immer noch eine „top-down“ Strategie. Unzählige Berichte über fehlgeschlagene Projekte in Kombination mit oft katastrophalen Auswirkungen und Veränderungen der lokalen Lebenssituation ändern kaum etwas am Festhalten längst überholter Strategien. Eine „bottom-up“ Sichtweise, wie das Einbeziehen von lokalem Wissen und Gegebenheiten, die Mitbestimmung auf lokaler Basis, findet nur langsam Beachtung in nationalen und internationalen Gremien. Die unterschiedlichen lokalen Bedingungen verlangen nach Projekten, die nach den örtlichen Bedingungen adaptierte Lösungen anbieten.

## 1.2. Zielsetzungen und Fragestellungen

Es soll gezeigt werden, dass Konzepte angepasster Siedlungshygiene als adäquate Lösungsansätze gelten und die Lebensbedingungen der Menschen vor Ort nachhaltig verbessern. Durch Trockentoiletten soll der Wasserverbrauch reduziert und eine Wasserverschmutzung vermieden werden. Hygienisierte menschliche Fäkalien beinhalten wichtige Nährstoffe, die als hochwertiger Dünger wieder in den natürlichen Kreislauf rückgeführt werden können. Durch diese Wiederverwertung wird die Fruchtbarkeit des Bodens vor Ort sowie die Struktur verbessert, um einen höheren Ertrag per Flächeneinheit und nährstoffreichere Erträge zu erwirtschaften. In dieser Arbeit sollen diesbezüglich folgende Problemstellungen und Arbeitsaufgaben behandelt werden:

- Wie sieht die aktuelle Situation bezüglich Siedlungshygiene aus?
- Welche Organisationsformen zur Wiederverwertung von hygienisierten menschlichen Fäkalien in der Landwirtschaft sind möglich?
- Welche Rolle spielen Stoffflüsse bzw. Nährstoffkreisläufe in einer Kleinstadt wie Kisoro und welchen Veränderungen sind diese ausgesetzt?
- Kann der „Household-centred Approach“ (HCA), bei dem der einzelne Haushalt im Mittelpunkt der Intervention steht, einen Beitrag zu einer besseren Siedlungshygiene leisten?

Im Mittelpunkt dieser Arbeit steht Kisoro, eine rasch wachsende Kleinstadt im Südwesten Ugandas sowie das „South Western Town Water and Sanitation Project“ (swTws), ein dezentralisiertes Projekt der österreichischen Entwicklungszusammenarbeit (OEZA), zur Verbesserung der Wasserversorgung und der schlechten sanitären Situation vor Ort (Nalubega et al., 2001).

Die vorliegende Arbeit basiert auf die Kooperation der „Universität für Bodenkultur, Wien/Österreich“, und der „Makerere University, Kampala/Uganda“. Die Feldarbeiten und Untersuchungen vor Ort wurden in Zusammenarbeit mit zwei Studenten der Studienrichtung „Civil Engineering“, Felix Twinomucunguzi und Francis Yiga, sowie einer Studentin der sozial-wissenschaftlichen Fakultät, Anet Nuwagaba, durchgeführt. Nach einigen Tagen Feldaufenthalt verließ Francis Yiga unser Team und somit beendeten wir zu Dritt unsere Arbeit. Begleitet und betreut würde dieses Projekt vor Ort von Dr. Maimuna Nalubega und Florence Akiiki Asiimwe, Lektorinnen an der „Makerere University“. Für die Kooperation sowie Betreuung auf österreichischer Seite war DI Hans Schattauer verantwortlich.

### 1.3. A Personal View of the Historical Background

Since the sixties all over the world people have been talking about environmental pollution, exploitation and limitation of natural resources. The intake capacity and overloading of the natural environment with emissions and waste are a focal point of various discussions, due to effects of an intensive exploitation of the worlds' resources.

Environmental pollution in a wide range, which results in unhealthy living conditions takes its toll: every year about 3.3 million people die of avoidable diarrhoea diseases. In Africa approximately 80 million people are threatened annually by cholera, and further 16 million cases of typhoid are the result of inadequate sanitation facilities and contaminated drinking water (WHO, 1996). One in five person does not have access to safe and affordable drinking water, as well as every second person does not have access to safe and sufficient sanitation (Larsson, 2001).

The rapid urbanisation, resulting from fast population growth and migration into cities, are one of the urgent problems mainly in the South. Appropriate solutions and strategies are tried to be established, especially for issues like safe water supply and sanitation, food security or growing environmental pollution.

The metabolism of municipalities is defined by a massive flow of nutrients, being food, water or energy. These nutrients are transported from outside into cities and are brought back to the outskirts for disposal in form of waste or excrements (Esrey, 2001). In developing countries more than 90% of sewage is discharged without any treatment, entering the natural water cycle and therefore lowers the quality of the environment drastically. According to this, the urban citizens are facing a serious deterioration of their hygienic and health conditions. The victims and affected persons are mainly women and children.

A rapid population growth and uncontrolled expansion of the cities call for safe, sustainable and affordable sanitation solutions in the countries of the South. Especially poor societies in the urban, suburban and rural regions often have no access to the advantages of public supply of clean water and sanitary facilities.

Concepts were developed searching for generally valid solutions to the emerging problems. However, applicable strategies promising an overall solution are often found to be invalid. Concepts for modernisation for so called developing countries are still following a "top-down" strategy. Even though there are various reports about failed projects, going along with disastrous consequences and changes of local living conditions, old fashioned methods are still being applied. A "bottom-up" strategy, taking into account local knowledge and circumstances as well as empowerment on a local scale, only slowly finds its way to recognition by national and international institutions. The diverse local conditions are calling for projects, which foster locally adapted solutions. Skogsfors (2001) said in the opening speech to the 10<sup>th</sup> Stockholm Water Symposium: "It is important both to involve the local people and, at the same time, have a regional corporation with an integrated approach to land and water use [...]. It is a great challenge for the industrialized world to be a partner in this important dialogue and to find ways to contribute with resources so that effective methods can be found for those areas in the world where life-threatening water scarcity and sanitation have a high priority."

## 1.4. Aims and Scientific Questions

It is aimed to prove that adapted concepts of sanitation are valid as appropriate solution and improve peoples living conditions sustainably. Using dry toilets water usage is reduced and water pollution greatly avoided. It is shown that sanitised human excrements contain important nutrients, which can be integrated again in the natural ecological cycle as fertiliser of high quality. Hence, the fertility of soil and also its structure is improved, consequently achieving a higher yield as well as healthier and more nutritive food. The specific questions of research are:

- What is the actual situation regarding sanitation?
- What are the possibilities of organising recycling of sanitised human excrements in agriculture?
- How important is the metabolism and nutrient flow of a small town like Kisoro and what are the challenges they are facing in the future?
- Does the “Household-centre Approach”, which regards the single household as the focus of intervention, contribute to a better sanitation?

The focus of the following thesis is on Kisoro, a small but rapidly growing town in the South-west of Uganda, as well as “The South Western Towns Water and Sanitation” project (swTws). This decentralised project is carried out by the “Austrian Development Co-operation”, under an agreement between the governments of Uganda and Austria, to provide safe water and improved sanitation facilities to 19 small towns in the South-western districts of the country (Nalubega et al., 2001).

This study is based on a co-operation between the „University of Agriculture Sciences, Vienna/Austria“ and the „Makerere University, Kampala/Uganda“. Our team was composed of three students, Felix Twinomucunguzi and Francis Yiga, studying Civil Engineering, and for the social impact of our research Anet Nuwagaba was responsible. Unfortunately Francis Yiga decided to leave our team after a few days in the field, and so three of us finished the research. Our study as well as our fields visit was looked after by Dr. Maimuna Nalubega, Florence Akiiki Asiimwe, both are lectures from the “Makerere University” and DI Hans Schattauer, from the “University of Agriculture Sciences”, who was in charge of the entire co-ordination. Language barriers and cultural differences between me and the local population were overcome through this co-operation.

## 1.5. Outline

The thesis consists of 6 chapters:

Chapter 2 gives an overview of the country of Uganda, as well as a more detailed description of Kisoro District, Kisoro Town, the “South Western Town Water and Sanitation” project and “Kisoro Town Council Water and Sanitation Office”.

Chapter 3 concentrates on the methods used. It consists of (i) the description of Material Flux Analysis (MFA) for nutrient flow and nutrient cycle, (ii) the Household-centre Approach (HCA) and (iii) a description of Rapid Rural Appraisal (RRA) and Participatory Rural Appraisal (PRA).

Chapter 4 gives a brief overview of (i) Ecological Sanitation (EcoSan), (ii) the contents and composition of urine and faeces, (iii) the main principles of EcoSan, (iv) the potential of reuse of sanitised human excrements and (v) the ongoing EcoSan project in Kisoro.

Chapter 5 analysis (i) the current sanitation situation and the potential of recycling of sanitised human excrements as manure in agriculture in Kisoro Town. (ii) Furthermore MFA is described focusing on nutrient flows.

Chapter 6 shows possible scenarios of the reuse of human urine and faeces in Kisoro Town.

Chapter 7 includes a summary as well as conclusions of the thesis.

The informational background of various chapters are derived from different main sources. These parts are marked with footnotes.

## 2. REGIONAL BACKGROUND

### 2.1. Uganda

“Over the last 50 years, Uganda, once known as ‘the pearl of Africa’, has suffered dictatorship, economic collapse, and systematic human rights abuses. Yet today, Uganda is widely viewed as an inspirational economic success story, and as a symbol of a more vibrant, successful Africa” (Leggett, 2001).

#### 2.1.1. HISTORY<sup>1</sup>

“Uganda is a young country. The announcement of its creation and of its status as a British protectorate was published in the London Gazette in 1894. Unfortunately, most of the people who lived in the territory that was described to the world as being Uganda had never heard of the London Gazette, nor did a country called Uganda mean anything to them. Not surprisingly they felt no allegiance to an imperial creation whose borders cut across existing economic, political, and social relationships” (Leggett, 2001).

In 1962 Uganda kept became independent from Britain after nearly 70 years of colonialism. In the first years of independence the country possessed with rapid agricultural growth, a developing industrial sector and growing intellectual as well as cultural leadership.

However, the situation changed dramatically in the late 1960s when political instability followed the coup by Idi Amin in January 1971. Next to the fact that approximately half a million people claimed victims of his dictatorial regime, the country sank into an economical chaos and slipped into political isolation. In 1979 Idi Amin was overthrown by guerrillas from Exile–Ugandans together with Tanzanian troops, but the crisis continued in the following years.

By the time the National Resistance Movement (NRM) lead by Yoweri Kaguta Museveni reached the political leadership in 1986, Uganda had become one of the poorest countries in the world. The education and health systems had collapsed; the physical infrastructure had crumbled as well as the civil service had been destroyed due to low wages and poor moral. The economy was highly regulated and the state intervened in nearly all sectors. Real Gross Domestic Products (GDP) per capita lied by 42% below the level in 1970 because the public revenue base had collapsed, inflation was dramatically high and government expenditure, exports and investment has all fallen to below 10% of GDP.

In mid 1987 the government passed an economic recovery program aiming to reduce poverty by restoring fiscal discipline, monetary stability and further the rehabilitation of economic, social and institutional infrastructure. Consequently, the government worked consistently to implement and improve an economic reform program, including a wide liberalisation and reform policy, with the effect of a turnaround by 1992. The impact of a combination of government-led reform and development assistance lead to a stable economic situation. “But economic growth does not mean that all Ugandans have benefited from current policies. There has been a growth in inequality, and an increasingly common feeling that some people and some parts of the country are doing very nicely, while others are being left behind” (Leggett, 2001).

---

<sup>1</sup> Data are derived, if not marked in an other way, from following sources: Nohlen (2000) and The World Bank (2001).





Map No. 3862 Rev. 2 UNITED NATIONS  
December 1998

Department of Public Information  
Cartographic Section

Figure 1: Map of Uganda (UN, 1998).

### 2.1.2. PHYSICAL CHARACTERISTICS<sup>2</sup>

Situated in Eastern Africa, Uganda is covering a total area of 236.040 sq. km. In the South the country borders to Lake Victoria, Rwanda and Tanzania. Further to the Democratic Republic of Congo in the West, Sudan in the North and Kenya in the East (Figure 1). The highest peaks are the extinct volcano Mount Elgon (4.323 m) in the East, the Ruwenzori Mountains (5.119 m) in the West and the Virunga Volcanoes in the Southwest. Lake Edward and Lake Albert form natural borders to the Democratic Republic of Congo.

Due to its location along the equator Uganda has a tropical climate with two rainy seasons in most parts of the country. Only the Northeast is semiarid with extensive half-nomadic cattle breeding (Nohlen, 2000).

Forests and woodland cover about 28% of the land, 25% is arable land, and permanent crops as well as permanent pasture cover an area of 9% each.

### 2.1.3. DEMOGRAPHIC CHARACTERISTICS<sup>3</sup>

The population of Uganda is 24 millions (SWI, 2001) with an average population growth rate of 2.9% per year between 1994 and 2000. The majority of the population lives in the cultivable areas around Lake Victoria in the South of the country and profits from the richness of fish in the lake. About 15% of the total population lives in urban centres primarily in the capital Kampala (SWI, 2001).

Table 1 shows the big gap between developed countries on the one hand and developing countries on the other hand. The figures for Uganda point up that the country is one of the poorest world wide. About 35% of the population lives below the national poverty line. Life expectancy amounts only to 42 years and the infant mortality is 97 per 1.000 live birth. Fertility rate per women lies by 6.9 children, whereby only 2% of the population is older than 65 years. The rate of HIV infected adults between 15 and 49 years ranges around 8.3% , which is low compared to other East African countries (Zimbabwe 25.1%, Zambia 20%).

	Population projection (million)		Growth rate (%)	Fertility rate (children per women)	Infants mortality (mortality per 1000 live birth)	Life expectancy at birth (years)	Population >65 years (%)
	2001	2050					
developed Countries			0.1	1.6	8	75	14
developing Countries			1.6	3.2	61	64	5
Uganda	24	84.1	2.9	6.9	97	42	2

Table 1: Demographic indicators (SWI, 2001).

<sup>2</sup> Data are derived, if not marked in an other way, from following source: OEFSE (2001).

<sup>3</sup> Data are derived, if not marked in an other way, from following sources: Nohlen (2000) and The World Bank (2001).

#### 2.1.4. SOCIO - ECONOMIC CHARACTERISTICS<sup>4</sup>

The tropical climate in Uganda, apart from the dry Northeast, is favourable for agriculture due to substantial natural resources, fertile soils and regular rainfalls. Agriculture, which is dominated by small farms, is the most important sector of the economy. The agricultural sector employs over 80% of the work force. Approximately 40% of all agrarian products are produced for means of subsistence.

**socio-economic development.** In the past few years Uganda has emerged as robust economic performer. Real GDP growth has been around 7% per year over the past decade, underlying inflation has averaged by 6%. But figures from the World Bank (2001) point out, that the average annual growing rates have decreased in the years 1999 and 2000. In predictions for the year 2001 a lower growth rate is expected due to a decline in prices for coffee as well as crop failures.

Nearly 99% of all exports apportioned to agriculture. Coffee is the major export crop, accounting for over 50% of export revenues, whereby Uganda is the largest coffee grower in the continent. Furthermore tea industry is revitalising, a small horticulture industry is emerging and maize exports to Kenya are increasing. By promoting the agricultural sector, a diversification of the produced products is strived for (next to coffee, tea and cotton) with the aim of a constant growing economy.

The industrial sector has also expanded rapidly, with real output growth of nearly 12% per year in average over the past decade. The main part of processed products arise from local agriculture and industries, which are located in the regions around Kampala and Jinja.

In the last decade the country has been confronted with a serious debt problem. In order to reduce the country's external debt burden, Uganda was the first country to be declared eligible by the Heavily Indebted Poor Countries (HIPC) Initiative I and II in April 1998.

However, Uganda is still rated to be among one of the 20 poorest countries in the world. Its social indices such as per capita income, infant mortality rate, primary school enrolment, life expectancy and access to safe drinking water and sanitation leads to the poor Human Development Index (HDI)<sup>5</sup> of 0.435 (1999), which points Uganda to position 141 of the 162 least developed countries (UNDP, 2001).

---

<sup>4</sup> Data are derived, if not marked in an other way, from following sources: Nohlen (2000) and The World Bank (2001).

<sup>5</sup> "The human development index (HDI) measures human progress on the basis of human achievement in three broad indicators namely: longevity, educational attainment, and standard of living. Longevity is measured by life expectancy at birth, educational attainment by a combination of adult literacy and school enrolment ratio, and standard of living by real GDP per capita (PPP\$). The HDI is an aggregation of these key indicators of human progress. In numerical terms, the index ranges from 0 to 1 where 0 indicates total absence of human development and 1 indicates the highest level of human development" (UNDP, 1998).

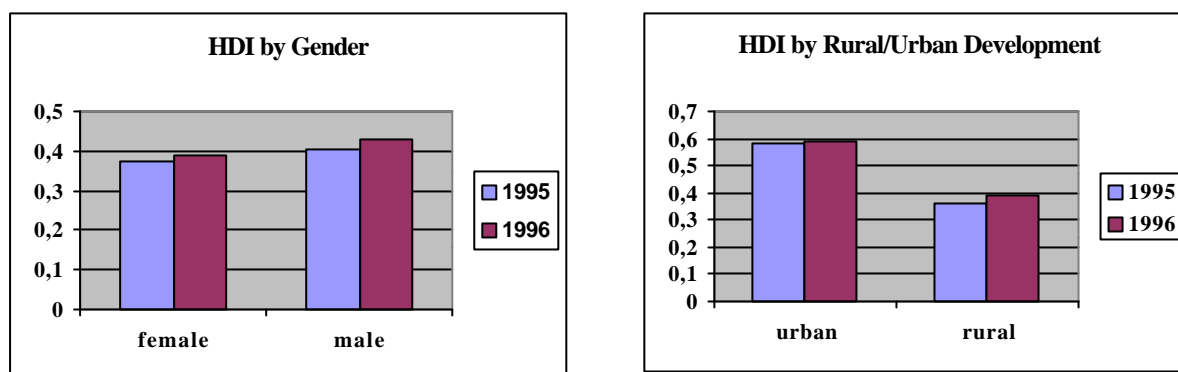

Figure 2: HDI separated for male, female, urban and rural population (UNDP, 1998).

By computing different human development indices on the basis of gender (Figure 2), wide disparities between men and women become evident. The HDI for men increased from 0.405 in 1995 to 0.428 in 1996. For women the index amounts to just 0.390 in 1996. The most notable factors for the significant gap remain to unequal access to income or the historic unequal opportunity in education (UNDP, 1998).

Analysing human development in rural and urban areas (Figure 2), the HDI for urban areas rose to 0.587 while in rural areas the index only amounts to 0.388. The difference in the level of income is the most crucial factor why rural areas are lagging behind the urban ones (UNDP, 1998).

**access to water and health services.** The huge development gap between urban and rural areas also reflect the differences in the access to safe water and health services (Table 2). Almost 60% of the rural population have neither access to safe water nor adequate health services. The most crucial disparity between urban and rural areas is the lack of access to health services, where 56% of rural dwellers compared to 5% in urban areas lack such access. For malnutrition the inequality seems to be better: 26.8% of the children in rural areas are malnourished in comparison to 15.3% in urban areas.

Due to the implementation of a program of Universal Primary Education, the illiteracy rate decreased from 52% in 1977 to 38% in the year 2000<sup>6</sup> (Table 2).

	Illiteracy (%)	No access to safe water (%)	No access to health services (%)	Malnutrition – underweight children (%)
Rural	43	58.6	56.5	26.8
Urban	16.4	23.2	5	15.3
National mean	38.4	51.1	51.0	31.8

Table 2: Deprivation in rural and urban areas (UNDP, 1998).

**sanitation.** Deprivations of sanitation facilities show a similar picture like for water supply and health services. In urban areas with 6% compared to the rural regions with 48% of the population do not have access to sanitation facilities (UNDP, 1998).

<sup>6</sup> Illiteracy rate in [% of population age 15+]

**political system.**<sup>7</sup> The Republic of Uganda consists of 45 administrative districts. On the 9<sup>th</sup> of October 1962 the country got independent from the United Kingdom and kept English as official language.

Since 1986 President Yoweri Kaguta Museveni is both chief of state and head of the government. The first public election for the presidency was held in 1996. The last elections were held in March 2001, where Museveni was re-elected for another five years period. Only a single political organisation, the National Resistance Movement (NRM), with President Museveni as chairman, is allowed to operate unfettered. Political parties are prohibited and the candidates for the next elections have to be independent.

A regional co-operation between the East African Community, which was revived in 1999, is actually responsible for a good relationship to Kenya and Tanzania. Dues to political as well as military involvement in Rwanda and conflicts in the Congo, instability and guerrilla fighting in border regions are still burdening the neighbour ship. The situation to the Sudan is also strained, accompanied with guerrilla activities (OEFSE, 2001).

---

<sup>7</sup> Data are derived, if not marked in an other way, from following source: OEFSE (2001).

## 2.2. Kisoro District

### 2.2.1. PHYSICAL CHARACTERISTICS<sup>8</sup>

**location.** Kisoro District is located in south-western Uganda (Figure 3), bordering Rwanda in the South and the Democratic Republic of Congo in the West. In the North and the East the districts of Rukungiri and Kabale adjoin, respectively. The district covers approximately an area of 729 sq. km of which 662 sq. km is land and the rest open surface water and swamps (Norplan, 1997). The District Administrative Centre, which is the Town Council is situated in Kisoro Town 510 km Southwest of Kampala City.



Figure 3: Location of the project area.

#### conservation areas.

**Bwindi Impenetrable National Park.** Covers an area of 331 sq. km located in the Northern part of Kisoro District and represents the remnants of a rich tropical moist forest. The major attraction of the park are Mountain Gorilla tracking tours. The National Park accommodate presumable half of the world's gorilla population. Furthermore the forest is the home of the Batwas Pygmies trip.

**Mgahinga Gorilla National Park.** Located in the Southern part of Kisoro District borders Rwanda and the Democratic Republic of Congo. The park covers an area of 33.7 sq. km including three extinct, dormant respectively, volcanic mountains, Mt. Muhavura, Mt. Mgahinga and Mt. Sabyinyo. The vegetation consists mainly of a mountain forest belt, a bamboo zone, an alpine zone and three extensive swamps in the zones between the volcanoes. As in Bwindi Impenetrable National Park Gorilla tracking is the main attraction, too.

**Echuya Bamboo Forest Reserve.** Covers an area of 702 ha and consists of 90% of bamboo forest. The rest of the area is covered with scattered plantations of cypress and pines.

**climate.** Kisoro District experiences two rainy seasons with heavy rains from March to May/June in which the peak rainfall is received. A secondary raining season is normally expected between August and October. The mean annual rainfall amounts to 1000-1250 mm. Temperatures are relatively low compared to the rest of Uganda, where the mean annual maximum is between 23°-25°C in the dry spell. Mean annual minimum is recorded between 10°-12.5°C, due to the high altitude of the region. However, in recent times rainfall has be-

<sup>8</sup> Data are derived, if not marked in an other way, from following source: Norplan (1997).

come unreliable and erratic, which seems to be a problem especially for farmers as well as for a sufficient water supply in the region.

Another decisive parameter are strong winds, especially during dry seasons and at onset of rainy season. Many crops are affected for instance bananas are staked or else they fall before maturity. In dry season dust storms become frequent, moving soil particle from roads and extensively cultivated areas.<sup>9</sup>

**soils.** In the South-western region the volcanic soils, composed mainly of volcanic ash, organic soils and humid ferrallitics, are among the most productive ones. The level of fertility is high due to the content's richness of organic matter.

**topography.** Kisoro District is located in a mountainous region with an average altitude of 1981 m a. s. l. The highest mountains are Mt. Mgahinga (3475 m), Mt. Muhavura (4127 m) and Mt. Sabyinyo (3645 m), bordering Rwanda in the southern part of the District. These three volcanic mountains are part of six extinct, dormant respectively, and two active volcanoes of the Virunga ranges, extending into Rwanda and the Democratic Republic of Congo. The volcanic ranges are interspersed by wide saddles with drainage valleys occupied by extensive swamps.

Most of the mountainous and hilly parts of the District, settlements are located in inter-ridge etched valleys, ridge saddles or on top of hills, which are free of flood during the rainy season. But most of the small villages can only be reached by foot paths and people have to transport their products in bamboo stretchers on their heads – a further hindrance to the development of the area.

**hydrology<sup>10</sup>.** Rivers in the region are short and most of them are perennial during rainy season. Most of precipitated water is absorbed by the porous and vesicular lava. Only a few permanent rivers and streams exist. Chuho river, which starts at Chuho spring, about 3.5 km north-east of Kisoro Town is the most important one. Water arises there over a length of about 18 m with an estimated yield of 80 l/s. Two additional small springs arise about 70 m north of the main spring. Chuho river flows more than half a kilometre on a hard and impermeable volcanic surface to the North before it disappears between fractured rock and finally flows into Lake Mutanda.

A second major river arises about 10 km west-north-west of Kisoro close to the boarder of the Democratic Republic of Congo at the Northern edge of the lava field at Nkanka. The Nkanka river leaves the lava field after a few hundred metres and continues its flow in a north-westerly direction.

Some minor small perennial streams exist high up in the mountains. From the Kabiranyuma swamp in the saddle between Muhavura and Gahinga a small stream emerges, which disappears in loose volcanic material. In 1948 a concrete structure was constructed, which channelled the water down the slope to supply the population of Nyaruzisa. In 1996 the system finally broke down due to a lack of maintenance. Furthermore, a stream is coming out of the Sabinio gorge, but disappears in loose volcanic material in a lower section of the mountain.

**land use.** About 75% of the land is arable land, about 21% is unproductive land (including tropical high forest, grassland, bushland, papyrus swamps and plantations), 4% cover open water bodies and approximately 0.3 percent are built up areas (Table 3). The arable land

<sup>9</sup> Compare with: Norplan (1997). p. 18/19.

<sup>10</sup> In 1996 TBW elaborated a hydro-geological study to gain a more detailed understanding of water flows in the region. Hydrological data are derived from this study.

is characterised by small-scale subsistence farming, with land plots of about 0.8 ha<sup>11</sup> (Department of Agriculture, 1998) where mainly beans, maize, sorghum, potatoes and bananas are produced.

	Area (sq. km)	Proportion (%)
Arable land	543.9	74.7
Unproductive land	155.3	21.3
Open water bodies	28.3	4.0
Built up areas	2.1	0.3
Total	729.6	100

Table 3: Land cover in Kisoro District (Norplan, 1997).

**environment and human impact.** The land was originally covered with open canopy mountain rain forest as found in Mgahinga National Park and Bwindi Impenetrable Forest National Park. The vegetation of the lowlands was naturally bamboo, small shrub and grass. Intensive deforestation activities have led to a reduction of natural forests remaining outside the conservation areas in the last decades. The human impact on vegetation through expansion of agricultural land, overgrazing, bush burning and over-harvesting of wood materials, including timber for fuel wood<sup>12</sup> faces the region with problems. Poverty and a high population density have compounded the situation and the pressure on vegetation, energy, agriculture development, soil conservation, wetland resources and environmental health has increased. One of the major struggles farmers suffer is soil erosion in addition to inappropriate farming systems. Wetlands have been drained for agricultural purposes leading to bio-diversity loss, microclimate change and lowering the water table.

**infrastructure and housing situation.** Missing or poor infrastructure are one of the main development problems in the region. Kisoro District has no tarmac road, apart from some roads in Kisoro Town. During the rainy season large parts become impassable and regions inaccessible due to the clay soils. The roads are obstacles especially for tracks to and from the Democratic Republic of Congo.

The housing situation has a direct relation to demographic changes. However, in recent years an improvement of housing standards in the urban centre of Kisoro can be mentioned while in rural areas standards and quality of housing are still low. Four types of houses are common in Kisoro District (Norplan, 1997):

- Traditional non-upgradable houses constructed of mud and wattle, then thatched with grass, especially sorghum stalks and papyrus.
- Upgradable traditional houses made of mud mixed with cement or dried bricks with poles and iron sheets. This type is mainly found in the suburbs of Kisoro Town.
- Semi permanent houses are commonly constructed of sun-dried bricks, walls with rough-cast and a roof of iron sheets with an ordinary foundation.
- Permanent houses made of brick walls, stones, cemented floor, iron sheet or tiled roofs are common in the centre of Kisoro Town and for a few rich families in rural areas.

<sup>11</sup> Based on dates from the Environmental Profile Report for Kisoro District the average land-holdings per farm family amounts to 1-2.5 ha.

<sup>12</sup> Wood fuel is the main source of energy (94%). Collected from plantation wood lots, bushes and any other existing vegetation cause deforestation, hence, land degradation is a major problem.



“Most of the already constructed houses lack adequate sanitary facilities especially pit latrines, given the presence of hard basement rock underground that makes construction difficult” (Norplan, 1997). The difficulties of digging as well as space scarcity are the major problems concerning the sanitation part. The spaces of the courtyards are limited and an expansion proves to be very hard.

### 2.2.2. DEMOGRAPHIC CHARACTERISTICS<sup>13</sup>

Kisoro District is one of the most densely populated districts in Uganda, with a population density of 301 persons/sq. km in 1991 while the country’s average amounts to 85 persons/sq. km. The majority of people, about 96%, live in villages and small trading centres while the remaining 4% are urban dwellers. The average growth rate of 3.5% lies over the national average of 3% as well as infant mortality of 105 individuals per 1000 live birth is still over the countries level.

A comparison of different Human Poverty Indexes (HPI)<sup>14</sup> shows clearly the big gap between various regions of Uganda (Table 4). An HPI of approximately 52% in Kisoro District is chiefly based on a higher illiteracy rate, a higher percentage of people without access to safe water or health services like the average of the country (39%).

(%)	Illiteracy	No access to safe water	No access to health services	Malnutrition – underweight children	HPI
Kisoro	67	76	34	30	52
Kabale	48	42	29	30	39
Uganda	38	52	51	32	39

Table 4: District human poverty profile (UNDP, 1998).

Low status of family planning methods with a low education level, inadequate health services and the fact, that the community is polygamous where the majority of men have more than two wives (an average of 10-15 people per household) are mainly responsible for this situation. The consequences are obvious: population pressure resulted into land fragmentation. Farmers are forced to cultivate steep hillsides, which has increased the threat of soil erosion hence environmental degradation.

**ethnic composition.** The area is mainly occupied by the Bufumbira, which is 68% of the total population, followed by Bakiga with 16%, Banyarwanda approximately with 15% and other smaller significant ethnic groups, like the Batwas (Pygmies), who lived in the forest ecosystem as hunters and gatherers. Nowadays most of them have changed their life style and are involved in agriculture.

<sup>13</sup> Data are derived, if not marked in an other way, from following source: Norplan (1997).

<sup>14</sup> The human poverty index for development countries (HPI) concentrates on deprivations in three essential dimensions of human life already reflected in the HDI – longevity, knowledge and a decent standard of living. While the HDI places emphasis on achievement, the HPI concentrates on deprivation or exclusion in these three broad areas of human life. The deprivation in a decent living standard, this is determined jointly by the proportion of the population without access to safe water, health services, and of moderately and severely underweight children under five (UNDP, 1998).

**migration.** Periods of civil unrest in Uganda, Rwanda and the Democratic Republic of Congo have greatly influenced the population growth in Kisoro region. The country's political instability in the second half of the last century is mainly responsible for migration activities in the area. Between 1994 and late 1996 wars that broke out in Rwanda and in former Zaire, disturbances and fighting spilled over into Kisoro District leading to influx of refugees and emigrations. On the other side migration from the region to other parts of the country is the consequence of land shortage and the lack of jobs.

**health.** Most of the health problems are a result of poor living conditions, no access to health care facilities combined with a poor health education. The key cause of infant mortality in the rural areas of Kisoro District is malnutrition, diarrhoea and intestinal worms. A lack of clean drinking water, poor sanitation and nutrition among children are responsible for an exceptionally high infant mortality rate. However, in general both the quality and availability of health services have increased in the last years due to various health programmes.

**education.** According to the Population and Housing Census in 1991 the illiteracy rate in the District lies by approximately 67%, well above the national level of 38%. Through the introduction of Universal Primary Education the situation has rectified in the last decade, but is still not reaching the national mean.

### 2.2.3. SOCIO - ECONOMIC CHARACTERISTICS<sup>15</sup>

**employment structure.** The economy of Kisoro District is one of the least developed in the country due to rough mountainous terrain, poor communication routes as well as low household income, which has consequently affected the level of a narrow tax base. The major economic activity is agriculture (cultivation with little livestock keeping) where production bases of subsistence nature with a very low income.

Only a few local people are engaged in small scale cottage industries dealing in carpentry, woodwork, metal fabrications, mechanical repairs and crafts like mats, granaries, baskets and some fishing. The local blacksmiths make knives, spears, slashes and single forked hoes for cultivation on stony soils.

Some households depend on making local brew: "Umusululu" made of sorghum and "Tonto" made of bananas are for sale in small bars.

Tourism, especially Gorilla tracking in the National Parks is a small additional business for the locals, as guides or game rangers. Next to revenues accrued from National Parks entrance fees and guided Gorilla tracking managed by Uganda Wildlife Authority, communities have set up additional income sources such as craft shops, restaurants and lodges.

#### **public services.**

**water supply.** This parameter is mainly affected by the regions location. Situated in the lava fields at the Northern foothills of the three most eastern Virunga mountains, large parts are characterised by the absence of available water resources, due to the high porosity of the volcanic rocks. Precipitation infiltrates rapidly into the ground leaving especially the higher regions without accessible permanent water sources (TBW, 1996). However, both, surface and underground water resources are found in the District as well as crater lakes and a network of permanent swamps, whereas many of them are under cultivation.

<sup>15</sup> Data are derived, if not marked in an other way, from following source: Norplan (1997).

The main sources of domestic water supply is dependent on rainwater tanks, gravity water flow schemes and unprotected natural sources. During dry season (June/July) especially seasonal wetlands dry up forcing people to travel up to 10 km for permanent sources (Picture 1). One of the problems in the region is the difficulty of drilling boreholes in the hard volcanic rocks and leaves runoff as the most important source of domestic water. The mountainous terrain mainly in the central parts of the area is influenced by water scarcity.

Kisoro Town Council gets piped water generated from Chuho spring well, a few kilometres away from town, which reaches only a population coverage of 18% (July 1997) served with clean water, the rest of the population depend on unprotected water sources. The situation is changing over time, due to several organisations, like CARE, UNICEF, the Austrian Development Co-operation or the local government, which try to ensure safe drinking water.

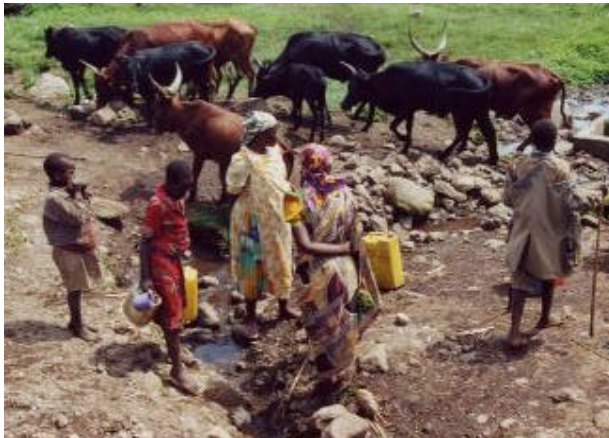

Picture 1: People and animals sharing one spring.

**sanitation.** The sanitation coverage in the District reflects a poor situation by the year 1997. Just fewer than 60% of the households had access to sanitation facilities, mainly pit latrines. The situation in Kisoro Town, with 72% coverage, seems to be better than in the rural areas, but the facilities are often inappropriate.

**energy.** The main energy source (94%) is wood fuel for both rural and urban households. The sources of firewood are mainly from woodlots, bushlands and crop residues like sorghum stalks. Charcoal covers only a small part of energy consumption, primarily for urban centres for cooking. The District is also supplied with electricity from Rwanda. Much of it is used by hospitals, public institutions, water works and maize mills while only small amounts are domestically used.

**waste management.** Kisoro Town and the rest of the District offers no proper waste and sewage management. The town has no garbage collecting system thus the growing amount of waste remains as problem in private hands and leaves individual households to dispose garbage or domestic waste in uncontrolled, often environmentally pollutant ways. A huge part of the refuse is burnt next to peoples houses or dumped somewhere in the landscape. Garbage heaps produce bad odour and are habitats for rats and houseflies, which are responsible for carrying disease pathogens. Stinking places where people are looking for useable things and animals searching for eatable waste are a growing hygienic risks. For peasants or households with agricultural activities recycling of organic waste has always been wide spread. In the country side domestic garbage has never been a problem. All the produced waste was of organic matter and reusable. In the last years the composition of the refuse has been changed as well as the dumping and collecting situation. Still the most com-

mon way for handling the material is dumping into pits, feeding of livestock and using it as organic manure. With the change of housing conditions and the lost of individual fields and gardens, the possibility of reusing the organic waste in an environmental friendly way is decreasing.

#### 2.2.4. AGRICULTURE<sup>16</sup>

Agriculture is the main land use in Kisoro District and a major economic activity that employs nearly 95% of the total population. Almost 90% of the household population have their main source of livelihood in subsistence farming. The majority of the rural farmers are small holders with an average land-holding per farm family of 0,8 ha<sup>17</sup> (Department of Agriculture, 1998). Commercial farming covers only 0.3% of the total land area and the livestock husbandry is mainly limited to a few animals for home consumption. The steep fields on the slopes of the hills as well as shortage of land admit chiefly traditional agricultural techniques. Mostly women are cultivating the small land plots with the use of hand tools like simple hoes, pangas and forked hoes.

**cultivated crops.** The crops grown in the District are mainly annual food crops, dominated by beans, sorghum, sweet potatoes, Irish potatoes, maize, field peas, wheat, bananas, and vegetables like cabbage, onions and tomatoes. On a small-scale also perennial crops such as coffee, tobacco, and tea are found, but these crops are not playing an important role at the moment. Much of the produced crops are consumed by families, sometimes leaving little surplus for sale to increase the families income. The major cash crops are peas, Irish potatoes and sorghum. Of particular importance in the region are sorghum and bananas for making local brew, which is sold in bars.

**crop yields and production.** The fertile volcanic soils in the region support a wide variety of crops. However, average crop production has declined in the past years mainly due to serious soil erosion. On the other side vegetable production has been increasing steadily, especially in valley bottoms where eroded material from up-slopes is deposited. Government policies encourage the cultivation of non-traditional cash crops for export. One example is the “Uganda Coffee Development Programme”: peasants are growing coffee plants for giving the crops to interested farmers. In return the government pays for every plant 200 Ugandan Shilling. The Environmental Profile Report of 1997 comprises a sentence, which represents the current situation very clearly: “The increase in agricultural production should be achieved through intensifying farming methods rather than focusing on expanding the area under cultivation by clearing of forests and swamps whose consequences are disastrous to the natural resource base of the District.”

**agricultural inputs.** The very fact of the high altitude of Kisoro determines the farming systems. The use of agro-chemicals is limited to very few farmers. A member of a local farmer organisation said, that they are starting to promote the use of chemical fertilisers. With field trails they want to demonstrate the advantages to persuade the local farmers. However, the actual situation is responsible that the use of chemicals is uneconomical due to small-scale farming and high prizes. Almost all farmers adhere to old traditions like the uses of their own seeds saved from the previous season to retain independence.

<sup>16</sup> Data are derived, if not marked in an other way, from following source: Norplan (1997).

<sup>17</sup> Based on dates from the Environmental Profile Report for Kisoro District the average land-holdings per farm family amounts to 1-2.5 ha.

**constraints in agricultural production.** Farmers in Kisoro District struggle with different problems affecting crop production: land degradation through soil erosion, poor and unimproved technologies for crop production, pests as well as other diseases, land fragmentation due to a high population density, and land shortage in general just as inheritance rules, which sub-divide family land among all surviving adult sons. Most of the families hold several tiny plots, which are a few kilometres apart and spend much time by travelling from one plot to another.

Land over-uses without fallow periods, insufficient soil conservation practices lead to land fertility. The problem of pests and diseases comes from continuous growing of crops on the same piece of land. A further set back for a more efficient agriculture lies in poor infrastructure for marketing produces and poor credit facilities. The local market in Kisoro is the main location for the farmers to sell small surpluses from their agricultural activities. On the weekly market days mainly women are coming from all over the villages in the region to Kisoro (Picture 2). Principally by foot, shoeless, with big heavy baskets on the heads or by bicycles. They cover wide distances to reach the market on Mondays and Tuesdays. Low market prices particularly at harvest season and lack of proper storage facilities force farmers to sell their products at give away prices to prevent from post-harvest losses.



Picture 2: Local market in Kisoro Town.



### 2.3. Kisoro Case Study<sup>18</sup>

**the town.** The designated urban centre of Kisoro District is Kisoro Town (Picture 3) situated in Bufumbira County a few kilometres from the borders of Rwanda and the Democratic Republic of Congo at an altitude of 2000 m a. s. l. The municipality lies in a valley surrounded by the Virunga Volcanoes in the South, Mt. Mgahinga, Mt. Muhavura and Mt. Sabyinyo as well as hills to the West, North and East.



Picture 3: The urban centre of Kisoro Town.

Table 5 and Table 6 show the estimated population growth of Kisoro Town from 1991 to 2015. During the 1991 national census the population of Kisoro Town Council was 7485. Local census up to 1996 carried out by the District Population Office estimated a population of 9.306 by 1996 with an average growth rate of 4.5% (TBW, 1999).

	Population	Growth Rate (medium sce- nario) (%)	Density (habitants/sq. km)
1991-	7 485		619
1996	9 306	4,5	769

Source: The 1991 population census and district profile series 1996 (TBW, 1999).

Table 5: Evaluation of Kisoro Town population between 1991-1996 (TBW, 1999).

TBW worked out scenarios of population growth till the year 2015. The forecast bases on date from the year 1991, estimated by the national census. TBW expects an annual growth rate of 4% till 1997. By this time 13 303 people should have lived in Kisoro Town. Till 2015, they expect a reduced growth rate of 3.5%, and by than the municipality should count 18 764 inhabitants.

<sup>18</sup> Data are derived, if not marked in an other way, from following source: Norplan (1997).

1997-	9 720		803.31
2005	13 303	4.0	1 099
2005-	13 303		1 099
2015	18 764	3.5	1 551

Source: TBW forecast, 1999.

Table 6: Forecast of Kisoro Town population between 1997-2015 (TBW, 1999).

**urban development.** Kisoro's urban structure is dominated by houses made of sun-dried bricks, volcanic plugs and stones or burnt bricks. In the most cases the roofs are of iron sheets, very few are covered with burnt clay tiles. Most of the houses have a small courtyard surrounded by three or four walls. The use of the patio varies from living space, kitchen to home gardens for planting some vegetables and fruits.

In the last years the municipality is still growing. People looking for jobs shift from small villages in the surrounding area to Kisoro Town. With the upcoming buildings and trading centres, the local urban authority supervises housing construction, which is dominated by the private sector.

In the last years the city growth took place around the core of the town, along the main connection road from Kabale to the borders of Rwanda and the Democratic Republic of Congo (Figure 4).

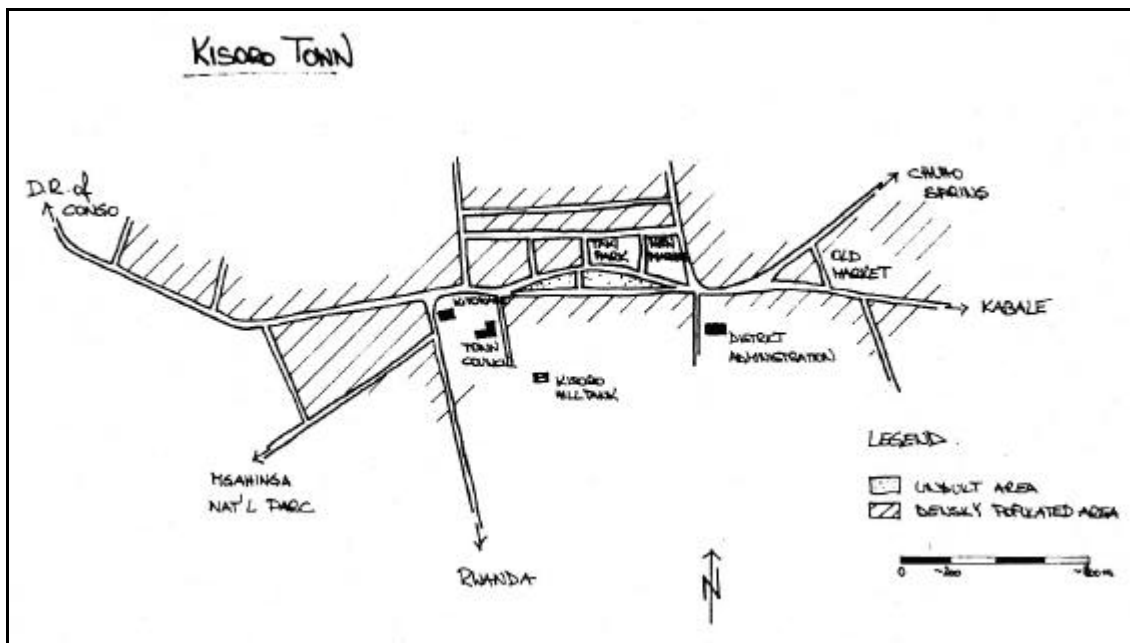

Figure 4: Map of Kisoro Town Centre.

The infrastructure improved in the past years like with a new taxi park, a new market, water stand posts and small family owned shops. With high building activities around the town, a better infrastructure has become an urgent demand with improvements in sanitation, water supply and garbage collection.

### 2.3.1. BACKGROUND INFORMATION<sup>19</sup>

**criteria for selection.** Kisoro Town was chosen as case study community because of a variety of reasons. The local situation concerning the hydro-geological situation, the poor sanitation coverage and above all the existing water supply and sanitation project were the main selection criterion. Furthermore, the ongoing EcoSan project and the actual state of affairs can be mentioned as main reasons.

#### 2.3.1.1. Kisoro within the South Western Town Water and Sanitation Project (swTws)

In 1986 the Government of Uganda worked out a programme to avail safe water within reasonable distances for everybody by the year 2015. Therefore in early 1990 the Government of the Federal Republic of Austria pledged to assist the Government of Uganda among others in the water and sanitation sector to reach this target.

Five years later, 1995, experts from the Department for Water and Wastewater Engineering, Industrial Waste Management and Water Pollution Control at the University for Agriculture Sciences in Vienna came to work with the Government of Uganda in the Southwest, to identify and formulate a project. By the end of the year a water supply and sanitation project had been formulated for 19 growing centres in the South-western districts of Uganda, namely Kisoro, Kabale and Rukungiri. Later the project was to extend into the districts of Ntungamo and Bushenyi.

swTws with its main office in Kabale, was founded in 1996. The project is run under the Rural Town Water and Sanitation Programme of the Directorate of Water Development of Uganda.

#### 2.3.1.2. Kisoro Town Council Water and Sanitation Office (KITOWASO)

In 1996 consulting engineers of Austria (from Technical Bureau Weidl -TBW) elaborated a hydro-geological study to trace and define Kisoro Districts potential water resources with regard to built a new water supply and sanitation system. The study clarifies the urgent need of the project, conclusively the main points (TBW, 1996):

- Kisoro, which is situated in the lava fields of the Virunga volcanoes, is characterised by the absence of surface water. Rainfall in the region is high, but precipitation infiltrates rapidly into the ground due to the high porosity of the volcanic rocks. However, water arises again in the lower parts of the lava fields leaving higher regions without permanent water.
- The catchment boundary lines of Chuho and Nkanka springs are not easily defined due to the complex geological situation.
- Kisoro Town is located in the catchment area above Chuho spring. The unknown geology makes it impossible to predict the underground path of water infiltrating at Kisoro. Therefore the pollution risk from the town cannot be estimated.
- Further springs with a yield high enough to supply Kisoro Town could not be found in the area. Water for the municipality has therefore to be pumped against a head of about 110 m from Chuho spring.

<sup>19</sup> Data are derived, if not marked in an other way, from following source: Hoellhuber and Nyiraneza (2001); Nalubega et al.,(2001); KITOWASO (2001); TBW (1996); TBW (2001).



- Drilled boreholes, to produce water without pollution risk from Kisoro Town, would be necessary. However, the geological conditions avoid the selection of favourable drilling sites. Furthermore, water quality seems to be poor and drilling cost would be very high due to the hard volcanic ground.
- The municipality has a poor sanitation coverage; mostly pit latrines in dirty and inappropriate conditions.
- Kisoro Town has no properly working sewage system. Lacking pit latrines endanger the only water source in the region.
- For pit latrines it is necessary to dig a pit into the ground. In Kisoro District these pits are usually not very deep, because of the rocky volcanic ground where digging is normally hard work.

From 1996 till 2000 TBW has elaborated feasibility studies to build the current integrated water supply with 13 public kiosks and standposts (Picture 4), sanitation and sewage treatment. For the operation and maintenance Kisoro Town Council Water and Sanitation Office (KITOWASO) was found. Since September 2000 this organisation is existing in the actual form, with a self-sustaining of the project. Selling the water for 25 Ugh. Shillings per jerrycan should guarantee independence from extern supports.



Picture 4: Public water kiosk – old market and new market Kisoro Town.

### 3. PLANNING METHODS

Three fundamental methods have been chosen for application in this study. The following section gives a brief introduction to the used methods: (i) The Material Flux Analysis (MFA) to describe nutrient flows in Kisoro Town. (ii) The Household-centre Approach (HCA), which helps to establish a decentralised sanitation system and (iii) the Rapid Rural Appraisal (RRA), Participatory Rapid Appraisal (PRA) respectively, as research technique in the field.

#### 3.1. Material Flux Analysis

Recourse depletion and environmental pollution is expected to arise in the next decades as a huge problem in developing countries. An increasing consumption combined with an increase in industrialised products and a rapid population growth are the main pressure factors for the environment. Experiences demonstrate that the identification of various problems lag behind in most cases. For reversing this trend, the MFA - method was developed by Baccini and Brunner (1991) as suitable instrument for a timely recognition of the potential accumulation or depletion of materials in the environment. Furthermore, this method helps to identify the most effective points of control of harmful concentrations and flows. Finally, by applying MFA an integrated resources and environmental management plan can be worked out (Lampert, 2000).

First methodological descriptions of MFA, as a method to study the regional metabolism, was published in the early 1990. MFA is a method to determine, describe and analyse the metabolism of e.g. industries or regions. The objective is to analyse fluxes of different materials in a defined space and time frame.

For industrialised countries, studies show that by combining data from market research with data from urban waste management the metabolism of urban regions can be observed (Binder, 1996).

The metabolism of a defined region can be described by four basic categories of processes (Figure 5), (Binder, 1996):

- *Supply* with natural resources from the region itself imported goods from other regions.
- Process of *production* and *consumption*: Upon the natural resources of the region goods are produced. Imported and produced goods are consumed.
- Through *waste management* produced products from other processes are cleaned, and end-products are contained or re-channelled.
- Processes in the *environment* consisting of soil, water and air.

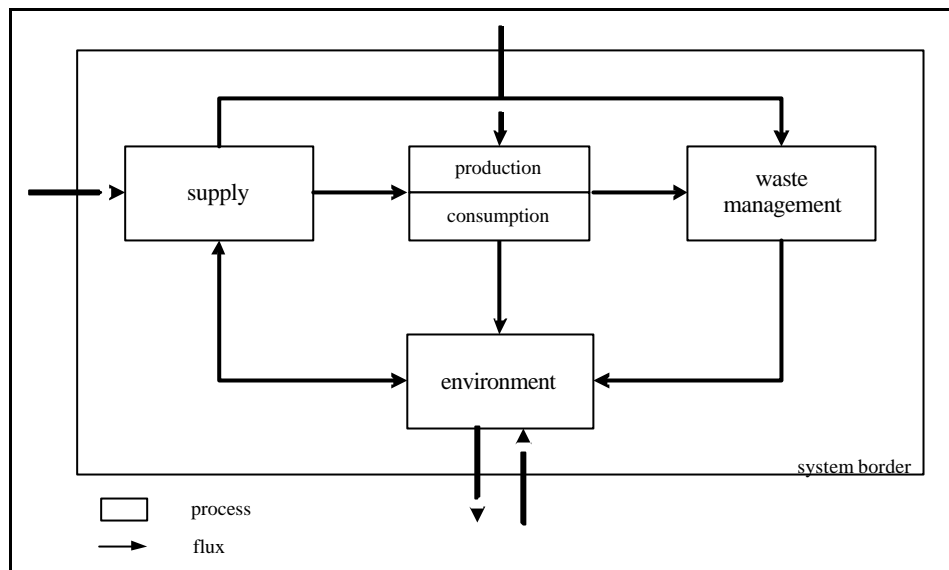

Figure 5: System analysis of a region (Binder, 1996).

The required output depend on the selection of the system border, processes and goods. The system borders can be defined as the geographic, political or any other useful boundary of a region, municipality or a certain catchment area. Water, food, consumers, durables or energy can serve as sub-system.

MFA evaluates different parameters of a chosen sub-system. E.g. an analysis for waste has to focus on supply processes, quantities and the composition of consumed durables. The early recognition of environmental impacts, the demand on resources and the evaluation of measures have to be based on different scenarios, e.g. which may be the impact of a growing population or the increase of durables and packaging. Based on different scenarios, forecasts for the future can be made to work out specific improvements.

Often the application of MFA should lead to concepts for a sustainable reduction of environmental pollution. An exact description of the method can be found in various publications of Baccini et al. (1991) or the thesis of Binder (1996).

### 3.2. The Household-centred Approach

In February 2000 a group of experts met in Bellagio (Italy)<sup>20</sup> to review the actual situation in sanitation and to identify ways to overcome problems. Following Bellagio-Principles (Figure 6) have been worked out as fundamental basis for a new approach (Schertenleib, 2000):

1. Human dignity, quality of life and environmental security at household level should be at the centre of the new approach, which should be responsible and accountable to needs and demands in the local and national setting.
  - Solutions should be tailored to the full spectrum of social, economic, health and environmental concerns.
  - The household and community environment should be protected.
  - The economic opportunities of waste recovery and use should be harnessed.
2. In line with good governance principles, decision-making should involve participation of all stakeholders, especially the consumers and providers of services.
  - Decision-making at all levels should be based on informed choices.
  - Incentives for provision and consumption of services and facilities should be consistent with the overall goal and objective.
  - Rights of consumers and providers should be balanced by responsibilities to the wider human community and environment.
3. Waste should be considered as a resource and its management should be holistic and part of integrated water resources, nutrient flows and waste management.
  - Inputs should be reduced so as to promote efficiency and water and environmental security.
  - Exports of waste should be minimised to promote efficiency and reduce the spread of pollution.
  - Wastewater should be recycled and added to the eater budget.
4. The domain in which sanitation problems are resolved should be kept to the minimum practicable size (household, community or town, district, catchment area) and wastes diluted as little as possible.
  - Waste should be managed as close as possible to its source.
  - Water should be minimally used to transport waste.
  - Additional technologies for waste sanitation and reuse should be developed.

---

<sup>20</sup> Bellagio Expert Consultation 1-4 February, 2000. Bellagio, Italy.

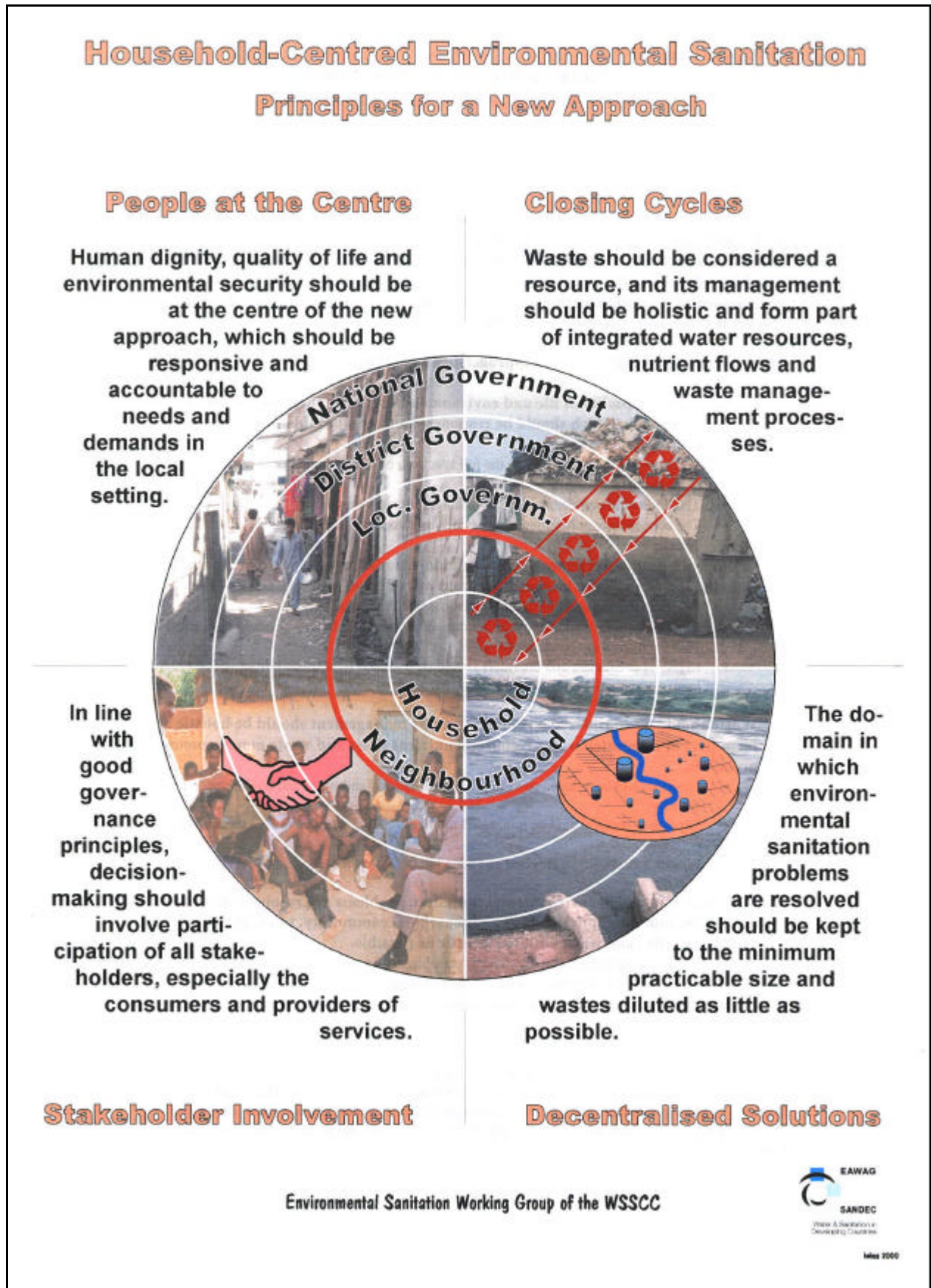

Figure 6: The Household-centred Environmental Sanitation – the main principles (Schertenleib, 2000).

Schertenleib and Wehrle (Coad, 2000) said in the introduction to the 16<sup>th</sup> SKAT-Aguasán Workshop<sup>21</sup>: “In many instances, efforts have been made to decentralise the functions of central government and to give local communities the responsibility for running their own services. Demand-responsive approaches are advocated, requiring the choice for technologies to be in the hands of the people concerned.” Next to the fact, that messages concerning failed projects, cases where services have not improved and where situations have been deteriorated have increase in number. Hence, new and improved concepts are necessary. The Household-centred Approach (HCA), the Household-centred Approach for Environmental Sanitation<sup>22</sup> (HCES) respectively, describes a new approach in the water supply and sanitation sector, which should help to avoid mistakes from the past.

**the household-centred approach.** The HCA refers to a concept in a general sense, which can be applied to a variety of development issues, e.g. in the water supply and sanitation sector as well as in other fields like forestry and road maintenance.

**the household-centred approach for environmental sanitation.** The HCES is an application of the HCA and denotes the HCA applied to Environmental Sanitation, whereas so far the main attention is given to the sanitation sector.

**the basic idea.** The conventional way in decision making is based on highly centralised systems, usually under control of the national governments (Figure 7). The HCES is a fundamental departure from central planning approaches. The idea behind the method consists of an emphasise of the household, reversing centralised top-down planning. “This model takes as its fundamental premise the need to put people and their quality of life at the centre of any environmental sanitation system, and it suggests that the first steps to solve problems should be taken at the lowest possible level (e.g. by the household)” (Coad, 2000). Households as focal point of finding decisions should guarantee a better and more improved resource management. Users, their opinions and demands should be regarded. Problems should be solved next to the arising source and should only be exported to the following zone (which reaches from household to the nation) if its really necessary. Only not manageable responsibilities should be exported to the next circle, neighbourhood, community and so on up to the largest level. A further focus is put on the empowerment of women. With the household as key stakeholder women are provided with more rights in planning processes.

<sup>21</sup> 16<sup>th</sup> AGUASAN Workshop, 26-30 June, 2000. Switzerland.

<sup>22</sup> In connection with the Household-centred Approach the term environmental sanitation is used. In other parts of this thesis the term ecological sanitation includes environmental sanitation.

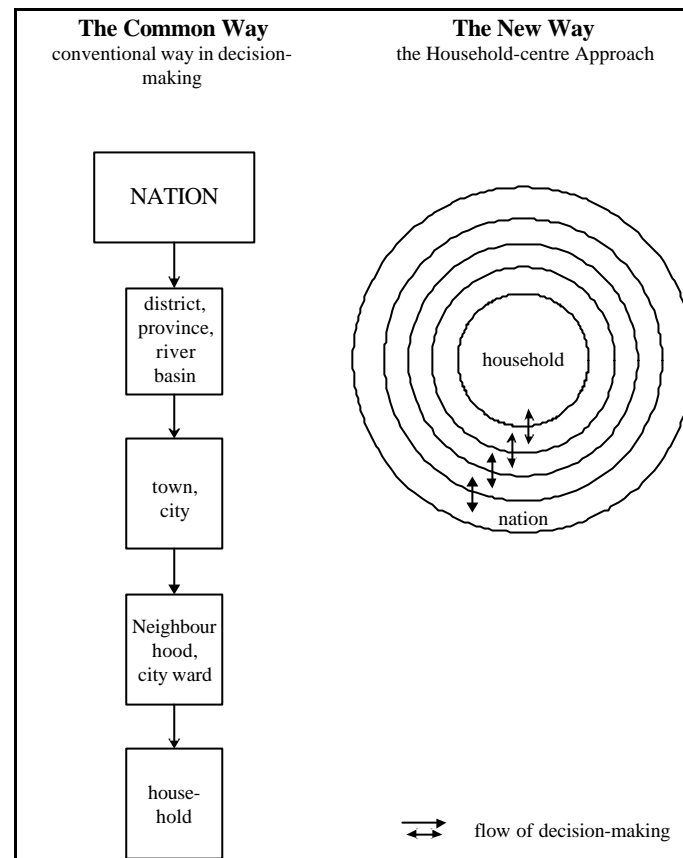

Figure 7: Decision-making systems (Schertenleib, 2000).

**how it works.** One of frequent mistakes in development projects are to disobey the user demands. The HCES represents a different planning approach with numerous principles for appropriate improvements (Schertenleib, 2000):

- Stakeholders are members of a zone and act in that level. The border of a zone may be defined by political boundaries, reflect common interests or physiographic border lines such as river basins or watersheds.
- Decisions are reached through consultations with all affected stakeholders in accordance with the methods selected by the concerned zone: e.g. town hall meetings at local level or informal discussions at neighbourhood level.
- Problems should be solved as close as possible to their source. The affected level is responsible first.
- Decisions and responsibilities flow from the household to the community, further to the city and finally to the central government.

Minimising waste transfer across circle boundaries and maximising recycling and reuse activities within each circle are further important principles of the HCES.

**requirements.** The HCES is a complex and time-consuming method, which has to integrate many aspects of development: institutional, social, economic, financial and technological aspects. Implementation takes time because of the need to inform households, to discover their opinions, to involve all major stakeholders in different zones. However, in the long term the benefits are obvious: sustainable solutions as well as closed cycles within each zone.



### 3.3. Analysis of the Social System<sup>23</sup>

Participatory Rapid Appraisal (PRA) as a specific form of Rapid Rural Appraisal (RRA) was developed in the late 1970s and early 1980s as an alternative and complement to conventional sample surveys. These research techniques have the purpose to gain an understanding of the complexities of a topic rather than highly accurate statistics. Especially pre-designed and fixed questionnaires do not allow progressive learning during data collection in the field and make it difficult to gain an insight of social processes. PRA and RRA are a way of learning from and with community members to investigate, analyse and evaluate constraints as well as opportunities.

#### 3.3.1. RAPID RURAL APPRAISAL (RRA)

The main advantages over conventional survey research are seen in the involvement of communities, the short duration and low cost. Furthermore, RRA embodies the principle that people perceive and understand reality in different ways. Community members and people from “outside” realise and interpret local situations in unlike ways. Thus, this research technique is characterised by a holistic and flexible approach of progressive learning conducted by multi-disciplinary teams and emphasising community participation. By now RRA methods have found widespread application in various fields and different studies.

#### 3.3.2. PARTICIPATORY RURAL APPRAISAL (PRA)

PRA was developed on the base of RRA. It represents a way of stimulating and encouraging communities to analyse their problems themselves. By involving the field team and community members in all aspects of the study, from the design of the research tools, the collection of information to the analysis of the findings a sustainable project should be developed.

PRA is based on few main features, to form the necessary framework for the used methods (Grady and Theis, 1991):

- **Triangulation:** A form of cross-checking in relation to the team composition (multidisciplinary, men and women, “insiders” and “outsiders”), variety of sources of information (people, places, events and processes), and a mix of techniques and tools.
- **Flexibility and Informality:** Plans and research methods are semi-structured and can be revised, adapted and modified.
- **Community:** The main aspect is participation, learning from, with and by the community members. Involving “insiders” and local specialists can greatly facilitate interpretation, understanding and analysis of collected data.
- **Optimal Ignorance and Appropriate Imprecision:** The team avoids unnecessary detail, accuracy and over collection of data.
- **On-the-Spot-Analysis:** Learning and analysis of information take place in the field, they are an integrated part of the fieldwork itself.
- **Offsetting Biases and Being Self-Critical:** The researches actively seeks out disadvantaged groups such like the poorest, children, women in remote areas, during every time of the year, at any time of the day to avoid talking only to the well-off, the better educated, the

<sup>23</sup> Data are derived, if not marked in an other way, from following source: Grady and Theis (1991).



articulate and men. The team reflects on what is said and not said, seen and not seen, who is met and not met and tries to identify sources of self errors.

### 3.3.3. TOOLS OF RRA AND PRA

The use of various tools of RRA and PRA instruments depend mainly on local situations. An adaptation on new situation as well as flexibility of the used tools is one of the important advantages over other techniques.

A short summary of successfully applied tools of RRA and PRA (Schönhuth and Kievelitz, 1993):

**secondary data-review.** Secondary data are sources of background information available in documented form, concerning the project area. This data includes documents, reports, statistics, maps, aerial photos, films as well as articles of newspapers.

**key indicators.** With the aid of key indicators it should be possible to describe the central problems concerning e.g. wealth, family structure or access to recourses.

**semi-structured interview.** The semi-structured interview is one of the most important instruments of RRA and PRA: It is a form of guided interviewing, using some predetermined questions. During the interview flexibility is the main factor. If it becomes apparent, questions should be skipped or formulated in a new way. This tool includes:

- Community interviews in which the whole community or village is invited to contribute with their own ideas and knowledge to the project design.
- Focus-group interviews can be carried out with randomly (e.g. on a marketplace) or systematically (e.g. sex age ) selected persons.
- Key informant interviews for specialised information. Representatives of specific persons of key functions are questioned.
- Individual respondents for representative information.
- Chains of interviews.

**observation techniques.** The instrument consists of two types, known as:

- Direct observation to capture phenomena and processes in their typical environment. With the consent of respondents tapes, cameras or notice books can support the research.
- Participant observation by participating in everyday life in order to experience the community's prospect.

**compilation of diagrams, maps and simulation models.** These instruments are used for planning, common discussions and analysis of information . By using local available materials (e.g. stones or seeds beside pen and paper), the tool is one of the most common and flexible ones.

- Transects, transect walks, transect analysis, cross-section maps and drawings showing different units (e.g. forest, field, village)
- Seasonal calendar to show causalities between natural cycles (rainfall, temperatures) and the effects on human resorts (e.g. employment, income).
- Timelines, historical profile, time trends.

- Social mapping, decision trees, chapati or venn diagrams to visualise local infrastructure or living conditions.
- Simulation models.

**ranking-/rating-/sorting-techniques.** These tools are analytic instruments to assess achieved data about main problems, preferences or other data as income or prosperity from the quality point of view. Used techniques are preference ranking, pairwise ranking, direct matrix ranking or wealth ranking.

**local knowledge.** Techniques, which revert to local methods of knowledge transfer like indigenous technical knowledge, folk taxonomies, classifications, ethno-biographies, case-studies, folklore, songs and poetry.

#### **3.3.4. LIMITATIONS**

The most critical elements for a successful study are social components, experience and qualifications of the team members as well as teamwork and various additional disciplinary perspectives. These attributes have to be available, otherwise participatory appraisal may be counterproductive and result in questionable findings.

Community participation has great potential, but it has shown also that the involvement of the community in decision making has limits.

## 4. ECOLOGICAL SANITATION

### 4.1. Background Information

Over the last decade the proportion of people in developing countries with access to safe water has improved. Contrary to water supply, access to sanitation services has improved only imperceptively (DFID, 1998).

We often have a fixed perspective that humans are producing sewage and not urine and faeces. Tanner (1995) writes that every social group has a social policy for excreting: some norms of conduct will vary with age, marital status, sex, education, class, religion, locality, employment and physical capacity.

The difference in understanding the attitudes and perceptions is of main importance and the key to reach a wide acceptance of reusing human waste.

Over the past hundred years flush-and-discharge systems, e.g. based on technologies like flush toilets, sewer networks and wastewater treatment plants, have been regarded as the ideal technology, especially in industrialised countries. Developing countries try to copy this model, however, most municipalities in these parts of the world cannot afford the necessary resources, in terms of water, money and institutional capacity (Esrey et al. 1998).

Flush toilets waste about 15.000 litre pure water per person and year for the transport of human excrements and therefore is deemed unfit for other purposes. Over 90% of all sewage in Third World countries is discharged completely untreated (Esrey et al., 1998) polluting rivers, lakes and coastal areas.

Uno Winblad (1997) distinguishes basically three different ways for managing human excreta at household level (Figure 8):

- Drop-and-Store is based on safe storage of the material containing pathogenic organisms. The device is a pit toilet.
- Flush-and-Discharge is based on dilution and removal of human excreta. The device in this system is a water toilet connected to a sewage system.
- Sanitise-and-Reuse systems are based on accelerated pathogen destruction through dehydration and composition. The device serves either a dehydration toilet or a composting toilet.

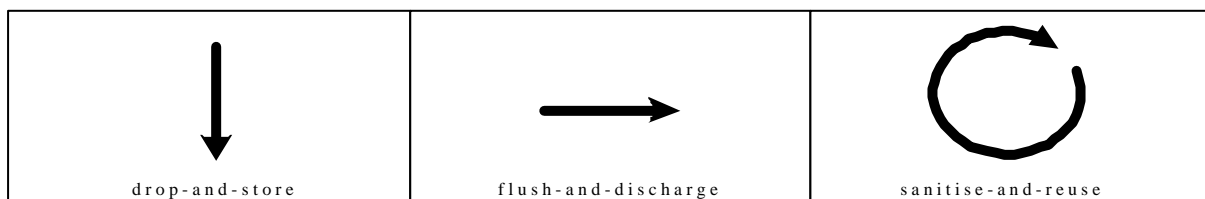

Figure 8: Three basically ways for managing human excreta (Winblad, 1997).

#### 4.1.1. DROP-AND-STORE

**pit latrine.** In many parts of the world people are using a local type of pit latrine (Figure 9) and therefore it is the most common sanitation facility. The working principle of

this Drop-and-Store system is fundamentally based on containment and indefinite storage of human excreta. Under favourable circumstances the pit latrine can be an appropriate technology, hence the system is simple, no water is required for flushing and it is low-cost.

To guarantee that the Drop-and-Store system works properly, specific environmental conditions are required such as access to open space as well as adequate soil conditions, which are deep, stable and permeable. Another prerequisite is a low groundwater level and a site that is never flooded. But if the existing conditions are not adequate disadvantages can increase dramatically. Soil and groundwater contamination, bad odour, fly and mosquito breeding, pit collapse or overflowing after heavy rainfalls are the most common side effect.

The simplest form of a pit toilet consists of a (large) pit, which people dig by hand at least a few meters away from their house. Nevertheless when they are full people have to dig another one.

The construction consists of a squatting slab made of timber and soil on the top of the pit. The material of the superstructure and the roof varies, almost depending on the income status. Widespread are local materials like papyrus, bamboo, banana leaves, bricks, mud but also iron sheets and nylon papers.

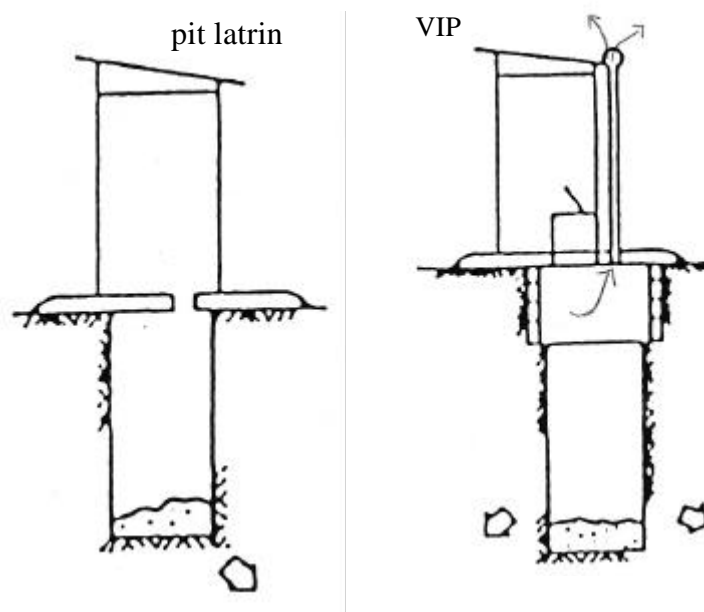

Figure 9: The main principles of a pit latrine and a VIP.

**ventilated improved pit latrine (VIP).** This toilet represents an improved type of the pit latrine (Figure 9) and several advantages over the traditional one are obvious. The most important difference consists of an additional hole in the slab for a vent pipe, which guarantees in the best cases no odour as well as no flies. A draught of air down through the squat hole up the pipe is responsible for a smell free shelter. To prevent the facility from flies, the opening of the pipe is covered with a fly screen. On the one hand the flies cannot enter into the pit and on the other hand, the light at the top of the pipe attracts the flies which are breeding in the pit. They are trapped and it is impossible for them to get out. The insects will die and fall back into the pit.

Furthermore, the superstructure of the improved latrine in most cases is constructed of solid materials. The risk that the pit will collapse is less; the concrete slab still can be cleaned properly and protects from hookworms and other infections.

Nevertheless, there are similar problems like those with the traditional pit latrine. There is no improvement concerning the darkness of the toilet, the distance between houses and VIP as well as that a new one has to be built after filling the chamber up.

#### 4.1.2. FLUSH-AND-DISCHARGE

Each person produces about 400-500 litres of urine and 50 litres of faeces over a year, which are flushed away with 15.000 litres of pure water. The system is based on the collection and transport of wastewater via an extended sewer system to centralised treatment plants. These systems use huge amounts of clean water as transport medium, which gets contaminated by faeces and urine. In most cases this mixture gets discharged completely untreated into the environment. A further problem are the high costs of a centralised wastewater system, due to that a satisfactory supply with piped water, sewerage, drainage and collection of garbage in many cases is not given.

Esrey et al. (1998) summarised the problem of the two systems above mentioned in one sentence: „Furthermore, nutrients and pathogens seeping from pour-flush toilets, pit toilets and septic tanks have been documented as the cause of contamination to groundwater and nearby surface waters throughout the world.“

#### 4.1.3. SANITISE-AND-REUSE

An alternative approach is Ecological Sanitation (EcoSan)<sup>24</sup>, which is meant to be a more sustainable, closed-loop sanitation system. EcoSan represents a holistic and systemic approach towards an ecologically as well as economically sound sanitation. EcoSan is an attitude based on new sanitation principles and not a new sanitation technology. The underlying goal is to close the nutrient and water cycles with as little expenditures on material and energy as possible. The new paradigm of EcoSan is to move away from a linear to a circular flow of nutrients – towards a recycling society (Esrey, 2001). It treats human excreta as a resource, which “[...] are processed on site, and if so required off site, until completely free from pathogens and inoffensive. The faeces are sanitised (composted or dehydrated) close to the place of excretion, and the composted organic matter is applied to the soil to improve its structure, water-holding capacity and fertility. Valuable nutrients contained in excreta, mostly in urine, are returned to the soil for healthy plant growth” (Esrey et al. 2001). Furthermore EcoSan systems require very little water. “It is thus very appropriate for areas with water shortage or irregular water supplies. It is a decentralised system, based on household and community management, and the need to invest in large-scale infrastructure and operate centralised institutions is drastically reduced” (Esrey et al. 2001).

Esrey et al. (2001) defines EcoSan as a system that

- Prevents disease and promotes health
- Protects the environment and conserves water
- Recovers and recycles nutrients and organic matter

„The reuse of plant nutrients (nitrogen, phosphorus, potassium etc.) in our human excreta is necessary for sustainable food production. These nutrients are provided by the soil to the plants which serve as our food“ (Jönsson, 1997). Eco San should help to keep the natural en-

---

<sup>24</sup> In this thesis the term EcoSan is used for composting and dehydrating toilets. In other literature it may be that Ecological Sanitation is used in a broader sense.

vironment clean and should save people from diseases. Interventions for reaching this objectives are required - they include:

- (i) disposal and hygienic management of human excreta, refuse and wastewater, which is adequate for the respective social, economical and environmental conditions.
- (ii) the control of the disease vectors and
- (iii) the promotion of washing facilities for personal and domestic hygiene.

EcoSan involves both behaviours and facilities , which work together to form a hygienic environment. Schertenleib (2001) demands a promotion of services, which:

- are people-centred
- meet basic needs
- improve public health
- reduce impact of poverty
- respond to demand
- are environmental, social, institutional, economical and financial sustainable
- respect the need to preserve and protect the resource base
- protect and enhance ecological integrity

But before talking about recycling and returning important nutrients to the soil, it is necessary to shed light on the different characteristics of urine and faeces.

## 4.2. Urine and Faeces

Human excreta contain nearly the same amount of nutrients as found in the food. The weight depends on the diet, thus, differs between persons, location, age, activity and health status. For example, a vegetarian produces a higher quantity of faeces with a higher amount of moisture than a person who eats meat (Del Porto and Steinfeld, 2000). Published figures indicate that a human being produces about 1kg of urine daily and excretes less than 150g of faeces (wet weight). These average amounts refer to Europeans and North Americans, while data from developing countries vary between 130g and 520g (Pieper, 2001).

The excreted amounts of human faeces fluctuate world-wide within a large range (Table 7) as well as the quantity of included components. Especially in developing countries a difference between people living in the rural area and in urban areas is mentioned.

wet weight	faeces (g)
<b>ENGLAND</b>	
sailor	104
teenager	110
vegetarian	225
<b>PERU</b>	
Shipibo Indians	325
<b>KENYA</b>	
hospital staff from rural areas	520
<b>UGANDA</b>	
<b>rural population</b>	<b>470</b>
<b>MALAYSIA</b>	
Chinese from rural regions	489
Chinese from rural regions	277
Indian from rural regions	170
Indian from rural regions	385
doctor from rural regions	135

Table 7: Daily average amount of human excreta world-wide per person (Pieper, 2001).

### 4.2.1. URINE

“The major plant nutrients nitrogen (N), phosphorous (P) and potassium (K) are found in human excreta and thus in domestic wastewater but the contents will vary depending on the food intake” (Schönning, 2001).

Yearly loads (kg/p/year)	Urine (~500)	Faeces (~50)	Greywater (25 000-100 000)
Nitrogen	87	10	3
Phosphorus	50	40	10
Potassium	54	12	34

Table 8: Daily average amount of selected components in human excreta per person (Otterpohl, 2001).

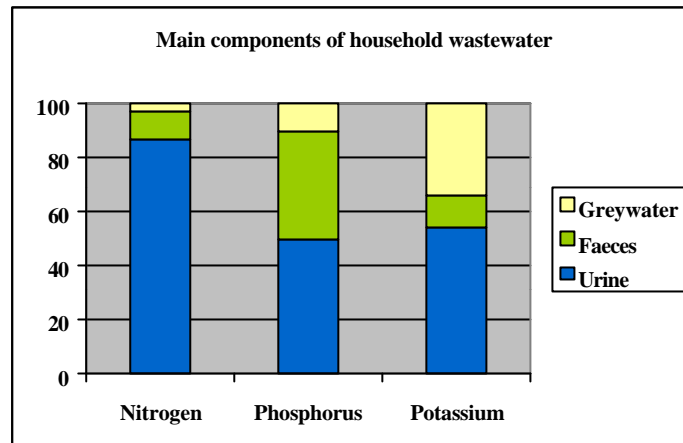

Figure 10: The contribution of urine, faeces and greywater to nitrogen, phosphorus and potassium in wastewater.

In the human urine most of the excreted plant nutrients are found (Table 8; Figure 10): nearly 87% of the total nitrogen, as well as 50% of the phosphorus and 54% of the potassium (Otterpohl, 2001)<sup>25</sup>. It follows that annually each person produces about 4 kg of nitrogen, 0.4 kg of phosphorus and about 0.9 kg of potassium - nitrogen in form of urea, phosphorus as phosphate and potassium as ions. At the same time urine comes to less than 1% of the total wastewater volume.

Furthermore, pathogenic organisms are also found in human urine. In a healthy individual it is sterile in the bladder. When transported out different types of dermal bacteria are picked up. Schönning (2001) concluded “[...] that pathogens that may be transmitted through urine are rarely sufficiently common to constitute a significant public health problem and are thus not considered to constitute a health risk related to the reuse of human urine in temperate climates. An exception in tropical areas is *Schistosoma haematobium*, which however implies a low risk due to its lifecycle. Furthermore, the inactivation of urinary excreted pathogens in the environment reduces their ability for transmission.”

The risk of transmission of infectious diseases via diverted human urine depends largely on a cross-contamination by faeces. The proper use of urine-diverting toilets should avoid faecal contamination. Schönning (2001) recommends some guidelines to ensure a minimal risk for a safe reuse of urine:

- Protection and awareness of risks is important, especially for those handling unstored urine.
- Using suitable fertilising techniques and working the urine into the soil, as well as letting some time pass between fertilisation and harvesting will decrease the exposure to potential pathogens.
- Using urine for commercially processed crops, like cereal crops, the risk for infection through food consumption is negligible.
- Reusing human urine at household level, for the own consumption, involves less risk than large-scale systems.
- The liquid is suitable for fertilising all types of crops if one month lies between fertilisation and consumption.

The components of chemical fertilisers, used as manure in agriculture, are similar to the contents and the quantities of plant nutrients in excreted urine. Furthermore, another advantage in

<sup>25</sup> In the literature different measurements are found, a different amount of components in human excreta. Compare with: Schönning (2001) and Jönsson (1997).



the use of human urine as fertiliser seems to be the lower heavy metal concentration compared to the amount in commercial fertilisers (Jönsson et al., 1997) and the normally low amount of pathogens. Hence, urine can be regarded as an excellent option for a high quality fertiliser (Figure 11).

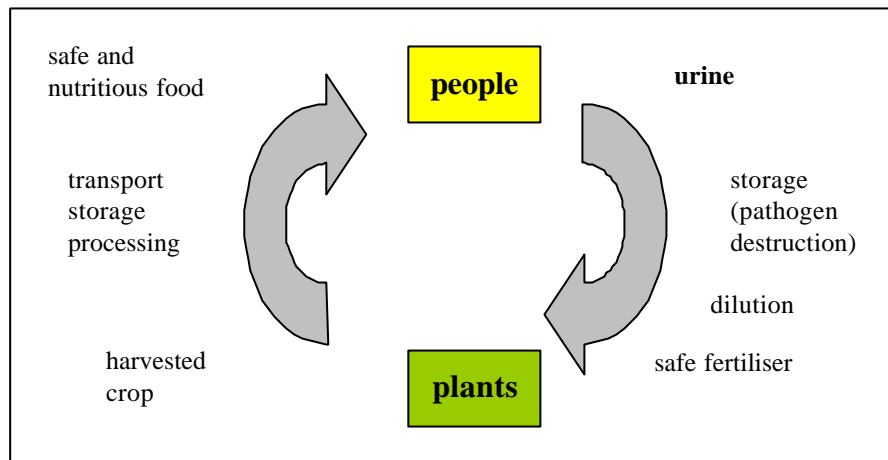

Figure 11: Closing the nutrient cycle with urine (Esrey et al., 2001).

By collection of urine, it is important to consider that nitrogen rapidly degrades to ammonium and is easily accessible for nitrification and use by plants. To prevent the loss of nitrogen to the air as well as to keep bad odours, urine should be stored in a closed system with restricted ventilation (Jönsson et al., 1997) and be used rapidly. Niemczynowicz (2001) writes, when the human urine is stored in a container without air contact it can be kept for about one year without losing its fertilising value.

The possibilities for using human urine as a fertiliser are widespread: the easiest way is the trickling away in a soak pit, another one is the evaporation if there is no interest in use. An additional, useful and not wasting way is the undiluted direct use on open soil, non-food crops or the direct use of water diluted urine (one part of urine to 2-10 parts of water, depending on the fertilised crops<sup>26</sup> to prevent scorching) on vegetable gardens or agricultural fields (Esrey et al., 1998).

#### 4.2.2. FAECES

In contrast to human urine, excreted faeces contain only a small part of plant nutrients (Table 8; Figure 10), which are found in undigested fractions of food. The total excreted quantity for an adult person per year is mentioned between 25-50 kg containing up to 0.55 kg of nitrogen, 0.18 kg of phosphorus and 0.37 kg of potassium (Jönsson, 1997). However, this organically material is not immediately plant available: the undigested food residuals have to be degraded before they become available. That means, the nutrients in the faeces take more time to be plant available than the nutrients in the urine.

The biggest problem by reusing faeces in agriculture is the content of pathogens, which can be an important health risk. With a properly functioning EcoSan facility, faeces are sanitised inside the vaults and no pathogens are spread into the environment (Figure 12).

<sup>26</sup> Compare with: Guzha (2001) and Johansson (2001).

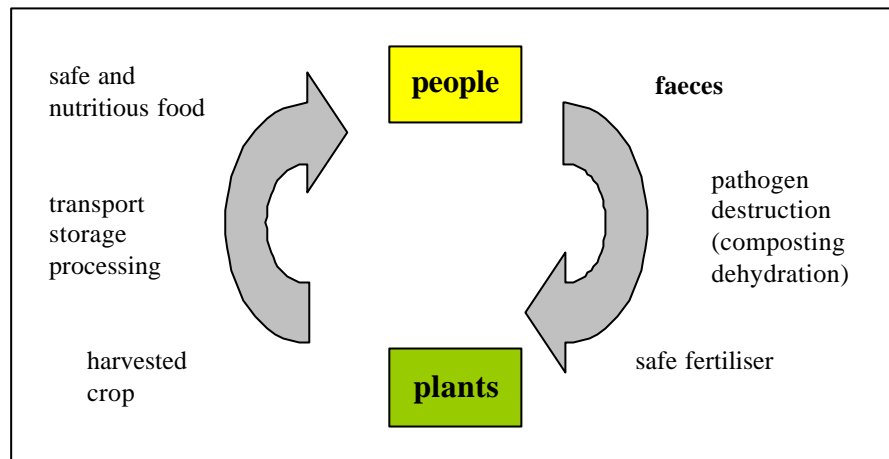

Figure 12: Closing the nutrient cycle with sanitised faeces (Esrey et al., 2001).

This rate varies considerably for the different types of pathogens found in human faeces. Some organisms die quickly, after hours or even after days, but there are also types staying alive for weeks or months. Environmental conditions play a significant part: they will speed up or slow down the die-off time.<sup>27</sup>

A declaration of a general valid death-time for organisms is not possible. Under different natural conditions the average die-off rate varies, as well as how many disease organisms are present. The greater the number, the longer it will take all of the pathogens to die. Crucial is the change of influencing environmental conditions at the same time. The most important are temperature, moisture, nutrients, other micro-organisms (including other pathogens), sunlight and pH. The death of the harmful organisms may be sped up, if more than one condition is changed (Esrey et al., 1998). Investigations have been carried out in dry latrines in various regions of the world under different conditions. Summarising it can be mentioned that the most important factors are time, a low moisture and a high pH, which can be obtained by adding ash, lime or similar additives. 6 to 8 month storage of dry collected faecal material at pH 9 is regarded as minimum storage condition to guarantee a safe reuse.

Temperature is an additional main factor in the reduction of most groups of pathogenic organisms, since all living organisms can survive at temperatures only up to a certain level. Temperatures of 50 °C and above could obtain a much shorter collection time and could still ensure a more or less total destruction of pathogens (Stenström, 2001). Likewise supporting conditions are a decrease in nutrients and micro-organisms as well as an increase in sunlight.

**prevention of pathogens.** EcoSan systems with an additional promotion about sanitation in general and the proper use of the facilities, show sustainable health benefits. Improved sanitation reduces childhood illnesses, their death rate and also plays an important part for improving the nutritional status of the people. Keeping the water bodies free of contamination, keeping excreta away from people and keeping the environment clean of contamination should help to interrupt the ongoing cycle of sanitation related illnesses. According to studies in the last years improved sanitation could reduce diarrhoea diseases by 35-40% and could reduce child mortality by half as well as child malnutrition (Esrey et al., 2001).

<sup>27</sup> “The time it takes for all the organisms of the same type to die is referred to as the die-off rate” (Esrey et al., 1998).

Pathogens and parasites found in human excreta are widely responsible for a variety of illnesses, including diarrhoea and malnutrition. Especially in faeces the majority of pathogens are found. Therefore the main risk lies in the contaminated environment, mostly by faeces spread next to the places where people and animals are living.

The main ways for infecting humans are contaminated fingers, fluids, fields, flies and foods (Figure 13). When people ingest dangerous pathogens from one of these media they are exposed to infections and diseases. Infected people, who are excreting into the environment, are continuing the cycle of contamination and infection. This spread can be reduced or stopped by using barriers to prevent the pathogens moving from one place to another. A primary barrier (like dry toilets) would prevent faeces from reaching flies, fluids, fields and foods. If pathogens gain access to the environment, secondary barriers (like washing hands, adequate cooking of food, food hygiene or water disinfection) must be relied. However, the overall aim to break the cycle begins at the first step: to keep peoples surroundings free of human excreta (Esrey et al., 1998).

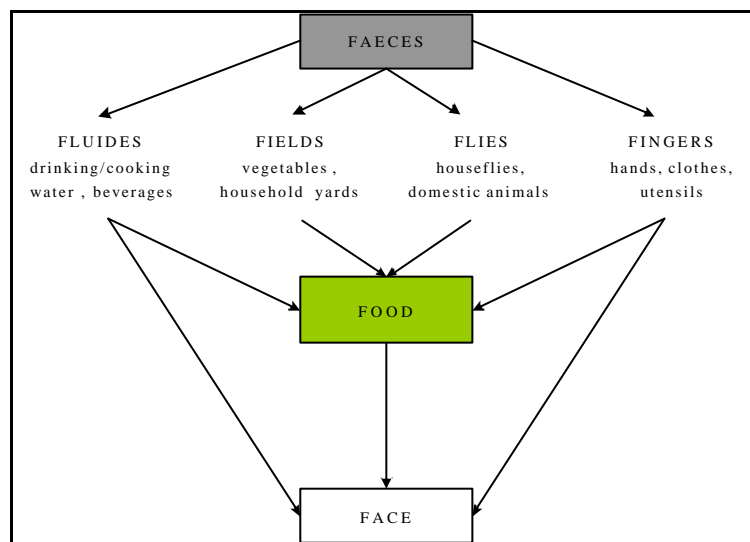

Figure 13: The F-diagram: the main ways diarrhoea is spread (Esrey et al., 1998).

“As the death or survival of excreted pathogens is an important factor influencing transmission, these organisms should be destroyed or otherwise rendered harmless” (Austin, 2001). Safe storage and quick destruction are the main two measures to destroy excreted pathogens, respectively to prevent their access to the environment.

**destruction of pathogens.** Bacteria, viruses and protozoa usually die-off within several months, while helminth eggs survive for many month and eggs of the species *Ascaris* can survive for years under optimal conditions. The most resistant pathogens in faeces, which are used as indicator organisms for the die-off rate, are eggs of *Ascaris lumbricoides* (the common roundworm) and *Cryptosporidium parvum* (a type of parasite causing diarrhoea) (Esrey et al., 1998). In different studies, depending on the local conditions and the treatment system used, the destroying time various, but it is generally assumed that after 6 to 8 months under dehydration or composting processes, the number of pathogens are reduced nearly to zero. Sanitised excreta are the prerequisite for a safe handling and recycling. Esrey et al. (1998) recommends a four-step process:

1. Keep the volume of dangerous material small by diverting the urine and not adding water (for flushing).

2. Prevent the dispersal of material containing pathogens by storing it in a secure device till it is safe for recycling.
3. Reduce the volume and weight of pathogenic material by dehydration and decomposition to facilitate storage, transport and further treatment.
4. Reduce pathogens to a harmless state by sanitation: primary treatment on-site (dehydration or decomposition, retention); secondary treatment on or off-site (further dehydration or high temperature composting; changes in pH by the addition of lime).

The sanitised excreta should now be safe for handling and after a sufficient secondary treatment, guaranteeing complete pathogen destruction, the products have become a nutrient rich fertiliser. Esrey et al. (1998) writes that the destruction of dangerous micro-organisms as well as handling is safer, easier and less costly if the faeces are not mixed with urine and water.

### 4.3. The Main Principles of EcoSan Facilities

The main principles of EcoSan are based on an eco-systematic approach, which prevents diseases by destroying pathogens before human excreta are returned to the terrestrial environment. Thus it recovers and recycles plant nutrients and organic matter for closing the nutrient loop by giving sanitised excreta safely back to the soil (Esrey et al., 2001). EcoSan or dry toilets are also minimising rapidly unnecessary water use and protect water sources from contamination with antibiotics, hormones, chemicals and pathogens. Furthermore EcoSan stresses the point of dealing with household and personal hygiene to reduce health risks.

#### 4.3.1. THE DESIGN

The huge number of different EcoSan facilities and designs need to be flexible, affordable, consider local conditions and customs and take socio-economic conditions into account (Esrey et al., 2001).

Different systems and designs of EcoSan facilities (Figure 14) are currently in use in many countries and regions of the world. Each toilet at least implies minimum of three minimum components: a pedestal or squatting pan, a slab and a chamber, plus a superstructure. The chamber, preferably two of them, stores human excrements or urine and faeces separately. They are constructed above or below ground, portable or fixed in place. The superstructure consists of four walls, a door and a roof made of different materials, depending on the location as well as on the social status of the owners. The ventilation pipe is above all responsible to prevent the shelter from bad odour, to dry out the contents and for composting toilets, to provide oxygen for the decomposition process.

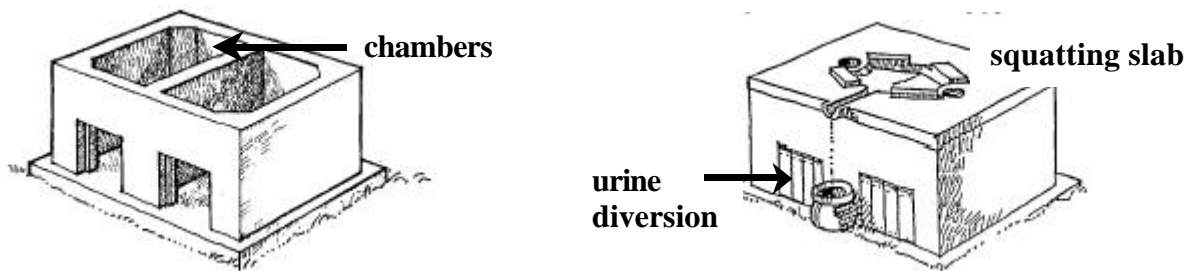

Figure 14: Basic design of an EcoSan dehydration toilet (Esrey et al., 1998).

The basic principles of dry toilets rest on two main processes: dehydration or decomposition. The main variance between the two systems lies in the humidity of the contents and the basic question: **How to deal with the liquids?**

**with or without urine diversion.** EcoSan systems offer three different ways of dealing with liquids: urine diversion, liquid separation or combined processing.

**urine diversion.** At least there are three good reasons for not mixing urine and faeces: (i) it is easier to avoid excess humidity in the processing vault, (ii) the urine remains relatively free from pathogenic organisms and (iii) the uncontaminated urine is an excellent fertiliser (Esrey et al., 1998). A urine diversion system requires a specially designed seat-riser or squatting slab (Picture 5), to avoid urine and faeces getting mixed. A dividing wall separates

urine, which passes in front of the wall, from faeces, which drop down behind the wall in a chamber.



Picture 5: Model of a squatting slab.

**liquid separation.** Urine and faeces are collected in the same chamber. The system requires no special design of the seat-riser or squatting plate. The liquids are drained afterwards and the urine has to be sanitised before it can be reused as fertiliser.

**combined processing.** Liquids and solids are processed together. The system requires a large amount of absorbent material and also an extremely dry climate seems to be advantageous.

#### 4.3.2. DEHYDRATION

Dehydration means that the moisture volume is brought down to less than 25%<sup>28</sup> through evaporation and addition of dry material like ash, lime, sawdust or soil. Pathogenic organisms are destroyed by depriving them of water, the moisture they need to survive and by increasing the pH above acceptable living conditions. This low humidity level guarantees (little) no odour and no fly breeding.

Urine diverts away from faeces with the use of a specially designed collection device, squatting pans or seat risers. The separation of liquids allows the faeces to be dehydrated fairly easily. The installation of separated urinals is recommended and should guarantee a proper use by men. The collected urine is stored in a separate container for using it directly as a fertiliser for food or non-food crops. In the collection chamber of the toilet faeces are sanitised through drying with the help of a dehydration agent, preferably ash. An EcoSan facility consists usually of two alternating faecal chambers, one active and one for the storage and sanitising process.

When one pit (from dehydration as well as decomposition toilets) is nearly filled up and before closing it with a concrete lid for further processing, the material should be covered with a layer of grass and a second one of soil. Before switching from one pit to the other, the con-

<sup>28</sup> The gap between 25% - 60% of humidity should be avoided, to prevent the dehydration process to be incomplete and the composting process to be too slow or in the worst case come to a standstill, as well as from fly breeding and unpleasant odours.

tents of the first vault, which should have had enough time for sanitising, are emptied. The end products should be soil-like, odour free, fairly dry and safe to handle for using as manure on food and non-food crops.

#### **4.3.3. DECOMPOSITION**

On the other hand to reach the aim of an effective biological decomposition process, the humidity of human excreta must be kept above 60%. Composting is a biological process, in which under controlled conditions organic substances are mineralised and turned into humus. In an composting toilet, potentially harmful residuals are transformed into a stable, oxidised form (Del Porto and Steinfeld, 2000). The high temperature, unfavourable pH value, adequate aeration and the ratio of carbon to nitrogen, within the range 15:1 to 30:1 (Kilma and Winblad, 1985; Esrey et al., 1998) will effectively destroy most of the pathogens. For reaching the optimal conditions in the compost heap, additional bulking agents like dry grass, clippings, sawdust, kitchen refuse must be added.

A variety of organisms, such as viruses, bacteria, fungi, earthworms and insects contribute to a breakdown of the faecal material. The produced humus is an excellent soil conditioner, nearly free of human pathogens after an adequate retention time. Possible rising odour can be extracted out via a ventilation system.

#### 4.4. Reuse of Human Excreta

The nutrients, in form of food, are shipped, trucked or railroded from rural areas to cities. This linear flow continues because these nutrients leave the urban areas in form of excreta and organic waste. Especially in developing countries more than 90% of sewage is discharged without any treatment with all the known consequences for the environment and thus for the health.

The characteristics of soil, weather conditions and altitude are responsible for agricultural activities and food production. The specific conditions determine the essential amount of sanitised human excreta as fertiliser to compensate the degradation.

Baanante and Henao (1999) write that the two main causes of degradation are loss of topsoil from water erosion and fertility decline. In Africa alone, 8 million tons of nutrients are lost every year, representing US\$ 1.5 billion per year. The depletion of NPK per hectare from African soils is significant and alarming. The annual amount varies from less than 30 kg/hectare to more than 60 kg/hectare. The negative nutrient balances show clearly that not enough nutrients are being applied in most areas.

Thus it is not possible to fix a global valid quantity like different field trials determine. An experiment of the fertilising effect of human urine in Sweden shows following results: "The fertilising effect of source separated urine to cereals has in Sweden been investigated in two pot experiments, a three year field experiment and a one year field demonstration. These investigations have shown that source separated urine is a well-balanced complete fertiliser and its nutrients are readily available to plants" (Jönsson, 2001).

The main components of artificial fertilisers are mostly limited to nitrogen, phosphorus and potassium but soils contain also numerous important micro-nutrients. By failing to return nutrients as well as micro-nutrients to agricultural lands, soils get depleted over the time. In urine and faeces the three major nutrients plus essential micro-nutrients, such as calcium, carbon and magnesium, are found (Esrey et al. 2001). Jönsson (2001) writes "All nitrogen, phosphorous and potassium from urine and faeces can be recycled to agriculture, except for some small losses of nitrogen in the form of ammonia. A lot of energy is conserved since a lot of chemical fertilisers can be replaced by urine and faeces."

The sanitised human excreta helps to cultivate crops without the use of expensive fertilisers and pesticides. It allows farmers to save money and commercial fertilisers do not wash out of the soil polluting groundwater, streams and lakes. Recycling returns nutrients to soil and plants, restoring helpful soil organisms to enhance the productivity and to grow healthier and nutritious food.

Composted faeces, or faeces and urine, usually by adding them to existing compostable materials, have several desirable qualities after having been transformed into humus or compost which smells and looks like earth (Esrey et.al., 2001):

- Compost improves soil structure. Compost helps to form the particles in the soil of sand, clay and silt, which are held together by humic acid.
- Compost increases the water-holding capacity of soil. While 50 kg of silt holds 12 kg of water and 50 kg of clay holds 25 kg of water, 50 kg of compost holds 100 kg of water. A soil rich in compost requires less watering and plants growing in compost will withstand drought better.
- Compost moderates soil temperatures. Adding compost to soil tends to keep the soil from heating up or cooling down too rapidly.
- Compost breaks up organic matter into the basic elements that plants need. Compost is teeming with micro-organisms, which continually break down organic matter.



- Compost gives back to the soil what agriculture takes out of it. Compost is made up of decaying matter, including every chemical a plant needs, like boron, manganese, iron, copper and zinc which are not present in commercial fertilisers.
- Compost releases nutrients at the rate plants need them. Compost acts as storehouse for nutrients, and slowly releases the nutrients throughout the growing season. Furthermore the compost layer prevents the surface from drying out, which increases uptake of nutrients and improves the growth of plants.
- Compost can neutralise soil toxins and heavy metals. Compost bind metals such as cadmium and lead, making it difficult for plants to absorb them.
- Compost reduces pests and diseases. Compost improves a plant's ability to withstand attacks by diseases and insects by enhancing naturally occurring microbial agents. It reduces the effects of soil-borne pathogens and reduces the amount of plant parasites and nematodes in the soil.

Esrey et al. (2001) summarises “[...] compost improves soil and its fertility. It makes soil easier to cultivate, reduces the need for chemical fertilisers and pesticides, and adheres to the principle of EcoSan. Composting serves as a secondary level of processing of faeces, making it safe and preventing disease. Composting conserves water because it holds more water in soil for a longer period of time. And finally, composting recycles nutrients”.

## 4.5. The EcoSan Project in Kisoro<sup>29</sup>

When we are talking about developments in the sanitation sector, people and local conditions should be a focal point of every project, according to the guideline “people at the centre”. Without stakeholders’ knowledge, awareness and co-operation, without knowing local point of views, sustainable improvements are hard to obtain. The following chapter should give an overview of the actual situation in Kisoro, for a better understanding of the ongoing EcoSan project.

As aforementioned Kisoro Town and Chuho spring are situated in the lava fields at the foot-hills of the Virunga volcanoes. Due to the porous nature of the rocks as well as of the soil, there exists an urgent need of safe guarding its water source against contamination. The complex geological situation seems to be the main problem to determine the accurate path of water, which infiltrates at the urban centre of Kisoro. For this reason the risk of polluting the spring is not exactly known at the moment. Presently there exists no contenting operating sewerage system in Kisoro Town. Therefore, this region was selected as a pilot study region for implementation of an EcoSan system.

The main purpose of the EcoSan programme was to promote types of toilets for dry sanitation, to minimise possible contamination of ground water. Over 250 units have been built in the years 1999 and 2000. Dry toilets were built for both, public households as well as for high polluters like primary schools, secondary schools, boarding schools, the prison, the old and new market as well as the taxi park and other institutions.

The dry sanitation toilets have been chosen because of the above mentioned hydro-geological situation, soil occupancy, land shortage, for their removal efficiency and general difficulties of digging into the ground on shallow soils.

### 4.5.1. TYPES OF EXCRETA DISPOSAL

The percentage of households with access to any type of toilet facilities in Kisoro District, given from the Population and Housing Census 1991 Analytical Report Vol. III 1995 (Table 9), is 84% of the total households. About 16% deposit faeces in bushes or all over the place. In the most cases pit latrines are used. VIP and water flush toilets are only found in the urban centre of Kisoro Town.

(%)	households	population
water borne	0.18	0.15
pit latrine	83.72	86.15
other	0.16	0.13
none	15.93	13.57
total	100.00	100.00

Table 9: Distribution of households and household population by toilet facilities (Norplan, 1997).

<sup>29</sup> Data are derived, if not marked in an other way, from following source: Hoellhuber and Nyiraneza (2001); Nalubega et al.,(2001); KITOWASO (2001); TBW (1996); TBW (2001).

In 1997 the District Health Inspectors Office in Kisoro published new information about the sanitation coverage in Kisoro District. 59% have sanitation facilities and in accordance with the 5 year old report most of the households are using pit latrines.

In 1998 under TBW a baseline survey was carried out to enlighten the exact sanitation and hygiene status, habits and practices within Kisoro Town (Table 10). 28% of households did not have any sanitation facility or have an inappropriate one. Out of the 70% having pit latrines, 43% were found inappropriate and dirty.

pit latrine	70%
flushing system	2%
none/not appropriate	28%
total	100%

Table 10: Household sanitation survey (TBW, 1999).

The results of the latest survey reflect a poor situation within the town. Especially the high percentage of households without any sanitation facilities points out the urgent need to change the current situation.

**none or inadequate sanitation.** One of the biggest problems related to inadequate sanitation facilities seems to be spreading diseases caused by pathogens and parasites found in human excreta. This can result in a wide variety of illnesses, mainly diarrhoea. With 28% of people who don't have or only have inadequate sanitation facilities disposal of used excreta is still very common in Kisoro. The people are excreting somewhere in the landscape, contaminating their environment, in many cases without being aware of the health risk.

**pit latrine.** Pit latrines cannot be indicated as an adequate excreta disposal. Especially the topographic characteristics influence crucial environmental processes and limitations. In most parts of Kisoro District covers only a thin layer of soil the underlying rocky ground. The volcanic ground renders digging of pits more difficult, which is unavoidable every few years for pit latrines.

**flush toilet.** Viewing the actual situation of Kisoro as a fast growing town and the majority of households are low-income, it is difficult to imagine that flush toilets can be a solution for the town's sanitation problem. Apart from the fact, that for most of the people this system is not affordable, only a few houses are connected to piped water. Currently just ten houses are connected to the sewer system in the town centre, but at the moment only four are using it together with the treatment plant. All other houses are using waterborne sanitation and have a septic tank with an overflow into the ground.

**EcoSan facilities.** Based on fundamental ecological principles, zero pollution, recycling and water conservation, EcoSan systems seem to be the most appropriate sanitation technology for Kisoro. Especially the permanence of the superstructure as well as the possibility of reusing the sanitised products are the key assets in the project area characterised by small plot and family holding sizes and degrading soil fertility due to over-cultivation. Two types of dry sanitation facilities - decomposition and dehydration - have been chosen for three different levels: household and private facilities, institutions and schools as well as facilities for public places.

In the project area of Kisoro Town two different EcoSan systems have been constructed: the Double Vault Solar Heated Composting Toilet and the Double Vault Solar Heated Dehydration Toilet.

**double vault solar heated composting toilet.** This type of EcoSan facility (Picture 6) comprises two vaults by a retention volume of  $1.8 \text{ m}^3$  (under ground) for each chamber and with two defecation holes one into each vault. Both urine and faeces are deposited into the same pit; each vault is used alternately for a certain period, depending on the number of users. Before the operation is started, the users should bring a layer (a minimum of 20 cm) of organic residues to cover the floor of the pit for purpose of absorption of liquids. In addition to manage the optimal moisture level the users have to add dry material such as ash, soil, sawdust after every use. Also kitchen waste or dry material like straw, dry leaves, dry grass has to be added into the vault during the operation phase. Anal cleansing material, e.g. newspapers, toilet paper, leaves, grass are thrown additionally into the vaults.



Picture 6: Example of a composting toilet in Kisoro.

**double vault solar heated dehydration toilet.** Like the composting type the dehydration one (Picture 7) comprises of two chambers, each with a volume of about  $0.6 \text{ m}^3$ , which are built above ground. Both chambers are equipped with a urine diversion system: a sitting type with a urine collector or the more common squatting slab with two drop holes. Both are diverting the liquids from the faeces and the urine flows via a pipe through the cubicle wall into a soakpit next to the toilet chamber, the faecal matter falls straight down into the vault. After every visit the users have to add enough (about a handful) dehydration agent like ash, soil, sawdust to absorb undesirable moisture and for sanitising the contents. Also papers, leaves, anal cleansing material is dropped into the vault. The chamber thus should contain only faeces, bulking agent and hygiene material.



Picture 7: Examples of dehydration toilets in Kisoro.

**superstructure.** In the project area two different types, one composting and one dehydrating type, have been chosen to make the process easier. The structure is generally designed to serve up to 10 users for one year. Nevertheless, to establish the right dimension is not that easy. For example: if the number of users increases, one chamber will get filled up too fast. The minimum size of a chamber however has to be sufficient at least for 6 months, which is the time human faeces, human faeces and urine respectively, need to be sanitised. On the one side the size chosen has to guarantee safety for users, especially for people who handle the material and on the other hand oversized chambers are uneconomic and expensive. The walls of the substructure are made of cement bound lava ash (concrete) blocks. Aspired was a reduction of required quantities of construction material to make the system as affordable as possible. The vaults are covered by a 6 cm thin reinforced slab, which consists of 2 fillings and 2 openings for emptying. The whole time one filling and both emptying holes should be covered properly.

The users have to build the superstructure on their own expense, which consists of a simple rectangular structure and a door. Most part units are lacking a window therefore the toilets are dark. The traditional systems had to be built some metres away from the house, to guarantee a minimum of safety. EcoSan facilities can theoretically be connected to the houses, to avoid needless distances.

The material for the superstructure consists preferably of local materials (Picture 6; Picture 7) such as bamboo or papyrus, to achieve an appropriate technology and to keep the building costs as low as possible.

**solar heaters.** Both types of facilities are solar heated meaning that the doors for emptying the chambers are black-painted and exposed to the sun in order to increase evaporation.

**ventilation and aeration.** The plastic pipe has a diameter of 10 cm and is covered with a rain shield as well as a fly screen for trapping the flies. The vent pipe reaches about 0,5 m above the roof to create enough draught for a working process.

**4.5.2. IMPLEMENTATION**

The urgent need of an improved sanitation system in Kisoro Town was evident since the beginning of the water project. Thus swTws decided to subsidise sanitation on household level. In 1999 swTws started to inform and sensitise the community by house to house visits about the advantages of the EcoSan technology. When a family was interested they were required to deposit 30.000 Ugh. Shillings on the KITOWASO account. For this money deposit the project constructed the sub structure, four corner poles and the roof of the toilet. The families had to finish the superstructure, using their own funds.

Table 11 gives an overview of the constructed units in Kisoro Town. In the first implementation phase 140 compost toilets on household level were built, but the result was not really satisfactory because most of the people did not use them properly (no or too less use of bulking agent and dry organic material for keeping the moisture low). The people used the dry toilet like a pit latrine: the material in the chambers was in most cases wet, combined with bad odour and flies.

In a second phase 107 dehydration toilets for private households, 4 public and 3 for institutions were built. The investigations showed that these units are easier to maintain for users.

	operating	completed	not finished	constructed Σ
composting units	44	21	75	140 (140 squatters)
dehydration units	31	13	63	107 (70 squatters, 37 sitters)
	+ 3 public units + 3 institutional	+ 1 public unit		

Table 11: EcoSan units in Kisoro (April 2001).

Nearly 50% of the units are incomplete at the moment (Picture 8). The reason is that most people are using an old pit latrine and they wait until it is filled up, before they plan to finish the structure of the dry sanitation unit. Others were constructed attached to houses which are incomplete, not yet built or which are unoccupied. A plot with only the sub structure of a dehydration or composting toilet is not unusual in Kisoro Town due to high encouragement for building one of the units.





Picture 8: Toilet sub structure.

Currently monitoring of the units is in progress. Like at the starting phase, with house to house visits and by talking to the users as well as checking the facilities, this process aims at finding out the assess of the technology, successes, failures and how to redress EcoSan in further projects.

At the moment promotion of dry sanitation is still going on. Sensitisation as well as information of the population is further the overall target. It is a long way to convince people of the advantages of this system besides the proper use of a dry sanitation unit. However, the project shows first good results: on one hand people are starting to accept these types of sanitation facilities and on the other hand interested parties are coming to visit Kisoro and to see how the units are working to promote EcoSan in other parts of the country.

## 5. EVALUATION OF FIELD FINDINGS

The following chapter is mainly based on collected data in Kisoro from August to October 2001. It gives a brief summary of results from specially prepared EcoSan questionnaires, not including the agricultural part (see chapter 5.3.3.). For a detailed evaluation see Annex A. Furthermore, a survey of various possible scenarios for recycling sanitised human excrements in agriculture was conducted. Different ways, how nutrient cycles can be closed by using valuable nutrients and without damages to the environment were considered.

**data collection.** To get an insight into the project and to collect information about the current situation, the austrian - ugandan research team spent the whole August 2001 in Kisoro. A questionnaire, a checklist, to assess the condition and the proper use of the EcoSan facilities, qualitative interviews and the help of Dorothy Nyiraneza, Robert Mukiibi and Benon Nteziryayo, from KITOWASO created the basis of the study. Furthermore the field work as well as the final evaluation orientates on the research technique Rapid Rural Appraisal (see chapter 3.3.) to avoid an extensive and time consuming data collection.



Picture 9: Data collection by house to house visits.

By house to house visits (Picture 9) we tried to get answers to our questions as well as a feeling for the acceptance and the opinion of the users. This main part of our fieldwork was principally influenced by the life rhythm of the people. Mondays and Thursdays are the market days in Kisoro and from the early morning hours everybody (especially women) is active. People are coming from the surrounding villages and the town is busy and full of life. During these days it was very difficult as well as time-consuming to reach a respondent. But also on the other days we often had problems to find an informed and responsible user of dry sanitation facilities. In some cases we had to rely on answers of workers, housemaids and children. However, after nearly 5 weeks and 56 respondents, we finished our fieldwork in Kisoro.



## 5.1. Evaluation of Questionnaires

We were using 2 different questionnaires (Annex A); each divided into 4 parts, for 2 groups of toilet users:

- (i) Respondents **who use** EcoSan units
- (ii) Respondents **who do not have or have but do not use** EcoSan units

Furthermore we distinguished between units on public or household level. To the category of public toilets belong institutions or schools, units at public places as well as units from bars or restaurants.

All in all we talked with 56 respondents, subdivided into 30 interviewee using or having composting and 26 interviewee using or having dehydrating units (Table 12; Table 13).

	public level	household level	total
in use	9	17	26
not in use	1	3	4

Table 12: Number of interviewed respondents with composting units.

	public level	household level	total
in use	11	11	22
not in use	2	2	4

Table 13: Number of interviewed respondents with dehydrating units.

### 5.1.1. ECOSAN TOILETS IN USE

Primarily we drew attention to toilets, which are in use. For all of the 48 respondents we used the same questionnaire, only for the evaluation we separated in 4 categories, in composting (26) and dehydration (20) users and also in public (20) and household (28) ones (Table 12; Table 13).

Each respondent was asked to give general information: (A) Location and (B) Household Information, to gain an overview about the user's background. Main results from part (C) Excreta Disposal/Management are summarised as follows:

- 87.5% or 42 respondents used pit latrines before adapting an EcoSan facility while 12.5% used other possibilities.
- As advantages over the former system the users mentioned mainly that this facility prevents from bad smell and flies, the facility is easier to clean, the structure is permanent, better respectively and the sanitised products can be reused. 4 people answered that the situation is the same like with the former pit latrine.
- Approximately 71% or 34 users prefer the squatting type for defecation due to the fact that the people are traditionally used to squat<sup>30</sup>. Reasons for preferring a squatting type toilet are mainly the fear of contracting with diseases from sitters, that children can use it easily,

<sup>30</sup> Some respondents did not know any difference between sitting and squatting, they have never seen a sitting type of toilet. They could not give a satisfying answer.

it is easy to clean or answers like better for public use or more hygienic. 14 users prefer a sitting type with the main reason that it is more comfortable for old aged or sick people.

- The majority is using ash<sup>31</sup> as dehydration agent, as a further paramount factor for a working toilet. Few add soil, sawdust or lime.
- The reuse of the sanitised excreta is one of the key reasons for the project implementation. Most of the people know theoretically that they can use the final products as fertiliser, but many of them show no interest to be personally involved in the process. Approximately 45% can not handle the dried faeces and nearly 17% are waiting for KITOWASO or have no idea what will happen if both chambers are full. Only 38% show no fear handling with the material.

Likewise we have been interested in additional problems, to get an idea what people are complaining about.

- The substructure of the toilet is too small, the defecation hole was built too close to the door, to the wall respectively, especially users of composition units emphasised this point.
- Above all owners of public toilets complain about improper use by various guests, often caused by a lack of information.
- Some respondents have problems with smell and flies mainly due to an improper use (dirty facility, no dehydration or bulking agent, and wet contents in the chambers).
- Four users of dehydration facilities mentioned a blockage of the urine-diverting pipe, three of them are owners of public units.

One of the main targets of the EcoSan systems is the affordability as well as a local adaptable and acceptable toilet. Suggestions for improvements from users should help to avoid mistakes of the past. Most points are conclusions of the above mentioned problems.

- The most named suggestion, especially for composting toilets, was the preference of a bigger structure, a bigger defecation hole respectively.
- An improvement of the drainage pipe or plumbing.
- Some people see a need in further education of the users to guarantee a better working sanitation system.
- Two users of composting toilets recommend a dehydration toilet, as well as two users of sitters would prefer a squatting type.

### 5.1.2. ECOSAN TOILETS NOT IN USE

A second pre-designed questionnaire (Annex A) for EcoSan systems, which are completed but not in use right now, was used in 8 cases, with the same separation as for in use facilities. Briefly it can be said that the majority of respondents uses pit latrines at the moment. For reasons, why they are not using the EcoSan facility were mentioned:

- The current toilet is not yet full (4 respondents).
- The EcoSan facility is yet not complete (3 respondents).
- The structure brook down, a blocked urine pipe (1 respondent).

---

<sup>31</sup> Obtaining ash should not be a problem for households since most families use firewood for cooking.

A sister of St. Gertrudes Secondary School, who wants to have a dry toilet for the school to promote advantages among the students and to sensitise them about sanitation, gave an additional interview. She sees advantages in the permanence of the substructure as well as in the possibility to reuse the final products. Remarkable was the sister's knowledge about the Eco-San system; she collected information from different sources on her own.

## 5.2. Evaluation of Checklists

The results from the checklist should give an impression on the performance of the system at the time of research in August 2001. For the assessment of the facilities we used 2 different checklists, depending on the type of toilet (Annex B), either composting (28 units) or dehydration (22 units) facilities.

### **composting units.**

- Rain shields were not provided at the time of construction, thus 25 facilities were not covered with a shield to prevent rain draining into the cambers.
- The aeration of the vault contents was not easy to ascertain. However, observation was done to see if the collected excrements were not too wet for a working composting process. 15 of the checked toilets seemed to be well aerated compared to 10 toilets with wet chambers.
- Perhaps the most evident advantage seems to be the control of smell and flies. 19 units did not smell and 21 units we found without flies or insects.
- Half of the units showed a fair standing of general cleanliness compared to some cases with improper use standard.

### **dehydration units.**

- The majority of users understood the importance of dehydration agent. Though 14 claimed to use it, only in 12 units ash was present at the time of observation.
- The dryness of the faecal contents seem to be one of the most positive aspects, with 17 dry contents and only 4 appearing wet. This was checked by observing the collected faeces as being heaped or flowing.
- 15 units did not smell and 19 units were found without flies or insects.
- One third of the toilets was found without adequate cleanliness including an unsanitary urine diversion system.

### 5.3. Potential of Reuse in Kisoro

Kisoro, with currently almost 11.000 inhabitants and an annual growing rate of 4.2% is a fast growing town. The amount of plots, houses respectively without places for agriculture activities, for growing food for subsistence, is constantly increasing. The pressure for harvesting a high yield is getting higher, the fields are getting smaller and the soil is losing fertility. Heavy rainfalls and agriculture activities on the steep slopes of the surrounding hills are the reasons for a dramatically loss of valuable soil.

Education programmes from different organisations, governmental as well as non-governmental, should help the farmers to improve their growing methods and protect the fields from erosion. Apart from the common approaches, like grass strips (mainly elephant grass), agro-forestry, terracing, inter-cropping and deforestation programmes, the reuse of the sanitised faeces can be an alternative and additional way.

#### 5.3.1. RETURN OF NUTRIENTS TO THE SOIL

Presently the use of commercial fertilisers is not widespread throughout Kisoro District. Most of the farmers use organic matters as soil conditioner, but farmer organisations are starting to promote chemical ones as an answer to all of the problems, like the loss of productivity.

The majority of people living in Kisoro are dependent on subsistence agriculture to guarantee enough food for the whole family. Along with the problem of loosing soil fertility, goes the loss of biological diversity and diversity of living beings and organisms. Above all, an unbalanced diet and malnutrition is responsible for a high infant mortality rate, 97 per 1000 born children (SWI, 2001). A variety of plants and food crops can prevent the loss of diversity in land and water ecosystems. Subsequently it improves food security and reduces malnutrition. Among other things the constantly growing population density within the town requires a permanent, non-polluting and save alternative to the common toilets in Kisoro. The EcoSan units fulfil all the demands mentioned for the owners, the users and the environment.

#### 5.3.2. HOW MUCH CAN BE GIVEN BACK TO NATURE?

The EcoSan project in Kisoro is presently unique for Uganda thus no data from field trials in other regions are available. The few data existing are from field surveys and at the moment only present for urine.

No user of a dehydration toilet is collecting the separated urine at the moment. The urine simply spills through a pipe onto the ground and gets soaked into it. Only KITOWASO is collecting the urine from the dry toilet at KITOWASO Office for fertilising the soil of a maize demonstration plot next to the house. The field is divided in 2 parts: one for fertilised maize with urine and one for unfertilised. The experiment is supposed to illustrate the difference between the two plots by means of the harvested quantity in addition to the size of the plants. The recycling of sanitised human faeces represents an uncommon situation because no chamber is emptied so far. Field trials are expected during the next month when the first end products will be adequately sanitised for recycling.

During the last years the data of field trials were increasing, but this only should be a beginning. The need for further trials all over the world still exists to guarantee a safe and effective reuse of human excreta.

### 5.3.3. QUESTIONNAIRE OUTCOMES

The fourth part, (D) Agriculture, of the questionnaire is supposed to show the users approach to the possibility of recycling the final products in their own agricultural fields (if existing), their willingness of hiring somebody to remove the products as well as their general knowledge. We tried to find out, how informed the people are, how interested they are in general for using the sanitised faeces (faeces and urine) as manure.

On one hand the main focus was questioning whether there was a difference between public and household units and on the other hand if the existence of gardens and fields shows a significant distinction.

#### 5.3.3.1. Household EcoSan Units

The number of respondents counts 28, whereby the number of “do not know yet” or “no idea” answers to the question: “What do you use the products from the EcoSan for?”, was noticed particularly. Out of the 28 interviewed people, 8 respondents could not give us a satisfying answer. Further 6 persons are waiting for KITOWASO, hoping the workers from the Water and Sanitation Office would empty the toilet chambers and also the workers know how to handle with the material (Table 14).

The majority of the private owners still have agriculture fields; small home gardens for home consumption respectively.<sup>32</sup> Only three households completely rely on buying food from the market or the small shops in town. The households without any agriculture are currently neglectable. But in consideration of the fact that the amount of Kisoro’s inhabitants will grow constantly in the next years as well as the problem of land shortage, the families without any subsistence agriculture will probably increase.

In opposition to the users of the public toilets, the private ones evidently show more interest in the issue of reusing. 8 respondents want to reuse the products as manure in their own gardens and one plans to bury them. The other 5 hope to hire somebody for emptying the toilet chambers, whereas the price is very important.

	with gardens	without gardens
reuse as manure	8	
hire somebody/ depending on the price	4	1
bury	1	
do not know yet/no idea	6	2
KITOWASO	6	

Table 14: Reuse of sanitised excrements - household units.

#### 5.3.3.2. Public EcoSan Units

To gain an overview of the situation in the public sector we asked 20 people. The starting point represents a different situation: most of the users did not feel responsible for the toilets. The units are open to the public thus a general inadequate use or interest can be mentioned.

<sup>32</sup> The agricultural fields of 10 respondents are located in one of the surrounding villages or a few kilometres out of Kisoro Town.

Another distinction is the lack of agriculture fields or gardens in 13 places; the majority has no possibility for recycling (Table 15).

4 respondents answered with “do not know yet” or “no idea” and 6 hope KITOWASO takes over to the maintenance of the EcoSan unite. That means that half of the respondents show little or no interest in reusing the products. Only 2 are interested in fertilising their fields with sanitised human excreta. The remaining part counting 8 respondents wants to hire somebody, if the price is acceptable.

	with gardens	without gardens
reuse as manure	2	
hire somebody/ depending on the price	4	4
bury		
do not know yet/no idea		4
KITOWASO	1	5

Table 15: Reuse of sanitised excrements - public units.

### 5.3.3.3. Results

In general we could ascertain that the users are more interested in a proper use of the facility and also in recycling the dry material, if the units are in private hands. The interest in a reuse further depends on agricultural activities. The people from households with fields and gardens in the majority of cases show an interest in closing the nutrient cycle. For fertilising food plants the use of organic material, like peelings, is very common. A lot of farmers know about the advantages of using organic fertiliser. Due to house to house visits to inform the people about the harmless of dried and sanitised human excrements, likewise about favourable effects of reusing the material, the acceptance of recycling is slowly increasing.

In view of the high amount of “do not know yet no idea” answers, half of all 48 respondents, a further information and promotion campaign is still necessary.

The possibility to hire somebody to remove the products from the chambers is required in any case. On one hand, the absence of fields and gardens and, on the other hand, the absence of responsibility and interest is accountable for this necessity. Especially owners of public units more or less rely on hiring somebody.

At all events the charged rates for emptying the EcoSan facilities are important. The charges have to be moderate and affordable.

## 5.4. Nutrient Flow and Input-Output Analysis

In the South-western corner of Uganda, Kisoro is the only urban centre. The main part is rural, consisting of small villages and scattered houses. For the last years the number of people, shifting from rural communities to Kisoro Town hoping to escape the meagre existence in the small villages, is still increasing. A clear sign for this trend are a number of unfinished houses, which define the townscape as well as unimproved plots, some with the superstructure of an EcoSan facility. The growing population involves a rising consumption per capita. New industrialised products, like cans, plastic bags instead of traditional baskets or packaged food are gaining importance. Thus environmental pollution and resource depletion is accelerating over time.

To gain an overview of the current situation the model of Material Flux Analysis should show different correlations for food and water.

**structure of material flux analysis.** Mainly in industrialised countries Material Flux Analysis have been utilised for the early recognition of environmental problems and the analysis of solutions (Binder, 1996). By observing the metabolism of Kisoro, it should be possible to show the nutrient flows of two sub-systems, for food and water. Unfortunately the time was too short to collect exact measurements and data. In this case the MFA was reduced to a nutrient flow, an input-output analysis respectively and can only give an overview of the actual situation, to rise an understanding of the interrelation between the sub-system food (Figure 15), water (Figure 16) and the environment.

### 5.4.1. SUB-SYSTEM FOOD

**system border.** The system border for the sub-system food is the urban part of the municipality of Kisoro.



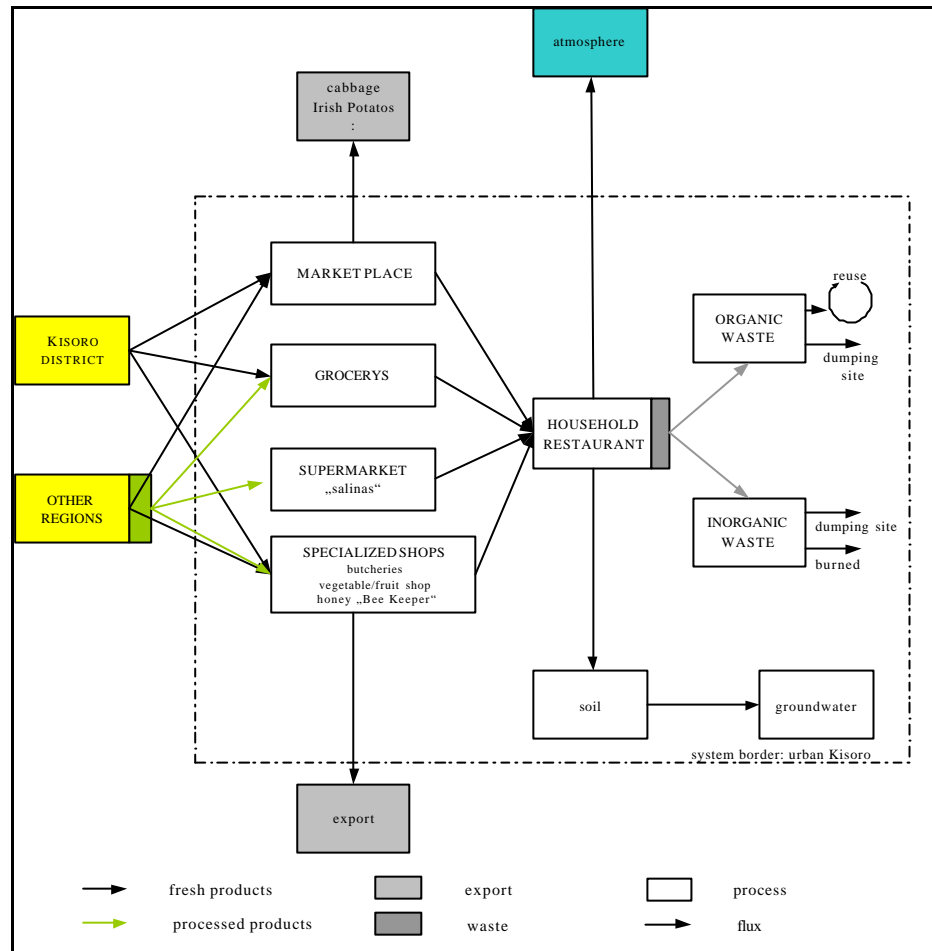

Figure 15: Sub-system food.

The sub-system consists of four supply processes, one consumption process, one waste management process and two environmental processes.

**supply.** The supply processes comprise the process market place, groceries, supermarket “Salinas” and specialised shops. Two times a week, on Mondays and Thursdays, the market place supplies the inhabitants of Kisoro with fresh products like vegetables, fruits, fowls and local sweets. Most of these goods come from the region, being the surplus of subsistence farmers. Imports are received from other regions of the country or from the near Democratic Republic of Congo. In numerous small groceries the offer ranges from manufactured products, like oil, margarine, tea leaves, bread to fresh products. The fresh products are obtained mainly from the market whereas manufactured products are all imported. The only supermarket in the municipality offers imported manufactured food. There are various specialised shops, including several butcheries, which are selling locally produced meat, primarily goat but also cow meat. One vegetable and fruit shop supplies the municipality with mainly imported goods, which are not available at the market like green pepper, egg plants, melons and pineapples. The beekeeper organisation offers different honey products produced from honey coming from the near region.

**consumption.** Household or restaurant form the consumption process. According to Binder (1996) households and restaurants are one consumption unite. It is assumed that households consume about 90% of food and public places only about 10%.

**waste management.** The waste management process divides into organic and solid waste. The refuse will become a big and new problem within town. At the moment no concept for collecting the waste exists. The people are burning the refuse next to their houses or dumping the material somewhere in the landscape. Stinking places, where people are looking for useable things and animals searching for eatable waste, are a growing hygienic risk. A huge part of organic material is used as manure in the fields and gardens and is closing rudimentary nutrient cycles.

**environment.** The environmental process are water and soil. Water mainly in form of groundwater, because no river flows through Kisoro Town. Sewage like organic and solid waste is polluting the soil and in consequence the groundwater.

#### 5.4.2. SUB-SYSTEM WATER

**system border.** For the sub-system water, the system border is defined by Chuho spring, which is the only yielding spring in the region, thus supplies the whole town.

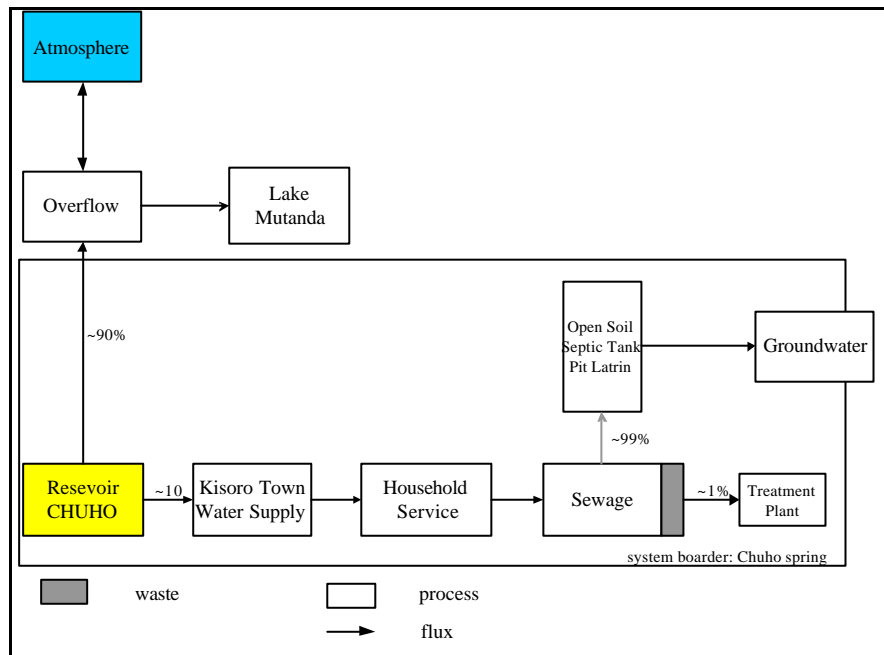

Figure 16: Sub-system water.

The sub-system consists of one supply, one consumption, two waste management and two environmental processes.

**supply.** This process consists of water supply, which operates through KITOWASO and supplies households and services of the municipality with water. Just a few houses have private house connections, the remaining part is collecting water from the public stand taps.

**consumption.** Households and services are the water consumers in Kisoro, households forming the main part. An exception are large-scale consumers, like hospitals and hotels.

**waste management.** Sewage will become one of the main problems in the near future. At the moment only three houses are connected to the treatment plant, the remaining house-

holds or public institutions resolve the sewage problem by using pit latrines, septic tanks or the open soil. But all three possibilities represent a big problem for the groundwater; a contamination with untreated sewage is predictable.

**environment.** The environmental process consist mainly of soil and groundwater, groundwater being the more endangered part because of untreated wastewater. The only surface water body in the region is the overflow of Chuho and merges with Lake Mutanda in the North, behind the surrounding hills of Kisoro.

### 5.4.3. CONCLUSIONS

As mentioned above the structure of Material Flux Analysis only permits to draw a superficial picture of the nutrient flows in the region. The analysis should help to get an impression of the actual situation and supposed to show the weak points of the system.

One fact emerges clear and distinctively: the flows, for both sub-systems food and water, are linear - the cycles are not closed and waste the surrounding environment. The system requires, like Esrey et al. (2001) demands: a “closed-loop-approach” for returning the nutrients to the soil instead of water or waste. Recycling of organic waste is actually the only practised approach in the right direction, but the target for closing the nutrient loop is still far away. In this context the possibility to use EcoSan systems instead of the local, mostly leaking pit latrines is of particular importance to avoid groundwater and environmental contamination. Furthermore, the option to close the cycles by using dried and sanitised material as manure in the agriculture leads to an interruption of the actual situation. Closing several processes should break off the linear flows to close nutrient cycles. A closed-loop-approach is targeted in which the nutrients in excreta are returned to soil to improve its structure, water-holding capacity and fertility.

## 6. POSSIBLE MEASURES

The necessity and demand for closing nutrient cycles appear to be an important strategy in the Kisoro region. Cultural taboos, poverty, lack of interest and information are only a few obstacles, which make the implementation of the concept difficult. Kisoro is just at the beginning to become a town, the people are not really used to industrialised products as well as to solid waste. Environmental pollution is something new.

The importance of measurements and improvements is obvious for the region of Kisoro. The following part has two main focus points:

- (i) ways and possibilities how nutrient cycles can be closed based on the reuse of sanitised human excreta,
- (ii) the importance of a decentralised solution and the role of the Household-centred Approach.

### 6.1. What Happens with the Sanitised Material?

At the time of field visit in Kisoro, August to October 2001, the first composting and dehydration toilets have been in use at most for two years. The majority is still using the first chamber and only a few ones were full and were already closed. The problem of what to do with the sanitised material will be becoming urgent within the next months.

**user's perceptions.** The evaluation of the questionnaire gives an overview of the users' perceptions, respectively the knowledge about EcoSan systems in general and the factor of reuse particularly. 50% of users interviewed answered "don't know yet/no idea" to the reuse question. A fixed idea is missing; they are waiting for what will happen. The remaining part divides into reuse as manure in the own fields or gardens and the wish to hire somebody to empty the chambers. The actual task consists of finding an efficient solution adapted to users' demand and local conditions.

#### **local advantages.**

- The peasant domination of the region makes recycling easier.
- Kisoro Town currently has enough open land (e.g. for a second treatment for reusing the material).
- The fields are located next to the houses or near the town, which keeps transportation ways short and helps to save costs as well as working time.
- The use of chemical fertiliser is not common. Most of the farmers use organic manure. They know about its advantages and how to handle it. This situation helps to facilitate the implementation of sanitised human faeces as manure. Fertilisation will increase yields in any case. The long and hard way to persuade the farmers of organic farming instead of using chemical fertilisation is not necessary.

#### **possible solutions.**

Option 1. The owners of a dehydration or composting unit are responsible for reusing the products. How to handle the material is everyone's own decision. The emphasis is being put on the reuse as manure on agricultural fields or gardens. An important prerequisite to guarantee a safe handling of the material is a sufficient knowledge about dehydration and composting. To reach this goal and to make this solution possible, an intensive informa-

tion campaign is necessary (e.g. at schools, through house to house visits, public meetings). Further possibilities for managing the material are burning or burying.

Option 2. Reuse of the material is the responsibility of the Town Council. It has to collect the sanitised products, has to guarantee a sufficient second treatment and has to recycle the material being an operation and maintenance public company.

This possibility includes a variety of proceedings: e.g. deciding if the collecting service is chargeable or not, the manure is free for farmers. Other open questions, which also refer in some extend to option 1 are: Which kind of infrastructure is necessary to empty the full toilet chambers? Where is enough space for a second treatment respectively for an intermediate storage? What should happen with the biodegradable solid waste? Is a combined collection as well as a combined second composting process reasonable?

Option 3. Emptying the chambers becomes a private business. This solution should be self-sustaining. For the option of privatisation similar questions arise as for option 2: Is the service for emptying chargeable or free of charge? Can the utilisable fertiliser be picked up for free by the farmers? Is the combination of human faeces and solid waste in the second treatment process practicable?

Option 4. Farmers, who are interested in reusing sanitised human faeces as manure, are collecting the material. The collecting service can be with or without fees. The peasant is responsible for emptying the chambers of the toilets, the necessary infrastructure and a safe fertiliser.

Option 5. The owners of a toilet are selling the products to farmers. This possibility is a labour intensive one. Two advantages especially attract attention: The users of dry toilets are responsible for a good quality of the manure. If they want to sell the chamber contents, a proper use of the toilet will be in their own interest. The owners of dry toilets will earn additional money, if the collecting farmer is satisfied with the product.

**separated urine.** Discussion the reuse of human excrements in Kisoro, another focus point lies in separated urine. The EcoSan project is not at its final stage and tries to solve more urgent problems, like emptying the full chambers. Fertilisation of fields and gardens with human urine is currently not an important issue. The dehydration units are equipped with a tube to drain the urine into the soil. This system is quite easy and uncomplicated but valuable nutrients get lost. Reusing urine has to be kept in mind for the future. A demonstration plot, like the KITOWASO one for maize in the town should be a first step to show the differences of urine fertilised and unfertilised fields, creating awareness among people. Urine has a big benefit compared to faeces due to the almost innocuous composition. Reusing can be adopted from the locals quiet easily. A jerrycan for collecting the urine should be enough to store the liquid until it is incorporated. Reusing solutions especially for the dry material are targeted in a next step; crucial at the moment is an emptying plan for the chamber contents.

**the most likely way in Kisoro.** The most likely way is in this case only valid for sanitised faeces, respectively composted urine and faeces and omits, because of the reasons mentioned above, separated human urine. First I want to explain the decision and want to point out the influencing factors again:

- Users, local people and their demands and willingness.
- Local environment as well as natural realities, natural conditions.
- Available or not available infrastructure.

- Social structures and relationships.
- Resources (like financial, human).
- Personal field experience.

Considering these points the most probable way will be option number 4. Probably other ones are more sustainable but taking into account the local situation all other possibilities do not correspond with actual facts. Nevertheless the farmer option number 4 seems to be the easiest and most uncomplicated way at the moment. To start with another one, requires a wide information campaign: for the household, private solutions (option 1 and 5) directly at family and user level, for Town Council, private business (option 2 and 3) ones for the workers, employers.

**farmers as reusers.** One part of the studies in Kisoro dealt with the search for farmers, who are interested in recycling of the sanitised products. Farmers who fulfil following criteria:

- The farmer should be aware of organic farming.<sup>33</sup>
- The size of the farm should be bigger than the average size in the region of 0.8 ha for an extensive recycling process.
- Knowledge about composting of organic waste should be available.
- The necessary infrastructure should exist, like a transporting vehicle.
- The farmers should plant a rich diversity of crops, to guarantee a safe reuse.
- The peasant should be active in the community, to reach something like an accumulative process.

At the end of the year 2000 KITOWASO invited peasants from the district to talk to them about the possibility of recycling human faeces and the reuse as manure. Some farmers accepted the invitation but at the end of the day only one farmer remained.

Getting an impression of the peasant, KITOWASO made it possible for me getting an insight Mr. David Rwisebura ideas, his knowledge, his way of working and his motivation as well as a visit on his farm. Actually he fertilises his fields with organic manure, with animal dung as well as with NPK-fertiliser. In the dry products he sees a way to save money, he wants to substitute the expensive NPK manure with the dry material he wants to collect from the toilets for free. Mr. Rwisebura already has a fixed idea how to reuse the material, also for which crops in which fields. (Annex D)

During the stay in Kisoro interested farmers were visited for a second time. Ms. Regina Sanyu, her compound is situated a few kilometres away from Kisoro Town, surprised with her profound knowledge about organic farming, in theory as well as in practice. She is holding workshops for farmers (mainly for women) to improve their knowledge especially in organic farming. Ms. Sanyu shows how to obtain higher yields or how to save the soil from erosion. All in all two farmers are interested in reusing sanitised human material at the moment. Their fields have enough capacity for the actual requirements. What are the next steps?

1. Knowledge: to introduce the interested farmers to EcoSan in general, how the system works (both of them have no dehydration or composting unite), what they have to take into account, about health risks and how to close nutrient cycles.

---

<sup>33</sup> Nearly all farmers in the District are organic farmers, because they are using no chemical fertilisers. We looked for peasants who are aware of organic farming.

2. Infrastructure: both farms are situated in one of the small villages a few kilometres away from the town as well as the dry toilets are scattered. Owning a private vehicle is something exceptional, mainly for people with a higher social status or who support the family by driving taxi. One possibility for transporting the material can be a small trailer for a bicycle or something similar. This option may be an economic one hence bicycles (next to the women's head) are the most common means for transporting goods in the region.
3. Payment: the financing aspect offers several possibilities but for all "recycling farmers" one modus has to be chosen with the same fees. The peasants have to decide if the collecting service is free of charges respectively how much the toilet owners have to pay. Mr. Rwisebura is prepared for emptying the toilets for free due to the benefit he sees but he has to agree with Ms. Sanyu to guarantee a working system.
4. Controlling and data collection: carrying out field trials, to collect data and experiment results, constitute a major part in the ongoing project. Measurements about quantity and quality of the material have to be collected to gain a thorough basis for further activities.
5. Additional possibilities: the way to an appropriate and sustainable solution includes obstacles as well as detours and often grows with an ongoing project. In consideration of a growing number of EcoSan facility users, thus a higher amount of material, an additional solution has to be developed.
6. Operation & maintenance: emptying the units can not be enough to guarantee a working project. The current situation demands a more intensive control of the material in the chambers. Many users are not informed or lack responsibility for the toilets. As a consequence the chamber contents are wet, there are flies and a bad odour. With correct operation and maintenance a proper use should be ensured.

The first steps for closing nutrient cycles have already been made. The material of some chambers can be reused on farmers' fields, to compensate the steady fertility loss of the soil. Most of the consumed nutrients in Kisoro come from the surrounding regions so that the way to a balanced input and output analysis appears a realistic goal.

## 6.2. Advantage of a Decentralised Solution

Nearly 92% of the whole population are living in the countryside of Uganda. Migration and urbanisation may gain importance during the coming-up centuries - Kisoro District is not an exception. Concepts to reduce high migration rates to other regions or cities have to be a main part in developing policies. One focus point comprises the strategy of decentralisation of various duties from the national to the local government. Decentralisation means a political and legal transformation and delegation of administration for more autonomy, participation and democracy for the districts. “By enhancing democratic participation, it is hoped that devolution of power would promote efficiency and productivity through deeper involvement of people at the local level” (UNDP, 1998).

The swTws project practices decentralisation in the water supply and sanitation sector. Geselbracht and Van Riper (1998) argued: “Decentralised urban sanitation (DUS) systems are in principle much less vulnerable, because their operation is independent of complex infrastructure such as energy and water supply; they are simple and robust.” Further advantages for a decentralised system Lens et al. (2001) see in following criteria and arguments:

- Little dependency on complex infrastructure services, for example, power or water supply.
- High self-sufficiency in construction, operation and maintenance of systems (independent of highly specialised people or companies).
- Low vulnerability to sabotage, destruction, etc.
- High public participation, acceptable to all social actors.
- Applicable at any site and scale.

The South western Town water supply project operates on a regional level, with the coordination bureau in the project area, in Kabale. Beside a better infrastructure, decentralised solutions create new jobs in the region and should stop migration in a large scale.

### 6.2.1. THE ROLE OF THE HOUSEHOLD-CENTRED APPROACH IN KISORO

Decentralised solutions should take households and the local population as major and smallest figure into consideration. Every decision should also take the Household-centred Approach into account, to solve problems as close as possible at origin. The water supply and sanitation project in Kisoro tries to meet the necessary requirements of being decentralised and appropriate for the region.

**an example: KITOWASO.** KITOWASO as a self-sustaining part of the swTws project, should serve as an example. The heart of the system are the households. KITOWASO tries to include the local population, their wishes and suggestions. The stakeholders should identify with the project as well as with its decisions and duties.

**sanitation sector.** In the sanitation sector, with the common pit latrines, the problem will be transferred to an unidentified level. The human excrements are dumped into a pit and pollute the soil as well as the groundwater. Most of the people are not aware of the problem: the excrements are invisible and therefore forgotten.

The main responsibility, when we are talking about EcoSan facilities, lies in the household (HH) level. Figure 17 visualises five possible solutions of how to deal with the dried material,



described in chapter 6.1. In solution 1 the owners are responsible for operation, maintenance and the reuse of the sanitised products. The nutrient cycle closes at the level of origin – the household. Users, which are not interested in recycling, submit the problem to the following level, their neighbourhood or to “recycling farmers” in the region (solution 4 + 5). The last feasible zone involves Kisoro Town or a private company to empty the chambers (solution 2 +3). Nevertheless, no matter which level functions for recycling, the returned nutrients close the cycle in the surrounding and the problem is stopped on regional level.

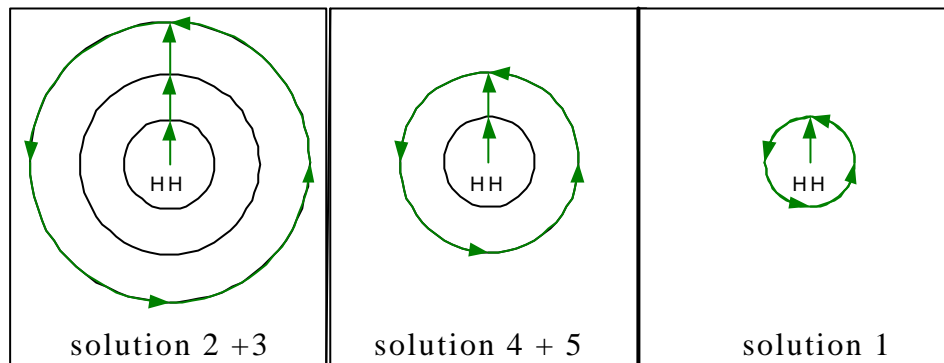

Figure 17: The 5 solutions based on the Household-centre Approach.

**water supply sector.** The advantages of a decentralised solution in Kisoro are predominant. The history of Kisoro Town water supply system reflects a common situation: the system was owned by the central government, the users considered the facilities not as their responsibility. Consequently the system never operated over a longer period of time until it finally broke down.

The actual working water supply system belongs to Kisoro Town. Participation of the consumers right from the beginning should increase the self-responsibility and the willingness to pay for the service. The fees, which every user has to pay, preserve the operation and maintenance.

For the sewage the responsibility refers to different levels. Considering the Household-centred Approach the central zone - the household - is not able to solve the problem. The wastewater, mainly without excrements, soaks into the soil or is collected in septic tanks. A pollution of the environment is inevitable. The next active zone, the town, operates a treatment plant but only a few houses are connected. The current situation can not be satisfactory. Crucial for a further development is the interruption of the linear flow to become a cycle.

## 6.3. Further Steps Forward

The question about the necessity of closing nutrient cycles as well as the question how this process can work in practice, has been answered in detail. But there are still open points and tasks. Some of them should be mentioned:

### 6.3.1. EDUCATION AND INFORMATION

Participation of stakeholders is one of the key elements in a working project. Community involvement strengthens the identification as well as the acceptance of improvements. Further information of the population by house to house visits are still important. On the one hand for users of dry toilets and on the other hand for the whole community. For users, how the system works, information about the proper use of the units, about dealing with the sanitised products, to guarantee a safe reuse. For the local community to support an improved Water Supply and Sanitation System, that they share the understanding and commitment.

Schools have a key position in the community and are the most important place of learning for children after the family. Childhood is the best time to stimulate or initiate changes, to learn hygiene behaviours. Next to the fact that they are future parents, children have important roles in the household, like taking care of younger brothers and sisters. Adequate sanitary facilities and also well informed teachers should act as a model to transfer knowledge for a long-term change. Schools can also influence communities through out-of-school activities and also they are in touch with a large number of households (UNICEF/IRC, 1998).

Women are of particular importance due to their role in the households. They are responsible for water, sanitation, hygiene and food preparation. They have to be included in empowerment and promotion processes, in the programme design and in detailed design decisions right from the beginning (Esrey et al., 1998).

### 6.3.2. DEMONSTRATION PLOTS

House to house visits, information campaigns, community empowerment, education and training should establish a sustainable EcoSan programme in Kisoro. Furthermore the promotion of reusing sanitised human excrements is still one of the main parts of the project. Demonstration plots, like the urine demonstration plot next to the KITOWASO Office, can be helpful to illustrate advantages of fertilising with urine or faeces. People can see an obvious difference between fertilised and non-fertilised crops. Public places, like the new market or the taxi park, next to the public EcoSan facilities, can be favourable as a location. On market days many people are passing these places or using the public units, and the fields can not be ignored.

### 6.3.3. ECOSAN FOR EVERYBODY

Currently most owners of dehydration or composting facilities in Kisoro have middle to high-income status but the vast majorities are poor subsistence farmers, without a regular income. Promoting dry toilets for everybody can only work with a financial consideration, how to support families with initial subsidies. A further step is the construction of appropriate toilets by using available local material to reduce costs. EcoSan facilities must be affordable for eve-

rybody with the goal of safeguarding public health and to increase living conditions for the people (Figure 18).



Figure 18: A new hygienic and prestigious toilet (Brandberg, 1997).

## 7. SUMMARY AND CONCLUSIONS

Uganda as one of the poorest countries in the world is still suffering under the effects of a turbulent history as well as under huge social gaps – gaps between a small rich elite and a poor majority. Poverty, combined with a poor living standard faces the country. Armed conflicts among rebel movements in border areas to Rwanda, the Democratic Republic of Congo and Sudan are aggravating circumstances.

(Inter)national programmes, policies and projects try to improve the peoples daily struggle for existence, their daily struggle against illnesses and early death caused among others of poor sanitation facilities and dirty drinking water. The fact that world wide approximately 90% of sewage is discharged untreated, polluting rivers, lakes, coastal areas and the groundwater improvements of the common (inadequate) sanitation systems seems to be obvious.

The two most widespread sanitation technologies, pit latrines and flush toilets, have limitations. “Flush-and-discharge” sanitation systems are expensive in operation, maintenance and waste precious sources of water. On the other hand “drop-and-store” technologies contaminate in many cases the groundwater. Together with a lack of space for digging deep pits, especially in the densely populated area of Kisoro, pit latrines are an inappropriate solution. Uganda suffers among other things environmental pollution, food insecurity as well as decreasing soil fertility. This situation requires new approaches for a sustainable development. EcoSan treats human excreta as a valuable source. The reuse of sanitised human urine and faeces give back plant nutrients to the nature, which are necessary for a sustainable food production. Most of the major plant nutrients, nitrogen, phosphorous and potassium are found in urine. A reuse of the liquid as manure in agriculture comprises a relatively low risk for transmitting of infectious diseases. Human faeces on the other hand are responsible for many diseases. To guarantee a safe reuse, all average period of 6 to 8 month for the dehydration or decomposition process is necessary. An increase in productivity and at the same time saving expensive fertilisers are an improvement for the living standard.

Since 1995 the Government of Austria supports Uganda to realise a better water and sanitation supply, especially in the South-western regions of Uganda. Kisoro, a small municipality next to the borders of Rwanda and the Democratic Republic of Congo, was chosen to implement a pilot study for EcoSan to improve the poor sanitation situation. By the year 1999 and 2000, 140 composting toilets, 107 dehydration toilets at domestic level, 3 dehydration toilets at institutions and 4 dehydration toilets for the public were constructed.

The co-operation with two students from the “Makerere University” forms the basis for this study in Kisoro. A questionnaire, a checklist, interviews and working with the local people are the main components to gain an insight into the project and to make following conclusions:

1. EcoSan facilities can be characterised as an appropriate technology to improve the poor sanitation situation in Kisoro Town.
2. Recycling of sanitised human excreta can help to prevent agricultural fields from soil erosion as well as from a decrease of soil fertility. Concepts for a sustainable recycling system depend primarily on the willingness of the toilet owners to handle the material and their knowledge about EcoSan systems. The users are more interested in a proper use of the facility and in recycling the dry material, if the units are private property. Furthermore, agricultural activities influence the interest of recycling. The majority of EcoSan system users and owners of fields and gardens are interested in the use of sanitised products.
3. Hiring somebody to empty the toilet chambers is a most likely solution for recycling the sanitised material in an effective way in the future. Currently two farmers are interested to fertilise their fields with the sanitised human excrements.

4. The MFA clarifies the linear nutrient flow for food and water in Kisoro Town. The nutrient cycles are open and waste the groundwater as well as the environment. Closing several processes should break down the linear flow. Examples are waste collecting concepts and reusing concepts of sanitised human excrements.
5. The HCA should guarantee a sustainable decentralised sanitation project in Kisoro Town. Based on the principle “people at the centre”, the household is first responsible for operation, maintenance and the reuse of the sanitised urine and faeces.
6. A further information and promotion campaign about the use of EcoSan facilities and the possibility of reusing the sanitised material is still necessary. Demonstration plots can be a helpful and additional step.

„To close the enormous sanitation gap in the developing world today, where several billions lack safe sanitation, waterborne sanitation has to give way to dry sanitation as a tested and valid alternative. Dry sanitation consisting of urine-separating toilets, with no or little water added, is a very elegant way to minimize water use and to create fertilizers both from urine and solid faecal matter. Human faeces can be seen as a resource that can be safely reused after reduction of pathogens and heavy metals. At the same time, poorly planned latrines - where insufficient attention is paid to hydrologic conditions - may generate groundwater pollution and make the city an unsafe and insecure place of residence and human activity.“

(Overall conclusion at the 9th Stockholm Water Symposium in 1999)

## 8. REFERENCES

- AUSTIN, A. (2001). Health Aspects of Ecological Sanitation. In: First International Conference on Ecological Sanitation. Abstract Volume. 5-8 November 2001. Nanning, China. p. 104-111.
- BAANANTE, C. and HENAO, J. (1999). Nutrient Depletion in the Agricultural Soils of Africa. 2020 Vision Brief 62. International Food Policy and Research Institute. Washington DC, USA.
- BACCINI, P. and BRUNNER, P. (1991). *Metabolism of the Anthroposphere*. Springer. New York, USA:
- BINDER, C. (1996). The Early Recognition of Environmental Impacts of Human Activities in Developing Countries. Dissertation ETH – Zürich. Nr. 11748. Zürich, Switzerland.
- BRANDBERG, B. (1997). *Latrine Building. A Handbook for Implementation of the SanPlat System*. Intermediate Technology Publications. London, United Kingdom.
- COAD, A. (2000). HCA – The Household-centred Approach – a new way to increase the sustainability of water and sanitation projects? A report on the 16<sup>th</sup> AGUASAN Workshop. 26-30 June 2000. SKAT. Switzerland.
- DEL PORTO, D. and STEINFELD, C. (2000). *The Composting Toilet System Book*. The Centre for Ecological Pollution Prevention. Concord, Massachusetts.
- DEPARTMENT OF AGRICULTURE (1998). *Kisoro District Agricultural Statistical Data*. Kisoro, Uganda.
- DFID-Department for International Development (1998). *Guidance Manual on Water Supply and Sanitation Programme*. London, United Kingdom.
- ESREY, S. (2001). Towards a Recycling Society: Ecological Sanitation – Closing the Loop to Food Security. In: *Water Science & Technology. Water Security for the 21<sup>st</sup> Century – Innovative Approaches*. Proceedings of the 10<sup>th</sup> Stockholm Water Symposium. August 14-17, 2000. Stockholm, Sweden. p. 177-187.
- ESREY, S. A., ANDERSSON, I., HILLERS, A. and SAWYER, R. (2001). *Closing the Loop. Ecological Sanitation for Food Security*. Sida. Stockholm, Sweden.
- ESREY, S. A., GOUGH, J., RAPAPORT, D., SAWYER, R., SIMPSON-HÉBERT, M., VARGAS, J. and WINBLAD, U. (1998). *Ecological Sanitation*. Sida. Stockholm, Sweden.
- GESELBRACHT, J. and VAN RIPER, C. (1998). Water Reclamation and Reuse. *Wat. Environ. Res.* 70. p. 586-589.
- GRADY, H. and THEIS, J. (1991). *Participatory Rapid Appraisal for Community Development. A Training Manual based on Experiences in the Middle East and North Africa*. International Institute for Environment and Development. London, United Kingdom.

- GUZHA, E. (2001). Ecological Sanitation Practice and Technology Development in Southern Africa and Zimbabwean Case Study. In: First International Conference on Ecological Sanitation. Abstract Volume. 5-8 November 2001. Nanning, China. p. 85-88.
- HOELLHUBER, F. and NYIRANEZA, D. (2001). Kisoro Town Ecological Sanitation, O&M Experience in South Western Uganda as Contribution to Water Resource Protection. In: First International Conference on Ecological Sanitation. Abstract Volume. 5-8 November 2001. Nanning, China. p. 82-84.
- JOHANSSON, M. (2001). Urine Separation – Closing the Nutrient Cycle. Stockholm Water Company. Stockholm, Sweden.
- JÖNSSON, H. (1997). Assessment of Sanitation Systems and Reuse of Urine. In: Drangert, J-O., Bew, J., Winblad, U. (1997). Ecological Alternatives in Sanitation. Proceedings from Sida Sanitation Workshop. 6-9 August 1997. Balingsholm, Sweden. p. 11-22.
- JÖNSSON, H. (2001). Source Separation of Human Urine – Separation Efficiency and Effects on Water Emissions, Crop Yield, Energy Usage and Reliability. In: First International Conference on Ecological Sanitation. Abstract Volume. 5-8 November 2001. Nanning, China. p. 39-45.
- JÖNSSON, H., STENSTRÖM, T-A., SVENSSON, J. and SUNDIN, A. (1997). Source Separated Urine - Nutrient and Heavy Metal Content, Water Saving and Faecal Contamination. *Wat. Sci. Tech.* 1997, 35(9), p. 145-152.
- KIEVELITZ, U. and SCHÖNHUTH, M. (1993). Partizipative Erhebungs- und Planungsmethoden in der Entwicklungszusammenarbeit: Rapid Rural Appraisal, Participatory Appraisal. Deutsche Gesellschaft für Technische Zusammenarbeit (GTZ). Eschborn, Germany.
- KILMA, W. and WINBLAD, U. (1985). Sanitation without Water. MacMillan Education Ltd. Stockholm, Sweden.
- KITOWASO (2001). Report on the Evaluation of the Kisoro EcoSan Toilet Pilot Programme 1999 – 2001. 10th April 2001 - 12th April 2001. Kisoro, Uganda.
- LAMPERT, C. (2000). Methodology of Material Flow Analysis. <http://insma.udg.es/isse2000/summary/lampert1.html>. Date of visit: 21/02/02.
- LARSSON, K. (2001). Opening Address of the 10<sup>th</sup> Stockholm Water Symposium. In: Water Science & Technology. Water Security for the 21<sup>st</sup> Century – Innovative Approaches. Proceedings of the 10<sup>th</sup> Stockholm Water Symposium. August 14-17, 2000. Stockholm, Sweden. p. 11-12.
- LEGGETT, I. (2001). Uganda. An Oxfam Country Profile. Oxfam, United Kingdom.
- LENS, P., LETTINGA, G. and ZEEMAN, G. (2001). Environmental Protection Technologies for Sustainable Development. In: Lens, P., Zeeman, G. and Lettinga, G. (Hrsg.). Decentralised Sanitation and Reuse: Concepts, Systems and Implementation. IWA Publishing. London, United Kingdom. p. 3-10.



- NALUBEGA, M., SCHATTAUER, H. and TUSHABE, A-A. (2001). Experiences with Ecological Sanitation in South Western Uganda. In: First International Conference on Ecological Sanitation. 5-8 November 2001. Nanning, China. p. 78-81.
- NIEMCZYNOWICZ, J. (2001). The Urban Sanitation Dilemma. In: Lens, P., Zeeman, G. and Lettinga, G. (Hrsg.). Decentralised Sanitation and Reuse: Concepts, Systems and Implementation. IWA Publishing. London, United Kingdom. p116-129.
- NOHLEN, D. (2000). Lexikon Dritte Welt. Rowohlt Taschenbuch Verlag. Reinbek, Germany.
- NORPLAN (U) Ltd. (1997). Environment Profile Report for Kisoro District. Final Report. Kampala, Uganda.
- NTEZIRYAYO, B. (1999). New Kisoro Town Water Supply to be Operational. In: Kisoro Today, Vol. 3 1999. Kisoro, Uganda. p. 11-12.
- OEFS (2001). [www.oefse.at/german/publikat/profile/uganda/ug\\_geo.htm](http://www.oefse.at/german/publikat/profile/uganda/ug_geo.htm). Date of visit: 15/01/2002.
- OTTERPOHL, R. (2001). Design of Highly Efficient Source Control Sanitation and Practical Experiences. In: Lens, P., Zeeman, G. and Lettinga, G. (Hrsg.). Decentralised Sanitation and Reuse: Concepts, Systems and Implementation. IWA Publishing. London, United Kingdom. p. 164-180.
- PIEPER, W. (2001). Das Scheiß-Buch. Der Grüne Zweig 123. Löhrbach, Germany.
- SCHERTENLEIB, R. (2000). Household-centred Approach in Environmental Sanitation. Background Paper for the AGUASAN – Workshop 16/2000. WSSCC. Dübendorf, Switzerland.
- SCHERTENLEIB, R. (2001). Principles and Implications of Household Centred-Approach in Environmental Sanitation. In: First International Conference on Ecological Sanitation. Abstract Volume. 5-8 November 2001. Nanning, China. p. 28-34.
- SCHÖNNING, C. (2001). Evaluation of Microbial Health Risks Associated with the Reuse of Human Urine. Swedish Institute for Infectious Disease Control, Royal Institute of Technology. Stockholm, Sweden.
- SKOGSFORS, S.-E. (2001). Opening Speech of the 10<sup>th</sup> Stockholm Water Symposium. In: Water Science & Technology. Water Security for the 21<sup>st</sup> Century – Innovative Approaches. Proceedings of the 10<sup>th</sup> Stockholm Water Symposium. August 14-17, 2000. Stockholm, Sweden. p. 7-9.
- STENSTRÖM, T. A. (2001). Reduction Efficiency of Index Pathogens in Dry Sanitation Compared with Traditional and Alternative Wastewater Treatment Systems. In: First International Conference on Ecological Sanitation. Abstract Volume. 5-8 November 2001. Nanning, China. p. 7-11.

- SWI – Österreichische Stiftung für Weltbevölkerung und internationale Zusammenarbeit (2001). Soziale und demographische Daten zu den Ländern und Regionen der Welt. SWI. Vienna, Austria.
- TANNER, R. (1995). Excreting, Excretors and Social Policy. Some Cross-Cultural Observations on an Underresearched Activity. *J. Preventive Medicine & Hygiene*. 1995. 36(N) ¾ p. 1-10.
- TBW (1996). South Western Towns Water and Sanitation Project, Hydrogeological Study for the Water Supply of Kisoro. Technisches Büro Weidl. Volders, Austria and Kisoro, Uganda.
- TBW (1999). Dry Sanitation Detail Design Draft Technical Report. Technisches Büro Weidl. Volders, Austria and Kisoro, Uganda.
- TBW (2001). Kisoro District Rural Water and Sanitation Project - Technical Proposal. Technisches Büro Weidl. Volders, Austria.
- UN (1998). [www.un.org/depts/dhl/maplib/docs/uganda.pdf](http://www.un.org/depts/dhl/maplib/docs/uganda.pdf). Date of visit: 17/02/2002.
- UNDP (1998). Uganda National Human Development Report. UNDP. 1998. <http://www.imul.com/undp/hdr96.html>. Date of visit: 15/01/2002.
- UNDP (2001). Human Development Indicators. [www.undp.org/hdr2001/](http://www.undp.org/hdr2001/). Date of visit: 15/01/2002.
- UNICEF/IRC (1998). A Manual on School Sanitation and Hygiene. Towards Better Programming. New York, USA.
- WHO-World Health Organisation (1996). Creating Healthy Cities in the 21<sup>st</sup> Century. Geneva, Switzerland.
- WINBLAD, U. (1997). Ecological Sanitation – A Global Overview. In: Drangert, J-O., Bew, J., Winblad, U. (1997). Ecological Alternatives in Sanitation. Proceedings from Sida Sanitation Workshop. 6-9 August 1997. Balingsholm, Sweden. p. 3.
- WORLD BANK (2001). [www.worldbank.org/data/countrydata/countrydata.html#AAG](http://www.worldbank.org/data/countrydata/countrydata.html#AAG). Date of visit: 09/01/2002.

## 9. ANNEXES

<i>Annex A: Questionnaires</i>	<i>A2</i>
<i>Annex B: Check lists</i>	<i>A31</i>
<i>Annex C: Interviews</i>	<i>A42</i>
<i>Annex D: Protocols of two farmers who are willing to use the toilet products</i>	<i>A48</i>

---

**ANNEX A: QUESTIONNAIRES**

<b>(i) Questionnaire for respondents who use the EcoSan system</b>	<b>A4</b>
<b>(ii) Evaluation of:</b>	
<b>public composting units</b>	<b>A8</b>
<b>composting units on household level</b>	<b>A12</b>
<b>public dehydration units</b>	<b>A16</b>
<b>dehydration units on household level</b>	<b>A20</b>
<b>agriculture and organic waste disposal</b>	<b>A23</b>
<b>(iii) Questionnaire for respondents who do not have or have and do not use the EcoSan system</b>	<b>A26</b>
<b>(iv) Evaluation of:</b>	
<b>composting units not in use</b>	<b>A28</b>
<b>dehydration units not in use</b>	<b>A29</b>
<b>respondents without a facility</b>	<b>A30</b>

**(i) Questionnaire for respondents who use the EcoSan system**

## ECO SANITATION STUDY IN KISORO

### QUESTIONNAIRE ADMINISTERED TO RESPONDENTS (WHO USE THE ECOSAN FACILITY)

Date:.....

#### A) LOCATION<sup>a</sup>

DISTRICT:..... COUNTY:.....

SUBCOUNTY:..... PARISH:.....

LOCAL COUNCIL I/VILLAGE:.....

#### B) HOUSEHOLD INFORMATION<sup>b</sup>

Name Household (optional):.....

Number of Household Members:.....  
                                     WOMEN (    )                      MEN (    )                      CHILDREN (    )

Source of Family Income:.....

Education Background:.....

#### C) EXCRETA DISPOSAL/MANAGEMENT

1. What method of excreta disposal did you use before adapting the EcoSan toilet?

- |                           |              |
|---------------------------|--------------|
| Pit latrine               | (    )       |
| Water Closets/Septic tank | (    )       |
| Sewer system              | (    )       |
| None                      | (    )       |
| Others (specify)          | (    ):..... |

2. Do you see any advantages compared to the former system?  
 .....

3. Who first talked to you/encouraged you about using the system?.....

---

<sup>a</sup> Answers to these questions were always the same.

<sup>b</sup> A detailed evaluation of this part was not possible due to inexact answers of the respondents.

4. For how long have you been using the system? (indicate if any chamber is full and time taken).....

5. What type of EcoSan toilet do you prefer? Squatter ( ) Sitter ( )  
Reasons:.....  
.....  
.....

6. What material do you use for anal cleansing?  
Water ( )  
Tissue/Toilet paper ( )  
Others ( ) Specify.....

7. What type of toilet are you using? Composting ( ) Dehydrating ( )  
Is it your preference? Reasons:.....

8. Regarding dehydrating units: What dehydrating agent do you use?  
Lime ( )  
Ash ( )  
Mixture (soil/lime) ( )  
Others ( ) Specify.....

9. Do you find difficulty in obtaining the dehydrating agent? YES ( ) NO ( )

10. Do you have any problems handling the final product yourself?  
.....

11. Who maintains/manages the operation of the facility?  
Household members ( )  
Community members ( )  
Local Council/Municipal Council ( )  
Do you pay for the maintenance service? No ( ) Yes ( )  
If Yes, How much?.....  
Do you find the fee fair?.....  
If NO, are you willing to pay for the maintenance? YES ( ) NO ( )

12. Do the following groups of people find problems using the system? (specify if any)  
Men YES ( ) NO ( ) :.....  
Women YES ( ) NO ( ) :.....  
Children YES ( ) NO ( ) :.....  
Aged YES ( ) NO ( ) :.....  
Disabled YES ( ) NO ( ) :.....

13. What other problems have you identified with the EcoSan system? (e.g. odours, flies,...)  
.....  
.....  
.....

14. What suggestions would you make concerning the improvement of the EcoSan system?  
.....  
.....

**D) AGRICULTURE AND ORGANIC WASTE DISPOSAL**

15. What do you use the products from the EcoSan for?.....

16. Do/Can you use the following products from the EcoSan toilets as fertilisers?

**Urine:**

YES  On which crops:.....

NO  Why?.....

**Composted/dehydrated faeces:**

YES  On which crops:.....

NO  Why?.....

17. Where are the agricultural fields located (if any)? How far, if not near home?  
.....

18. Are they  subsistence  or commercial ?

19. Do you use any fertilisers at the moment?

Specify:.....

20. Which foods do you usually consume from

your garden:..... market:.....

.....

.....

.....

.....

21. What method do you use for organic waste disposal?

organic fertiliser

others  specify:.....

22. How much organic waste do you produce per day (entire household)?  
.....

23. Can/do you use the organic wastes combined with decomposed faeces?

YES  NO

If NO, why?.....

If YES, how are you doing it?.....



**(ii) Evaluation of:**

- **public composting units**
- **composting units on household level**
- **public dehydration units**
- **dehydration units on household level**
- **agriculture and organic waste disposal**

**EVALUATION: COMPOSTING UNITS - public** (9 respondents)

A detailed evaluation of Part A) and B) was not possible, respectively useful.

**B) HOUSEHOLD INFORMATION**

Number of users:

	<b>NUMBER OF USERS</b>
Travellers Hotel (staff)	13
Kindley Petrol Station	3 + customer
Police Station	10 - 20
Catholic Church	~100
Aunt Phina Primary School	100 - 150
Mr. Harera (different households + bar)	~20
Mr. Munyambabazi (bar)	~12
Gashumba Guest House (bar)	
Mr. Mbyariyehe (bar)	~10

**C) EXCRETA DISPOSAL**

1. What method of excreta disposal did you use before adapting the EcoSan toilet?

<i>Method used before</i>	<i>Number of respondents</i>
pit latrine	8
water closet/septic tank	
sewered system	1
VIP	
others:	
none	

2. Advantages compared to the former system (mainly pit latrine)

<i>Advantages</i>	<i>Number of respondents</i>
no smell	3
no flies	3
permanence of the system/cheaper	2
reuse of the products	2
easier to empty	1
cannot fall into it	1
easier to clean	3

3. Who first talked to you/encouraged you about using the system?  
Most information from KITOWASO.

4. For how long have you been using the system?

<i>Time in years</i>	<i>Number of respondents</i>
0 - ½	
½ 1	7
1 - 1½	
1 ½ 2	7
doesn't know	

Indicate if any chamber is full and time taken

<i>Chambers</i>	<i>Number of respondents</i>
not full	8
full	1

5. What type of EcoSan toilet do you prefer?

<i>Preferred type</i>	<i>Number of respondents</i>
squatter	6
sitter	3

<i>Reasons for squatter</i>	<i>Number of respondents</i>
easier to use for children	1
fear of contracting diseases on sitter	1
better for public use	1
doesn't know	3

<i>Reasons for sitter</i>	<i>Number of respondents</i>
easy use for everybody	1
separation is easy for women	1
comfortable, you don't get tired	1

6. What material do you use for anal cleansing?

<i>Used material</i>	<i>Number of respondents</i>
water	1
toilet paper	5
newspaper	3
leaves/grass	3
nothing	

## 7. What type of toilet are you using? Is it your preference?

Respondents do not know the different types; different types were offered in different phases of the project.

## 8. Regarding dehydrating units: What dehydrating agent do you use?

<i>Dehydration agent</i>	<i>Number of respondents</i>
lime	
ash	7
soil	
sawdust	1
others	1 (grass)
none	1

## 9. Do you find difficulty in obtaining the dehydrating agent?

	<i>Number of respondents</i>
yes	3
no	4
sometimes	1
no idea	1
don't use	

## 10. Do you have any problems handling the final product yourself?

<i>Problems</i>	<i>Number of respondents</i>
can	2
cannot	5
waiting for KI-TOWASO	2
no idea	

## 11. Who maintains/manages the operation of the facility?

	<i>Number of respondents</i>
household members	6
community members	
KITOWASO	1
hire a cleaner	2
no answer/no one	

Who will remove the products?

	<i>Number of respondents</i>
hire somebody	7
him/herself	

depends on the price	1
doesn't know yet	
KITOWASO	1
no answer	

12. Do the following groups of people find problems using the system?

	<i>women</i>	<i>men</i>	<i>children</i>	<i>aged</i>	<i>disabled</i>
pregnant	1				
can fall inside/accidents				2	
improper use	1			1	

13. What other problems have you identified with the EcoSan system?

<i>Problems</i>	<i>Number of respondents</i>
removing the material	1
structure too small	1
improper use	1
smell	2
ash is hard to optaine	1
hole too close to the door/wall	1

14. What suggestions would you make concerning the improvement of the EcoSan system?

<i>Suggestion</i>	<i>Number of respondents</i>
further education on the use	1
bigger structure/hole	1
wants sewer sanitation	1
increase size of chamber	1
recommend it everybody	1

**EVALUATION: COMPOSTING UNITS - household** (17 respondents)

A detailed evaluation of Part A) and B) was not possible, respectively useful.

**C) EXCRETA DISPOSAL**

1. What method of excreta disposal did you use before adapting the EcoSan toilet?

<i>Method used before</i>	<i>Number of respondents</i>
pit latrine	16
water closet/septic tank	
sewered system	
VIP	
others:	1 (public toilet)
none	

2. Advantages compared to the former system (mainly pit latrine)

<i>Advantages</i>	<i>Number of respondents</i>
no smell	4
no flies	2
permanence of the system/cheaper	4
reuse of the products	3
better structure	2
can be built near the house	1
private toilet	1
easier to clean	5
same as pit latrine	2
use of local material for maintenance	1

3. Who first talked to you/encouraged you about using the system?  
Most information from KITOWASO.

4. For how long have you been using the system?

<i>Time in years</i>	<i>Number of respondents</i>
0 - ½	6
½ 1	5
1 - 1½	2
1 ½ 2	3
doesn't know	1

Indicate if any chamber is full and time taken

<i>Chambers</i>	<i>Number of respondents</i>
not full	17
full	

5. What type of EcoSan toilet do you prefer?

<i>Preferred type</i>	<i>Number of respondents</i>
squatter	14
sitter	3

<i>Reasons for squatter</i>	<i>Number of respondents</i>
easily use by children	1
fear of contracting diseases on sitter	3
easy to clean	2
suitable for urination	1
used to squatter	1
blockage of urine - diversion on sitter	1
sitter requires more toilet paper	1
doesn't know	2
only one he/she knows	4

<i>Reasons for sitter</i>	<i>Number of respondents</i>
more comfortable for old aged/sick people	1
no urine contact	1
the only type he/she knows	1

6. What material do you use for anal cleansing?

<i>Used material</i>	<i>Number of respondents</i>
water	3
toilet paper	14
newspaper	7
leaves/grass	
nothing	

7. What type of toilet are you using? Is it your preference?

Respondents do not know the different types; different types were offered in different phases of the project.

8. Regarding dehydrating units: What dehydrating agent do you use?

<i>Dehydration agent</i>	<i>Number of respondents</i>
lime	1
ash	15

soil	
sawdust	2
others	1 (dry banana leaves)
none	1

9. Do you find difficulty in obtaining the dehydrating agent?

	<i>Number of respondents</i>
yes	3
no	13
sometimes	
no idea	
don't use	1

10. Do you have any problems handling the final product yourself?

<i>Problems</i>	<i>Number of respondents</i>
can	4
cannot	9
waiting for KI-TOWASO	2
no idea	2

11. Who maintains/manages the operation of the facility?

	<i>Number of respondents</i>
household members	14
community members	
KITOWASO	
hire a cleaner	
no answer/no one	3

Who will remove the products?

	<i>Number of respondents</i>
hire somebody	9
him/herself	3
depends on the price	1
doesn't know yet	1
KITOWASO	1
no answer	3

12. Do the following groups of people find problems using the system?

	<i>women</i>	<i>men</i>	<i>children</i>	<i>aged</i>	<i>disabled</i>
squatting because of age					1



squatting not comfortable		1
improper use		1
man's dick contact with the diversion	1	
hole is too big (falling inside)		3
no privacy after use	1	

13. What other problems have you identified with the EcoSan system?

<i>Problems</i>	<i>Number of respondents</i>
steps are too high	1
structure too small	6
improper use	1
smell	2
flies	1
ash is hard to optaine	1
leaking structure	1
hole too close to the door/wall	2
hole too small	1
urine spills around	1
hard to get toilet paper	1

14. What suggestions would you make concerning the improvement of the EcoSan system?

<i>Suggestion</i>	<i>Number of respondents</i>
further education on the use	1
bigger structure/hole	6
using of local material	1
recommends dehydration	2
include bathroom	1
increase size of chamber	1
separation for men and women	1
recommend it everybody	1

**EVALUATION: DEHYDRATION UNITS - public** (11 respondents)

A detailed evaluation of Part A) and B) was not possible, respectively useful.

**B) HOUSEHOLD INFORMATION**

Number of users:

	<i>Number of users</i>
Public Toilet Taxi Park	~40 (on market days)
Public Toilet New Market	~20 (on market days)
Public Toilet Old Market	~20 (on n
Shalom Foundation Nursery School	~25
Teacher Training Centre	~100
Mosque	~10
KITOWASO Office	~13
Town Council	~50
Mr. Wilson (bar)	~10
Mr. Nana (bar)	
Senlina Supermarket + bar	

**C) EXCRETA DISPOSAL**

1. What method of excreta disposal did you use before adapting the EcoSan toilet?

<i>Method used before</i>	<i>Number of respondents</i>
pit latrine	8
water closet/septic tank	
sewered system	
VIP	1
others:	1 (compost EcoSan)
none	1

2. Advantages compared to the former system (mainly pit latrine)

<i>Advantages</i>	<i>Number of respondents</i>
no smell	4
easier to empty	1
permanence of the system/cheaper	2
reuse of the products	2
easier to clean	5
same as pit latrine	1
no answer/don't know	2

3. Who first talked to you/encouraged you about using the system?  
Most information from KITOWASO.

4. For how long have you been using the system?

<i>Time in years</i>	<i>Number of respondents</i>
0 - ½	1
½ 1	6
1 - 1½	
1 ½ 2	3
doesn't know	1

Indicate if any chamber is full and time taken

<i>Chambers</i>	<i>Number of respondents</i>
not full	8
full	3

5. What type of EcoSan toilet do you prefer?

<i>Preferred type</i>	<i>Number of respondents</i>
squatter	8
sitter	3

<i>Reasons for squatter</i>	<i>Number of respondents</i>
more hygienic	2
fear of contracting diseases on sitter	4
better for public use	1
sitter feels cold	1
misuse the sitter	2

<i>Reasons for sitter</i>	<i>Number of respondents</i>
adequate when using water for anal cleansing	1
doesn't know why	1

6. What material do you use for anal cleansing?

<i>Used material</i>	<i>Number of respondents</i>
water	1
toilet paper	9
newspaper	3
leaves/grass	1
nothing	

## 7. What type of toilet are you using? Is it your preference?

Respondents do not know the different types; different types were offered in different phases of the project.

## 8. Regarding dehydrating units: What dehydrating agent do you use?

<i>Dehydration agent</i>	<i>Number of respondents</i>
lime	1
ash	11
soil	
sawdust	
others	
none	

## 9. Do you find difficulty in obtaining the dehydrating agent?

	<i>Number of respondents</i>
yes	4
no	4
sometimes	1
no idea	
don't use	

## 10. Do you have any problems handling the final product yourself?

<i>Problems</i>	<i>Number of respondents</i>
can	6
cannot	4
waiting for KI-TOWASO	
no idea	1

## 11. Who maintains/manages the operation of the facility?

	<i>Number of respondents</i>
household members	4
community members	
KITOWASO	3
hire a cleaner	3
no answer/no one	1

Who will remove the products?

	<i>Number of respondents</i>
hire somebody	4
him/herself	1

depends on the price	1
doesn't know yet	1
KITOWASO	4
no answer	

12. Do the following groups of people find problems using the system?

	<i>women</i>	<i>men</i>	<i>children</i>	<i>aged</i>	<i>disabled</i>
squatting because of age				1	
steps are too high					1
improper use			1		
man's dick contact with the diversion		1			
unhygienic sitter	1				
urine separation inadequate (sitter)	2				

13. What other problems have you identified with the EcoSan system?

<i>Problems</i>	<i>Number of respondents</i>
blockage of pipe	3
structure too small	1
improper use	4
no roof overhang	1
smell	1
flies	1
cleaning water enters the chamber	1
broken sitter	1
too much water of cleaning sitter	1
no lighting	1
people don't like sitter	1

14. What suggestions would you make concerning the improvement of the EcoSan system?

<i>Suggestion</i>	<i>Number of respondents</i>
increase the roof overhang	1
further education on the use	1
bigger structure/hole	1
preference to squat	2
improve the drainage	2
pipes/plumbing	
KITOWASO should finish the structure	1
urinal outside	1
provide lighting	1

**EVALUATION: DEHYDRATION UNITS - household** (11 respondents)

A detailed evaluation of Part A) and B) was not possible, respectively useful.

**C) EXCRETA DISPOSAL**

1. What method of excreta disposal did you use before adapting the EcoSan toilet?

<i>Method used before</i>	<i>Number of respondents</i>
pit latrine	10
water closet/septic tank	
sewered system	
VIP	
others:	1 (public toilet)
none	

2. Advantages compared to the former system (mainly pit latrine)

<i>Advantages</i>	<i>Number of respondents</i>
no smell	3
no flies	2
permanence of the system/cheaper	1
reuse of the products	4
better structure	3
can be built near the house	1
private toilet	1
easier to empty	1
same as pit latrine	1
no answer/don't know	2

3. Who first talked to you/encouraged you about using the system?  
Most information from KITOWASO.

4. For how long have you been using the system?

<i>Time in years</i>	<i>Number of respondents</i>
0 - ½	2
½ 1	7
1 - 1½	2
1 ½ 2	
doesn't know	

Indicate if any chamber is full and time taken

<i>Chambers</i>	<i>Number of respondents</i>
not full	8
full	3

5. What type of EcoSan toilet do you prefer?

<i>Preferred type</i>	<i>Number of respondents</i>
squatter	6
sitter	5

<i>Reasons for squatter</i>	<i>Number of respondents</i>
easily use by children	1
fear of contracting diseases on sitter	1
easy to clean	1
better to use	1
easy target/direction	1
only one he/she knows	1

<i>Reasons for sitter</i>	<i>Number of respondents</i>
more comfortable for old aged/sick people	3
no spilling of urine	1

6. What material do you use for anal cleansing?

<i>Used material</i>	<i>Number of respondents</i>
water	1
toilet paper	9
newspaper	8
leaves/grass	1
nothing	

7. What type of toilet are you using? Is it your preference?

Respondents do not know the different types; different types were offered in different phases of the project.

8. Regarding dehydrating units: What dehydrating agent do you use?

<i>Dehydration agent</i>	<i>Number of respondents</i>
lime	
ash	11
soil	1
sawdust	1
others	
none	

9. Do you find difficulty in obtaining the dehydrating agent?

<i>Number of respondents</i>	
yes	3
no	8
sometimes	
no idea	
don't use	

10. Do you have any problems handling the final product yourself?

<i>Problems</i>	<i>Number of respondents</i>
can	6
cannot	4
waiting for KI-TOWASO	
no idea	1

11. Who maintains/manages the operation of the facility?

<i>Number of respondents</i>	
household members	6
community members	
KITOWASO	
hire a cleaner	
no answer/no one	5

Who will remove the products?

<i>Number of respondents</i>	
hire somebody	6
him/herself	2
depends on the price	1
doesn't know yet	2
KITOWASO	
no answer	

12. Do the following groups of people find problems using the system?

	<i>women</i>	<i>men</i>	<i>children</i>	<i>aged</i>	<i>disabled</i>
squatting because of age	1				
squatting not comfortable					1
steps are too high				1	



13. What other problems have you identified with the EcoSan system?

<i>Problems</i>	<i>Number of respondents</i>
steps are too high	1
improper use	1
blockage of pipe	1
structure too small	1
people steal the urine jerrycans	1
removing the material	1

14. What suggestions would you make concerning the improvement of the EcoSan system?

<i>Suggestion</i>	<i>Number of respondents</i>
put chamber doors in reach	1
wants sewer sanitation	1
increase the roof overhang	1
improve the drainage	1
pipes/plumbing	1
put my sitter back (KI-TOWASO repair)	1

**EVALUATION: COMPOSTING/DEHYDRATION UNITS – public**

(20 respondents)

**D) AGRICULTURE AND ORGANIC WASTE DISPOSAL**

	with gardens	without gardens
reuse as manure	2	
hire somebody/ depending on the price	4	4
bury		
do not know yet/no idea		4
KITOWASO	1	5

**EVALUATION: COMPOSTING/DEHYDRATION UNITS – household**

(28 respondents)

**D) AGRICULTURE AND ORGANIC WASTE DISPOSAL**

	with gardens	without gardens
reuse as manure	8	
hire somebody/ depending on the price	4	1
bury	1	
do not know yet/no idea	6	2
KITOWASO	6	

**(iii) Questionnaire for respondents who do not have or have and do not use the EcoSan system**

## ECO SANITATION STUDY IN KISORO

**QUESTIONNAIRE ADMINISTERED TO RESPONDENTS**  
(WHO DO NOT HAVE OR HAVE BUT DO NOT USE THE ECOSAN FACILITY)

Date:.....

### A) LOCATION<sup>c</sup>

DISTRICT:..... COUNTY:.....

SUBCOUNTY:..... PARISH:.....

LOCAL COUNCIL I/VILLAGE:.....

### B) HOUSEHOLD INFORMATION<sup>d</sup>

Name Household (optional):.....

Number of Household Members:.....  
WOMEN ( )                      MEN ( )                      CHILDREN ( )

Source of Family Income:.....

Education Background:.....

### C) EXCRETA DISPOSAL/MANAGEMENT

1. What kind of toilet are you using at the moment?  
.....

2. Has anyone talked to you about the operation/advantages of the EcoSan toilets? If yes, who?.....

3. Do you think you would have any problems handling the final products of the system e.g. urine and composted faeces?.....

4. Why are you not using the EcoSan toilet?  
.....  
.....

<sup>c</sup> Answers to these questions were always the same.

<sup>d</sup> A detailed evaluation of this part was not possible due to inexact answers of the respondents.

**(iv) Evaluation of:**

- **composting units not in use**
- **dehydration units not in use**
- **respondents without a facility**

**EVALUATION: COMPOSTING UNITS- not in use** (4 respondents)

A detailed evaluation of Part A) and B) was not possible, respectively useful.

**C) EXCRETA DISPOSAL/MANAGEMENT**

1. What kind of toilet are you using at the moment?

	<i>household</i>	<i>public</i>
pit latrine	3	1
VIP		
EcoSan - compost		

2. Has any one talked to you about the operation/advantages of the EcoSan toilets?

	<i>household</i>	<i>public</i>
KI-	2	1
TOWASO		
others	1 (friends)	

3. Do you think you would have any problems handling the final products of the system?

	<i>household</i>	<i>public</i>
can		1
can, but would prefer to hire		1
cannot	1	1

4. Why are you not using the EcoSan toilet?

	<i>household</i>	<i>public</i>
not complete	1 (financial problem)	1
current one not yet full		2

**EVALUATION: DEHYDRATING - not in use** (4 respondents)

A detailed evaluation of Part A) and B) was not possible, respectively useful.

**C) EXCRETA DISPOSAL/MANAGEMENT**

1. What kind of toilet are you using at the moment?

	<i>household</i>	<i>public</i>
pit latrine	2	
VIP		1
EcoSan - compost		1

2. Has any one talked to you about the operation/advantages of the EcoSan toilets?

	<i>household</i>	<i>public</i>
KI-TOWASO	2	2
others		

3. Do you think you would have any problems handling the final products of the system?

	<i>household</i>	<i>public</i>
can	1	1
cannot	1	
do not know yet		1

4. Why are you not using the EcoSan toilet?

	<i>household</i>	<i>public</i>
not complete	1	
currently one, not yet full	1	1
structure broke down (urine pipe blocked)		1

**EVALUATION: NOT YET BUILT - St. Gertrude's Secondary School**

(School population about 350)

A detailed evaluation of Part A) and B) was not possible, respectively useful.

**C) EXCRETA DISPOSAL/MANAGEMENT**

1. What kind of toilet are you using at the moment?

	<i>public</i>	
pit latrine		1

2. Has any one talked to you about the operation/advantages of the EcoSan toilets?

	<i>public</i>	
others		1 (friends)

3. Do you think you would have any problems handling the final products of the system?

	<i>public</i>	
can		1

4. Why are you not building an EcoSan toilet?

	<i>public</i>	
expensive		1

**Remarks:**

- Respondent (a sister of the school) is very well informed and really interested to build an EcoSan facility for St. Gertrude's Secondary School.
- She collected information from different sources for her own.
- She is interested to build an EcoSan demonstration unite at her school to educate pupils about the importance of sanitation.
- Advantage over the pit latrine: they don't have to dig a new pit in the ground; reuse of the sanitised products as manure; no smell, no odour; more hygienic over the currently used system.



**ANNEX B: CHECK LISTS**

<b>(i) Check list for composting toilets</b>	<b>A33</b>
<b>(ii) Evaluation for composting toilets:</b>	
<b>public units and</b>	<b>A35</b>
<b>household facilities</b>	<b>A36</b>
<b>(iii) Check list for dehydration toilets</b>	<b>A38</b>
<b>(iv) Evaluation for dehydration toilets:</b>	
<b>public units and</b>	<b>A40</b>
<b>household facilities</b>	<b>A41</b>

**(i) Check list for composting toilets**

## SANITARY SURVEY FORM FOR ECOSANITATION SYSTEMS CHECK LIST

### COMPOSTING TOILETS

#### A) GENERAL INFORMATION<sup>e</sup>

Date:.....

Location of the facility (distance from house):.....

Nature of the facility (communal, household, institutional):.....

Number of users:.....

Number of chambers:.....

Time in use:.....

Date of last emptying:.....

#### B) SPECIFIC INFORMATION

- |   |                |
|---|----------------|
| 1. Is the rain shield present on the vent?      | YES( ) / NO( ) |
| 2. Is the vent functional?                      | YES( ) / NO( ) |
| 3. Are the chamber contents adequately aerated? | YES( ) / NO( ) |
| 4. Is cleaning water drained into the chamber?  | YES( ) / NO( ) |
| 5. Is the system smelling?                      | YES( ) / NO( ) |
| 6. Are there flies/insects?                     | YES( ) / NO( ) |
| 7. Is the system adequately clean?              | YES( ) / NO( ) |

#### REMARKS

<sup>e</sup> A detailed evaluation of this part was not possible due to inexact answers of the respondents.

- (ii) Evaluation for composting toilets:**
- **public units and**
  - **household facilities**

## SANITARY SURVEY FORM FOR ECOSANITATION SYSTEMS CHECK LIST

### COMPOSTING TOILETS – PUBLIC (9 RESPONDENTS)

A detailed evaluation of Part A) was not possible, respectively useful.

#### B) SPECIFIC INFORMATION

	<i>yes</i>	<i>no</i>	<i>no answer</i>
1. Is the rain shield present on the vent?	1	8	
2. Is the vent functional?	4	5	
3. Are the chamber contents adequately aerated?	3	6	
4. Is cleaning water drained into the chamber?			9
5. Is the system smelling?	4	5	
6. Are there flies/insects?	3	6	
7. Is the system adequately clean?	1	8	

#### Remarks:

	Number of respon- dents
no dehydration agent	6
chamber content wet	2
vent pipe is too short	1
not aware how to use	1
improper use	3
use too much water for cleaning	1

## SANITARY SURVEY FORM FOR ECOSANITATION SYSTEMS CHECK LIST

### COMPOSTING TOILETS – HOUSEHOLD (17 RESPONDENTS)

A detailed evaluation of Part A) was not possible, respectively useful.

#### B) SPECIFIC INFORMATION

	<i>yes</i>	<i>no</i>	<i>no answer</i>
1. Is the rain shield present on the vent?		17	
2. Is the vent functional?	15	1	1
3. Are the chamber contents adequately aerated?	12	4	1
4. Is cleaning water drained into the chamber?			17
5. Is the system smelling?	2	14	1
6. Are there flies/insects?	1	15	1
7. Is the system adequately clean?	12	4	1

#### Remarks:

	<i>1.1 Number of re- spondents</i>
local material used for construction	1
incomplete construction	3
toilet was closed (not possible to look inside)	1
stagnant water in the toilet (smell like urine)	1
no dehydration agent	5
plastic bags in the chamber	1
does not work properly	1
not aware how to use (using ash)	1
use too much water for cleaning	1
vent too short	1
using both chambers at the same time	1
chamber content wet	4
vent shield broken	1

**(iii) Check list for dehydration toilets**

## SANITARY SURVEY FORM FOR ECOSANITATION SYSTEMS CHECK LIST

### DEHYDRATING TOILETS

#### A) GENERAL INFORMATION<sup>f</sup>

Date:.....

Location of the facility (distance from house):.....

Nature of the facility (communal, household, institutional):.....

Number of users:.....

Number of chambers:.....

Time in use:.....

Date of last emptying:.....

#### B) SPECIFIC INFORMATION

- |  |                |
|--|----------------|
| 1. Is the rain shield present on the vent? | YES( ) / NO( ) |
| 2. Is the vent functional?                 | YES( ) / NO( ) |
| 3. Is the dehydrating agent present?       | YES( ) / NO( ) |
| 4. Is the dehydrating agent used?          | YES( ) / NO( ) |
| 5. Are the chamber contents dry (heaped)?  | YES( ) / NO( ) |
| 6. Is the system smelling?                 | YES( ) / NO( ) |
| 7. Are there flies / insects?              | YES( ) / NO( ) |
| 8. Is the urine diversion system sanitary? | YES( ) / NO( ) |
| 9. Is the system adequately clean?         | YES( ) / NO( ) |

Remarks

<sup>f</sup> A detailed evaluation of this part was not possible due to inexact answers of the respondents.



- (iv) Evaluation for dehydration toilets:**
- **public units and**
  - **household facilities**

## SANITARY SURVEY FORM FOR ECOSANITATION SYSTEMS CHECK LIST

### DEHYDRATION TOILET –public (11 respondents)

A detailed evaluation of Part A) and B) was not possible, respectively useful.

#### B) SPECIFIC INFORMATION

	<i>yes</i>	<i>no</i>	<i>no answer</i>
1. Is the rain shield present on the vent?	11		
2. Is the vent functional?	4	5	2
3. Is the dehydrating agent present?	6	4	1
4. Is the dehydrating agent used?	6	4	1
5. Are the chamber contents dry (heaped)?	8	2	1
6. Is the system smelling?	5	6	
7. Are there flies/insects?	2	8	1
8. Is the urine diversion system sanitary?	6	4	1
9. Is the system adequately clean?	6	4	1

#### Remarks:

	<i>Number of respondents</i>
no doors/no privacy	1
urine pipe blocked	1
toilet cover broken	1
vent pipe is too short	2
the rain shield is too close to the pipe	3
urinal inside the construction (smell)	1
system too dirty to check the functionality	2
urine diversion (sitter - women): no proper use	1
use like a compost toilet + both chambers at the same time	1
mosque: system does not work properly, because of using water for anal cleansing; no ash added; built a new pit latrine	1

## SANITARY SURVEY FORM FOR ECOSANITATION SYSTEMS CHECK LIST

### DEHYDRATION TOILET –household (11 respondents)

A detailed evaluation of Part A) and B) was not possible, respectively useful.

#### B) SPECIFIC INFORMATION

	<i>yes</i>	<i>no</i>	<i>no answer</i>
1. Is the rain shield present on the vent?	10	1	
2. Is the vent functional?	9	2	
3. Is the dehydrating agent present?	6	5	
4. Is the dehydrating agent used?	8	3	
5. Are the chamber contents dry (heaped)?	9	2	
6. Is the system smelling?	2	9	
7. Are there flies/insects?			11
8. Is the urine diversion system sanitary?	10	1	
9. Is the system adequately clean?	8	3	

#### Remarks:

	<i>Number of respondents</i>
improper function of the rain shield (dump during the rainy season)	1
urine pipe/diversion blocked	1
2 chambers - 1 vent pipe	1
2 chambers - no vent pipe	1
no proper use	1
vent is broken	1
use like a compost toilet + removed the sitter	1

## **ANNEX C: INTERVIEWS**

<b>Mr. Ndimio Deo town clerk of Kisoro</b>	<b>A43</b>
<b>The sanitation officer of the municipality</b>	<b>A44</b>
<b>Mr. Rukundo Edgar Bangar from the agriculture department</b>	<b>A45</b>

## **INTERVIEW – TOWN CLARK**

Kisoro District – Mr. Ndimio Deo (6<sup>th</sup> August 2001)

### **2.1 1. Solid waste**

#### **The current situation in Kisoro Town.**

Two types of waste: about 95% of the produces waste consists of organic waste, the remaining 5% are inorganic material, like plastics (the main part) and a small amount is toxic material, dry cells or aluminium.

#### **Waste collection.**

The community is not involved in waste collection, which is one of the biggest problem within the town. Currently some workers are paid from the Town Council to transfer refuse to the dumping site. They are using wheel barrows from private households for transporting waste from a skip, which is an old tractor bed to the final dumping site – no separation! The collection rate is about 2 tracks per week. Near the market place exists a demonstration site, to show people the separation of organic and inorganic waste. But at the moment there is no use of the collected material afterwards (no recycling/no reuse).

#### **What is being done.**

Sensitisation (promotion) among the population about the importance of separating waste at household level. Mr. Ndimio wants to reduce the costs of transportation of waste. Some people collect organic waste from the market and the dumping site to use the material as manure on their agricultural fields.

#### **Future plans.**

Reuse of collected inorganic waste like polythene bags for seat cushions, mattresses.  
Reuse of organic waste as manure in agriculture due to poor soils. At the moment farmers are not using chemical fertilisers.  
Introduction of communal collection bins, each bin for several households (private or council) as well as constructing an improved concrete base dumping site.  
For further promotion campaigns the priority lies in how to minimise the amount of waste on household level and in awareness building.

### **3.1 2. Generalities**

Currently most of the EcoSan facilities belong to upper and middle class households. Mr. Ndimio wants to support ecological toilets for everybody. One of his targets is to intend decomposition or dehydration toilets by law for every new house.

### **4.1 3. Personal remarks**

Mr. Ndimio seems to be open minded, especially to new innovations and ideas. He is aware of the importance to avoid huge amounts of waste as well as the necessity of recycling waste instead of dumping. In his point of view an involvement and participation of the local population guarantees sustainable future projects.

---

## **INTERVIEW - SANITATION OFFICE**

Kisoro District (10<sup>th</sup> August 2001)

### **1. The common types of excreta disposal in Kisoro Town**

Most of the people are using pit latrines, only some families are using VIPs, flush toilets which are connected to a sewerage or to a private septic tank or EcoSan (dehydration or decomposition) facility.

### **2. Pollution**

By an implementation of ecological facilities pollution of the environment, especially of water, can be reduced. A sustainable protection of water sources has to be the overall goal.

### **3. Reusing of sanitised human faeces**

Currently no concrete plans or ideas exist for households as well as for public toilets. The sanitation officer hopes that KITOWASO knows what to do with and how to handle the sanitised excrements or rather that the users should handle and reuse the products for themselves (reuse as manure on their own fields or selling the products).

### **4. Plans for the future**

Promotion of EcoSan facilities by informing the people about the advantages of the system (like workshops, education, schools).

From time to time people come to the Town Council to ask for ecological toilets. They are asking for free toilets and whether somebody can build a facility for them.

### **5. Plans for solid waste**

A separation in organic and inorganic waste is necessary – organic waste as manure or for selling the material.

Building a system for collecting the waste from individual households to transport the material to a dumping site.

### **6. Personal remarks**

The given information has been miserable as well as timid. The sanitation officer has not been willing to talk with us and gave the impression to be uninformed. Most of the given information are from his working colleague.

## **INTERVIEW - AGRICULTURE DEPARTMENT**

Kisoro District Agriculture Office - Mr. Rukundo Edgar Bangar (16<sup>th</sup> August 2001)

### **1. Crop cultivation in Kisoro District**

About 60 per cent of the cultivated crops are for subsistence (depends on the crop). The main cultivated crops in Kisoro District are Irish potatoes (major), sweet potatoes, beans, maize, vegetables (cabbage, tomatoes, onions, carrots), peas, bananas, wheat, matooke.

Approximately 40 per cent are for commercial like coffee, Irish potatoes, beans, passion fruits, matooke.

Coffee production: Depending on the volcanic soils, coffee plants produce a good quality of coffee. Currently the whole production is for export, an export of the raw, unprocessed coffee beans.

Uganda Coffee Development Program: The Government of Uganda tries to implement an own coffee production in the county. Selected peasants are growing coffee plants for giving the crops to interested farmers for free. In return the government pays for each plant 200 Uganda shilling to the farmer.

Wheat: These plants are mainly cultivated in the mountains and hills to produce local brew or for local bakery.

The families are confronted with several problems like land fragmentation (1-1,5 ha/household) due to land shortage in general, high population as well as inheritance rules which sub-divide family land among all adult sons. A further problem leads to the limited mechanisation and volcanic rocky soils in this region. Small (hilly) plots are cultivated by hand tools.

### **2. Imported food**

Meat: beef is produced local or gets imported from Kabale (big weekly livestock market on Tuesday).

Fruits: pineapples, mangos, melons are from Kabale or Kampala.

Cross-boarder-trade with the Democratic Republic of Congo: main products are matooke, avocados, beans, bananas, Irish potatoes; especially during the dry season, when the yield, the harvest is low.

### **3. Manure/fertiliser**

Most of the farmers in the region use organic fertilisers as peelings, cow dung, sweepings for their fields. Some peasants use for Irish potatoes and coffee commercial fertilisers (pesticides, fungicides).

The Agricultural Department tries to promote the importance of using manure, especially organic fertilisers. Every household produces compost and the farmers must not pay extra money for the material.

An option for later consideration is the use of sanitised EcoSan products as manure.

#### **4. Irrigation**

No irrigation in this region.

#### **5. Harvested food surplus**

The families store harvested food in cribs, granaries or stores. Surpluses are mainly sold on the local market in Kisoro.

Production level is generally decreasing since the last 5 years on the one side due to a general climatic change. The rainy season is changing - it starts when the farmers are not expecting the rain. On the other side pests and diseases are increasing - notably bacterial wilt and blights in Irish potatoes or bean root rot on beans.

#### **6. Settlement effects for agriculture production**

Kisoro Town is a fast growing municipality with a high population density. Many people from the surrounding villages are moving to Kisoro. Limited space for agriculture will become an urgent problem in the following years.

#### **7. Seeds for planting**

Seeds are usually kept from the previous year. Mr. Rukundo sees the reason for transferring plant illnesses from one year to another in the use of harvested seeds for sowing on always the same piece of land. A solution could be a better use of the land or changing the seeds and the production cycle by using the same seeds only for two or three seasons.

#### **8. Remedial measures**

Remedial measurement is a joint research with the National Agriculture Research Organisation (NARO) to create pest resistant seeds or to advise farmers on improved and appropriate farming practises.

#### **9. Using sanitised human faeces**

Currently the possibility for using sanitised human excreta as manure is not an issue. But Mr. Rukundo told that he is open for new ideas and possibilities because the agriculture yield is constantly going down. He sees in the use of EcoSan products an option for the future.



## **10. Plans for the future**

The Government Policy includes points like the transformation from subsistence agriculture to the commercial one. Further an improvement of production methods as well as the use of different varieties of seeds for producing higher yields (e.g. Victoria for Irish) or planting crops which need shorter time to yield (e.g. in Kisoro District Irish potatoes grow twice; in Congo Irish grow three times while sorghum grows only once a year) are an issue. Encouraging to grow marketable crops (e.g. passion fruits, coffee,..) and a better land planing - no mono-cultures – is also mentioned.

## **11. NGOs operating in agriculture in Kisoro District**

- CARE
- AFRICARE
- Africa 2000
- Mugahinga - Bwindi Forest Conservation Trust
- Muhabura Diosece

**ANNEX D: PROTOCOLS of two farmers who are willing to use the toilet products on their fields**

**Mr. David Rwisebura**

**A49**

**Mrs. Regina Sanyu**

**A51**

***MEETING with David Rwisebura***  
(5<sup>th</sup> August 2001)

David Rwisebura  
Kabaya-Gitenderi, Nyarusizy  
PO Box 229  
Kisoro, South Western Uganda

## **1. Personalities**

Educational background: Agriculture College  
Profession: Organic farmer; one of the founders of the „Kisoro Bee Keeping Project“  
Used toilet: Traditional pit latrine

## **2. Agriculture**

The size of the farm comes to 8 ha. The fields are located around and near the house, which is situated a few kilometres out of Kisoro Town, in direction to Mgahinga and Muhabura National Park.

### **Types of crops.**

Eucalyptus trees (about 5 ha), which are mainly for selling as firewood and timber. Additionally for producing eucalyptus honey.

On the remaining 3 ha Mr. Rwisebura cultivates Irish potatoes, sweet potatoes, beans, maize, matooke, sweet bananas as well as avocados and coffee, for both subsistence and commercial.

### **Livestock.**

The farmers livestock consists of one male pig for renting to other farmers. Peasants can bring their female pigs for 10.000 = Ugh Shilling for 3 days. On the other side Mr. Rwisebura produces manure of the pigs dung as fertiliser for his agricultural fields.

Furthermore he owns some hens as well as bees for selling honey to the „Bee Keeping Project“ in Kisoro.

### **Cultivation.**

Mr. Rwisebura is an organic farmer, whereas the majority of peasants in this region are working in this way, but most of them are not aware of it.

He is using a variety of fertilisers, such as NPK manure (50kg/0,5ha/season; costs: 40.000 Ugandan Shilling/50kg), cow dung (a worker collects the material from neighbours for free), pig dung and organic waste. These materials are composted in a pit and afterwards transported in a basket with a bicycle to the fields. Furthermore he is aware of inter-cropping (e.g. bananas and beans; potatoes and maize) and agro-forestry.

## **3. Reuse of the sanitised human excreta**

When the chambers are filled up and the material is sanitised, the users of the ecological toilet should contact KITOWASO or Mr. Rwisebura personally. He empties the chambers and wants to transport the material with a bicycle or by renting a pick up.

Mr. Rwisebura wants to offer this service for free because NPK fertiliser is very expensive and by using sanitised human excreta as fertiliser he can save money. He calculated his capacity for 20 chambers (1000kg/ 0.5ha) and wants to use this manure on every crop. Furthermore he is interested to built an EcoSan facility by using local material, due to the cheapness and permanence of the toilet. He sees only a problem in buying expensive cement.

#### **4. Personal Remarks**

Mr. Rwisebura is very well informed about organic farming such as using fertilisers, increasing the yield with inter-cropping or agro-forestry and about recycling of sanitised human excrements as manure. Furthermore he is open minded for new ideas and changes.

## MEETING WITH REGINA SANYU

(14<sup>th</sup> August 2001)

Regina Sanyu  
PO Box 226  
Kisoro, South Western Uganda  
Tel: 077-685875

### 1. Personalities

Educational background: In 1995 a 8 month training for organic farming in the UK  
In 2001 participant of a workshop in the USA  
Further: different workshops in Uganda

Profession: Organic farmer; she holds workshops for the local farmers (especially for women) in organic farming (both on her own and for an organic farming organisation).

Used toilet: Traditional pit latrine

### 2. Agriculture

The size of Mrs. Sanyus farm comes to 2,5 ha. The farm is situated in a small village near the boarder to the Democratic Republic of Congo, whereas the fields are located around and near the house.

#### Types of crops.

The main part of the cultivated crops are for subsistence, mainly avocados, Irish potatoes, sweet potatoes, beans, maize, matoke, sweet bananas, cassava, vegetables, passion fruits. Mrs. Sanyu is member of the „Uganda Coffee Development Programme“: for every plant which farmers are collecting, she gets 200 Ugandan Shilling from the government.

#### Livestock.

She owns 4 cows and 2 calves which are for milk production (commercial 20l/day and the remaining part is for subsistence). Further she uses cow urine, which is collected in a planted bed for fermentation and after a second treatment for 2 weeks the manure can be used as well as cow dung as manure. The pasture of the cows is rotating from one plot to another. She plants new gardens (like banana) after using as pasture for the animals.

#### Cultivation.

Mrs. Sanyu owns an organic farm. She uses different fertilisers to increase the yield like manure from cow urine, cow dung or organic waste (e.g. for coffee seeds, she mixes the organic fertiliser with soil for growing coffee plants). Another used strategy is inter-cropping such as bananas and beans; potatoes and maize; vanilla under banana trees.

For soil and water conservation she tries to reduce the water speed by cropping elephant grass or trees on the slopes between the different plots for conserving the soil and to keep the nutrients for the seeds. Furthermore she is cultivating plants for medical use, like the leafs from *tiphrosia*, for animal skin diseases or tea leaves and spices.

„Everything has to help each other on the farm“

### **3. Reuse of the sanitised human excreta**

Currently Mrs. Sanyu has no specific concept for reusing sanitised human excreta, because it was the first time somebody asked her if she is interested in this project.

### **4. Personal Remarks**

Mrs Sanyu is convinced of organic farming; she is also convinced that this is the only right way for farming; and it seems that she is satisfied with her work and her life. She wants to share her knowledge with the other farmers in the region and she complained about nothing!!