

van den Berg, Vincent A.C.; Meurs, Henk; Verhoef, Erik T.

Working Paper

Business models for Mobility as an Service

Tinbergen Institute Discussion Paper, No. TI 2022-002/VIII

Provided in Cooperation with:

Tinbergen Institute, Amsterdam and Rotterdam

Suggested Citation: van den Berg, Vincent A.C.; Meurs, Henk; Verhoef, Erik T. (2022) : Business models for Mobility as an Service, Tinbergen Institute Discussion Paper, No. TI 2022-002/VIII, Tinbergen Institute, Amsterdam and Rotterdam

This Version is available at:

<https://hdl.handle.net/10419/263922>

Standard-Nutzungsbedingungen:

Die Dokumente auf EconStor dürfen zu eigenen wissenschaftlichen Zwecken und zum Privatgebrauch gespeichert und kopiert werden.

Sie dürfen die Dokumente nicht für öffentliche oder kommerzielle Zwecke vervielfältigen, öffentlich ausstellen, öffentlich zugänglich machen, vertreiben oder anderweitig nutzen.

Sofern die Verfasser die Dokumente unter Open-Content-Lizenzen (insbesondere CC-Lizenzen) zur Verfügung gestellt haben sollten, gelten abweichend von diesen Nutzungsbedingungen die in der dort genannten Lizenz gewährten Nutzungsrechte.

Terms of use:

Documents in EconStor may be saved and copied for your personal and scholarly purposes.

You are not to copy documents for public or commercial purposes, to exhibit the documents publicly, to make them publicly available on the internet, or to distribute or otherwise use the documents in public.

If the documents have been made available under an Open Content Licence (especially Creative Commons Licences), you may exercise further usage rights as specified in the indicated licence.

TI 2022-002/VIII
Tinbergen Institute Discussion Paper

Business models for Mobility as an Service

Revision: February 2022

Vincent A.C. van den Berg^{1,2}
Henk Meurs³
Erik T. Verhoef^{1,2}

1 Tinbergen Institute

2 Vrije Universiteit Amsterdam

3 Radboud University, MuConsult

Tinbergen Institute is the graduate school and research institute in economics of Erasmus University Rotterdam, the University of Amsterdam and Vrije Universiteit Amsterdam.

Contact: discussionpapers@tinbergen.nl

More TI discussion papers can be downloaded at <https://www.tinbergen.nl>

Tinbergen Institute has two locations:

Tinbergen Institute Amsterdam
Gustav Mahlerplein 117
1082 MS Amsterdam
The Netherlands
Tel.: +31(0)20 598 4580

Tinbergen Institute Rotterdam
Burg. Oudlaan 50
3062 PA Rotterdam
The Netherlands
Tel.: +31(0)10 408 8900

Business models for Mobility as an Service (MaaS)

Vincent A.C. van den Berg, Vrije Universiteit Amsterdam & Tinbergen Institute, v.a.c.vanden.berg@vu.nl *

Henk Meurs, Radboud University & MuConsult, h.meurs@fm.ru.nl

Erik T. Verhoef, Vrije Universiteit Amsterdam & Tinbergen Institute, e.t.verhoef@vu.nl

* Corresponding author. Address: Vrije Universiteit Amsterdam De Boelelaan 1105, 1081 HV Amsterdam

Date: Wednesday, 12 January 2022

Abstract

Travellers often combine transport services from different firms to form trip chains: e.g. first taking a train and then a bus. Integration of different forms of public and private transport into a single service is gaining attention with the concept of Mobility as a Service (MaaS). Usually the attention focuses on such things as ease of use for travellers and shifting demand away from the car. We focus on the effects of MaaS on behaviour and welfare via the market structure of transportation. In particular, we analyse three archetypical ways in which MaaS could be operationalised: Integrator, Platform, and Intermediary.

We find that these models differ strongly in how consumers and firms are affected by the availability of MaaS technologies. The Integrator model seems best for consumers and social welfare. It always leads to lower prices than free competition without MaaS and therefore benefits consumers; transport firm profits can be lower or higher. The Platform model tends to lead to an outcome that is relatively close to free competition without MaaS: prices can be higher or lower, while transport firm profits are lower. Finally, the Intermediary model tends to lead to much higher prices. Regulation of the price that the MaaS firm has to pay may lower prices, but, compared to the Integrator model, the change is often small. So, even without price regulation, MaaS supply can benefit consumers by increasing competition and removing serial marginalisation, even before we consider other benefits of MaaS.

JEL codes: D21, D43, R40

Key words: MaaS, market structure, platform, intermediary, integrator, regulation

1. Introduction

Travellers often combine complementary transport services to form trip chains: e.g. using a taxi as the egress mode after a train trip. Parts of the trip chain are supplied either by individual firms or by vertically integrated firms. Travellers like such combined services as it makes their lives easier. In recent years, integration of various public and private transport services from different firms into a single service has gained increasing attention in the concept of mobility as a service (MaaS). Such integration can now be done in a user-friendly way via an app or website.¹ It is expected that this will bring significant social, economic and environmental benefits, including greater accessibility, enhanced inclusion and less pollution (Jittrapirom et al., 2017). For the users, MaaS offers added value as they can simply use a single service, with a single payment channel, instead of multiple payment operations.²

The introduction of MaaS, often acting as an *intermediary* between the providers of transport services, raises many issues with respect to economic consequences for current transport service providers, as well as for travellers. What are the effects of the introduction of a MaaS service on the demand for transport and on the fares that users pay? What are the effects on pricing and profits of the transport providers? What prices can the MaaS provider charge? Will society be better off with the provision of MaaS integrating independent services, or with a single integrated firm offering all transport, or with independent transport providers without any integration via MaaS? This also relates to the large social concerns on the market power of large Internet and platform firms in general.

Although policymakers, researchers and consultants are spending much effort in addressing these issues, in transport an economic framework for addressing them is lacking. Our aim is to develop such a framework and apply it to the issues mentioned above. We will test how different ways of organising MaaS changes its effects on prices, profits, consumer surplus and welfare. For this purpose, we adopt the approach developed by Economides and Salop (1992) and examine a variety of alternative market structures. This approach has also been applied in analysing public transport networks, airlines, logistics, roads, etc. (e.g. Clark et al., 2014; D'Alfonso et al., 2016; Lin, 2004; Mantin, 2012; Park and Keh, 2003; Silva and Verhoef, 2013; van den Berg, 2013; Verhoef, 2008; Zhang et al., 2012). A related literature focusses on the integration of transport services within a single firm or by alliances of firms (Brueckner, 2001; Meurs et al., 2020; Van de Velde et al., 2005; Verhoef, 2008; Vij et al., 2020). To the best of our knowledge, application of this framework for MaaS is new.³

¹ MaaS is defined as a user-centric mobility distribution model in which all mobility services are aggregated by an operator and supplied to users through a single digital platform (Jittrapirom et al., 2017; Kamargianni et al., 2016; Pantelidis et al., 2020; Polydoropoulou et al., 2020). The platform can be realised by public or private agencies. In some cases, the platform is owned by a major transport firm: for instance, Transdev and Toyota, who have shares in the Finnish MaaS provider MaaS Global (Pöllänen, 2020).

² MaaS also brings many other benefits for users such as services for planning of trips.

³ Pandey et al. (2019) look at cooperation and competition between MaaS/ridesharing operators but in terms of supplying rides without considering pricing. Related papers looking at pricing of innovative transport technologies include Kaspi et al. (2014), Ke et al. (2020) and Ma and Zhang (2017) on ride sharing, Tan et al. (2019) on parking space sharing, Simoni et al. (2019) and Van den Berg and Verhoef (2016) on autonomous vehicles, and Verhoef et al. (1996) on information provision. Di and Ban (2020) look at MaaS and congestion in

Our main methodological contribution is the development of a consistent economic framework to study how different ways of organising MaaS determines its effects on prices, profits, consumer surplus and welfare. Compared to earlier studies that look at complementary and competitive services, and possible integration of services, our paper adds the vertical dimension where the new entrant—the MaaS operator—markets and combines complementary products supplied by transport operators who remain in operation as marketeers of their own products. This also makes the market structure fundamentally different from models that study code sharing or alliance formation in aviation markets (e.g. Brueckner, 2001). Our main policy / societal implication is, as mentioned, to test the effects of different forms of organising MaaS on prices, consumers, profits and welfare. We also check if regulation can be expected to further improve things.

We consider a stylised setting with a four-link network, two competing transport providers, one MaaS service provider and assuming away any other effects of MaaS other than via the resulting market structure. The MaaS provider sells multimodal services from each of the two transport providers. We formulate a number of non-cooperative games with different pricing strategies by the players, as well as different power structures. Many papers have looked at how MaaS could be organised or modelled in more complicated and more detailed settings than our stylised setting, but in such settings it is impossible to gain insight on how the way MaaS is organised affects the market outcome, and attaining such an understanding is our goal. Similarly, adding other effects of MaaS would make the model more realistic but would muddle the effects of the market structure, making it difficult to attain insight. Finally, in our sensitivity tests, we will also check what the effects are of extensions that make the model more realistic, such as: extra demand due to the convenience of MaaS, transfer cost when using multiple firms, (dis)economics of scale, and heterogeneous firms.

The paper is structured as follows. The next section reviews the literature on the different forms of MaaS that currently exist, and that have helped inspire our three market structures. Section 3 will explain how we set-up our MaaS market structures and compare them to real world cases of MaaS. This section also discusses the set-up the model. Section 4 will analytically scrutinize our setting, while Section 5 will look at a numerical version of our model. This Section 5 will also present many sensitivity analyses, and extensions of our model. This will help show the robustness of our results. Section 6 reflects on the possibility of price regulation. Finally, Section 7 concludes and discusses possible future work.

more extensive networks than ours but do not look at pricing. Polydoropoulou et al. (2020) explore prototype business models for MaaS and how different actors may interact.

Recent papers have looked at pricing of MaaS in less stylised settings than ours but did not consider how different ways of organising the MaaS can alter the outcome. For instance, Djavadian and Chow (2017) used agent-based modelling while considering both the behaviour of consumers, transport firms and the MaaS supplier. Expanding on Rasulkhani and Chow (2019), Pantelidis, et al. (2020) analysed MaaS traffic assignment in a large-scale network using a stable matching model.

2. Review of business structures for MaaS

Now, we will briefly discuss the various forms of MaaS as found in the literature. This will help us determine what the possible business structures of MaaS we will look at.

Polydoropoulo et al. (2020) state that the development of prototype business models for MaaS is an under-researched area, as existing literature is mainly limited to: (i) contributions aiming to define the MaaS ecosystem and specify the actors involved and their roles (e.g. Kamargianni and Matyas, 2017) and (ii) contributions which analyse existing schemes and categorize them in different types of MaaS models (e.g. König et al., 2016; Ebrahimigharehbagh et al., 2018).

König et al. (2016) described a number of different types of business models for MaaS. They base their analysis on various schemes and pilots (including Tuup, Whim, Ylläs Around, Kutsuplus, and UbiGo). Four different models of MaaS are presented: reseller, integrator, public transport operator and public private partnership (PPP). These settings are based on who holds control over the integration of mobility services. König et al. (2016) argue that different models are appropriate for different geographical levels of mobility services such as urban, suburban areas, national, international levels. For instance, the reseller (or Intermediary in our terminology) model might be best for national and international travelling. The Integrator is suitable for multiple levels including urban, suburban areas and international.

Ebrahimigharehbagh et al. (2018) investigate potential business architectures for MaaS and define crucial dimensions that motivate the choice among those architectures. Based on their analysis, typologies of business architectures for MaaS are established identifying their corresponding strengths and weaknesses. They distinguish integration versus separation of different components in the supply chain for transport services and as well as of the marketing and communication.

So there are different ways how MaaS may be organized and, most importantly for our paper, there are differences in who sets which prices. The MaaS could set all prices for the transport services it offers, so akin to our *Integrator*. Transport firms could sell trips to the MaaS company, who then combines these into complete trip tickets and sells them to the customers. This is the reseller in König et al. (2016) or our *Intermediary* setting, and it is how the company Whim operates. Finally, transport firms may keep all pricing control, and the MaaS only offers a *Platform* on which trips using multiple firms can be more easily bought.⁴ This describes our three set-ups of MaaS—Integrator, Platform, and Intermediary—and we will see that each leads to very different outcomes in terms of pricing, profits and societal welfare. Other possible settings—such as an PPP offering the MaaS—and their effects via the resulting market structure seem interesting topics for follow on research,

⁴ For example, the Belgian public transport operator De Lijn launched mobile ticketing for third party resellers in 2016 through open access agreements (UITP, 2019).

3. Modelling supply chain structures for mobility services

3.1 The supply chain structures

The setting for our analysis is illustrated in Fig. 1. Let there be two types of transport services, Mode 1 and 2, such as public transport and bike-sharing services. Each service supports two links (components) required to travel from the origin to the destination. A denotes the upstream segment, and B the downstream segment. Travellers can use four combinations A_i and B_j ($i, j=1, 2$). Hence, the service components A_1 versus A_2 and B_1 versus B_2 are substitutes; conversely, A_1 and B_2 are complements and A_2 and B_1 are complements as well. We assume that all travellers are making trips from the single origin to the single destination and have to use a complete bundle using one segment A and one segment B , so no individual segments are made (no partial trips). We consider two cases presented in Fig. 1: one with and one without a platform provider. The left panel represents the case of two independent firms that compete for individual trips. In the right-hand panel a MaaS-provider is added, which provides the two multimodal services shown as diagonals in the diagram. Hence, we focus on the stylised, symmetric case where each trip has two segments and each segment can be travelled via one of two modes.⁵ So the MaaS provider saves people the hassle of buying two segments and instead they can buy one full trip from the MaaS provider. Naturally, when staying within a mode and company—i.e. using A_1 and B_1 or A_2 and B_2 —one also needs to buy only the combined trip. We assume that the key proposition of MaaS is to sell multimodal trips. The situation with the two independent firms without MaaS will serve as a reference situation for the analysis. Table 1 summarises the used notation.

Fig. 1: Combining mobility services (with and without MaaS) with two transport providers
 (a) Independent vertically integrated firms (b) MaaS with independent vertically integrated firms

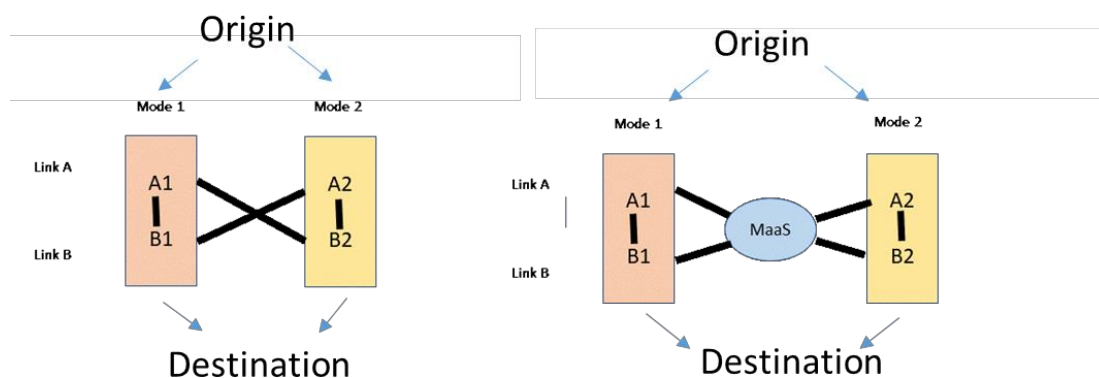

⁵ In reality, some trips may have only one mode, but then MaaS is not that relevant. There may also be many more possible modes and segments, and then our setting may be seen as a stylised representation.

Table 1: Notation used

<i>Functions and welfare (components)</i>	
D_{21}	Inverse demand for cross-network trips first using Firm 1 and then Firm 2. Similarly $_{11}$ indicates only using Firm 1, and $_{21}$ means first Firm 2 and then 1.
Q_{11}	Quantity transported by cross-network trips first using firm 1 and then 2. Similarly, $_{11}$ indicates only using firm 1, and $_{21}$ means first firm 2 and then 1.
PR_i	Profit for transport firm i
PR_m	Profit for the MaaS company
U	Utility of the trip for the representative consumer
CS	Consumer surplus
$W=CS+PR_1+PR_2 +PR_m$	Welfare / social surplus from the transport market
ϕ	Share of revenue going to the MaaS company
<i>Demand parameters</i>	
α	Intercept of the demand function
β	Slope of the demand function to the price of the good (i.e. the own-price sensitivity)
γ	Slope of the demand function to the price of the other goods (i.e. the cross-price sensitivity)
$\delta = (\beta-\gamma)(\beta+3\gamma)$	<i>Compound demand parameter used for short-hand</i>
$a=(\alpha\cdot(\beta-\gamma))/\delta$	Intercept of the inverse demand function
$b=((2\gamma+\beta))/\delta$	Slope of the inverse demand towards the price of a good
$c=\gamma/\delta$	Slope of the inverse demand to the prices of the other goods ($c < 3 b$ must hold for a working demand system)
$r=b/c$	Relative slope to the own-price vs cross-prices. It is used to simplify expressions and helps with interpretation.
<i>Prices</i>	
P_{11}	Full price of a cross-network trip first using Firm 1 and then 2. Similarly, $_{11}$ indicates only using Firm 1, and $_{21}$ means first Firm 2 and then 1.
p_1	Price of using Firm 1 for the first part of the trip (and p_2 is this price when using Firm 2)
q_1	Price of using Firm 1 for the first part of the trip (and q_2 is this price when using Firm 2)
s_{11}	(Possible) bundle price when using Firm 1 for both parts of the links. Similarly, $_{22}$ indicates only using Firm 1, and $_{21}$ means first Firm 2 and then 1 (only a MaaS could by assumption offer a cross -network bundle).

The price of using firm i for the first link A is p_i , and for using i for the second link B it is q_i . When solely using one firm for the complete trip, the firm may sell the combined trip at a different bundle price s_{ii} . Further, the MaaS supplier may sell a complete cross-network trip at price s_{ij} .⁶ The combined price, P_{ii} , for using only firm one is thus p_i+q_i or s_{ii} if the transport firm offers bundling; a cross-network trip has a combined price P_{ij} of p_i+q_i or s_{ij} if there is a MaaS supplier that offers bundling.

We have two reference cases without a MaaS company:

- **Free competition** in which within- and cross-firm services can be used by the traveller. Each firm can set up to three prices: the prices of the service on both links, p_i and q_i , and a complete trip price with “door-to-door services” (assuming no access before A, or regress after B) from a specific firm with a possible discount $s_{ii} \leq p_i+q_i$.
- **Independent services** when there is no cross-firm travel. This latter case gives the minimum profit that firms must make for them to be willing to be part of a platform, as a single firm can

⁶ Non-arbitrage conditions hold: i) the price of the bundle cannot be larger than the price of the individual components ($s_{ii} \geq p_i$; $s_{ii} \geq q_i$; $s_{ij} \geq p_i$; $s_{ij} \geq q_j$), and ii) the price of the bundle cannot be smaller than the sum of prices of individual components ($s_{ii} \leq p_i+q_i$; $s_{ij} \leq p_i+q_j$).

always choose not to allow cross-travel by not stopping at the point of intersection between A and B where the alternative mode stops.

With a MaaS platform, we consider three different cases (for simplicity, in all three cases we assume that cross-network trips are impossible without using the MaaS platform):

- **Integrator model.** The firms set their own price (s_{ii}) and the platform sets the cross-travel prices s_{ij} ; the platform keeps an exogenously fixed share ϕ of the revenue it generates. This model could apply to services provided by multimodal transport firms such as Transdev, Arriva, Keolis and Veolia in Europe, but expanding to other continents.
- **Platform model.** In this model, the transport firms set all prices, and the platform keeps share ϕ of the revenues it generates. The price for an on-network trip of firm i is $P_{ii}=s_{ii}$, and a cross-network trip first using firm i and then firm j has a price of p_i+q_j . This set-up reflects the business models of platform firms such as Airbnb, Booking, eBay, Amazon or AliExpress.⁷ In transport, the Belgian public transport operator De Lijn launched mobile ticketing for third party resellers in 2016 through an open access agreements. This has contributed to a vibrant MaaS ecosystem in Flanders with 7 third party resellers, most of them MaaS operators (UITP, 2019).
- **Intermediary model, transport firms as the leader.** Transport firm i sells the segments of the cross-trips to the MaaS supplier at wholesale prices p_i and q_i , and the MaaS supplier sets cross-trips at retail price s_{ij} to the travellers. The difference is that now there are two layers of price setting—wholesale and final cross-network prices—and thus extra serial marginalisation; conversely, with the Integrator model, the integrator is the only one that affects cross-network prices. This model reflects the retail market where intermediaries sell products and services that are bought from manufacturers or wholesalers. A transport example is Whim, that buys tickets from the transport providers and sells them in bundles to customers adding value such as booking, planning and reservation services.

3.2 *The model*

To model the demand we consider a representative traveller who derives utility from making trips, allowing for imperfect substitutability between the four travel options available in our network, and allowing for overall price sensitivity of transport demand. The simplest demand structure that captures all this are linear inverse demand functions. For the demand system to be invertible and thus solvable, the cross sensitivity between modes—i.e. the sensitivity of the quantity demanded for mode i to a change in the price of mode j —must be smaller than or equal to the direct effect resulting from a change in the own price of mode i . To further simplify things and allow for some analytical insight, we

⁷ Most of these platforms also offer information and payment services. We will omit these extra services and leave it for future work.

assume that the demand intercepts, own-price slopes and cross-price slopes are the same for all. In our sensitivity analyses we will relax these assumptions.

Such a demand structure is implied by a quadratic and strictly concave utility function (Singh and Vives, 1984) of the following form:

$$U[Q_{11}, Q_{12}, Q_{21}, Q_{22}] = \alpha \cdot (Q_{11} + Q_{12} + Q_{21} + Q_{22}) - \frac{\beta \cdot (Q_{11}^2 + Q_{12}^2 + Q_{21}^2 + Q_{22}^2)}{2} - \gamma \cdot (Q_{11} Q_{12} + Q_{11} Q_{21} + Q_{11} Q_{22} + Q_{12} Q_{21} + Q_{12} Q_{22} + Q_{21} Q_{22}). \quad (1)$$

Q_{1l} is the number of trips using mode or Firm 1 for both legs of the trip, Q_{2l} is the number of trips using first Firm 2 and then Firm 1, and so on. The $\alpha > 0$, $\beta > 0$ and $\gamma > 0$ are preference parameters. Goods are imperfect substitutes when $\beta > \gamma$.

Assuming a constant marginal utility of money, normalised to 1, U also represents Marshallian benefits from transport, and consumer surplus can therefore be written as:

$$CS = U[Q_{11}, Q_{12}, Q_{21}, Q_{22}] - (P_{11} Q_{11} + P_{12} Q_{12} + P_{21} Q_{21} + P_{22} Q_{22}), \quad (2)$$

with P_{1l} being the total price of using Firm 1 for both legs of the trip, P_{12} of using first Firm 1 and then 2, and so on. By having a representative consumer maximise this consumer surplus in (2) by choosing the different quantities, we indeed get linear inverse demand (or marginal willingness-to-pay) functions for all trip types; that for example reads for P_{11} :⁸

$$P_{11} = \alpha - \beta Q_{11} + \gamma \cdot (Q_{12} + Q_{21} + Q_{22}). \quad (3)$$

Inverting this system yields the direct demand functions, with D denoting quantity demanded; e.g. for D_{11} :⁹

$$D_{11} = a - b P_{11} + c \cdot (P_{12} + P_{21} + P_{22}) \quad (4)$$

$$\text{with } a = \frac{\alpha \cdot (\beta - \gamma)}{\delta}, b = \frac{(2\gamma + \beta)}{\delta}, c = \frac{\gamma}{\delta}, \text{ and } \delta = (\beta - \gamma)(\beta + 3\gamma) \quad (5)$$

The newly introduced composite parameters can be interpreted as follows: a is the amount of consumption when all prices are zero, and is the same for all product types because of the assumed symmetry; b is the own-price sensitivity; and c the cross-price sensitivity. Finally, $\beta > \gamma$ must hold for the demand system to be consistent, which implies $b > 3c$.¹⁰ The condition indicates that, with imperfect substitutes, the sensitivity to all other prices needs to be smaller than that to the own price. As can be

⁸ Here, α is the intercept of the inverse demand function and thus the maximum willingness-to-pay. The β gives how much the willingness-to-pay changes with the own quantity and the γ how much it changes with the quantity of a competing travel option.

⁹ We leave it implicit what will be done by people who use none of the four options. They could stay at home, go to a different destination or use some other way to travel. As long as all outside travel options are priced at their constant marginal cost, we expect that that our model and results would remain unchanged. Otherwise, the analysis would be more complex, but results on the effects within the market currently modelled would probably remain similar.

¹⁰ Since $b = \frac{2\gamma + \beta}{\delta} > \frac{2\gamma + \gamma}{\delta} = 3c$.

seen in Table D.1 in Appendix D, this simple set-up already gives complicated equilibrium demand and profit functions. Indeed, we use simple linear functions as these allow for clear analytical results. We do not expect the functional form of the demands to affect our qualitative results; but, as for instance Choi (1991) finds, this choice of linear demand will have an impact on numerical results. Appendix E tests this for our numerical model. It turns out that, for this check at least, our main results are robust to the choice of functional form.

For conceptual transparency, we ignore possible economies of scale, fixed costs, and congestion effects. All these would mean that changes in market structure would also alter cost, while we want to focus on the isolated impacts via changes in competitive conditions. For further notational ease, we may then next normalise the marginal cost to zero for all links. So, in the social optimum, prices would equal the marginal cost of zero. Yet adding positive constant marginal costs would not change results: the price equations we give would then represent the markups asked above the marginal costs. Consideration of mode-specific economies of scale and scope, or reversely congestion effects, would naturally affect the effects of different scenarios. Still, our qualitative comparative results on strategic interactions in different market structures are likely to remain robust.¹¹ Appendix F also concludes this for our numerical model by making the average costs linear in the quantities served by a firm and varying the degrees of (dis)economies of scale. Clearly, scale or congestion effects would affect profitability and pricing behaviour of transport suppliers, but the strategic interactions between them—the key topic that we wish to explore—one would expect not to be fundamentally overturned. The extent to which results will change in a quantitative sense is an issue we believe deserves more attention in follow-up work.

As costs are zero by assumption, social surplus equals consumer surplus plus the profits of the transport firms (denoted PR_1 and PR_2), plus any profit of the MaaS company (PR_m):

$$W = CS + PR_1 + PR_2 + PR_m$$

From these functions, we derive the equilibria for prices and profits for the different settings. So each transport firm and MaaS operator chooses a price that maximises its own profits while taking the prices of the other firms as a given.¹² The resulting profits are given in Table D.1 in Appendix D for reference.

For the Intermediary model, we only consider a Stackelberg price game instead of the Bertrand–Nash formulation used for the other settings. The transport firms are the leaders, and in setting wholesale prices for cross-trips to the platform, they take into account how the platform will react to changes in wholesale price. Such Stackelberg behaviour may seem more natural in this case than Nash

¹¹ In our formulation, the operators face a marginal willingness to pay function that is given by the difference between marginal benefits and a constant zero marginal user cost. When frequency benefits or congestion would affect the users' well-being, the resulting marginal willingness to pay would still be downward sloping, leaving the essence of intermodal competition unaltered.

¹² The profit maximization of each firm is characterised by the first-order conditions by differentiating the profit functions with respect to the price variables. From these we can then solve for the equilibrium prices, and thus demands and profits.

behaviour, where the wholesalers would take the prices to consumers as a given. But more importantly, under the Nash assumption, the Intermediary model would always lead to zero cross-trips and in effect no MaaS, which defeats the purpose of analysing the Intermediary model. Under Nash behaviour, a transport firm would take the final price of the MaaS as a given, and thus the cross-network quantities are seen as fixed. Consequently, the firm would believe that raising the wholesale price always increases its profit. Accordingly, we would always end up with very high wholesale prices, and the intermediary being unwilling to sell any cross-trips.

Concluding the model set-up, we will consider three MaaS market structures that differ in how the MaaS operator: Integrator, Platform and Intermediary. For comparison, we will also look at Free competition without any MaaS, the social optimum of marginal cost pricing, and a setting with no cross-network travel—which gives constraint on how low transport firms’ profits can be as they can always stop offering the services that the MaaS sells. For ease of exposition and for allowing clear analytical results, we assume Nash behaviour where all firms take the prices of the others as given, except with the Intermediary as there the Nash assumption would lead to no cross-network trips and thus no MaaS. In a sensitivity check, we will add Stackelberg behaviour to the Integrator setting to test the effects of the Nash assumption.

4. Analytical analysis

4.1 *The effects of providing cross-network transport options*

We consider two cases without MaaS as references: a situation with and one without cross-network services. In both cases, providers maximise their profit and take the prices of the other firm as a given. The resulting Bertrand–Nash equilibrium profits and prices are given in Table 2; Table D.1 in Appendix D gives the profit objectives that the operators maximise. This analysis serves two purposes: (a) we examine the effects of cross-supply on prices and profits and (b) it provides benchmarks for the business structures with the MaaS provider.

Firm 1 asks a price p_1 for only using its first link, and a price q_1 for only using its second link. It offers a bundle price $s_{11} < p_1 + q_1$ if you use it for both legs of the trip. Firm 2 similarly has prices p_2 , q_2 and s_{22} . The full prices for an entire trip are $P_{11} = s_{11}$, $P_{12} = p_1 + q_2$, $P_{21} = p_2 + q_1$ and $P_{22} = s_{22}$.

Comparing the equilibrium prices for the two bundles s_{ii}^* (asterisks represent equilibrium outcomes) in Table 2, we find that the prices for the cases with cross-network supply are lower than without cross-network supply, except for the obvious case when the cross-price sensitivity c is 0 (remember that $b > 3c$.) Hence, the introduction of cross-network competition lowers the prices, from which travellers benefit. The price of the within-network bundle, s_{ii} , is lower than the price of the cross-network bundle $p_i + q_j$. Finally, profits of the firm providing both services are higher than firms that only provide the direct services. Thus, there is also an incentive for firms to provide cross-network services.

For simplicity we assume that the operator has zero costs; if it had positive costs then our price equations would be the markups on top of the marginal cost (which is assumed to be zero).

In this setting we see “serial marginalisation” as in Economides and Salop (1992), and the full price $P_{12}=P_{12}$ for a cross-network trip is higher than for an in-network trip. Each firm independently maximises profits and ignores the externality that raising the price on the one link (p or q) lowers the profit of the other firm by depressing demand. So, given s_{11} and s_{22} , these prices p_1, p_2, q_1 and q_2 are higher than what a monopolist would ask, and lowering them would raise both aggregate profits and consumer surplus. But of course such collusive behaviour is not possible in a Nash setting. We will see later that a MaaS supplier may remove such serial marginalisation, and this may then benefit consumers and firms. However, it may also add an extra layer of serial marginalisation, which would work the other way. The ultimate outcome depends on which of the three MaaS models will prevail.

Table 2: Price, profit and demand equilibria for the supply chain structures “free competition” and the “independent services” structure

	<i>Free Competition</i>	<i>Independent Services (without cross-network trips)</i>
Prices	$s_{ii}^* = \frac{a}{2b-5c}$	$s_{ii}^* = \frac{a(b+c)}{2b^2 - 3bc - 3c^2}$
	$p_i^* = q_i^* = \frac{2a}{6b - 15c}$	
Profits	$PR_i^* = \frac{a^2(17b - 32c)}{36b^2 - 180bc + 225c^2}$	$PR_i^* = \frac{a^2(b^3 + 2b^2c + bc^2)}{4b^4 - 12b^3 - 3b^2c^2 + 18bc^3 + 9c^4}$

4.2 Integrator model of MaaS

Now we turn to the first form of MaaS supply. The transport firms set the own price (s_{ii}), and the platform sets the cross-travel prices s_{12} and s_{21} ; the platform keeps a share ϕ of revenue. Each operator and the integrator set their prices to maximise their own profits (see Table D.1), and each competes in a Bertrand fashion by taking the prices of the others as given. Table 3 gives the resulting Bertrand–Nash equilibrium profits and prices. The Integrator setting leads to two changes to the market structure.

- i) While free competition without MaaS has “serial-marginalisation” externalities in the prices of cross-network services, the integrator internalises these and thus removes the serial marginalisation. This lowers cross-network prices, and this in turn leads to lower in-network prices by increasing competition.
- ii) There are now in effect three transport suppliers: Firm 1, Firm 2 and the MaaS operator. This intensifies competition and lowers prices.

Both these effects benefit consumers by lowering prices. The removal of serial marginalisation raises transport-firm profits, while the extra competitor lowers their profits. Table 3 presents the results.¹³

¹³ For all MaaS cases we assume away the option of cross-network trips that do not use the MaaS supplier, and this market seems an interesting option for further research.

Table 3: Price, profit and demand for the Integrator model of the supply chain structure

	<i>Nash equilibria for the Integrator model</i>
Prices	$s_{11}^* = s_{22}^* = \frac{2ab - (\varphi - 1)ac}{4b^2 - 6bc + (2\varphi - 4)c^2}$ $s_{12}^* = s_{21}^* = \frac{2ab + ac}{4b^2 - 6bc + (2\varphi - 4)c^2}$
Transport firm profit	$PR_i = - \frac{(\varphi^2 - 3\varphi + 2)a^2c^3 + ((\varphi^2 - 7\varphi + 6)a^2bc^2 + (4\varphi - 8)a^2b^3}{(4\varphi^2 - 16\varphi + 16)c^4 + (48 - 24\varphi)bc^3 + (16\varphi + 4)b^2c^2 - 48b^3c + 16b^4}$
Profit MaaS	$PR_p^* = - \frac{\varphi^2a^2c^3 + 3\varphi a^2bc^2 - 4\varphi a^2b^3}{(2\varphi^2 - 8\varphi + 8)c^4 + (24 - 12\varphi)bc^3 + (8\varphi + 2)b^2c^2 - 24b^3c + 8b^4}$

Proposition 1: *The Integrator setting lowers all prices compared with the free-competition case, and thus raises demands, consumer surplus and social surplus (as prices get closer to the marginal costs of zero). The price decreases are larger when demand is less sensitive to the own price (i.e. smaller b), more sensitive to the price of the other travel options (i.e. larger c), and when the integrator keeps a larger share, ϕ , of revenue.*

Proposition 2: *Transport firm profits can be lower or higher with the Integrator model than with free competition: the integrator removes the serial marginalisation that hurts profit, but effectively acts as a third supplier, and this raises competition. Transport firms' profits with the Integrator model are larger than with free competition when the revenue share for the platform is not too large and the travel options are not too strong a substitute; the parameter conditions are:*

- $\phi < \frac{1}{2c^2 \cdot (18b^2 - 81bc + 97c^2)} (-72b^4 + 396b^3c - 658b^2c^2 + 213bc^3 + 163c^4 + 3(2b - 5c)\sqrt{144b^6 - 864b^5c + 1784b^4c^2 - 1200b^3c^3 - 423b^2c^4 + 658bc^5 + 225c^6})$
- $c < \frac{2}{(9 + \sqrt{19})} b$

Proofs for Propositions 1–2 can be found in Appendix A.

The price decreases can be rather large. If the travel options would be perfect substitutes and thus $b=3c$, the price decrease would be 50–62.5% for in-network trips, and 62.5–67.2% for cross-firm trips, where the exact percentages depend on the share ϕ the integrator gets of revenue. Hence, in this setting, MaaS supply has the advantage of lowering prices. If demand would be perfectly elastic with respect to the own price ($b=\infty$), all prices are always zero, and, so in this extremum, the price decreases from the intermediary reach zero. When $c=0$, the demands would be independent of the prices of the other options, and hence the price of in-network trips that only use a single firm is unaffected by the presence of the platform. Under $c=0$, the cross-trip prices would be 25% lower with the Integrator model than under free competition, as the integrator still removes serial marginalisation.

Transport firm profits are larger with the Integrator model than with the no-cross-network trips of the independent services unless demand is really insensitive to the own price (i.e. low b) and/or really sensitive to other prices (i.e. high c). So typically, firms will not have an incentive to stop supplying cross-network trips, but this may be a problem in some parameter ranges.

We can conclude that this subsection showed that MaaS with an integrator setting the cross-network prices leads to lower prices than under free competition. Travellers benefit, and demand for transport services will increase. The profits of transport providers may rise or fall depending on the parameters. Naturally, besides these pricing benefits, in reality we would also get benefits from the ease of use of MaaS and information provision, which would raise the demand for multimodal transport. But even with these extra benefits, the effects of the market structure should be pronounced.

4.3 Analysis of the Platform model

This section discusses the Platform model, in which the transport firms set the prices for the direct services s_i and for their parts of the cross-network services p_i and q_i . The MaaS operator only offers a platform on which the cross-network services are sold, and unlike with the Integrator model there is no bundling of cross-network trips. The price for a cross-network trip is the sum of prices charged by the operators for using their links, while a fraction ϕ of the revenues remains with the MaaS operator. Just like before, the operator maximises its own profits and competes in a Bertrand fashion.

The Nash equilibria are presented in Appendix B in Table B.1, as they are messier than the previous ones. Here, we will review the results. The prices of the direct services of the platform model are lower than with free competition, and so demand is higher. For cross-network services we see that prices are higher for the platform model compared to the reference model.

Proposition 3: *The Platform model of the MaaS supplier leads to higher prices than the Integrator model, and thus it leads to lower consumer and social surpluses. Compared with the free-competition case, the Platform model leads to lower prices for in-network trips but higher prices for cross-network trips, and thus consumer surplus and welfare can be higher or lower.*

Proposition 4: *The platform setting always leads to lower profits for the transport firms than under the free-competition setting. Compared to the Integrator model setting, the Platform model can lead to higher or lower transport firm profits depending on the revenue share for the MaaS supplier and the ratio of demand sensitivities, b/c . Fig. 2 illustrates these parameter ranges.*

Proofs for Propositions 3–4 can be found in Appendix B.

Fig. 2. *The platform gives higher profits in the grey parameter region and the intermediary in the white region.*

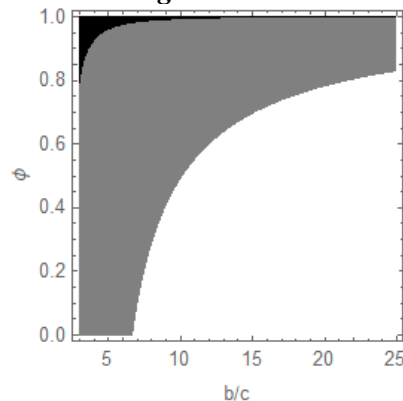

Note: In the black region, there is a corner solution with no supply of MaaS trips with a Platform

To conclude, the Platform model—with transport providers setting all prices and no bundling—yields lower equilibrium prices for the direct services and higher cross-network prices, promoting usage of direct services. The effects of the introduction of a platform on the transport firm profits are negative compared to the free-competition setting, and the effects on demand are positive. On the whole, this model of MaaS seems an attractive one, but less so than the Integrator setting. So the used market structure for MaaS can have important effects on the outcomes of the transport market.

4.4 *Analysis of the Intermediary model*

Now consider the Intermediary model, in which transport firms set the prices for the direct services and the wholesale prices for services provided by the platform. The platform sets the prices for the travellers using cross-network services. For this model we adopt a Stackelberg game. First, the transport providers set their prices for the direct services and the wholesale cross-network prices. Thereafter, the intermediary sets the cross-network prices as seen by the customers. The two transport providers compete Bertrand–Nash amongst themselves, but each is a leader towards the intermediary, setting wholesale prices while taking into account how the platform will respond to their wholesale price. Based upon this, we derive the profits and demands. The detailed results are presented in Appendix C in Table C.1. Here, we will overview the more important results.

Comparing this supply chain structure with the reference model of free competition, we find that the prices resulting from this intermediary model are higher than the prices of the reference model. With increasing price sensitivity (higher b), this difference decreases.

Proposition 5: *The Intermediary model leads to higher prices than the Integrator model, and even than the free-competition setting.*¹⁴

Proposition 6: *The Intermediary model can lead to higher or lower transport-firm profits than the Integrator model and free-competition settings depending on the ratio of demand sensitivities b/c and ϕ .*¹⁵

Proofs for Propositions 5–6 can be found in Appendix C.

It can be concluded that the model in which the platform acts as an intermediary is not very attractive for travellers because of the high prices. An important mechanism behind this result is the combination of Stackelberg behaviour of the service operators in combination with extra double marginalisation that is introduced,¹⁶ with both the transport operators and the MaaS operator trying to skim off the same consumer surplus. Still, this setting is also not particularly attractive for the transport

¹⁴ Note again that for simplicity we assume that the operator has zero costs; if it were to have positive costs then our price equations would be the markups on top of the marginal cost (which is assumed as zero).

¹⁵ The ϕ only affects the profits with the Integrator model and is irrelevant for the Intermediary model and under free competition.

¹⁶ Although, as argued in Section 2, full Nash–Bertrand would be even worse than our Stackelberg setting, as it would always lead to cross-network trip prices that are so high that there are no cross-trips. As then there basically would be no MaaS, we focus on the Stackelberg setting instead, which as argued also seems a more logical way to compete in this setting.

firms, since profits can be higher or lower than in the other settings, and it seems likely that the profits will be similar in all cases.

4.5 Concluding the analytical model

This section analytically studied three versions of how MaaS can be introduced. We found that the resulting market structure can have large effects on the outcome of the transport market. The Intermediary version clearly leads to the worse outcome, which is troubling as it is the version of MaaS that most often comes up in informal discussions with practitioners and government agencies. The Platform lead to a similar outcome as no MaaS—assuming away all other effect from MaaS as we do—so this seems a good option, The Integrator leads to lower prices compared to the setting without MaaS by removing the serial marginalisation from multiple transport firms serially setting prices, while profits can be higher or lower.

5. Numerical analysis

In this section, we compare the outcomes of the different business models using a numerical example. The analytics showed that some MaaS structures have better or worse effects for consumers or transport firms, and that for others it depends on the parameters. But how large are the effects on prices, profits and consumer surplus? How strongly do results depend on parameters? For this we need a numerical model. We will start with our base case numerical model, and thereafter we will look at sensitivity analyses where we change some of the more important parameters.

5.1 Base case numerical example

Let us consider a market with at maximum 100 000 trips for each of the four services when all fees are zero, hence $a=100\ 000$. We assume an own-price elasticity of -0.4 for the transport services in the free-competition case. This results in $b=20\ 000$ and $c=4\ 000$. Assume that the share of revenue for the platform (when relevant) is $\phi=0.02$. Informal statements by people involved in the negotiations reveal such shares have been discussed. This share appears in the discussions between transport operators and MaaS service providers,¹⁷ although ride-sourcing services such as Uber require a much larger share (up to 35%). Based on these assumptions, we can compare equilibrium prices and profits for each of the business models. The results are presented in Table 4. The sensitivity analysis will focus on the effects of changing b , c and ϕ .

Table 4 shows a number of results:

- The prices with free competition are higher than the prices with independent services, and so are the profits of the transport firms. In absence of costs to make services of different firms

¹⁷ Transport providers in Belgium offer third parties selling their mobile tickets fixed fee of 6 eurocents per ticket or about 2% of the ticket price.

compatible for travellers, firms have an interest in supplying cross-network services, and to charge higher prices for this. This result matches insights from the literature on standardisation.

- For the Integrator model, prices are lower than in the free-competition case, as the Integrator platform basically is a third competitor and removes serial marginalisation. Total profits are slightly lower, but firms would not choose to stop supplying to the platform.
- For the Platform case, profits for the firms are higher than for the Integrator case, and the profit for the platform is lower. Consumers face higher prices but are better off than in the free-competition case. Hence, under the base parameters, this seems a good option but less so than the Integrator model.
- The Intermediary model adds extra serial marginalisation, as now there are three price setters for the cross-network trips. Prices are high, and profits low. Accordingly, this does not seem to be an attractive setting. This does assume that the platform does not increase travel demand in another way than through pricing, e.g. by making it easier to make cross-firm trips, but the same holds for all three MaaS settings.

These results suggest that both the Integrator model and the Platform model seem to contribute to realising cross-network services with lower prices than would result from free competition. The difference between these two models is the actor who sets the cross-network prices; in case of the Integrator model this is the platform, in case of the Platform model this is done by the transport providers. This is also reflected in the allocation of profits; in the former case the platform profits are higher, and in the latter case the transport providers get higher profits.

Table 4: Results of the different market structures under the base calibration

	<i>Free competition</i>	<i>Independent services</i>	<i>Marginal cost pricing</i>	<i>Integrator</i>	<i>Platform</i>	<i>Intermediary</i>
$P_{11}=P_{22}$	5.000	4.688	0=MC	4.157	4.989	5.312
$P_{12}=P_{21}$	6.666	NA	0=MC	4.164	6.678	7.927
$Q_{11}=Q_{22}$	73 333.3	93 750	100 000	66 808.0	73 601.3	78 434.7
$Q_{12}=Q_{21}$	33 333.3	0	100 000	66 626.3	33 061.8	15 653.3
<i>Consumer surplus</i>	2 233 330	2 197 270	7 500 000	3 338 890	2 291 760	1 947 140
<i>Transport firm's profit</i>	588 890	439 453	0	549 585	583 571	525 387
<i>MaaS profits</i>	NA	NA	NA	11 100	8 828	30 626
<i>Social surplus</i>	3 411 110	3 076 170	7 500 000	4 448 650	3 411 880	2 987 600
<i>Relative efficiency</i>	0	-0.0819	1	0.2537	0.0002	-0.1036

Note: Marginal costs are normalised to zero, and we assume that there are neutral scale economies and no fixed cost. Social surplus = Consumer surplus + Transport firms' profits + MaaS supplier profit. Relative efficiency is the gain in social surplus of a policy from the base case of free competition and no MaaS relative to the gain of going to the first-best outcome of marginal cost pricing.

5.2 Sensitivity analyses

Now we turn to sensitivity analysis of our numerical model to see how robust our results are, when each policy is better for profits or welfare and what the effects are of parameters. We will focus on prices, profits and social surplus. We will study the three MaaS models and compare their outcomes to the reference case of free competition. As the demand functions are the same in all settings, a lower price for a service always means a higher demand for that service, a higher total demand and a higher consumer surplus. Besides all of this, a test illustrated in Appendix E shows the effects of adopting different functional forms for the demand functions and finds that our qualitative results seem robust.

5.2.1. Sensitivity analysis: Integrator vs free competition without MaaS

Let us first consider the Integrator model. Figures 3 and 4 show the changes from the free-competition setting. Fig. 3 does this over ranges ϕ (share of revenue going to the MaaS firm) and Fig. 4 over ranges of b (own-price sensitivity) for three levels of c (cross-price sensitivity, i.e. the sensitivity to the prices of the other options). As the analytics predicted, the MaaS supply via Integrator lowers the prices by removing the serial marginalisation. Hence, the price drop is especially large for cross-network trips. The lowered prices also raise consumer surplus. Because prices become closer to the zero marginal costs, social surplus also increases. Transport firm profits fall unless the own-price sensitivity is very large (i.e. very large b).

The introduction of the Integrator model removes serial marginalisation—which raises profits—and leads to more competition—which lowers profits. With a high b , competition is always intense and profits low, so the competition effect of the Integrator is weak, and thus even the firms benefit. Note again that for simplicity we ignore any demand-increasing effect (i.e. a shift of the demand function rather than along the demand function) that MaaS may have. So in reality the Integrator is likely to be even more beneficial.

Prices change less in percentage terms when demand is more own-price sensitive, and prices change more when c is larger. The effect on consumer surplus and welfare changes is non-monotonic and depends on the interplay of c and b . Finally, the boundary $b > 3c$ for a working demand system is clearly visible, as the functions become asymptotically vertical at this point.

Fig.3: Effect of ϕ (share of revenue going to the platform) on the changes from going from free competition with no MaaS to the Integrator setting

(a) Price for direct services

(b) Price for cross-network trip using the Integrator

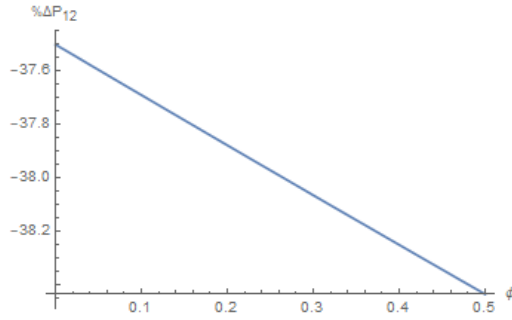
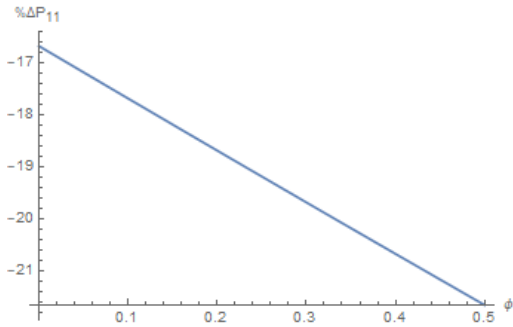

(c) Transport firm profits

(d) Consumer surplus

(e) Welfare

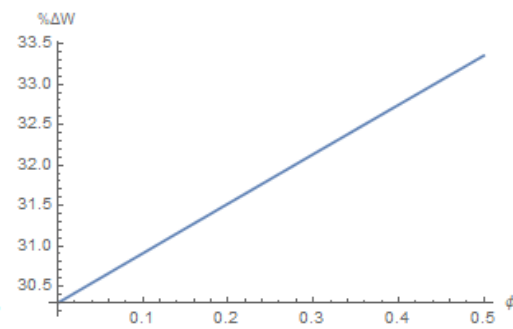
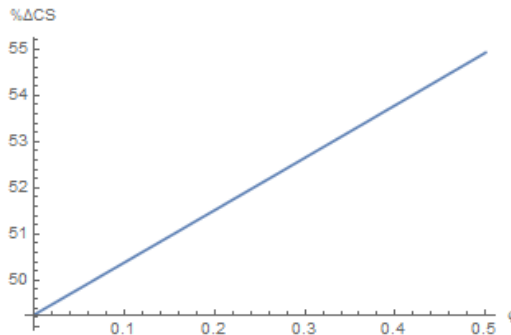
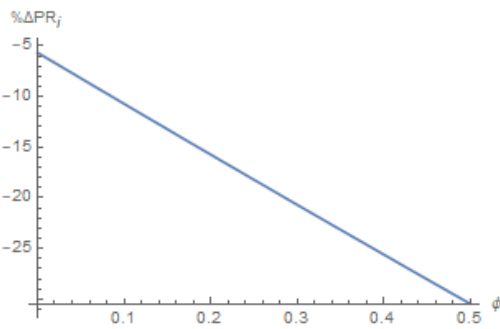
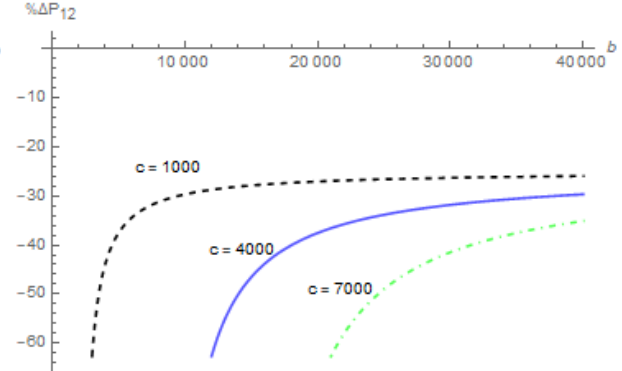
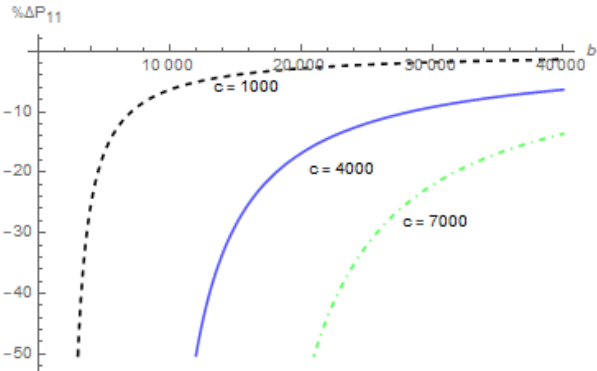

Fig.4: Effect of b (own-price sensitivity) and c (cross-price sensitivity) on the changes from going from free competition with no MaaS to the Integrator setting

(a) Price for direct services

(b) Price for cross-network trip using the Integrator



(c) Transport firm profits

(d) Consumer surplus

(e) Social surplus

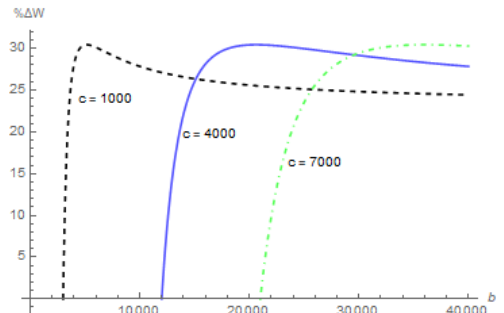
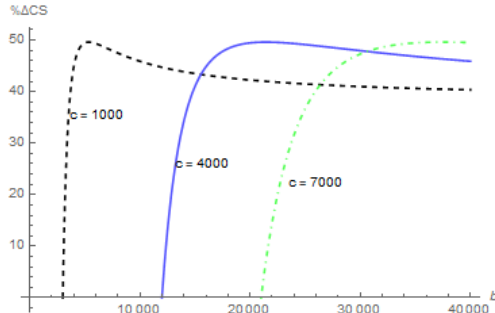
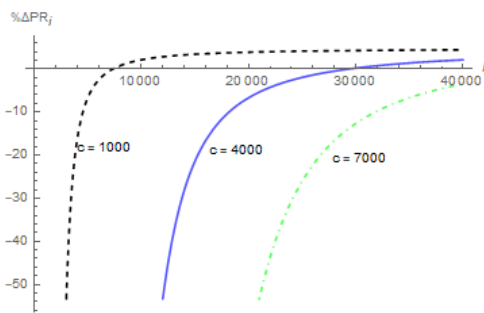

5.2.2. Sensitivity analysis: Platform model vs free competition with no MaaS

Now we turn to the changes that the Platform model causes from the free-competition setting without MaaS. Just as in the previous analysis, we will do so for ϕ in Fig. 5 and for b in Fig. 6. The introduction of MaaS via the Platform model has two effects on price setting. First, MaaS basically becomes a third supplier that supplies cross-network transport and so creates more competition for in-network trips and thus lowers their prices P_{11} and P_{22} . Second, MaaS uses the trips made by the transport firms, and consequently it causes even more serial marginalisation for the cross-trips and raises these prices P_{12} and P_{21} . It therefore depends on the parameters whether consumer surplus and social surplus are higher or lower with the Platform model than without MaaS, although for social surplus this is hard to see. The lower the share going to the platform or the less price-sensitive demand, the better the Platform setting performs compared to the setting without MaaS.

Fig. 5: Effect of ϕ (share of revenue going to the platform) on the changes from going from free competition with no MaaS to the Platform setting

(a) Price for direct services

(b) Price for cross-network trips using the Platform

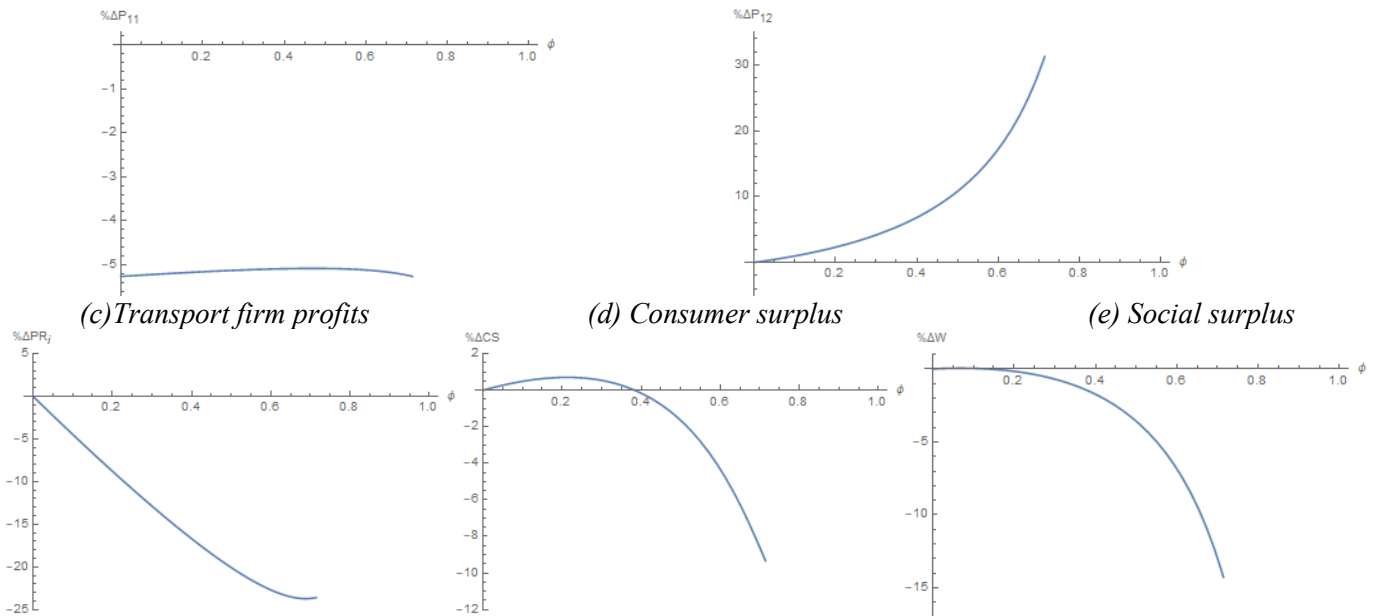
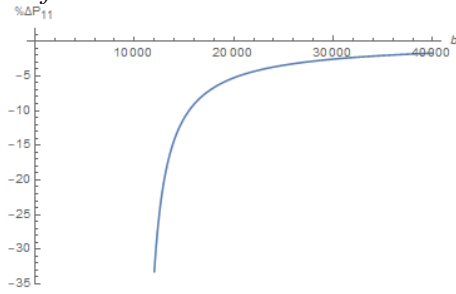
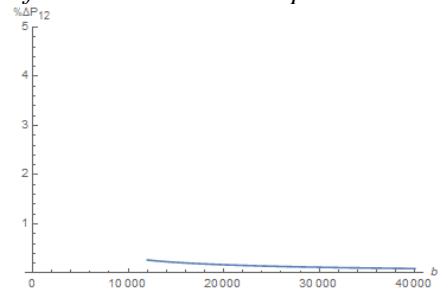

Fig. 6: Effect of b (own-price sensitivity) on the changes from going from free competition with no MaaS to the Platform setting

(a) Price for direct services



(b) Price for a cross-network trip



(c) Transport firm profits

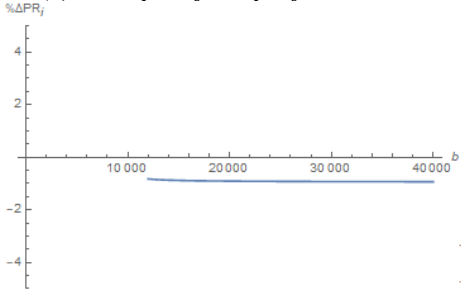

(d) Consumer surplus

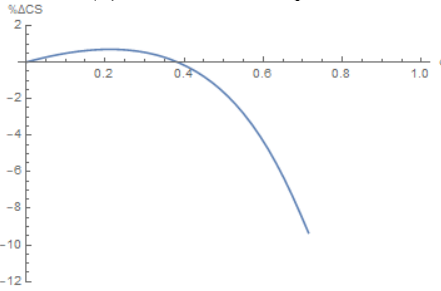

(e) Social surplus

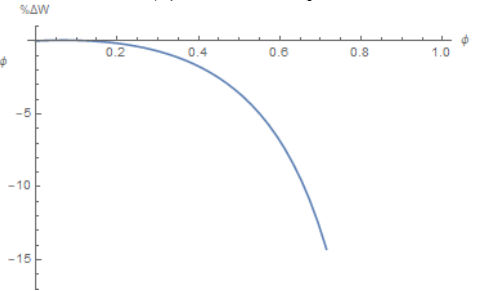

5.2.3. Sensitivity analysis: Platform model vs Integrator model

Now we turn to comparing the Platform model of MaaS to the Integrator model of MaaS, and look at the effect of ϕ in Fig. 7 and b and c in Fig. 8. As predicted by the analytics, the Platform model always has higher prices and thus lower consumer and social surpluses. It depends on the parameters as to which setting has the higher transport firm profits. The Platform setting does relatively better for the firms when the share going to the MaaS supplier is lower, demand is less sensitive to the own price, and demand is more sensitive to the price of other transport options.

Fig. 7: Effect of ϕ (share of revenue going to the platform) on the changes from going from the Integrator setting to the Platform setting

(a) Price for direct services

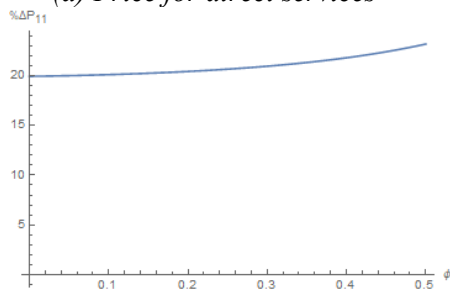

(b) Price for cross-network trips

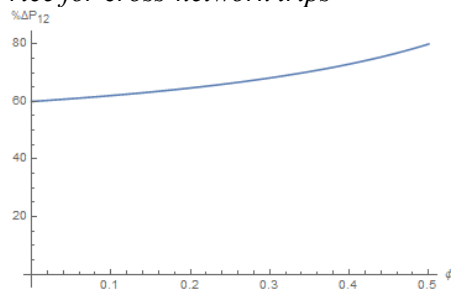

(c) Transport firm profits

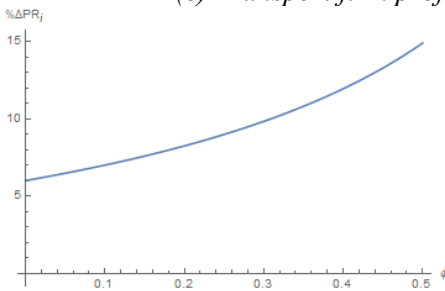

(d) Consumer surplus

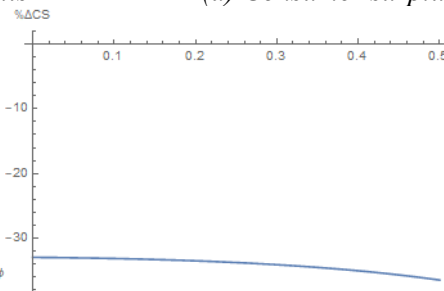

(e) Social surplus

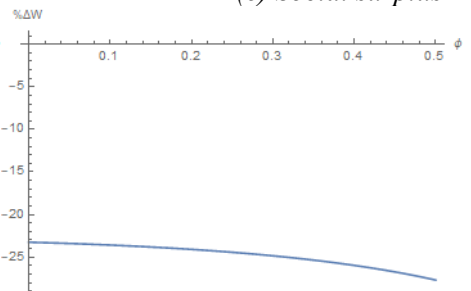
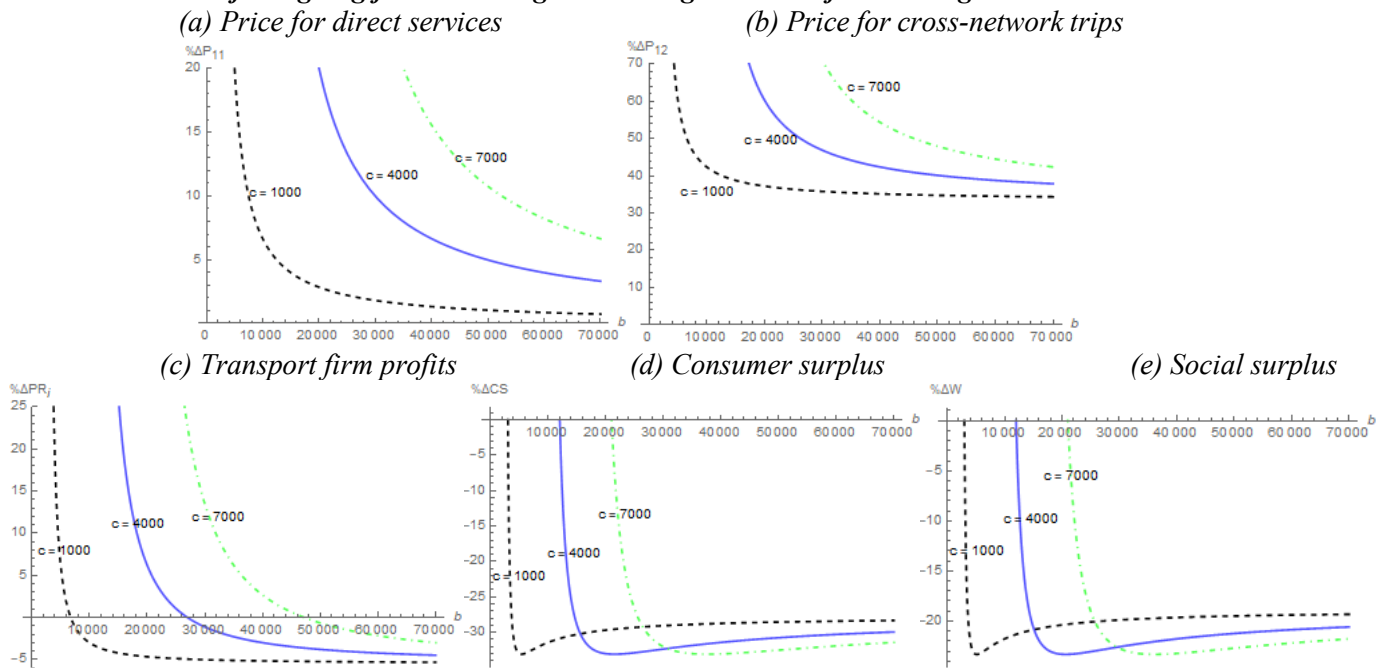

Fig.8: Effect of b (own-price sensitivity) and c (cross-price sensitivity) on the changes from going from the Integrator setting to the Platform setting



5.2.4. Sensitivity analyses for the Intermediary model

Finally, we turn to the sensitivity analyses for our third form of MaaS supply: the Intermediary model. We will focus on the effects of the own-price sensitivity, as it is most interesting. Fig. 9 shows that the Intermediary model leads to much higher prices than even the Platform model, and thus to lower social surplus, where the Platform model leads to higher prices than the Integrator model. It depends on the parameters as to whether profits are higher or lower. Finally, Fig. 10 show that prices are also much higher with Integrator than without any MaaS. The Intermediary setting tends to perform better for customers when demand is more sensitive to the own price, as this intensifies competition and lowers markups in all settings. Thus, the Intermediary model does not seem to be an attractive option for MaaS supply. Platform and especially Integrator seem much better.

Fig.9: Effect of b (own-price sensitivity) on the changes from going from the Platform setting to the Intermediary setting

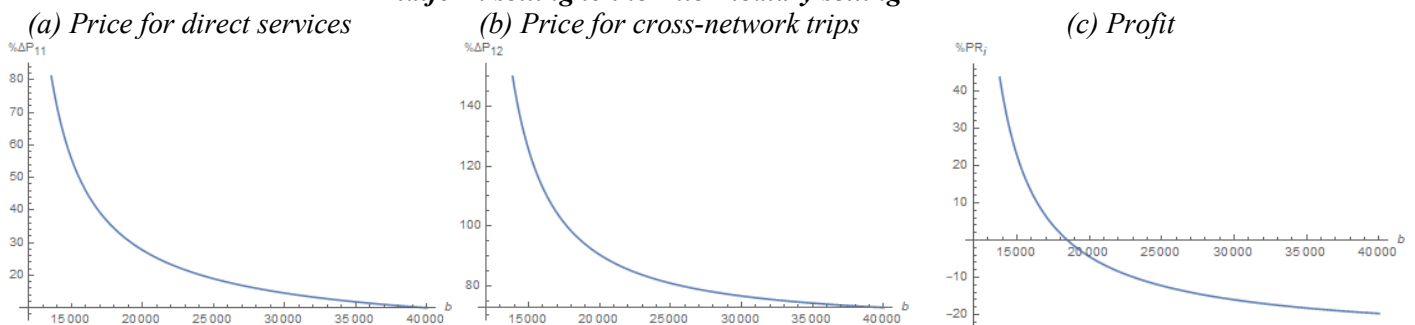
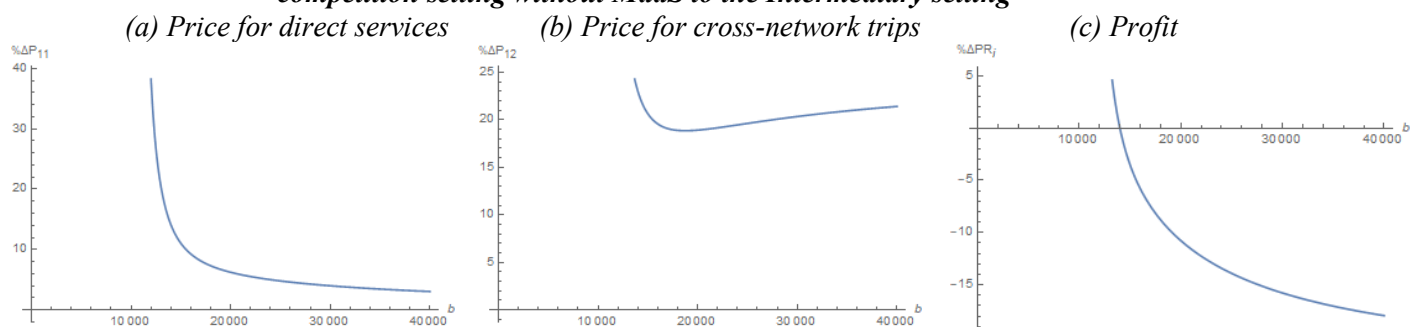

Fig. 10: Effect of b (own-price sensitivity) on the changes from going from the free-competition setting without MaaS to the Intermediary setting



5.5. Extensions of our model

Our model is rather stylized, and although the analytical results are complex, it is instructive to verify the effects of making different assumptions in our numerical model

- Increased demand for multimodal and public transport options is very often mentioned as an advantage of MaaS. Yet, we chose to ignore this in our main model for ease of presentation, and to focus on the effects of MaaS via the resulting market structure. Appendix G allows for MaaS leading to an increase in the demand intercept of cross-network trips to represent extra utility from a multimodal trip if supplied via a convenient MaaS channel. It logically finds that when MaaS lead to a larger demand shift, this increases the share of that trips that is cross-network. However, besides this, the effect of the market structures remain very similar as in our base numerical model.
- We assume away any transfer cost, waiting time or walking time when switching operators. Appendix H tests the effect of adding a transfer cost, and it analyses what happens when we change this cost. As expected, a higher transfer cost means that fewer people use cross-network travel. However, again the results remain similar to those in our base numerical model.
- Appendix E tests the effects of different functional forms for our demands, by adding a second-order term to the own-price sensitivity. It turns out that, for this check at least, our main results are robust to the choice of functional form.
- Appendix F allows for (dis)economies of scale by allowing average costs to vary with the amounts produced. It also allows the firms to have different costs. The degree of (dis)economies of scale and the heterogeneity in costs affect quantitative results, but qualitatively the outcomes remain very similar, and the effects of these extensions are as one would expect.
- Finally, our MaaS models assumed Nash-Bertrand competition. Appendix I allows for the MaaS operator to be a Stackelberg leader who sets its price first, and does so strategically to also affect the pricing of the transport firms. The Stackelberg assumption leads to more complex equations—making analytical study even more difficult—while numerical results are similar to those under Nash behaviour. Prices and profits are a bit higher with Stackelberg behaviour, and consumer surplus and welfare a bit lower. Still, the Stackelberg Integrator leads to markedly lower prices than the Nash Platform. So again, qualitatively our results seem robust to the assumed form of competition.

Over all, our main (numerical) results seem robust to the above extensions. The base model has the advantage that it allows for clearer analysis on the effects of the market structure of MaaS on the outcome of the transport market.”

5.6 *Concluding the numerical model*

The numerical section confirmed the predictions of the analytical model. The Integrator leads to much lower prices than the Platform and thus it has the higher welfare. In turn, the platform leads to much lower prices than the Intermediary. Conversely, it depends on the exact parametrisation which setting has the higher profit, but differences in profit tend to be small. We also saw that allowing for extensions to make the model more realistic—such an increased demand due to MaaS, transfer cost, heterogeneous firms, economies of scale and non-linear demand—affect the exact quantitative results, but do not overturn the qualitative results on the effects of the market structure of MaaS.

6. Regulation of wholesale prices

6.1 *Introduction*

It has been argued (e.g. Ecorys, 2015) that transport providers should offer their services at marginal costs to the platforms, or at collectively agreed upon wholesale prices. To be able to offer mobility services, MaaS firms need access to public transport services. Without access to the relevant services, MaaS companies cannot operate. Mobility service providers currently have limited access to the range of public transport services and prices offered by these firms. For example, (certain) transport firms do not offer access to discount products, and (some) carriers can unilaterally adjust agreements. This often implies that mobility service providers can only offer public transport services to private individuals at full-rate retail prices. As a result, mobility service providers cannot match the offers of transport firms that do sell various products with discounts to travellers.

One option to realise a level playing field is to require that transport firms offer these services at marginal costs (or a fixed and commonly agreed wholesale price) to the platforms. This was suggested by Economides and Salop (1992) under the name “one-sided joint price setting” or “one-sided regulation”. In this section, we will evaluate this idea for MaaS applications.

6.2 *Analytical model*

By assumption transport firms have to sell cross-network trips at marginal costs to the MaaS company. Two problems with this setting are that the government needs enormous amounts of information to verify the quoted marginal costs, and that transport firms would take losses if there are economies of scale (which we assume away). Perhaps more realistic, but even more information-intensive, would be allowing “some” profit. The current setting can be seen as an extreme ideal case that is best for consumers and social surplus. The platform maximises its profit by setting the cross-prices (s_{12} and s_{21}), taking these input costs as a starting point. Table 4 overviews the results.

Table 4: Analytical outcomes with wholesale price regulation

Equilibrium prices	$S_{11} = S_{22} = \frac{a b}{2 b^2 - 3 b c - c^2}$ $S_{12} = S_{21} = \frac{a(2 b + c)}{4 b^2 - 6 b c - 2 c^2}$
Equilibrium profits	<p><i>Transport providers:</i></p> $PR_1 = PR_2 = \frac{a^2 b^3}{c^4 + 6 b c^3 + 5 b^2 c^2 - 12 b^3 c + 4 b^4}$ <p><i>MaaS firm:</i></p> $PR_m = \frac{-1*(a^2 c^3 + 3 a^2 b c^2 - 4 a^2 b^3)}{2 c^4 + 12 b c^3 + 10 b^2 c^2 - 24 b^3 c + 8 b^4}$

6.3 Numerical model

Let us now return to the numerical model. Table 5 compares the effects of the regulated case to the unregulated cases. The regulation clearly benefits travellers, since they will experience much lower prices. The MaaS company benefits even more and sees gigantic profits. The transport firms will experience much lower profits, even in comparison with the case without cross-network services. Hence, they are unlikely to be willing to participate (unless they get a higher fee for cross-trips than just the marginal cost). This case is thus unlikely to be accepted by the transport firms.

To conclude, a MaaS with regulated supply may help consumers a bit more than even an Integrator MaaS. However, transport firms will dislike this option and will often prefer not to supply any cross-trips to the MaaS firm, making it difficult to implement. Further, regulation may be difficult and costly to implement, and there is the danger of misregulation if the marginal cost is not known or due to corruption. If we need to allow firms some profits instead of forcing them to sell at marginal costs, such regulation would be even more complex and less beneficial for consumers. So in the end such regulation does not seem very attractive, as it does little better for consumers than the best unregulated MaaS but is very sensitive to misregulation.

Table 5: Numerical outcomes with wholesale regulation under the base calibration

	<i>Free competition</i>	<i>Independent services</i>	<i>Integrator</i>	<i>Platform</i>	<i>Regulated</i>
$P_{11}=P_{22}$	5.000	4.688	4.157	4.989	3.676
$P_{12}=P_{21}$	6.666	NA	4.164	6.678	4.044
$Q_{11}=Q_{22}$	73 333.3	93 750	66 808.0	73 601.3	73 529.4
$Q_{12}=Q_{21}$	33 333.3	0	66 626.3	33 061.8	64 705.9
<i>Consumer surplus</i>	2 233 330	2 197 270	3 338 890	2 291 760	1 947 140
<i>Transport firm's profit</i>	588 890	439 453	549 585	583 571	270 329
<i>MaaS profit</i>	NA	NA	11 100	8 828	523 352
<i>Welfare</i>	3 411 110	3 076 170	4 448 650	3 411 880	4 651 820
<i>Relative efficiency</i>	0	-0.0819	0.2537	0.0002	0.3034

7. Conclusions

We analysed the effects of the introduction of Mobility as a Service (MaaS) in the market for transport services on prices, demands and profits. We considered different supply chain structures with two competing transport providers and one MaaS provider. The MaaS provider sells multimodal services from each of the two transport providers. We focus on the effects of MaaS via the market structure, and to do so ignore all other possible effects—such as ease of use and increased demand—to make the impacts via changes in competitive conditions as transparent as possible. When incorporating all possible effects of MaaS, it becomes difficult, if not impossible, to see the separate impacts of each.

Our first MaaS model was the **Integrator**, where the transport firms set their own prices for direct services and the MaaS provider sets the cross-network prices. The MaaS provider keeps a share of revenue. Prices are lower than without MaaS, since the MaaS provider acts as an additional competitor and serial marginalisation will be eliminated. Profits for the transport firms may be a bit higher or lower. In extreme parameter ranges, transport firms may want to stop supplying cross-network trips.

The second model was the **Platform model**, where the transport firms set all prices and the MaaS provider only offers a platform. In this case, the transport firms' profits may be higher or lower than with the Integrator, but profits are lower than without MaaS. Compared to the setting without MaaS, consumers see lower prices for in-network trips but higher prices for cross-network trips. In the base calibration of our numerical model, the platform and no-MaaS settings lead to similar prices, and this remains true unless demand is very price insensitive or the platform gets a very large share of revenue. Compared to the Integrator setting, prices are higher with the Platform. So, the Platform model seems a decent option, as prices and profits are similar to the option without MaaS, but the Integrator model seems even better.

The third model was the **Intermediary model**, with the transport firms as the leaders and setting their prices first. This option adds extra serial marginalisation—from the transport firms to the MaaS operator—but also adds more competition between the suppliers of final trips as now there are three. Prices are high, and profits are low. This does not seem to be a good way to introduce MaaS, and this shows the importance of how MaaS is supplied. Moreover, this outcome is problematic as in discussions with practitioners and regulators this form of MaaS is the most commonly named one.

We finally considered a **regulated case**, where the transport firms are required to offer the MaaS platform their services at marginal costs. This case is great for the customers, who see much lower prices for the direct and especially cross-network transport services. The transport firms see much lower profits than with free competition, and often also lower profits than when they stop supplying cross-network services. So firms are unlikely to be willing to participate unless they get a higher fee

for cross-trips than just the marginal costs. The government also needs accurate information on the marginal cost, which may be difficult to find, leading to dangers of misregulation.

Overall, we find that intermediaries, especially when they are integrators, will contribute to lower prices due to increased competition and less serial marginalisation. So MaaS seems beneficial even without considering the usual benefits of information provision, ease of use and increased demand for public transport. But for other market structures, in particular the Intermediary setting, prices are much higher and profits low. Hence, considering the market structure as we do is important: without considering the effects on pricing, the Intermediary seems a logical choice for introducing MaaS.

Partly to maintain the transparency of results, our models have a number of limitations which could be dealt with in future work.

- Most importantly, most MaaS offers value-added services that we omitted for transparency. For instance, if MaaS makes public transport more attractive and thus shifts out its demand function, this would make all our MaaS settings more beneficial for firms and customers. A sensitivity check also indicates this when we add such induced demand due to MaaS to our numerical model. Symmetrically, when there are extra transfer costs when switching between operators, this makes cross-network travel less attractive (see Appendix H), and then MaaS could have the extra benefit of lowering such transfer costs.
- For all MaaS cases, we assumed away the option of cross-network trips that do not use the MaaS supplier or on-network trips also being also by the MaaS. In reality, the ease of use of MaaS may mean that many of the trips that only use a single firm will be via a MaaS supplier. Alternatively, some other people may not use the MaaS for cross-network trips.
- We used constant marginal costs. However, in transport we often see economies of scale and congestion. Adding this would make results much less clear as any change in demand also leads to changes in (average) costs. We did do a numerical sensitivity check, and saw the expected result that if MaaS leads to more (less) demand then under economies of scale average cost and prices would fall (rise), and this would further increase (decrease) demand. So, economies of scale would strengthen any demand change. Conversely, diseconomies of scale or congestion would dampen any demand change.
- We used linear demand functions with strong assumptions about the parameters. We also assumed that demands and cost functions are symmetric. It seems interesting for future work to relax these simplifications. Appendixes E-H did some relaxations of such assumptions in our numerical model.
- Quality differences between the services have been ignored: e.g. a higher frequency of public transport vehicles makes travel by public transport more flexible and more attractive for users. Other important “quality” element in transport is how long trips take and how congested and crowded they are. If such quality characteristics are important, this also raises the danger of serial marginalisation in the quality setting (e.g. Czerny et al., 2016).

- We used synthetic links to describe travel upstream and downstream of the point where travellers have the option to switch mode. It would be attractive to explicitly model the networks that in reality make up these synthetic links. Doing so would allow one to study the choice of the “hub(s)” where modal switching is enabled. It would also allow investigating which origin-destination pairs are more amenable to MaaS. This issue we could only implicitly capture by the cross-substitution possibilities. However, given the choice of such hubs and given the implicit aggregation over origin destination pairs, we think our model still accurately describes the strategic market interactions between operators, as the basic relations that we assume for our synthetic links will remain true with more sophisticated network representations.
- We have only considered the companies being private firms that maximise profits. It would be interesting to look public organisations supplying the transport or the MaaS. When both transport firms are public with the objective to maximize social surplus, their initial prices would be the marginal costs. A private MaaS operator may then have very limited room to operate, and one may speculate that it can only charge a mark-up equal to the convenience gain from MaaS for the travellers. A more challenging case arises when one transport operator is public, and one private. We leave the treatment of these cases for future work.
- We look at 3 forms how MaaS may be organised. It seems interesting to look at other formats such as one of transport operator supplying the MaaS or a public private partnership (PPP).
- We assumed that firms are free to set their prices, but public transport fares are often heavily regulated.
- Linear price contracts between the transport firms and the MaaS were used. Marketing research has developed a number of other contract strategies that may circumvent some of the limitations of the linear contract.
- We assumed that there is only one MaaS supplier. What happens if there are multiple? What determines entry and exit of MaaS firms? What are the effects of entry or exit? These are issues that will be important for MaaS just like they have been for other social network, IT and transport areas.

The methodology applied in this paper is rich enough to be used in assessing the contribution of MaaS providers and the appropriate business models. This allows *ex ante* analysis of the different business configurations, obviously to be followed by real-world implementation and evaluation. The results show that the way how the MaaS supply is organised—integrator, platform or intermediary—strongly affects the outcomes. So care is needed in setting it up. MaaS can benefit consumers by increasing competition and removing serial marginalisation or it can hurt both consumers and transport firms by adding even more serial marginalisation.¹⁸

¹⁸All this is even before we consider other benefits or downsides of MaaS such as information provision or ease of use.

Acknowledgements

The contribution of Henk Meurs is part of SCRIPTS: Smart Cities Responsive Intelligent Public Transport Systems, a SURF (Smart Urban Regions of the Future) project, an initiative funded by NWO (The Netherlands Organisation for Scientific Research), various Dutch Ministries and several private and public social partners.

Declaration of interest

The authors have no financial and personal relationships with other people or organisations that could inappropriately influence (bias) their work.

Appendix A: Detailed results for the Integrator model

With respect to the *equilibrium prices* s_{11} , s_{22} and s_{12} and s_{21} we have for this specific model:

- Equilibrium prices are decreasing in b . The more price sensitive demand is, the smaller markups are, both for the direct services and for the cross-network services.
- Equilibrium prices are decreasing with the substitution parameter γ of the utility function. This implies that higher substitution between services leads to lower equilibrium prices for the direct services; competition among the different suppliers of direct and indirect services is increasing.
- Equilibrium prices for direct services are decreasing in ϕ ; a higher share of the revenue for the platform will lead to lower prices for all services.
- The cross-network prices are higher than the prices of the direct services. This difference is decreasing in b and increasing in the share ϕ that the platform takes.

Proof of Proposition 1:

Using the price equations in Tables 1–3, we see that prices are strictly positive as $b > 3 \cdot c > 0$ must hold with substitutes, $a > 0$ and $0 < \phi < 1$. We get the following differences in prices between the Integrator model and the free-competition cases:

$$\Delta P_{11} = \Delta P_{22} = -\frac{ac}{2(2b-5c)} \frac{2b+c+2b\phi-3c\phi}{2b^2-3bc+c^2(2-\phi)} < 0$$

$$\Delta P_{12} = \Delta P_{21} = -\frac{a}{6(2b-5c)} \frac{b^2-c^2+8c^2\phi}{2b^2-3bc+c^2(2-\phi)} < 0,$$

which are clearly negative. Consequently, the Integrator model has lower prices than with free competition. Logically, consumers are better off with lower prices, and so consumer surplus is higher. Social surplus is maximised with prices equal to the marginal cost of zero, so the closer the prices are to zero the higher the welfare. Hence, the Integrator case also has the higher welfare.

Now turning to the effects of parameter ranges, we will focus on the price difference for ΔP_{11} , and for the others the proofs work in the same way. We see that the first term, $\frac{ac}{2(2b-5c)}$, clearly increases with c . For the second term, the derivative is $\frac{2b+c+2b\phi-3c\phi}{2b^2-3bc+c^2(2-\phi)}$, which again is positive when $b > 3c$. Remember that with the minus sign at the equation, ΔP_{11} becomes more negative (i.e. smaller) the larger c is. Now for b , the derivative for the first term of ΔP_{11} is negative and the second is negative as well, being $-\frac{4b^2+4bc+c^2+\phi b(4b-12c)+c^2\phi(11-2\phi)}{(2b^2-3bc-2c^2+c^2\phi)^2}$. So ΔP_{11} becomes less negative the larger b is. Finally, the derivative of ΔP_{11} towards b is negative: the first term is independent of b , while the second term has a positive derivative of $\frac{(2b-5c)(b-c)(2b+c)}{(2b^2-3bc-2c^2+c^2\phi)^2}$. ■

Proof of Proposition 2:

Using the profit equations in Tables 1–3, we see that the difference in transport-firm profit follows the messy equation of:

$$\Delta PR = \frac{-a^2(2b+c)}{36(2b-5c)^2(2b^2-3bc+c^2(-2+\phi))^2} [12b^3c(5-33\phi) + 8b^4(9\phi-1) + 2b^2c^2(329\phi + 9\phi^2 - 10) - 3bc^3(50 + 71\phi + 27\phi^2) + c^4(97\phi^2 - 62 - 163\phi)].$$

Here, the fraction is clearly negative, but the term between brackets thereafter can be positive or negative. So profits can be lower or higher with the Integrator model than under free competition. ■

Appendix B: Detailed results for the Platform model

Table 4 gives the detailed results for the Platform setting, and these will be used below in proving the propositions.

Table B.1: Price, profit and demand equilibria for the Platform model of the market structure¹⁹

<i>Nash equilibria for prices, profits and demand for the Platform supply chain model</i>	
Price	$s_{ij}^* = \frac{a(1-\phi)(3b+c(3-2\phi))}{6b^2(1-\phi)-9bc(1-\phi)-c^2(15(1-\phi)+4\phi^2)}$ $p_i^* = q_i^* = \frac{a(c(2-\phi) + 2b(1-\phi))}{6b^2(1-\phi) - 9bc(1-\phi) - c^2(15 - 15\phi + 4\phi^2)}$
Transport firm Profit	$PR_i^* = (-1) \frac{(4\phi^4 - 28\phi^3 + 72\phi^2 - 80\phi + 32)a^2c^3 + (4\phi^4 - 36\phi^3 + 103\phi^2 - 118\phi + 47)a^2bc^2 + (-2\phi^2 + 4\phi - 2)a^2b^2c + (8\phi^3 - 33\phi^2 + 42\phi - 17)a^2}{(16\phi^4 - 120\phi^3 + 345\phi^2 - 450\phi + 225)c^4 + (-72\phi^3 + 342\phi^2 - 540\phi + 270)bc^3 + (48\phi^3 - 147\phi^2 + 198\phi - 99)b^2c^2 + (108\phi^2 + 216\phi - 108)b^3c + 36\phi^2 - 72\phi + 36)b^4}$
MaaS Profit	$PR_m^* = (-1) \frac{(12\phi^3 - 44\phi^2 + 40\phi)a^2c^3 + (28\phi^3 - 84\phi^2 + 64\phi)a^2bc^2 + (8\phi - 8\phi^2)a^2b^2c + (-16\phi^3 + 32\phi^2 - 16\phi)a^2b^3}{(16\phi^4 - 120\phi^3 + 345\phi^2 - 450\phi + 225)c^4 + (-72\phi^3 + 342\phi^2 - 540\phi + 270)bc^3 + (48\phi^3 - 147\phi^2 + 198\phi - 99)b^2c^2 + (-108\phi^2 + 108)b^3c + (36\phi^2 - 72\phi + 36)b^4}$

¹⁹ With respect to prices s_{ii} we see that equilibrium prices decrease in b and increase in ϕ . The equilibrium prices of the cross-network links p_i and q_j decrease with increase in b and increase with increase in ϕ , especially when ϕ is high.

With respect to the profits of the transport providers, we see that the profits decrease with higher price sensitivity b . In addition, the profits of the transport firms decrease a little with small ϕ but increase fast for large values for ϕ . The former may be related to having to share the profits with the MaaS platform. The larger effects of large values of ϕ may be due to lower demand for cross-network services; these may not be attractive anymore due to high prices. For the MaaS platform, the profits decrease with increasing b and become negative when the share ϕ gets large. Demand for the direct services decreases with b and increases with ϕ . Demand for the cross-services increases with b and decreases with increasing ϕ .

Proof of Proposition 3:

To start, we derive two conditions for an interior solution for the Platform model that will help. For non-negative prices $p_i=q_i$ in Table 3, we need the denominator not to be negative: $6b^2(1-\phi) - 9bc(1-\phi) - c^2(15-15\phi+4\phi^2) \geq 0$. Using $0 \leq \phi \leq 1$ and the necessary conditions for a working demand system with imperfect substitutes $b>3c>0$ and $a>0$, we can rewrite this to:

$$\phi < \frac{3}{8} \left(5 - \frac{2b^2}{c^2} + \frac{3b}{c} \right) + \frac{1}{8} \sqrt{3} \sqrt{-5 + \frac{12b^4}{c^4} - \frac{36b^3}{c^3} - \frac{b^2}{c^2} + \frac{42b}{c}}, \quad (\text{B.1})$$

which puts things in terms of ϕ vs ratio of demand sensitivities $\frac{b}{c}$. Note that condition (B.1) is not very strict. When $b=3c$, the ϕ would need to be below 0.7913; and, as b becomes larger or c smaller, the restrictions become even less strict. So in a real-world setting it will almost always hold, as it seems very extreme for the platform to keep 80% of revenue. Further, for an existing MaaS we need a positive demand for cross-network trips, $D_{ij}>0$. Using (B.1), this implies:

$$\frac{2b-5c}{2b-3c} > \phi. \quad (\text{B.2})$$

Again, this condition is not very strict. Using the base calibration of Section 4, it would be $\phi < 0.71$; when $b=\infty$, the condition would become $\phi < 1$, and for the lowest possible $b=3c$, it would become $\phi < 1/3$. So only for a very low b would this condition be a realistic problem.

Using the prices from Tables 1–3, $0 \leq \phi \leq 1$, $b>3c>0$ and $a>0$, we see that the difference in prices between the Platform and Integrator models are:

$$\begin{aligned} \Delta P_{11} = \Delta P_{22} &= -\frac{a(2b+c-c\phi)}{4b^2-6bc+2c^2(-2+\phi)} - \frac{a(-1+\phi)(-3b+c(-3+2\phi))}{6b^2(-1+\phi)-9bc(-1+\phi)+c^2(15-15\phi+4\phi^2)} > 0. \\ \Delta P_{12} = \Delta P_{21} &= -\frac{a(2b+c)}{4b^2-6bc+2c^2(-2+\phi)} + \frac{2a(c(-2+\phi)+2b(-1+\phi))}{6b^2(-1+\phi)-9bc(-1+\phi)+c^2(15-15\phi+4\phi^2)} > 0. \end{aligned} \quad (\text{B.3})$$

Both of these are positive when (B.1) holds, and so the Platform model has higher prices than the Intermediary model. This is not obvious in (B.3) or the price equations, but whenever the equations would suggest something else, the outcome would be a corner solution, as the Platform and possibly the Intermediary models would have negative prices following them, and this cannot be.

The differences in prices when going from free competition to the Platform model are:

$$\begin{aligned} \Delta P_{11} = \Delta P_{22} &= \frac{2ac\phi(2b(1-\phi)-c(5-3\phi))}{(2b-5c)(6b^2(-1+\phi)-9bc(-1+\phi)+c^2(15-15\phi+4\phi^2))} < 0, \\ \Delta P_{12} = \Delta P_{21} &= -\frac{(2/3)ac\phi(6b-c(15-8\phi))}{(2b-5c)(-6b^2(1-\phi)+9bc(1-\phi)+c^2(15(1-\phi)+4\phi^2))} > 0. \end{aligned}$$

The denominators of these two are the same and are negative when condition (B.2) holds. The numerators are similar, and both are positive when (B.2) holds. So this implies $\Delta P_{11} = \Delta P_{22} < 0$

and $\Delta P_{12} = \Delta P_{21} > 0$. Hence, compared with free competition, the platform has lower prices for in-network trips and higher ones for cross-network trips. ■

Proof of Proposition 4:

We will first look at what happens at a transport firm's profit when we go from free competition to the Platform model. The change in profit is:

$$\Delta PR = \frac{-4a^2\phi}{9(2b-5c)^2 (6b^2(-1+\phi)-9bc(-1+\phi)+c^2(15-15\phi+4\phi^2))^2} \{(72b^5(-1+\phi)^2 - 360b^4c(-1+\phi)^2 + 6b^3c^2(39-100\phi+55\phi^2+6\phi^3) - 6b^2c^3(-156+245\phi-113\phi^2+24\phi^3) + c^5(-900+1290\phi-615\phi^2+97\phi^3) + bc^4(-630+1284\phi-699\phi^2+113\phi^3))\}$$

Here, the fraction is clearly negative due to the minus sign. The term between curly brackets is less obvious but is positive when (B.1) holds. Accordingly, introducing MaaS via a Platform model leads to lower profits for transport firms.

Compared to the Integrator model, the Platform model can lead to higher or lower transport firm profits. The difference in profits is:

$$\Delta PR = \frac{a^2}{4(2b^2-3bc-2c^2+c^2\phi)^2 (-6b^2+9bc+15c^2+6b^2\phi-9bc\phi-15c^2\phi+4c^2\phi^2)^2} \{(16b^7(-1+\phi)^3 - 16b^6c(-1+\phi)^2(-5+3\phi) + c^7(-1+\phi)^2(-62+93\phi-47\phi^2+8\phi^3) + bc^6(-398+1083\phi-1081\phi^2+473\phi^3-77\phi^4) - 8b^4c^3(21-51\phi+64\phi^2-39\phi^3+5\phi^4) + 4b^5c^2(57-120\phi+110\phi^2-56\phi^3+9\phi^4) + b^2c^5(-930+2067\phi-1565\phi^2+481\phi^3-61\phi^4+8\phi^5) + b^3c^4(-894+1833\phi-1507\phi^2+675\phi^3-187\phi^4+16\phi^5))\}$$

The first fraction is clearly positive. It is proportional to a^2 , the demand intercept only affects the overall scale of profits and profits are proportional to a^2 . The denominator of the fraction is positive, as all terms are squared. The term between curly brackets is very messy and can be positive or negative, but this is not obvious. Let us replace b with $r \cdot c$, where $r = b/c > 3$ is the relative size of b . Then the term between curly brackets becomes:

$$(-1-3r-2r^2+\phi-r\phi+2r^2\phi)(62+212r+170r^2-40r^3-52r^4+8r^5-155\phi-468r\phi-271r^2\phi+130r^3\phi+72r^4\phi-16r^5\phi+140\phi^2+348r\phi^2+128r^2\phi^2-108r^3\phi^2-20r^4\phi^2+8r^5\phi^2-55\phi^3-100r\phi^3-11r^2\phi^3+18r^3\phi^3+8\phi^4+8r\phi^4),$$

which is still messy but more manageable. The first term between parentheses is always positive under our needed assumptions. The second can be positive or negative. So compared with the

Intermediary model, with the Platform model, transport-firm profits can be higher or lower. Fig. 2 in text depicts this, and is based on the second part of the above expression. The black area is where (B.1) is violated.

Now we turn to the comparison with free competition. The profit difference is:

$$\Delta PR = \frac{-4a^2\phi}{\left(9(2b-5c)^2(6b^2(-1+\phi)-9bc(-1+\phi)+c^2(15-15\phi+4\phi^2))^2\right)} \cdot (72b^5 - 360b^4c + 234b^3c^2 + 936b^2c^3 - 630bc^4 - 900c^5 - 144b^5\phi + 720b^4c\phi - 600b^3c^2\phi - 1470b^2c^3\phi + 1284bc^4\phi + 1290c^5\phi + 72b^5\phi^2 - 360b^4c\phi^2 + 330b^3c^2\phi^2 + 678b^2c^3\phi^2 - 699bc^4\phi^2 - 615c^5\phi^2 + 36b^3c^2\phi^3 - 144b^2c^3\phi^3 + 113bc^4\phi^3 + 97c^5\phi^3)$$

The fraction is again clearly negative, while the term between curly brackets is positive if (B.2) holds. So this implies that free competition always leads to higher firm profits than the Platform model, and this completes the proof of Proposition 4. ■

Appendix C: Detailed results for the Intermediary model

From the detailed results in Table C.1 for the Intermediary model we can gather the following. The wholesale prices of the transport providers decrease with b . The prices for the direct services paid by the travellers decrease with b , and so again when demand becomes more strongly price sensitive. The cross-network prices also decrease with b . Comparing the margins of the platform, we see a positive margin for the platform provider, which is decreasing in b . The profits for the transport provider decrease with b . The platform makes some profit for larger values of b .

Table C.1: Price, profit and demand equilibria for the Intermediary model of the supply chain structure
Equilibria for the Stackelberg game for transport services with the Intermediary supply chain model, with the transport firm as leader

Equilibrium prices	$p_i = q_i = (-1) \frac{ac^4 + 7abc^3 + 4ab^2c^2 - 16ab^3c + 8ab^4}{c^5 + 32bc^4 + b^2c^3 - 122b^3c^2 + 108b^4c - 24b^5}$
	$s_{ii}^* = (-1) \frac{4ac^4 + 13abc^3 - 11ab^2c^2 - 20ab^3c + 12ab^4}{c^5 + 32bc^4 + b^2c^3 - 122b^3c^2 + 108b^4c - 24b^5}$
	$s_{ij} = \frac{5ac^4 - 13abc^3 - 30ab^2c^2 + 92ab^3c - 40ab^4}{2c^5 + 64bc^4 + 2b^2c^3 - 244b^3c^2 + 216b^4c - 48b^5}$
Profit for transport firm	$PR_i^* = \frac{a^2(c^9 + 3bc^8 - 39b^2c^7 + 18b^3c^6 + 368b^4c^5 - 435b^5c^4 - 800b^6c^3 + 1784b^7c^2 - 1088b^8c + 208b^9)}{(c^5 + 32bc^4 + b^2c^3 - 122b^3c^2 + 108b^4c - 24b^5)^2}$
Profit for platform	$PR_m^* = (-1) \frac{81a^2c^9 + 189a^2bc^8 - 297a^2b^2c^7 + 111a^2b^3c^6 + 808a^2b^4c^5 - 1916a^2b^5c^4 + 2032a^2b^6c^3 + 1456a^2b^7c^2 + 512a^2b^8c - 64a^2b^9}{2c^{10} + 128bc^9 + 2052b^2c^8 - 360b^3c^7 - 15182b^4c^6 + 13240b^5c^5 + 27128b^6c^4 - 52800b^7c^3 + 35040b^8c^2 - 10368b^9c + 1152b^{10}}$

Proof of Proposition 5:

Let us first compare the prices with the Intermediary model with those under the Integrator model.

The differences in prices are:

$$\Delta P_{11} = \Delta P_{22} = \frac{a(b-c)c(c^4(15-7\phi)-bc^3(-57+\phi)+8b^4(5+3\phi)+2b^2c^2(5+11\phi)-4b^3c(17+15\phi))}{2(-24b^5+108b^4c-122b^3c^2+b^2c^3+32bc^4+c^5)(2b^2-3bc+c^2(-2+\phi))} > 0,$$

$$\Delta P_{12} = \Delta P_{21} = \frac{a(32b^6-112b^5c+120b^4c^2-44b^2c^4+23bc^5+11c^6+40b^4c^2\phi-92b^3c^3\phi+30b^2c^4\phi+13bc^5\phi-5c^6\phi)}{2(24b^5-108b^4c+122b^3c^2-b^2c^3-32bc^4-c^5)(2b^2-3bc-2c^2+c^2\phi)} > 0.$$

In both of these the numerator and denominator are positive when $b > 3c > 0$, $a > 0$ and $0 \leq \phi \leq 1$ hold.

So the Intermediary model has higher prices than the Integrator model.

Similarly, when compared to free competition we get:

$$\Delta P_{11} = \Delta P_{22} = \frac{ac(8b^4-44b^3c+82b^2c^2-25bc^3-19c^4)}{(2b-5c)(24b^5-108b^4c+122b^3c^2-b^2c^3-32bc^4-c^5)} > 0,$$

$$\Delta P_{12} = \Delta P_{21} = \frac{a(48b^5-288b^4c+584b^3c^2-364b^2c^3+31bc^4+83c^5)}{6(2b-5c)(24b^5-108b^4c+122b^3c^2-b^2c^3-32bc^4-c^5)} > 0,$$

which again are positive, and so the Intermediary model has higher prices than free competition. ■

Proof of Proposition 6:

We will first compare the transport firm's profit with the Intermediary model to that with the Integrator model. The difference in profit is:

$$\Delta PR = \frac{a^2}{4c} \left\{ \frac{4(1+3r-39r^2+18r^3+368r^4-435r^5-800r^6+1784r^7-1088r^8+208r^9)}{(1+32r+r^2-122r^3+108r^4-24r^5)^2} + \frac{2+4r^3(-2+\phi)-3\phi+\phi^2+r(6-7\phi+\phi^2)}{(-2-3r+2r^2+\phi)^2} \right\},$$

with $r=b/c$ being the ratio of demand sensitivities just as for Proposition 4 and ϕ the revenue share for the platform in the Integrator setting. The profit difference can be negative or positive depending on r and ϕ .

Let us now compare the profit with the Intermediary model to that with free competition. The difference in profit is:

$$\Delta PR = \frac{-a^2}{9(2b-5c)^2(24b^5-108b^4c+122b^3c^2-b^2c^3-32bc^4-c^5)^2} \cdot \{2304b^{11} - 29952b^{10}c + 156864b^9c^2 - 414720b^8c^3 + 545648b^7c^4 - 233056b^6c^5 - 177420b^5c^6 + 161696b^4c^7 + 12024b^3c^8 - 22465b^2c^9 - 2526bc^{10} - 257c^{11}\}.$$

The first term of this is clearly negative when we consider the squares in the denominator. The second term between curly brackets can be negative or positive. This depends on the demand-parameters ratio $r=b/c$ just as for Proposition 4. The second term is positive when:

$$-257 - 2526r - 22465r^2 + 12024r^3 + 161696r^4 - 177420r^5 - 233056r^6 + 545648r^7 - 414720r^8 + 156864r^9 - 29952r^{10} + 2304r^{11} > 0.$$

This proves that the profit with the intermediary can be higher or lower than with free competition depending on $r=b/c$. ■

Appendix D: Detailed demand and profit functions

Table D.1: Demand for routes with links i and j ($i,j=1,2$) and profits for the supply chain models

	Demand	Profit
Free competition	$D_{11}: a-b*s_{11} + c*(p_1 + q_2) + c*(p_2 + q_1) + c*s_{22}$ $D_{12}: a + c*s_{11} - b*(p_1 + q_2) + c*(p_2 + q_1) + c*s_{22}$ $D_{21}: a + c*s_{11} + c*(p_1 + q_2) - b*(p_2 + q_1) + c*s_{22}$ $D_{22}: a + c*s_{11} + c*(p_1 + q_2) + c*(p_2 + q_1) - b*s_{22}$	Firm 1: $D_{12}*p_1 + D_{21}*q_1 + s_{11}*D_{11}$ Firm 2: $D_{21}*p_2 + D_{12}*q_2 + s_{22}*D_{22}$
No cross-network trips	$D_{11}: a - b*s_{11} + c*s_{12} + c*s_{21} + c*s_{22}$ $D_{22}: a + c*s_{11} + c*s_{12} + c*s_{21} - b*s_{22}$	Firm 1: $s_{11}*D_{11}$ Firm 2: $s_{22}*D_{22}$
Integrator model	$D_{11}: a - b*s_{11} + c*s_{12} + c*s_{21} + c*s_{22}$ $D_{12}: a + c*s_{11} - b*s_{12} + c*s_{21} + c*s_{22}$ $D_{21}: a + c*s_{11} + c*s_{12} - b*s_{21} + c*s_{22}$ $D_{22}: a + c*s_{11} + c*s_{12} + c*s_{21} - b*s_{22}$	Firm 1: $D_{12}*s_{12}*(1-\phi)/2 + D_{21}*s_{21}*(1-\phi)/2 + s_{11}*D_{11}$ Firm 2: $D_{12}*s_{12}*(1-\phi)/2 + D_{21}*s_{21}*(1-\phi)/2 + s_{22}*D_{22}$ MaaS: $D_{12}*s_{12}*\phi + D_{21}*s_{21}*\phi$
Platform model, transport providers setting prices	$D_{11}: a - b*s_{11} + c*(p_1 + q_2) + c*(p_2 + q_1) + c*s_{22}$ $D_{12}: a + c*s_{11} - b*(p_1 + q_2) + c*(p_2 + q_1) + c*s_{22}$ $D_{21}: a + c*s_{11} + c*(p_1 + q_2) - b*(p_2 + q_1) + c*s_{22}$ $D_{22}: a + c*s_{11} + c*(p_1 + q_2) + c*(p_2 + q_1) - b*s_{22}$	Firm 1: $D_{12}*p_1*(1-\phi) + D_{21}*q_1*(1-\phi) + s_{11}*D_{11}$ Firm 2: $D_{12}*p_2*(1-\phi) + D_{21}*q_2*(1-\phi) + s_{22}*D_{22}$ MaaS: $D_{12}*(p_1 + q_2)*\phi + D_{21}*(p_2 + q_1)*\phi$
Intermediary model, transport firms setting prices	$D_{11}: a - b*s_{11} + c*s_{12} + c*s_{21} + c*s_{22}$ $D_{12}: a + c*s_{11} - b*s_{12} + c*s_{21} + c*s_{22}$ $D_{21}: a + c*s_{11} + c*s_{12} - b*s_{21} + c*s_{22}$ $D_{22}: a + c*s_{11} + c*s_{12} + c*s_{21} - b*s_{22}$	Firm 1: $D_{12}*p_1 + D_{21}*q_1 + s_{11}*D_{11}$ Firm 2: $D_{12}*p_2 + D_{21}*q_2 + s_{21}*D_{22}$ MaaS: $D_{12}*(s_{11} - (p_1 + q_2)) + D_{21}*(s_{22} - (p_2 + q_1))$

Appendix E. Different functional forms for the demands

To test for the effects of different functional forms of the demand function, we will redo our analyses while adding a second-order quadratic term to the own-price sensitivity. Adapting eq. 4, the demand for using Firm 1 for both legs of the trip would become (and similar for the other three options):

$$D_{11} = a - b P_{11} + c (P_{12} + P_{21} + P_{22}) - b_2 P_{11}^2. \quad (\text{E.1})$$

A negative b_2 implies a convex demand function, a positive b_2 implies a concave one, and $b_2=0$ is a linear demand and is the same as our base case.

Fig. E.1 studies the effect of changing parameter b_2 on the prices $P_{11}=P_{22}$ and $P_{12}=P_{21}$ and the transport firm profits $PR_1=PR_2$. It does so for our best two MaaS settings and compares their outcomes to that in the Free competition setting without MaaS by giving the percentage differences. We see that the Integrator leads to lower prices and profits than Free competition, while the Platform leads to about the same outcome as Free competition. Changing the shape of the demand function does not alter our qualitative main results, although there are quantitative effects. Interestingly, the effect of making the demand convex (negative b_2) is stronger than making it concave. Also, if b_2 gets negative enough, then the Platform model gives a slightly larger profit than Free competition, while in our base case it leads to a slightly lower one. But of course this is in line with our results, since Proposition 6 and the other sensitivity analyses already concluded that the profit can be higher or lower depending on the parameters.

To conclude, changing the shape of our demand function does not seem to change our main results. Although this is only a limited sensitivity check, this suggests that our overall results should be robust to the choice of type of demand function.

Fig. E.1: Effect of changing parameter b_2 (which affects the shape of the demand function) on the percent difference in prices and profits between our MaaS settings and Free competition (without MaaS setting).

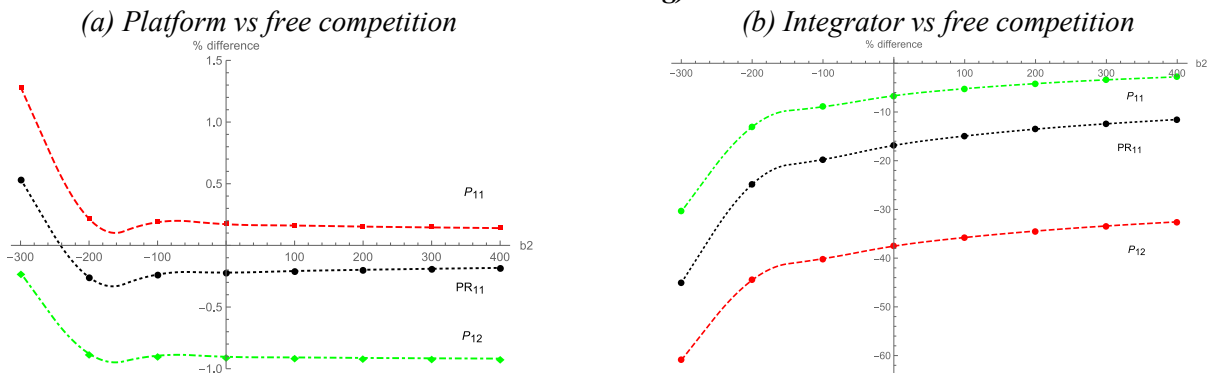

Note: Changing b_2 changes the shape of the demand function in E.1. A negative b_2 implies a convex demand function, a positive b_2 implies a concave one, and $b_2=0$ is a linear demand and is the same as our base case. The markers indicate calculated outcomes, the curves are fitted splines through them.

Appendix F: Economies of scale and asymmetric costs

Here, we test what the effects are of (dis)economies of scale. We will see that the effect of economies of scale are noticeable, but the effects are as one would expect in any (transport) setting and this is why in our main analysis we assumed them away for ease of presentation and analysis.

We introduce a parameter M that is the slope of the linear average cost. The average cost for firm 1 is $Intercept_1 + M * Q_{11} + M * (Q_{12} + Q_{21})/2$, and similar for the other firm. A positive M means diseconomies of scale and an average cost that increases with quantities consumed. $M=0$ means neutral scale economies and a constant average cost as in our base calibration. Finally, $M<0$ means economies of scale and an average cost that falls with the quantity consumed.

To also allow for heterogeneous firms, we make the intercept for Firm 1 a bit lower than of Firm 2. Hence, Firm 1 has an advantage and has lower (average) costs.

As we change M , we also adjust the intercepts. This ensures that (average) costs are positive, that firms are willing to operate, and that the prices and quantities implied by the first order conditions of profit maximization are positive.

Fig F.1: the effects of the (dis)economies of scale parameter M and heterogeneity in costs between firms on prices & the share of trips that is cross-network

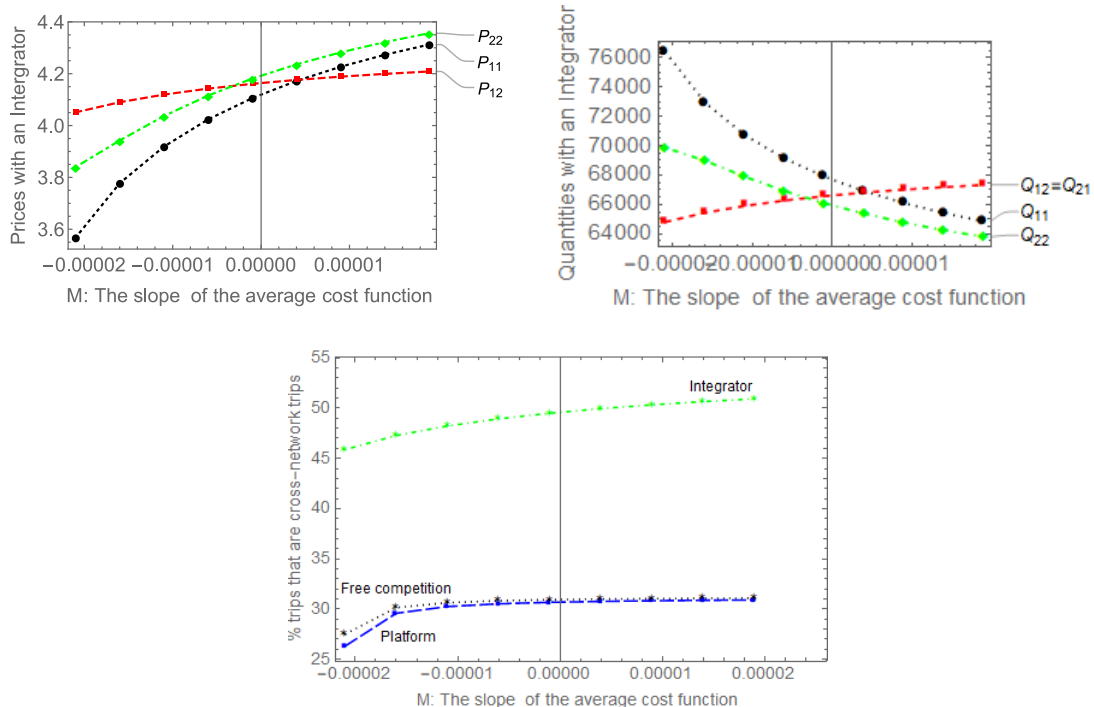

Note: The average cost of firm 1 is $AC_1 = Intercept_1 + M * Q_{11} + M * (Q_{12} + Q_{21})/2$ and for 2 it is $AC_2 = Intercept_2 + M * Q_{22} + M * (Q_{12} + Q_{21})/2$. The markers indicate calculated outcomes, the curves are fitted splines through them.

Fig. F.1 shows that the higher the slope M of the average cost functions—and thus the less economies of scale (or more diseconomies) there are—the higher the prices and the lower the quantities

consumed. The exceptions are the cross-network quantities Q_{12} and Q_{21} that rise slightly with M , and thus the share of people using cross-network options rises slightly with the slope M .

Finally, we see that Firm 2 who has slightly higher average costs for the same quantities transported has the disadvantage. It has higher costs and prices and a lower profit.

To conclude, The degree of (dis)economies of scale and the heterogeneity in costs off course affect quantitative results, but qualitatively the outcomes remain very similar.

Appendix G: Demand shift due to MaaS

Increased demand for multimodal and public transport options is a very often named advantage of MaaS. Yet, we chose to ignore this in our main model for ease of presentation and to focus on the effect of MaaS via the resulting market structure. Now, we will numerically check the effects of altering the demand intercept for cross network trips due to increased demand resulting from MaaS. We do so by increasing the demand intercept of the cross-network options (D_{12} and D_{21}) by some percentage when there is a MaaS. We will find that the effects such a demand shift is as one would expect: more use of cross-network options and higher mark-ups due to this increased demand.

Fig G.1: the effect of a demand shift due to MaaS on prices & the share of cross-network trips

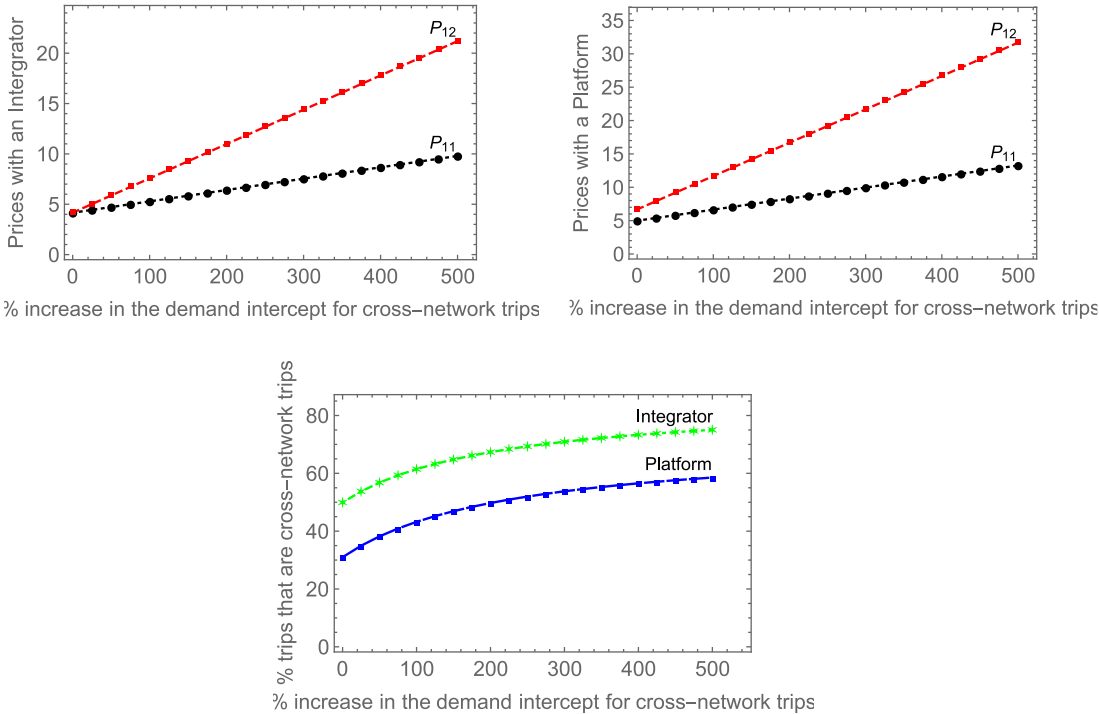

Fig. G.1 illustrates that overall demand increases with the size of the positive demand shift, and that cross-network trips that use the MaaS become relatively more common. The higher demand means that the mark-ups and thus prices increase, especially for cross-network trips. Naturally, without MaaS, there is no demand shift due to MaaS, so this has no effect on the Free competition setting.

Concluding, in our numerical model, introducing a demand shift towards cross-network travel due to MaaS means logically that MaaS will lead to more cross-network travel and to a higher mark-ups for these options. Besides this, the qualitative effects via the market structure remain the same.

Appendix H: Transfer cost

Now we will numerically check the effects of adding transfer costs, T , when using a cross network trip. These costs are assumed to be borne by the users. We will focus on the effects on prices, demands and profits of the two best MaaS settings. We will find that the effects of such a cost is as one would expect—less demand for cross-network travel and thus lower a lower mark-up for these options—which is why we chose to assume away this in our main model.

Fig H.1: the effect of the transfer cost for cross-network trips on prices of on-network ($P_{11}=P_{22}$) and cross-network ($P_{12}=P_{22}$) travel

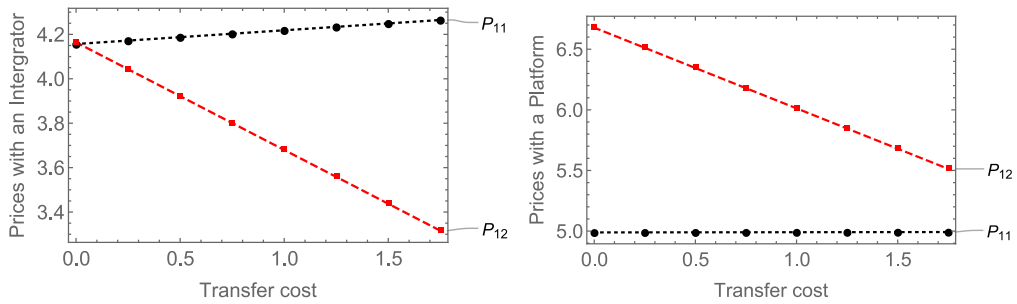
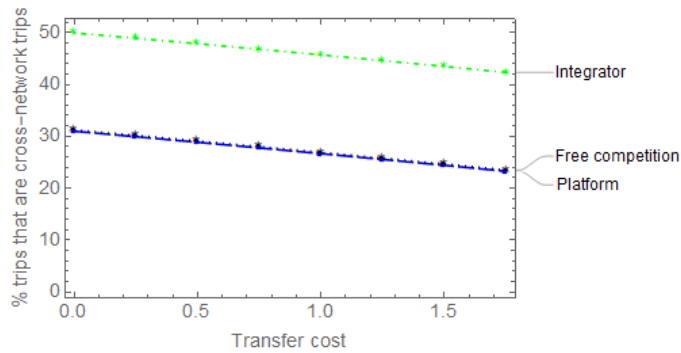

Fig H.2: the effect of the transfer cost for cross-network trips on the share of users using a cross-network option



The transfer cost is borne by the users if they use a cross-network option where there transfer between operators. This cost is the same with and without MaaS. We see in Figures H.1 and H.2 that the prices excluding the transfer cost for cross-network travel (i.e. the mark-ups $P_{12}=P_{22}$) fall as the transfer cost rises, while the ‘full price’ that also includes the transfer cost rises with the transfer cost. A transfer cost makes cross network travel less attractive, reducing its number of users and thus it lowers the mark-up. This fall in mark-up will be smaller than the transfer cost, and thus the overall ‘full price’ that equals $P_{12} + T = P_{22} + T$ will rise due to the inclusion of a transfer cost. The price $P_{11}=P_{22}$ of on-network trips

increases very slightly with the transfer cost, as these options will become more interesting for users and thus their mark-ups will go up. The effect of the transfer cost is quantitatively similar in all settings.

Appendix I : Stackelberg leader as the MaaS Integrator

In our main text we assumed Nash behaviour for the Integrator setting. Here, we will see what changes if the MaaS company is a Stackelberg leader who sets its prices first while considering the effects on the price setting of the transport firms who are followers. This thus differs from our Intermediary setting, as there the transport firms were the leaders. In the Platform setting, the MaaS sets no prices, and thus it cannot be a follower or a leader.

One would expect that the MaaS would want to set higher prices to induce the Transport firms to do the same. This we also see for our main numerical model in Table I.1 and in Fig I.1. It becomes clear that the Stackelberg setting leads to moderately higher prices and profits, but the Stackelberg setting remains very similar to the Nash Integrator setting. Interestingly, the transport firms have a second mover advantage, in that they see a larger percentage increase in profit than the leader. Prices are substantially higher in the Platform setting than in the Stackelberg Integrator setting. So, this main result on the difference between Integrator and Platform remains.

In Fig I.1, we vary the demand parameter b , as throughout we found this the most influential parameter. We see that the b has a substantial effect on prices and profits. However, no matter what the price sensitivity is, the Stackelberg setting remains very similar to the Nash Integrator with only somewhat higher prices and profits, and somewhat lower welfare and consumer surplus. The profits with the platform then to be higher still unless the demand parameter b is very high and thus demand very sensitive. This latter point is however difficult to see in the graph.

To summarise this sensitivity check. We see that allowing for Stackelberg behaviour instead of Nash leads to slightly higher prices and profits, as one would expect. Yet, the effects are minor and the two versions of the integrator model lead to very similar outcomes.

Table I.1: Comparing the numerical outcomes under a Stackelberg Integrator in the base calibration

	<i>Free competition</i>	<i>(Nash) Integrator</i>	<i>Stackelberg Integrator</i>	<i>Platform</i>
$P_{11}=P_{22}$	5.000	4.157	4.29	4.989
$P_{12}=P_{21}$	6.666	4.164	4.58	6.678
$Q_{11}=Q_{22}$	73 333.3	66 808.0	67924.2	73 601.3
$Q_{12}=Q_{21}$	33 333.3	66 626.3	61111.1	33 061.8
<i>Consumer surplus</i>	2 233 330	3 338 890	3 124 800	2 291 760
<i>Transport firm's profit</i>	588 890	549 585	565 748	583 571
<i>MaaS firm's profit</i>	NA	11 100	11 188	8 828
<i>Welfare</i>	3 411 110	4 448 650	4 267 480	3 411 880
<i>Relative efficiency</i>	0	0.2537	0.209439	0.0002

Fig 1.1: Comparing prices and transport firm profits for the Stackelberg Integrator over the own price sensitivity parameter b

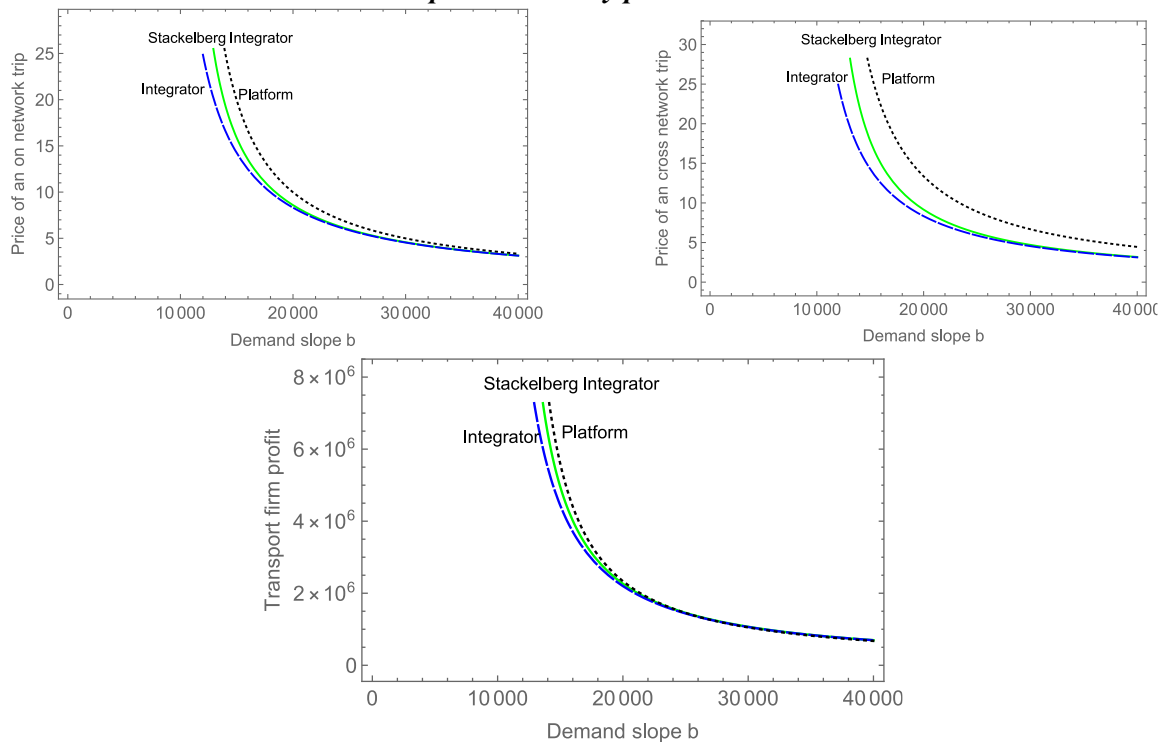

Note: A higher b means a more price-sensitive demand. In all three panes, the solid green curve is the Stackelberg Integrator, the blue dashed curve the base-case Nash Integrator, and the dotted black curve is the Platform.

References

- Brueckner, J.K., 2001. The economics of international codesharing: an analysis of airline alliances. *International Journal of Industrial Organization* 19(10), 1475-1498.
- Choi, S.C., 1991. Price competition in a channel structure with a common retailer. *Marketing Science* 10(4), 271-296.
- Clark, D.J., Jørgensen, F., Mathisen, T.A., 2014. Competition in complementary transport services. *Transportation Research Part B: Methodological* 60, 146-159.
- Czerny, A.I., van den Berg, V.A.C., Verhoef, E.T., 2016. Carrier collaboration with endogenous fleets and load factors when networks are complementary. *Transportation Research Part B: Methodological* 94, 285-297.
- D'Alfonso, T., Jiang, C., Bracaglia, V., 2016. Air transport and high-speed rail competition: environmental implications and mitigation strategies. *Transportation Research Part A: Policy and Practice* 92, 261-276.
- Di, X., Ban, X. J., 2019. A unified equilibrium framework of new shared mobility systems. *Transportation Research Part B: Methodological* 129, 50-78.
- Djavadian, S., Chow, J.Y., 2017. An agent-based day-to-day adjustment process for modeling 'mobility as a service' with a two-sided flexible transport market. *Transportation Research Part B: Methodological* 104, 36-57.
- Ebrahimigharehbagh, F. Sharmeen and H. Meurs (2018). Innovative Business Architectures (BAs) for Mobility as a Service (MaaS) – exploration, assessment, and categorization using operational MaaS cases. In: Transportation Research Board 97th Annual Meeting, Washington DC, 7-11 January 2018.
- Economides, N., Salop, S.C., 1992. Competition and integration among complements, and network market structure. *Journal of Industrial Economics* 40(1), 105-123.
- Ecorys, 2015. Effecten toetreding nieuwe mobiliteitskaartaanbieders op bestaande ov-concessies (Effects of entry of new mobility card providers on existing public transport concessions, in Dutch). Report prepared for the Dutch Ministry of Transport and Waterworks. Rotterdam.
- Jittrapirom, P., Caiati, V., Feneri, A.M., Ebrahimigharehbaghi, S., Alonso-Gonzalez, M.J., Narayan, J., 2017. Mobility as a service: a critical review of definitions, assessments of schemes, and key challenges. *Urban Planning*, 2, 13-25.
- Kamargianni, M., Matyas, M. (2017). The Business Ecosystem of Mobility-as-a-Service. 96th Transportation Research Board (TRB) Annual Meeting. Washington DC, 8-12 January 2017.

- Kamargianni, M., Li, W., Matyas, M., & Schäfer, A. (2016). A critical review of new mobility services for urban transport. *Transportation Research Procedia*, 14, 3294-3303.
- Kaspi, M., Raviv, T., Tzur, M., 2014. Parking reservation policies in one-way vehicle sharing systems. *Transportation Research Part B: Methodological* 62, 35-50.
- Ke, J., Yang, H., Li, X., Wang, H., Ye, J., 2020. Pricing and equilibrium in on-demand ride-pooling markets. *Transportation Research Part B: Methodological*, 139, 411-431.
- König, D., Eckhardt, J., Aapaoja, A., Sochor, J. L., & Karlsson, M. (2016). Deliverable 3: Business and operator models for MaaS. MAASiFiE project funded by CEDR. MAASiFiE project funded by CEDR. Accessed from https://publications.lib.chalmers.se/records/fulltext/239795/local_239795.pdf on 22 Augustus 2021.
- Lin, M.H., 2004. Strategic airline alliances and endogenous Stackelberg equilibria. *Transportation Research Part E: Logistics and Transportation Review*, 40(5), 357-384
- Ma, R., Zhang, H.M., 2017. The morning commute problem with ridesharing and dynamic parking charges, *Transportation Research Part B: Methodological* 106, 345-374.
- Mantin, B., 2012. Airport complementarity: private vs. government ownership and welfare gravitation. *Transportation Research Part B: Methodological* 46(3), 381-388.
- Meurs, H, Sharmeen, F., Marchau, V., van der Heijden, R., 2020. Organizing integrated services in mobility-as-a-service systems: principles of alliance formation applied to a MaaS-pilot in The Netherlands. *Transportation Research Part A: Policy and Practice* 131, 178-195.
- Pandey, V., Monteil, J., Gambella, C., Simonetto, A., 2019. On the needs for MaaS platforms to handle competition in ridesharing mobility. *Transportation Research Part C: Emerging Technologies* 108, 269-288.
- Pantelidis, T.P., Chow, J.Y., Rasulkhani, S., 2020. A many-to-many assignment game and stable outcome algorithm to evaluate collaborative mobility-as-a-service platforms. *Transportation Research Part B: Methodological* 140, 79-100.
- Park, S.Y., Keh, H.T., 2003. Modelling hybrid distribution channels: a game-theoretic analysis. *Journal of Retailing and Consumer Services* 10(3), 155-167.
- Pöllänen, J., 2020. Whim, how to make yourself ready for mobility as a service? <https://www.maas-market.com/sites/default/files/JOANNA%20POLLANEN.pdf>. Accessed 20 May 2020.
- Polydoropoulou, A., Pagoni, I., Tsirimpa, A., Roumboutsos, A., Kamargianni, M., Tsouros, I., 2020. Prototype business models for mobility-as-a-service. *Transportation Research Part A: Policy and Practice* 131, 149-162.
- Rasulkhani, S., Chow, J.Y., 2019. Route-cost-assignment with joint user and operator behavior as a many-to-one stable matching assignment game. *Transportation Research Part B: Methodological* 124, 60-81.
- Silva, H.E., Verhoef, E.T., 2013. Optimal pricing of flights and passengers at congested airports and the efficiency of atomistic charges. *Journal of Public Economics* 106, 1-13.
- Simoni, M.D., Kockelman, K.M., Gurusurthy, K.M., Bischoff, J., 2019. Congestion pricing in a world of self-driving vehicles: an analysis of different strategies in alternative future scenarios. *Transportation Research Part C: Emerging Technologies* 98, 167-185.
- Singh, N., Vives, X., 1984. Price and quantity competition in a differentiated duopoly. *The Rand Journal of Economics* 15(4), 546-554.
- Tan, B.Q., Xu, S.X., Zhong, R., Cheng, M., Kang, K., 2019. Sequential auction based parking space sharing and pricing mechanism in the era of sharing economy. *Industrial Management & Data Systems* 119(8), 1734-1747.
- Van de Velde, D.M., 2005. Co-ordination, integration and transport regulation. In Button, K.J. and Hensher, D.A. (Eds) *Handbook of Transport Strategy, Policy and Institutions*. Elsevier, Oxford. 115-134.
- van den Berg, V.A.C., 2013. Serial private infrastructures. *Transportation Research Part B: Methodological* 56, 186-202.
- UITP (2019). *Mobility as a service*. Report prepared by the International Association of Public Transport (UITP), Brussels, Belgium.
- van den Berg, V.A.C, Verhoef, E.T., 2016. Autonomous cars and dynamic bottleneck congestion: the effects on capacity, value of time and preference heterogeneity. *Transportation Research Part B: Methodological* 94, 43-60.
- Verhoef, E.T., 2008. Private roads: auctions and competition in networks. *Journal of Transport Economics and Policy* 42(3), 463-493.
- Verhoef, E.T., Emmerink, R.H., Nijkamp, P., Rietveld, P., 1996. Information provision, flat and fine congestion tolling and the efficiency of road usage. *Regional Science and Urban Economics* 26(5), 505-529.
- Vij, A., Ryan, S., Sampson, S., Harris, S., 2020. Consumer preferences for mobility-as-a-service (MaaS) in Australia. *Transportation Research Part C: Emerging Technologies* 117, 102699.
- Zhang, R., Liu, B., Wang, W., 2012. Pricing decisions in a dual channels system with different power structures. *Economic Modelling* 29(2), 523-533.