

Yang, Xiaoliang; Zhou, Peng

Working Paper

Wealth inequality and social mobility: A simulation-based modelling approach

Cardiff Economics Working Papers, No. E2022/3

Provided in Cooperation with:

Cardiff Business School, Cardiff University

Suggested Citation: Yang, Xiaoliang; Zhou, Peng (2022) : Wealth inequality and social mobility: A simulation-based modelling approach, Cardiff Economics Working Papers, No. E2022/3, Cardiff University, Cardiff Business School, Cardiff

This Version is available at:

<https://hdl.handle.net/10419/261231>

Standard-Nutzungsbedingungen:

Die Dokumente auf EconStor dürfen zu eigenen wissenschaftlichen Zwecken und zum Privatgebrauch gespeichert und kopiert werden.

Sie dürfen die Dokumente nicht für öffentliche oder kommerzielle Zwecke vervielfältigen, öffentlich ausstellen, öffentlich zugänglich machen, vertreiben oder anderweitig nutzen.

Sofern die Verfasser die Dokumente unter Open-Content-Lizenzen (insbesondere CC-Lizenzen) zur Verfügung gestellt haben sollten, gelten abweichend von diesen Nutzungsbedingungen die in der dort genannten Lizenz gewährten Nutzungsrechte.

Terms of use:

Documents in EconStor may be saved and copied for your personal and scholarly purposes.

You are not to copy documents for public or commercial purposes, to exhibit the documents publicly, to make them publicly available on the internet, or to distribute or otherwise use the documents in public.

If the documents have been made available under an Open Content Licence (especially Creative Commons Licences), you may exercise further usage rights as specified in the indicated licence.

Cardiff Economics Working Papers



Working Paper No. E2022/3

Wealth Inequality and Social Mobility: A Simulation-Based Modelling Approach

Xiaoliang Yang and Peng Zhou

February 2022

ISSN 1749-6010

Cardiff Business School
Cardiff University
Colum Drive
Cardiff CF10 3EU
United Kingdom
t: +44 (0)29 2087 4000
f: +44 (0)29 2087 4419
business.cardiff.ac.uk

This working paper is produced for discussion purpose only. These working papers are expected to be published in due course, in revised form, and should not be quoted or cited without the author's written permission. Cardiff Economics Working Papers are available online from:
<http://econpapers.repec.org/paper/cdfwpaper/> and
business.cardiff.ac.uk/research/academic-sections/economics/working-papers
Enquiries: EconWP@cardiff.ac.uk

Wealth Inequality and Social Mobility: A Simulation-Based Modelling Approach

Xiaoliang Yang^a and Peng Zhou^{b*}

^a Zhongnan University of Economics and Law, Wuhan, China. Email: xiaoliang@zuel.edu.cn

^{b*} Corresponding author. Cardiff University, Cardiff, UK. Address: D47, Aberconway Building, Colum Drive, Cardiff, CF10 3EU, UK. Email: zhoup1@cardiff.ac.uk

Funding: This work was supported by the Fundamental Research Funds for the Central Universities, ZUEL [grant number 31512010906], and Innovation and Talent Base for Income Distribution and Public Finance [grant number IIDPF2020B013].

Declaration of Interest: None.

Wealth Inequality and Social Mobility: A Simulation-Based Modelling Approach¹

Abstract: We design a series of simulation-based thought experiments to deductively evaluate the causal effects of various factors on wealth inequality (the distribution) and social mobility (dynamics of the distribution). We find that uncertainty per se can lead to a “natural” degree of inequality and returns-related factors contribute more than earnings-related factors. Based on these identified factors, we construct an empirical, hybrid agent-based model to match the observed wealth inequality measures of the G7 countries and China. The estimated model can generate a power-law wealth distribution for the rich and a positively sloped intra-generational Great Gatsby curve. We also demonstrate how this hybrid model can be extended to a wide range of questions such as redistributive effects of tax and finance.

Keywords: Wealth Inequality; Social Mobility; Agent-Based Model

JEL: D31, E21, J60

1 Introduction

Wealth inequality has increased in major economies over the last decades (Figure 1). Specifically, the wealth Gini and the top 10% wealth share in the US reached record levels, remarkably higher than its G7 peers, especially during the COVID-19 pandemic (Couch *et al.*, 2020). Meanwhile, inequality in China had worsened dramatically. There is a huge literature on the effect of inequality on welfare, trust, and growth (Gächter *et al.*, 2017; Turnovsky, 2015; Alesina *et al.*, 2004) and therefore on the optimal inequality (Bardhan *et al.*, 2007; Martin, 1999). Instead, this paper focuses on the upstream of the issue—*what are the factors that cause wealth inequality?*

Wealth inequality is inextricably intertwined with social mobility in public choices (Roth & Wohlfart, 2018; Almas *et al.*, 2011). Inequality takes a static snapshot of the distribution of wealth at a point in time, and social mobility describes the dynamic evolution of the distribution. Arguably and ideally, a social system with high concentration of wealth (“inequality of outcome”) can only be economically efficient and politically acceptable if the social mobility (“equality of opportunity”) is high (Kanbur & Stiglitz, 2016). However, empirical evidence (Fisher *et al.*, 2016; Corak, 2020) suggests a negative correlation between wealth inequality and inter-generational social mobility (known as the “Great Gatsby curve”), which seems to negate the Utopian hope. To resolve this disjunction, we attempt to simultaneously address a closely related question—*what are the factors that cause social mobility?*

¹ We are grateful for the constructive comments from the editor and two anonymous referees. We are also thankful for the proofreading by Prof. James Foreman-Peck at Cardiff University. All errors remain our own.

Figure 1 Measures of Wealth Inequality in Selected Countries

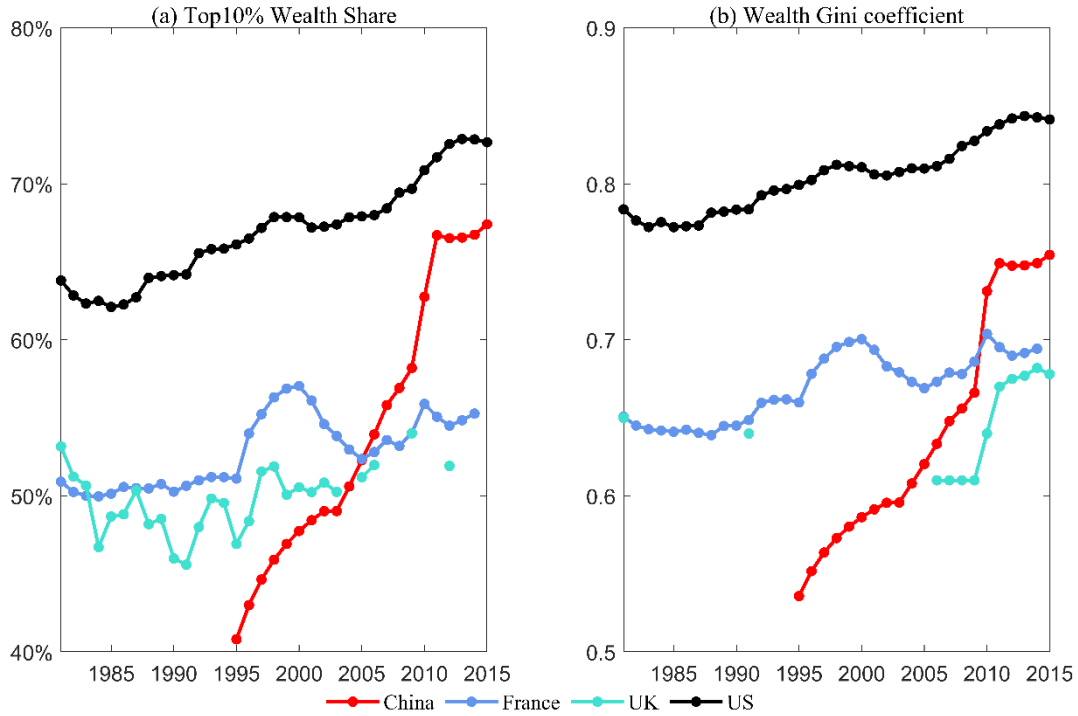

Data source: World Inequality Database (WID). The wealth Gini of the UK is from Credit Suisse.

Unfortunately, data on social mobility are extremely scanty and most empirical studies are on inter- rather than intra-generational mobility (Adermon *et al.*, 2018; Björklund *et al.*, 2012). Only a few longitudinal surveys are available for a specific period and a specific country (Fisher *et al.*, 2016; Kopczuk *et al.*, 2010). In fact, data availability on wealth inequality is not much better due to the lack of observations on the richest (Alvaredo *et al.*, 2018). Any *inductive reasoning* is ultimately restricted by observable evidence, but can we say anything about the factors that affect wealth inequality and social mobility without a complete dataset of empirical observations? In other words, can we discuss causality when data-demanding econometrics is not feasible? We propose simulation-based thought experiments or Agent-Based Models (ABMs) to provide some novel insights into causality-type questions in a *deductive reasoning* tradition. This new approach allows us to establish the causalities and evaluate the relative importance of the factors based on controlled thought experiments. This is the first contribution of the paper—to theoretically test factors that influence wealth inequality and social mobility when data are limited.

The second contribution of this paper is empirical. We construct a hybrid ABM with all identified factors as well as substantial realistic features. The model is then simulated in a bottom-up fashion and estimated to match the observable evidence of the eight major economies (G7+C). Our paper is surely not the first in the literature to address both inequality and mobility (see for example, Benhabib *et al.*, 2019; Corak, 2013; De Nardi, 2004), but to our knowledge

it is the first attempt to estimate an empirical ABM in this field. One advantage of our approach is that we can derive unobservable information such as upper-tail wealth and intra-generational transition matrices based on the model. These by-products enable a rich set of empirical inferences which are not easy to obtain with traditional econometric approaches. For example, compared to Benhabib *et al.* (2019) who adopt the neoclassical tradition, our empirical ABM can better match a famous stylized fact—that wealth distribution follows a power-law at the upper tail and an exponential distribution for the poor. In contrast to Vermeulen (2018) who uses only the top-tail wealth data, we can estimate the index of tail thickness for the entire wealth distribution. Another interesting finding is that we obtain a positively sloped intra-generational Great Gatsby curve, in contrast to the inter-generational Great Gatsby curve which is normally negatively sloped (Corak, 2013).

The third contribution is methodological. Despite its own limitations, ABMs provide a promising alternative to, or at least a complement of, the mainstream neoclassical paradigm of optimization and general equilibrium. The flexibility of ABMs in incorporating heterogeneity and interactions can shed useful light on the modelling issues in the neoclassical doctrine. In fact, an increasing number of attempts have been made in macroeconomic literature to advocate an open stance towards ABMs especially after the global financial crisis in 2008 (Papadopoulos, 2019; Farmer & Foley, 2009; Colander *et al.*, 2008). The following section discusses the necessity, advantages, and disadvantages of our proposed approach before we conduct a thorough literature review on inequality and mobility (Section 3). Some important factors identified in the literature are deductively (not inductively) tested with the carefully designed thought experiments (Section 4), which form the basis of the empirical ABM before implications (Section 5). The empirical ABM is then extended to address two heatedly discussed issues in the literature (Section 6) before conclusions (Section 7) are drawn.

2 Methodological Discussion

Let us start our methodological discussion with a heuristic quiz².

Imagine there is an island with $N = 1,000$ residents, and each of them initially owns exactly the same wealth, $w_0 = 3$ units of coconuts.³ At the beginning of every period, each resident must hand in 1 unit of coconut to the chief, who then randomly distributes

² This quiz is adapted from a famous idea by physicists more than 100 years ago—the distribution of wealth resembles the distribution of energy among molecules in a gas, a pattern called the Boltzmann-Gibbs distribution. People exchange wealth when they meet, much as gas molecules exchange energy when they collide. See Drăgulescu & Yakovenko (2000) for more details.

³ If we treat the handed-in coconuts as “output” generated from “capital” (i.e., a simple AK model), the initial endowment level is to match the average capital-output ratio of 3 in OECD countries.

each collected coconut to all residents with absolutely equal opportunity.⁴ After, say, $T = 1,000$ periods, what does the final wealth distribution look like?

The first impression would be, given that both the initial endowment and the opportunity of obtaining the new income are perfectly equal, the final distribution must resemble the initial (uniform) distribution with no substantial inequality. However, computer simulation shows that the final distribution is asymptotically normal (Figure 2).

Figure 2 The Wealth Distribution with Stochastic Income

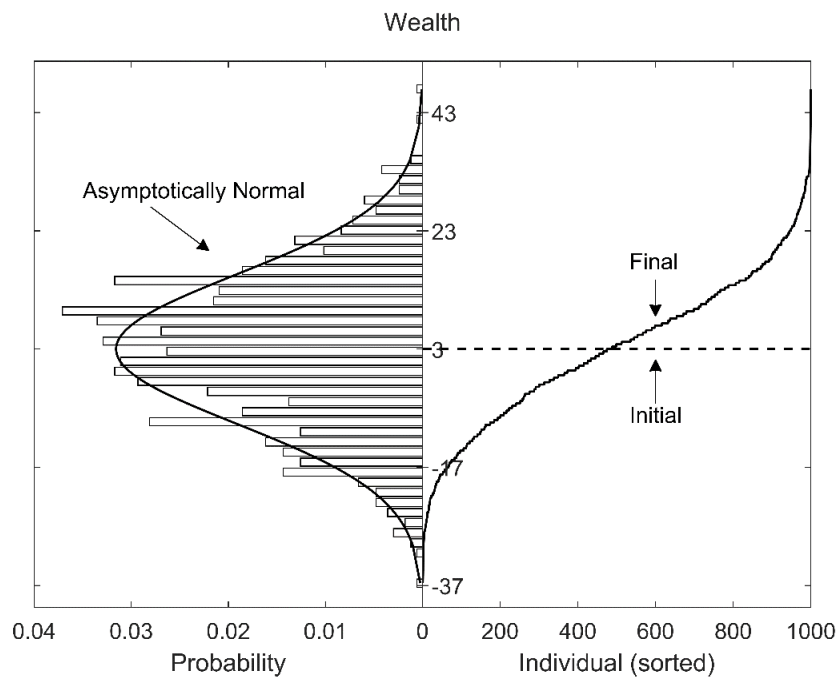

Notes: The right panel shows the initial (dash) and the final (solid) wealth sorted by individuals, and the left panel shows the corresponding final wealth distribution.

This so-called Boltzmann-like feature of wealth distribution (excluding the upper tail which follows a power law) is well documented in the econophysics literature (Brzezinski, 2014; Goswami & Sen, 2014; Yakovenko & Rosser, 2009). In fact, an analytical proof of this counter-intuitive conclusion can be provided by applying the Central Limit Theorem:

Denote the wealth of an individual at the end of period t as w_t . In period 0, everyone has the same initial endowment w_0 . In period $t > 0$, wealth has a deterministic component $w_0 - t$ and a stochastic component $\sum_{j=1}^t \sum_{i=1}^N \epsilon_{ij}$, which is the sum of all idiosyncratic income shocks (ϵ_{ij}) she receives in each round ($i = 1, \dots, N$) of all previous periods ($j = 1, \dots, t$).

⁴ For simplicity, negative wealth is allowed, so those with zero wealth need to borrow to pay the tribute.

The income shock ϵ_{ij} follows an independent and identical Bernoulli distribution with a probability of $\frac{1}{N}$ to receive 1 and a probability of $\frac{N-1}{N}$ to receive 0. Using the moment properties of Bernoulli distribution, we have $\mathbf{E}[\epsilon_{ij}] = \frac{1}{N}$ and $\mathbf{V}[\epsilon_{ij}] = \frac{N-1}{N^2}$. Therefore, the wealth at the end of period T is:

$$w_T = (w_0 - T) + \sum_{j=1}^T \sum_{i=1}^N \epsilon_{ij} = (w_0 - T) + TN \frac{\sum_{k=1}^{TN} \epsilon_k}{TN}.$$

Using the Central Limit Theorem, we have $\frac{\sum_{k=1}^{TN} \epsilon_k}{TN} \xrightarrow{d} N\left(\frac{1}{N}, \frac{1}{TN} \frac{N-1}{N^2}\right)$.

Applying a linear transformation to this normal distribution leads to the asymptotic wealth distribution: $w_T \xrightarrow{d} N\left(w_0, \frac{N-1}{N} T\right)$. ■

It is somewhat astounding that inequality exists even if there is absolute equality in the initial endowment and interim opportunity. Given that all distributional arrangements are fair, the resulting “inequality of outcome” is also fair according to the Responsibility-Sensitive Theory of Justice (Almas *et al.*, 2011; Arneson, 1989). If you are more or less convinced by this simple thought experiment that there is a “natural rate of inequality”, then this approach surely has a potential to answer other *causality-type* of questions related to inequality and mobility, where empirical data are limited.

In economics, most theoretical models are developed in the neoclassical tradition and most empirical models are assessed by econometric regressions, ignoring that there may well be other conceptual tools at hand (Schabas, 2008). We have learned many things from physics, such as comparative statics, statistical modelling, and even controlled experiment. However, thought experiments (e.g., “chasing a beam of light” in Einstein’s theory of relativity and “Schrodinger’s cat” in quantum mechanics) seem less appealing to contemporary economics. Economists are usually optimistic about finding a succinct but comprehensive story (the model) to match the reality (the data or stylized facts). There are good reasons for this Positivistic stance, but the original purposes of many economic studies may not be so ambitious. We may just want to answer simple causality questions such as “whether X (e.g., growth) affects Y (e.g., inequality) *ceteris paribus*”, so sometimes *deductive* rather than *inductive* reasoning is enough to serve the purpose. In this case, data-fitting econometric models are a sledgehammer to crack a nut—yet they still often fail thanks to omitted variables, measurement errors and model misspecifications that stand between the model and the data. If we can, for now, downplay the ambition of data-fitting induction and divert the purpose to question-answering deduction, it will open the door for new methodological possibilities.

Thought experiment is one such. In fact, suppositional reasoning with the help of thought experiments has been widely used in philosophy (e.g., “the pleasure machine” by Robert Nozick), political science (e.g., “the veil of ignorance” by John Rawls) and early economists (e.g., “the

five pounds miracle” by David Hume). Like controlled experiments in behavioral economics, carefully designed thought experiments can avoid complications in the data, so we can focus on the key causality. Nowadays, deductive reasoning in thought experiments can be harnessed by computational simulations—the ABMs as in Charness & Genicot (2009), Geanakoplos *et al.* (2012) and Chattopadhyay *et al.* (2017). The essence of ABMs is to build a bottom-up model based on individual-level microdata evidence. The agents’ behavior is dependent on each other’s and the local environment, making it a *complex* system with sophisticated interactions, dynamics, non-linearities and heterogeneities (Gallegati & Kirman, 2012). Macroscopic patterns “emerge” out of the interactions and dynamics at the microscopic level. In other words, the aggregate is not equal to the sum—a fundamental divergence from the representative agent paradigm where interactions are basically assumed away. However, an observed macroscopic measure of the system (e.g., Gini coefficient or Shorrocks index) can correspond to a myriad of possible microscopic states (e.g., different decision rules and interaction rules of the agents). The level of our ignorance on the microstates for a given macrostate is usually measured by Shannon information entropy. In practice, we can pin down most of the model uncertainties by calibrations using microeconomic evidence. This is a more realistic “micro-foundation” than the theoretical micro-foundation (i.e., optimization of representative agents) adopted in New Classical and New Keynesian models. Any left-over uncertainties in the microstates of the model can then be estimated by minimizing the gap between the observed and the simulated macrostates.

Meanwhile, we should be warned of the limitations of thought experiments. On the one hand, compared to *data-fitting econometric models*, simple controlled thought experiments cannot paint a complete picture of the world, but only of a specific corner. In other words, causalities can only be theoretically, not empirically, identified. In this regard, we believe that concluding something is better than concluding nothing, but we admit that thought experiment is an alternative method to data-fitting modelling. On the other hand, compared to *neoclassical theoretical models*, our thought experiments do not impose rationality on individual behavior and equilibrium on aggregate behavior. In contrast to general equilibrium models in this tradition (e.g., CGE and DSGE) which assume an incredibly simple environment but unrealistically sophisticated agent, ABMs assume very simple agent but an extremely complex environment (Hamill & Gilbert, 2016). Nevertheless, a greater realism is a double-bladed sword—absence of the neoclassical ideology may imply a lack of theoretical convergence to equilibrium. The decision in modelling strategy really depends on the trade-off between theoretical elegance and practical relevance in answering the research question. Given the essential role of heterogeneity and interaction in explaining inequality and mobility, we believe that thought experiment can strike a good balance between the two desirable criteria.

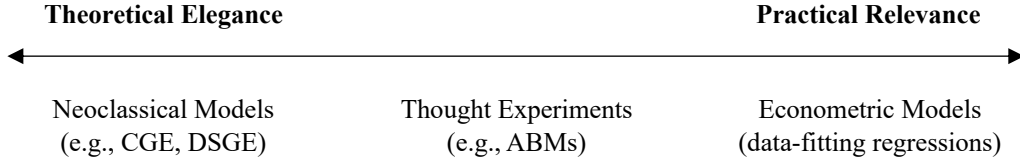

3 Literature Review

Wealth inequality is a feature of the distribution across individuals at a point in time, while social mobility characterizes the transitions across the distribution over time. Given the entangled relationship between the two concepts, there has been a growing literature attempting to explain both within one framework (Benhabib *et al.*, 2019; Fisher *et al.*, 2016; De Nardi, 2004). This section reviews the relevant literature to inform the configurations of the thought experiments in the next section.

Equation [1] describes the law of motion of an individual’s wealth. Note that the term “income” is sometimes interchangeably used with “earnings” in the literature. We follow the convention of the Bureau of Labor Statistics in distinguishing between non-wealth-derived income or earnings (y_t , e.g., wage and salary) and wealth-derived income ($r_{t+1}w_t$). According to this identity, the change in wealth depends on: (i) residual earnings, (ii) returns on wealth (r_{t+1}), and (iii) income shocks or idiosyncratic shocks (ϵ_t). Therefore, we will summarize the factors that affect wealth inequality and social mobility along the three dimensions.

$$w_{t+1} - w_t = \underbrace{[(1 - \tau)y_t + T_t - c_t]}_{\text{residual earnings}} + \underbrace{r_{t+1}w_t}_{\text{returns}} + \epsilon_t \quad [1]$$

where w_{t+1} and w_t are wealth stocks in periods $t + 1$ and t ; τ is the income tax rate on earnings y_t ; T_t is the transfer payment; c_t is consumption; r_{t+1} is the rate of return on wealth.

3.1 Literature on Wealth Inequality

At the outset of the literature since Pareto (1897), it is naturally assumed that a skewed earnings distribution⁵ would map into a skewed wealth distribution. Therefore, economic research in wealth inequality starts with earnings inequality and the underlying distribution of talents across individuals (Edgeworth, 1917). In the same vein, dispersion of education and human capital endowment are argued to cause inequality of earnings and wealth (Björklund, *et al.*, 2017; De Gregorio & Lee, 2002; Caselli & Ventura, 2000). Apart from earnings y_t per se, equation [1] suggests that redistribution tax (τ) plays a significant role in shaping the distribution: inequality in the US started to fall during 1930s and 1940s when the income tax rate (the

⁵ Some would call it “income distribution”, but we call it earnings distribution to emphasize that it refers to the non-wealth-derived income.

highest rate was 90%) and bequest tax rate (70%) were extremely high (Saez & Zucman, 2016). Similarly, inequality in the UK rose during the Thatcher era in the 1980s when the income tax on the rich was slashed and labor unions were repressed (Alvaredo *et al.*, 2018). Moreover, consumption behavior (c_t) matters in determining the residual earnings in equation [1] via heterogeneous marginal propensities to consume and savings rate (Garbinti *et al.*, 2021; Carroll *et al.*, 2017; Atkinson, 1971). Other identified individual-level factors influencing earnings inequality include parental ability (Galor & Tsiddon, 1997), parental bequests (Bhattacharya, 1998) and credit constraints (Papadopoulos, 2019; Galor & Moav, 2000). At the aggregate level, Kuznets (1955) proposes the famous Kuznets curve—earnings inequality is a concave function of *economic growth*—which is empirically accepted as a stylized fact (Castelló-Climen, 2010; Banerjee & Duflo, 2003; Laitner, 2001; Forbes, 2000; Perotti, 1996). Nevertheless, Rodríguez *et al.* (2002) argue that distributions of wealth and earnings do not always have the same dynamic trend. The upper tail of wealth distribution is usually thicker than that of earnings distribution, so earnings inequality per se is not enough to explain wealth inequality. Caiani *et al.* (2016, 2019) develop an ABM with financial markets and Dosi *et al.* (2020) pioneer in building an ABM with a labor market.

The second source of wealth inequality is returns to wealth (r_{t+1}). Skewed wealth distributions can be easily obtained under the assumption of “explosive wealth accumulation”, which can result from voluntary bequests (Cagetti & De Nardi, 2008) or an increasing return to wealth (Fagereng *et al.*, 2016). For example, an increasing return to wealth can be derived from indivisibility of investment (Bhattacharya, 1998) or credit rationing (Barro, 2000; Aghion & Bolton, 1997). However, under this assumption, the wealth distribution is non-stationary with mean and variance increasing and exploding in time (Benhabib & Bisin, 2018). In other words, it means the rich get richer and the poor get poorer—a notorious characteristic of capitalism in its crude form. To obtain convergence in the distribution, births, and deaths (Reed, 2001; Blanchard, 1985; Wold & Whittle, 1957), fiscal policies (Alesina & Rodrik, 1994), monetary policies (Adam & Zhu, 2016) or other mechanisms are needed.

Finally, idiosyncratic shocks (ϵ_t) are recognized as an important cause of wealth inequality (Algan *et al.*, 2008; Aiyagari, 1994; Shorrocks, 1975), so the outcome of the quiz in Section 2 should not be a surprise to those familiar with early literature such as Champernowne (1953). We can treat stochastic components of earnings and returns as part of ϵ_t . Kesten (1973) proves that a stochastic rate of return to wealth can generate a thick-tailed distribution even if the distribution of earnings is not thick-tailed. More recent studies in this spirit include Nirei & Souma (2007) without microfoundations and Benhabib *et al.* (2015, 2016) with microfoundations.

3.2 Literature on Social Mobility

The literature on mobility originates in sociology research, which focuses on the role of an individual's forebears in determining her socioeconomic status, viz. inter-generational social mobility (Blau & Duncan, 1967). Human capital is again identified as a key factor of social mobility via family's optimal decision on education (Arenas & Hindriks, 2021; Loury, 1981; Becker & Tomes, 1979). Following this idea, more theoretical foundations for the effect of human capital were established, such as credit markets' imperfections and indivisibilities in human capital investment (Galor & Zeira, 1993). Other factors identified in the theoretical literature include time preferences or the "Spirit of Capitalism" (Doepke & Zilibotti, 2005), equal opportunity policy (Corak, 2013; Conlisk, 1974), voluntary bequests (De Nardi, 2004) and the spillover effect of neighborhoods (Durlauf, 1994). A Markov process is usually adopted to model the transition probabilities (Beshers & Laumann, 1967) and the most famous measure of mobility is the Shorrocks index (Shorrocks, 1978).

In the empirical literature, some focus on occupation changes of offspring generations (Long & Ferrie, 2018, 2013; Erikson & Goldthorpe, 2002), while others are interested in income class changes (Kearney & Levine, 2014; Andrews & Leigh, 2009; Mazumder, 2005; Björklund & Jäntti, 1997; Solon, 1992). At the aggregate level, Featherman *et al.* (1975) and Galor & Tsiddon (1997) find that economic development improves social mobility, but if the economy is already highly developed, this effect will be dampened. It is also well recognized that inequality and mobility tend to be negatively correlated in data—greater wealth inequality is associated with lower social mobility—the so-called Great Gatsby curve introduced by Alan Krueger in 2012 (Corak, 2013). The most popular empirical strategy is to use data-fitting statistical models, including both reduced-form (Solon, 1992) and structural-form regressions (Lefgren *et al.*, 2012).

We summarize the key factors underlying wealth inequality and social mobility:

- | | |
|--------------------------|--|
| Earnings-related factors | <ul style="list-style-type: none">• individual level factor: human capital• aggregate level factor: economic growth• institutional factors: income tax, transfer payment |
| Returns-related factors | <ul style="list-style-type: none">• explosive wealth accumulation• increasing returns: physical capital |
| Shocks-related factors | <ul style="list-style-type: none">• stochastic earnings• stochastic returns |

4 Thought Experiments

Based on the literature review, we design five simple thought experiments to evaluate the contributions of the identified factors to wealth inequality and social mobility.

Baseline Model. We extend the quiz model by including production and consumption to form the baseline experiment. Assume that there are $Y = 1000$ units of outputs produced in every period and each resident (endowed with the same initial wealth $w_0 = 3$) has a Keynesian consumption function:

$$c_t = \bar{c} + \alpha \times y_t \quad [2]$$

where $\bar{c} = 0.4$ is the subsistence level of consumption, $\alpha = 0.6$ is the marginal propensity to consume, and y_t is the total earnings distributed to the agent. Those whose wealth falls below \bar{c} in the beginning of each period will get \bar{c} from the government, but they still have an equal chance to be distributed with new earnings. This lower bound of wealth (\bar{c}) results in a context-specific decision rule, so an analytical proof is no longer possible. This makes simulation necessary to identify the emerging patterns. The baseline model focuses on the role of stochastic income shocks in forming wealth inequality and social mobility.

Tax Model. Building on the baseline experiment, we add a tax system with a simplified progressive income tax (τ) and the transfer payment (T_t). Each resident beyond a certain tax allowance depending on the national income level (proportionately calibrated using the tax bands in the UK) is taxed at a rate of 20% (the basic rate in many European countries such as Ireland and the UK).⁶ The tax revenue is then equally redistributed to everyone to simulate the use of taxes as transfer payments and public goods/services. This design is to see the effect of redistribution policy (Fernholz & Fernholz, 2014).

Growth Model. Still building on the baseline experiment, we now allow for sustained economic growth in output (Y) with an annual rate of 8% (the growth rate in China). This experiment is to see the effect of the aggregate-level factor (exogenous economic growth).

Human Capital Model. Then, we add labor-related endowment or human capital to the baseline experiment. Residents are still endowed with the same initial wealth, but with different diligence and intelligence. Following the examples in Benhabib & Bisin (2018), we assume that the (demeaned) human capital endowment h follows a normal distribution, which determines the probability of obtaining the earnings in the form of a logit function [3].

⁶ The existence of tax exemption makes the income tax in our model essentially a progressive tax. Note that it's an integrated income tax taking into account both personal income and corporate income.

$$\Pr(\epsilon_{it} = 1) = \frac{\exp(\beta_0 + \beta_1 \times h)}{1 + \exp(\beta_0 + \beta_1 \times h)}, \text{ where } h \sim N(0, \sigma_h^2) \quad [3]$$

In the logit function, β_0 is equal to $\ln\left(\frac{1}{N-1}\right)$ such that it becomes the baseline case when everyone has zero human capital ($h = 0$), and β_1 is the return on human capital. The dispersion of the wealth distribution depends on the dispersion of human capital σ_h (set as 10%).

Figure 3 Lorenz Curves of Thought Experiments

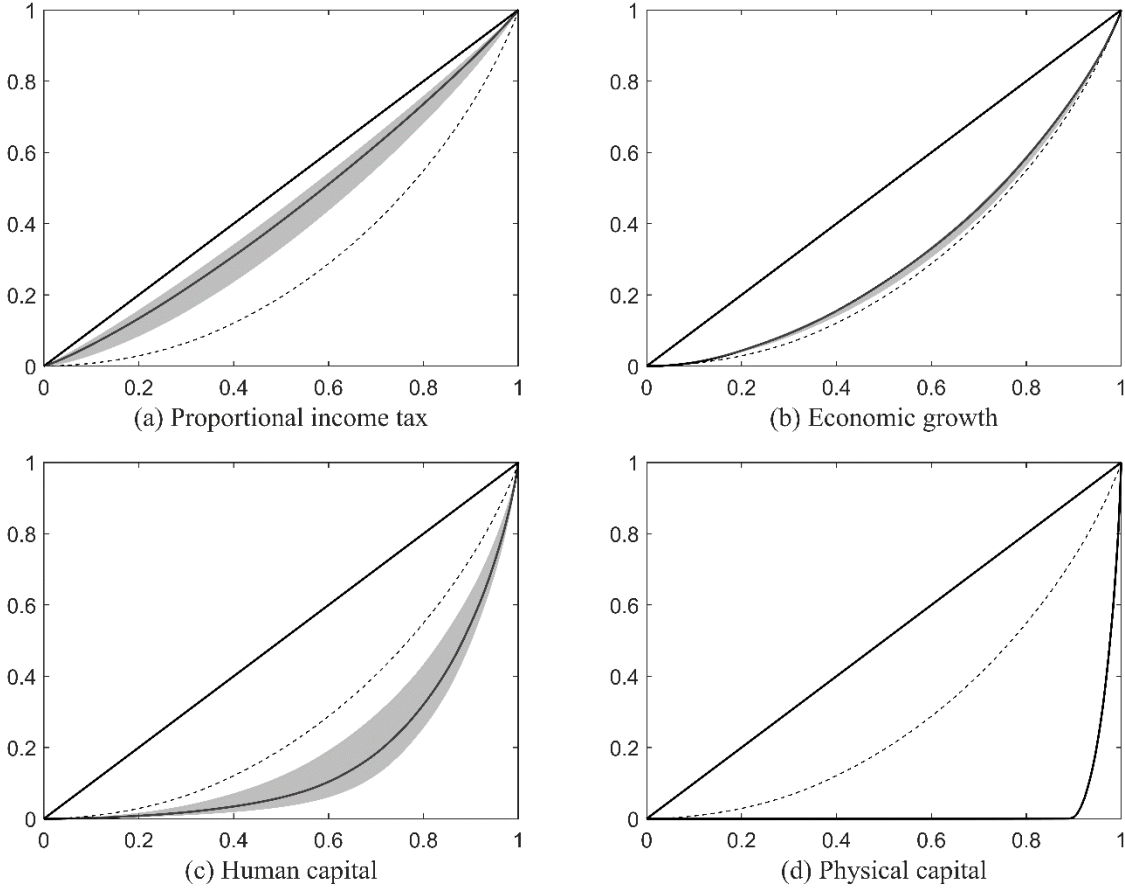

Notes: The dash curves are the baseline experiment. The solid curves are the experiments. The bands are based on $\pm 50\%$ variation of the key parameters: (a) tax rate, (b) growth rate, and (c) return to human capital.

Physical Capital Model. Lastly, we add investment to the baseline experiment to see the effect of physical capital. An additional assumption is added that, after consumption, an agent can invest the rest of her wealth in the capital market for return in the next period. To emulate reality (e.g., stock market investment), the proportion of her capital/wealth in the capital market determines the probability of obtaining new income. This configuration captures the important features of ABM—interactions among heterogeneous agents—since everyone’s return depends on every else’s investment which differs across agents. Moreover, the existence of subsistence consumption (\bar{c}) implies that the poorest people have zero returns due to zero investments. This

feature chimes with the abovementioned literature on increasing returns on wealth because rich people have greater opportunities to invest and benefit from the credit market. This thought experiment is to demonstrate the effect of physical capital on inequality and mobility.

4.1 Factors of Wealth Inequality

Figure 3 shows the Lorenz curves of the thought experiments in contrast to the baseline experiment. As predicted, income tax reduces inequality in line with the findings of Slack (2015) and Alvaredo *et al.* (2017). Our finding on economic growth is consistent with Piketty & Saez (2014)—when economic growth slows down, inequality tends to rise. By contrast, skewed distributions in human capital and physical capital tend to aggravate wealth inequality in line with Lee & Seshadri (2018). The effect of the latter is especially big. In fact, the distribution of wealth is not stationary under the assumption of differentiated returns (the physical capital model) and the inequality is getting more extreme as time elapses (Benhabib *et al.*, 2018). Without further assumptions about demographic structure, this model is not suitable for empirical purpose (Reed, 2001), so the implication for the causality between physical capital and inequality remains qualitative.

We quantify the effects of various factors on wealth inequality using the two most popular measures in Table 1. The qualitative conclusions summarized above are confirmed by both Gini coefficients and top wealth shares.

Table 1 Wealth Inequality and Social Mobility

	Wealth Inequality		Social Mobility		
	Gini	Top 10%	Upward	Downward	SI
Baseline	0.428	26.7%	6.4%	25.0%	0.955
Tax	0.132	14.0%	3.6%	16.0%	0.831
Growth	0.376	24.3%	10.4%	53.0%	0.994
Human Capital	0.657	45.2%	0.0%	0.0%	0.746
Physical Capital	0.940	99.5%	0.0%	0.0%	0.516

Notes: “Upward” columns indicate transition probabilities of a medium-wealth individual at her 30s (300th period) moving to the top 10% at the end of her life (1000th period). “Downward” columns indicate transition probabilities of a top 10% individual at her 30s moving to the bottom 50% at the end of her life.

4.2 Factors of Social Mobility

Turning to social mobility, we begin with a narrative story to intuitively quantify the upward mobility—the probability of climbing into the top 10% richest group by the end of her life for a 30-year-old person ranked at the 50th percentile (the median). It is worth pointing out that it can be interpreted as a measure of intra-generational mobility rather than that of inter-generational mobility as in most empirical literature. Alternatively, we can of course add in an overlapping generation structure and interpret each period as a generation to measure the inter-

generational mobility. But we adopt the former interpretation here, seeing that intra-generational mobility is rarely discussed in the literature. Also, this is a more pertinent question to most people in reality—what is the chance of ascending “from rags to riches” like Mr Jay Gatsby? In fact, the original storyline of *The Great Gatsby* is about the transition *within* one’s life rather than *across* generations.

As shown in the Upward and Downward columns of Table 1, economic growth can significantly increase this hope—if you are a mediocre when you are 30 years old, you still have a 10.4% chance to squeeze into the richest 10%, higher than the chance in the baseline experiment without economic growth. At the same time, the richest 10% also have a 53% chance to end up dropping into the middle or even lower class on death, i.e., a greater downward mobility compared to the baseline. This suggests that the social mobility in both directions is greatly boosted by a dynamic economy in a “creative destruction” fashion. By contrast, in an economy with physical capital without any other mitigating measures, social classes are completely frozen. Surprisingly, redistribution tax hampers this transition because the poor and the middle classes are losers in taxation and their chances of ascendance are actually reduced. This finding is conformable with a vast literature on the median voter’s tax policy preferences (Alesina *et al.*, 2018; Benabou & Ok, 2001; Piketty, 1995). A more systematic measure of social mobility is the Shorrocks Index (SI) proposed by Shorrocks (1978):

$$SI = \frac{\text{rank}(M) - \text{trace}(M)}{\text{rank}(M) - 1} \in [0,1], \text{ where } M \text{ is the transition matrix.} \quad [4]$$

Each cell of the transition matrix M describes the chance of shifting from a row social class in the 300th period to a column social class in the 1000th period. The trace of M therefore measures the overall probabilities of staying in the same social class. Therefore, as SI approaches to 1, mobility becomes higher. If we divide agents into five social classes with each accounting for 20% of the population, then the transition matrix is 5×5 .

We show the transition matrix of the baseline model in Table 2, which leads to an SI of 0.955. It is also interesting to see that the bottom and top classes tend to have a greater rigidity than the middle class. The transition matrices for other thought experiments can be found in Appendix 2 and the implied SIs are reported in the last column of Table 1. The findings of the narrative are confirmed by this more systematic measure of mobility—economic growth improves social mobility, while the other factors (including redistribution tax) reduce it. At the first glance, it appears counterintuitive that a progressive income tax reduces the SI from 0.955 to 0.831. This is because, despite that the tax can redistribute some wealth from the rich, the additional tax burden also increases the chance for the poorest of being stuck in the “poverty trap” as well as the chance for the middle class to be stuck in the “middle income trap”. The

bottom and lower class suffer greater loss in social mobility compared to the rest (see Appendix 2). This conclusion is in line with the 30-year-old transition story above. The most significant effect comes from capital, which almost halves the SI down to 0.516.

Table 2 Transition Matrix of the Baseline Model

Final Period \ Initial Period	Bottom 20%	Lower 20%	Middle 20%	Upper 20%	Top 20%
Bottom 20%	24.5%	19.0%	24.0%	17.5%	15.0%
Lower 20%	19.0%	24.0%	21.5%	21.5%	14.0%
Middle 20%	20.5%	21.5%	20.5%	17.5%	20.0%
Upper 20%	21.0%	25.0%	20.0%	16.0%	18.0%
Top 20%	15.0%	10.5%	14.0%	27.5%	33.0%

5 An Empirical Hybrid ABM

Based on the thought experiments in the previous section, we conclude that capital (human or physical) exacerbates wealth inequality, while tax and growth alleviate it. At the same time, growth improves social mobility, while tax and capital hamper transitions among classes. If our aim is only to answer the simple causality questions such as “whether X leads to higher wealth inequality and social immobility?”, our job is already accomplished. Nevertheless, we would like to push our method a bit further to achieve an empirical ambition—to see how well ABMs can match the real data. The motivation of doing so is that, based on the estimated ABM, we can then generate otherwise unobservable data such as the upper end of the wealth distribution and the transition matrix among different social classes. A richer set of implications and counterfactuals then become possible (Papadopoulos, 2019).

5.1 Specification, Calibration and Estimation

We combine all previous experiments to construct a hybrid ABM with sufficient realism to match the empirical data. The timing of the actions and interactions among agents with heterogeneous conditions are configured as follows:

Step 1: Distribution. The output is distributed to agents in two hierarchical steps.

- **Step 1A:** The output is first split into labor income and capital income according to income shares of labor (γ) and capital ($1 - \gamma$) in each country.
- **Step 1B:** Each agent gets her labor income according to her position in the distribution of human capital and gets her capital income according to her position in the distribution of capital ownership.

Step 2: Taxation. A progressive income tax is collected based on the taxable income of each agent.

Step 3: Redistribution. Each agent with $w_{t-1} < \bar{c}$ receives social benefit \bar{c} from the government, which finances this transfer payment by the income tax.

Step 4: Public Expenditure. The government uses the rest of the collected income tax to produce public goods and services, which are equally shared by all agents.

Step 5: Private Expenditure. Each agent follows a Keynesian consumption function as described in [2].

Step 6: Investment. The net wealth at the end of period t is invested in the capital market, which will affect the distribution of capital ownership in period $t + 1$.

Most parameters in this hybrid model are listed in Table 3 with their calibrated values for G7+C in 2016. g is the annual growth rate of GDP per capita. Human capital return (β) is calibrated by the return to another year of schooling based on Montenegro & Patrinos (2014). Tax allowance (\bar{y}) is the personal income tax exemption level relative to GDP per capita issued by national authority in each country.⁷ Income tax rate is computed as a proportion of average taxable income per capita.⁸ Subsistence consumption \bar{c} is the poverty line over GDP per capita and marginal propensity to consumption α is backed out from the consumption equation. The income shares of labor (γ) and capital ($1 - \gamma$) are based on geographical economic data documented by St. Louis Fed in 2016. The interpretation of ‘agent’ differs across countries due to different sizes of population, which is also identified as an important contributor to inequality (Alesina & Spolaore, 2003; Deltas, 2003; Bolton & Roland, 1997). Each agent (out of 1000) in our model represents a group of individuals that is equal to the total population divided by 1000. For example, for the US, each agent contains 323,000 individuals (323 million population as in 2016 divided by 1000), while for China, each agent stands for 1,379,000 individuals (1.379 billion population as in 2016 divided by 1000). In principle, ABMs can capture any degree of heterogeneity, but we use the same number of agents here to keep things simple and comparable. A detailed description of data sources is in Appendix 1.

⁷ The tax exemption level in each country is transformed into US dollars by the average annual foreign exchange rate in 2016.

⁸ Take Japan as an example. Given GDP per capita and the tax-free income, the taxable income per capita in 2016 is 3.2 million JPY. According to the cumulative tax figure in Japan, this average taxable income should be 0.397 million and thus the average rate of proportional taxable income is 0.397 million over 3.2 million.

Table 3 Calibrated Parameters

Parameter	Canada	China	France	Germany	Italy	Japan	UK	US
Annual growth rate g	0.003	0.061	0.008	0.01	0.011	0.011	0.011	0.008
Human capital return β	0.121	0.166	0.090	0.145	0.071	0.120	0.119	0.138
Tax allowance \bar{y}	0.27	0.78	0.29	0.23	0.29	0.24	0.37	0.18
Income tax rate τ	0.15	0.10	0.18	0.15	0.24	0.12	0.17	0.16
Subsistence consumption \bar{c}	0.385	0.193	0.334	0.299	0.334	0.289	0.305	0.300
Consumption propensity α	0.251	0.438	0.229	0.252	0.280	0.341	0.427	0.451
Labor share of income γ	0.661	0.586	0.620	0.630	0.516	0.566	0.586	0.594
Size of each agent (1000s)	35	1379	67	82	61	127	66	323

One of the key parameters, the standard deviation of (log) human capital σ_h , is unobservable. This parameter measures the dispersion of human capital, such as talents, schooling, and training. In a more complicated model, we can endogenize it as a decision made by agents, but individual changes in the distribution do not change the shape of the distribution. It is therefore a secondary issue whether to treat human capital as a “fixed effect” or as an endogenous variable. We estimate this parameter by minimizing the sum of squared errors between model-simulated and observed measures of inequality (Gini coefficients and top wealth shares) for each country. Table 4 shows the estimated σ_h . Unfortunately, there is no direct counterpart of σ_h in data. The closest proxy we can find is inequality in education by United Nations Human Development Report (the “Data” Column of Table 4). The estimated σ_h and the observed inequality in education have a positive correlation coefficient of 62.4%, suggesting an empirical consistency. To show the robustness, estimates under different numbers of periods and agents are also reported. We do notice a small scale effect for different numbers of agents, but the results do not vary qualitatively. Hence, we use 1000 periods and 1000 agents.

Table 4 Estimated Parameter (σ_h)

	Data	Estimate (St. Err.)	Different Agents		Different Periods	
No. of Agents		1000	500	5000	1000	1000
No. of Periods		1000	1000	1000	5000	10000
Canada	2.7	6.86 (0.011)	6.73	6.96	6.68	6.65
China	11.7	8.15 (0.016)	7.99	8.50	8.24	8.19
France	9.5	10.54 (0.015)	10.37	10.69	10.49	10.53
Germany	2.3	7.89 (0.013)	7.75	8.09	7.84	7.89
Italy	10.6	13.34 (0.019)	13.00	13.43	13.23	13.32
Japan	4.7	5.62 (0.007)	5.53	5.61	5.66	5.58
UK	2.7	6.87 (0.010)	6.81	7.01	6.90	6.89
US	2.8	8.90 (0.020)	8.75	9.27	8.85	8.86

Notes: The “Data” column lists the inequality in education (Atkinson inequality) by United Nations Human Development Report in 2020. Monte Carlo simulation-based standard errors are reported in the parentheses. See section 5.2 for details.

Figure 4 shows how well our estimated model can fit the data of the eight major economies (G7+C), both qualitatively (ranking) and quantitatively (with a mean root squared error of 0.07%, measured by the length of line segments between the actual and simulated values). Since most of the parameters are calibrated based on actual data and only one parameter (σ_h) is estimated, the hybrid ABM has shown an impressive empirical performance in a cross-section of countries. The Monte Carlo simulation described in section 5.2 formally tests the estimated ABM and offers simulation-based standard errors of $\hat{\sigma}_h$ reported in Table 4. A more sophisticated model can consider endogenizing human capital, time allocation and overlapping generations into our prototype ABM for other research topics. These additions are straightforward—simply specify more rules of actions and interactions and then let simulation takes over. Two examples of such extensions are demonstrated in section 6.

Figure 4 Simulated and Observed Wealth Inequality

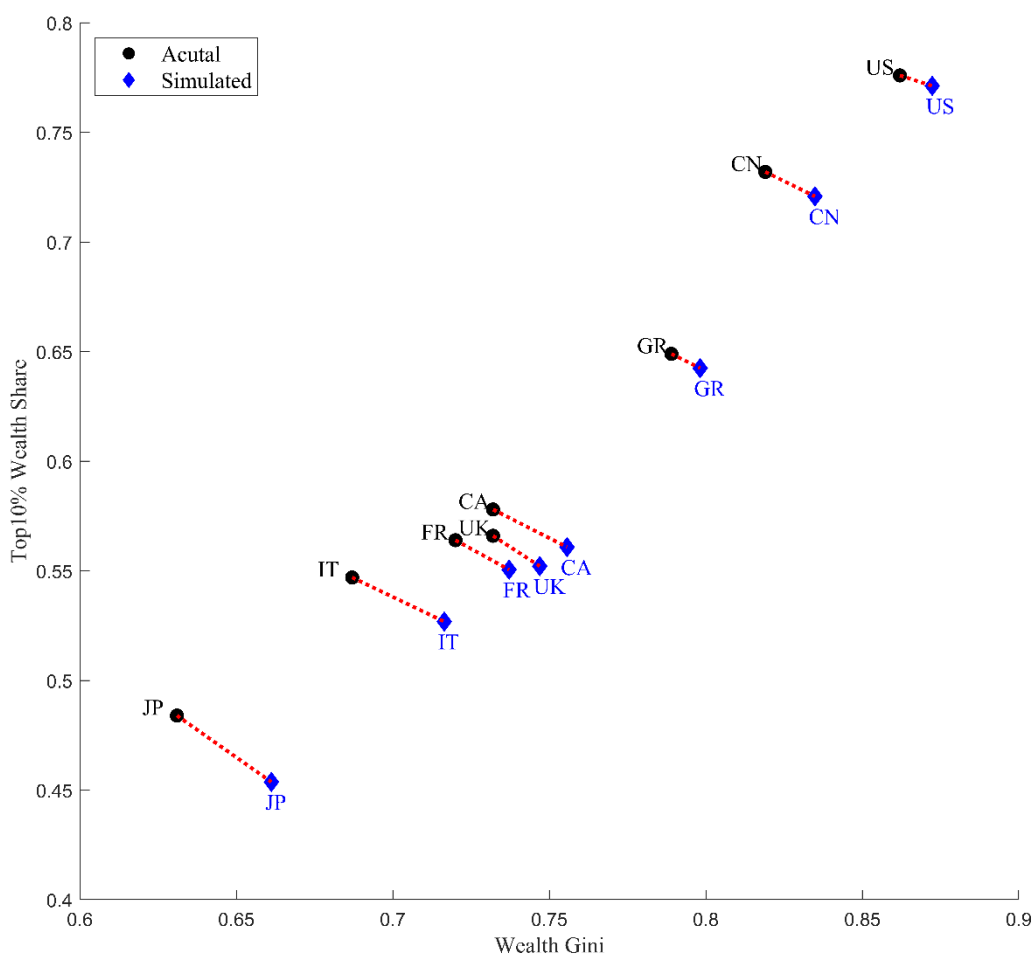

5.2 Monte Carlo Simulation

In the hybrid model, the standard deviation of human capital (σ_h) is the key parameter but unobservable in empirical data. The estimates in Table 4 are *point* estimates to minimize the squared distance between the model predictions and data observations of Gini coefficients and

top 10% wealth shares. In empirical studies, it is common practice to report standard errors of estimated parameters to shed light on the significance and robustness of the estimates. Moreover, standard errors can also be used to test various hypotheses based on the model. One fundamental hypothesis as such is the test of the model per se—how likely is the ABM a true data generation process of the observed data?

To do so, we propose a Monte Carlo simulation procedure to test the null hypothesis and to estimate standard errors of the key structural parameter σ_h . Note that the null hypothesis (H_0 : The ABM is a true data generating process.) is what we expect to be true, so a larger P-value of H_0 is favored. This is unlike F tests in regressions, where a smaller P-value is favored because the null hypothesis (insignificant model) is what we expect to reject.

To be general, the structural parameter vector is denoted as $\boldsymbol{\theta}$, which includes calibrated (Table 3) and estimated (Table 4) parameters. For different realizations of the underlying random processes, the ABM can generate different endogenous variables (\mathbf{y}), a subset of which is observable such as Gini coefficients and top 10% wealth shares (\mathbf{y}^*). The Monte Carlo procedure aims to evaluate, under the null hypothesis H_0 , the probability of the estimated ABM generating the observed data. The procedure is summarized in Figure 5:

0. **Estimation.** The key parameter $\hat{\sigma}_h$ is estimated by the observed data \mathbf{y}^* as described in subsection 5.1.
1. **Simulation.** Simulate $N_s = 1000$ random draws of human capital distributions based on the estimate $\hat{\sigma}_h$.
2. **Generation.** Each realization of the N_s simulations is fed into the ABM, which generates a set of $\mathbf{y}^{(s)}$.
3. **Comparison.** Compare the observed value \mathbf{y}^* with the simulated distribution of $\mathbf{y}^{(s)}$. If the observed value \mathbf{y}^* lies within the critical values (of a two-tail test), then H_0 cannot be rejected (or in other words, the ABM is true).
4. **Re-estimation.** If the model is true, then take each realization $\mathbf{y}^{(s)}$ as a true data and re-estimate the key parameter σ_h . Then we have N_s estimates $\hat{\sigma}_h^{(s)}$, which can be used to obtain the standard errors of $\hat{\sigma}_h$.

We plot the distributions of simulated Gini coefficients of the US and China in Figure 6. The simulated Gini coefficients follow beta distributions since the domain is restricted between 0 and 1. It is shown that the observed Gini coefficients fall within the 95% confidence intervals. In other words, the null hypothesis H_0 cannot be rejected and the estimated ABM is likely to

generate the observed data. The P-values of the ABM being true are 57.3% for the US and 82.7% for China, respectively.

Figure 5 The Flowchart of Monte Carlo Procedures

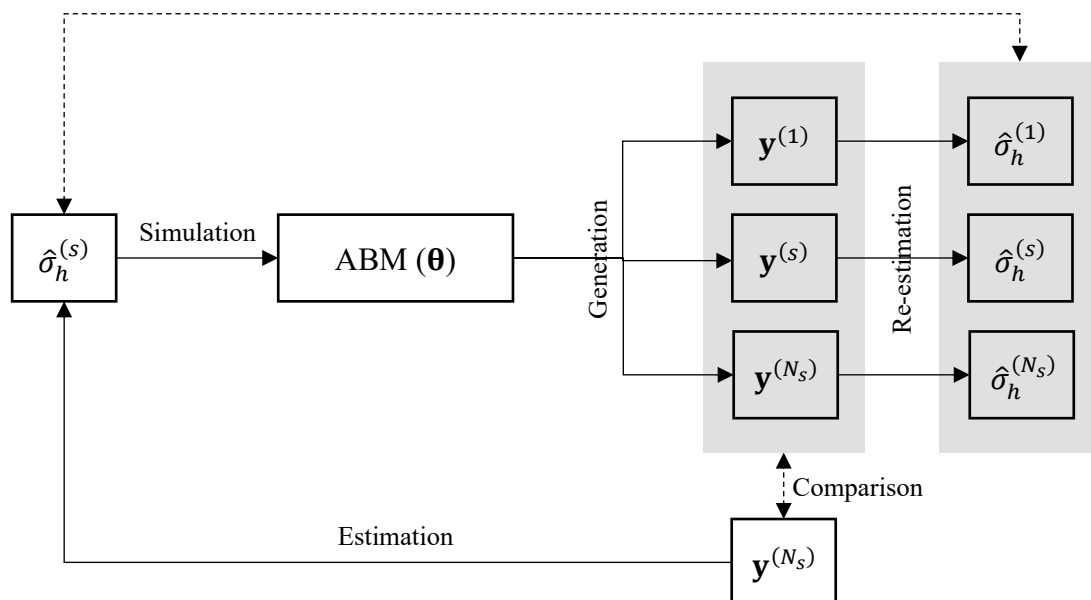
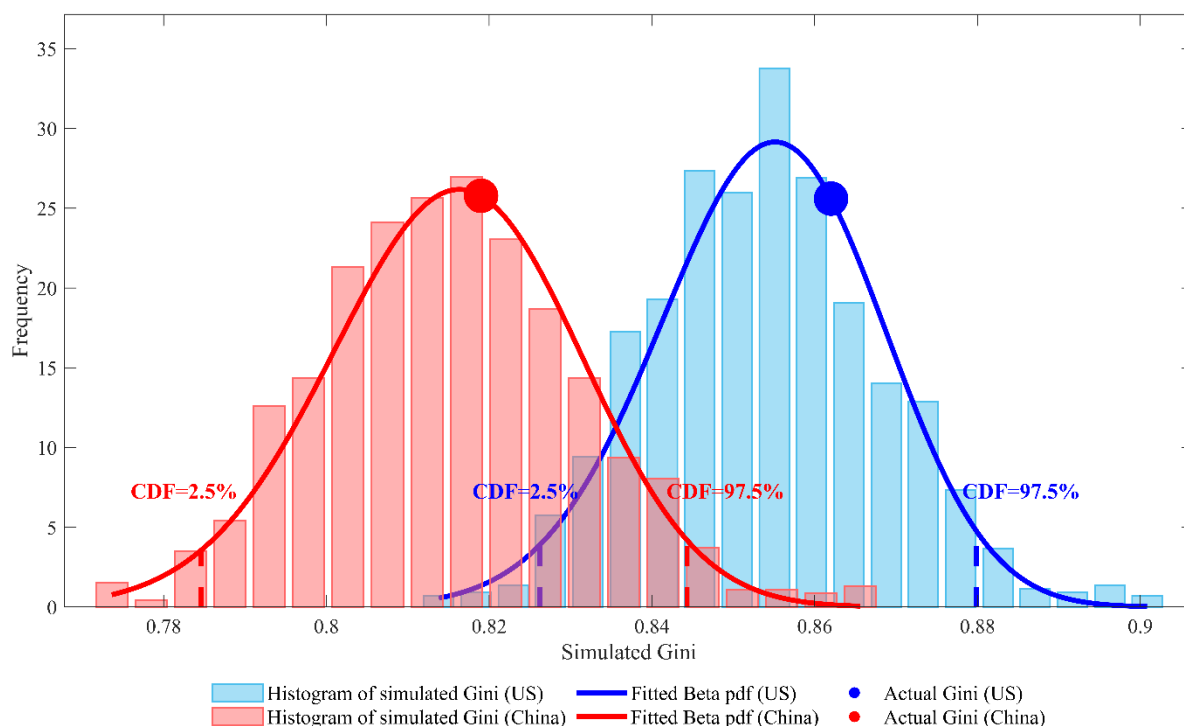

Figure 6 Monte Carlo Simulated Distributions of Gini VS. Observed Gini



The complete results of P-values for all countries are reported in Table 5. Almost all observed Gini coefficients and wealth shares are likely to be generated by the estimated ABM (greater

than 5% significance level). It also seems that the estimated ABM can better match observed Gini coefficients than wealth shares in general.

Based on the N_s simulated data, it enables us to re-estimate $\hat{\sigma}_h$ and obtain its distribution. We report the simulation-based standard errors of $\hat{\sigma}_h$ in Table 4 to indicate the significance and robustness of the estimates.

Table 5 P-Values of the Estimated ABM (G7+C)

Country	Gini Coefficient	Top 10% Wealth Share
Canada	25.3%	6.1%
China	82.7%	6.3%
France	58.0%	10.1%
Germany	71.8%	15.1%
Italy	13.1%	5.1%
Japan	2.3%	0.6%
UK	68.8%	8.3%
US	57.3%	12.1%

Notes: The null hypothesis H_0 is “the estimated ABM is the data generating process for the observed data.” The P-values are the probabilities of the null hypothesis being true.

5.3 Tail Thickness of the Wealth Distribution

In addition to matching quantitative measures of wealth inequality, we also find that the simulated wealth distribution can also replicate a well-documented stylized fact—the thick tail of the richest and the thin tail of the rest. In other words, the rich have a different way of accumulating wealth (the Pareto law or power law) from the poor (an exponential distribution).

To see this, we divide the population into the rich (the top 20%, i.e., the richest 200 agents) and the rest (the bottom 80%, i.e., the other 800 agents) in light of the famous Pareto 20/80 principle. In Figure 7, we fit the wealth distributions of the two groups in the US with a power-law distribution and an exponential distribution respectively. Judging from an eyeball test and the R^2 , we can clearly see that the wealth distribution of the rich nicely fits a power law (panel a1) while the distribution of the rest can be better described by an exponential distribution (panel b1). If we estimate each with the alternative distribution, then the goodness of fit becomes much poorer (panel a2 and panel b2).

Here, we use the US to demonstrate the empirical power of our hybrid ABM, but all our estimated models for other countries share the same feature. There is an extensive literature on the thickness or fatness of the upper tail of wealth distribution (Brzezinski, 2014; Davies *et al.* 2011). A basic understanding of this stylized fact is that the rich accumulate wealth mainly by wealth returns instead of by labor earnings, which has a natural limit.

Figure 7 Wealth Distributions of the Rich and the Rest (US)

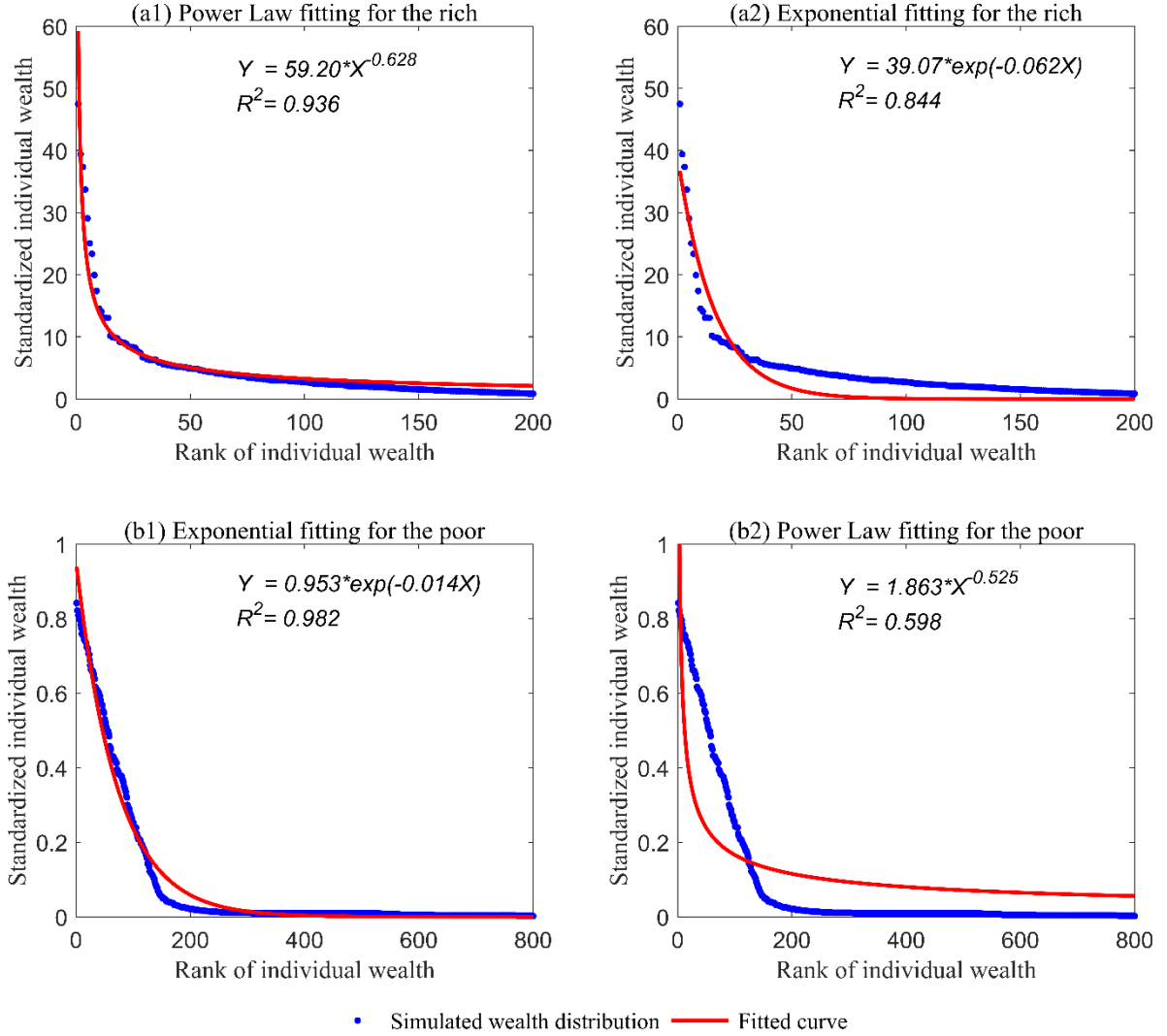

Formally, if a cumulative distribution function (CDF) of wealth $\Phi(w)$ has a thick tail, then the ratio of two complementary/tail probabilities is a (negative) power function of the wealth ratio:

$$\frac{1-\Phi(w)}{1-\Phi(w_{min})} = \left(\frac{w}{w_{min}}\right)^{-\phi} \text{ for } w > w_{min} \quad [5]$$

The highest integer below the tail index $\phi > 0$ determines the number of moments of a power-law distribution (Benhabib & Bisin, 2018). The smaller is ϕ , the thicker the tail. The limiting case of $\phi \rightarrow \infty$ is a thin tailed distribution like the normal and Boltzmann belonging to the exponential family. The empirical literature has well documented the thickness of the upper tail of wealth distribution, such as Vermeulen (2018) and Piketty *et al.* (2019). These empirical estimates are usually based on limited data of the rich and ingenious techniques such as over-sampling are used in estimation. As mentioned above, one advantage of our modelling method is that it can generate otherwise unobserved data like the wealth of the richest (and everyone

else), which are systematically consistent with other observed evidence. We are therefore able to estimate the tail thickness of the wealth distribution without having to worry about the availability and accuracy of the data on the richest.

Figure 8 The Rolling-Window Estimates of The Tail Thickness Indices (G7+C)

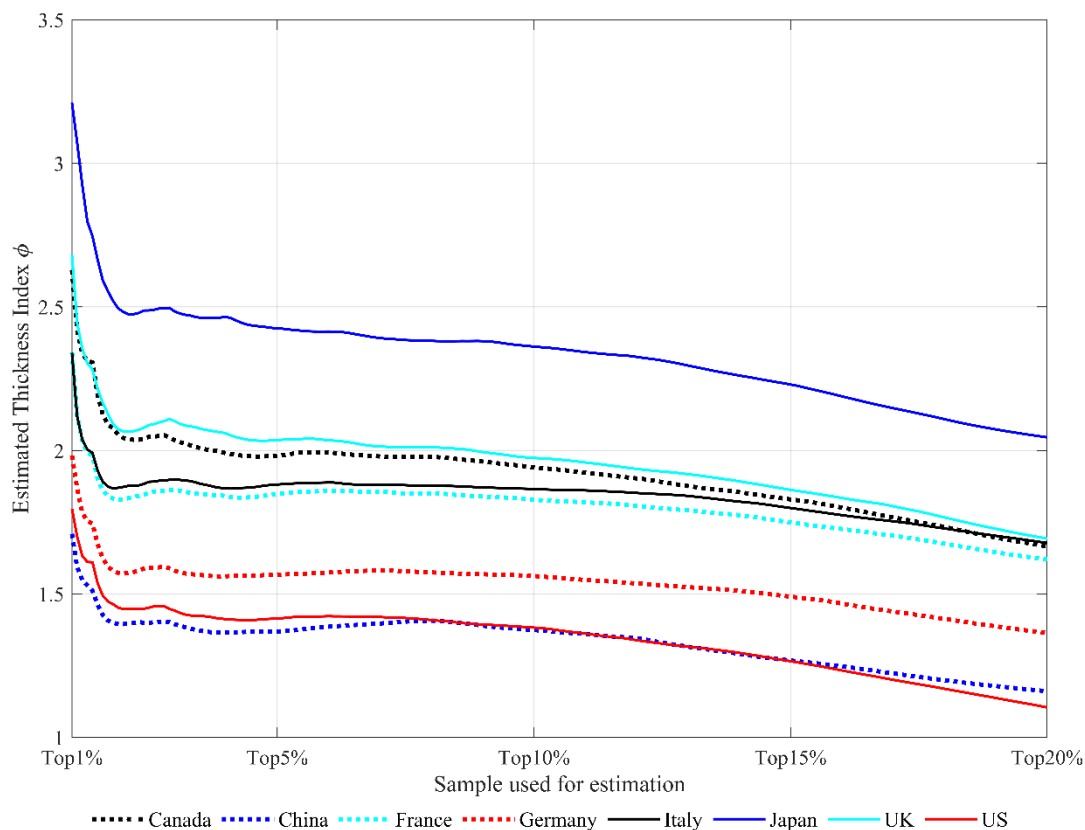

In Figure 8, we plot the estimated tail thickness indices (ϕ) of G7+C using a rolling-window procedure, starting from the top 1% and gradually extending the sample down to top 20%. We identify an interesting pattern—the tail thickness declines as poorer individuals are included in the sample. This pattern is also found in Vermeulen (2018, Appendix Table A1 & Table A2), but no explanation is offered there. We provide a formal proof of why this is always the case in Appendix 3, but the simple story is—the estimated tail thickness based on a mixed sample from both power-law and exponential distributions is thicker than that based on a pure sample from a single power-law distribution. The intuition is that, if some observations come from another thin-tailed (or thinner-tailed) distribution, then the estimated thickness of the overall distribution is magnified. It is like putting a pig’s fat tail behind a goat’s thin bottom, which makes the tail seem even fatter. Figure 8 shows a sharp decline when the sample is extended from top 1% down to top 3%. The indices are stabilized until the top 10% individuals are included in the sample, after which the indices begin to fall again. The pattern implies that there are three cutting points in the upper tails of the wealth distributions (top 1%, top 3%, and top 10%) where thickness sharply diminishes.

Our estimated tail thickness indices based on the simulated upper tails are surprisingly close to those based on observed data. Taking Vermeulen (2018) as an example, his estimates lie well within the ranges of our results (Table 6). His method is based on limited samples of the richest (mostly millionaires and billionaires) without knowing which percentiles those observations belong to. Our method, in contrast, can generate a full population and a complete spectrum of thickness over different ranges of tail coverage.

Table 6 Estimated Tail Thickness Indices (G7+C)

	Our Estimation				Vermeulen (2018)	
	Top 1%	Top 3%	Top 10%	Top 20%	Excl. Forbes	Incl. Forbes
Canada	2.63	2.04	1.94	1.67		
China	1.71	1.39	1.37	1.16		
France	2.34	1.86	1.83	1.62	1.76	1.62
Germany	1.98	1.58	1.56	1.36	1.68	1.39
Italy	2.34	1.90	1.87	1.68	2.02	1.58
Japan	3.21	2.48	2.36	2.05		
UK	2.68	2.10	1.97	1.69	2.05	1.74
US	1.80	1.44	1.38	1.10	1.59	1.52

Notes: The last two columns are copied from Vermeulen (2018) Table 8. The column “Excl. Forbes” provides average of estimated Pareto tail indices using the regression method on the survey data at three thresholds, \$0.5 million, \$1 million, and \$2 million. The column “Incl. Forbes” also adds Forbes billionaires to the survey sample.

5.4 *Shorrocks Indices of the Transition Matrices*

Another important dataset that the ABM can generate is the traces of agents migrating across wealth percentiles over time. It is almost impossible to track actual individuals in real life over such a long time with an adequate sample size, so most empirical studies hinge on inter-generational, rather than intra-generational, mobility. Harnessed with this simulated data, we can shed light on an interesting but rarely discussed issue, intra-generational mobility.

Similar to the thought experiments in the previous section, we report a descriptive measure of mobility: the transition probability of a poorer-than-the-median agent at 30 years old to ascend to the richer-than-the-median group at the end of her life in Table 7. As a dynamic economy, in the US the agent has the highest chance (10.8%) among G7 countries. However, the highest probability belongs to China (13.2%), which has a fast growth and plenty of opportunities. The opposite of the story is described by the downward mobility probabilities with the same ranking and magnitude. It suggests a Schumpeterian “creative destruction” of social classes.

The full transition matrices estimated based on the simulated data are listed in Appendix 2. There is a common pattern across the eight countries—the richest have the highest chance of staying in the same social class (the diagonal elements), with a diminishing probability of moving to a more remote social class (the off-diagonal elements). SIs are reported in Table 7 to quantitatively measure the intra-generational social mobility between the 300th period (30 years old) and the 1000th period (100 years old). The conclusion is in line with the above measures of upward and downward mobility in terms of ranking and magnitude.

Table 7 Estimated Wealth Inequality and Social Mobility Measures (G7+C)

	Wealth Inequality		Social Mobility	
	Gini	Top 10%	Probability	SI
Canada	0.756	56.1%	2.0%	0.343
China	0.835	72.1%	13.2%	0.589
France	0.737	55.1%	3.8%	0.308
Germany	0.798	64.2%	3.2%	0.378
Italy	0.716	52.7%	4.2%	0.270
Japan	0.661	45.4%	4.4%	0.285
UK	0.747	55.2%	4.8%	0.368
US	0.872	77.1%	10.8%	0.539

Notes: Probability = transition probabilities of moving between the poorest half and the richest half.

An interesting finding is that there is a positive relationship between wealth inequality (Gini) and social mobility (SI) (Figure 9). This positive relationship makes sense—if you treat mobility as a “good” and inequality as a “bad”, then indifferent social choices between the two should have a positive trade-off. However, in the empirical literature, a negative Great Gatsby curve is usually found (Güell *et al.*, 2018; Fisher *et al.*, 2016). We call this contradiction the Great Gatsby puzzle. We resolve this puzzle by noting that the empirical literature mainly uses inter-generational rather than intra-generational mobility data (the latter are usually not available). The ABM developed in this model enables us to back-engineer the unobserved data and verify the positively sloped intra-generational Great Gatsby curve.

The two seemingly contradictory curves are compatible. On the one hand, as proposed in Thorstein Veblen’s masterpiece, *The Theory of the Leisure Class* (1899), “social instability leads to political stability”. Arguably, higher inequality is only tolerable if there is greater hope of escaping from poverty and this greater social mobility must be intra-generational—political unrests are initiated by the current generation who suffer both inequality and immobility, not their offspring. It is what intra-generational Great Gatsby curve describes (positively sloped Figure 9). On the other hand, greater wealth inequality means unbalanced education resources and

inherited financial capital available for the next generation. This stops children of the poor to escape from their parents' social classes, hence a negatively sloped inter-generational Great Gatsby curve. A similar conclusion is also found in Garnero *et al.* (2019), which is based on surveys in OECD. As a result, a negatively sloped inter-generational Gatsby curve (a static view) and a positively sloped intra-generational Gatsby curve (a dynamic view) are consistent.

Figure 9 The Intra-generational Great Gatsby Curve

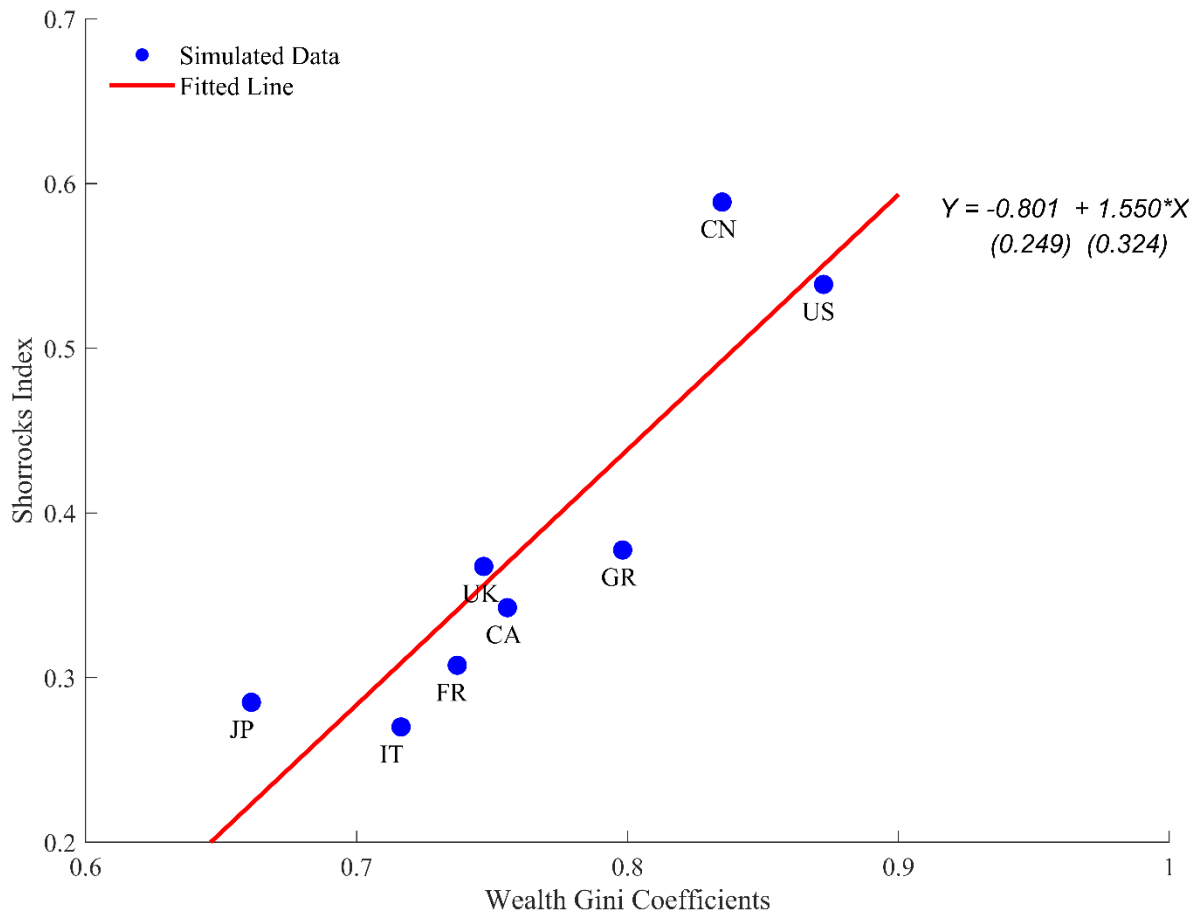

6 Extensions and Applications

ABMs are good apparatuses to test various hypotheses. To do so, we can modify relevant parameters and mechanisms to simulate different counterfactual scenarios. In this section, we apply the model to answering two questions frequently asked in the literature on inequality and mobility. It gives some examples of how to extend and apply the AMB developed in this paper to a wide range of topics.

6.1 Redistributive Effects of Different Taxes

The public finance literature has long discussed and compared redistributive effects of different taxes (Kaymak & Poshke, 2016). The hybrid ABM can be easily extended to have all types of

taxes. We can then compare redistributive effects of different taxes under a revenue-neutral assumption—for a given tax burden, which tax has the biggest effect on wealth inequality?

The generalized version of the budget constraint [1] accommodating for income tax (τ), consumption tax (τ^C), and capital/wealth tax (τ^W) is:

$$w_{t+1} = [(1 - \tau)(y_t - \bar{y}) + T_t - \bar{c} - (1 + \tau^C)(c_t - \bar{c})] + (1 - \tau^W)[w_t(1 + r_{t+1}) - \bar{w}] + \epsilon_t \quad [1]'$$

To fairly evaluate the redistributive effects of different taxes, we assume the same tax burden (the total tax revenue of income tax in the hybrid ABM). Then, we set other (two) tax rates to zero while focusing on only one tax at a time. The hybrid ABM is already a test of income tax because it is a special case of [1]' where $\tau^C = \tau^W = 0$. To evaluate the redistributive effect of consumption tax, we set $\tau = \tau^W = 0$, and for wealth tax, we set $\tau = \tau^C = 0$. To make the simulations realistic, we also assume a tax allowance for each tax. For income tax, the allowance (\bar{y}) is described in subsection 5.1. For consumption tax, the subsistence consumption (\bar{c}), mostly necessities, is tax free. For wealth tax, the allowance (\bar{w}) is the mean wealth of the current population. In this way, all taxes are progressive.

Nonetheless, it is a nontrivial task to calculate the implied tax rates under the counterfactual scenarios because agents are heterogeneous and tax bases change over time. To arrive at the right tax rate, we start with a rough estimate of corresponding tax rate by the ratio between the given tax burden and the tax base. Based on this initial tax rate, we simulate and derive the tax revenue, which may be different from the target tax revenue. Starting from this initial rate, an optimization algorithm is used to search for the right tax rate to minimize the gap in each period. The average income tax rate of the eight countries (as calibrated in Table 3) is 16%, which is greater than the counterfactual wealth tax rate 1.3%, while lower than the counterfactual consumption tax rate 43.6%. This finding is straightforward since the tax base of wealth tax (stock) is much greater than income tax and consumption tax (flow). In the same vein, the tax base of income tax is greater than the consumption tax, which is only charged on non-necessity goods. To see this point, the income tax allowance (\bar{y}) is generally lower than the consumption tax allowance (\bar{c}), as shown in Table 3.

The redistributive effects of the three taxes are summarized in Table 8. Under the same tax burden, the redistributive effect of income tax (τ) lies between wealth tax (τ^W) and consumption tax (τ^C). This general conclusion holds for both wealth Gini and top 10% share. The difference in effectiveness depends on the settings of tax allowances (\bar{y} , \bar{c} , and \bar{w}), but the conclusion ($\tau^W > \tau > \tau^C$) is robust within the realistic range.

Table 8 Redistributive Effects of Different Taxes (G7+C)

	Wealth Gini			Top 10% Share		
	τ	τ^W	τ^C	τ	τ^W	τ^C
Canada	0.756	0.661	0.812	56.1%	43.5%	64.1%
China	0.835	0.840	0.876	72.1%	71.3%	79.1%
France	0.737	0.629	0.783	55.1%	41.5%	61.0%
Germany	0.798	0.737	0.836	64.2%	54.1%	70.1%
Italy	0.716	0.502	0.791	52.7%	30.9%	62.2%
Japan	0.661	0.520	0.717	45.4%	31.3%	50.9%
UK	0.747	0.603	0.838	55.2%	37.3%	69.6%
US	0.872	0.810	0.929	77.1%	63.5%	90.9%

It is easy to understand that wealth tax has the most significant effect on wealth equality—because it directly reduces the wealth stock of the rich and the return on it (returns-related). In contrast, both income tax and consumption tax take effect via the flow (earnings-related) and affect both the rich and the poor. Furthermore, consumption depends on after-tax income (see equation [2]), so income tax has a direct effect on wealth via y_t as well as an indirect effect on wealth via c_t . This explains why income tax has a greater effect than consumption tax.

6.2 Redistributive Effects of Financial Wealth

In the hybrid ABM, all net wealth at the end of each period is invested to form the distribution basis in the next period. Therefore, it is assumed that everyone has equal access to all investment opportunities, and it does not distinguish non-financial assets from financial assets. However, the data show that the proportion of wealth held in the form of financial assets differs between the rich and the poor (Federal Reserve, 2009-2016). Financial asset prices are an important driver of wealth inequality, especially for the super-rich. For an anecdotal example, Jeff Bezos increased by \$13 billion in one day on July 20th, 2020, purely driven by an increase in the price of Amazon shares rather than some accumulation of tangible assets.⁹ Moreover, the return on financial assets tends to be higher than the return on nonfinancial assets (St. Louis Fed, 2009-2016). As a result, in an extended model with financial assets, the wealth inequality is expected to be higher, and the tails of wealth distribution are expected to be thicker.

Due to data availability, we use the US as an example. The extended model is only different from the hybrid model in step 1 (how output is distributed) and step 6 (how wealth is invested). In step 1, output (Y) is still split into labor income (γ) and capital income ($1 - \gamma$), and the labor income is still distributed according to the distribution of human capital. The capital income, nevertheless, is further decomposed into financial capital income ($r^F F$) and nonfinancial capital income ($r^K K$) as in equation [6], where r^F and r^K are returns on financial capital F and

⁹ We thank an anonymous referee who suggested this anecdotal example.

nonfinancial capital K . The two types of capital income are then distributed according to ownership structures of the two assets. In step 6, the ratio of financial assets for each individual is updated according to her current position in the wealth distribution in each period. We calibrate the ratio by the data on Distributional Financial Accounts (Federal Reserve, 2009-2016). The resulting ownership structures then form the distribution basis in the next period.

$$(1 - \gamma)Y = r^F F + r^K K, \text{ where } F = \sum_{i=1}^N F_i \text{ and } K = \sum_{i=1}^N K_i \quad [6]$$

The values of $(1 - \gamma)Y$, F , and K are either exogenously given or endogenously simulated based on the model. The value of r^F is based on the data (Bank's return on equity minus annual inflation rate, GeoFRED, St. Louis Fed, 2009-2016). The value of r^K is derived based on the identity of [6]. All additional calibrations and implied r^K are listed below.

Ratio of Financial Assets for the Top 1%	32.68%
Ratio of Financial Assets for the Top 2-10%	17.61%
Ratio of Financial Assets for the Top 11-50%	7.19%
Ratio of Financial Assets for the Bottom 50%	2.16%
Return on Financial Assets (Data)	5.96%
Return on Nonfinancial Assets (Implied)	0.3%

The re-estimated key parameter $\hat{\sigma}_h$ of the extended model is 5.23, smaller than the hybrid model 8.90. It suggests that the importance of human capital dispersion drops if financial wealth is considered. In other words, financial wealth can exacerbate wealth inequality.

In Table 9, we compare the hybrid ABM with the extended ABM under different parameterizations. Extended model 0 is calibrated with actual returns on financial assets. On the one hand, the richest become more disperse with a greater tail thickness, but the wealth inequality in general (measured by wealth Gini) becomes smaller. On the other hand, the social mobility also drops when financial wealth is introduced in terms of both transition probabilities (10.8% \rightarrow 3.6%) and SIs (0.539 \rightarrow 0.346). To explore why we observe positive effects of financial wealth on inequality and mobility, we perform two counterfactual experiments.

Extended model 1 imposes a 10% higher return on financial assets ($r^F = 6.55\% > 5.96\%$), *ceteris paribus*. It is shown in Table 9 that both inequality and mobility drop mildly as the return rises. This finding suggests that a higher financial return can help the poor more than proportionately than the rich, even if the poor invest less proportionately (Azmat *et al.*, 2020).

Extended model 2 assumes an equal ratio for all individuals (implying a higher ratio for the poor), *ceteris paribus*. The measures of inequality and mobility all drop substantially. This

finding echoes recent literature—inclusive financial development can significantly reduce inequality via economic growth (Altunbaş & Thornton, 2020; Zhang & Zhou, 2021).

Table 9 Redistributive Effects of Financial Wealth (US)

	Observed Data	Hybrid Model	Extended Model 0 (calibrated)	Extended Model 1 ($r^F \uparrow$)	Extended Model 2 (Ratio \uparrow)
$\hat{\sigma}_h$	NA	8.90		5.23	
Wealth Gini	0.862	0.872	0.854	0.869	0.695
Top 10% Share	77.6%	77.1%	78.0%	80.6%	48.9%
Transition Probability	NA	10.8%	3.6%	3.6%	4.0%
SI	NA	0.539	0.346	0.355	0.305
1% Tail Thickness	NA	1.80	3.04	3.09	3.03
3% Tail Thickness	NA	1.44	0.65	0.59	2.27
10% Tail Thickness	NA	1.38	0.96	0.88	2.21
20% Tail Thickness	NA	1.10	0.94	0.90	1.90

7 Concluding Remarks

In this paper, we begin with a set of thought experiments to answer causality-type theoretical questions related to wealth inequality and social mobility. We conclude that (i) *ceteris paribus*, stochastic shocks *per se* can lead to a “natural” degree of inequality, even if everything is equal in the initial state and fair in the distribution process; (ii) redistributive taxation and economic growth tend to alleviate inequality, but heterogeneous endowments in human and physical capital make things worse.

In the empirical exercise, we integrate the simple thought experiments into a comprehensive ABM with an adequate degree of realism for eight major economies (G7+C). The model can well match the observed measures of wealth inequality (“macrostates”), while generating unobserved “microstates” (each agent’s wealth history). The derived datasets enable us to answer many interesting questions that are not addressable with more data-demanding approaches. First, we can now estimate the tail thickness for each percentile of wealth distribution, and our simulation-based estimates are largely in line with the data-based estimates in the empirical literature. Second, the evolution of each agent’s wealth makes it possible to calculate the Shorrocks index to quantify social mobility. Surprisingly, despite a greater mobility in the US compared with the other G7 countries, emerging economies like China are more favorable for upward mobility thanks to fast economic growth and a high return to education. Third, we discover a positively sloped intra-generational Great Gatsby curve—greater wealth inequality is associated with higher social mobility. This pattern has been neglected in the literature due to the lack of data.

We then extend and apply the hybrid model to address widely discussed issues on inequality and mobility. With the help of different taxes, we conclude that factors related to returns contribute to wealth inequality more than factors related to earnings. By distinguishing between financial and nonfinancial wealth, we find that inclusive financial development can reduce wealth inequality.

Two policy implications can be drawn from our theoretical and empirical conclusions. On the one hand, policymakers should work on reducing inequality in schooling and promoting the return on education, given the paramount role of human capital in wealth creation and distribution. On the other hand, given the importance of shocks and returns in forming wealth inequality, policymakers should facilitate an inclusive access to the financial market for deprived individuals and to the capital market for small businesses. In practice, financial inclusion has been an effective tool for the United Nations to reduce poverty and wealth inequality in developing countries like India, Philippines, and Tanzania.

Furthermore, despite that taxation can certainly represent an effective tool in reducing inequality, a more effective policy intervention should intervene directly in the real sphere of the economy, and specifically in the labor market (Caiani et al., 2019). For instance, considering western countries, after decades of “structural reforms” aimed at reducing the bargaining power of workers, the typical wage of non-supervisory workers (endowed with low human capital) has increased quite less than labor productivity, thus amplifying income differences. The expansion of finance that characterized the same period has only allowed to postpone an inevitable crisis such as the Global Financial Crisis. Monetary policy measures have been implemented to help the system to recover. Now, not only more effective fiscal policies aimed at redistributing the resources are needed, but it is also necessary to revisit the balance of power in the labor market in order to create the condition for a more equitable, inclusive growth. In other words, ex-post redistribution through the taxation system can have beneficial effects on the economy, but it is also necessary to consider ex-ante distribution issues and social mobility issues.¹⁰

There are of course limitations of this paper. First, the simulation-based thought experiments cannot completely replace neoclassical models. ABMs are useful to offer an alternative perspective to test causalities, while theoretical foundations of these causalities can be derived from neoclassical economic principles like individual optimization and general equilibrium. Second, our empirical hybrid ABM is still a simplification of the reality, but it can serve as a prototypical model for other extensions and applications. Future studies can add richer features like overlapping generation structure, geographical dimension, endogenous human capital accumulation, and endogenous growth. One promising extension is to allow for private finance and negative wealth. In the hybrid ABM, if an individual touches the zero lower bound, her

¹⁰ The credit of this policy discussion belongs to one of the anonymous referees.

demand for subsistence consumption is subsidized by public finance or social benefit. In an extended model with private finance, both the poor and the middle class can borrow from the rich via banks and pay back an interest. If the borrower is unlucky, she can run into negative equity and default on her debt. These detailed mechanisms in the financial market can be incorporated into the model to study credit rationing and nonperforming loans. Another possible extension of the ABM is to investigate whether an appropriately calibrated version of the model can reproduce the dynamics of wealth distribution over time. One merit of our bottom-up approach is its flexibility and extensibility to new scenarios. Therefore, it has a great potential for counterfactual analysis of other complicated contexts.

References

- Adam, Klaus and Junyi Zhu. (2016). "Price-Level Changes and the Redistribution of Nominal Wealth across the Euro Area." *Journal of the European Economic Association*, 14(4), 871-906.
- Adermon, Adrian, Mikael Lindahl, and Daniel Waldenstrom. (2018). "Intergenerational Wealth Mobility and the Role of Inheritance: Evidence from Multiple Generations." *The Economic Journal*, 128(612), F482-F513.
- Aghion, Philippe and Patrick Bolton. (1997). "A Theory of Trickle-Down Growth and Development." *Review of Economic Studies*, 64(2), 151-72.
- Aiyagari, S. Rao. (1994). "Uninsured Idiosyncratic Risk and Aggregate Saving." *Quarterly Journal of Economics*, 109(3), 659-84.
- Alesina, Alberto, Rafael Di Tella, and Robert MacCulloch. (2004). "Inequality and Happiness: Are Europeans and Americans Different?" *Journal of Public Economics*, 88(9-10), 2009-42.
- Alesina, Alberto and Dani Rodrik. (1994). "Distributive Politics and Economic-Growth." *Quarterly Journal of Economics*, 109(2), 465-90.
- Alesina, Alberto and Enrico Spolaore. (2003). *The Size of Nations*. MIT Press, Cambridge, MA.
- Alesina, Alberto, Stefanie Stantcheva, and Edoardo Teso. (2018). "Intergenerational Mobility and Preferences for Redistribution." *American Economic Review*, 108(2), 521-54.
- Algan, Yann, Olivier Allais, and Wouter J. Den Haan. (2008). "Solving Heterogeneous-Agent Models with Parameterized Cross-Sectional Distributions." *Journal of Economic Dynamics & Control*, 32(3), 875-908.
- Almas, Ingvild, Alexander W. Cappelen, Jo Thori Lind, Erik O. Sorensen, and Bertil Tungodden. (2011). "Measuring Unfair (in)Equality." *Journal of Public Economics*, 95(7-8), 488-99.
- Altunbaş, Yener and John Thornton. (2020). "Finance and Income Inequality Revisited." *Finance Research Letters*, 37, 101355. <https://doi.org/10.1016/j.frl.2019.101355>.
- Alvaredo, Facundo, Anthony B. Atkinson, and Salvatore Morelli. (2018). "Top Wealth Shares in the UK over More Than a Century." *Journal of Public Economics*, 162, 26-47.
- Alvaredo, Facundo, Lucas Chancel, Thomas Piketty, Emmanuel Saez, and Gabriel Zucman. (2017). "Global Inequality Dynamics: New Findings from Wid. World." *American Economic Review*, 107(5), 404-09.
- Andrews, Dan and Andrew Leigh. (2009). "More Inequality, Less Social Mobility." *Applied Economics Letters*, 16(15), 1489-92.
- Arenas, Andreu and Jean Hindriks. (2021). "Intergenerational Mobility and Unequal School Opportunity." *The Economic Journal*, 131(635), 1027-1050.
- Arneson, Richard. J. (1989). "Equality and Equal-Opportunity for Welfare." *Philosophical Studies*, 56(1), 77-93.
- Atkinson, Anthony Barnes. (1971). "Capital Taxes, the Redistribution of Wealth and Individual Savings." *The Review of Economic Studies*, 38(2), 209-27.
- Azmat, Saad, Ahmad Ayub, Kym Brown and Michael Skully. (2020). "The Inequality Debate: Do Financial Markets Matter?" *Journal of Behavioral and Experimental Finance*, 27, 100384. <https://doi.org/10.1016/j.jbef.2020.100384>.
- Banerjee, Abhijit. V. and Esther Duflo. (2003). "Inequality and Growth: What Can the Data Say?" *Journal of Economic Growth*, 8(3), 267-99.
- Bardhan, Pranab, Maitreesh Ghatak, and Alexander Karaivanov. (2007). "Wealth Inequality and Collective Action." *Journal of Public Economics*, 91(9), 1843-74.
- Barro, Robert. J. (2000). "Inequality and Growth in a Panel of Countries." *Journal of Economic*

- Growth*, 5(1), 5-32.
- Becker, Gary S. and Nigel Tomes. (1979). "Equilibrium-Theory of the Distribution of Income and Intergenerational Mobility." *Journal of Political Economy*, 87(6), 1153-89.
- Benabou, Roland and Efe. A. Ok. (2001). "Social Mobility and the Demand for Redistribution: The Poup Hypothesis." *Quarterly Journal of Economics*, 116(2), 447-87.
- Benhabib, Jess and Alberto Bisin. (2018). "Skewed Wealth Distributions: Theory and Empirics." *Journal of Economic Literature*, 56(4), 1261-91.
- Benhabib, Jess, Alberto Bisin, and Mi Luo. (2019). "Wealth Distribution and Social Mobility in the US: A Quantitative Approach." *American Economic Review*, 109(5), 1623-47.
- Benhabib, Jess, Alberto Bisin, and Shenghao Zhu. (2015). "The Wealth Distribution in Bewley Economies with Capital Income Risk." *Journal of Economic Theory*, 159, 489-515.
- Benhabib, Jess, Alberto Bisin, and Shenghao Zhu. (2016). "The Distribution of Wealth in the Blanchard–Yaari Model." *Macroeconomic Dynamics*, 20(2), 466-81.
- Beshers, James M. and Edward O. Laumann. (1967). "Social Distance: A Network Approach." *American Sociological Review*, 32(2), 225-36.
- Bhattacharya, Joydeep. (1998). "Credit Market Imperfections, Income Distribution, and Capital Accumulation." *The Economic Theory*, 11(1), 171-200.
- Björklund, Anders and Markus Jäntti. (1997). "Intergenerational Income Mobility in Sweden Compared to the United States." *American Economic Review*, 87(5), 1009-18.
- Björklund, Anders, Markus Jantti, and Martin Nybom. (2017). "The Contribution of Early-Life Versus Labour Market Factors to Intergenerational Income Persistence: A Comparison of the UK and Sweden." *The Economic Journal*, 127(605), F71-F94.
- Björklund, Anders, Jesper Roine, and Daniel Waldenstrom. (2012). "Intergenerational Top Income Mobility in Sweden: Capitalist Dynasties in the Land of Equal Opportunity?" *Journal of Public Economics*, 96(5-6), 474-84.
- Blanchard, Olivier J. (1985). "Debt, Deficits, and Finite Horizons." *Journal of Political Economy*, 93(2), 223-47.
- Blau, Peter M. and Otis Dudley Duncan. (1968). *The American Occupational Structure*, First edition. John Wiley & Sons Inc., New York.
- Bolton, Patrick and Gérard Roland. (1997). "The Breakup of Nations: A Political Economy Analysis." *Quarterly Journal of Economics*, 112(4), 1057-90.
- Brzezinski, Michal. (2014). "Do Wealth Distributions Follow Power Laws? Evidence from 'Rich Lists'." *Physica A: Statistical Mechanics and Its Applications*, 406, 155-62.
- Cagetti, Marco and Mariacristina De Nardi. (2008). "Wealth Inequality: Data and Models." *Macroeconomic Dynamics*, 12, 285-313.
- Caiani, Alessandro, Antoine Godin, Eugenio Caverzasi, Mauro Gallegati, Stephen Kinsella, and Joseph E. Stiglitz. (2016). "Agent Based-Stock Flow Consistent Macroeconomics: Towards A Benchmark Model." *Journal of Economic Dynamics and Control*, 69, 375-408.
- Caiani, Alessandro, Alberto Russo, and Mauro Gallegati. (2019). "Does Inequality Hamper Innovation and Growth? An AB-SFC Analysis." *Journal of Evolutionary Economics*, 29(1), 177-228.
- Carroll, Christopher, Jiri Slacalek, Kiichi Tokuoka, and Matthew N. White. (2017). "The Distribution of Wealth and the Marginal Propensity to Consume." *Quantitative Economics*, 8(3), 977-1020.
- Caselli, Francesco and Jaime Ventura. (2000). "A Representative Consumer Theory of Distribution." *American Economic Review*, 90(4), 909-26.
- Castelló-Climent, Amparo. (2010). "Inequality and Growth in Advanced Economies: An Empirical Investigation." *Journal of Economic Inequality*, 8(3), 293-321.
- Champernowne, D. G. (1953). "A Model of Income Distribution." *The Economic Journal*, 63(250), 318-51.

- Charness, Gary and Garance Genicot. (2009). "Informal Risk Sharing in an Infinite-Horizon Experiment." *The Economic Journal*, 119(537), 796-825.
- Chattopadhyay, Amit K., T. Krishna Kumar, and Sushanta K. Mallick. (2017). "Poverty Index with Time-Varying Consumption and Income Distributions." *Physical Review E*, 95(3).
- Colander, David, Peter Howitt, Alan Kirman, Axel Leijonhufvud, and Perry Mehrling. (2008). "Beyond DSGE Models: Toward an Empirically Based Macroeconomics." *American Economic Review*, 98(2), 236-40.
- Conlisk, John. (1974). "Can Equalization of Opportunity Reduce Social Mobility?" *American Economic Review*, 64(1), 80-90.
- Corak, Miles. (2013). "Income Inequality, Equality of Opportunity, and Intergenerational Mobility." *Journal of Economic Perspectives*, 27(3), 79-102.
- Corak, Miles. (2020). "The Canadian Geography of Intergenerational Income Mobility." *The Economic Journal*, 130(631), 2134-2174.
- Couch, Kenneth A., Robert W. Fairlie and Huanan Xu. (2020). "Early Evidence of The Impacts of COVID-19 on Minority Unemployment." *Journal of Public Economics*, 192. 104287. <https://doi.org/10.1016/j.jpubeco.2020.104287>
- Davies, James B., Susanna Sandstroem, Anthony Shorrocks, and Edward N. Wolff. (2011). "The Level and Distribution of Global Household Wealth." *The Economic Journal*, 121(551), 223-54.
- De Gregorio, José and Jong-Wha Lee. (2002). "Education and Income Inequality: New Evidence from Cross-Country Data." *Review of Income and Wealth*, (3), 395-416.
- De Nardi, Mariacristina. (2004). "Wealth Inequality and Intergenerational Links." *The Review of Economic Studies*, 71(3), 743-68.
- Deltas, George. (2003). "The Small-Sample Bias of the Gini Coefficient: Results and Implications for Empirical Research." *Review of Economics and Statistics*, 85(1), 226-34.
- Doepke, Matthias and Fabrizio Zilibotti. (2005). "Social Class and the Spirit of Capitalism." *Journal of the European Economic Association*, 3(2-3), 516-24.
- Dosi, G., M. C. Pereira, A. Roventini, and M. E. Virgillito. (2020). "The Labour-Augmented K+S Model: A Laboratory for The Analysis of Institutional and Policy Regimes." *Economia*, 21(2), 160-184.
- Drăgulescu, Adrian and Victor M. Yakovenko. (2000). "Statistical Mechanics of Money." *European Physical Journal B*, 17(4), 723-29.
- Durlauf, Steven N. (1994). "Spillovers, Stratification, and Inequality." *European Economic Review*, 38(3-4), 836-45.
- Edgeworth, Francis Ysidro. (1917). "On the Mathematical Representation of Statistical Data." *Journal of the Royal Statistical Society*, 80(3), 411-37.
- Erikson, Robert and John H. Goldthorpe. (2002). "Intergenerational Inequality: A Sociological Perspective." *Journal of Economic Perspectives*, 16(3), 31-44.
- Fagereng, Andreas, Luigi Guiso, Davide Malacrino, and Luigi Pistaferri. (2016). "Heterogeneity in Returns to Wealth and the Measurement of Wealth Inequality." *American Economic Review*, 106(5), 651-55.
- Farmer, J. Doyne and Duncan Foley. (2009). "The Economy Needs Agent-Based Modelling." *Nature*, 460(7256), 685-86.
- Featherman, David. (1975). "Social-Stratification and Career Mobility. Edited by Walter Müller and Karl Ulrich Mayer. The Hague: Mouton, 1974. 390 pp." *Social Forces*, 54(2), 495-96.
- Fernholz, Ricardo; Fernholz, Robert. (2014) Instability and concentration in the distribution of wealth. *Journal of Economic Dynamics and Control*, 44(7), 251-269.
- Fisher, Jonathan, David Johnson, Jonathan Latner, Timothy Smeeding, and Jeffrey Thompson. (2016). "Inequality and Mobility Using Income, Consumption, and Wealth for the Same

- Individuals.” *The Russell Sage Foundation journal of the social sciences: RSF*, 2(6), 44-58.
- Forbes, Kristin J. (2000). “A Reassessment of the Relationship between Inequality and Growth.” *American Economic Review*, 90(4), 869-87.
- Gächter, Simon, Friederike Mengel, Elias Tsakas, and Alexander Vostroknutov. (2017). “Growth and Inequality in Public Good Provision.” *Journal of Public Economics*, 150, 1-13.
- Gallegati, Mauro and Alan Kirman. (2012). “Reconstructing Economics: Agent Based Models and Complexity.” *Complexity Economics*, 1(1), 5-31.
- Galor, Oded and Omer Moav. (2000). “Ability-Biased Technological Transition, Wage Inequality, and Economic Growth.” *Quarterly Journal of Economics*, 115(2), 469-97.
- Galor, Oded and Daniel Tsiddon. (1997). “Technological Progress, Mobility, and Economic Growth.” *American Economic Review*, 87(3), 363-82.
- Galor, Oded and Joseph Zeira. (1993). “Income-Distribution and Macroeconomics.” *The Review of Economic Studies*, 60(1), 35-52.
- Garbinti, Bertrand, Jonathan Goupille-Lebret, and Thomas Piketty. (2021). “Accounting for Wealth-Inequality Dynamics: Methods, Estimates, and Simulations for France.” *Journal of the European Economic Association*, 19(1), 620-663.
- Garnero, Andrea, Alexander Hijzen, and Sébastien Martin. (2019). “More Unequal, But More Mobile? Earnings Inequality and Mobility in OECD Countries.” *Labour Economics*, 56, 26-35.
- Geanakoplos, John, Robert Axtell, Doyne J. Farmer, Peter Howitt, Benjamin Conlee, Jonathan Goldstein, Matthew Hendrey, Nathan M. Palmer, and Chun-Yi Yang. (2012). “Getting at Systemic Risk Via an Agent-Based Model of the Housing Market.” *American Economic Review*, 102(3), 53-58.
- Goswami, Sanchari and Parongama Sen. (2014). “Agent Based Models for Wealth Distribution with Preference in Interaction.” *Physica A: Statistical Mechanics and its Applications*, 415, 514-24.
- Güell, Maia, Michele Pellizzari, Giovanni Pica, and José V. Rodríguez Mora. (2018). “Correlating Social Mobility and Economic Outcomes.” *The Economic Journal*, 128(612), F353-F403.
- Turnovsky, S. (2015) Economic growth and inequality: The role of public investment. *Journal of Economic Dynamics and Control*, 61(12), 204-221.
- Hamill, Lynne and Nigel Gilbert. (2016). *Agent-Based Modelling in Economics*, First edition. John Wiley & Sons, Ltd., New York.
- Kanbur, Ravi and Joseph E. Stiglitz. (2016). “Dynastic Inequality, Mobility and Equality of Opportunity.” *Journal of Economic Inequality*, 14(4), 419-34.
- Kaymak, Barış and Markus Poschke. (2016). “The Evolution of Wealth Inequality over Half A Century: The Role of Taxes, Transfers and Technology.” *Journal of Monetary Economics*, 77, 1-25.
- Kearney, Melissa S. and Phillip B. Levine. (2014). “Income Inequality and Early Nonmarital Childbearing.” *Journal of Human Resources*, 49(1), 1-31.
- Kesten, Harry. (1973). “Random Difference Equations and Renewal Theory for Products of Random Matrices.” *Acta Mathematica*, 131(1), 207-48.
- Kopczuk, Wojciech, Emmanuel Saez, and Jae Song. (2010). “Earnings Inequality and Mobility in the United States: Evidence from Social Security Data since 1937.” *Quarterly Journal of Economics*, 125(1), 91-128.
- Kuznets, Simon. (1955). “Economic Growth and Income Inequality.” *American Economic Review*, 45(1), 1-28.
- Laitner, John. (2001). “Secular Changes in Wealth Inequality and Inheritance.” *The Economic*

- Journal*, 111(474), 691-721.
- Lee, Sang Yoon and Ananth Seshadri. (2018). "Economic Policy and Equality of Opportunity." *The Economic Journal*, 128(612), F114-F51.
- Lefgren, Lars, Matthew J. Lindquist, and David Sims. (2012). "Rich Dad, Smart Dad: Decomposing the Intergenerational Transmission of Income." *Journal of Political Economy*, 120(2), 268-303.
- Long, Jason and Joseph Ferrie. (2013). "Intergenerational Occupational Mobility in Great Britain and the United States since 1850." *American Economic Review*, 103(4), 1109-37.
- Long, Jason and Joseph Ferrie. (2018). "Grandfathers Matter(ed): Occupational Mobility across Three Generations in the Us and Britain, 1850-1911." *The Economic Journal*, 128(612), F422-F45.
- Loury, Glenn C. (1981). "Intergenerational Transfers and the Distribution of Earnings." *Econometrica*, 49(4), 843-67.
- Martin, Philippe. (1999). "Public Policies, Regional Inequalities and Growth." *Journal of Public Economics*, 73(1), 85-105.
- Mazumder, Bhashkar. (2005). "Fortunate Sons: New Estimates of Intergenerational Mobility in the United States Using Social Security Earnings Data." *Review of Economics and Statistics*, 87(2), 235-55.
- Montenegro, Claudio E. and Harry Anthony Patrinos. (2014). "Comparable Estimates of Returns to Schooling around the World." World Bank Policy Research Working Paper No. 7020, Washington, DC.
- Nirei, Makoto and Wataru Souma. (2007). "A Two Factor Model of Income Distribution Dynamics." *Review of Income and Wealth*, 53(3), 440-59.
- Papadopoulos, Georgios. (2019). Income inequality, consumption, credit and credit risk in a data-driven agent-based model. *Journal of Economic Dynamics and Control*, 104(7), 39-73.
- Pareto, Vilfredo. (1897). *Cours D'Economie Politique*. In Bousquet, G. H. and G. Busino eds., *Oevres Completes de Vilfredo Pareto*, 1. Geneva: Librairie Droz, 1964.
- Perotti, Roberto. (1996). "Growth, Income Distribution, and Democracy: What the Data Say." *Journal of Economic Growth*, 1(2), 149-87.
- Piketty, Thomas. (1995). "Social-Mobility and Redistributive Politics." *Quarterly Journal of Economics*, 110(3), 551-84.
- Piketty, Thomas and Emmanuel Saez. (2014). "Inequality in the Long Run." *Science*, 344(6186), 838-43.
- Piketty, Thomas; Li Yang and Gabriel Zucman. (2019). "Capital Accumulation, Private Property, and Rising Inequality in China, 1978-2015." *American Economic Review*, 109(7), 2469-96.
- Reed, William J. (2001). "The Pareto, Zipf and Other Power Laws." *Economics Letters*, 74(1), 15-19.
- Rodríguez, Santiago Budría, Javier Díaz-Giménez, Vincenzo Quadrini, and José-Víctor Ríos-Rull. (2002). "Updated Facts on the U.S. Distributions of Earnings, Income, and Wealth." *Federal Reserve Bank of Minneapolis Quarterly Review*, 26(3), 2-35.
- Roth, Christopher and Johannes Wohlfart. (2018). "Experienced Inequality and Preferences for Redistribution." *Journal of Public Economics*, 167, 251-62.
- Saez, Emmanuel and Gabriel Zucman. (2016). "Wealth Inequality in the United States since 1913: Evidence from Capitalized Income Tax Data." *Quarterly Journal of Economics*, 131(2), 519-78.
- Schabas, Margaret. (2008). "Hume's Monetary Thought Experiments." *Studies in History and Philosophy of Science*, 39(2), 161-69.
- Shorrocks, Anthony. (1975). "Stochastic-Models of Size Distributions." *The Review of*

- Economic Studies*, 42(4), 631-41.
- Shorrocks, Anthony. (1978). "Measurement of Mobility." *Econometrica*, 46(5), 1013-24.
- Slack, Sean Edward. (2015). "Revisiting the Optimal Linear Income Tax with Categorical Transfers." *Economics Letters*, 134, 73-77.
- Solon, Gary. (1992). "Intergenerational Income Mobility in the United-States." *American Economic Review*, 82(3), 393-408.
- Vermeulen, Philip. (2018). "How Fat Is the Top Tail of the Wealth Distribution?" *Review of Income and Wealth*, 64(2), 357-87.
- Wold, H. O. A. and P. Whittle. (1957). "A Model Explaining the Pareto Distribution of Wealth." *Econometrica*, 25(4), 591-95.
- Yakovenko, Victor M. and J. Barkley Rosser, Jr. (2009). "Colloquium: Statistical Mechanics of Money, Wealth, and Income." *Reviews of Modern Physics*, 81(4), 1703-25.
- Zhang, Bo and Peng Zhou. (2021). "Financial Development and Economic Growth in A Microfounded Small Open Economy Model." *The North American Journal of Economics and Finance*, 58, 101544. <https://doi.org/10.1016/j.najef.2021.101544>.

Appendix 1: Data Description

The data used in this paper come from a variety of sources.

- GDP per capita

GDP per capita is measured in 2010 US dollars at constant prices, published by the *World Bank national accounts data*, and *OECD National Accounts data files*, available at:

<https://data.worldbank.org/indicator/NY.GDP.PCAP.KD?view=chart>

- Human capital return

Human capital return is calibrated by the return to another year of schooling based on the Annex Table 1 in Montenegro & Patrinos (2014) published by the *World Bank Education Global Practice Group*, available at: <http://econ.worldbank.org>

- Personal income tax allowance

The personal income tax allowance is calculated by the sum of the threshold of annual personal income tax plus annual personal deductions, transferred by the average foreign exchange rate against the US dollars in 2016. Sources of the tax information in each country are listed below.

Canada: *Government of Canada*, available at:

<https://www.canada.ca/en/revenue-agency/news/newsroom/fact-sheets/fact-sheets-2015/2016-indexation-adjustment-personal-income-tax-benefit-amounts.html>

China: *Ministry of Finance of the People's Republic of China*, available at:

http://szs.mof.gov.cn/shuizhijianjie/200806/t20080630_54460.htm

France, Germany, Italy, US: *Taxing Wages 2017 published by OECD*, available at:

https://www.oecd-ilibrary.org/taxation/taxing-wages-2017_tax_wages-2017-en

Japan: *Ministry of Finance Japan*, available at:

https://www.mof.go.jp/english/tax_policy/tax_system/income/index.html

UK: *GOV.UK*, available at:

<https://www.gov.uk/government/publications/rates-and-allowances-income-tax/income-tax-rates-and-allowances-current-and-past>

- Poverty line

The poverty line is computed following OECD methodology, i.e., the half of the median disposable household income. Data for G7 countries are collected in the OECD Database, available at: <https://data.oecd.org/hha/household-disposable-income.htm>

Data for China are from National Bureau of Statistics of China, available at:

<http://data.stats.gov.cn/easyquery.htm?cn=C01>

- Marginal consumption propensity

It is estimated from the consumption equation, which is equal to the ratio of (consumption per capita – poverty line) over disposable income per capita. The data on household consumption per capita and disposable income per capita are collected from the OECD Database.

Appendix 2: Transition Matrices

Table 10 Social Mobility Transition Matrices of Thought Experiments

Tax Model	Bottom 20%	Lower 20%	Middle 20%	Upper 20%	Top 20%
Bottom 20%	46.5%	21.5%	18.0%	9.0%	5.0%
Lower 20%	24.5%	26.0%	25.5%	14.0%	10.0%
Middle 20%	16.0%	21.0%	23.5%	22.5%	17.0%
Upper 20%	9.5%	19.5%	19.5%	27.5%	24.0%
Top 20%	3.5%	12.0%	13.5%	27.0%	44.0%

Growth Model	Bottom 20%	Lower 20%	Middle 20%	Upper 20%	Top 20%
Bottom 20%	21.5%	21.0%	17.5%	21.0%	19.0%
Lower 20%	21.5%	16.5%	16.5%	26.0%	19.5%
Middle 20%	19.5%	20.0%	26.0%	15.5%	19.0%
Upper 20%	19.0%	17.5%	18.5%	20.5%	24.5%
Top 20%	18.5%	25.0%	21.5%	17.0%	18.0%

Human Capital Model	Bottom 20%	Lower 20%	Middle 20%	Upper 20%	Top 20%
Bottom 20%	35.5%	31.5%	22.0%	10.0%	1.0%
Lower 20%	30.5%	36.5%	19.5%	12.0%	1.5%
Middle 20%	20.5%	20.0%	28.5%	26.5%	4.5%
Upper 20%	13.0%	11.5%	27.5%	28.0%	20.0%
Top 20%	0.5%	0.5%	2.5%	23.5%	73.0%

Physical Capital Model	Bottom 20%	Lower 20%	Middle 20%	Upper 20%	Top 20%
Bottom 20%	82.5%	11.5%	0.5%	5.0%	0.5%
Lower 20%	0.0%	60.5%	8.0%	20.0%	11.5%
Middle 20%	9.5%	1.0%	54.5%	19.5%	15.5%
Upper 20%	5.5%	22.5%	26.5%	34.5%	11.0%
Top 20%	2.5%	4.5%	10.5%	21.0%	61.5%

Table 11 Social Mobility Matrices of Hybrid Models (G7+C)

Canada	Bottom 20%	Lower 20%	Middle 20%	Upper 20%	Top 20%
Bottom 20%	69.5%	26.5%	4.0%	0.0%	0.0%
Lower 20%	51.5%	34.0%	14.5%	0.0%	0.0%
Middle 20%	9.0%	9.5%	75.0%	6.5%	0.0%
Upper 20%	0.0%	0.0%	6.5%	89.0%	4.5%
Top 20%	0.0%	0.0%	0.0%	4.5%	95.5%
China	Bottom 20%	Lower 20%	Middle 20%	Upper 20%	Top 20%
Bottom 20%	34.5%	44.5%	18.5%	2.5%	0.0%
Lower 20%	36.0%	36.5%	24.0%	3.5%	0.0%
Middle 20%	29.0%	29.5%	29.0%	12.5%	0.0%
Upper 20%	0.5%	3.0%	15.0%	73.0%	8.5%
Top 20%	0.0%	0.0%	0.0%	8.5%	91.5%
France	Bottom 20%	Lower 20%	Middle 20%	Upper 20%	Top 20%
Bottom 20%	66.0%	32.5%	1.5%	0.0%	0.0%
Lower 20%	46.5%	44.0%	9.5%	0.0%	0.0%
Middle 20%	1.5%	9.5%	82.0%	7.0%	0.0%
Upper 20%	0.0%	0.0%	7.0%	89.0%	4.0%
Top 20%	0.0%	0.0%	0.0%	4.0%	96.0%
Germany	Bottom 20%	Lower 20%	Middle 20%	Upper 20%	Top 20%
Bottom 20%	68.5%	21.5%	10.0%	0.0%	0.0%
Lower 20%	59.5%	25.5%	15.0%	0.0%	0.0%
Middle 20%	14.0%	11.0%	69.5%	5.5%	0.0%
Upper 20%	0.0%	0.0%	5.5%	90.0%	4.5%
Top 20%	0.0%	0.0%	0.0%	4.5%	95.5%
Italy	Bottom 20%	Lower 20%	Middle 20%	Upper 20%	Top 20%
Bottom 20%	69.0%	30.5%	0.5%	0.0%	0.0%
Lower 20%	36.5%	53.5%	10.0%	0.0%	0.0%
Middle 20%	0.0%	10.5%	83.0%	6.5%	0.0%
Upper 20%	0.0%	0.0%	6.5%	90.0%	3.5%
Top 20%	0.0%	0.0%	0.0%	3.5%	96.5%
Japan	Bottom 20%	Lower 20%	Middle 20%	Upper 20%	Top 20%
Bottom 20%	75.5%	24.5%	0.0%	0.0%	0.0%
Lower 20%	24.5%	60.0%	15.5%	0.0%	0.0%
Middle 20%	0.0%	15.5%	74.5%	10.0%	0.0%
Upper 20%	0.0%	0.0%	10.0%	83.0%	7.0%
Top 20%	0.0%	0.0%	0.0%	7.0%	93.0%

UK	Bottom 20%	Lower 20%	Middle 20%	Upper 20%	Top 20%
Bottom 20%	56.5%	39.0%	4.5%	0.0%	0.0%
Lower 20%	44.0%	41.0%	15.0%	0.0%	0.0%
Middle 20%	9.5%	10.0%	73.0%	7.5%	0.0%
Upper 20%	0.0%	0.0%	7.5%	87.5%	5.0%
Top 20%	0.0%	0.0%	0.0%	5.0%	95.0%

US	Bottom 20%	Lower 20%	Middle 20%	Upper 20%	Top 20%
Bottom 20%	39.0%	45.5%	12.0%	3.5%	0.0%
Lower 20%	31.5%	44.5%	21.0%	3.0%	0.0%
Middle 20%	30.0%	42.5%	20.0%	7.5%	0.0%
Upper 20%	2.0%	4.0%	8.0%	83.5%	2.5%
Top 20%	0.0%	0.0%	0.0%	2.5%	97.5%

Appendix 3: Proof of a diminishing thickness index as w_{min} drops

The complementary CDF or tail distribution (defined as 1 minus the CDF) which follows a power law can be written as:

$$\Pr(W > w) \equiv 1 - \Phi(w) = w^{-\phi}$$

If the entire distribution follows the same power law, then for any $w_{min} < w$, we have:

$$\frac{\Pr(W > w)}{\Pr(W > w_{min})} = \left(\frac{w}{w_{min}}\right)^{-\phi}$$

Now assume that, for all values $w \in (0, \underline{w})$ including w_{min} , the distribution follows an exponential law. The cutting-off point \underline{w} is where the two distributions meet. The complementary CDF is therefore:

$$\Pr(W > w) \equiv 1 - \Psi(w) = \psi^{-w} \text{ for } w \in (0, \underline{w})$$

The PDFs of the two distributions can be obtained by differentiating CDF, so:

$$\text{Power law: } \phi(w) = \Phi'(w) = \phi w^{-\phi-1}$$

$$\text{Exponential law: } \psi(w) = \Psi'(w) = \psi^{-w} \ln \psi$$

We now prove the following theorem.

[Theorem] The estimated thickness index ϕ diminishes as more observations from exponential distribution are added in the sample.

We break down the proof into two steps. First, the difference between the two distributions is shown. Second, the effect of the difference on the estimated ϕ is derived.

[Step 1]

The PDF of the exponential part is lower than the power-law counterpart for $w \in (0, \underline{w})$. This can be shown by resorting to two special points: $w = 0$ and $w = \underline{w}$.

	$\phi(w)$		$\psi(w)$
$w = 0$	$\phi(0) = \infty$	$>$	$\psi(0) = \ln \psi$
$w = \underline{w}$	$\phi(\underline{w}) = \phi \underline{w}^{-\phi-1}$	$=$	$\psi(\underline{w}) = \psi^{-\underline{w}} \ln \psi$

Both PDFs are continuous and monotonic, so $\phi(w) \geq \psi(w)$ for $w \leq \underline{w}$. We use the following figure to show the intuition of the proof of step 1. The overall PDF includes the exponential-law part when $w \leq \underline{w}$ and the power-law part when $w > \underline{w}$.

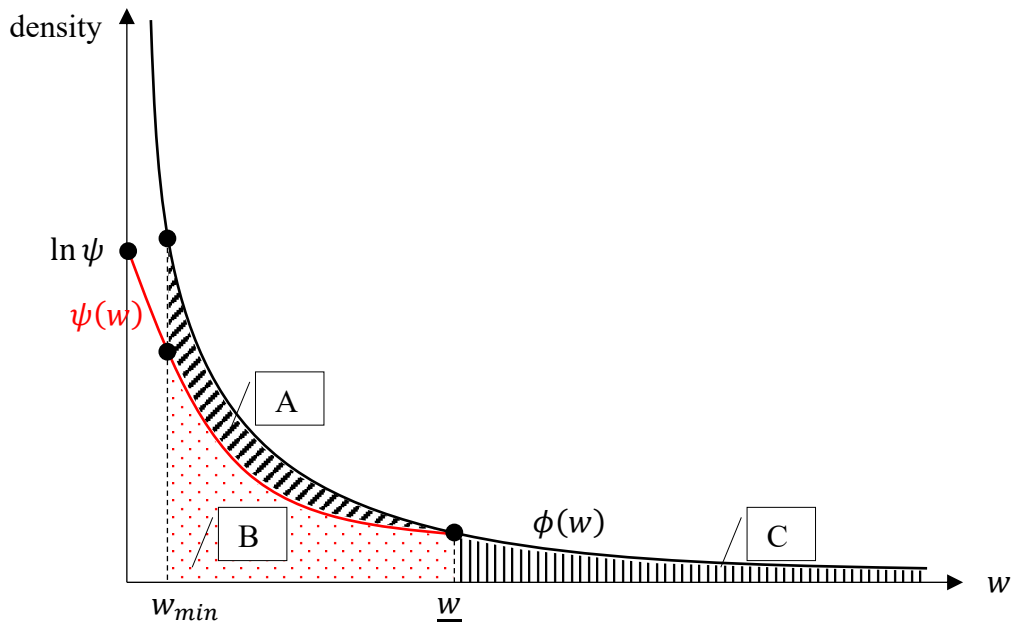

[Step 2]

According to the property of power-law distribution, we have the condition below:

$$\frac{1-\Phi(w)}{1-\Phi(w_{min})} = \left(\frac{w}{w_{min}}\right)^{-\phi}$$

Without losing generality. let's pick $w = \underline{w}$ and use the fact that $1 - \Phi(w)$ is just the integration of the PDF for $(w, +\infty)$. The equation above can be expressed with the help of the illustrations in the figure:

$$\frac{1-\Phi(w)}{1-\Phi(w_{min})} = \frac{C}{A+B+C} = \left(\frac{w}{w_{min}}\right)^{-\phi}$$

If observations below \underline{w} come from an exponential distribution and we force the use of the condition above to estimate the thickness $\hat{\phi}$, then we have:

$$\frac{1-\Psi(w)}{1-\Psi(w_{min})} = \frac{C}{B+C} = \left(\frac{w}{w_{min}}\right)^{-\hat{\phi}} > \frac{C}{A+B+C} = \left(\frac{w}{w_{min}}\right)^{-\phi}$$

Simple analysis leads to the conclusion that $\hat{\phi} < \phi$. ■

In fact, this proof is not limited in exponential distribution. Any thinner distribution than the richest tail will have the same effect. That is why the rolling window estimation of ϕ has a downward trend. A reverse trend is also possible if the distribution is thicker. The intuition behind this theorem is that the thickness of the tail for a combined distribution is boosted if the lower end is thinner.