

Plückebaum, Thomas et al.

Research Report
Green WiFi

WIK-Consult Report

Provided in Cooperation with:

WIK Wissenschaftliches Institut für Infrastruktur und Kommunikationsdienste GmbH, Bad Honnef

Suggested Citation: Plückebaum, Thomas et al. (2021) : Green WiFi, WIK-Consult Report, WIK-Consult GmbH, Bad Honnef

This Version is available at:

<https://hdl.handle.net/10419/251548>

Standard-Nutzungsbedingungen:

Die Dokumente auf EconStor dürfen zu eigenen wissenschaftlichen Zwecken und zum Privatgebrauch gespeichert und kopiert werden.

Sie dürfen die Dokumente nicht für öffentliche oder kommerzielle Zwecke vervielfältigen, öffentlich ausstellen, öffentlich zugänglich machen, vertreiben oder anderweitig nutzen.

Sofern die Verfasser die Dokumente unter Open-Content-Lizenzen (insbesondere CC-Lizenzen) zur Verfügung gestellt haben sollten, gelten abweichend von diesen Nutzungsbedingungen die in der dort genannten Lizenz gewährten Nutzungsrechte.

Terms of use:

Documents in EconStor may be saved and copied for your personal and scholarly purposes.

You are not to copy documents for public or commercial purposes, to exhibit the documents publicly, to make them publicly available on the internet, or to distribute or otherwise use the documents in public.

If the documents have been made available under an Open Content Licence (especially Creative Commons Licences), you may exercise further usage rights as specified in the indicated licence.

Green WiFi

Authors:

Dr Thomas Plückebaum

Dr Bernd Sörries

Matthias Wissner

Ahmed Elbanna

Dr Sonia Strube Martins

Ilsa Godlovitch

WIK-Consult GmbH

Rhöndorfer Str. 68

53604 Bad Honnef

Germany

Bad Honnef, March 2021

Imprint

WIK-Consult GmbH
Rhöndorfer Str. 68
53604 Bad Honnef
Germany
Phone: +49 2224 9225-0
Fax: +49 2224 9225-63
eMail: info@wik-consult.com
www.wik-consult.com

Person authorised to sign on behalf of the organisation

General Manager	Dr Cara Schwarz-Schilling
Director	Alex Kalevi Dieke
Director Head of Department Networks and Costs	Dr Thomas Plückebaum
Director Head of Department Regulation and Competition	Dr Bernd Sörries
Head of Administration	Karl-Hubert Strüver
Chairperson of the Supervisory Board	Dr Daniela Brönstrup
Registered at	Amtsgericht Siegburg, HRB 7043
Tax No.	222/5751/0926
VAT-ID	DE 123 383 795

Contents

Figures	III
Tables	IV
Abbreviations	V
1 Management summary	8
2 Introduction	10
3 Fixed data traffic and future bandwidth demand	12
3.1 Fixed data traffic: growth rates, applications and devices	12
3.2 Forecast of WIK market potential model	15
3.2.1 Methodology	15
3.2.2 Applications and bandwidth requirements	16
3.2.3 Allocation to user types	18
3.2.4 Aggregating demand across households	21
3.2.5 Forecast of bandwidth demand in Germany in 2025	22
3.3 Future developments to be expected until 2030	24
3.3.1 E-Health	24
3.3.2 E-Learning	25
4 WiFi technology today and in the near future	28
4.1 WiFi 6 and 6E	29
4.2 Power consumption in WiFi 6 compared to elder generations	31
5 CO₂ footprint of WiFi	33
6 Decline of CO₂ footprint resulting from WiFi in different sectors	39
6.1 Remote working and remote learning	40
6.2 e-Health	42
6.3 Buildings	44
6.4 Transport	46
7 Regulatory framework	49
8 Summarizing the supporting role of WiFi in Green IT	50
References	52
Annex A: Methodology and assumptions of bandwidth demand model	59
Annex B: Detailed considerations for chapter 4 (WiFi technology)	66

B.1 WiFi 4 (IEEE 802.11n)	66
B.1.1 Operating Frequency	66
B.1.2 Capabilities and Benefits	67
B.1.3 Channel Structure	68
B.2 WiFi 5 (IEEE 802.11ac)	69
B.2.1 Operating Frequency	70
B.2.2 Capabilities and Benefits	70
B.2.3 Channel Structure	74
B.3 WiFi 6 (IEEE 802.11ax)	75
B.3.1 Operating Frequency	76
B.3.2 Capabilities and Benefits	77
B.4 WiFi 6E	85
Annex C: Case studies	88

Figures

Figure 1:	Growth of fixed data traffic in Europe	13
Figure 2:	Share of fixed data traffic by applications in Europe (2015)	14
Figure 3:	Share of fixed data traffic by applications in Europe (estimation for 2020)	14
Figure 4:	Internet User Profiles in Germany in 2025	19
Figure 5:	Future development of Virtual Reality in Germany	20
Figure 6:	Bandwidth demand in Germany in 2025	23
Figure 7:	CO ₂ kg per person EU 27 (2018)	34
Figure 8:	Power consumption and energy efficiency per Mbit of the Aruba AP	36
Figure 9:	CO ₂ abatement potential by sector (2030) (in Gt)	40
Figure 10:	Work from home before Corona outbreak	41
Figure 11:	Corona as a trigger to work from home	41
Figure 12:	Smart Home: Different levels of smartness	45
Figure 13:	GHG emissions by main sector in the EU-28, 1990-2017	46
Figure 14:	GHG emissions from transport in the EU	47
Figure A 1:	Methodology of the WIK market potential model	59
Figure A 2:	Internet user profiles in the UK in 2025	64
Figure A 3:	Internet user profiles and share in population in Flanders in 2025	65
Figure B 1:	Channel structure comparison between WiFi 3 (52 carriers) and WiFi 4 (56 carriers)	68
Figure B 2:	Comparison between 20 MHz and 40 MHz channels in WiFi 4	69
Figure B 3:	How WiFi 5 accelerates WiFi 4	71
Figure B 4:	Single-user MIMO vs. Multi-user MIMO	73
Figure B 5:	Spatial reuse per Access Point Vs. Spatial reuse per receiver	74
Figure B 6:	WiFi 4 Channels Vs. WiFi 5 Channels	75
Figure B 7:	Operating frequencies in different WiFi generations	77
Figure B 8:	Key Features of WiFi 6	78
Figure B 10:	Subcarrier spacing change in WiFi 6	80
Figure B 11:	Constellation maps of 256-QAM and 1024-QAM	81
Figure B 12:	Advantage of BSS Colouring	83

Figure B 13:	TWT operation between an AP and 2 STAs	85
Figure C 1:	Methodology for measuring energy costs of telemedicine	90
Figure C 2:	Typical room dimensions in residences considered in the study	91
Figure C 3:	Home energy management systems for smart homes	92
Figure C 4:	Building typology and users' profile of the Centocelle project	93
Figure C 5:	Connection architecture of the Centocelle project	94
Figure C 6:	Average weekly occupancy profile over seven months	95
Figure C 7:	Deployment plan for traffic data collecting system	96
Figure C 8:	Intersection setup	97
Figure C 9:	WiFi in smart traffic light setting	98
Figure C 10:	Network design distribution	99

Tables

Table 3-1:	Household structure in Germany	21
Table 3-2:	Future bandwidth demand in the UK and the Flemish region in % of households	23
Table 4-1:	WiFi Generations	28
Table 4-2:	Comparison between different APs performance in terms of Power Consumption	32
Table 5-1:	Energy and emission intensity for various lifetimes and the relative contribution of the manufacturing stage (in parenthesis)	34
Table 6-1:	Examples of eHealth methods and their potential impacts and health co-benefit	43
Table A 1:	Application categories with their capacity and quality requirements 2025	61
Table B 1:	WiFi Evolution until today	86

Abbreviations

AFC	Automated Frequency Coordination
AI	Artificial Intelligence
Ap	Access Point
AR	Augmented Reality
BES	Battery Energy System
BSS	Basic Service Set
CAGR	Compound Annual Growth Rate
CBTC	Communication-Based Train Control
CCA	Clear Channel Assessment
CCK	Complementary Code Keying
CEPT	European Conference of Postal and Telecommunications Administrations
CES	Consumer Electronics Show
CHLA	Children's Hospital Los Angeles
CO ₂	Carbon Dioxide
CPE	Customer-Premises Equipment
dB	Decibel
DL	DownLink
DSSS	Direct Sequence Spread Spectrum
ECC	European Electronic Communications Committee
EEA	European Environment Agency
EIRP	Effective/Equivalent Isotropically Radiated Power
ER	Extended Range
EU	European Union
EVM	Error Vector Magnitude
EWH	Electric Water Heater
FCC	Federal Communications Commission
FSS	Fixed Satellite Services
FTTB	Fibre to the Building/Basement
FTTH	Fibre to the Home
GHG	Green House Gas
HD	High Definition
HE	Higher Education
HFC	Hybrid Fibre Coax

HFC-gas	Hydrofluorocarbon Gas
HVAC	Heating Ventilation and Air-Conditioning
ICT	Information and Communication Technologies
ICT	Infraestructura Comun de Telecomunicaciones (Spanish in-building infrastructure standard system)
IEEE	Institute of Electrical and Electronics Engineers
IoT	Internet of Things
ISM	Industrial Scientific and Medical
LPI	Low Power Indoor
MAC	Media Access Control
MCS	Modulation and Coding Sets
m-health	Mobile Health
MIMO	Multiple-Input Multiple-Output
ms	milliseconds
MU-MIMO	Multi User- MIMO
MU-OFDMA	Multi User-OFDMA
NGA	Next Generation Access
NHS	National Health Service
OFDM	Orthogonal Frequency Division Multiplexing
OFDMA	Orthogonal Frequency Division Multiple Access
OobE	Out-of-Band Emission
PFC-gas	Perfluorocarbon-gas
PoE	Power over Ethernet
QAM	Quadrature Amplitude Modulation
QoE	Quality of Experience
QoS	Quality of Service
RU	Resource Unit
RX	Receiver
SD	Secure Digital
SIS	Solar Integration System
SISO	Single Input Single Output
SNR	Signal to Noise Ratio
SoC	System on Chip
SU-MIMO	Single User-MIMO
TWT	Target Wake Time
TX	Transmitter

UHD	Ultra High Definition
UL	UpLink
ULS	Universal Licensing System
UTP	Unshielded Twisted Pair
VHC	Very High Capacity
VLP	Very Low Power
VPN	Virtual Private Network
VR	Virtual Reality
WLAN	Wireless Local Area Network

1 Management summary

Accelerating digitization along with the reduction of greenhouse gas emissions are both critical objectives for the European Union at this time. The modern generations of fixed and mobile network technologies FTTH and 5G can make significant contributions to digitization as well as improving energy efficiency compared with legacy technologies. However, both are likely to require the latest Next Generation WiFi technology (WiFi 6) indoor as a cordless tail to enable them to exploit their full potential.

In this study, we explore how WiFi 6 and WiFi 6E can contribute to new applications which help to reduce CO₂ emissions. We also analyse the energy consumption of WiFi 6 and 6E and examine how this new generation technology will support innovative mass-market applications such as Augmented Reality and Virtual Reality.

The COVID pandemic has sharpened awareness of the importance and need for Very High Capacity Networks. However, at the same time, increased use of remote working, the trend towards cloud computing as well as e-learning and e-health services, have highlighted an important additional challenge – namely that Very High Capacity Networks also need indoor infrastructure as a complement. After all, what is the advantage of having gigabit speeds available in the basement of a building or even up to the front door, when due to a lack of a performant indoor infrastructure, the bandwidths received by end-users are limited to a few megabits per second. It should also be noted that wireless connectivity is often a necessity, because there are many devices which are used inside buildings which do not have a wired connection, either because they are new and their presence was not foreseen in the original wiring plans (e.g. sensors) or they are mobile by nature (i.e. cordless phones, smartphones, tablets etc.). The availability of Next Generation WiFi is therefore essential to implement the vision for a European Gigabit society.

According to Cisco, by 2023 in Western Europe 69% of all networked devices will be wired or connected over Wi-Fi and the remaining 31% of networked devices will be mobile-connected. New innovative applications such as Augmented Reality and Virtual Reality are likely to drive increased requirements for bandwidth and quality in indoor infrastructure. Against this background, freeing up additional spectrum in the 6 GHz band (480 MHz) for WiFi can be considered as a first and crucial step to address the envisaged bandwidth demand. In the coming years it will be essential to avoid any regulatory barrier or obstacle which might hamper the development and uptake of new innovative services.

As regards the CO₂ footprint, the total GHG emissions of WiFi account for only a very small share of the ICT sector which itself accounts for about 4% of total GHG emissions from all sources. According to literature and interviews, the power consumption of WiFi 6 is comparable with the technologies that preceded it. However, higher data rates of WiFi 6 lead to significantly improved energy efficiency, enabling more data to be

transmitted while the input of energy stays constant. Furthermore, using the new deep sleep mode (Target Wake Time, TWT) in coordination with the applications can reduce power consumption considerably. Thus, WiFi 6 is significantly more powerful in terms of data capacity and speed compared with previous WiFi generations.

At the same time, WiFi enabled applications (“use cases”) can help to limit GHG emissions in a range of sectors, with significant potential particularly in the fields of remote working and learning, e-Health, buildings and transport. This means that, when the knock-on effects are also taken into account, WiFi 6 and 6E could have a significant net positive effect on the environment.

WiFi requires sufficient frequency space to provide for future bandwidth needs. These bandwidth requirements should be provided well in advance of the increase in demand, enabling suppliers to develop and building owners to provide investment security. Today the EU approach for WiFi 6E with 500 MHz in the 6 GHz band lags significantly behind when compared with the approach to 1,200 MHz taken by other regions such as America and Asia.

In conclusion, WiFi 6 and 6E could make a significant contribution to the GHG emission reduction goals of European Member States, at a time when bandwidth demands are increasing. At the same time, WiFi 6 and 6E should facilitate the widespread uptake of new applications which in turn are associated with significant added value for business and society.

2 Introduction

It is now widely recognised that the full economic and social benefits of digitization can only be achieved if Europe facilitates the widespread deployment of Very High Capacity Networks, which form the backbone of the Gigabit society. Moreover, the COVID pandemic has sharpened awareness of the importance and need for Very High Capacity (VHC) Networks. However, at the same time, increased use of remote working, the trend towards cloud computing as well as e-learning and e-health services, have highlighted an important additional challenge – namely that the concept of Very High Capacity Networks needs to include indoor infrastructure. After all, what is the advantage of having gigabit speeds available in the basement of a building or even at the front door, when due to a lack of a performant indoor infrastructure, the bandwidths received by end-users are limited to a few megabits per second. The availability of Next Generation WiFi is therefore essential to implement the vision for a European Gigabit society.

Modern information and communication technologies (ICT) have been developed not only to satisfy the increasing demand for bandwidth, but also to act as an enabler for new innovative applications which help to combat climate change and environmental damage. Member States and the European Commission have acknowledged that digital solutions enabled by fibre optic networks and modern wireless technologies can support the decarbonisation of sectors and as a consequence reduce the environmental footprint of goods and services.¹ In addition, efforts are being made to improve the environmental impacts of telecommunication technologies themselves, and standardization bodies and vendors have placed considerable focus on developing new technologies which are more energy efficient. A good example of this development is WiFi 6/6E.

In this study, with the aid of interviews and case studies, we explore how WiFi 6 can contribute to new applications which help to reduce CO₂ emissions. Furthermore we analyse the energy consumption of WiFi 6 and examine how this new generation technology will enable new innovative mass-market applications such as AR/VR. While in this study, our focus is on indoor applications, it should be noted that WiFi networks also provide internet connectivity in hot spots and indoor mobile off-loading and thus complement mobile networks.

The structure of this study is as follows

- In chapter 3, we estimate the future bandwidth demand which will have an impact on the capacity provided by WiFi 6 networks.

¹ In 2019, the European Commission adopted a Communication on the European Green Deal. The Communication sets out the Commission's commitment to tackling climate and environmental challenges. At its heart is a target to reduce the EU's greenhouse gas emissions by at least 50% compared the levels of 1990.

- In chapter 4, we describe the technical aspects of different WiFi generations (WiFi 4 to WiFi 6/6E)
- In chapter 5, we elaborate on the WiFi and CO₂ footprint.
- In chapter 6, we illustrate through case studies (transport, buildings, remote working, e-health) how WiFi 6 enables applications with which CO₂ emissions can be reduced.
- In chapter 7, we discuss the role of regulation in making available additional frequencies in Europe for WiFi.

We conclude in chapter 8 with some recommendations on how the interplay between indoor WiFi networks and devices could significantly improve energy efficiency of ICT-based applications and summarise the conclusions of the study.

3 Fixed data traffic and future bandwidth demand

In this chapter, we analyse the development of fixed data traffic in Europe and future bandwidth demand.

KEY FINDINGS

- The availability of Next Generation Access (NGA) networks and the uptake of Very High Capacity Networks (e.g. FTTB/H) has led to continuously expanding fixed data traffic in Europe.
- Forecasts of bandwidth demand in Europe suggest that by 2025, up to 44% of households could demand 1 Gbps down- and more than 600 Mbps in upstream bandwidth. Demand is likely to further increase towards 2035 as a result of the deployment and growing acceptance of new applications.
- Although considerable focus has been given to providing access lines to end-users, it is also important to ensure that the Indoor infrastructure is capable of satisfying current and future demand of end users.
- According to Cisco, by 2023 in Western Europe 69% of all networked devices will be wired or connected over Wi-Fi and the remaining 31% of networked devices will be mobile-connected.
- AR/VR applications in particular are likely to drive increased requirements for bandwidth and quality in indoor infrastructure.
- End user devices as well as other wireless devices within buildings (such as sensors) require powerful high capacity wireless connectivity, which could be considered as a cordless extension of fibre access.

3.1 Fixed data traffic: growth rates, applications and devices

The availability of Next Generation Access (NGA) networks and the uptake of Very High Capacity Networks (e.g. FTTB/H) has led to an expansion in the growth of fixed data traffic in Europe. We expect that higher penetration of fibre optical access networks will provide an additional stimulus for data consumption in all EU member states. In particular the consequences of the current pandemic could have a lasting impact on the acceptance of new services such as remote working and cloud based services.

Figure 1: Growth of fixed data traffic in Europe

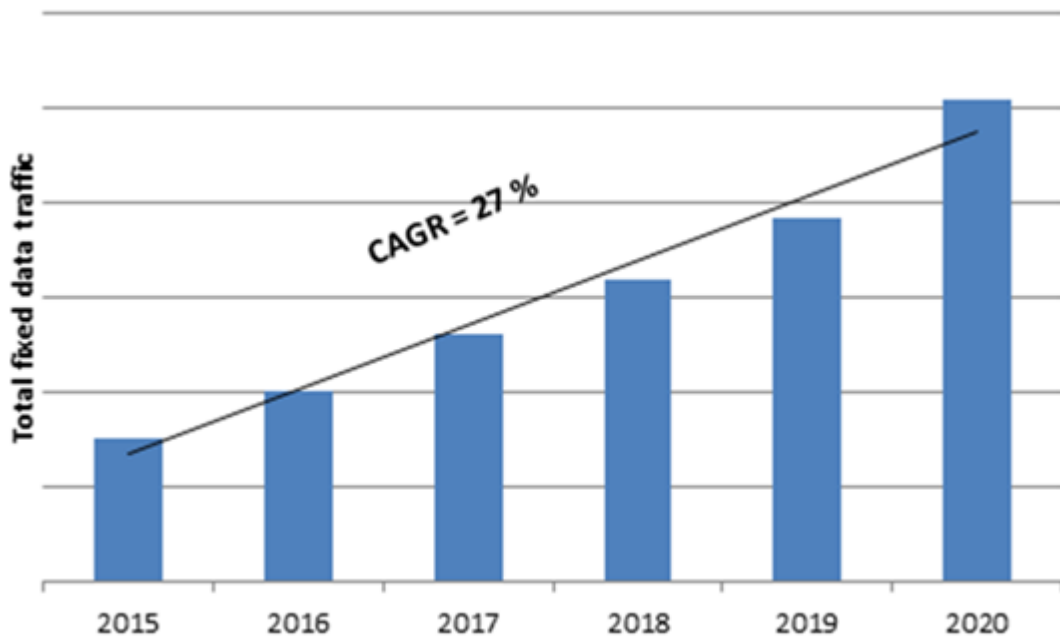

Source: WIK-Consult

The main driver of fixed data traffic is video and TV streaming. When we compare the year 2015 with the estimation for 2020 we see that Video & TV streaming clearly accounts for 70 percent of total data traffic. Increasing competition in the streaming market and expanding consumption of non-linear content is likely to have a long lasting impact on fixed data traffic.²

² See Godlovitch, I.; Hoceped, C.; Lemstra, W.; Plückebaum, T.; Strube Martins, S.; Kroon, P.; Lucidi, S.; Alexiadis, P.; Char, S. (2020).

Figure 2: Share of fixed data traffic by applications in Europe (2015)

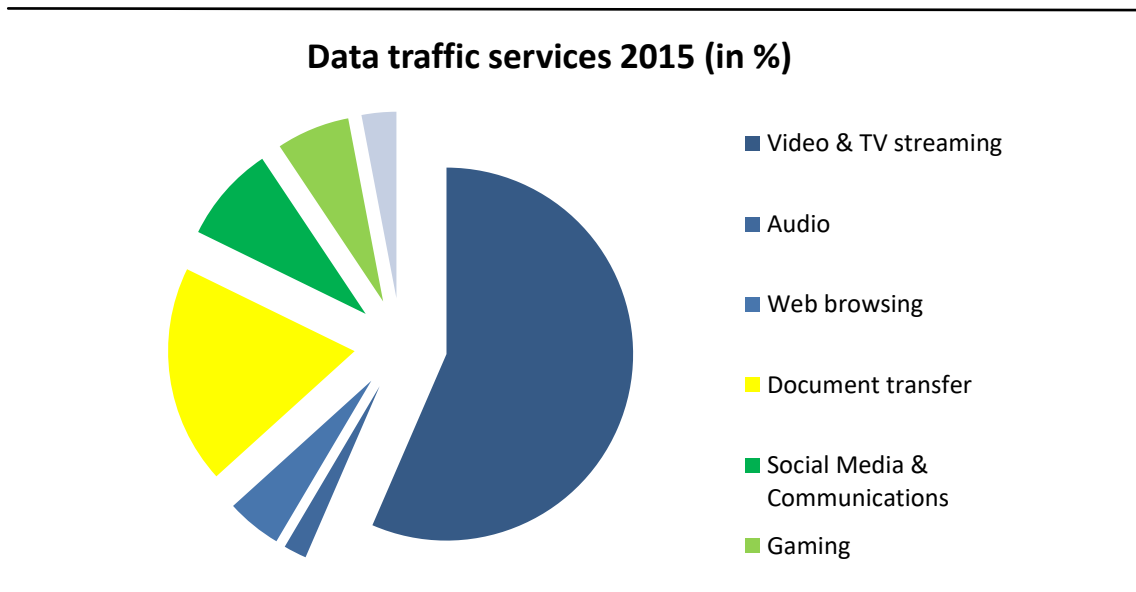

Source: WIK-Consult

Figure 3: Share of fixed data traffic by applications in Europe (estimation for 2020)

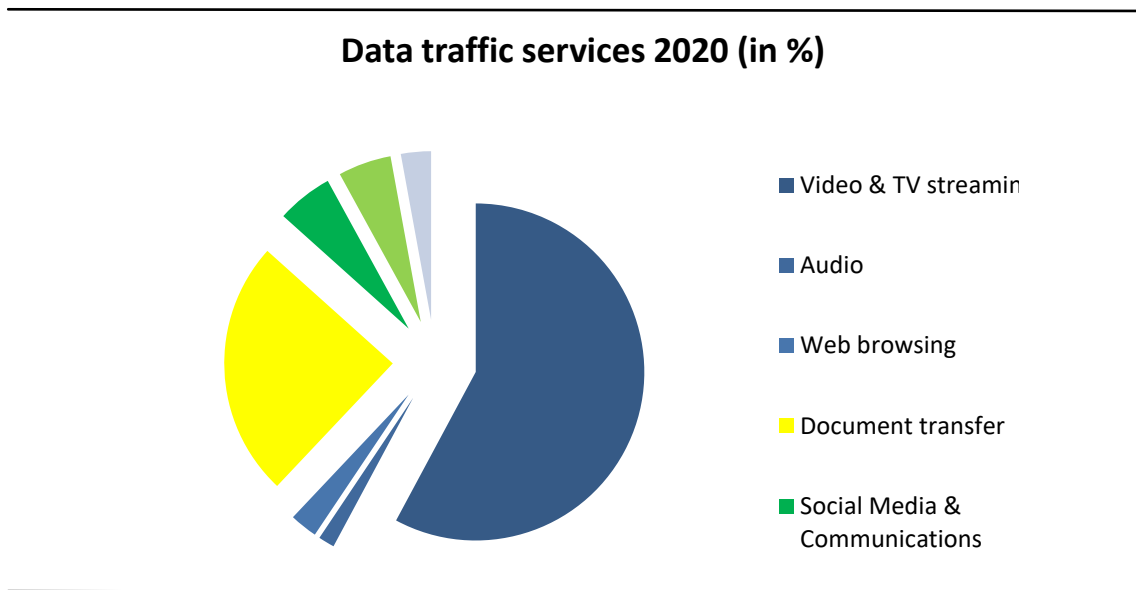

Source: WIK-Consult

Regarding the traffic generated by different devices, it should be noted that a high proportion of devices rely on wireless connections. According to our estimation, approx. 40 percent of fixed data traffic is down- and uploaded by mobile phones. Furthermore, the usage of smart TVs has increased in recent years. We estimate that these devices

consume more than 14 percent of all data, while computers (including laptops) consume approx. 40 percent of all data traffic.

In summary, fixed line data traffic needs to be complemented by cordless – WiFi - indoor networks because mobile devices are typically not connected to a wireline indoor infrastructure. When data traffic increases, this may increase the need for further frequencies to support WiFi networks.

3.2 Forecast of WIK market potential model

3.2.1 Methodology

WIK has developed a 'market potential' model in order to assess how bandwidth requirements may evolve in the near future (i.e. to 2025).³ Originally developed in 2011, this model was revised and updated in 2017⁴ to reflect emerging applications and new developments. The update was made to reflect the bandwidth requirements of future applications, as well as reflecting developments in household usage patterns for broadband.⁵ The WIK market potential model has been applied to Germany, UK and the Flemish region in Belgium. The application of the model in different regions provides additional information on the main drivers of bandwidth demand.⁶

Bandwidth demand and quality requirements of households are important in assessing the frequency requirements of WiFi because

- A high share of households use WiFi for in-building access to support connectivity on their devices. New buildings often are built with in-building wiring which can transmit high bandwidths with a high degree of quality. However, to provide an illustration less than 5% of buildings in Germany have been new-built since 2015.⁷ Inhabitants of existing buildings typically refrain from the high cost of installing new in-building wiring and use WiFi technologies to connect their devices.
- Even when there is the potential to use in-building wiring, there are a number of applications which rely on devices which need wireless access technologies (e.g. tablets and smartphones). This means that even if a household has high capacity in-building wiring, there will always be a need for high capacity WiFi to

³ See Doose, A.-M.; Monti, A.; Schäfer, R. (2011) and Monti, A.; Schäfer, R. (2012).

⁴ See Strube Martins, S.; Wernick, C.; Plückebaum, T.; Henseler-Unger, I. (2017).

⁵ See Strube Martins, S.; Wernick, C.; Plückebaum, T.; Henseler-Unger, I. (2017) and Godlovitch, I.; Plückebaum, T.; Strube Martins, S.; Gantumur, T.; Elixmann, D.; Tas, S.; Arnold, R.; Wernick, C. (2018).

⁶ Strube Martins, S.; Wernick, W. (2020).

⁷ See <https://www.destatis.de/DE/Themen/Branchen-Unternehmen/Bauen/Tabellen/baufertigstellungen.html> and <https://www.destatis.de/DE/Themen/Gesellschaft-Umwelt/Wohnen/Tabellen/wohneinheiten-nach-baujahr.html>

provide indoor connections. In Germany, in 2020 88% of the population (aged >14 years) used a smartphone and 49% a tablet.⁸ According to Cisco, by 2023 in Western Europe 69% of all networked devices will be wired or connected over Wi-Fi and the remaining 31% of networked devices will be mobile-connected.⁹

Against this background, there is a strong demand for WiFi technologies which fulfil the bandwidth and quality requirements for households without high capacity in-building wiring and for devices which require wireless access to the Internet (for example smartphones and tablets).

The model projects the future demand for bandwidth from residential customers on the basis of three parameters:¹⁰

- applications and their bandwidth requirements
- user profiles (i.e. different types of customers) that are to be expected in the future, and the applications that each user profile is likely to use
- population structure expected in 2025 and the distribution of user profiles among the population structure

3.2.2 Applications and bandwidth requirements

The model considers the applications listed below. The list of applications reflects the most important drivers of bandwidth usage and quality requirements in 2025.

- Basic Internet¹¹
- Home-office and VPN¹²
- Cloud Computing
- State of the Art Media and Entertainment (4K, 3D, HD)
- Progressive Media and Entertainment (8K, VR/AR)
- Communication¹³
- Video communication
- Gaming
- E-Health

⁸ <https://www.ard-zdf-onlinestudie.de/geraetenutzung/>

⁹ See Cisco (2020).

¹⁰ Please refer to Annex A for a more detailed analysis of the methodology and assumptions of the model.

¹¹ Basic Internet refers e.g. to surfing the Internet (including e-commerce) and social networks.

¹² Home office and VPN refers to the file exchange and online usage of resources such as software in the context of teleworking.

¹³ Communication refers e.g. to telephony, chats on social networks etc. Video communication includes video telephony, videoconferencing.

- E-Home/ E-Facility¹⁴
- Mobile Offloading¹⁵

The main drivers of bandwidth demand growth are applications such as progressive TV/Virtual Reality, VPN,¹⁶ cloud and gaming. In the area of progressive TV, a significant increase in bandwidths is expected due to the introduction of new technologies such as 8K as well as Augmented and Virtual Reality (AR and VR), which demand higher data transmission rates, low latency and packet loss rates.¹⁷ Facebook's Oculus Quest 2 is an example of a VR headset which targets the streaming and gaming market. The bandwidth and quality requirements of future applications also impact the spectrum requirements for WiFi, particularly since many devices depend on wireless connections.¹⁸

The bandwidth requirements of Home office/VPN are driven by a strongly increasing share of high definition audio-visual content transmitted by Home office/VPN users. The COVID-19 pandemic, which has led to a large number of employees working from home underlines the relevance of high data rates to support the effective use of remote working. Remote working is an important contributor to the reduction of CO₂ emissions (see chapter 6.1).

The main driver of bandwidth demand in terms of speed requirements in gaming is expected to be virtual reality, high-definition graphics and sophisticated software that allows players to play online in a networked environment. These developments are also likely to require high levels of quality of service including low latency.

Cloud computing includes the storage of high-resolution images, movies and data as well as the use of software in the cloud. The growing need for bandwidth in this area results from the increasing amount of data that is transferred via the Internet. While only a few kilobytes of data are needed to transmit a text message, a Full HD¹⁹ video requires several gigabytes of data and requires high data rates if the transmission is to take place without major delays.

The increasing use of e-Health and smart home applications may also generate additional data volumes, potentially in conjunction with cloud computing. While today's data volumes and speed requirements associated with many telemedicine and telecare solutions are straightforward, upcoming e-Health applications are likely to require more advanced forms of connectivity requiring increased bandwidth as well as quality of

¹⁴ E-Home refers to anything in the home that can be controlled remotely by a smartphone, tablet or computer; e.g. a thermostat that 'learns' the desired temperature of a user throughout the day to a washing machine that orders washing powder before it runs out.

¹⁵ WiFi-Offloading of mobile data.

¹⁶ Virtual Private Networks.

¹⁷ Mangiante, S. et al (2017): CAICT and HUAWEI Technologies Co. Ltd (2017): Huawei iLab (2017).

¹⁸ See Quotient Associates (2017): and Qualcomm (2016).

¹⁹ High Definition.

service and/or reliability. For example, virtual reality technology is used to treat certain medical conditions such as dementia and phobias. Interactivity, virtual reality and tactile internet are increasingly used in the area of e-Learning. They all require high bandwidth and quality of service.²⁰

More moderate increases in bandwidth requirements are also expected from services that are prevalent in the market today. For instance, bandwidth requirements for basic Internet and communication will increase, as high-resolution images and videos are increasingly transmitted via the Internet. Bandwidth requirements for current TV applications (termed 'state of the art media') such as 4K, UHD²¹ and video communication are assumed to grow at slower CAGRs.

Apart from the bandwidth requirements of applications, it is important to note that many of the applications used in 2025 not only require high bandwidth, but also low latency, packet loss rates as well as reliable connections. Applications such as e-Health and video communications do not require bandwidths as high as gaming and progressive audio-visual content, but they may still require specific access technologies to satisfy their demand for low packet loss rates and low latency.

3.2.3 Allocation to user types

The WIK market potential model projects the bandwidth needs of broadband households in 2025 based on user categories. These are assumed to have distinct usage patterns in relation to the applications they use.

The increase in demand for new applications (which is reflected in growing shares of user types using those applications) does not always mean that users churn from existing applications to new ones. For example, cloud and smart home applications may be used complementarily (and to some extent simultaneously) by some user types. Likewise, gaming and progressive TV do not substitute for Internet usage, i.e. user types using them do not churn from Internet to gaming and progressive TV but continue to use the Internet.

In the model, there are six user profiles, which make more or less intensive use of digital applications. There are also groups of broadband deniers and users who are exclusively mobile. We assume that three user profiles – the home office user, the digital avant-gardist and the digital professional – use one of the three most bandwidth-intensive applications: VPN, progressive TV and gaming. Two user profiles, the occasional user and the sceptical outsider, are more reluctant to use digital applications. The trend user does not use VPN, 8K or gaming, but relies on a variety of digital applications, including audio-visual communication and e-Health.

²⁰ Godlovitch, I et al. (2019).

²¹ Ultra High Definition.

The model estimates the share of the six user profiles in the population in Germany in 2025.²² In the UK and the Flemish Region the same was done based on specific country and regional data respectively. The results for the share of user categories in population in the UK and in the Flemish Region are presented in the Annex A.

Figure 4: Internet User Profiles in Germany in 2025

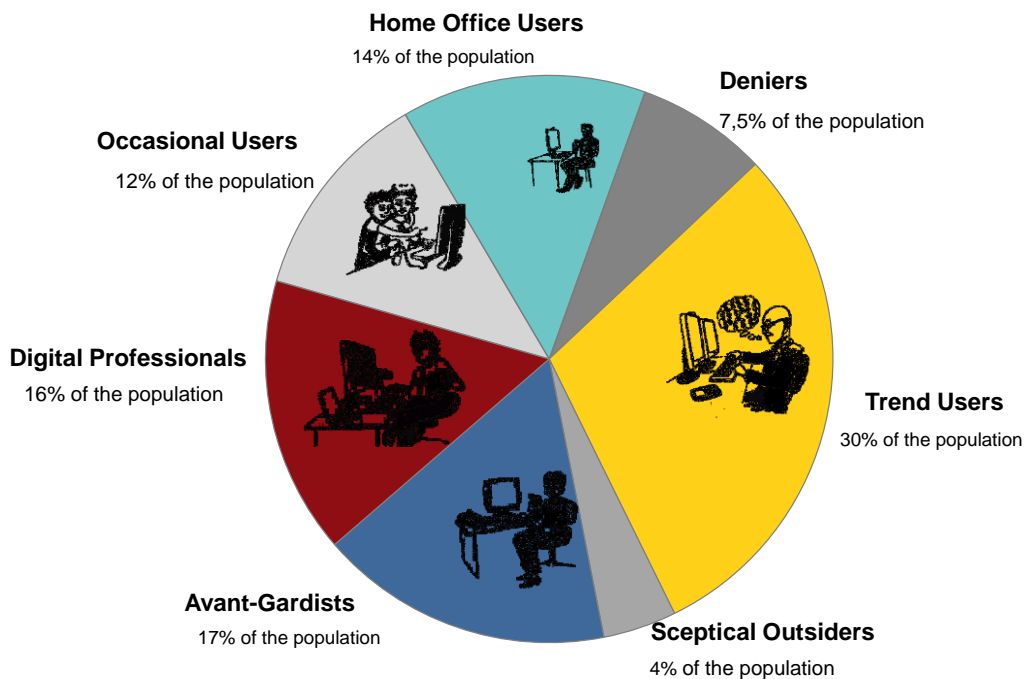

Source: WIK.

Basic Internet and TV in HD quality²³ are already widely used. For example, three quarters of all Internet users in Germany over the age of 14 (76%) watched videos on the internet in 2018. Moreover, around 44% use video streaming, an increase of 6% from the past year.²⁴

E-Health and smart applications are said to have great disruptive potential if the necessary infrastructure is available, especially for developers of attractive applications²⁵. Accordingly, it can be expected that by 2025 the proportion of trend users using applications such as smart homes, conventional TV and video communication will be quite high. In contrast, the share of user types digital avant-garde, professional users and digital professionals is below 20%.

²² This is done based on the D21 Digital Index, supplemented by data from the European Commission, the Federal Statistical Office in Germany and ARD/ZDF on online behaviour and other studies on the internet usage in Germany as well as on usage data of the German population and research on the future development of digital demand,

²³ See Statistisches Bundesamt (2018); Frees, B. and Koch, W. (2018): n p. 398-413.

²⁴ See Kupferschmitt, T. (2018), p. 427-437.

²⁵ See Nationaler IT Gipfel (2015a), Nationaler IT Gipfel (2015b), Bitkom (2014)

24% of Internet users already work in a home office. This share has increased significantly during the COVID 19 pandemic such that the share of 14% (indicating professional home users) is likely to underestimate the role of the home office in the future.

Progressive TV in 8K quality and Virtual Reality applications are used exclusively by the user group of digital professionals, who make up 17% of the population. The use of Virtual Reality applications is of interest to a large proportion of the population. A survey conducted by Bitkom in 2018 showed that every sixth German citizen (16%) aged 14 and above has already tried Virtual Reality. The potential for VR remains high, as currently 17% expect that they will explore this technology in the future²⁶. Figure 5 shows estimates for the revenues with VR applications in Germany in 2023, assuming growth rates of around 20%.

Figure 5: Future development of Virtual Reality in Germany

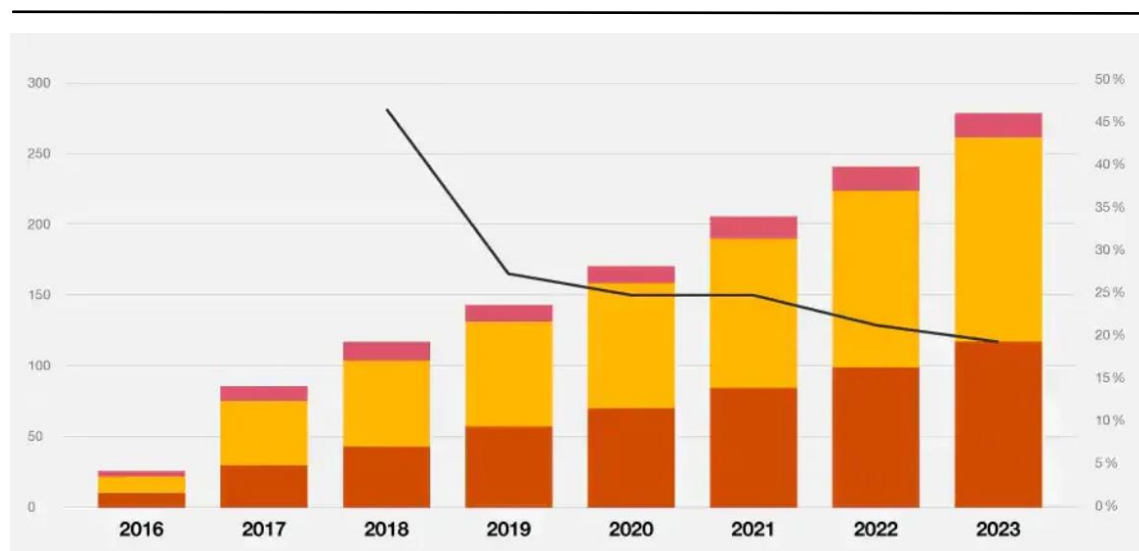

Note: Revenues excl. of hardware revenues (e.g. VR device); they refer excl. to virtual reality applications.

Source: <https://www.pwc.de/de/technologie-medien-und-telekommunikation/studie-deutscher-virtual-reality-markt-waechst-ueber-die-nische-hinaus.html>

The gaming segment is growing rapidly. Between 2013 and 2020 the markets in UK, France, Germany, Italy and Spain grew by 55% in terms of revenues. 51% of the population aged 6-64 in those countries play video games.²⁷ Internet gaming traffic is estimated by Cisco to grow ninefold from 2017 to 2022, a CAGR of 55 percent. Globally, Internet gaming traffic is estimated to be 4 percent of global IP traffic by 2022, up from 1 percent in 2017.²⁸ The German market is one of the biggest markets in

²⁶ See Deloitte; Bitkom (2018), p. 37.

²⁷ ISFE (2020).

²⁸ Cisco (2018).

Europe with half the population playing video games across all age and education groups. People from all social classes and age groups play on the PC, on the console or on the tablet and smartphone. It was reported in 2018 that around 34.3 million Germans played computer or video games, which adds up to more than 40% of the population. Moreover than 20% of the population has expressed an interest in using augmented reality.²⁹ Furthermore, Cisco predicts that gaming traffic will grow 15 fold from 2017 to 2022, thus achieving a compound annual growth rate of 59%.³⁰

Overall, it can be said that in the future there will be a significantly higher proportion of Internet users in the cloud if there are no restrictions on the available bandwidths on the supply side. Cloud computing will then run in the background with technology-oriented user profiles (trend users, digital professionals and avant-gardists). This assumes that security concerns about the use of the cloud will be greatly reduced by 2025, due to better protection mechanisms. The cloud not only serves to store data (high-resolution images and videos, music, etc.), but also enables the use of software and support applications in the E-Home and E-Health sectors and in office environments. As regards Germany, 31% of households used cloud computing services in 2019, marking a growth of 9% from 2016.³¹

It should be noted in this context that the model assumes that there are no technical restrictions, i.e. users have no reason to ensure that software updates, synchronizations and similar functions are carried out in their applications at times when the Internet is not used as intensively.

3.2.4 Aggregating demand across households

The aggregation of bandwidth demand from individual users into household demand, is based on the population size and household structure estimated for 2025. The aggregation of user profiles across households also has an impact on the results of the WIK model as it influences the extent to which applications are used simultaneously in a multi-person household.

Table 3-1 shows the household structure in Germany.³²

Table 3-1: Household structure in Germany

Region / Household members	1	2	3	4+
Germany	43,4%	38,4%	9,1%	9,1%

Source: Statistisches Bundesamt (2011): Bevölkerung und Erwerbstätigkeit, Entwicklung der Privathaushalte bis 2030, Ergebnisse der Haushaltsvorausberechnung; https://www.destatis.de/GPStatistik/servlets/MCRFileNodeServlet/DEHeft_derivate_00012544/512

²⁹ See Game (2019): BIU (2016), pp. 30 ff., Game (2018): p.7.

³⁰ Cisco (2018).

³¹ Eurostat (2019).

³² Statistisches Bundesamt (2011).

4001109004.pdf;jsessionid=1F6F71176E99BFCE7657F67AE47E9F70; ONS (2016): Families and households in the UK: 2016,
<https://www.ons.gov.uk/peoplepopulationandcommunity/birthsdeathsandmarriages/families/bulletins/familiesandhouseholds/2017> and Statistiek Vlaanderen (2017): Meer en kleinere huishoudens in Vlaanderen in de komende 10 jaar,
<https://www.statistiekvlaanderen.be/sites/default/files/docs/proj2018-kleinere-huishoudens.pdf>.

3.2.5 Forecast of bandwidth demand in Germany in 2025

Based on these assumptions Figure 6 shows the forecast of bandwidth demand in Germany in 2025. The forecast bandwidth demands are not primarily driven by individual applications such as TV/Video viewing, but rather by the simultaneous use of digital services in households. This mainly reflects several people in one household using applications with high bandwidth requirements and also, but to a lesser extent, the parallel use of applications/devices, such as simultaneous use of cloud and mobile offloading by one person.

It is important to note that the model forecasts are based on the assumption that there are no technical restrictions, such that users do not have to worry about overloading their broadband connection e.g. when they synchronize their devices with the cloud while they are watching an 8K movie on a TV streaming platform.

By 2025 it is predicted that approximately 30.6 million households, which represents 74.5% of households in Germany will demand top level and higher bandwidths representing downstream bandwidth of 500 Mbps or more. Only 7.5% of households are expected to refuse to subscribe to an Internet connection. The following figure shows the bandwidth demand forecast for fixed broadband access in 2025 in Germany.

Figure 6: Bandwidth demand in Germany in 2025

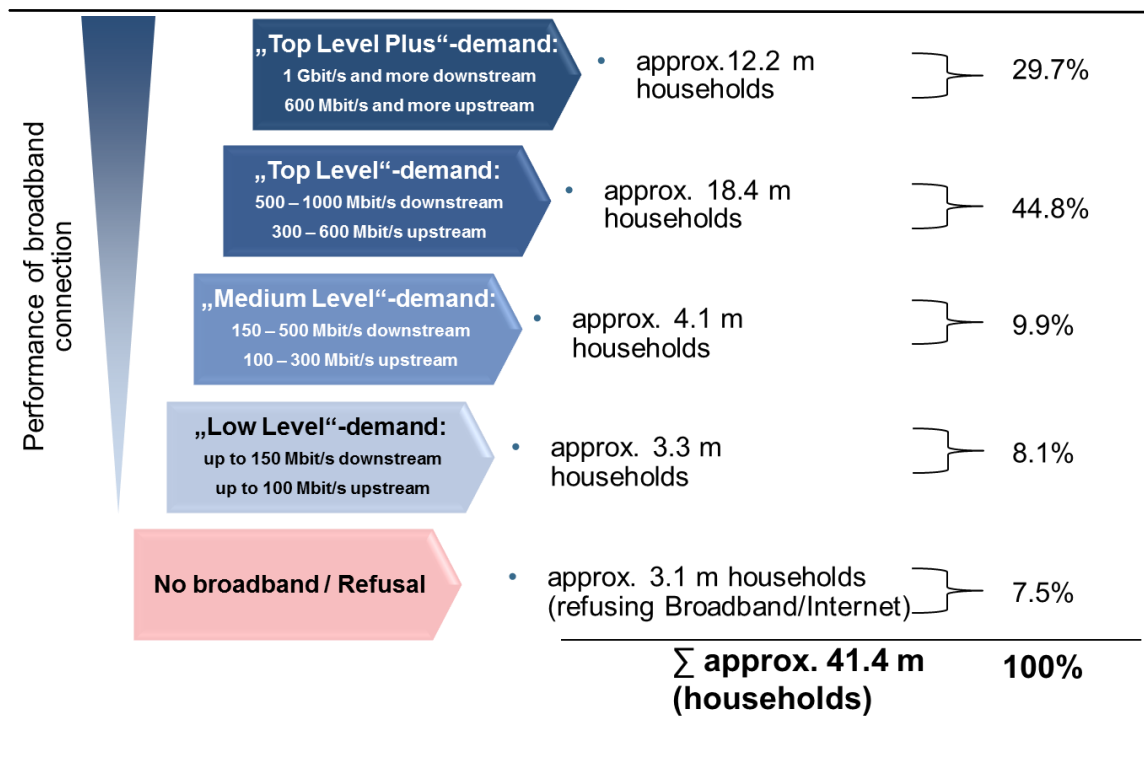

Source: WIK.

The WIK demand model has also been applied to the UK and the Flemish Region (in Belgium). In the UK, it is estimated that 74% of households will demand bandwidths above 500 Mbps and in the Flemish Region 66%. Table 3-2 shows the results for UK and the Flemish Region by bandwidth categories.

Table 3-2: Future bandwidth demand in the UK and the Flemish region in % of households

Region / Download capacity	Gigabit	500 Mbps - Gigabit	150-500 Mbps	Up to 150 Mbps	Deniers
UK	40	34	11	8	7
Flemish region	44	22	15	9	10

Source: Strube Martins, S. and Wernick, W. (2021): Regional differences in residential demand for very high bandwidth broadband internet in 2025, in: Telecommunications Policy, Volume 45, Issue 1, February 2021.

The driver of bandwidth demand in households and associated high WiFi requirements is the increasing penetration of applications with high bandwidth and quality requirements and the simultaneous use of applications in multi-person households.

It should be taken into account that the future demand for gigabit connections may also be driven by quality requirements (low latency and low packet loss rate), which are not reflected in the share of households with top level bandwidth demand in the forecast.

For WiFi requirements, only part of the forecasted demand is relevant if one takes into account that households may also to some extent use in-building wiring to network their devices. However, as already mentioned, the share of buildings with high capacity in-building wiring can be assumed to be less than 5% in Germany. Spain is the leading edge country regarding in-building wiring, having implemented an ICT in-building infrastructure obligation for new constructions and major renovations in 1998 (an obligation later extended to all Member States via the Broadband Cost Reduction Directive). But even here we estimate that in-building infrastructure has only been installed to approximately 40% of all buildings. Thus, we can expect that there will be no Gigabit capable fixed line infrastructure inside a large majority of buildings today and in the near future. Furthermore, for a considerable share of devices, wireless technologies are necessary to provide an Internet connection.

It seems realistic to estimate that more than half of the households in Germany will demand at least 500 Mbps, and against the background of increasing future demand, it is clear that users must have access to high-capability in-building infrastructure. In this context, the future development of WiFi will play an important role when it comes to the penetration of new innovative applications.

3.3 Future developments to be expected until 2030

As outlined above, we observe a continuously increasing demand for applications which require higher bandwidths. In particular we expect the relevance of virtual/augmented reality for e-Learning and e-Health to increase and to be a driver for bandwidth and high quality of service demand. In the following section we further analyse some of these drivers of future demand.

3.3.1 E-Health

Upcoming e-Health applications are likely to require more advanced forms of connectivity involving increased bandwidths quality of service and/or reliability,³³ or raise policy or regulatory questions:³⁴

- **Virtual reality:** Certain medical conditions are treated with VR technology. For instance, VR solutions can help to address some symptoms associated with

³³ Quality of service metrics can be particularly important for the use of Health IT. Latency, reliability, packet loss and jitter can be even more important than bandwidth in the specific solutions, available at: <https://transition.fcc.gov/national-broadband-plan/health-care-broadband-in-america-paper.pdf>.

³⁴ For the following examples see Godlovitch, I et al. (2019).

dementia. For example, at nursing homes, virtual images of fields, farm animals and barns are shown (via optical devices) to older people who grew up in rural areas.³⁵ VR is also used to treat patients with phobias.³⁶ Moreover Augmented Reality may have applications in surgery. Without blocking the surgeon's view, AR can indicate a patient's vital indicators, medical images and provide guidance concerning the next surgical steps.³⁷

- **Big data processing:** The routine aggregation and transmission of patient data including scans and medical records is likely to require considerably higher and symmetric connectivity for healthcare centres than is present today.³⁸
- **Artificial intelligence:** The aggregation of data in the medical field provides significant scope to use AI to analyse patterns and develop algorithms to detect specific medical conditions. One application might be the analysis of scans e.g. in the field of radiology where AI can detect patterns that are invisible to the human eye.³⁹ Another field is AI data analysis from medical device sensors might detect irregularities with pacemakers enabling them to be repaired/replaced more quickly.

E-Health applications which rely on virtual reality, tactile internet⁴⁰ and big data will require more advanced forms of connectivity. The network must be capable of transmitting large volumes of data almost instantaneously. Virtual and augmented reality require a high-resolution feedback system in real time to provide a seamless user experience. Ericsson suggests that a latency of less than one millisecond and a reliability of nearly 100% is required.⁴¹ The use of virtual reality also requires low latencies and bandwidths of potentially more than 200 Mbps.⁴² Today's VR systems require 100-to-200 Mbps to provide only a one-way immersive experience.⁴³

3.3.2 E-Learning

E-learning refers to the use of ICT in all areas of education (pre-school, school, university and continuing vocational education). Applications and instruments are

35 See <https://www.healthline.com/health-news/heres-how-vr-can-help-people-with-dementia#What-the-study-found>.

36 See <https://www.npr.org/sections/13.7/2016/09/01/491991386/can-cute-virtual-reality-spiders-help-reduce-arachnophobia>.

37 See <https://healthcare-in-europe.com/en/news/augmented-reality-is-the-future-of-surgery.html>.

38 See preliminary findings from the study for the European Commission "Smart investments for smart communities", available at: <https://ec.europa.eu/digital-single-market/en/news/cef2-study-workshop-smart-investments-smart-communities>.

39 See <https://www.ncbi.nlm.nih.gov/pmc/articles/PMC6199205/>.

40 The term tactile Internet refers to a network system which is characterised by very low latency and ultra-high reliability, enabling reaction times similar of those of humans. Maier, M. et al. (2016), "The Tactile Internet: Vision, Recent Progress, and Open Challenges", IEEE Communications Magazine, 54(5), 138-145, p.139.

41 See Ericsson (2017).

42 See Wireless World Research Forum (2016). ITU (2014).

43 See Bastug, E. et al. (2017), p.114.

available for all conceivable disciplines and age groups, both for teachers and learners. E-learning should allow greater flexibility in learning and adaptation to specific interests and learning progress.⁴⁴

Innovative technologies can be used to support vocational training. For example:⁴⁵

- **Virtual Reality:** VR can simulate difficult work scenarios that cannot be easily recreated. For instance, safety and emergency training operations can be emulated so that workers can learn how to react in specific crisis scenarios. Some solutions combine VR with immersive environments, such as training for emergency situations for power plants and other critical infrastructure as well as military operations. VR has a strong appeal in these fields due to its cost efficiency and ability to replicate challenges associated with large-scale emergencies.
- **Tactile Internet:** The immersive environments associated with the tactile Internet (including visual, audio and haptic elements) can be used to train medical staff. The teacher is able to feel the learner's movements when they undertake a task involving fine motor skills, and make corrections as necessary. The learner will be able to see, hear and feel the exact movements their trainer has made, be they an engineer, pilot or surgeon. For example, surgeons can learn how to work with human bodies and the direct effects of their treatments are instantly recreated. As a result, the costs of training medical staff can be substantially reduced and the real-time interaction with a living human body can be better replicated.

A Virtual Reality conference enables participation in a meeting from anywhere in the world. Using VR glasses you can access an interactive meeting room with numerous functions, such as using virtual boards together and creating interactive media and models in this virtual environment. Those participating can be pictured as avatars in a virtual setting.

For example, Walmart is using Virtual Reality in a pilot training program in an ongoing collaboration with STRIVR, a leading provider of immersive VR training, and Facebook's Oculus. Participants in Walmart's early VR training program reported a 30% higher training satisfaction using the Rift and associated modules developed by STRIVR, versus other training materials and methods. 70% of employees who trained on Rift outperformed groups trained with other materials and techniques.⁴⁶

⁴⁴ For the following examples see Godlovitch, I et al. (2019).

⁴⁵ A large part of the implementation of innovative technologies like AI and VR focuses on higher education available at:

<https://static1.squarespace.com/static/551b6f21e4b0b4693e02e908/t/5cdb63fe7817f7d645be1f1d/1557881861531/Nordic+%26+Baltic+XR-Edu+Report+4-2019.pdf>.

⁴⁶ <https://www.oculus.com/blog/walmart-expands-vr-training-with-oculus-go/>

In another example, Oculus partnered with Children's Hospital Los Angeles (CHLA) to build a VR simulation that places medical students and staff in rare yet high-risk pediatric trauma situations where split-second decisions determine whether a patient lives or dies. With the help of Virtual Reality, it is possible to replicate these training scenarios in true-to-life fashion.⁴⁷

Interactivity, augmented / virtual reality and tactile Internet all require high quality parameters in terms of broadband access: High bandwidth for interactive and augmented reality solutions and very low latency (less than 1 ms) for tactile internet solutions.

⁴⁷ <https://www.oculus.com/blog/vrs-healthcare-revolution-transforming-medical-training/>

4 WiFi technology today and in the near future

WiFi is a family of wireless network protocols, based on the IEEE 802.11 family of standards, which are commonly used for local area networking of devices and Internet access. WiFi uses multiple parts of the IEEE 802 protocol family and is designed to interwork seamlessly with wired Ethernet. The different versions of WiFi are specified in various IEEE 802.11 protocol standards, with the different radio technologies determining radio bands, the maximum ranges, and speeds that can be achieved. The IEEE 802.11 protocol has gone through various amendments that have been standardized as shown in Table 4-1.

Table 4-1: WiFi Generations

Generation/IEEE Standard	Year of Adoption	Operating Frequency
WiFi 6 (802.11ax)	2019	2.4/5/6 GHz 1–6 GHz (ISM) ⁴⁸
WiFi 5 (802.11ac)	2014	5 GHz
WiFi 4 (802.11n)	2008	2.4/5 GHz
WiFi 3 (802.11g)	2003	2.4 GHz
WiFi 2 (802.11a)	1999	5 GHz
WiFi 1 (802.11b)	1999	2.4 GHz

Source: Wikipedia (2020), WIK

In the past, WiFi versions were identified through a letter or a pair of letters that referred to a wireless standard. However, as these technical names were composed of a long set of numbers followed by random letters, it could be a challenge for non-experts to understand and distinguish between the different generations of WiFi technology. Therefore, the WiFi Alliance — the group that hosts the implementation of WiFi — is planning to change this naming system. The re-branding of these alphanumeric codes will serve to help consumers to make more informed decisions about the networks to which they are connecting. For example, the names for popular wireless standards like 802.11n and 802.11ac which are commonly used when implementing home and office networks will be replaced with single digit numbers that represent the ranking of each WiFi technology, e.g. WiFi 4 (802.11n), WiFi 5 (802.11ac), or WiFi 6 (802.11ax). Amongst the different WiFi standards, there are significant differences between

⁴⁸ The ISM radio bands are portions of the radio spectrum reserved internationally for industrial, scientific and medical (ISM) purposes other than telecommunications.

technologies, operating frequencies, bandwidth, modulation techniques, and data rates. In this chapter we focus on the two most commonly used versions of WiFi (4 and 5) as well as the future versions (WiFi 6 and 6E). For details of the technical characteristics of these generations we refer to Annex B.

KEY FINDINGS

- Significant improvements have been realized over the WiFi generations 1 to 6, from 11 Mbps to 3,7 Gbps per channel
- The 5GHz band (and 6GHz) has been added to the license free frequency band of 2,4 GHz
- Over time new modulation methodologies and channel access methods have been implemented, which have improved the transmission efficiency and –quality significantly
- Modern antenna techniques (MIMO) allow the use of more parallel useable channels (more terminals and capacity) and transmission to dedicated special segments (beamforming), enabling an improved adaption to the spacial environment
- The increased transmission efficiency at more or less constant power consumption increases the energy efficiency of WiFi significantly
- Modern sleep mode techniques such as Target Wait Time (TWT) accelerate this effect, but dedicated and adapted communication time settings are needed to make full use of TWT's capabilities.
- WiFi 6 and 6E will replace previous WiFi generations over time and in doing so, should significantly improve energy efficiency (factor > 1,000 for WiFi 1 to 6).

4.1 WiFi 6 and 6E

WiFi 6 operates in the well-utilised 2,4 and 5 GHz bands and WiFi 6E additionally operates in the 6 GHz band. This means that WiFi 6 is still affected by legacy WiFi traffic, if access points for these technologies serve the same areas. One advantage of remaining in these frequency ranges is that it should allow for a smooth upgrade of legacy terminal devices. However, the common use of the frequency ranges by up to 5 WiFi technology generations operating in the same area can slow down the operation of modern WiFi 6 equipment.

This sharing of frequency bands with legacy WiFi technology will end with WiFi 6E and its use of the empty 6 GHz frequency band. Legacy WiFi technologies are not permitted in this band and thus cannot interfere with transmissions over the more modern technology. The size of the 6 GHz band and thus its potential capacity varies from

continent to continent. Europe intends to give access to the lower half of the 6 GHz band, while the U.S., Canada, most of South America (incl. Brazil) and some Asian Countries also provide the other half of this frequency space, thus providing a spectrum band of a little more than 1GHz.⁴⁹ For more details of the regulatory implications see section 7.

WiFi 6 is designed to meet changing user needs. WiFi 6's performance is expected to exceed that of WiFi 5 Wave 2 by more than three to four times, support higher density with more efficient airtime, support a larger scale of client devices, and provide significant savings in battery usage. While WiFi 6 will be able to deliver theoretical data rate growth of around 37 percent, its largest benefit is the ability to deliver high efficiency performance in real world environments. As the number of clients increase, WiFi 6 will be able to sustain far more consistent data throughput than previous generations of WiFi technology (including WiFi 4 and 5).

The improvements in WiFi 6 are mainly due to two technologies: Orthogonal frequency division multiple access (OFDMA), and Spatial reuse, referred to as High density improvements. Additionally, WiFi 6 provides a slew of new features which should drive performance improvements and optimization across multiple dimensions. More generally, the key features of WiFi 6 fall under four categories: High density, Spectral efficiency, Long range, and Power saving. Each category includes performance improvements which are illustrated in detail in Annex B.

Spectral Efficiency improves the transmission capacity per channel by the 1024-QAM (Quadrature Amplitude Modulation) modulation scheme, provides for larger antenna arrays (8x8 MIMO) and a longer transmission symbol for more resilient transmission.

Power saving can be achieved not only through dedicated transmission characteristics such as improved and power dedicated beamformed radio signals but through a new and significant power saving feature called Target Wait Time (TWT), which offers three receive states for Access Points and terminals. Besides the full operational on-mode it offers the already well known idle-mode and the newly introduced deep sleep mode, which does not listen to the radio during idle times but rather wakes up at predefined intervals and listens. If there is a requirement for communication, the device fully wakes up, but otherwise returns to deep sleep.

The following section elaborates on the power saving and efficiency improving features of WiFi 6. More in-depth discussion of technical details of WiFi 6 and 6E is included in Annex B.

⁴⁹ WiFi (2021)

4.2 Power consumption in WiFi 6 compared to elder generations

WiFi APs are typically solid state devices and do not have moving parts. As a result, their power consumption is continuous, as they are usually left on 24 hours a day to provide uninterrupted Internet access. WiFi devices that support MIMO features can consume a great deal of power compared to their SISO predecessors. Much of the difference is due to the larger number of amplifiers used in the MIMO supporting devices. Each transmitting radio chain requires a power amplifier to boost the signal before sending it out the antenna, while each receive chain uses a low-noise amplifier to bring the signal directly off the antenna up to a level that it can be used by the remainder of the components in the chain. Additional components in the transceiver chain also consume power. By turning off whole receive chains, substantial power saving is possible.

Power saving in WiFi networks can be achieved by minimizing the time the transceiver is active, i.e. transmitting or receiving data, and by maximizing the time spent in the power-saving mode, i.e. either idle or sleep mode. In the active mode, a station is fully powered, thus it can send and receive frames at any time. Establishing a data transmission channel means that one of the two points of the communication will be the transmitter (and/or receiver) and the other will be the receiver (and/or transmitter). In the power-saving mode, the station can be in one of the two states, sleep state or an idle state. For most of the time spent in the power-saving mode, a station remains in the sleep mode, consuming very little power compared to the full active mode. Transition to the idle state is only made for listening to the management frames, called beacons, at certain intervals and for receiving frames from the AP⁵⁰.

Power consumption in WiFi 6

The emergence of IoT-centric WiFi 6 chipsets that can efficiently and reliably address smart home, industrial, and other IoT market requirements support the next generation of low-power WiFi networks. WiFi 6 has already seen strong growth for battery-powered applications, driven by increased adoption of WiFi devices. WiFi 6 will enable these products/devices to integrate improved power consumption and efficiency, along with enhanced performance and robustness. Hence low-power WiFi 6 devices are the next step in the evolution of WiFi in battery-constrained applications. As detailed in Annex B.3.2.6, WiFi 6 introduced the TWT mechanism, defining a specific time at which an individual STA can gain media access, in which the STA and AP can exchange information, which includes the activity duration estimate. As a result, the AP can reduce its power consumption, entering sleep mode before the TWT.

WIK has collected and analysed data describing the performance of the different WiFi 4, 5, and 6 devices (APs) in terms of their power consumption as shown in Table 4-2. We

⁵⁰ Gast (2012).

took an example of the highest performance WiFi APs from the same producer (Aruba) to provide a like-for-like comparison.

Table 4-2: Comparison between different APs performance in terms of Power Consumption

WiFi Generation	AP Model	AP technical specifications	Power per device (W)		
			on-mode	idle-mode	deep sleep
WiFi 4 + WiFi 5	Aruba 340	Dual Band, 4x4 MIMO in 5 GHz and 2x2 MIMO in 2.4 GHz	20.4	11	N/A
	Aruba 310	Dual Band, 4x4 MIMO in 5 GHz and 2x2 MIMO in 2.4 GHz	12.7	5.9	N/A
WiFi 6	Aruba 550	Dual/tri-radio, 5 GHz and 2.4 GHz with 4x4 MIMO in all bands	32.6	15.1	3.6
	Aruba 530	Dual Band 5 GHz and 2.4 GHz with 4x4 MIMO in both	23.3	14.3	3.6
	Aruba 510	Dual Band, 4x4 MIMO in 5 GHz and 2x2 MIMO in 2.4 GHz	16	9.7	1.5
	Aruba 500	Dual Band, 2x2 MIMO for both 5 GHz and 2.4 GHz	8.9	4.3	1.7

Source: WIK, composed of Aruba Networks datasheets, 2020

This shows that the main energy efficiencies from WiFi 6 Aps arise from the TWT feature, which can support the deep sleep mode, if appropriately designed, and is exclusive to this generation of WiFi. A more detailed power consumption and emission model follows in section 5.

5 CO₂ footprint of WiFi

In this chapter we analyse the CO₂ footprint of WiFi.

KEY FINDINGS

- As the number of WiFi networks increases so does the number of access points (APs) and their absolute power consumption.
- The power consumption of WiFi still accounts for a very small share of total ICT power consumption and should be considered compared to the environmental benefits it brings along.
- WiFi 4, 5 and 6 do not differ significantly in their power consumption but WiFi 6 provides significantly higher data rates.
- Further energy saving with WiFi 6 is possible when the APs and end user devices are automated and optimized so as to ensure that they will only wake up when they are really needed.
- In the future, algorithms for APs and end user devices should be programmed in a way that minimizes power flows without reducing service quality.

The total impact of WiFi on carbon emissions is limited. While the impact of the total ICT sector is estimated to account for about 3.7 to 3.8 percent,⁵¹ our calculations find a share of GHG emissions in Europe for WiFi use in households of around 0.19 %. Compared with the benefits expected from ICT (cp. section 6) this is negligible. Figure 7 shows the big picture for the EU 27 for 2018. The share of ICT (118 kg) is limited compared to the possible benefits arising from it (section 6).

⁵¹ Cp. Shift project (2019), p. 4 and ICT carbonfootprint: <https://ictfootprint.eu/en/about/ict-carbon-footprint/ict-carbon-footprint>.

Figure 7: CO₂ kg per person EU 27 (2018)

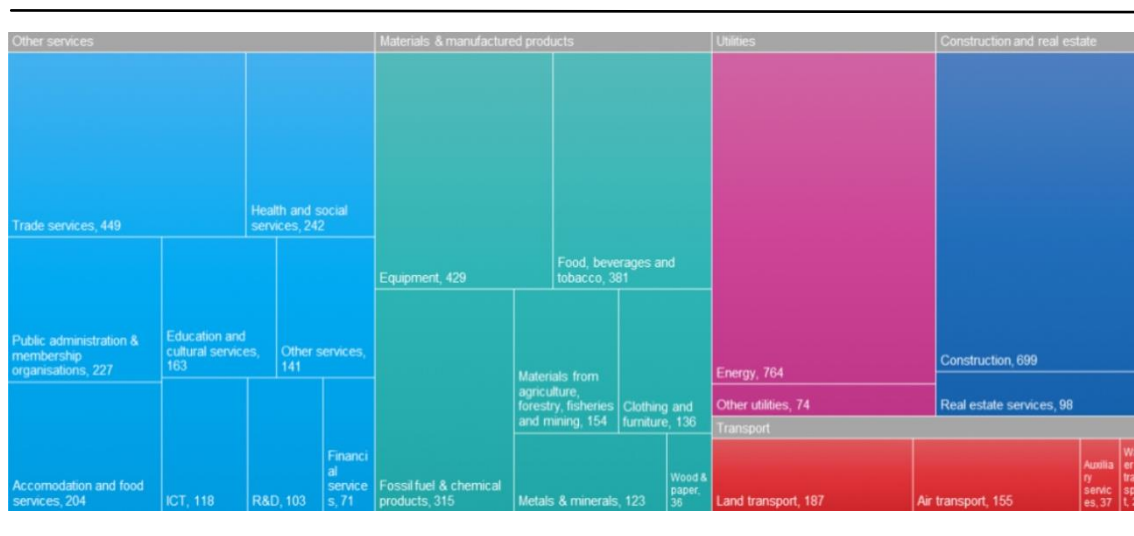

Source: Eurostat, available under: https://ec.europa.eu/eurostat/statistics-explained/index.php/Greenhouse_gas_emission_statistics_-_carbon_footprints#Products_with_largest_contribution_to_the_carbon_footprint, last access: 18/02/2021.

WiFi networks are responsible for CO₂ emissions over their whole life cycle, from manufacturing and transport to usage. As Sikdar (2013) shows, the share of energy consumed and CO₂ emissions during manufacturing naturally decreases with the life time of the components. This is clearly visible in Table 5-1.

Table 5-1: Energy and emission intensity for various lifetimes and the relative contribution of the manufacturing stage (in parenthesis)

Device	Energy Intensity (KWh)					Emission Intensity (kg-CO ₂)				
	1 year	2 years	3 years	5 years	10 years	1 year	2 years	3 years	5 years	10 years
Switch	88.79 (80.06%)	106.49 (66.75%)	124.20 (57.23%)	159.61 (44.53%)	248.14 (28.65%)	21.25 (49.17%)	32.05 (32.60%)	42.85 (24.38%)	64.45 (16.21%)	118.45 (8.82%)
Access Point	63.89 (61.94%)	88.21 (44.86%)	112.52 (35.17%)	161.15 (24.56%)	282.74 (14.00%)	23.94 (38.06%)	38.77 (23.50%)	53.60 (17.00%)	83.26 (10.94%)	157.41 (5.79%)

Source: Sikdar (2013), p. 92.

Because of this decreasing share in the lifecycle of components and because we expect similar results for devices of different WiFi generations for manufacturing and transport, we focus on access points and their power consumption, because this is expected to be the main source of energy saving.

As the number of WiFi networks increases so does the number of access points (APs) and their absolute power consumption. As long as power generation is not entirely covered by renewable energy resources this will contribute to CO₂ emissions. However,

most WiFi connections are not needed 24 h a day, which offers potential for energy savings.⁵²

Silva et al. (2019) have conducted an experimental study, comparing enterprise WiFi APs of the three different vendors. The study includes WiFi up to generation 5. One result they found was that “the rationale that higher data rates always use more power was not verified; according to our study, in some configurations, higher data rates for some IEEE 802.11 standards use in fact the same power level or even less power than lower data rates. Due to this, higher data rates are always more energy efficient configurations.”⁵³

This is, for example, shown when looking at the power consumption performance of the Aruba AP for different WiFi standards, different modes (RX: Receiving Frames, TX: Transmitting Frames) and different frequency ranges in Figure 8.

⁵² Silva et al. (2019).

⁵³ Silva et al. (2019), p. 96865.

Figure 8: Power consumption and energy efficiency per Mbit of the Aruba AP

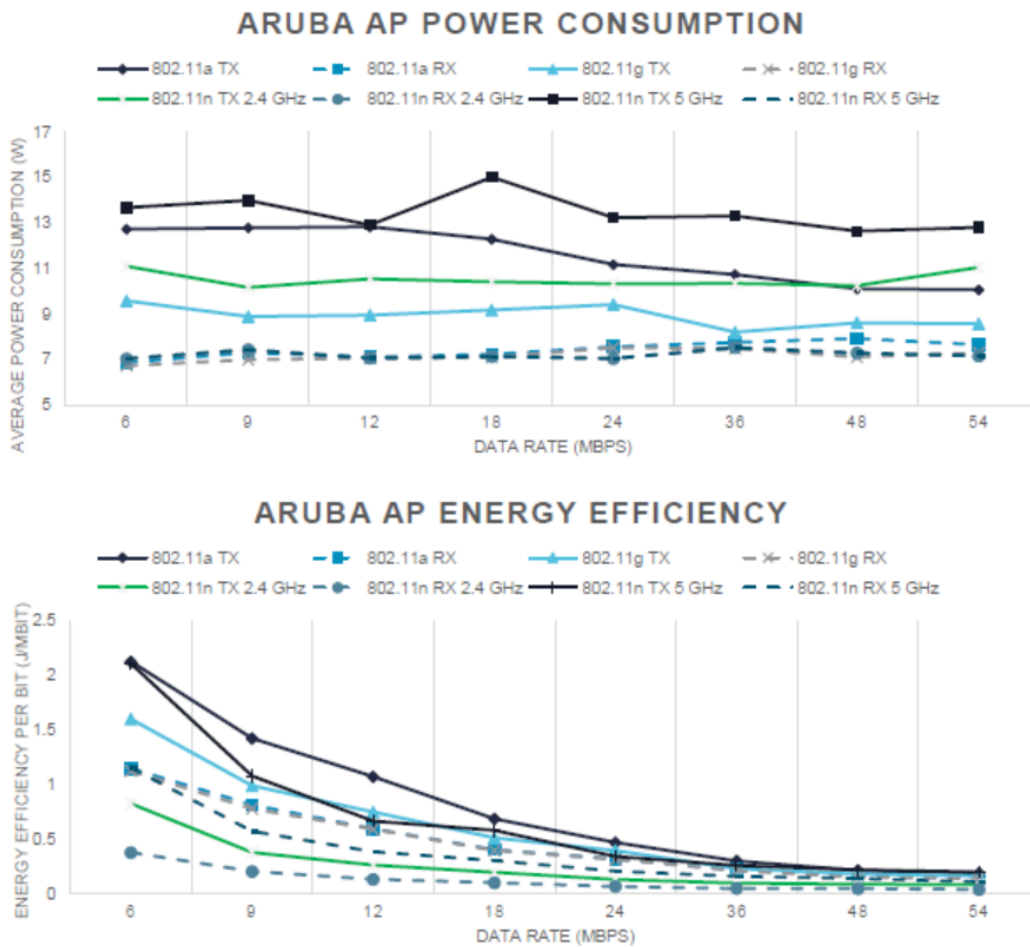

Source: Silva et al. (2019), p. 96863.

As the absolute power consumption is more or less stable for higher data rates, energy efficiency (J/Mbit) increases with increasing data rates.

Another result was that it makes sense to transmit data fast (using high data rates) and then fall back to an idle or sleep mode, because this is where the most energy savings are possible.⁵⁴ This possibility is a main feature of WiFi 6.

It is not clear, however, for how long the APs will actually be in idle or sleep mode as this would require there being no connection to any CPE. This might either be achieved by the end user, defining times when the AP is in sleep mode, or through an algorithm that oversees all CPEs connected to an AP and optimizes power consumption. A challenge is that, while it can be assumed that only a very small proportion of users is concerned by the power configuration of their APs, automated power configurations do

⁵⁴ Silva et al. (2019), p. 96855.

not yet exist. Operators report that much of the communication behaviour in WiFi networks is driven by the terminal equipment, especially by always-on smartphones, hosting a variety of Apps, which establish uncontrolled communications and thus wake up the Access points, even when there is no need. Therefore it cannot be definitively concluded, what are the usage patterns of APs and thus their power consumption.

For this reason we have assumed average power rates that have been found in a real-world test and are backed by claims made by manufacturers.

We refer to a real environment test that compared the WiFi 5 Fritz!Box 7590 and the WiFi 6 Asus RT-AX88U under the same conditions.⁵⁵ In terms of power consumption the testers found no significant differences. While the WiFi 5 device had a power input of 8 W (without data traffic), the WiFi 6 device consumed 9 W in the same mode. These figures correspond with the indication of the manufacturers. While AVM states an average power consumption of 9 to 10 W for its Fritz!Box⁵⁶, the Asus router consumes 9.8 W on average.⁵⁷ This is also consistent with expert interviews that showed that market actors do not see differences in the average power consumption of the different WiFi generations.

From these figures it becomes clear that the overall power consumption of both devices are similar. For the EU 27 this results in the following numbers: The WiFi 5 Fritz!Box 7590, if it was used by all EU citizens at home, would lead to a power consumption of 25,825 GWh and 6,069 Mt of carbon emissions per year, while the Asus device would account for 26,640 GWh and 6,260 Mt of carbon emissions.⁵⁸

However, with respect to increasing future bandwidth demand (cp. section 3) another figure might be more relevant, namely the power consumption per data volume. Higher electrical power can then be compensated through higher data rates, i.e. the user gets a better service with the same input (power consumption).

Comparing the two devices with respect to their data rates, the WiFi 6 device performs significantly better than the WiFi 5 device. The data rates in the above described test differ by a substantial factor. While the Fritz!Box 7590 attains a data rate of 1,733 MBps in the range of 5 GHz, the Asus RT-AX88U achieves 4,804 MBps. In the range of 2,4 GHz, the Fritz!Box achieves 800 Mbps and the Asus 1,148 MBps.⁵⁹

⁵⁵ <https://www.computerweekly.com/de/feature/80211ax-Test-Wi-Fi-5-FritzBox-versus-Wi-Fi-6-Asus-Router>

⁵⁶ https://avm.de/service/fritzbox/fritzbox-7590/wissensdatenbank/publication/show/138_Stromverbrauch-der-FRITZ-Box/#:~:text=Die%20Leistungsaufnahme%20betr\u00e4gt%20durchschnittlich%209%20-%2010%20Watt%20und%20maximal%2030%20Watt.

⁵⁷ <https://www.techstage.de/test/wlan-6-router-asus-rt-ax88u-im-test-schnell-und-teuer/mh6v8wy>.

⁵⁸ We assume that there is a repeater in every second room that has the same power consumption as the corresponding device.

⁵⁹ <https://www.computerweekly.com/de/feature/80211ax-Test-Wi-Fi-5-FritzBox-versus-Wi-Fi-6-Asus-Router>

With respect to energy efficiency, this means that the Asus WiFi 6 device performs much better. The energy input per GB (J/GB) is 13.16 compared to 30 J/GB for the WiFi 5 Fritz!Box. In this respect there is an increase in energy efficiency by a factor of 2.27.

Another feature of WiFi 6 is that “target wake times” between AP and stations⁶⁰ can be agreed.⁶¹ This means that devices can negotiate at which times they communicate with APs, so that they carry out “frame exchanges in predefined service periods.”⁶² This not only increases spectral efficiency because overlapping between users is reduced but also saves battery life in devices and thus energy.⁶³ A main application area of this feature is IoT, where devices or sensors only transmit data in a few minutes or seconds per day.⁶⁴

It is clear that there is potential for increased power use for WiFi 6 as a result of increasing data rates. However, substantial energy savings are possible when the APs and end user devices are automated and optimized in a way that the APs will only wake up, when they are really needed. At the moment the dominant approach is still to have the APs working 24 h i.e. they consume electricity even when they are not “working”. In the future, algorithms for APs and end user devices should be programmed in a way to minimize power flows without reduction in service quality.

The positive effect of WiFi can further be understood by taking into account use cases for WiFi in sectors where energy can be saved. Examples for such sectors are given in the case studies in the following section.

⁶⁰ See Annex B.3.2.6

⁶¹ Huang (2018).

⁶² Cisco (without date): Target Wake Time, p.1, available at: https://www.cisco.com/c/en/us/td/docs/wireless/controller/9800/17-2/config-guide/b_wl_17_2_cg/target_wake_time.pdf, last accessed: 02/12/2020.

⁶³ Huang (2018).

⁶⁴ Lade et al. (2018).

6 Decline of CO₂ footprint resulting from WiFi in different sectors

In this chapter we explain how WiFi can contribute to reducing CO₂ emissions. Smoother processes using less energy provide an opportunity to save energy in different sectors.

KEY FINDINGS

- WiFi is essential for *remote working* and *remote learning*, resulting in traffic reduction by telecommuting in significant shares. For Europe our estimate is that between **515 and 870 Mt CO₂ could be saved already with two additional days of home working** compared to the pre-corona situation.
- In the *health sector*, *virtual visits* to hospitals and doctors save time and avoid traffic, and thus reduce CO₂ emissions.
- Home office, E-learning, remote workshop and video consultation often require *high resolution video VR support*
- With regards to **buildings** WiFi solutions support *Smart Home Applications*, saving energy use and optimize *low or zero carbon energy sources*, switches off *unused rooms, idle devices, controls heating and air conditioning in line with wheather conditions etc.*
- WiFi helps improving *traffic* processes, i.e. by reducing *road traffic congestion, traffic light managing, smart parking, intelligent public transport and more.*

Generally, the potential of ICT to save energy and GHG emissions is huge. The GeSi report (2015) estimates that ICT enables benefits 9.7 times higher than its own CO₂ emissions. According to the report, 12 GT of CO₂ could be saved worldwide by 2030. Figure 9 shows the contribution by different sectors.

Figure 9: CO₂ abatement potential by sector (2030) (in Gt)

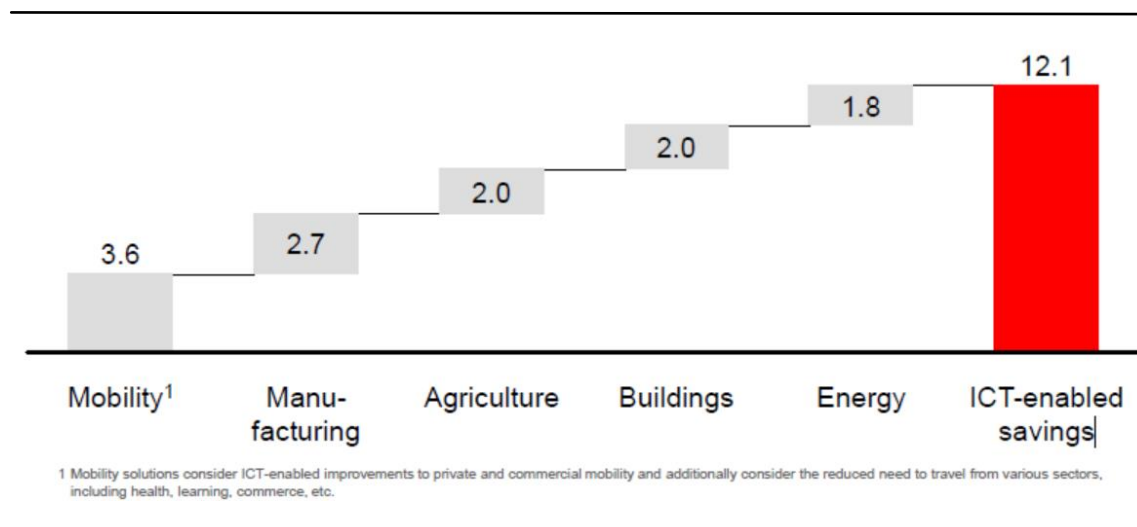

Source: Gesi (2015), p. 17.

We examine the fields of remote working and learning, e-health, buildings and transport to illustrate the potential for WiFi to support such developments. We show what impact each sector has on greenhouse gas emissions in Europe and how WiFi can help to tackle the challenges. Single case studies for every sector showing the GHG reduction potential of WiFi are described in Annex C.

6.1 Remote working and remote learning

Remote working and learning have become the standard – where possible – during the Corona crisis. A positive side-effect of this is that it helps reducing traffic and greenhouse gas emissions.

Remote working has become a form of working that is steadily increasing. It can help to tackle climate change because employees save energy by avoiding travel to their workplace or to events such as business meetings or conferences. However, the share of remote working differed significantly Europe-wide before the Corona outbreak as Figure 10 shows.

Figure 10: Work from home before Corona outbreak

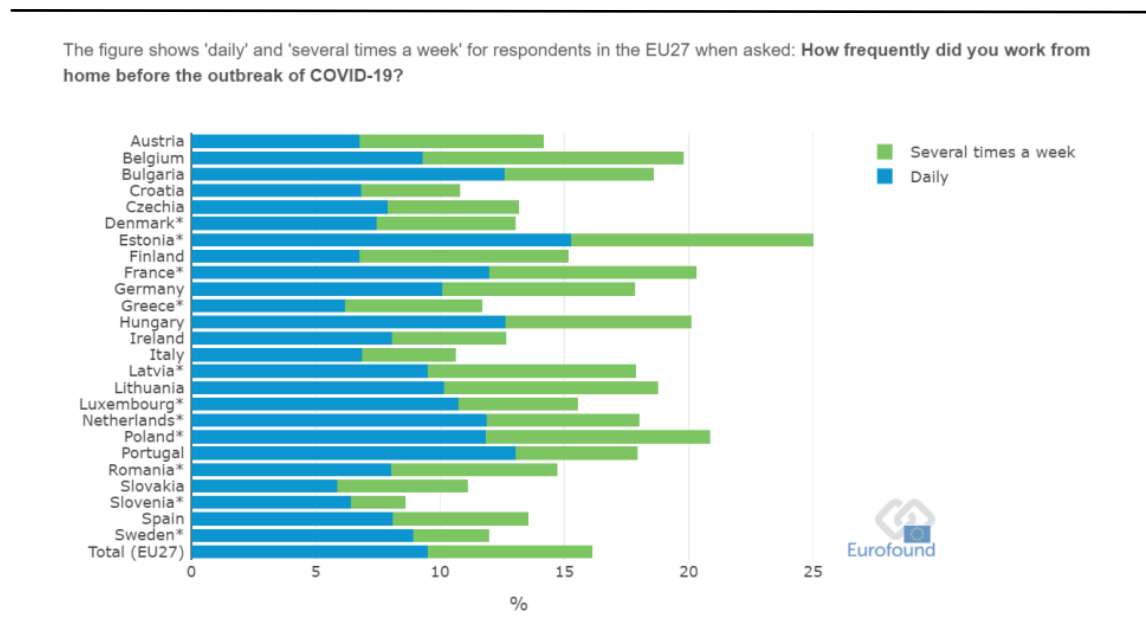

Source: Eurofund (2020): Working during COVID-19, available at: <https://www.eurofound.europa.eu/data/covid-19/working-teleworking>, last accessed: 10/05/2020.

Figure 11: Corona as a trigger to work from home

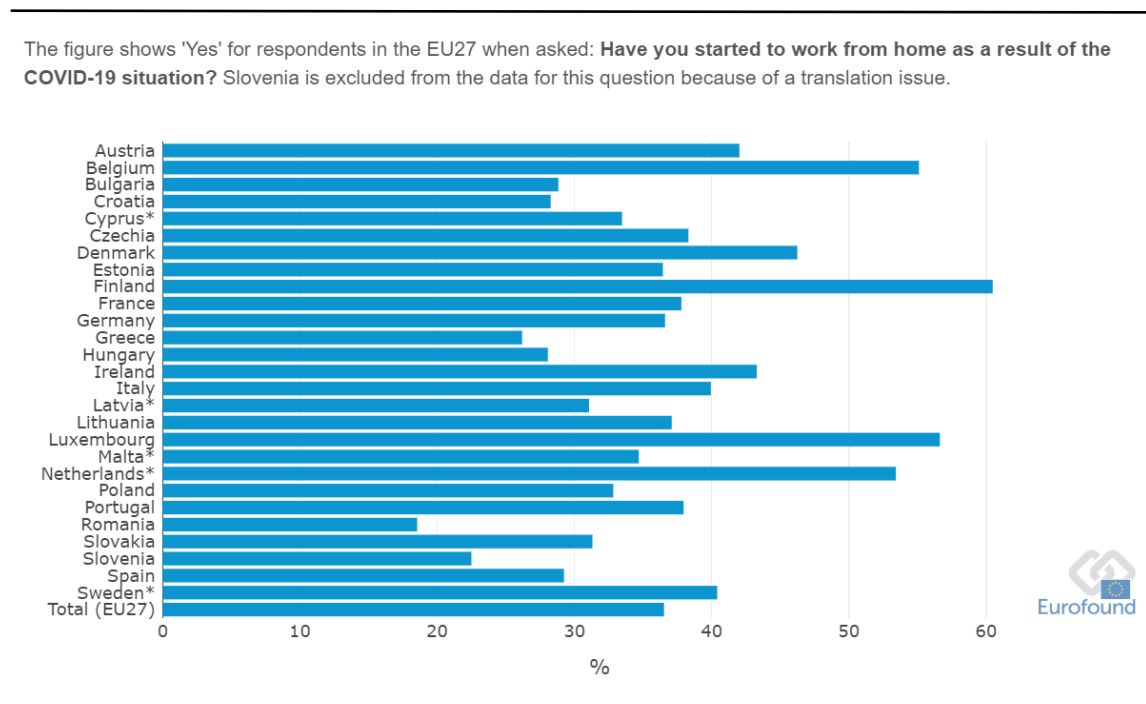

Source: Eurofund (2020): Working during COVID-19, available at: <https://www.eurofound.europa.eu/data/covid-19/working-teleworking>, last accessed: 10/05/2020.

“Over three-quarters of EU employees in July [2020] want to continue working from home at least occasionally, even without COVID-19 restrictions. Most EU workers report a positive experience teleworking during the pandemic but very few wish to telework all the time, with the preferred option being a mix of teleworking and presence at the workplace.”⁶⁵

Whether these figures will remain after the crisis or to what extent they will decrease remains to be seen. However, what is clear is that there is a huge potential for remote working, which saves GHG emissions through cutting travel activities. For example, EY and the German Wuppertal Institute claim for Germany that total passenger transport could be reduced by 8% due to work from home and video conferencing.⁶⁶

Büttner and Breitzkreuz (2020) find for Germany, that two additional days of remote working per week would result in GHG savings of between 3.2 and 5.4 million tonnes CO₂. If we assume a similar working structure in the EU 27 this would result in GHG savings of between 515 and 870 Mt CO₂ per year.

For E-learning, virtual reality applications play an important role (cp. section 3.3.2) and thus even more energy savings could be achieved.

6.2 e-Health

The health sector also contributes to carbon emissions. Worldwide, its share amounts to 4.4 % of emissions (in CO₂ equivalents).⁶⁷ In Europe, the share is 4.7 % which represents 249 MtCO₂.⁶⁸

The health sector includes several fields, where energy might be saved, e.g.

- Supply Chain: Manufacturing transport, use and disposal of medical products⁶⁹
- Health care facilities and vehicles ⁷⁰
- Patients’ ways to the hospitals and registered doctors.

E-health applications fall under the last category. These are:

- “mobile health apps (m-health), which can support and monitor healthy behaviours
- connected biometric sensors and devices (such as continuous glucose monitoring, or pacemakers with automated wi-fi check-ins);

⁶⁵ Eurofund (2020): Working during COVID-19, available at: <https://www.eurofound.europa.eu/data/covid-19/working-teleworking>, last accessed: 10/05/2020.

⁶⁶ Losse-Müller et al. (2020).

⁶⁷ Health Care Without Harm and ARUP (2019), p.4.

⁶⁸ Health Care Without Harm and ARUP (2019), p.26.

⁶⁹ Health Care Without Harm and ARUP (2019), p.5.

⁷⁰ Health Care Without Harm and ARUP (2019), p.5.

- consultations via video link or phone (also known as “telemedicine”)
- electronic personal health records
- decision support systems that mine clinical datasets”⁷¹

An overview of possible environmental benefits is shown in Table 6-1.

Table 6-1: Examples of eHealth methods and their potential impacts and health co-benefit

eHealth methods	Direct & indirect greenhouse gas impact	Potential co-benefits and examples of subsequent implications
Video consultations, e.g. between general practitioner and specialist or specialist and patient	Reduced travel for specialist and/or patient	<ul style="list-style-type: none"> ● Less pollution^a ● Positive impact on health economy ● Long-term benefit: education of the general practitioner. ● Sub-specialist access for out-patient clinics in low-resource settings
Telehomecare, e.g. remote support of self-management in chronic diseases	Reduced travel for patients and specialists	<ul style="list-style-type: none"> ● Less pollution^a ● Decrease in hospital admissions for individuals with chronic diseases ● Positive impact on health economy ● Increased quality of life for the patient
Remote public health or medical education	Reduced travel for teacher, patient, and/or student	<ul style="list-style-type: none"> ● Less pollution^a ● Increased medical knowledge, e.g. in poor or remote settings. Positive impact on health economy ● Large potential for out-patient clinics in remote or low-resource settings
Virtual visits	Reduced travel for patients and relatives	<ul style="list-style-type: none"> ● Less pollution^a ● Positive impact on long-term hospital admissions since more frequent contact with relatives will be possible. ● Potential to reduce the need for near-hospital parking facilities
Remote diagnostics, e.g. teleradiology, remote auscultations	Reduced travel for patient and/or specialist	<ul style="list-style-type: none"> ● Less pollution^a ● Positive impact on health economy ● Large potential for out-patient clinics in remote or low-resource settings
Electronic prescriptions	Reduced travel for patient Reduced paperwork ^b	<ul style="list-style-type: none"> ● Less pollution^a ● Significant potential to reduce harmful adverse drug interactions
Electronic medical records and referrals	Reduction in travel Reduced paperwork ^b	<ul style="list-style-type: none"> ● Less pollution^a ● Shared health information leads to safer and more efficient care

^aLess pollution should result in direct benefits of lower rates of diseases such as respiratory diseases and cardiovascular diseases.

^bReduced paperwork should result in less deforestation and lowered emission from paper manufacturing, transport and recycling.

Source: Holmner et al. (2012), p.5.

WiFi can contribute to saving carbon emissions by supporting these kinds of e-health applications. BT (2016, p. 25) has estimated the possible contribution of E-health for Europe to account for about 500 Mt CO₂ savings.

⁷¹ Royston, S. (2019), p.5.

6.3 Buildings

“Buildings are responsible for approximately 40% of energy consumption and 36% of CO₂ emissions in the EU.”⁷² These figures show the huge potential for buildings with respect to possible GHG saving. The retrofitting of buildings is one major aspect in this field.⁷³ Röck et al. (2020) find that “emissions from building operation arise from the energy used for heating and/or cooling, hot water supply, ventilation and air conditioning, lighting, and process-related climate-relevant GHG emissions, i.e., the release of refrigerants and blowing agents (HFC- and PFC-gases).”

One means to tackle energy consumption in buildings is the use of information and communication technologies to make buildings more intelligent or “smart”. So called “*Smart Homes*” have existed for many years and with many different approaches and features. The basic idea is to automate processes within the home and give users remote control for monitoring and steering the building and its appliances, but also to integrate homes into wider systems. This includes, for example, the turn off of idle devices.⁷⁴ Furthermore, the integration of renewable energy in people’s homes can be supported through smart home applications.⁷⁵ Figure 12 gives an overview of different levels in the evolution of smart homes.

⁷² <https://ec.europa.eu/easme/en/life-platform-meeting-climate-action-and-building-sector>, last accessed:10/29/2020.

⁷³ Life / BE reel (2019): Life Platform Meeting on Climate Action and The Building Sector, Brussels, 17-18 June 2019, p. 22.

⁷⁴ Gong et al. (2019).

⁷⁵ Gong et al. (2019).

Figure 12: Smart Home: Different levels of smartness

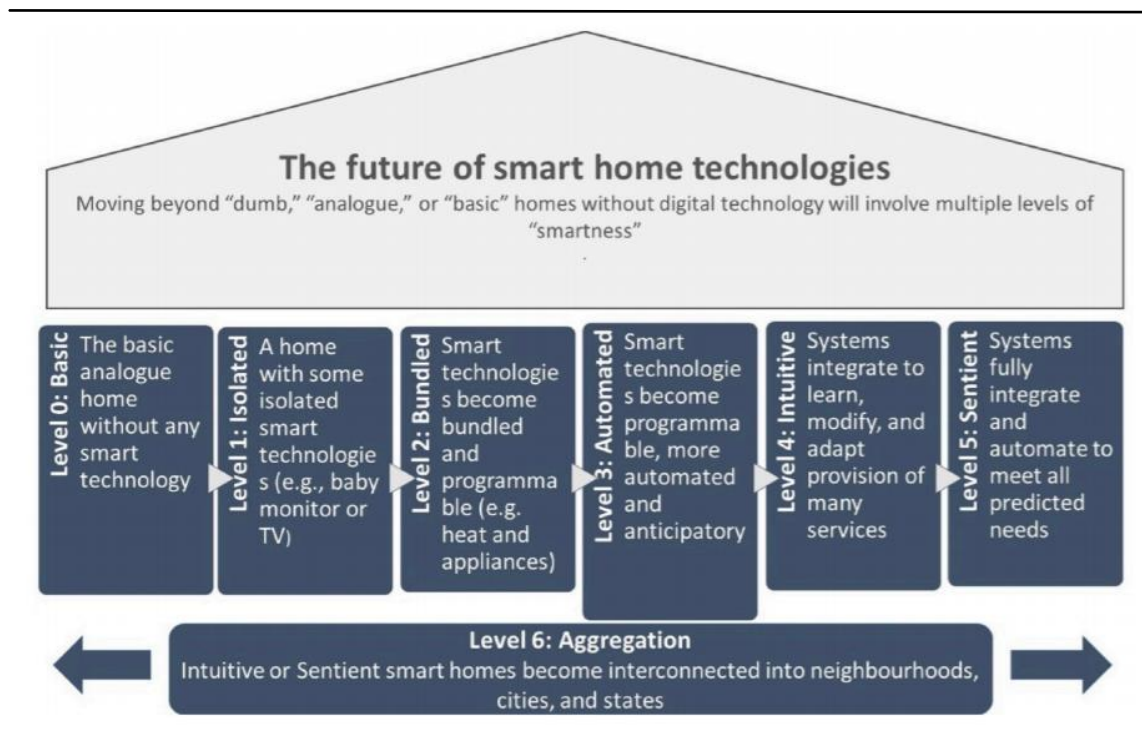

Source: Sovacool and Furszyfer Del Rio (2020), p. 7.

Energy savings from smart homes differ in different (case) studies as do the information and communication technologies used. In the following we show different examples of smart home energy savings realised with WiFi technology.

The realisation of smart homes can involve a range of devices and communications technologies. In a simple case, just one or a few devices are made “smart”. In the following example we look at a WiFi-driven thermostat. In principle, such smart thermostats enable the user to remotely control it, adjust the room temperature and “learn” the inhabitants’ behaviour.

BT (2016, p. 25) has estimated the possible contribution of ICT in buildings for Europe to account for about 1,700 Mt CO₂ savings.

6.4 Transport

The transport sector is responsible for 27% of all greenhouse gas emissions in Europe (2017).⁷⁶ Figure 13 shows the development of the most important sectors of the past years up to 2017.

Figure 13: GHG emissions by main sector in the EU-28, 1990-2017

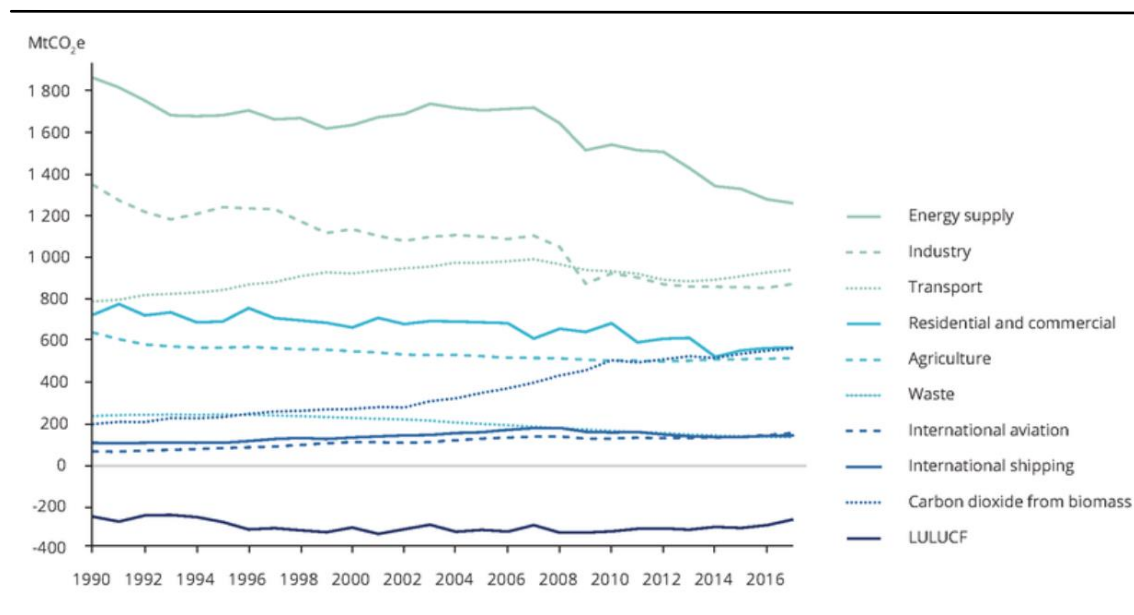

Source: European Environment Agency (EEA) (2019), available at: <https://www.eea.europa.eu/data-and-maps/figures/ghg-emissions-by-main-sector>, last accessed: 10/01/2020.

As the green dotted line shows, the transport sector is one of the sectors where emissions have stagnated since 1990. The following is what the European Environment Agency (EEA) says about the transport sector (see box below).⁷⁷

⁷⁶ European Environment Agency (EEA) (2019): Greenhouse gas emissions from transport in Europe, available at: <https://www.eea.europa.eu/data-and-maps/indicators/transport-emissions-of-greenhouse-gases/transport-emissions-of-greenhouse-gases-12>, last accessed: 01/10/2020.

⁷⁷ Quotation from: European Environment Agency (EEA) (2019): Greenhouse gas emissions from transport in Europe, available at: <https://www.eea.europa.eu/data-and-maps/indicators/transport-emissions-of-greenhouse-gases/transport-emissions-of-greenhouse-gases-12>, last accessed: 01/10/2020.

- In 2017, 27% of total EU-28 greenhouse gas emissions came from the transport sector (22% if international aviation and maritime emissions are excluded). CO₂ emissions from transport increased by 2.2 compared with 2016.
- Emissions from transport (including international aviation but excluding international shipping) in 2017 were 28 % above 1990 levels, despite a decline between 2008 and 2013.
- International aviation was responsible for the largest percentage increase in greenhouse gas emissions over 1990 levels (+129 %), followed by international shipping (+32 %) and road transport (+23 %). However, EEA estimates show that emissions from transport (including aviation) decreased by 0.7 % in 2018.
- Emissions need to fall by around two thirds by 2050, compared with 1990 levels, in order to meet the long-term 60 % greenhouse gas emission reduction target as set out in the 2011 Transport White Paper.

A further distinction can be made for the transport sector between domestic aviation, domestic navigation, railways and road transportation. Figure 14 shows that road transportation accounts for the biggest share of greenhouse gas emissions from transport.

Figure 14: GHG emissions from transport in the EU

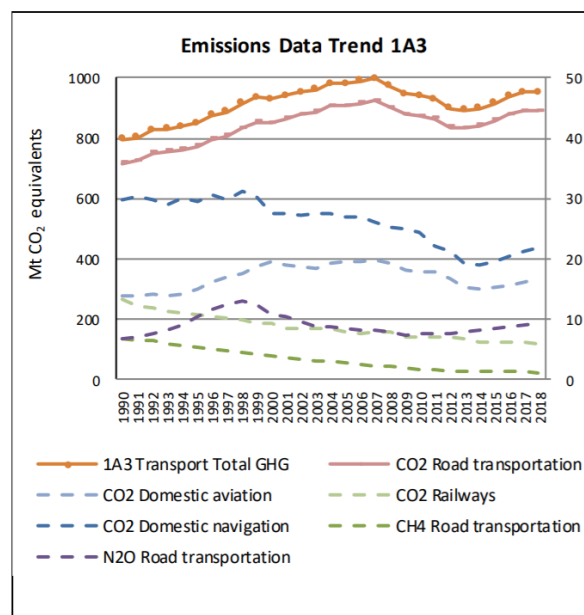

Source: EEA (2020), p.227.

WiFi can contribute in different ways to mitigating greenhouse gas emissions. The most noteworthy are listed below. Use cases for every measure can be found in Annex C.

- To *reduce road traffic congestion* it is necessary to monitor and measure the flow of vehicles. One option to do this is to install a WiFi-based monitoring system.
- One aspect of reducing congestion is *smart traffic light management*. With the goal of achieving GHG emissions reduction, data is collected from the vehicles to apply signal timing strategies.
- A further means to reduce emissions is *smart parking*. Using WiFi systems can significantly reduce cruising time of people looking for a parking opportunity.
- Finally, *Improving processes* and making them more efficient is also an objective of *public transport systems*. WiFi can support such solutions.

BT (2016, p. 25) has estimated the possible contribution of ICT for traffic control and optimisation for Europe to account for about 600 Mt CO₂ savings.

7 Regulatory framework

The “any-to-any” principle is one of the cornerstones of telecommunication policy. In the past this principle applied mainly to voice telephony. However, nowadays it is a synonym for commercial approaches to connect all things which can have access to wireless networks, which is particularly relevant with the expansion of the Internet of Things. In this context, the prospects and development of wireless communications networks are becoming increasingly important from an economic perspective. The increasing demand for and use of radio-based applications result in future demand for spectrum. Without making additional frequencies available it will be difficult to support the growth in wireless applications. Frequencies will therefore continue to be a scarce resource for the foreseeable future.

Given the already high penetration of WiFi based applications and devices and the future prospects of the use cases, additional frequencies have been freed up in the 6 GHz range for Wifi. For instance, the United States, Canada, most of the South Americas (incl. Brasil), Japan and South Korea have already assigned 1,200 MHz for WiFi (5945 – 7125 MHz).⁷⁸

In Europe and Africa (region 1 of ITU regulation) the situation and discussion differs from other regions. In Europe (and U.K.), it has already been agreed to make 480 MHz (5945 - 6425 MHz) of new spectrum with the same regulatory requirements available for WiFi. Here however, different stakeholders ask for the use of frequencies in the upper part of the 6 GHz band⁷⁹ with some calling for the provision of the upper half of the 6 GHz frequencies to be used for WiFi while mobile network operators would like to see IMT technologies deployed in this band. These operators are looking for additional frequencies in a mid-range band for 5G. The frequency band 6425 - 7125 MHz is considered as an additional 5G capacity band on top of 3,6 GHz frequencies or as a substitute for the 3,6 GHz band, which in some countries is not available.

Since the use of the upper half of the 6GHz band by WiFi has already been decided in a number of regions globally, there is a risk of an uneven distribution of spectrum for WiFi in different ITU regions. It is possible when considering the total spectrum required to address bandwidth demand and the available spectrum in Europe, that a spectrum shortfall might occur. The same consideration applies for applications enabled by IMT technologies. Furthermore, there may be impacts on the cost of equipment as well as the development of an ecosystem in the upper part of the GHz band. In this context, thorough analysis to weigh up the different interests will be needed to ensure that the needs of end users are best served. Market players expect that the conflict can be resolved before the next World Radio Conference in 2023.

⁷⁸ WiFi (2021)

⁷⁹ The IEEE 802.11be designs Extremely High Throughput Channels with 320 MHz bandwidth. Three of these could be configured in the 1,200 MHz US approach, only one in the EU approach (see Annex B.4).

8 Summarizing the supporting role of WiFi in Green IT

In many cases WiFi is the cordless tail of a broadband connection, i.e. for connection mobile devices indoor (tablets, smartphones, VR-glasses, wearable telemedicine sensors, emergency case alert buttons, ...) or for connecting smart home sensors or controllers at otherwise unconnected locations and for substituting old indoor cabling with insufficient quality and/ or capacity (i.e. UTP telephone wires).

With the migration towards higher bandwidth access lines, and the increasing bandwidth demand from both sides, applications as well as users, access technologies are set to be upgraded with fibre access links. However, when this happens, the indoor connection may become the new, very final bottleneck of the network access.

Network access cannot perform better than its weakest link. Thus both the cordless and fixed network access links need to be dimensioned to meet future access needs, supporting at last several Gigabit access connections.

In-building access link upgrades may require significant resources for building owners, end users or the access network operators, and may require the building owner to organise upgrades, which may take time. WiFi is the natural substitute over time for fixed indoor connections.

WiFi is in any case the state of the art cordless tail for broadband access for all devices which are indoor and mobile or which do not have the opportunity to be connected to fixed access.

WiFi requires sufficient frequency space to provide for future bandwidth needs. These bandwidth requirements should be provided well in advance of the increase in demand, enabling suppliers to develop and building owners to provide investment security (in terms of if and where to upgrade in-building cabling).

Broadband demand will develop over time and step by step for different user groups. Thus the frequency space should be available when the first user groups press for gigabit level bandwidth.

In-building wiring based on fibre links provides an opportunity to reduce electromagnetic interference to the most significant extent, but cannot be available everywhere and does not support cordless terminals. Migration to fibre inside buildings is expensive and time consuming, requires energy and produces GHG emissions, and will require decades when deployed only in case of new buildings or major renovations. WiFi is an appropriate substitute, which should satisfy bandwidth expectations if coupled with sufficient frequencies.

WiFi is already present in nearly all homes. New high capacity WiFi 6E equipment substituting WiFi 4 and 5 will consume electrical power at a comparable level, but provide significantly higher capacity and thus a significantly improved efficiency.

Moreover, existing and new WiFi based applications can enable power saving in other sectors.

WiFi is one of the indoor access solutions that can contribute to a greener environment in conjunction with fibre.

WiFi also plays an important role in offering cordless access to local hotspots. Increased capacity should in these cases improve the end customer experience so that it is more like being at home or office, allowing for mobile offloading and thus reducing the power consumption of mobile networks. The implementation of WiFi 6/6E will increase capacity at nearly constant power consumption, and thus is an element in the toolkit to achieve green telecommunications.

In conclusion, WiFi 6 and 6E will contribute to the GHG emission reduction goals of the European nations to a significant extent, and its role should be reflected in spectrum allocations.

References

- Arista (2020): WiFi 6: A technological leap for Next Generation Enterprise WiFi Networks, White Paper, <https://www.arista.com/assets/data/pdf/Whitepapers/WiFi-6.pdf>
- Arista (2020a): 6GHz WiFi - The Silver Bullet for Addressing the 1000x Data Challenge Using Unlicensed Spectrum, White Paper, <https://www.arista.com/assets/data/pdf/Whitepapers/Arista-6GHz-WiFi-WP.pdf>
- Aruba (2020): Wi-Fi 6 (802.11ax): A new Standard for a New Experience, White Paper, https://www.arubanetworks.com/assets/wp/WP_802.11ax-IDG.pdf
- Barriga et al. (2019): Smart Parking: A Literature Review from the Technological Perspective, Appl. Sci. 2020, 10(13), 4674.
- Barth, M.J., Wu, G., Boriboonsomsin, K. (2015): Intelligent Transportation Systems and Greenhouse Gas Reductions, Current Sustainable/Renewable Energy Reports, pp. 1-8.
- Bastug, E. et al. (2017), "Towards Interconnected Virtual Reality: Opportunities, Challenges and Enablers", IEEE Communications Magazine, 55 (6), 110-117, p.114.
- Bitkom (2014): Smart Home in Deutschland, <https://www.bitkom.org/noindex/Publikationen/2014/Studien/Smart-Home-in-Deutschland-Praesentation/Praesentation-Smart-Home.pdf>
- BIU (2015): Positionspapier Agenda 2020: für eine starke Computer- und Videospielebranche in Deutschland, https://www.biu-online.de/wp-content/uploads/2015/06/20150608_BIU_Positionspapier_F%C3%B6rderung_Standort_Deutschland.pdf
- BIU (2016), Jahresreport der Computer- und Videospielebranche in Deutschland 2016, pp. 30 ff., https://www.biu-online.de/wp-content/uploads/2016/07/BIU_Jahresreport_2016.pdf
- Broadcom, 2019: Wi-Fi 6E: Faster Speed, Lower Latency and Higher Capacity, <https://docs.broadcom.com/doc/wi-fi-6e-presentation>, Slide 9.
- BVDW (2019): Digitale Nutzung in Deutschland 2018, https://www.bvdw.org/fileadmin/user_upload/BVDW_Marktforschung_Digitale_Nutzung_in_Deutschland_2018.pdf.
- CAICT and HUAWEI Technologies Co. Ltd (2017): Virtual Reality/Augmented Reality White Paper, <http://www-file.huawei.com/-/media/CORPORATE/PDF/ilab/vr-ar-en.pdf>
- Caird, S., Lane, A., Swithenby, E., Roy, R. Potter, S. (2015). Design of higher education teaching models and carbon impacts. International Journal of Sustainability in Higher Education, 16(1) pp. 96–111.
- CISCO (2019): Smart Intersections – IoT insights using Wi-Fi, White Paper.
- Cisco (2018): VNI: Forecasts and Trends, 2017-2022 White Paper, <https://www.cisco.com/c/en/us/solutions/collateral/service-provider/visual-networking-index-vni/white-paper-c11-741490.pdf>.

- CISCO (2018a): 802.11ac: The Fifth Generation of Wi-Fi, Technical White Paper, <https://www.cisco.com/c/dam/en/us/products/collateral/wireless/aironet-3600-series/white-paper-c11-713103.pdf>
- CISCO (2019): Wi-Fi 6: The Next Generation of Wireless, Technical White Paper, <https://www.cisco.com/c/dam/en/us/products/collateral/wireless/aironet-3600-series/white-paper-c11-713103.pdf>
- Cisco (2020): White Paper, Cisco Annual Internet Report (2018–2023), <https://www.cisco.com/c/en/us/solutions/collateral/executive-perspectives/annual-internet-report/white-paper-c11-741490.pdf>.
- Cisco (without date): Target Wake Time, p.1, available at: https://www.cisco.com/c/en/us/td/docs/wireless/controller/9800/17-2/config-guide/b_wl_17_2_cg/target_wake_time.pdf, last accessed: 02/12/2020.
- DCTI (2015): DCTI GreenGuide Smart Home 2015, Die optimale Lösung für Ihr Zuhause, http://www.dcti.de/fileadmin/user_upload/GreenGuide_SmartHome_2015_Webversion.pdf
- Deloitte; Bitkom (2018), Zukunft der Consumer Technology – 2018, Marktentwicklung, Trends, Mediennutzung, Technologien, Geschäftsmodelle, p. 37, <https://www.bitkom.org/sites/default/files/file/import/180822-CT-Studie-2018-online.pdf>.
- Doose, A.-M.; Monti, A.; Schäfer, R. (2011): Mittelfristige Marktpotenziale im Kontext der Nachfrage nach hochbitratigen Breitbandanschlüssen in Deutschland, WIK Diskussionsbeitrag Nr. 358, Bad Honnef
- Doutsi, E. (2017): Compression d'images et de vidéos inspirée du fonctionnement de la rétine, <https://tel.archives-ouvertes.fr/tel-01584114/document>.
- EEA [European Environment Agency] (2020): Annual European Union greenhouse gas inventory 1990–2018 and inventory report 2020, Submission to the UNFCCC Secretariat.
- Elektronik Kompendium (2020): Wi-Fi 5 / IEEE 802.11ac / Gigabit-WLAN, <https://www.elektronik-kompendium.de/sites/net/1602101.htm>
- Emami, 2016: Improved spatial reuse with MU-MIMO, <https://www.slideshare.net/gotvand/80211ac-60204652>, Slide 13.
- Ericsson (2017): 5G Systems – Enabling the transformation of industry and society. White Paper, p.4.
- Eurofund (2020): Working during COVID-19, available at: <https://www.eurofound.europa.eu/data/covid-19/working-teleworking>, last accessed: 10/05/2020.
- European Commission “Smart investments for smart communities”, available at: <https://ec.europa.eu/digital-single-market/en/news/cef2-study-workshop-smart-investments-smart-communities>.
- European Environment Agency (EEA) (2019): Greenhouse gas emissions from transport in Europe, available at: <https://www.eea.europa.eu/data-and-maps/indicators/transport-emissions-of-greenhouse-gases/transport-emissions-of-greenhouse-gases-12>, last accessed: 01/10/2020.

- Eurostat (2019), Individuals – use of cloud services, http://appsso.eurostat.ec.europa.eu/nui/show.do?dataset=isoc_cicci_use&lang=en.
- Fraunhofer FOKUS (2016): Netzinfrastrukturen für die Gigabitgesellschaft, https://cdn2.scrvt.com/fokus/5468ae83a4460bd2/65e3f4ee76ad/Gigabit-Studie_komplett_final_einzelseiten.pdf; Godlovitch, I et al. (2019): Analysis of the Danish Telecommunications Market in 2030, https://www.wik.org/fileadmin/Studien/2020/Analysis_of_the_Danish_TK_Market_in_2030.pdf
- Frees, B. and Koch, W. (2018): ARD/ZDF-Onlinestudie 2018: Zuwachs bei medialer Internetnutzung und Kommunikation, in *Mediaperspektiven* 9/2018, p. 398-413, http://www.ard-zdf-onlinestudie.de/files/2018/0918_Frees_Koch.pdf.
- Frontier Economics (2017): Future benefits of broadband networks, <https://www.nic.org.uk/wp-content/uploads/Benefits-analysis.pdf>.
- FTTH Council (2016): FTTH Business Guide, Edition 5 Financing Committee, Revision date: 16/02/2016, http://www.ftthcouncil.eu/documents/Publications/FTTH_Business_Guide_V5.pdf
- Fumagalli, S., Pizzuti, S., Romano, S. (2017): Smart Homes Network: sviluppo dei servizi di aggregazione e progettazione di un dimostrativo pilota, Report Ricerca di Sistema Elettrico, Accordo di Programma Ministero dello Sviluppo Economico – ENEA.
- Game (2018): Jahresreport der deutschen Games-Branche 2018, p.7, <https://www.game.de/wp-content/uploads/2018/08/Jahresreport-der-deutschen-Games-Branche-2018.pdf>.
- Game (2019): The German games industry, Insights, facts and reports, https://www.game.de/wp-content/uploads/2017/02/2019_Guide-to-the-German-Games-Industry_web.pdf
- Gann, B. (2018): Digital Inclusion in Health and Care in Wales, The potential for digital inclusion to improve the health and well-being of older people and people with a limiting long-standing illness, disability or infirmity in Wales.
- Gast, Matthew S. (2012): 802.11.n: A Survival Guide. O'Reilly Media, Inc, <https://www.oreilly.com/library/view/80211n-a-survival/9781449335472/index.html>
- Gast, Matthew S. (2013): 802.11.ac: A Survival Guide. O'Reilly Media, Inc, <https://www.oreilly.com/library/view/80211ac-a-survival/9781449357702/>
- Godlovitch, I.; Hoceped, C.; Lemstra, W.; Plückebaum, T.; Strube Martins, S.; Kroon, P.; Lucidi, S.; Alexiadis, P., Char, S. (2020): Future electronic communications product and service markets subject to ex-ante regulation Recommendation on relevant markets, <https://ec.europa.eu/digital-single-market/en/news/study-future-electronic-communications-product-and-service-markets-subject-ex-ante-regulation>
- Godlovitch, I et al. (2019): Analysis of the Danish Telecommunications Market in 2030, https://www.wik.org/fileadmin/Studien/2020/Analysis_of_the_Danish_TK_Market_in_2030.pdf
- Godlovitch, I.; Plückebaum, T.; Strube Martins, S.; Gantumur, T.; Elixmann, D.; Tas, S.; Arnold, R.; Wernick, C. (2018): The Benefits of Ultrafast Broadband Deployment, Report for Ofcom, https://www.ofcom.org.uk/__data/assets/pdf_file/0016/111481/WIK-Consult-report-The-Benefits-of-Ultrafast-Broadband-Deployment.pdf.

- Gong, H., Rallabandi, V., McIntyre, M.L., Ionel, D.M. (2019): On the Optimal Energy Controls for Large Scale Residential Communities including Smart Homes. 2019 IEEE Energy Conversion Congress and Exposition (ECCE), Baltimore, MD, USA, pp. 503-507.
- Gupta, S., Hamzin, A., Degbelo, A. (2018): A Low-Cost Open Hardware System for Collecting Traffic Data Using Wi-Fi Signal Strength, in: *Sensors* (Basel). 2018 Oct 25;18(11):3623.
- Habibzadeh, H. et al. (2019) Smart City System Design: A Comprehensive Study of the Application and Data Planes, *ACM Computing Surveys*, Vol. 52, No. 2, Article 41.
- Health Care Without Harm and ARUP (2019): Health Care's Climate Footprint, How the health sector contributes to the global climate crisis and opportunities for action.
- Hobson, B.W., Gunay, W., Ashouri, A. (2020): Wi-Fi based occupancy clustering and motif identification: A case study, Conference: ASHRAE Transactions, at: Orlando, FL, Volume: 126 I.
- Holmner, Å., Ebi, K.L., Lazuardi, L., Nilsson, M. (2014): Carbon Footprint of Telemedicine Solutions - Unexplored Opportunity for Reducing Carbon Emissions in the Health Sector, *PLoS ONE* 9(9): e105040.
- Holmner, Å., Rocklöv, J., Ng, N., Nilsson, M. (2012): Climate change and eHealth: a promising strategy for health sector mitigation and adaptation, *Global Health Action*, 5:1, 18428.
- Huang (2018): 802.11ax fundamentals: Target Wake Time (TWT), available at: <https://www.commscope.com/blog/2018/802.11ax-fundamentals-target-wake-time-twt/>, last accessed: 02/12/2020.
- Huawei (2020): Wi-Fi 6 (802.11ax) Technology, White Paper, Hannover Messe, https://www.messe.de/apollo/hannover_messe_2020/obs/Binary/A1032221/Huawei%20Wi-Fi%206%20%28802.11ax%29%20Technology%20White%20Paper.pdf
- Huawei iLab (2017): Video Big Data, The Top 10 Most Demanding Videos on the Net, <https://www.huawei.com/~media/CORPORATE/PDF/white%20paper/Big-Data-Video-Top-Ten-Most-Demanding-Videos-en>;
<https://www.mushroomnetworks.com/infographics/bandwidth-requirements-for-virtual-reality-vr-and-augmented-reality-ar-infographic/>.
- Initiative D21 (2018): D21 DIGITAL INDEX 2017/2018 Jährliches Lagebild zur Digitalen Gesellschaft, https://initiated21.de/app/uploads/2018/01/d21-digital-index_2017_2018.pdf
- ISFE (2020): Key Facts 2020, <https://www.isfe.eu/game-industry/economic-success/>
- Issa, M., Bergs, R. (2020): Less commuting and climate protection: An estimation exercise for the Frankfurt/Rhein-Main region.
- IW Consult GmbH (2016): Der Weg in die Gigabitgesellschaft, wie Netzausbau zukünftige Innovationen sichert, <http://www.vodafone-institut.de/wp-content/uploads/2016/07/studie-lange-version.pdf>.
- Kupferschmitt, T. (2018): Onlinevideo-Reichweite und Nutzungsfrequenz wachsen, Altersgefälle bleibt, in *Mediaperspektiven* 9/2018, p. 427-437, http://www.ard-zdf-onlinestudie.de/files/2018/0918_Kupferschmitt.pdf.

- Lade, V., Mohan, A., Patil, S. (2018): 802.11ax for Internet Of Things - Machine Learning Assisted Optimized Power Save Techniques for IoT Devices Using 802.11ax Target Wake Time, Technical Disclosure Commons.
- Life / BE reel (2019): Life Platform Meeting on Climate Action and The Building Sector Brussels, 17-18 June 2019, p. 22.
- LITEPOINT (2020): A Guide to Wi-Fi 6E: Wi-Fi 6 in the 6 GHz Band, White Paper, <https://www.litepoint.com/wp-content/uploads/2020/06/Wi-Fi-6E-Whitepaper-060220-web.pdf>
- Losse-Müller, T., Gläser, N., Czemin, S., Ramesohl, S., Berg, H., Lauten-Weiss, J. (2020): Zwischenbilanz COVID-19: Umweltpolitik und Digitalisierung.
- Lou, R., Hallinan, K.P., Huang, K., Reissmann, T. (2020): SmartWifi Thermostat-Enabled Thermal Comfort Control in Residences, in: Sustainability 2020, 12, 1919.
- Maier, M. et al. (2016), "The Tactile Internet: Vision, Recent Progress, and Open Challenges", IEEE Communications Magazine, 54(5), 138-145, p.139.
- Mangiante, S. et al (2017): VR is on the Edge: How to Deliver 360° Videos in Mobile Networks, https://www.researchgate.net/publication/319049968_VR_is_on_the_Edge_How_to_Deliver_360_Videos_in_Mobile_Networks/download
- Monti, A.; Schäfer, R. (2012): Marktpotenziale für hochbitratige Breitbandanschlüsse in Deutschland, Abschlussbericht für den BREKO, Bad Honnef.
- Nationaler IT Gipfel (2015a): Smart Home, Ergebnisdokument der Projektgruppe Smart Home Plattform „Digitale Netze und Mobilität“, http://www.de.digital/DIGITAL/Redaktion/DE/IT-Gipfel/Download/2015/it-gipfel-2015-smart-home.pdf?__blob=publicationFile&v=2;
- Nationaler IT Gipfel (2015b): Thesenpapier zum Schwerpunktthema Smart Data im Gesundheitswesen, <https://www.bitkom.org/noindex/Publikationen/2016/Positionspapiere/Thesenpapier-zum-Schwerpunktthema-Smart-Data-im-Gesundheitswesen/it-gipfel-2015-thesenpapier-zum-schwerpunktthema-smart-data-im-gesundheitswesen.pdf>
- Nitti, M., Pinna, F., Pintor, L., Pilloni, V., Barbino, B. (2020): iABACUS: A Wi-Fi-Based Automatic Bus Passenger Counting System, Energies 2020, 13, 1446.
- On The Fly Wi-Fi (2014): Wi-Fi's Enigma: MU-MIMO, <http://ontheflywifi.net/wi-fis-enigma-mu-mimo/>
- Qorvo (2017): Wi-Fi 6 (802.11ax): 5 Things to Know, <https://www.qorvo.com/design-hub/blog/80211ax-5-things-to-know>
- Qualcomm (2016): A Quantification of 5 GHz Unlicensed Band Spectrum Needs.
- Qualcomm (2019), Jorgensen, C.: How Wi-Fi 6 Is So Much More Than Just Faster Wi-Fi, <https://developer.qualcomm.com/blog/how-wi-fi-6-so-much-more-just-faster-wi-fi>
- Qualcomm (2020): Cutting edge Wi-Fi 6E performance, <https://www.qualcomm.com/wi-fi-6e/product-list>
- Quotient Associates (2017): Wi-Fi-Spectrum Needs Study, Final Report

- Raghavan, B., Ma, J. (2011): Proceedings of the 10th ACM Workshop on Hot Topics in Networks. Cambridge, Massachusetts: ACM. 1–6.
- Review42 (2020): Internet of Things Statistics, Facts & Predictions, <https://review42.com/resources/internet-of-things-stats/>
- Röck et al. (2020): Embodied GHG emissions of buildings – The hidden challenge for effective climate change mitigation, in: Applied Energy, Volume 258, pp. 1-12.
- Romano, S., Botticelli, M., Dionisi, F. (2019): Experimental demonstration of a smart homes network in Rome, in: International Journal of Sustainable Energy Planning and Management, Vol. 24, pp. 107–114,
- Royal College of Physicians (2018): Outpatients: The future, Adding value through sustainability, case studies.
- Royston, S. (2019): Digitalisation, energy and healthcare, Working Paper, January 2019.
- Siemon (2020): Preparing for Wi-Fi 6E: Cabling Considerations for High Efficiency Wireless Access Point Connections, White Paper, <https://www.siemon.com/en/home/forms/wi-fi-6e>
- Sikdar, B. (2013): A study of the environmental impact of wired and wireless local area network access, in IEEE Transactions on Consumer Electronics, vol. 59, no. 1, pp. 85-92.
- Silva, P., Almeida, N.T., Campos, R. (2019): A Comprehensive Study on Enterprise Wi-Fi Access Points Power Consumption," in IEEE Access, vol. 7, pp. 96841-96867.
- Sovacool, B.K., Furszyfer Del Rio, D.D. (2020): Smart home technologies in Europe: A critical review of concepts, benefits, risks and policies, in: Renewable and Sustainable Energy Reviews 120, pp. 1-20.
- Statistisches Bundesamt (2011): Bevölkerung und Erwerbstätigkeit, Entwicklung der Privathaushalte bis 2030, Ergebnisse der Haushaltsvorausberechnung, https://www.destatis.de/GPStatistik/servlets/MCRFileNodeServlet/DEHeft_derivate_00012544/5124001109004.pdf;jsessionid=1F6F71176E99BFCE7657F67AE47E9F70.
- Statistisches Bundesamt (2018) Wirtschaftsrechnungen, Private Haushalte in der Informationsgesellschaft – Nutzung von Informations- und Kommunikationstechnologien, https://www.destatis.de/DE/Themen/Gesellschaft-Umwelt/Einkommen-Konsum-Lebensbedingungen/IT-Nutzung/Publikationen/Downloads-IT-Nutzung/private-haushalte-ikt-2150400187004.pdf?__blob=publicationFile&v=4
- Strube Martins, S.; Wernick, C.; Plückebaum, T.; Henseler-Unger, I. (2017): Die Privatkundennachfrage nach hochbitratigem Breitbandinternet im Jahr 2025, WIK Bericht, Bad Honnef, März 2017, http://www.wik.org/fileadmin/Studien/2017/Die_Privatkundennachfrage_nach_hochbitratigem_BreitbandInternet_im_Jahr_2025_FINAL.pdf.
- Strube Martins, S.; Wernick, W. (2020): Regional differences in residential demand for very high bandwidth broadband internet in 2025, in: Telecommunications Policy, Volume 45, Issue 1, February 2021.
- U.S. Department of Transportation (2014): AERIS-applications for the environment: real-time information synthesis: eco-signal operations modeling report, publication number FHWA-JPO-14-185.

van der Vorst, Tommy; Brennenraedts, Reg (2018): Understanding the demand growth for digital connectivity. The 22nd Biennial Conference of the International Telecommunications Society: "Beyond the boundaries: Challenges for business, policy and society", June 24th - 27th, 2018, Seoul, Korea, International Telecommunications Society (ITS), Seoul, https://www.econstor.eu/bitstream/10419/190350/1/B1_2_Vorst-and-Brennenraedts.pdf.

VAUNET (2019): .VAUNET-Mediennutzungsanalyse, Mediennutzung in Deutschland 2018, https://www.vau.net/system/files/documents/vaunet_mediennutzung-2018-publikation.pdf.

Wikipedia (2020): IEEE 802.11, https://en.wikipedia.org/wiki/IEEE_802.11

WiFi (2021): Roytlat, Alex: Wi-Fi 6E and 6 GHz Update, WiFi Alliance Seminar, 11.03.2021, https://www.wi-fi.org/download.php?file=/sites/default/files/private/202103_Wi-Fi_6E_and_6_GHz_Update.pdf.

Wireless World Research Forum (2016). Outlook: Visions and research directions for the Wireless World – A New Generation of e-Health Systems Powered by 5G. White Paper, p.19. ITU (2014), "The Tactile Internet", ITU-T Technology Watch Report, Geneva, p.6.

Won, M., Sahu, S., Park, K.-J. (2019): DeepWiTraffic: Low Cost WiFi-Based Traffic Monitoring System Using Deep Learning, in: 2019 IEEE 16th International Conference on Mobile Ad Hoc and Sensor Systems (MASS), Monterey, CA, USA, 2019, pp. 476-484.

Yang et al. (2020): Optimization of real-time traffic network assignment based on IoT data using DBN and clustering model in smart city, Future Generation Computer Systems, Volume 108, July 2020, pp. 976-986.

Annex A: Methodology and assumptions of bandwidth demand model

The starting point for the estimation of bandwidth demand in the WIK market potential model is the end customer’s usage behaviour. The model focuses on “unconstrained” bandwidth demand i.e. household demand assuming no technical and commercial restrictions, such that connections of any bandwidth are available. The model is not targeted at explicitly estimating end users’ willingness to pay for additional bandwidth.⁸⁰

The following figure shows the methodology used for the market potential model.

Figure A 1: Methodology of the WIK market potential model

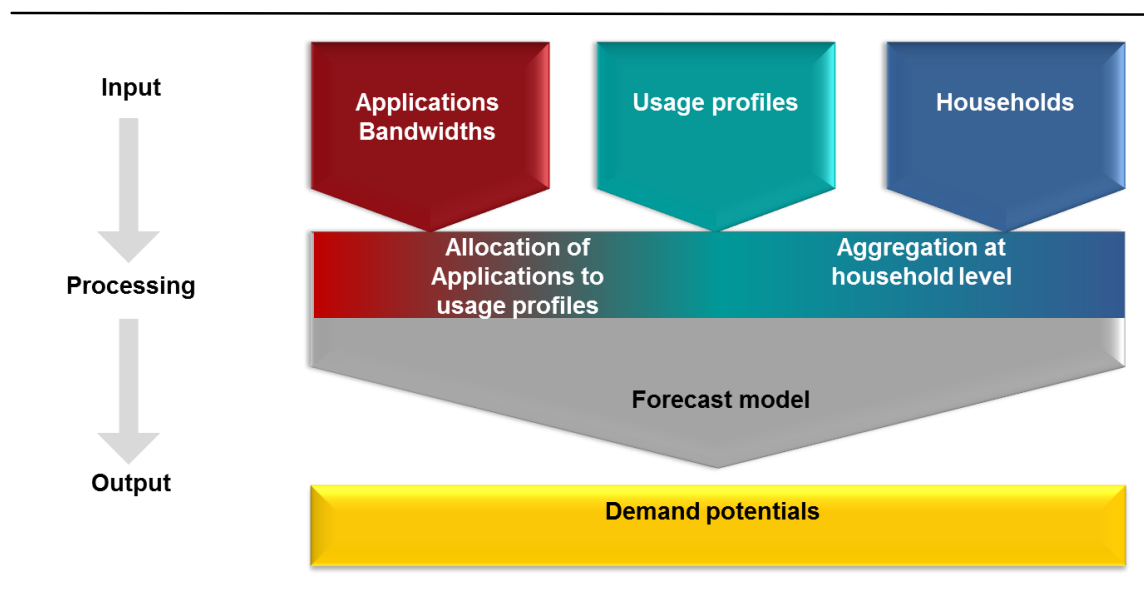

Source: WIK-Consult

1. Bandwidth and quality requirements

For each of the applications considered in the model, assumptions have been made on the likely bandwidth requirements (both downstream and upstream), as well as packet loss and latency requirements by 2025.

Bandwidth growth rates among others have been estimated based on an analysis of the development of historic data volumes and data rates. In the past, three factors contributed to growing data volumes: (i) increasing bandwidth requirements (ii) increasing number of users and devices., and (iii) increased use of specific applications within the user base. Historic growth rates in data volumes may give some indication of

⁸⁰ For indoor considerations the cost for high bandwidth WiFi is related to the cost of the access point and thus not so relevant.

bandwidth requirements, but could overstate them. The development of average data rates used by households is more likely to reflect the historical development of bandwidth demand as the size of households statistically remains rather stable over time.

Growth in bandwidth demand is driven by the requirements of applications and the number of devices used in a household so this needs to be taken into account when making assumptions on growth rates for bandwidth demand based on historical data. At the same time, as consumers may have been constrained by the limited availability of high bandwidth broadband connections, this assessment may understate growth bandwidth demand that would have occurred in an unconstrained environment.⁸¹

Furthermore, it is necessary to take into account the fact that future bandwidth requirements for applications cannot be explained with reference only to current data regarding the usage of existing applications and state-of-the art applications. Rather, it seems likely that there will be a residual growth of speed requirements and Internet traffic volume which cannot be explained by the growth of existing services categories.⁸²

The assumptions on future bandwidth requirements have also been supported by a review of desk research on data requirements of individual applications⁸³ and have been discussed with industry experts.

⁸¹ Strube Martins, S.; Wernick, W. (2020).

⁸² This has been discussed by van der Vorst, Tommy; Brennenraedts, Reg (2018) ety".

⁸³ See for example Fraunhofer FOKUS (2016); Cisco (2019) FTTH Council (2016) CAICT and HUAWEI Technologies Co. Ltd (2017).

Table A 1: Application categories with their capacity and quality requirements 2025

Application category	Downstream (Mbps) in 2025	Upstream (Mbps) in 2025	Packet loss	Latency
Basic Internet	≈20	≈16	o	O
Home office/VPN	≈250	≈250	+	+
Cloud Computing	≈250	≈250	+	++
State of the Art Media and Entertainment (4k, 3D, HD)...	≈150	≈30	++	+
Progressive Media and Entertainment (8k, ...)	≈300	≈60	++	+
Communication	≈8	≈8	++	+
Video Communication (HD)	≈25	≈25	++	++
Gaming	≈300	≈150	++	++
E-Health	≈50	≈50	++	+
E-Home/E-Facility	≈50	≈50	o	O
Mobile Offloading	≈15	≈12	o	O

Notes:

- O = Low specific importance
- +
- ++ = Very high importance

Source: WIK.

The bandwidth increases shown result from speed requirements (i.e. applications, which can be only be used if certain data rates are available (e.g. video streaming)) as well as data volume requirements associated with specific applications. The latter could also be used with lower bandwidths (from a technical point of view), but tend to be unattractive if low down- or upload speeds make use of the service too time consuming. Examples where low upload speeds could constrain usage include the use of the cloud as files server or software updates taken from the cloud.

WIK's model does not reflect aggressive assumptions concerning compression. This means that if there are substantial advances in compression technologies in future, the unconstrained bandwidth demand forecasts would (other things being equal) be overstated. More conservative approaches e.g. reflecting aggressive assumptions concerning compression technologies assume lower bandwidth requirements.⁸⁴ There are several reasons behind the decision not to assume aggressive compression scenarios in the WIK model:⁸⁵

- In this model there are no technical and commercial restrictions. Content providers that do not have to consider technical restrictions are likely to develop applications without the need to concentrate on reducing the bandwidth requirements of their innovative products.
- There may be advantages from the absence of restrictions, as better broadband infrastructure is likely to create incentives for new and innovative applications to be developed, without the need to consider infrastructure as a potential bottleneck.
- For a number of digital applications, bandwidth is not the only nor the main requirement to make them attractive and usable. Rather, the quality requirements concerning low latency, packet loss rate and jitter are of great importance. However, these parameters cannot readily be addressed using compression techniques.
- Compression methods are not only detrimental to quality (signal quality and delay times) but also involve high costs themselves and have an environmental impact as they typically require more powerful HW for faster compression/decompression. Moreover, the codecs of compression rates have grown at a lower rate than the growth rate of the data volume for audio-visual content (without compression). Further, images for medical use may require high resolution quality and therefore should not be compressed at all (see also Section 3.3.1)⁸⁶

It can be assumed that in private households digital applications such as TV and gaming are typically used intensively from 8 p.m. in parallel with applications, such as cloud and mobile offloading. While there is a share of the population which uses the Internet while watching TV,⁸⁷ applications such as gaming, progressive TV and VPN

⁸⁴ See for example Frontier Economics (2017).

⁸⁵ Strube Martins, S.; Wernick, W. (2020).

⁸⁶ There are predictions that codecs will not be able to compress efficiently by 2020 so that efforts are being made to develop a video codec based on neurological science to achieve an efficient compression. See Doutsis, E. (2017).

⁸⁷ In Germany for example, market research by BVDW shows that 54% of online users watch TV and use the internet in parallel on their Laptop/Tablet or Smartphone. See BVDW (2019).

are only allocated to one user profile and are not used in parallel with applications as e-Health, e-Home or video communication.⁸⁸

The time from 8 p.m. onwards is considered the peak time for Internet users to use for digital media⁸⁹. This time window is referred to as the busy hour in network planning.

The WIK market potential thus determines a peak bandwidth demand for the busy hour and is oriented towards the logic of network planning, under which the capacity network infrastructures is aligned with bandwidth needs during the main load phase.

2. User categories in Germany

The future share of user categories as a proportion of the total population is influenced by the fact that younger generations (with a much higher affinity for technology) will in turn become household decision-makers, and digital applications will be more widespread than they are today. Looking at the proportion of households with Internet access in Germany, we can see that it has increased steadily from 69% in 2008 to 90% in 2018⁹⁰. Households are typically connected to the Internet every day or almost every day. 86% of households with Internet access had a broadband connection in 2018⁹¹. The proportion of Internet users in the 10-44 age group is 99%, while 95% of 45-65 year olds use the Internet. In contrast, only 63% of the 65+ age group use the Internet⁹². It can therefore be assumed that only a small proportion of the population will not use the Internet in 2025. WIK's market potential model assumes that by 2025 more than 90% of users will have a broadband connection going into their home.

Only the population aged 15 and over is taken into account in the model, which underscores the conservative approach of the market potential calculation when one considers that the group of users under 15 years of age are highly likely to belong to the digital native segment.

⁸⁸ For a detailed discussion of user profiles in the Germany and the UK please refer to Strube Martins, S.; Wernick, C.; Plückebaum, T.; Henseler-Unger, I. (2017), and Godlovitch, I.; Plückebaum, T.; Strube Martins, S.; Gantumur, T.; Elixmann, D.; Tas, S.; Arnold, R.; Wernick, C. (2018).

⁸⁹ See VAUNET (2019).

⁹⁰ Statistisches Bundesamt (2018).

⁹¹ Statistisches Bundesamt (2018).

⁹² Statistisches Bundesamt (2018).

3. User categories in the UK

Figure A 2: Internet user profiles in the UK in 2025

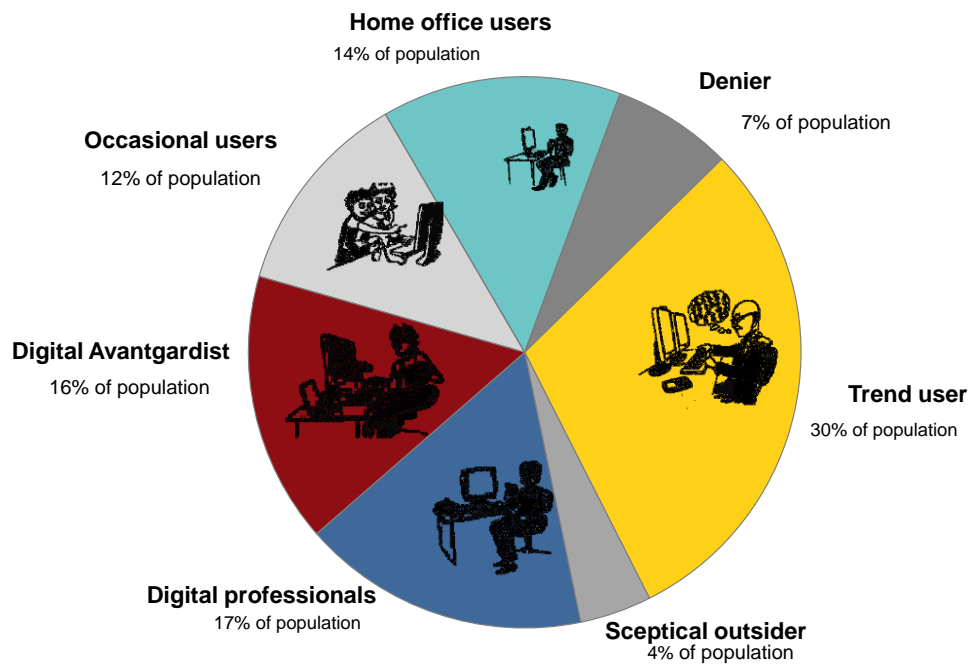

Source: WIK.

4. User categories in the Flemish Region

Figure A 3: Internet user profiles and share in population in Flanders in 2025

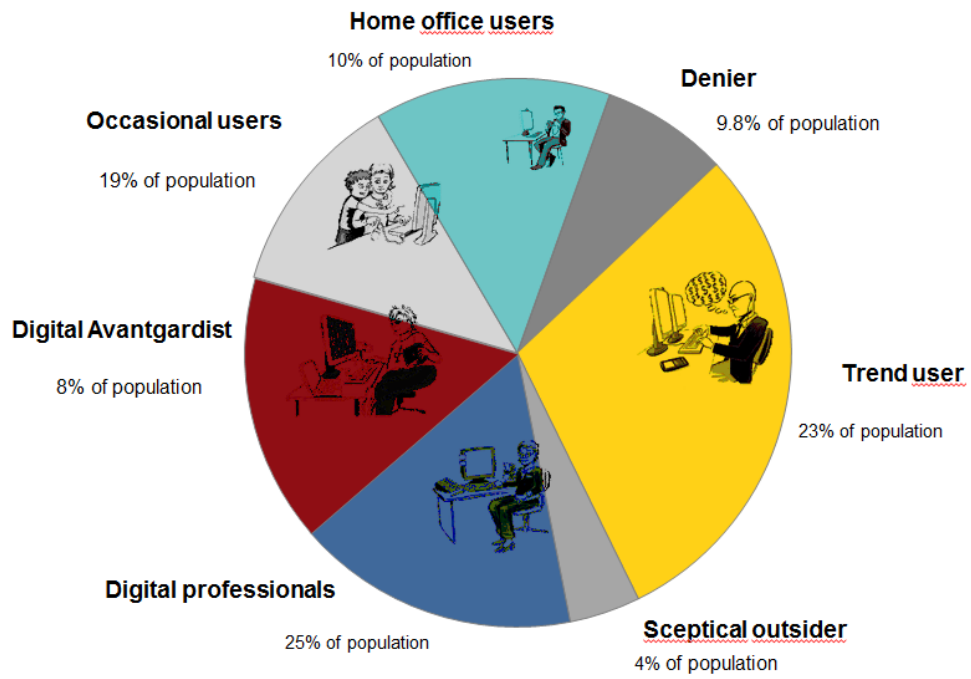

Source: WIK

Annex B: Detailed considerations for chapter 4 (WiFi technology)

This annex includes more detailed information about the different WiFi standards and its technological characteristics and explains the main differences, thus makes the performance improvements from generation to generation better understandable. It is based on chapter 4 of the main report.

B.1 WiFi 4 (IEEE 802.11n)

IEEE 802.11n standard is an amendment that improved on and is based on the older 802.11 standards. The 802.11n standard was retroactively labelled as WiFi 4 by the WiFi Alliance and operates on both the 2.4 GHz and the 5 GHz frequency bands. In comparison with older standards, the key feature of WiFi 4 is its support of the multiple-input multiple-output antennas (MIMO), which will be explained in detail in this section. The net data rate of WiFi 4 varies from 54 Mbps up to 600 Mbps. The IEEE approved the amendment and published it on October 2009.

B.1.1 Operating Frequency

The first WiFi standard developed by IEEE for Wireless Local Area Network (WLAN) was IEEE 802.11b and is referred as **WiFi 1**. WiFi 1 devices operate in the 2.4 GHz frequency band, and support data rates up to 11 Mbps using a 20 MHz bandwidth channel and Complementary Code Keying (CCK), as well as Direct Sequence Spread Spectrum (DSSS) modulation techniques/schemes.

As a successor to IEEE 802.11b, the WiFi standard IEEE 802.11a, also referred to as **WiFi 2**, has been developed. This was the first WiFi standard in which a multi carrier modulation scheme i.e. Orthogonal Frequency Division Multiplexing (OFDM) was introduced to support high data rates. WiFi 2-based routers operate at 5 GHz frequency band and support data rates up to 54 Mbps due to the use of a 20 MHz bandwidth channel.

The Standard IEEE 802.11g is referred to as **WiFi 3**, and is a successor to IEEE 802.11a or WiFi 2. WiFi 3 based routers operate in the 2.4 GHz frequency band, and support data rates of up to 54 Mbps using the available spectrum of WiFi 1 in OFDM modulation.

WiFi 4, however, was designed when both bands were available. WiFi 4 based routers operate at both frequency bands (2.4 GHz and 5 GHz), and support data rates up to 600 Mbps using a maximum of a 40 MHz channel in OFDM modulation. Manufacturers use a variety of terms to inform the user about the operating frequency bands for end-user devices. One of the more common names is “802.11ng” for 802.11n devices that operate in the 2.4 GHz band, and “802.11na” for 802.11n devices that operate in the

5 GHz band. Dual-band devices may be labelled in a variety of ways, such as “Dual Band 802.11n” or “802.11agn.” In order to avoid confusion with all the abbreviations associated with technical standards, a new numbering scheme based on the generation for each WiFi technology has been adopted.

B.1.2 Capabilities and Benefits

The source of the raw speed of WiFi 4 is the Multiple Input Multiple Output (MIMO) technology, which allows a single radio channel to support multiple data streams. Before WiFi 4, the transmitter and receiver were Single Input Single Output (SISO) devices. From the transmitter’s antenna, the same data stream flew out in every direction, bouncing off walls and other obstacles, and then arrived at the receiver. If two paths between the transmitter antenna and the receiver antenna were out of synchronization, the resulting signal could be weak due to the interference between the paths. This phenomenon, known as multipath interference, was the bane of network designers because moving an access point slightly could dramatically improve coverage characteristics. As client devices moved around, they could move from “hot spots” to “cold spots” due to multipath interference. In a MIMO system, the transmitter and receiver can take advantage of multiple paths. Each path is associated with a different set of data, and therefore the resulting transmission is not subject to the same destructive effects of multipath interference. In this way, MIMO has brought WiFi 4 not only higher data rates but also better coverage and connectivity. MIMO technology can also be enhanced for beamforming. With an antenna array, it is possible to arrange transmissions such that the energy is focused or directed towards a particular physical location. By concentrating energy in one direction, it is possible to improve the signal to noise ratio (SNR) and the transmission speed, though a complex set of trade-offs also limits the raw capability of beamforming.

To increase speed beyond the capabilities offered by MIMO, WiFi 4 offers the option for wider channels. By doubling channel width, it is possible to double data rates. Network administrators must carefully consider a set of trade-offs in using wider channels. In return for higher speed, radio network planning becomes more complex due to a higher demand for spectrum, and with the coexistence with previously installed networks based on 20 MHz channels becomes a concern. The wider 40 MHz channels also have a higher potential to interfere with non-802.11 standards or technologies such as Bluetooth, which is one of the major reasons why 40 MHz channels must be disabled by default in the 2.4 GHz band to avoid the overlapping channels in this band.

Simultaneous development on WiFi 2 used Orthogonal Frequency Division Multiplexing (OFDM) to establish the speed of 54 Mbps. WiFi 2 required the use of new spectrum, and the main innovation in WiFi 3 was to bring the OFDM technology into the 2.4 GHz band to make higher speeds widely available. However in WiFi 4, the main feature is the inclusion of MIMO that enabled the transmission of multiple simultaneous data

streams. WiFi 4 broke new ground in other ways as well, most notably by standardizing wider channel bandwidths which will be further discussed in the following section.

B.1.3 Channel Structure

WiFi 4 introduced channel bonding, which enabled 40 MHz widths. Bonding channels increases throughput, which can improve network performance. Thus, 40 MHz WiFi channels have higher throughput than 20 MHz ones. The 20 MHz WiFi channels are generally referred to as “narrow channels” or “narrow widths”. Whereas 40, 80, and 160 MHz WiFi channels are labelled as “wide channels” or “wide widths”. There are also downsides to channel bonding. While 40 MHz might have higher throughput than 20 MHz, it also reduces the number of non-overlapping channels, which consequently increases the probability for interference.⁹³ Moreover, not all WiFi client devices support channels other than 20 MHz so compatibility can be another concern.

The structure of the channel in WiFi 4 is essentially the same as previous generations. Both are based on OFDM, and therefore, both divide the radio channel into a number of subcarriers that are packed closely together and precisely enough that they are orthogonal to each other. WiFi 4 brings several minor improvements to the structure of the channel. It uses OFDM and reuses the same modulation and coding schemes. WiFi 4 increases the utilization of the radio spectrum while retaining the common 20 MHz channel width used by prior WiFi standards (802.11). Within the 20 MHz channel, however, WiFi 4 improves spectral efficiency by adding subcarriers that were unused in WiFi 2 and 3, as shown in Figure B 1.

Figure B 1: Channel structure comparison between WiFi 3 (52 carriers) and WiFi 4 (56 carriers)

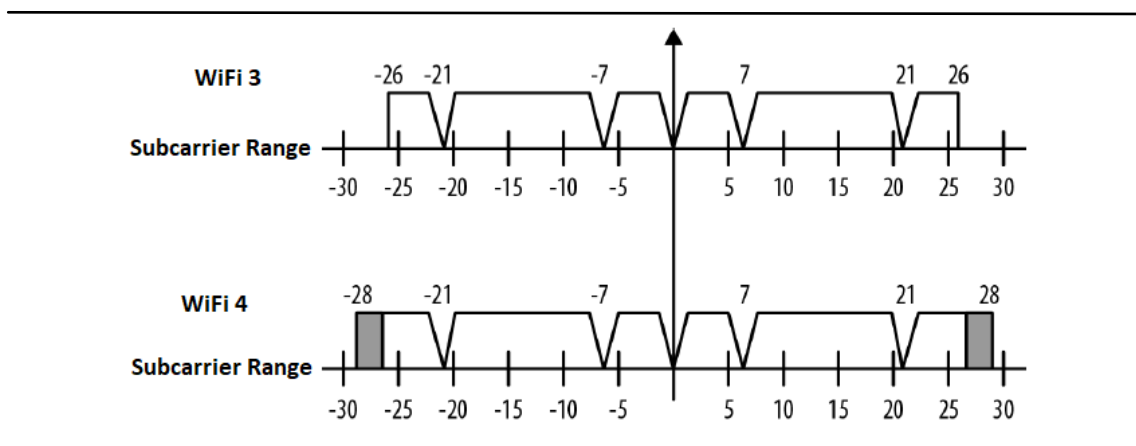

Source: Gast (2012)

⁹³ A channel can serve individual terminal equipment in an individual wireless link. The more channels the more terminal equipment can be served individually, the smaller the channel width (20 – 160 MHz), the less bandwidth it can provide. Modulation techniques influence the bandwidth/ capacity of a radio link.

Even though WiFi 4 adds four data subcarriers, increasing throughput by about 8%, it does not need to add any pilot subcarriers. Pilot subcarriers are used to provide channel measurement and calibration, and are a form of overhead. Just as MIMO increases the efficiency of a data transmission, it increases the efficiency of the pilot carrier operation. In a MIMO system, each subcarrier will be received through each of the received radio chains, and thus, will provide more information on the state of the channel as in a SISO systems. The second change made by WiFi 4 is that it supports operation in wider 40 MHz channels. Although the standard describes several methods of operating a 40 MHz channel, by far the most common is that two adjacent 20 MHz channels are treated as one channel and as a single 40 MHz contiguous spectrum block.⁹⁴

Figure B 2: Comparison between 20 MHz and 40 MHz channels in WiFi 4

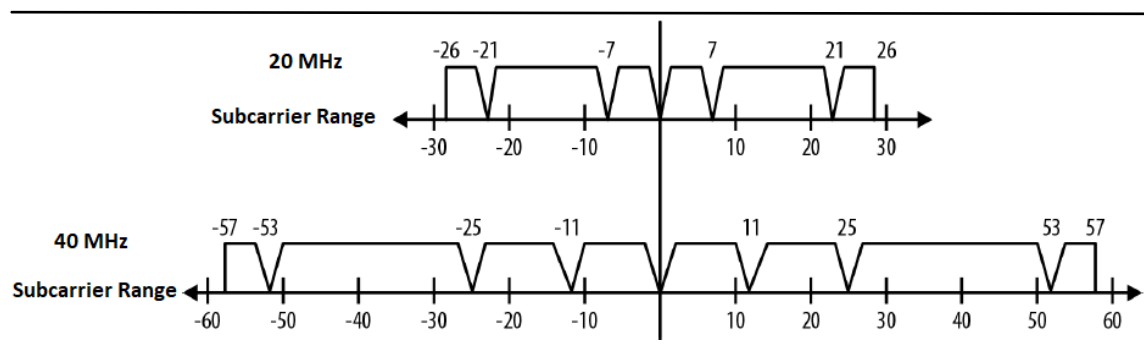

Source: Gast (2012)

WiFi 4's 40 MHz channels more than double the throughput when compared to the traditional narrow channels because the 40 MHz channel format decreases overhead as a fraction of the channel. Pilot carriers are an overhead expense required in OFDM, and do not transmit any data from higher protocol layers. WiFi 4 doubled the channel width from 20 MHz to 40 MHz, but only increased the number of pilot carriers by half. By using the increased effectiveness of pilot carriers in a MIMO system, the spectral efficiency of the channel increases by 4%⁹⁵.

B.2 WiFi 5 (IEEE 802.11ac)

IEEE 802.11ac, or WiFi 5, is a standard for a local radio network that was adopted in November 2013. The WLAN standard IEEE 802.11ac provides for a transmission speed

⁹⁴ Even though the center frequency of a 40 MHz channel moves upward, the “name” of the channel does not change. For example, a 20 MHz channel operating on channel 60 can be used next to a 20 MHz channel operating on channel 64. However, an AP advertising a 40 MHz bandwidth at channel 60 occupies the spectrum for both, channel number 60 and channel number 64. Figure B 2 illustrates and compares the differing channel widths (20 MHz, and 40 MHz).

⁹⁵ Gast (2013).

in the gigabit range. Strictly speaking, the standard defines a maximum calculated data rate of 6,936 Mbps⁹⁶. WiFi 5 is an evolution from WiFi 4 and not a revolutionary technology or standard. Many of the techniques used to increase speed in WiFi 5 are familiar after the introduction of MIMO. Unlike WiFi 4, which developed major new MAC features to improve efficiency, WiFi 5 uses familiar techniques and takes them to a new level, with one exception. Rather than using MIMO only to increase the number of data streams sent to a single client, WiFi 5 involves a multi-user form of MIMO that enables an access point (AP) to send to and receive from multiple clients at the same time.

The design constraints and economics that kept WiFi 4 products at one, two, or three spatial streams have not changed significantly for WiFi 5, with first-wave WiFi 5 products built around 80 MHz and delivering up to 433 Mbps (low end), 867 Mbps (mid-tier), or 1300 Mbps (high end) at the physical layer. However, second-wave products, or WiFi 5 Wave 2 as they are sometimes referred to, support more channel bonding and spatial streams, with plausible product configurations operating at up to 3.47 Gbps.

B.2.1 Operating Frequency

Unlike WiFi 4, which operated all across the unlicensed spectrum bands allocated to wireless LANs, WiFi 5 is restricted to 5 GHz operation only. Therefore, dual-band Access Points (APs) and clients will continue to use WiFi 4 at 2.4 GHz. However, WiFi 5 clients operate in the less crowded 5 GHz band. Current home wireless routers are likely WiFi 5-compliant, and operate in the 5 GHz frequency space. Some router vendors include technologies that support the 2.4 GHz frequency via WiFi 4, providing support for older client devices that rely on previous generation WiFi signals (802.11b/g/n), while also providing additional bandwidth for improved data rates.

B.2.2 Capabilities and Benefits

WiFi 5 is designed to be compatible and coexist efficiently with existing previous generation WiFi devices. WiFi 5 achieves its raw speed increase by achieving improvements in three different dimensions:

- More channel bonding
- More spatial streams and denser modulation scheme
- Beam forming and multi-user MIMO (MU-MIMO)

1. More channel bonding (wider channels)

WiFi 5 introduces two new channel sizes: 80 MHz and 160 MHz. Just as with WiFi 4, wider channels increase speed. In some areas, 160 MHz of contiguous spectrum is

⁹⁶ Elektronik Kompendium (2020).

hard to find, so WiFi 5 introduced two forms of 160 MHz channels: a single 160 MHz block, and a “80+80 MHz” channel that combines two 80 MHz channels and gives the same capability of spectrum.

2. More spatial streams and denser modulation scheme (256-QAM)

Quadrature Amplitude Modulation or QAM enables more packets to be sent, more efficiently by modulating the amplitude and phase of a signal. Like previous 802.11 amendments, WiFi 5 transmits a series of symbols, each of which represents a bit pattern. By using a more complex modulation that supports more data bits, it is possible to send eight bits per symbol period (256-QAM) rather than 6 bits in a symbol period (64 QAM), which leads to a gain of 30 percent. WiFi 5 specifies up to eight spatial streams, compared with WiFi 4’s four spatial streams, at the AP. The extra spatial streams can be used to transmit to multiple clients at the same time. With the ability to transmit at high speeds to multiple clients simultaneously, WiFi 5 will speed up networks even more than might be apparent from simply looking at the data rate. Figure B 3 depicts how the performance of WiFi 5 APs is enhanced compared to WiFi 4 APs through the wider channels, the denser modulation scheme, as well as the additional spatial streams.

Figure B 3: How WiFi 5 accelerates WiFi 4

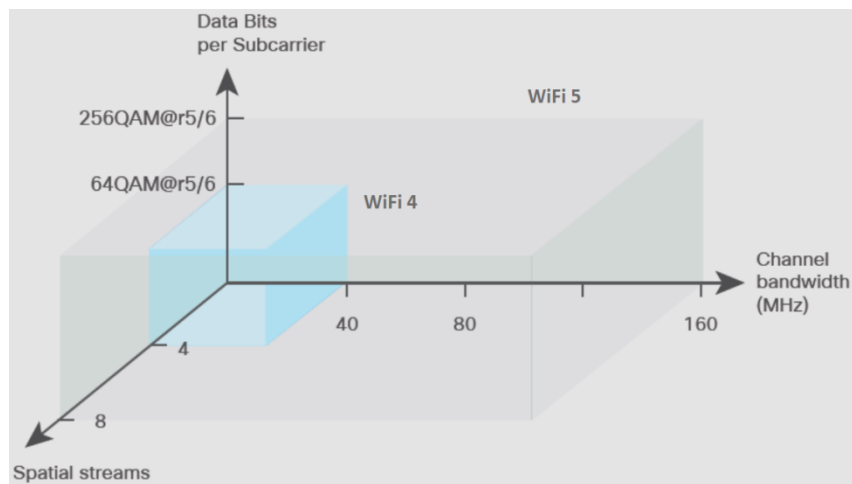

Source: Cisco (2018)

3. Beamforming and Multi-User MIMO (MU-MIMO)

Beamforming is a process by which the sender of a transmission can direct its energy toward a receiver to increase the Signal-to-Noise Ratio (SNR), and hence the speed of the transmission. Beamforming can be grouped into two main types: explicit, and implicit beam forming. Explicit beamforming is based on the transmitter and receiver exchanging information about the characteristics of the radio channel to extract

maximum performance from the radio channel based on channel quality measurements, while implicit beamforming is based on inferences of channel characteristics when frames are lost. Explicit beamforming is generally more powerful because the channel measurements are more detailed than the inference of loss, but the explicit measurement and exchange of data on the radio link must be supported by both ends of the link. Transmitting beam-formed frames typically requires an antenna array capable of altering its pattern on a frame by frame basis, which is why the term “smart antenna” is often used in discussions of beamforming. To change the radiation pattern on a frame-by-frame basis, smart antennas are controlled electronically.

WiFi 5 significantly simplifies the beamforming specifications to one preferred technical method. Beamforming in WiFi required two devices to implement mutually agreeable beamforming functions from the available menu of options. Very few vendors implemented the same options, and as a result, there was almost no cross vendor beamforming compatibility. As the key features of WiFi 5 depended on beamforming, however, a simplification was required to enable the core technology.

Multi-User MIMO (MU-MIMO) represents the greatest potential of WiFi 5. Prior to WiFi 5, all 802.11 standards supported only Single-User MIMO (SU-MIMO), and every transmission sent was sent to a single destination only. Beamforming is occasionally used in such networks as a means of increasing the signal power over a portion of the AP’s covered area to increase the data rate at the receiver. Multi-User transmissions are a new capability within 802.11. radio waves, like any waves, added by superposition. If there are two receivers located in sufficiently different directions, a beam-formed transmission may be sent to each of them at the same time.

Figure B 4 compares the SU-MIMO technologies used in WiFi 4 with the new MU-MIMO used in WiFi 5. In Figure B 4(a), all of the spatial streams are directed to one receiving device. In 2013, multiple spatial streams were a commonplace technical innovation, supported in every WiFi 4 AP and almost every client device. In contrast, Figure B 4(b) shows what it means for a MIMO transmitter to be multi-user. In Figure B 4(b), the AP is transmitting four simultaneous spatial streams. The main advantage of MU-MIMO is that the four spatial streams are being transmitted to three separate devices. Two of the spatial streams are transmitted to a laptop supporting high-speed data transmission. Each of the other two spatial streams is transmitted to a single-stream device, such as a phone or tablet computer. To keep the three transmissions separate, the AP uses beamforming to focus each of the transmissions toward its respective receiver. For this type of scenario to work, it is necessary that the receivers are located in directions different enough so that focused transmissions avoid interfering with each other.

Figure B 4: Single-user MIMO vs. Multi-user MIMO

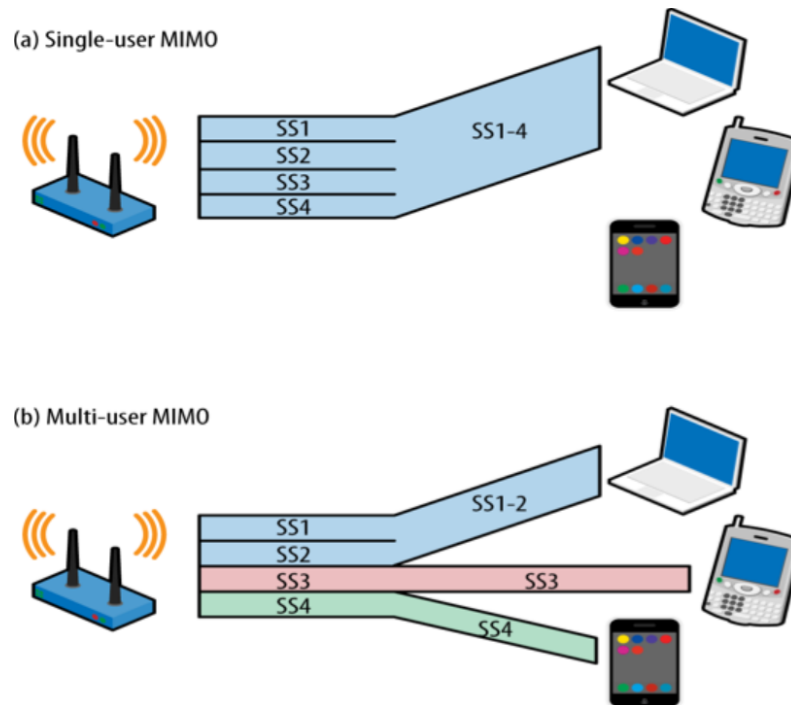

Source: On The Fly Wi-Fi (2014)

MU-MIMO has the potential to change the way WiFi networks are built because it enables better spatial reuse. One of the keys for building a WiFi network of any type is reusing the same channel in multiple places. For example, in Figure B 5(a), the radio channel is used for omnidirectional transmissions. When the AP transmits, the radio energy is received by both the laptop and the smartphone, and the channel may be used to communicate with only one of the devices at any point in time. One of the reasons why high-density networks are built on small coverage areas is that the same radio channel can be reused multiple times, and each AP in a dense network can transmit on the channel independently. MU-MIMO builds on the small cell approach by enabling even more tightly packed networks. In Figure B 5(b), MU-MIMO is in use in a spatially separated segment use. As a result, the AP can send independent transmissions within its own coverage area. Just like Ethernet switches reduced the collision domain from a whole broadcast segment to a single port, MU-MIMO reduces the spatial contention of a transmission. The simple world of Figure B 5 is an ideal depiction. In practice, there will always be some crosstalk between transmissions to different clients. As regards implementation, each of the multiple transmissions in Figure B 5(b) will be slower than the single transmission in Figure B 5(a), but the total throughput in the multiple transmission case will be larger.

Figure B 5: Spatial reuse per Access Point Vs. Spatial reuse per receiver

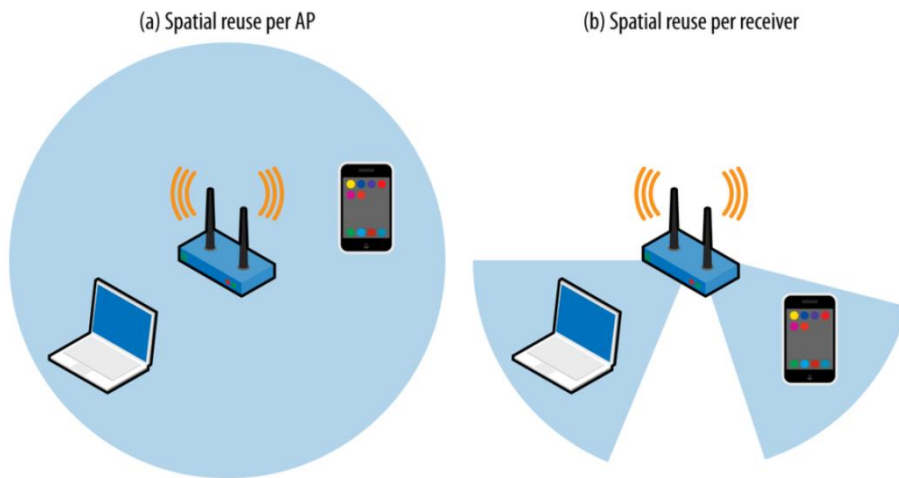

Source: Emami (2016)

B.2.3 Channel Structure

To increase channel throughput, WiFi 5 introduced two new channel widths. As in previous OFDM-based transmissions, WiFi 5 divides the channel into OFDM subcarriers, each of which has a bandwidth of 312.5 kHz. Each of the subcarriers is used as an independent transmission, and OFDM distributes the incoming data bits among the subcarriers. A few subcarriers are reserved and are called pilot carriers; they do not carry user data and instead are sent for supervisory, control, equalization, continuity, synchronization, or reference purposes. All WiFi 5 devices support 80 MHz channels, which doubles the size of the spectral channel over WiFi 4. It further adds a 160 MHz channel option for even higher speeds. Due to the limitations of finding contiguous 160 MHz spectrum, the standard allows for a 160 MHz channel to be either a single contiguous block or two non-contiguous 80 MHz channels. Figure B 6 shows the layout of channels in terms of their OFDM data and pilot carriers defined in WiFi 5, along with the channel formats from WiFi 4 for comparison. In Figure B 6, each horizontal line represents the layout of OFDM subcarriers in one type of channel, ranging from the 20 MHz channels first used with OFDM up to the widest channel that WiFi 5 has to offer. Pilot carriers are represented by the dips down in the line to show that they carry no data.

Figure B 6: WiFi 4 Channels Vs. WiFi 5 Channels

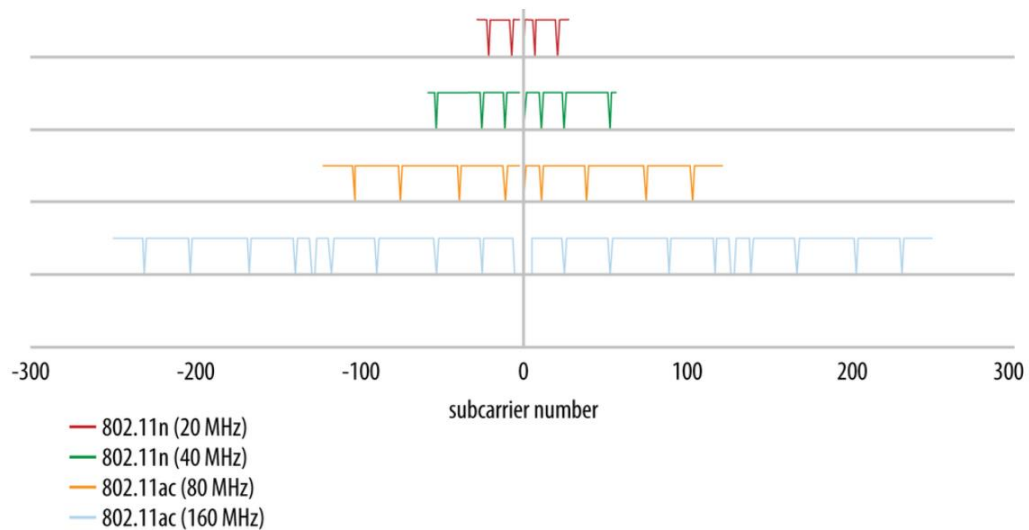

Source: Gast (2013)

B.3 WiFi 6 (IEEE 802.11ax)

For today's digital organizations and environments, delivering reliable network performance has never been as critical, challenging, as well as demanding. One reason is the meteoric growth and diversity of clients on wireless networks. Bandwidth demand is not primarily driven by individual applications such as TV/Video viewing, but rather by the simultaneous use of digital services in households. This mainly reflects several people in one household using applications with high bandwidth requirements and also, but to a lesser extent, the parallel use of applications/devices, such as simultaneous use of cloud and mobile offloading by one person. In Germany for example, more than 70% of households are predicted to demand bandwidths of 500 Mbps or more in 2025 (see traffic demand figures (Figure A 1)). As service applications such as video conferencing, video streaming, wireless interactive VR, e-Health, and remote teaching develop and expand, an increasing number of WiFi access terminals are deployed. Even the home WiFi network that has few end user terminals has become crowded with the access needs of more and more smart home devices and the simultaneous use of high end applications by several household members. Additionally, Internet of Things (IoT) development will bring more mobile terminals to the wireless network. The number of connected devices driven by the Internet of Things (IoT) is significantly growing, with 127 new IoT devices connected to the web every second. It is anticipated that 20.4 billion IoT devices will be online by the end of 2020, 31 billion by 2021, and 75 billion devices by 2025⁹⁷. At the same time, the variety of applications and traffic

⁹⁷ Review42 (2020).

being generated is evolving quickly. Video applications, for example, will represent 82 percent of all IP traffic in 2021, amounting to 1 million minutes of video transmitted through networks every second⁹⁸. Furthermore, consumers have increased expectations around network performance and voice quality. The pressure is clearly on to improve the wireless experience. In a world of limited bandwidth, that means increasing the capacity and efficiency of the network to accommodate high expectations. By doing so, WiFi can enhance customer retention, boost user satisfaction, increase productivity, and help in cutting network deployment costs.

As with previous generations, WiFi 6 (also known as IEEE 802.11ax standard) will improve high density performance and provide faster throughput. Additionally, this new generation of WiFi will augment customary speed and density improvements with new capabilities designed for technology trends of the future. IoT connections will represent more than half of all global connected devices by 2022. Virtual and augmented reality network traffic is poised to grow twelve fold by 2022. WiFi networks of the future need to be nimble and efficient to accommodate increased client density, high throughput requirements, and a diversity of new applications.

B.3.1 Operating Frequency

While WiFi 4 enhanced operation with both the 2.4 GHz and 5 GHz bands, WiFi 5 only focused on 5 GHz. WiFi 6 adds additional spatial streams by supporting both the 2.4 and 5 GHz bands. In addition, WiFi 6 operates in 20, 40, and 80 MHz, similar to WiFi 5. The added 2.4 GHz spectrum provides several benefits for longer range outdoor use cases and improved coverage for IoT devices. While the spectrum is noisy and congested, the better propagation abilities of 2.4 GHz combined with efficiency improvements of WiFi 6 should help maximize the potential of the 2.4 GHz band. Figure B 7 depicts the operating frequencies along the different WiFi generations and up to WiFi 6.

⁹⁸ Aruba Networks (2020).

Figure B 7: Operating frequencies in different WiFi generations

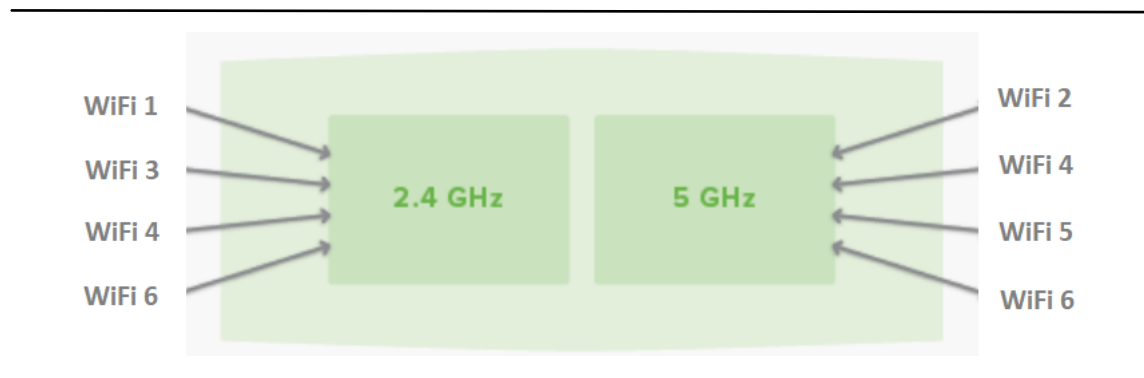

Source: Cisco (2019)

In a wireless communications system, signals with a relatively low frequency are more likely to penetrate obstacles than those with a relatively high frequency. A lower operating frequency indicates a longer wavelength, stronger diffraction capability, poorer penetration capability, smaller signal loss attenuation, and longer transmission distance. Although the 5 GHz frequency band can bring a higher transmission speed, the signal attenuation is larger. Therefore, the transmission distance is shorter than that of the 2.4 GHz frequency band. When deploying a high density wireless network, the 2.4 GHz frequency band is not only used for compatibility with old devices but also to ensure coverage of white spots in edge areas.

B.3.2 Capabilities and Benefits

Today's WiFi 6 will start to take over as the prominent wireless technology. With WiFi 6, there will no longer be haves and have-nots when it comes to WiFi density. We expect the early Technology adopters to be schools, colleges and other organizations that have up to this point been unable to implement wireless networks that can support higher densities due to budget limitations. Despite the challenges in the changing wireless landscape, users expect wireless deployments to be pervasive, and to support high capacity and a high density of clients. WiFi 6 is designed to meet these changing user needs. WiFi 6's performance will exceed WiFi 5 Wave 2 by over three to four times, support higher density with more efficient airtime, support a higher scale of client devices, and provide significant savings in battery usage. While WiFi 6 will be able to deliver theoretical data rate growth of around 37 percent, its largest benefit is the ability to deliver high efficiency performance in real world environments. As the number of clients increase, WiFi 6 will be able to sustain far more consistent data throughput than previous 802.11n amendments (including WiFi 4 and 5). There are controlled environments with a very small number of clients where previous generations of WiFi

may provide higher throughput. However, this is due to the longer frames and wider guard intervals of WiFi 6, which help provide resilience.⁹⁹

Essentially, there are two technologies that make a real difference in WiFi 6 which are orthogonal frequency division multiple access (OFDMA), and spatial reuse, which is also referred to as Basic Service Set (BSS) colouring. Additionally, WiFi 6 provides a slew of new features to address performance improvements and optimizations across multiple dimensions. The key features of WiFi 6 can be categorized in four categories as shown in Figure B 8: Spectral efficiency, High density, Long range, and power saving. Each category includes the performance improvements which will be illustrated in details in this Chapter.

Figure B 8: Key Features of WiFi 6

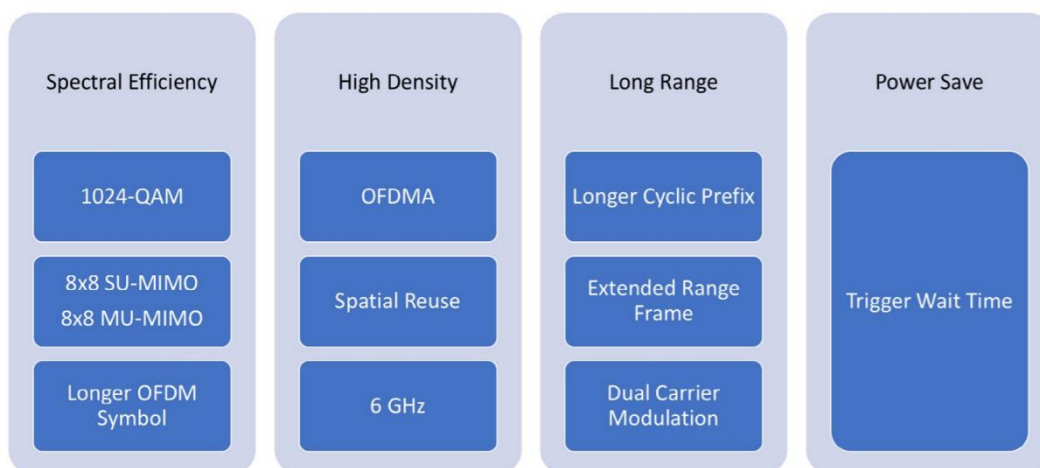

Source: Arista (2020)

B.3.2.1 OFDM Vs. OFDMA

One of the biggest benefits of WiFi 6 is the transition from Orthogonal Frequency Division Multiplexing (OFDM) towards Orthogonal Frequency Division Multiple Access (OFDMA). In current pre-WiFi 6 technologies, the OFDM mode is used for data transmission, and users are distinguished by time segment. OFDM is a digital multi-carrier modulation scheme that extends the concept of single subcarrier modulation by using multiple subcarriers within the same single channel. Rather than transmitting a high-rate stream of data with a single subcarrier, OFDM makes use of a large number of closely spaced orthogonal subcarriers that are transmitted in parallel. Each subcarrier is modulated with a conventional digital modulation scheme at low symbol rate. However, the combination of many subcarriers enables data rates similar to conventional single-carrier modulation schemes within equivalent bandwidths. During each time segment,

⁹⁹ Cisco (2019).

one user occupies all subcarriers and sends a complete data packet, as shown on the left hand side of Figure B 9.

WiFi 6 introduces a more efficient data transmission mode/technique, which is called Orthogonal Frequency Division Multiple Access (OFDMA). Since WiFi 6 supports the uplink and downlink Multi User (MU) mode, this mode can also be referred to as MU-OFDMA. It allows multiple users to reuse channel resources by allocating subcarriers to different users and adding multiple access in the OFDM system. Thus far, this technology has been used by many wireless technologies, such as LTE in mobile networks. In addition, the WiFi 6 defines the smallest sub channel as a resource unit (RU). Each RU includes at least 26 subcarriers, and users are distinguished by time-frequency RUs. The resources of the entire channel are divided into small fixed time-frequency RUs. In this mode, user data is carried on each RU. Therefore, on the total time-frequency resources, multiple users may simultaneously send data on each time segment, as shown on the right hand side of Figure B 9.

Figure B 9: OFDM Vs. OFDMA

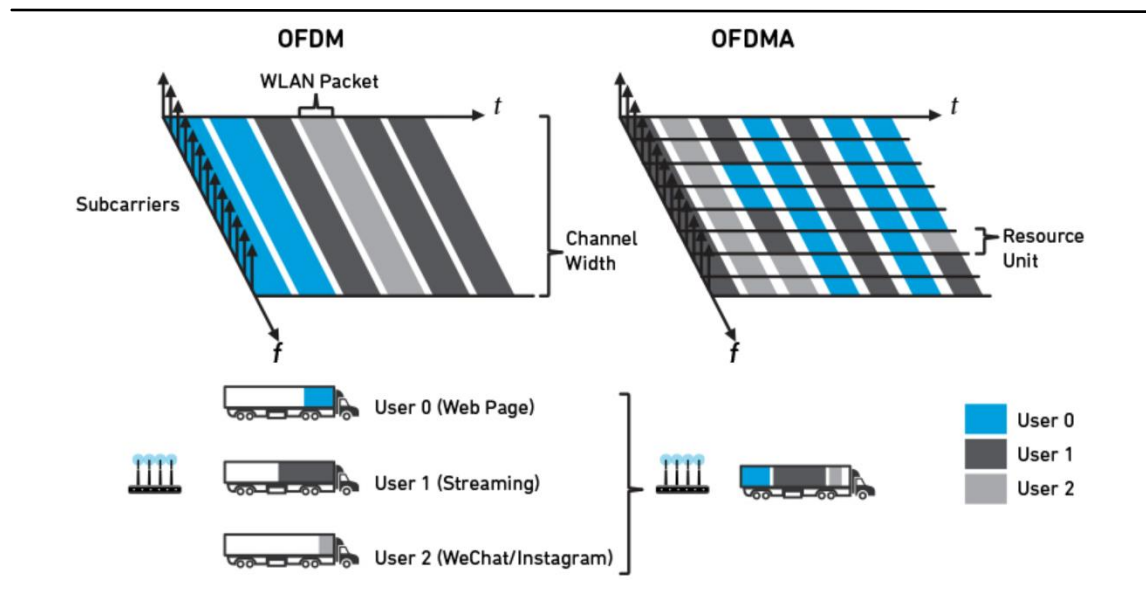

Source: Oorvo (2017)

In previous WiFi generations, a small transmission from a single client would be able to monopolize an entire channel. OFDMA allows more efficient transmission of data to multiple devices, allowing for a 20 MHz channel to be split into small RUs or sub-channels. A WiFi 6's AP can use the entire 20 MHz channel to send data to a single client or split the channel to send data to 9 clients using 9 RUs, which is predicted to bring transformational effects on WiFi channels efficiency. At the same time, OFDMA decreases the spaces between the subcarriers from 312.5 KHz to 78.124 KHz, packing even more resource units into the truck as shown in Figure B 10.

Figure B 10: Subcarrier spacing change in WiFi 6

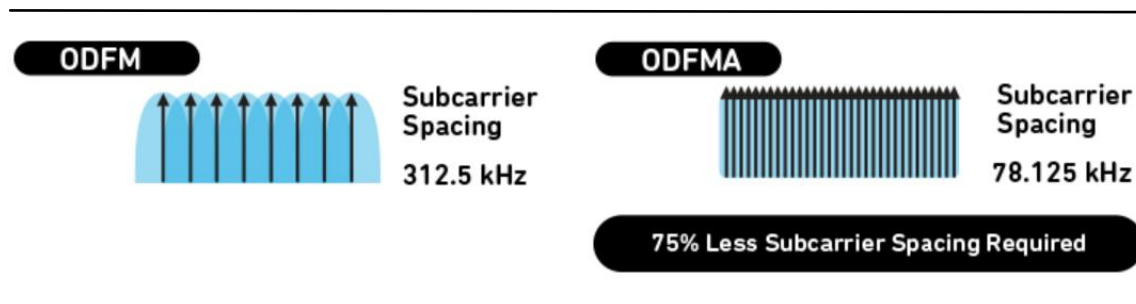

Source: Oorvo (2017)

In conclusion, advantages of OFDMA over OFDM can be realized through:

More efficient channel resource allocation: The transmit power can be allocated based on the channel quality, especially when the channel status of some nodes is not good. This can help allocate channel time-frequency resources in a more refined manner.

Better Quality of Service (QoS): earlier WiFi generations occupy the entire channel to transmit data. If a QoS data packet needs to be sent, it must wait until the current sender releases the complete channel. Therefore, a long delay exists. In OFDMA mode, one sender occupies only some resources of the entire channel. Therefore, data of multiple users can be sent at a time. This reduces the access delay of QoS nodes.

More concurrent users and higher user bandwidth: OFDMA divides resources of the entire channel into multiple subcarriers (subchannels). The subcarriers are further divided into several groups by RU type. Each user may occupy one or more groups of RUs to meet different bandwidth requirements.

B.3.2.2 Enhanced Modulation (256-QAM TO 1024-QAM)

As explained in section B.3.2, WiFi 5 has made 256-QAM available, while WiFi 6 will move to a higher constellation density of 1024-QAM. In optimal conditions where a single client is near the access point, it may be possible to achieve 2.5 times increase in throughput and 1.2 Gbps per spatial stream. When coupled with OFDMA, 1024-QAM significantly improves the noise threshold, offering high performance at bandwidth of 20 MHz or even less. With 256-QAM, the number of bits transmitted per OFDM symbol was 8 bits ($2^8 = 256$), and 1024-QAM increases that to 10 bits ($2^{10} = 1024$), allowing for a 25 percent increase in spectral efficiency as shown in Figure B 11. With more density comes increased importance for high signal-to-noise-ratio (SNR) as 1024-QAM has very little margin for error.

Figure B 11: Constellation maps of 256-QAM and 1024-QAM

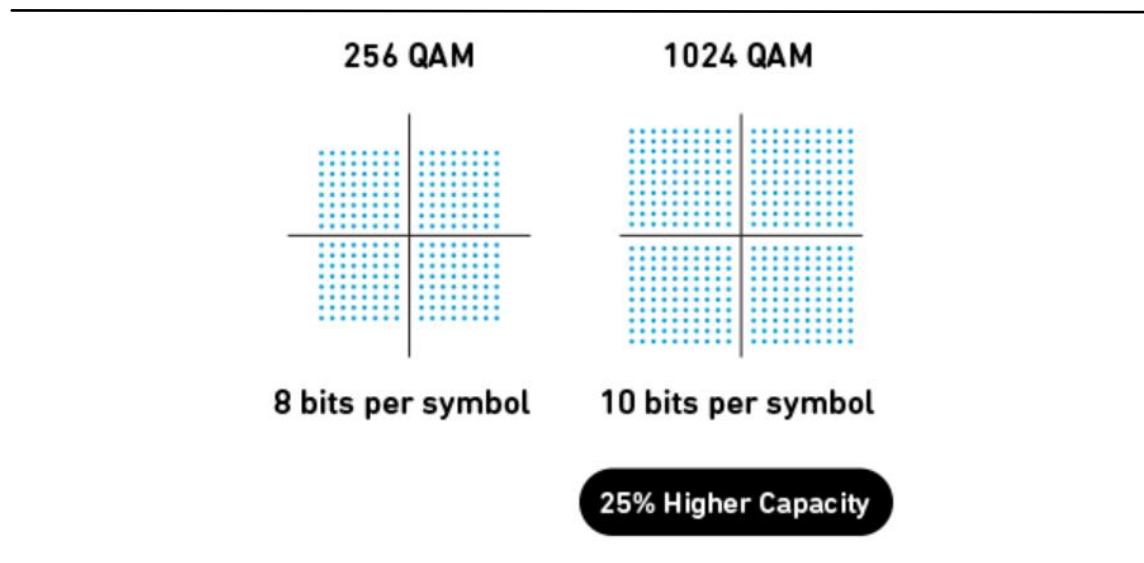

Source: Oorvo (2017)

With the introduction of two additional Modulation and Coding Sets (MCS) (10 and 11), WiFi 6 is able to deliver further throughput improvements over previous generations of WiFi. For example, WiFi 5, using a 20MHz channel and MCS8 could reach peak throughput of 86.7 Mbps. WiFi 6 is able to use MCS11 in a 20MHz channel, and deliver 143.4 Mbps, resulting in 65 percent throughput increase.

The successful application of 1024-QAM modulation in WiFi 6 depends on the channel conditions. Dense constellation points require great error vector magnitude (EVM) (which is used to quantize the performance of the radio receiver or transmitter in modulation precision) and receiver sensitivity. Moreover, the channel quality must be higher than that in other modulation types.

B.3.2.3 Enhanced MU-MIMO

As explained earlier in section B.3.2, MU-MIMO has been introduced since WiFi 5 (802.11ac), but only for DownLink (DL) 4x4 MU-MIMO. In WiFi 6 (802.11ax), the number of MU-MIMO is further increased, and DL 8x8 MU-MIMO is supported. DL OFDMA technology can be used to simultaneously perform MU-MIMO transmission and allocate different RUs for multi-user multiple access transmission, which increases the concurrent access capacity of the system and balances the throughput. Up Link (UL) MU-MIMO is another important feature introduced by WiFi 6. Similar to UL SU-MIMO, UL MU-MIMO uses the same channel resources to transmit data on multiple spatial streams by using multi-antenna technology of the transmitter and receiver. The only difference is that multiple data streams of UL MU-MIMO are from multiple users. WiFi 5 and earlier WiFi generations use UL SU-MIMO, where a user can receive data from

only one user, which is inefficient in multi-user concurrent scenarios. Since WiFi 6 supports UL MU-MIMO, UL OFDMA technology is leveraged to allow MU-MIMO transmission and multi-user multiple-access transmission at the same time. This improves the transmission efficiency in multi-user concurrent scenarios and greatly reduces the application delay. Although WiFi 6 allows OFDMA as well as MU-MIMO to work at the same time, they still bring the WiFi 6 networks different benefits, that are important to understand. OFDMA allows multiple users to subdivide channels (sub channels) to improve the concurrency efficiency. MU-MIMO allows multiple users to use different spatial streams to increase the throughput.

Earlier generations of WiFi theoretically supported the ability to pursue an 8x8 architecture, however none of the enterprise chipsets provided such a capability. In WiFi 5, the limited benefits and increased costs of 8x8 MIMO chipsets resulted in very little adoption of 8x8 MIMO architectures. As radio technologies have improved, the 8x8 MIMO functionality will finally be fully commercially supported with most enterprise WiFi 6 chipsets. The transition from fewer antenna transmission streams (e.g. 2x2 or 4x4) towards those supporting 8x8 MIMO offers increased upstream and downstream throughput, and significantly improved reliability.

B.3.2.4 Dynamic Clear Channel Assessment (CCA) and BSS Colouring

A channel allows only one user to transmit data within a specified time interval. If a WiFi AP and a STA detect transmission of another 802.11 radio on the same channel, they automatically avoid conflicts and wait for the channel to become idle for transmission. Therefore, each user uses channel resources in turn. Therefore, channels are valuable as well as critical resources on wireless networks. In high-density scenarios, channel allocation and utilization greatly affect the capacity and stability of the entire wireless network. As mentioned before, WiFi 6 can operate on the 2.4 GHz or the 5 GHz frequency band. In high density deployment scenarios, the number of available channels may be too small (especially on the 2.4 GHz frequency band). The system throughput can be increased by improving the channel multiplexing capability.

In earlier versions of WiFi, the mechanism of dynamically adjusting the clear channel assessment (CCA) threshold is used to reduce co-channel interference (interference caused by using the same channel). This threshold was fixed to -82 dBm, which meant that if an ongoing transmission was detected at -82 dBm or higher, all other potential transmitters had to back off. WiFi 6 provides a more flexible spatial channel reuse, where an AP or a client that wants to transmit on a currently busy channel can dynamically modify the CCA thresholds. To avoid interference, however, raising the CCA threshold above -82 dBm means that the AP must reduce its transmission power. Due to the mobility of WiFi STAs, co-channel interference detected on the WiFi network is not static however changes with the movement of the STAs. Therefore, the dynamic CCA mechanism is a very effective solution in WiFi networks.

Another very interesting feature introduced by WiFi 6 is the so called “Basic Service Set” or “BSS” colouring, which is a new co-frequency transmission identification mechanism. This feature aims at optimizing data transmission in dense and interference environments. The BSS colour field is added to the packet header between the access point and the STA to colour data from different BSSs and allocate a colour to each channel. The colour identifies a BSS that should not be interfered. The receiver can identify co-channel interference signals (interference in the same channel) and stop receiving them at an early stage, thereby avoiding collisions and high response and transmission times. If the colours are the same, the interference signals are considered to be in the same BSS, and signal transmission is delayed. If the colours are different, no interference exists between the two WiFi terminals. They can then transmit data on the same channel and at the same frequency. Figure B 12 depicts the advantage of considering the BSS colouring in WiFi networks.

Figure B 12: Advantage of BSS Colouring

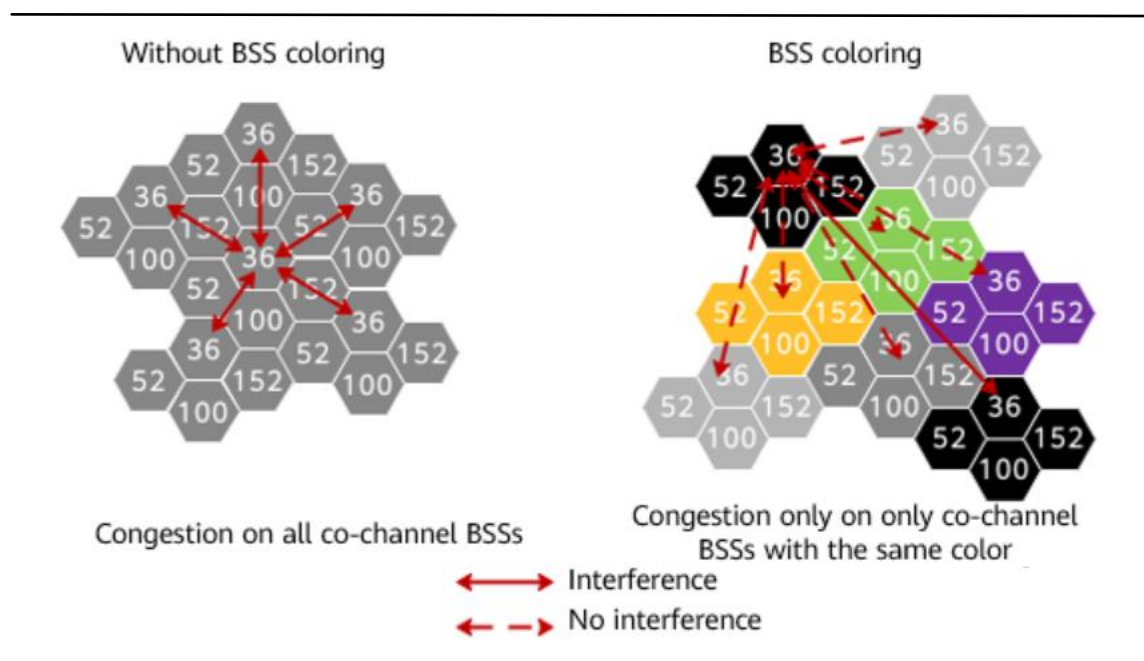

Source: Huawei (2020)

Having this feature, the channels with the same colour are kept far away from each other. The dynamic CCA mechanism is used to set such signals to be insensitive. In fact, they are unlikely to interfere with each other.

B.3.2.5 Long/extended Range

WiFi 6 uses the long OFDM symbol transmission mechanism. The data transmission duration increases from 3.2 μ s to 12.8 μ s. A longer transmission time can reduce the

packet loss rate of STAs. In addition, WiFi 6 can use only 2 MHz bandwidth for narrowband transmission, which reduces noise interference on the frequency band, improves the receiver sensitivity of STAs, and increases the coverage distance. To support large cells, WiFi 6 also defines the Extended Range (ER) BSS. The same AP can provide two types of BSS: ER and non-ER, with the former expected to have a larger coverage area than the latter. The ER feature is supported only for SU transmissions, in other words cannot be combined with OFDMA and/or SU-MIMO/MU-MIMO.

B.3.2.6 Target Wake Time (TWT)

Reducing energy consumption is a key factor of WiFi 6, especially for smart devices, which remain connected for long periods of time and transmit little information less frequently. WiFi 6 introduces a functionality called TWT (Target Wake Time). TWT is a negotiation based agreement, based on expected traffic activity between the AP and WiFi clients, to specify a scheduled target wakeup time for clients in power saving mode. This feature allows devices to remain in power saving mode until there is transmission or reception of data, prior negotiation with the access point, so battery life increases. In addition to the power saving benefits, the negotiated TWTs allow an AP to manage client activity by scheduling client stations to operate at different times and therefore minimize contention and overlapping between STAs. Unlike prior client power saving mechanisms, which require sleeping client devices to wake up in microsecond intervals, TWT could theoretically allow client devices to sleep for hours. TWT is thus an ideal power saving method for mobile devices and Internet of Things (IoT) devices that need to conserve battery life. It follows that IoT device manufacturers will take advantage of WiFi 6 radios in their IoT devices unlike other communication technologies such as Bluetooth, Thread, and Zigbee.

TWT setup frames are used between the AP and the client to negotiate a scheduled TWT. For each WiFi 6 client there can be as many as 8 separate negotiated scheduled wake up agreements for different types of traffic applications. WiFi 6 has also extended TWT functionality to include a non-negotiated TWT capability. Moreover, An AP can create wake up schedules and deliver TWT values to the clients via “broadcast TWT” procedure. Figure B 13 depicts the TWT operation between an AP and two WiFi STAs.

Figure B 13: TWT operation between an AP and 2 STAs

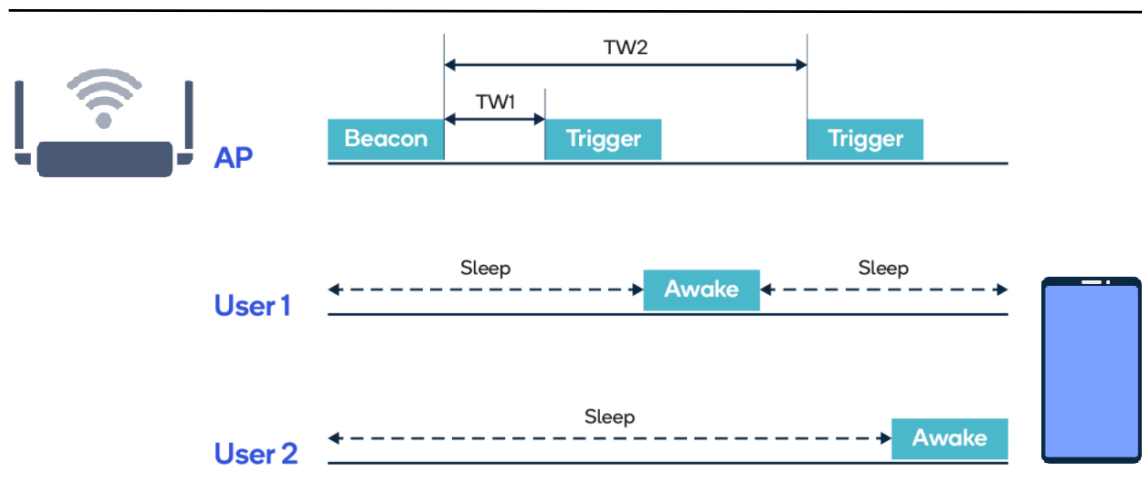

Source: Qualcomm (2019)

B.4 WiFi 6E

WiFi 6E is the industry name for users to identify WiFi devices that will operate in 6 GHz frequency band. WiFi 6E offers all the features and capabilities of WiFi 6 including higher performance, lower latency, and faster data rates extended into the 6 GHz band. Rapid development of products has already begun, with WiFi 6E devices expected to become available quickly following 6 GHz regulatory approvals. The additional spectrum capacity offered by WiFi 6E enables more WiFi innovation and delivers valuable contributions to consumers, businesses, and economies. WiFi 6E has been strongly advocated for by many innovation drivers in the WiFi industry. From chipset and equipment manufacturers to service providers and end users, all agree that more than doubling the available spectrum will revolutionize the WiFi user experience. Chipset manufacturers (e.g. Qualcomm, and Broadcom) have already announced new products capable of supporting the 6 GHz band¹⁰⁰.

On April 23, 2020 the Federal Communications Commission of the United States (FCC) - The United States agency in charge of regulating telecommunications - voted unanimously to make 1200 MHz of spectrum available for unlicensed use in the 5.925-7.125 GHz (6 GHz) band. While FCC has already notified the 6 GHz rules, European regulators are focusing only on the UNII-5 band (5.925-6.425 GHz) which means a spectrum of 500 MHz has been made available. Due to its similar characteristics and proximity to the 5 GHz band, where WiFi already operates, 6 GHz will bring additional spectrum capacity. The 6GHz band encompasses frequencies between 5.925 GHz and 7.125 GHz, thereby providing 1200 MHz spectrum. Therefore WiFi 6E can provide contiguous spectrum blocks to accommodate up to 14 additional 80 MHz channels or

¹⁰⁰ Qualcomm (2020).

7 additional 160 MHz wide channels, and spectrum less congested from legacy WiFi 4 or WiFi 5 devices. WiFi 6E utilizes the capabilities of 6 GHz to enable high bandwidth applications that require faster data throughput such as high definition video streaming and virtual reality, as well as lower latency connectivity for online gaming applications. In contrast to the US situation in Europe the lower 500 MHz UNII-5 band for WiFi 6 use just allows for 6 x 80 MHz or 3 x 160 MHz channels. For more background information reasoning the different regulatory decisions we refer to chapter 7.

WiFi 6E devices operating in the 6 GHz band in the US will be immediately able to take advantage of the benefits provided by this greenfield spectrum such as:

High Capacity: With 59 new 20 MHz channels available in the US in the 6 GHz band, and 24 new 20 MHz available channels in Europe, congestion issues will be immediately relieved. WiFi 6E APs will not need to compete for spectrum and will be able to operate on congestion-free channels.

Higher Speed: The availability of 1200 MHz of contiguous spectrum in the US enables 7 new 160 MHz channels and 14 new 80 MHz channels. Network administrators will be able to enable widespread use of wider channels without the risk of interference from overlapping channels and sufficient spatial reuse. Wider channels deployments will surely unlock multi Gigabit WiFi speeds for its end users.

Low Latency: IEEE's decision to reserve access of the 6 GHz band to WiFi 6 devices will reduce the latency and enable less than 1 ms latency for 6E devices¹⁰¹. First by removing all legacy slower devices and also by allowing only 802.11ax/WiFi 6 (OFDMA, MU-MIMO, 1024-QAM) capable devices, that can take full advantage of the capacity and latency improvement features provided by this technology.

WiFi 6E will enjoy all the features and functionalities of WiFi 6, in other words WiFi 6 and WiFi 6E devices are similar in all aspects except for the operation in the 6 GHz frequency band as shown below in Table B 1.

Table B 1: WiFi Evolution until today

	WiFi 4	WiFi 5	WiFi 6	WiFi 6E
Operating frequency bands	2.4 GHz, 5 GHz	5 GHz	2.4 GHz, 5 GHz	6 GHz
Modulation scheme	OFDM	OFDM	OFDMA	OFDMA
Channel width	20 MHz, 40 MHz	20 MHz, 40 MHz, 80 MHz, 160 MHz	20 MHz, 40 MHz, 80 MHz, 160 MHz	20 MHz, 40 MHz, 80 MHz, 160 MHz

¹⁰¹ Broadcom (2019).

	WiFi 4	WiFi 5	WiFi 6	WiFi 6E
Number of non-overlapping channels	2.4 GHz band: 3 x 20 MHz or 1 x 40 MHz 5 GHz band: 25 x 20 MHz, or 12 x 40 MHz	25 x 20 MHz, or 12 x 40 MHz, or 6 x 80 MHz , or 2 x 160 MHz	2.4 GHz band: 3 x 20 MHz or 1 x 40 MHz 5 GHz band: 25 x 20 MHz, or 12 x 40 MHz, or 6 x 80 MHz , or 2 x 160 MHz	In the US (1200 MHz): 59 x 20 MHz, or 29 x 40 MHz, or 14 x 80 MHz, or 7 x 160 MHz In Europe (500 MHz): 24 x 20 MHz, or 12 x 40 MHz, or 6 x 80 MHz, or 3 x 160 MHz
Highest modulation order	64-QAM	256-QAM	1024-QAM	1024-QAM
MIMO streams	Up to 4x4	Up to 8x8	Up to 8x8	Up to 8x8
MU-MIMO	No	Downlink MU-MIMO	Downlink and Uplink-MU-MIMO	Downlink and Uplink-MU-MIMO
Target Wake Time (TWT)	No	No	Yes	Yes
BSS Coloring	No	No	Yes	Yes
Extended Range Improvements	No	No	Yes	Yes

Source: Litepoint (2020)

IEEE 802.11be defines Extremely High Throughput Channels with a bandwidth of 320 MHz, Thus putting two 160 MHz channels together. In consequence the European 500 MHz 6E approach so far just enables one such channel, the US and others 1,200 MHz approach 3 of these channels for future use.¹⁰²

¹⁰² WiFi (2021)

Annex C: Case studies

This Annex refers to section 6. It shows various case studies in more detail, demonstrating the potential and positive impact of WiFi as an enabler to save GHG emissions.

Remote working and learning

A case study from Germany has analysed the correlation of GHG and teleworking for the Frankfurt/Rhein-Main region.¹⁰³ It focuses on those 350,000 commuters travelling to work by car. The average travel distance was 34 km, cars with combustion engines were taken into account as well as cars with electric motors. The number of passengers was also accounted for. Rebound effects of commuting were part of the calculation.

In sum, the authors found that a 20 % reduction in commuter traffic would result in GHG saving of 90,632 tons of CO₂ equivalents. This would amount to a net effect of 65,800 tons of CO₂ equivalents. They state that “the absolute effect of around 65,800 tons per year for a region with slightly less than 2.5 million inhabitants on just 2,500 square kilometres is quite substantial. Due to the fact that the region is densely populated, being a central part of a leading metropolitan German region, the overall relative effect (for the country) is much larger than that of a sparsely populated region of similar spatial size. In other words: in agglomeration regions such as Frankfurt/Rhein-Main it would be worth considering less commuting for a better environment.”¹⁰⁴

Similar results can be found in the field of remote education. Caird et al. (2015) investigated the environmental impact of remote learning “of 30 higher education (HE) courses in 15 UK institutions.”¹⁰⁵

They identified different sources of energy consumption and thus carbon emissions with HE systems including:

- Travel to and from the learning location
- Purchase and use of ICT devices and time spent per week using ICT devices on and off-campus
- Choice of residential accommodation and home energy use for student study and lecturers homework.
- Campus site operations

The results were striking: “Teaching models in the distance-based education system, including the Distance teaching, ICT-enhanced Distance teaching and Online teaching models, consumed on average 88% less energy and produced 83% fewer carbon

¹⁰³ Issa, M., Bergs, R. (2020). This source is applied for the entire description of this case study.

¹⁰⁴ Issa, M., Bergs, R. (2020), p. 18.

¹⁰⁵ Caird et al. (2015), p.1; This source is applied for the entire description of this case study.

emissions than the Face-to-face teaching and ICT-enhanced Face-to-face teaching models in the campus-based system.”¹⁰⁶

e-Health

One example of telemedicine is the so called CARTREF project in Wales.¹⁰⁷ “The catchment area for this project was Dwyfor Primary Care Cluster in the county of Gwynedd with a population of 25,000; 27% aged over 65 and 4% over 85. Patients within this area were selected on the basis of: progressive degenerative disease, more than five medications, aged 75 or over and more than three outpatient visits per month within general internal medicine.”

The main idea of the project is to save travel for elderly and fragile patients by bringing them closer to the medical staff via video conferencing. The patients could attend hospitals within their neighbourhood and correspond with specialists that are further away. This saves travel and time not only for the patients but also for the medical transport staff when used.¹⁰⁸

The environmental benefits were significant. They found that, “the distance travelled by patients was reduced by an average of 40 miles per patient per clinic. Based on around 90 patients (the number who took up the telemedicine clinics in an average year) this equates to 1.06 tonnes CO₂. The distance travelled by the consultant was reduced by 80 miles per clinic, equivalent to approximately 1 tonne CO₂ per annum.”¹⁰⁹

This project is part of the strategy of the UK NHS (National Health Service) to equip all its large healthcare settings with free WiFi,¹¹⁰ a strategy that could further support such services.

Another example comes from an analysis for the Umeå University Hospital in Northern Sweden. Holmner et al. (2014)¹¹¹ investigated the carbon reduction potential of telemedicine for two clinical units, a rehabilitation unit of the hand and plastic surgery and a speech therapy clinic. For the first unit 238 telemedicine appointments took place from January to December 2012 avoiding travel to Umea. For the second unit 481 therapy sessions were accounted for, taking place in the years 2005/06.

The CO₂ emissions relating to telemedicine were compared with those of physical visits to the hospital. For the telemedicine the following approach was used (cp. Figure C 1):

¹⁰⁶ Caird et al. (2015).

¹⁰⁷ Cp. <https://www.rcplondon.ac.uk/projects/outputs/future-hospital-development-site-betsi-cadwaladr-university-health-board>, last accessed 20/11/2020.

¹⁰⁸ Royal College of Physicians (2018), p.21.

¹⁰⁹ Royal College of Physicians (2018), p.20.

¹¹⁰ Gann, B. (2018), p. 52.

¹¹¹ Cp. Holmner et al. (2014) for the whole description of the case study.

Figure C 1: Methodology for measuring energy costs of telemedicine

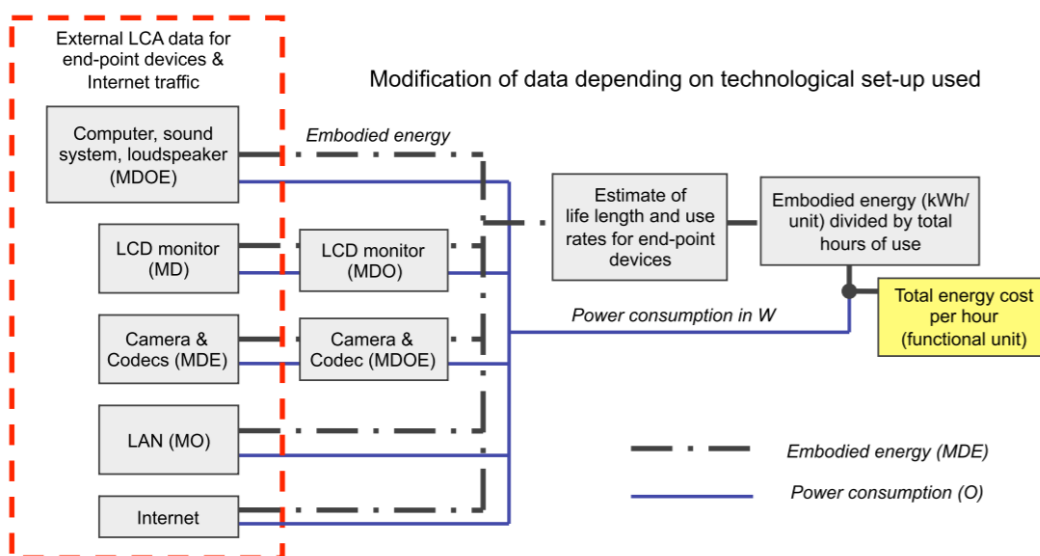

“Methods summary. The study is based on the method used by Ong et al. that builds on existing LCA data for end-point devices used in videoconferencing and emission estimates for Internet traffic [...]. Completeness of the LCA data varies between devices, but includes energy costs and/or carbon emissions generated during manufacturing (M), distribution (D), operation (O) and end-of-life stages (E). Emissions data for MDE are provided in, or has been converted to, energy equivalents (kWh/unit) and is called embodied energy. Data for the videoconferencing solution (monitors, camera and video codecs) were modified to better fit our technological set-up. To obtain the hourly carbon cost of telerehabilitation in kgCO₂, we divided the embodied energy with estimates of the life length and use rates of all equipment, and applied a conversion factor of 0.6 kg CO₂/kWh [...].”¹¹²

Source: Holmner et al. (2014), p. 3.

The LAN network that is referred to typically include switches to WiFi access points.¹¹³ For the physical visits the authors calculated that the total distance saved through Telemedicine had an environmental value of 0.26 kg CO₂/km.

As a result, “the telerehabilitation activities of the two clinics resulted in a cut in carbon emissions by 15–250 times for the telemedicine work model compared to traditional care.”¹¹⁴

Buildings

Lou et al. (2020) have taken data from more than 700 university student residences in the Midwest USA to show what energy savings are possible with WiFi-driven thermostats. They ran calculations based on parameters like room relative humidity, air velocity and mean radiant temperature, also taking into account weather conditions outside. they also accounted for the possibilities of smart homes to recognize whether a

¹¹² Holmner et al. (2014), P. 3.

¹¹³ Raghavan, B., Ma, J. (2011).

¹¹⁴ Holmner et al. (2014), p. 5.

person is in a room or not and what are the room specifics. The rooms considered are shown in Figure C 2 (dimensions in meters).

Figure C 2: Typical room dimensions in residences considered in the study

Living room 3.7 × 5.5	Dining room 3.4 × 3.7	Family room 3.7 × 4.9
Kitchen 3 × 3	Bedroom 3.4 × 3.4	Master bedroom 3.7 × 4.6

Source: Lou et al. (2020), p. 8.

Furthermore, two types of residencies were examined: one was energy efficient and one was not. For these two types, the project found large-scale cooling savings of 85% and 95%.¹¹⁵ “Additionally, we demonstrated the ability to leverage a dynamic machine learning-based predictive model of the residential temperature and humidity measured by a smart WiFi thermostat using historical thermostat and outdoor weather data to estimate savings with thermal comfort control. Such models can be derived for any smart WiFi-equipped residence. Thus, we have demonstrated the ability to estimate thermal comfort control savings in any residence.”¹¹⁶

In a project called “SET” in Kentucky, USA, the homes participating received “building upgrades and highly efficient and controllable device.”¹¹⁷ More than 300 homes out of more than 5,000 residences from Glasgow, KY, participated in the project, “leading to approximately 600,000 kWh of energy saving every year.”¹¹⁸ Figure C 3 shows the home energy management scheme of the SET project.

¹¹⁵ Lou et al. (2020), p. 14.

¹¹⁶ Lou et al. (2020).

¹¹⁷ Gong et al. (2019), p. 504.

¹¹⁸ Gong et al. (2019), p. 504.

Figure C 3: Home energy management systems for smart homes

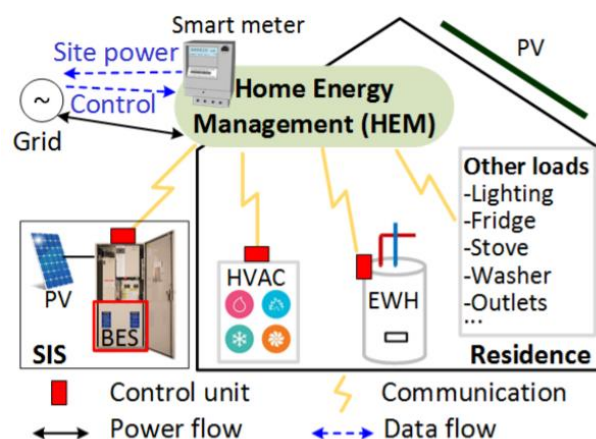

Source: Gong et al. (2019), p. 505.





















The communication technology used to connect the elements (electric water heater (EWH), heating ventilation and air-conditioning (HVAC) and battery energy system (BES) within the Solar Integration System (SIS) might be Ethernet or WiFi.¹¹⁹

Another project was realised in Centocelle, a suburb in the district of Rome under the name “ENEA Smart Home Model”, starting in May 2018.¹²⁰ Figure C 4 shows the buildings’ and user’ profile of the ten participating families.

¹¹⁹ Gong et al. (2019).

¹²⁰ Romano et al. (2018), p.111.

Figure C 4: Building typology and users' profile of the Centocelle project

PICTURE	ID	BUILDING TYPE	m ²	YEAR OF CONSTRUCTION	N. OF FAMILY COMPONENTS
	C1	Flat in multi-family apartment block	49	1919-45	
	C2	Flat in a two-family house	101	1919-45	
	C3	Flat in multi-family apartment block	100	1962-71	
	C4	Flat in a two-family house	50	1946-61	
	C5	Flat in multi-family apartment block	100	1946-61	
	C6	Detached house	65	2010-15	
	C7	Flat in multi-family apartment block	65	1991-05	
	C8	Flat in multi-family apartment block	60	1962-71	
	C9	Flat in multi-family apartment block	95	1946-61	
	C10	Flat in multi-family apartment block	102	1962-71	

Source: Romano et al. (2018), p. 111.

An energy box in people's homes collects data on energy consumption and behaviour. The in-house communication between the box and the smart devices works via Z.Wave.¹²¹ The devices installed are the following:

- "Electric Smart Meter, installed in the apartment electrical panel underneath the general switch for monitoring the overall apartment electricity consumption;
- Smart Switch for monitoring consumption and controlling air conditioners;
- Smart Plug for monitoring and controlling several electrical devices (e.g. appliances);

¹²¹ Romano et al. (2018).

- Opening and closing sensors on doors and windows;
- Integrated comfort/presence sensors for monitoring indoor temperature, brightness and user presences.
- Smart valve for monitoring and controlling the radiator set point.”¹²²

“The collected data is sent to an ICT platform with the task of carrying out the collection functions, aggregation and analysis of the data provided by the monitored home network, to provide educational feedback to the user and it is also able to provide the data available to external applications.”¹²³ This is the aggregator level in Figure C 5. “At the District level, the Smart District Platform has been envisaged, whose task is the management and integration of the different vertical applications of the district in order to allow the monitoring of district and the exchange of data between the different application contexts.”¹²⁴

Figure C 5: Connection architecture of the Centocelle project

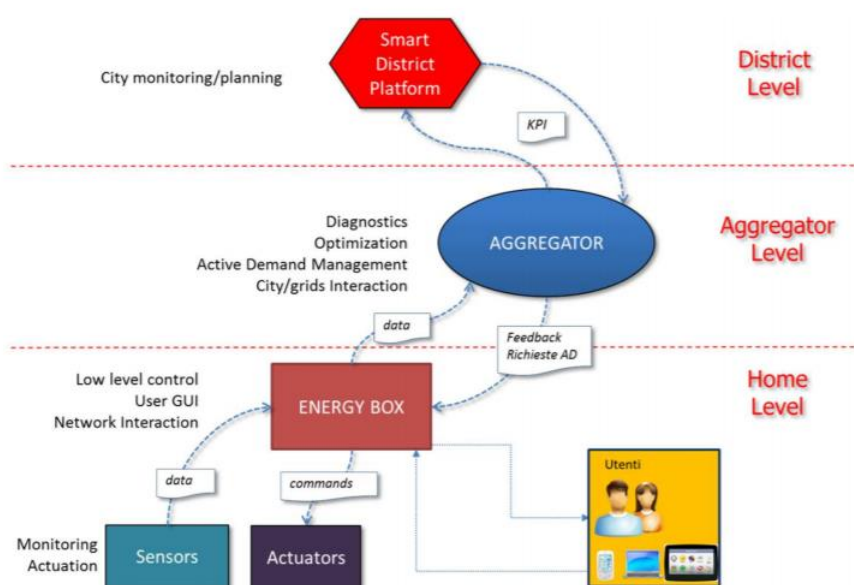

Source: Fumagalli et al. (2017), p. 8.

This project shows that even when WiFi is not used as an in-house technology, it plays a vital role to communicate data outside the buildings, in this case to a cloud. The project offers people the possibility to compare their user habits with other houses /families through the data feed-back. As a result the project yielded ten percent of

¹²² Romano et al. (2018), pp. 108-109.
¹²³ Translation from Fumagalli et al. (2017), p.9.
¹²⁴ Translation from Fumagalli et al. (2017), p.9.

electricity savings per household on average due to the implementation of a smart home system.¹²⁵

The last example shows how WiFi can be used to save energy by means of occupancy count. Hobson et al. (2020) looked at an office building of a size of 6,650 m² and a peak estimated occupancy of 565 persons for seven months. Every floor is equipped with several WiFi access points which record the number of WiFi enabled devices.¹²⁶ The correlation between occupancy counts via the WiFi device count and actual building occupancy was found to be 0.85, which means a strong correlation. On this basis an average weekly occupancy profile was calculated as depicted in Figure C 6.

Figure C 6: Average weekly occupancy profile over seven months

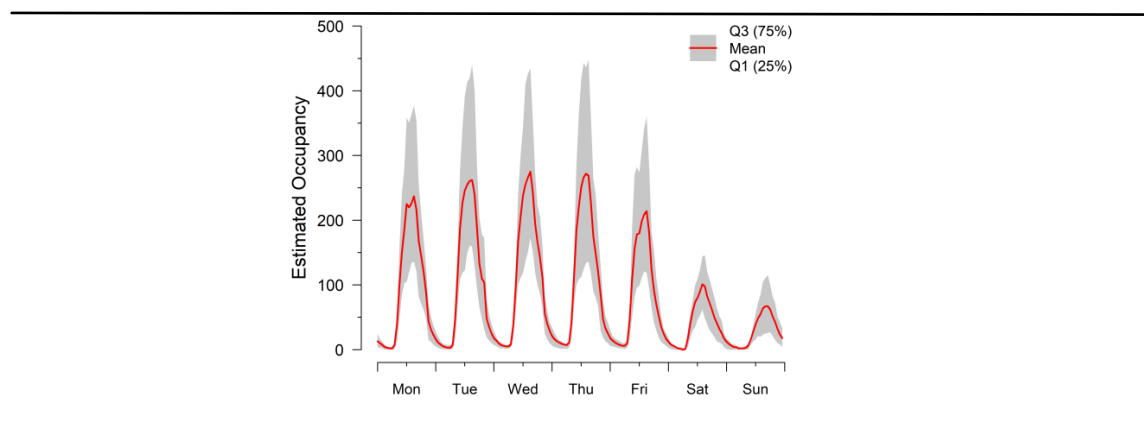

Source: Hobson et al. (2020), p. 3.

According to these estimates different occupancy clusters were calculated to carry out a 24 hour forecast. This forecast could be used to feed it into autonomous or semi-autonomous processes of building control and intervention in, for example, heating, ventilation, and air conditioning (HVAC) systems and thereby save energy.

In a similar study for a lecture hall, Simma et al. (2019) found that energy savings for HVAC of up to 54 percent are possible when applying real-time occupancy estimation using WiFi.

These case studies show that WiFi solutions offer a huge potential for saving energy on the one hand as well as supporting the integration of renewable energy as low or zero carbon energy sources. Therefore WiFi can play a vital role in this sector and contribute to tackling climate change.

¹²⁵ Romano et al. (2018).

¹²⁶ Cp. for this paragraph: Hobson et al. (2020).

Transport

Won et al. (2019) suggest a system called DeepWiTraffic for rural areas that can be established with two laptops. It collects traffic data for “effective utilization of resources, improving environmental sustainability, and estimating future transportation needs including road improvement, assessment of road network efficiency and analysis of economic benefits, etc.”¹²⁷ They consider that this system is highly reliable and cost effective.

Gupta et al. (2018) have suggested a similar system for urban areas. “Because the system is low-cost (less than \$50), it can be used to involve citizens in WiFi-based traffic data crowdsourcing projects, and in this way expand traffic data collection to streets currently not covered by conventional traffic monitoring techniques.”¹²⁸ The system is illustrated in Figure C 7.

Figure C 7: Deployment plan for traffic data collecting system

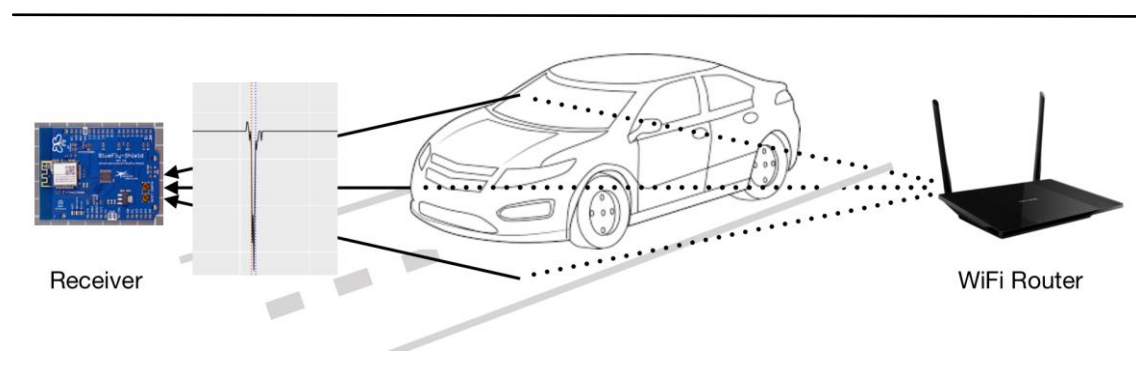

Source: Gupta et al. (2018), p. 6.

The receiver is built from two components. “The first component was the WiFi shield (ATWINC1500), which receive the WiFi signal from connection created via IEEE 802.11n standard and works with the encryption type WPA2. The second component was an SD card shield V3.0 (Model: INT106D1P) that stores the WiFi strength in decibel (dB) and time in milliseconds (ms).”¹²⁹ A TP-link router was used as transmitter with the following settings:¹³⁰

- Band: 2.4 GHz
- Standard: Wireless-N
- Width: 20 MHz
- Encryption: mixed WPA/WPA2 PSK (CCMP)

¹²⁷ Won et al. (2019), p. 476.

¹²⁸ Gupta et al. (2018), p. 2.

¹²⁹ Gupta et al. (2018), p. 6-7.

¹³⁰ Gupta et al. (2018), p. 7.

- Bitrate: 144.4 Mbps
- Time lapse in the data capture: 100 ms
- Transmission time: 10 ms
- Packet size: 88.5 Bytes

The purpose of such systems is to create a database that is the basis for applying new models that can optimize traffic flows.¹³¹ The main objective is to make use of all capacities of the roadway infrastructure, maintaining traffic flow and avoiding congestion. This will save energy and carbon emissions.¹³² According to Barth et al. (2015), in a project called COSMO, CO₂ emission reductions of 5–15 % were shown through the application of transport management systems in test sites in Salerno, Vienna, and Gothenburg. The advantage of WiFi in such systems is that it is a relatively cheap and reliable technology.¹³³

CISCO has tested a WiFi-based system in Melbourne, Australia.¹³⁴ The aim was to measure real-time traffic flow and road user behaviour to use infrastructure more efficiently. Figure C 8 shows a typical intersection setup.

Figure C 8: Intersection setup

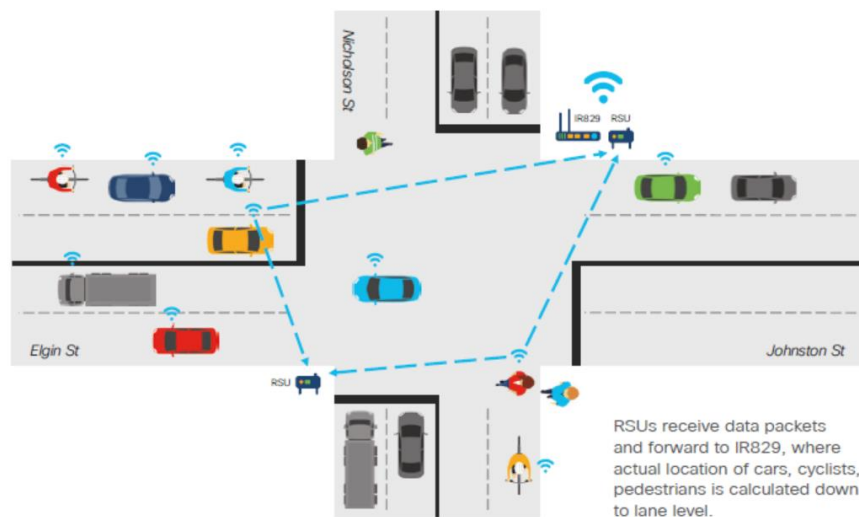

Note: RSU = Road-Side-Units

Source: CISCO (2019), p. 8.

¹³¹ Habibzadeh, H. et al. (2019), Yang et al. (2020).

¹³² Barth et al. (2015).

¹³³ Gupta et al. (2018).

¹³⁴ See for this paragraph: CISCO (2019).

Devices using WiFi may be in-vehicle WiFi Access points and smart phones of different users (bicyclist, motorcyclists, pedestrians etc.). As a result, CISCO finds that “through this trial it has been proven that IoT insights based on WiFi and Edge/Fog computing can provide a near real-time view at a lane level of road user performance. [...] Cities can [...] reduce CO₂ emissions by optimising the routes of heavy freight and public transport vehicles.”¹³⁵

One aspect of reducing congestion is *smart traffic light management*. With the goal of achieving GHG emissions reduction, data is collected from the vehicles to apply signal timing strategies “so that the traffic network is optimized using available green time to serve the actual traffic demands while minimizing the environmental impact. In terms of results, the AERIS program has shown that there is 1 to 5.5 % energy savings and that the application is effective in most conditions other than full saturation.”¹³⁶

WiFi is, among other technologies, one option to implement smart traffic lights. As Pratama et al. (2018) show, it can be used to send information from a mini-pc to a server to monitor and control the traffic flow. Figure C 9 illustrates this function of WiFi.

Figure C 9: WiFi in smart traffic light setting

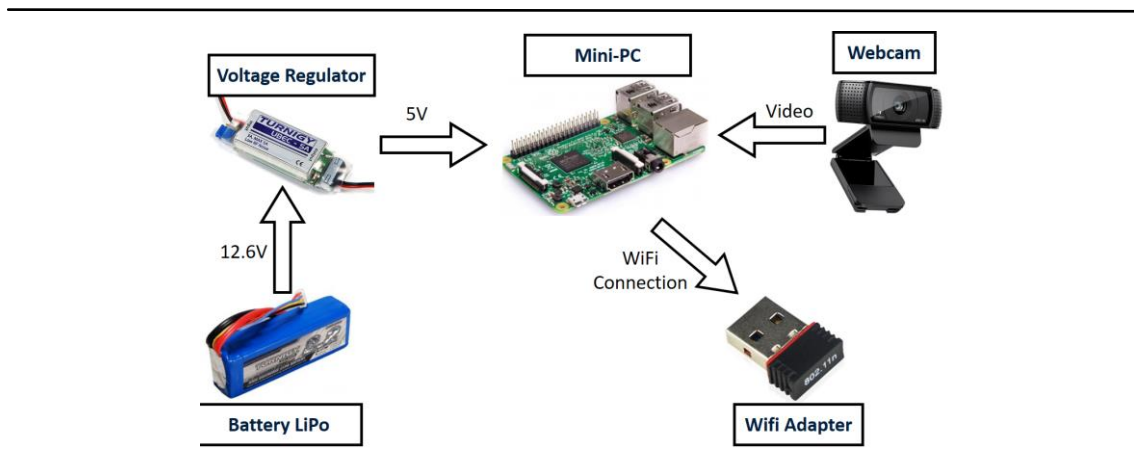

Source: Pratama et al. (2018), p. 84.

Another aspect is *smart parking*. According to Shoup (2006), studies between 1927 and 2001 show that cruising in congested downtowns “took between 3.5 and 14 min to find a curb space, and that between 8 and 74 percent of the traffic was cruising for parking.” With WiFi and other communication technologies, it is possible to tackle this problem and save energy and CO₂ emissions.

Barriga et al. (2019) show in a meta study, that WiFi is an option that is often used in smart parking concepts. These concepts aim to inform vehicle users about free parking

¹³⁵ CISCO (2019), p.19.

¹³⁶ Barth et al (2015), p. 5, with reference to U.S. Department of Transportation (2014).

space via communication technologies and thereby save searching time, fuel and CO₂. According to Barriga et al. (2019) two communication systems are needed as Figure C 10 shows, a sensor network and a user network.

Figure C 10: Network design distribution

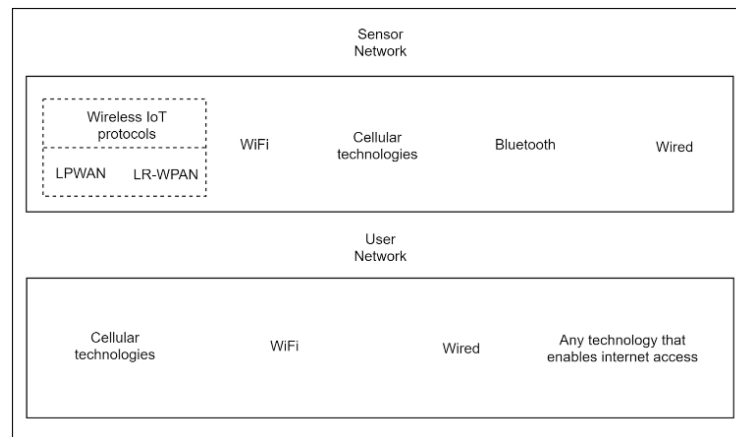

Source: Barriga et al. (2019), p. 18.

The sensor network comprises the network architecture and protocols used for sensor communication. The user network comprises protocols that send information to the end user.¹³⁷ From the 120 cases examined by Barriga et al. (2019) 60% provided information on the technology used. From these cases 31% used WiFi in the sensor networks (51% wireless IoT protocols, 15% 3G or 4G solutions) while about 24% used WiFi in the user networks.

Improving processes and making them more efficient is also an objective of *public transport systems*. If companies know about passenger loads they can react by changing transportation schedules and thus reduce carbon emissions, e.g. by reducing the frequency on certain lines.

WiFi technology can help to monitor traveller flows. This way more people can be encouraged to use public transport and CO₂ emissions can be saved. A case study from Italy shows that the results are quite promising.¹³⁸ The project tested a WiFi-Based Automatic Bus Passenger Counting System (iABACUS) in the city of Cagliari.

On a route of 2.4 km, the system counted people getting on and off a car (simulating a bus) for approximately 15 minutes. The car was equipped with an on-board unit that collected MAC addresses¹³⁹ from the devices on board. The authors state that “The

¹³⁷ Barriga et al. (2019).

¹³⁸ Nitti, M. et al. (2020).

¹³⁹ “Every Network Interface Card (NIC) has a hardware address that's known as a MAC, for Media Access Control.” “The NIC is essentially a computer circuit card that makes it possible for a computer

results are quite good, as the counting algorithm, when set correctly, is able to count all the passengers; however, due to the low frequency with which devices send their probe requests, there may be random errors concerning the correct boarding and alighting from the bus of passengers.”¹⁴⁰

to connect to a network.” “A MAC address is given to a network adapter when it is manufactured” and it is unique. (cp. <https://whatismyipaddress.com/mac-address>, last accessed: 24/11/2020).

¹⁴⁰ Nitti, M. et al. (2020).