

Kelsall, Tim; Laws, Ed; Befani, Barbara

Research Report

The ingredients of successful adaptive programming in Tanzania: A QCA analysis

ODI Report

Provided in Cooperation with:

Overseas Development Institute (ODI), London

Suggested Citation: Kelsall, Tim; Laws, Ed; Befani, Barbara (2021) : The ingredients of successful adaptive programming in Tanzania: A QCA analysis, ODI Report, Overseas Development Institute (ODI), London

This Version is available at:

<https://hdl.handle.net/10419/251134>

Standard-Nutzungsbedingungen:

Die Dokumente auf EconStor dürfen zu eigenen wissenschaftlichen Zwecken und zum Privatgebrauch gespeichert und kopiert werden.

Sie dürfen die Dokumente nicht für öffentliche oder kommerzielle Zwecke vervielfältigen, öffentlich ausstellen, öffentlich zugänglich machen, vertreiben oder anderweitig nutzen.

Sofern die Verfasser die Dokumente unter Open-Content-Lizenzen (insbesondere CC-Lizenzen) zur Verfügung gestellt haben sollten, gelten abweichend von diesen Nutzungsbedingungen die in der dort genannten Lizenz gewährten Nutzungsrechte.

Terms of use:

Documents in EconStor may be saved and copied for your personal and scholarly purposes.

You are not to copy documents for public or commercial purposes, to exhibit the documents publicly, to make them publicly available on the internet, or to distribute or otherwise use the documents in public.

If the documents have been made available under an Open Content Licence (especially Creative Commons Licences), you may exercise further usage rights as specified in the indicated licence.



<https://creativecommons.org/licenses/by-nc-nd/4.0/>



Annex 1 QCA models and findings

The ingredients of successful adaptive programming in Tanzania: a QCA analysis

Tim Kelsall, Ed Laws and Barbara Befani

February 2021

Disclaimer: this Annex contains background data to the above paper. The information has been included in the peer review process but has not undergone extensive editing or formatting.

Table of Contents

Annex: QCA Models and Findings	1
List of i4id Outputs/Cases	1
Table of ingredients	5
How to read the Findings	8
Meta-analysis findings	10
Politics	19
Design	30
Actors	47
HR	62
Learning	66
Funding	86
Capacity	96

List of i4id Outputs/Cases

Case Code	Short Description
1.SWM1	SOLID WASTE MANAGEMENT: Fee collection pilot
2. RIF – OP (1)	REGIONAL INVESTMENT FACILITATION: RIFO facilitates at least one investor in Iringa
3. MHM – OP1 (2)	MENSTRUAL HEALTH MANAGEMENT: VAT exemption initiative
4. SWM2	SOLID WASTE MANAGEMENT: Recycling trial
5. SWM3	SOLID WASTE MANAGEMENT: Mtaa business model trial
6. SWM4	SOLID WASTE MANAGEMENT: New mobile app
7. SWM5	SOLID WASTE MANAGEMENT: Interdepartmental cooperation
8. SWM6	SOLID WASTE MANAGEMENT: Mobile transfer station scaled
9. SWM7	SOLID WASTE MANAGEMENT: Wastepickers’ rehab
10. SWM8	SOLID WASTE MANAGEMENT: Wastepickers’ advocacy
11. SWM10	SOLID WASTE MANAGEMENT: Bag model
12. UW1	URBAN WATER: Expansion plan
13. UW2	URBAN WATER: Coordination mechanism
14. UW3	URBAN WATER: Better Decisionmaking
15. UW4	URBAN WATER: Stakeholders agree expansion plan
16. UWV1	URBAN WOMEN VENDORS: Buy-in to work on urban vendors
17. UWV2	URBAN WOMEN VENDORS: Town Vending Committees
18. MHM – OP1 (2)	MENSTRUAL HEALTH MANAGEMENT: Distribution of reusable product in two regions

19. MHM – OP 1 (1)	MENSTRUAL HEALTH MANAGEMENT: Successful intro of new affordable brand
20. MHM OP1 (3)	MENSTRUAL HEALTH MANAGEMENT: Increased sales outside of Dar
21. MHM OP 2.1 (1a and b)	MENSTRUAL HEALTH MANAGEMENT: Support for MHM from Mps or Ministers + increased profile of MHM in national health policy
22. MHM OP2.1 (2)	MENSTRUAL HEALTH MANAGEMENT: Collective action by private companies
23. MHM OP2.2 (1)	MENSTRUAL HEALTH MANAGEMENT: Two media houses highlight MHM issues
24. MHM OP2.2 (2)	MENSTRUAL HEALTH MANAGEMENT: Apex organisation creates platform for MHM issues
25. MHM OP1 (1)	MENSTRUAL HEALTH MANAGEMENT: Increased private sector investment in local distribution
26. RIF (2)	REGIONAL INVESTMENT FACILITATION: RIFO demonstrates it can liaise with other regulatory bodies
27. RIF (1) OP2.2	REGIONAL INVESTMENT FACILITATION: At least two businesses demonstrate improved capacity and willingness to invest
28. RIF OP2.1 (1)	REGIONAL INVESTMENT FACILITATION: District and village political stakeholders collaborate and coordinate for investment
29. IE. OP1 (1)	INCLUSIVE EDUCATION: MOE recognises TSL
30. IE OP1 (1)	INCLUSIVE EDUCATION: MOE agrees to wider TSL promotion initiative
31. IE OP1 (3)	INCLUSIVE EDUCATION: Changes in Teacher Training Policy agreed
32. IE OP1.IE (2)	INCLUSIVE EDUCATION: MoEST commits to developing a more equitable curriculum
33. IE OP1.IE (3)	INCLUSIVE EDUCATION: GoT Ministries and Sign Language stakeholders collectively agree draft for TSL dictionary
34. IE OP1.IE (5)	INCLUSIVE EDUCATION: MoEST reviews and changes quality assurance framework
35. IE OP2.1 IE (1)	INCLUSIVE EDUCATION: Senior political stakeholders demonstrate accountability to Parliament
36. IE OP2.1 IE (2)	INCLUSIVE EDUCATION: Senior political stakeholders make tangible and visible commitments
37. IE OP2.2 IE (2)	INCLUSIVE EDUCATION: A major national media house mainstreams TSL interpreters
38. IE OP2.2 (1)	INCLUSIVE EDUCATION: CHAVITA and other stakeholders support genuine participation and harmonisation with other (sign) linguistic groups in Tanzania, incl other sign-language groups, deaf women and girls.
39. IE OP2.1. IE(1)	INCLUSIVE EDUCATION: MoEST adopts a progressive approach to policy reform wrt examination format; MOEST & NECTA identify and agree changes to improve equity and accessibility of examination systems for deaf children
40. OP1 USD (1)	URBAN SPATIAL DEVELOPMENT: Participatory boundary maps developed with each Ward Executive Office in Kigamboni.
41. OP1 USD (2)	URBAN SPATIAL DEVELOPMENT: Inclusive land use plan developed.
42. OP1. USD(3)	URBAN SPATIAL DEVELOPMENT: Inclusive land use plan disseminated, validated and adopted.
43. (DROPPED) OP1. USD(4)	URBAN SPATIAL DEVELOPMENT: KMC adopt land value capture strategy for priority projects in KMC.

44. OP1. USD(5)	URBAN SPATIAL DEVELOPMENT: Dar es Salaam Masterplan revised and updated to reflect Kigamboni land plan
45. OP2.1. USD (1)	URBAN SPATIAL DEVELOPMENT: At least one high level politician explicitly promotes Kigamboni for wider replication.
46. OP2.1. USD(2)	URBAN SPATIAL DEVELOPMENT: Full council meeting approves land use plan.
47. OP2.1.USD(3)	URBAN SPATIAL DEVELOPMENT: Key stakeholders in Kigamboni municipality and MLHSD agree to the process for development of a new land use plan for Kigamboni.
48. OP2.2. USD (1)	URBAN SPATIAL DEVELOPMENT: Kigamboni citizen groups and associations take initiative to ensure improved consultation and contribution to land use plan formulation and validation.
49. OP1.USD (1)	URBAN SPATIAL DEVELOPMENT: Land inventory in Kigamboni District developed and validated.
50. OP1.USD (2)	URBAN SPATIAL DEVELOPMENT: Diverse stakeholder groups contribute to a shared, long-term vision for Kigamboni.
51. OP1.USD (3)	URBAN SPATIAL DEVELOPMENT: New land use map [for the city visioning, 2040] developed through consultation.
52. OP2.1. USD (1)	URBAN SPATIAL DEVELOPMENT: A majority of local level politicians agree the new land use plan to be used in guiding and controlling land development issues in Kigamboni.
53. OP2.2 USD (1)	URBAN SPATIAL DEVELOPMENT: Citizen groups constructively engage and influence key policy makers around process inclusivity.
54. SF1	SUNFLOWER: Tariff study completed and disseminated with key stakeholders
55. SF2	SUNFLOWER: Convene early dissemination for progress update with key stakeholders
56. SF3	SUNFLOWER: Support ANSAF to make presentation to Parliamentary Committee on Agriculture
57. SF4	SUNFLOWER: Secure agreement with ANSAF to place an embedded (p/t) coordinator to focus on sunflower
58. SF5	SUNFLOWER: 24 minutes magazine radio show (Haba na Haba) to explore implementation of government decision to abolish taxes, levies and fees
59. SF6	SUNFLOWER: Media dialogue sessions to influence national and EAC policy with at least two national and two local media channels
60. SF7	SUNFLOWER: Political influencing and media campaign strategy developed by ANSAF, including broader or targeted dissemination
61. SF8	SUNFLOWER: Wide dissemination of narrative around progressive policy change on Ag fees and levies, through a national media channel
62. SF9	SUNFLOWER: Analysis of tariff policy completed and shared with key stakeholders

63. SF10	SUNFLOWER: Key stakeholders learn about findings and agree implications
64. SF11	SUNFLOWER: Parliamentary Committee on Agriculture gains improved understanding of tariff options and implications
65. (Dropped) SF	SUNFLOWER: Seed initiative

Table of ingredients

Overarching condition	Specific ingredients
1. Politics. The initiative paid attention to its authorising environment and/or employed politically smart programming principles	<p>1.0 A reasonably in-depth study of some sort was commissioned;¹</p> <p>1.1. An ex ante in-depth political economy study was conducted;</p> <p>1.2. The initiative responded to a problem already receiving a high level of political attention;</p> <p>1.3. The initiative responded to a problem already receiving a high level of media attention;</p> <p>1.4. The team responded to or sought out political stakeholders with a potentially positive interest in the initiative;</p> <p>1.5. There was ongoing political engagement and light-touch everyday political/political economy analysis;</p> <p>1.6. As the Programme evolved, more in-depth PEA studies were commissioned;</p> <p>1.7. Workstream coordinators or other team members were given space, time and resources to follow their 'political antennae';</p> <p>1.8. The authorising environment for donor support and funding was maintained.</p>
2. Design. The initiative employed PDIA/Human-centred/systems design principles	<p>2.1 The team engaged in rigorous systems research, mapping or modelling around the initiative;</p> <p>2.2 The team took a less formal systems approach - recognising the complex, multidimensional nature of most problems and searching, iteratively, for solutions, but not using specific systems research, mapping or modelling tools/methods;</p> <p>2.3 The team approached the problem as a discrete, one-dimensional issue for which the solutions could be pre-determined, pre-planned and implemented more or less as intended (i.e. there was no systems thinking in either a formal or organic sense);</p> <p>2.4 The team took a 'human-centred approach' - i.e involving participatory action research, deep immersion in context, community brainstorming, usability scales, sustained community feedback to inform decisions on scale, etc;</p> <p>2.5 Solutions were ideated through processes of positive deviance or latent practice;</p> <p>2.6 There was a deliberate attempt to adapt external best practice or technology to the local context.</p>
3. Actors. The initiative leveraged or paid attention to local leadership/ownership/acceptance	<p>3.1 The initiative received "buy-in" from high-level politicians;</p> <p>3.2 The initiative received "buy-in" from lower-level politicians;</p> <p>3.3 The initiative received "buy-in" from implementing agencies; eg ministries, executive agencies; local government;</p> <p>3.4 The initiative focused on problems that mattered to local non state actors. For example to civil society, citizen groups or the private sector;</p>

¹ With the benefit of hindsight, we think this ingredient might be more suitably placed in the Design category. However, we do not believe it has had a big impact on the overall results.

	3.5 The workstream faced opposition from well-coordinated and/or politically influential actors or groups.
4. HR. The initiative employed appropriate staff or engaged a wider team with what might reasonably have been expected to be the requisite abilities, political networks or technical skills normally associated with this problem area.	<p>4.1 Team or coalition members have strong local networks;</p> <p>4.2 Leading team or coalition members had been resident in Tanzania for many years;</p> <p>4.3 Team or coalition members have held senior positions in a national organization;</p> <p>4.4 Team or coalition members are widely known in this geographic, issue or policy area;</p> <p>4.5 Team or coalition members are connected to government and/or civil society networks;</p> <p>4.6 Team or coalition members are strongly identified with an opposition party;</p> <p>4.7 Coalition members have a successful track record in political analysis, GESI analysis, market systems analysis or other relevant fields of technical knowledge;</p> <p>4.8 Team or coalition members have a successful track record in using adaptive approaches.</p>
5. Learning. The initiative employed principles of iterative adaptation .	<p>5.1 The initiative deliberately engaged in at least a loose kind of hypothesis formation upfront;</p> <p>5.2 The initiative identified multiple rival hypotheses upfront and tested them in parallel;</p> <p>5.3 The initiative clearly and explicitly identified the conditions for testing hypotheses, with clear success/failure criteria;</p> <p>5.4 The initiative subjected its hypotheses and prototypes to a rigorous and structured process of implementation and testing;</p> <p>5.5 The team went beyond purposive muddling, to systematically analyse and understand successes, setbacks and failures against initial hypotheses, enabling modification and adaptation;</p> <p>5.6 A number of experimental, iterative steps were progressively employed to enable real solutions to emerge;</p> <p>5.7 There was a clear plan for how initial success would lead to scale-up.</p>
6. Funding. The programme made funding decisions that were consistent with adaptive management conventional wisdom.	<p>6.1 The initiative deployed programme funds in a smart or strategic way, i.e. as a catalyst for significant change, or to provide proof of concept for a pilot or solution that could be scaled up without further I4ID investment;</p> <p>6.2 The initiative took a ‘money off the table’ approach, i.e. i.e. funds were used principally for brokering and convening, instead of funding pilots, infrastructure, technical assistance, or to provide core funding;</p> <p>6.3 The Programme agreed to provide funds for pilots, infrastructure, technical assistance, or core funding;</p> <p>6.4 The resources made available in the programme budget were regarded as sufficient by the workstream co-ordinator.</p>
7. Capacity and innovation. The initiative sought to innovate or to improve existing solutions.	<p>7.1 The initiative deliberately tried to introduce and/or build capacity for an innovative technology;</p> <p>7.2 The initiative deliberately tried to introduce and/or build capacity for an innovative behaviour;</p>

	7.3 The initiative sought to 'fine-tune' an existing system, model, or technology, rather than look for an innovative solution, model or approach
--	---

How to read the Findings

For those unused to QCA the following findings may be difficult to interpret. We consequently provide a brief guide here.

In our models, each of the ingredients in the above table is given an abbreviation. For example, the 5-condition model below tests a combination of ingredients that can be found under the category of Politics, where '1.0studies' refers to '1.0 A reasonably in-depth study of some sort was commissioned' and so on.

1.0studies, 1.2pol_att, 1.3mediaatt, 1.4polstake, 1.6resanalysedt.

The text typically works its way through a variety of combinations subjected to Boolean analysis.

For example, the notation in bold below is presenting the results of a Boolean analysis on this 5-condition model.

1.0STUDIES*1.2POL_ATT*1.4POLSTAKE*1.6resanalysedt

In this notation, uppercase letters signify that a condition was present in successful outcomes; lowercase that a condition was absent; asterisks mean 'in conjunction with'.

The text also typically tells us how important the combination is for this model, where importance refers to *coverage* and *consistency*. So it might say something like, 'This combination had a coverage of 44% of cases with positive Outcome 1, Outcome 2A, and Outcome 2B, between 23% and 26% uniquely, but with only 93% consistency on Outcome 2B. Note that where no mention of consistency is made, as with Outcomes 1 and Outcome 2A here, it means consistency is 100%.

The text typically proceeds to show the Boolean results in Venn diagrams. Here, each box represents a different combination of ingredients, with the codes in the corner of each box representing the presence or absence of each ingredient in the five-condition model 1.0studies, 1.2pol_att, 1.3mediaatt, 1.4polstake, 1.6resanalysedt we are discussing. So, 00000 signifies that none of the conditions was present, 00001 signifies that only ingredient 1.6 was present, and so on.

If a box is coloured green, it means that that combination of ingredients only led to success; if it is pink, it only led to failure; if it is striped it could lead to either success or failure; and if it is white, it means this combination did not appear in the dataset.

When it comes to the precise combination

1.0STUDIES*1.2POL_ATT*1.4POLSTAKE*1.6resanalysedt

this is represented in the diagram by two boxes: 11110 and 11010 (with 1.3mediatt left out of the notation because it has a mixed value). The fact that the boxes are coloured green shows that whenever this combination appeared, there was a successful outcome, while the bolded codes within the boxes (29IE, 30IE etc) refer to specific cases (readers can refer back to the Table of cases above). If you were to count the cases in both these boxes, you would find that they comprised or covered 44% of all the successful cases, between 23% and 26% uniquely.

Figure 1

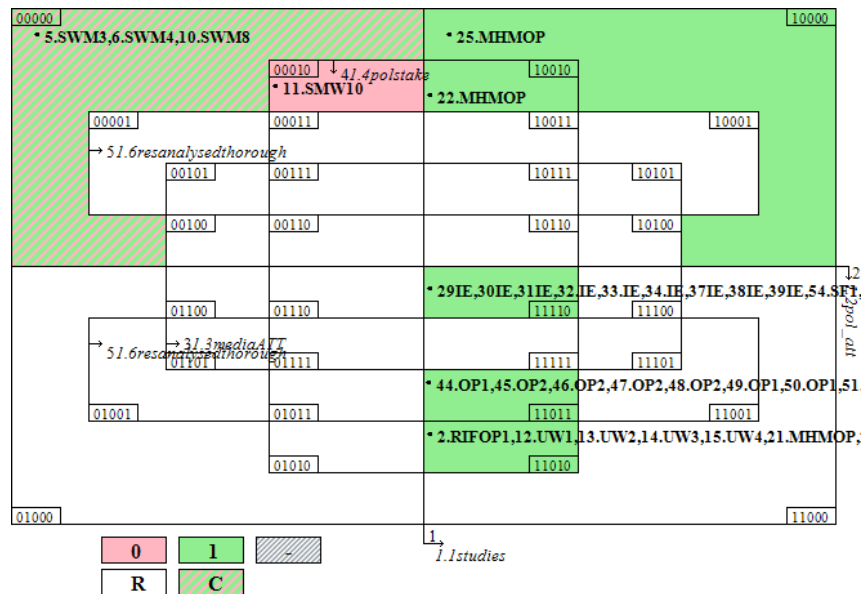

We now proceed to present our findings.

Meta-analysis findings

Politics (Pol) + Design (Des) + Actors (Act) + HR + Learning (Learn) + Funding (Fund) + Capacity (Cap)

1.0 The first two datasets are similar: the one analysed for Outcome 1 has 60 cases, of which 59 positive and one negative (10.SWM8_Wastepickers_advocacy); the one analysed for Outcome 2A has 50 cases, of which 48 positive and two negative (10.SWM8_Wastepickers_advocacy and 11.SMW10_bag_model).

The dataset for Outcome 2B has 57 cases, of which 48 positive and 9 negative; the one for Outcome 3 has 46 cases, of which 34 positive and 12 negative.

2.0 Two conditions are necessary for outcomes: the presence of FUND for all four outcomes, and POLITICS for Outcome 3; but some conditions are present in a large part of the positive outcome cases: POLITICS is present in 81% of Outcome 1 cases and 83% of Outcome 2A and Outcome 2B cases; HR in 88% of Outcome 3 cases, 80% of Outcome 1 and 79% of Outcome 2A and Outcome 2B cases; DESIGN in 81% of Outcome 1 positive cases, 83% of Outcome 2A and Outcome 2B positive cases, and 82% of Outcome 3 positive cases; ACTORS in 81% of cases with a positive Outcome 1, 85% with a positive Outcome 2A and Outcome 2B, and 88% of cases with a positive Outcome 3. The worst represented condition in all datasets is Capacity, present in only 34% of the Outcome 1 cases, 33% of the Outcome 2A cases, and 41% of the Outcome 3 cases.

For Outcome 1, the only case with a negative outcome does not present any of the seven conditions; hence they are all sufficient for the outcome as single conditions; that is, whenever any of them are present, Outcome 1 is positive.

The situation is similar but not identical for Outcome 2A: one case with a negative outcome does not present any of the seven conditions; while the other presents HR, Learning, and Funding. Therefore, four conditions (Politics, Design, Actors, and Capacity) are sufficient by themselves; that is, whenever any of them is present, Outcome 2A is positive.

There are many more negative cases in the other two outcomes so there is no single condition that is sufficient for either. Many conditions, whether absent or present, lead to a positive outcome in most cases. The ones with the highest consistency are DESIGN, ACTORS, and CAPACITY (all with 89%) for Outcome 2B (but there are also LEARNING with 87.5% and FUNDING with 86%); notice that the proportion of positive cases in the entire set of cases is 84% though. As for Outcome 3, CAPACITY is 93% consistent by itself, followed by POLITICS and ACTORS at 83%, and DESIGN at 82%. Note that these consistencies are more significant than those for Outcome 2B because the overall proportion of positive cases in the dataset is 74% for Outcome 3.

3.0 The Boolean minimisations conducted on the 7-condition model for Outcome 1 indicated that the following five conditions might provide a good case coverage for both

outcomes (in addition to the expected perfect consistency): Politics, Design, Actors, HR, and Funding.

When applied to this 5-condition model, the Boolean minimisations returned the following results.

The most important combination is **POLITICS*FUNDING**, which covers 81% of cases with a positive Outcome 1 and 83% of cases with a positive Outcome 2A.

If we remove FUNDING which is a necessary condition and hence present in all solution terms, we can test the model Politics + Design + Actors + HR.

The most important combination is a single-condition one: **POLITICS**, which covers 81% of cases with a positive Outcome 1, and 83% of cases with a positive Outcome 2A. If we add two more conditions, DESIGN and HR, the combination **POLITICS*DESIGN*HR** covers 67% of cases with a positive Outcome 2B and 80% of cases with a positive Outcome 3.

Two other combinations are, however, important: **DESIGN*ACTORS** covers 75% of cases with a positive Outcome 2A (90% consistency) and 71% of cases with a positive Outcome 1; and **POLITICS*ACTORS*HR**, which covers 85% of cases with a positive Outcome 3 (85% consistency).

ACTORS*HR covers 73% of cases with a positive Outcome 1 and 75% of cases with a positive Outcome 2A.

The Venn diagrams are almost identical for Outcome 1 and Outcome 2A.

The areas 10-0 (**POLITICS*design*hr**) and 1101 (**POLITICS*DESIGN*actors*HR**) are consistently positive across the four outcomes

Figure 2: Outcome 1

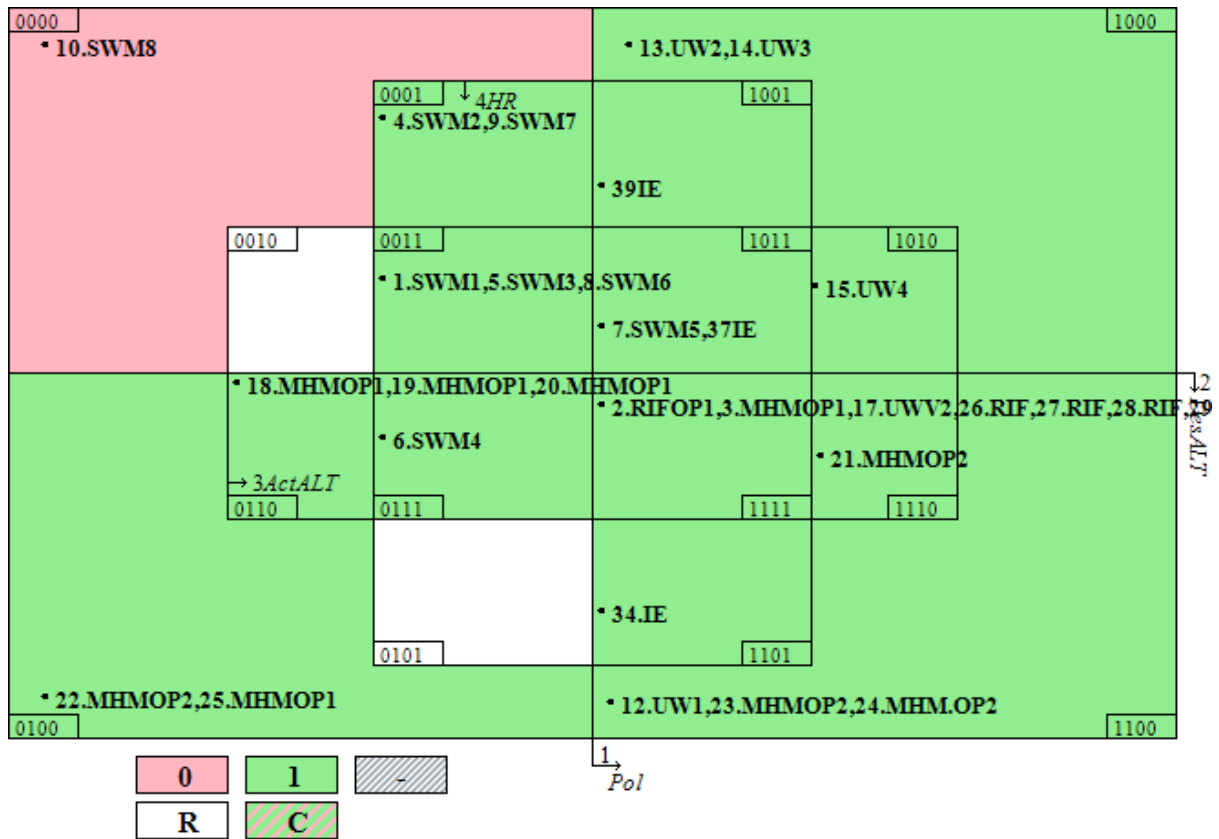

Figure 3: Outcome 2A

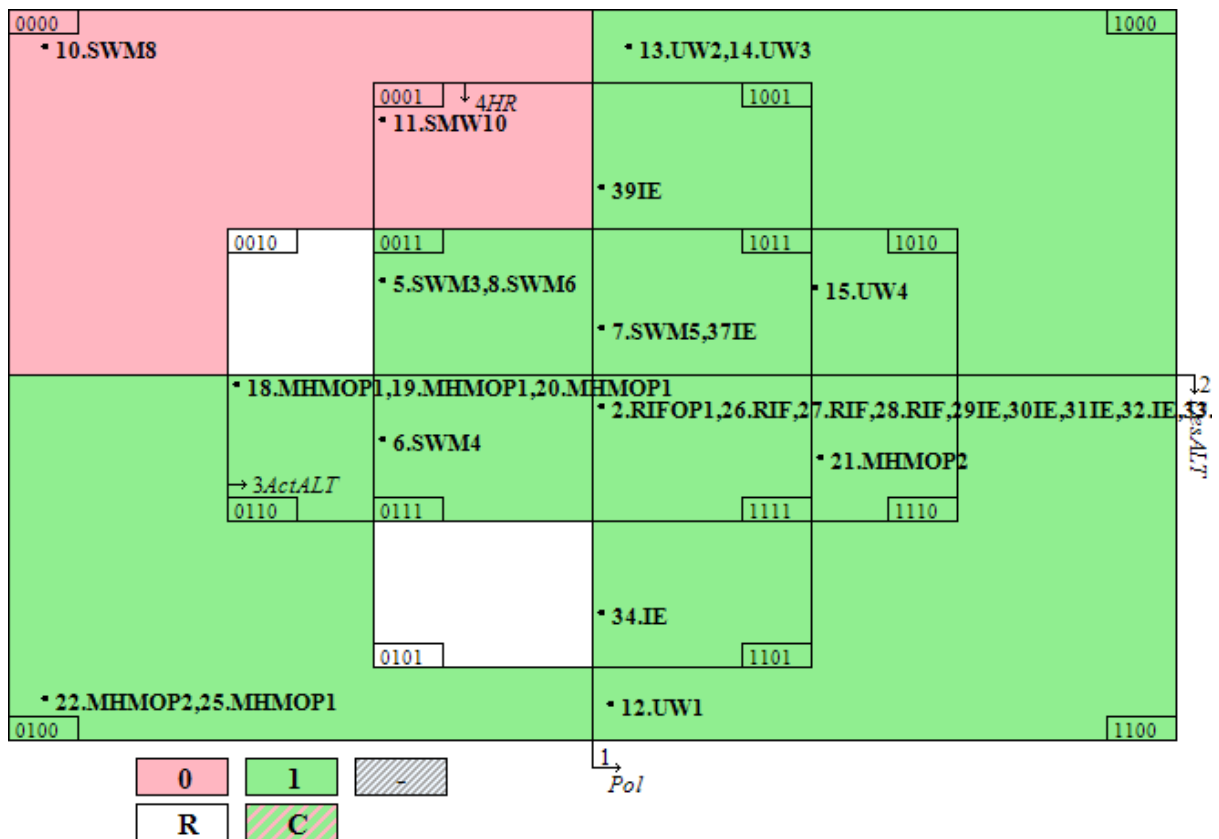

Figure 4: Outcome 2B

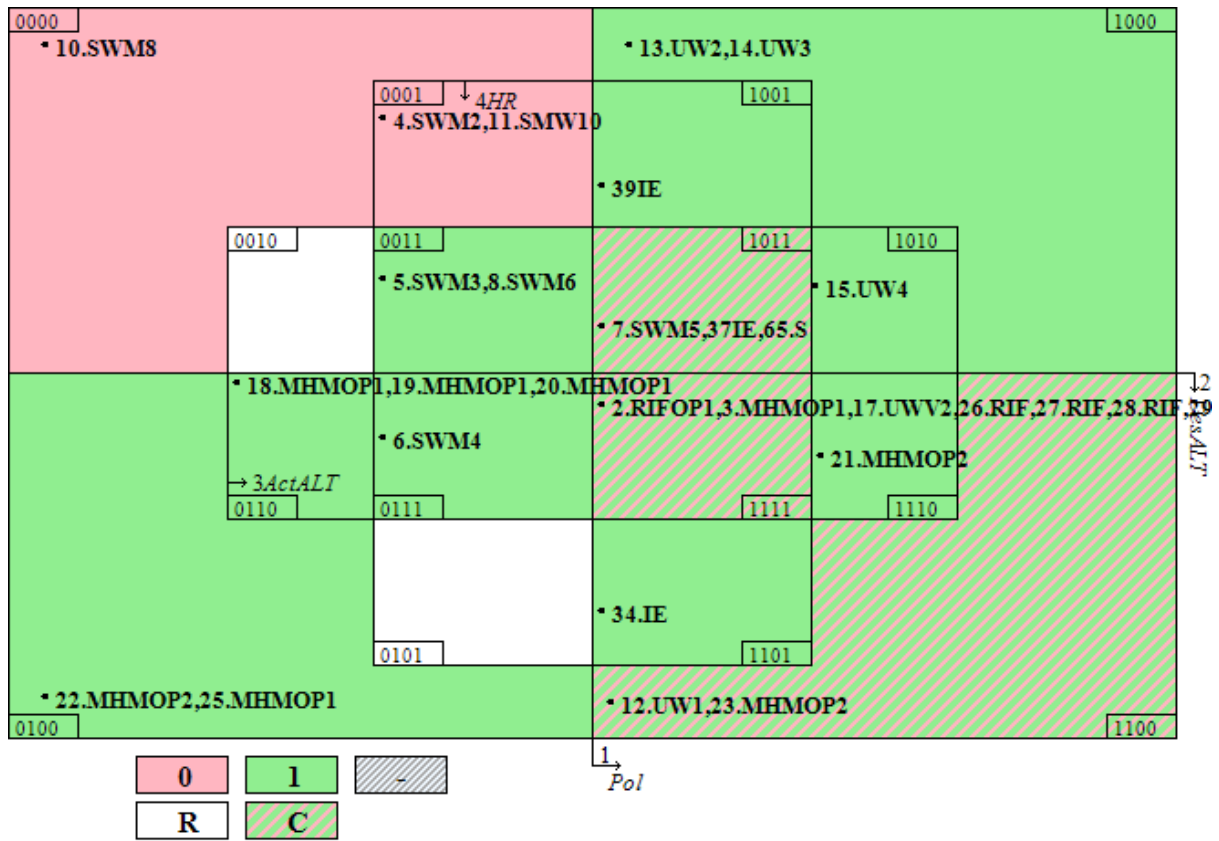
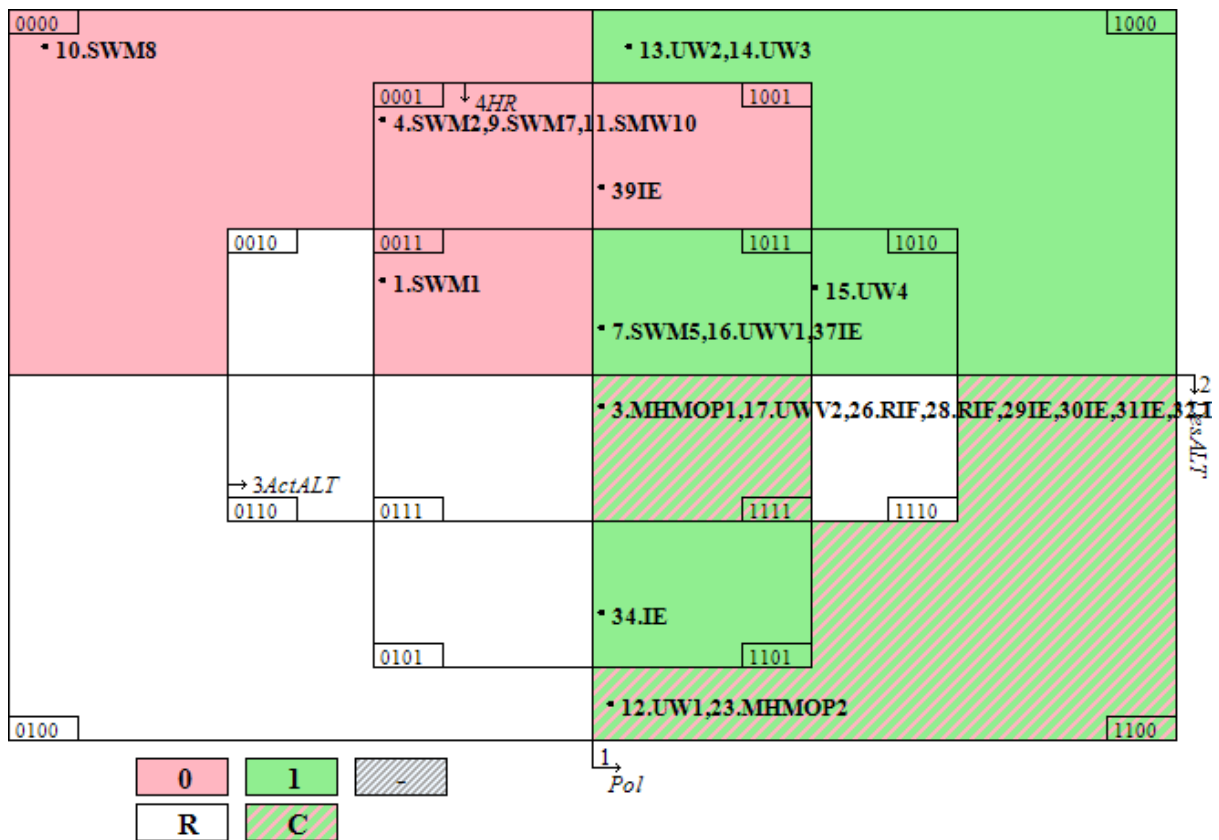

Figure 5: Outcome 3



4.0 The third most important condition in the solution to the 5-condition model is ACTORS: if we test the model Politics + Actors + Funding, we discover that the presence of **FUNDING** covers the entire dataset and is both necessary and sufficient for the Outcome 1 outcome; even as a result from the relatively conservative Boolean minimisation (complex solution).

For other outcomes, we need to add conditions: **ACTORS*FUNDING** covers 85% of cases with positive Outcome 2A outcomes; **POLITICS*FUNDING** covers 83% of cases with positive Outcome 2A outcomes; and **POLITICS*ACTORS*FUNDING** covers 88% of cases with a positive Outcome 3 (all uniquely, albeit with 86% consistency).

Figure 6: Outcome 1

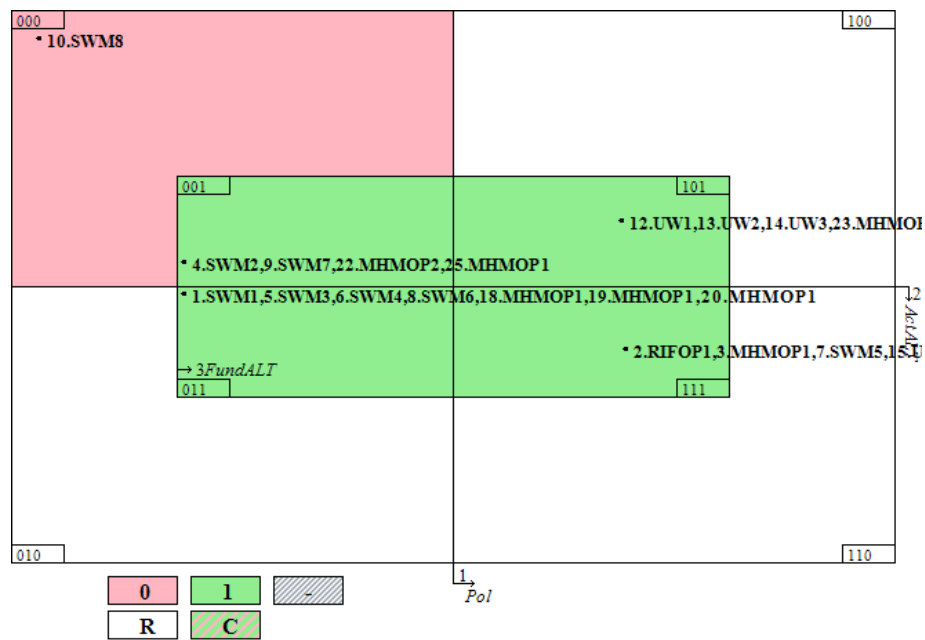

Figure 7: Outcome 2A

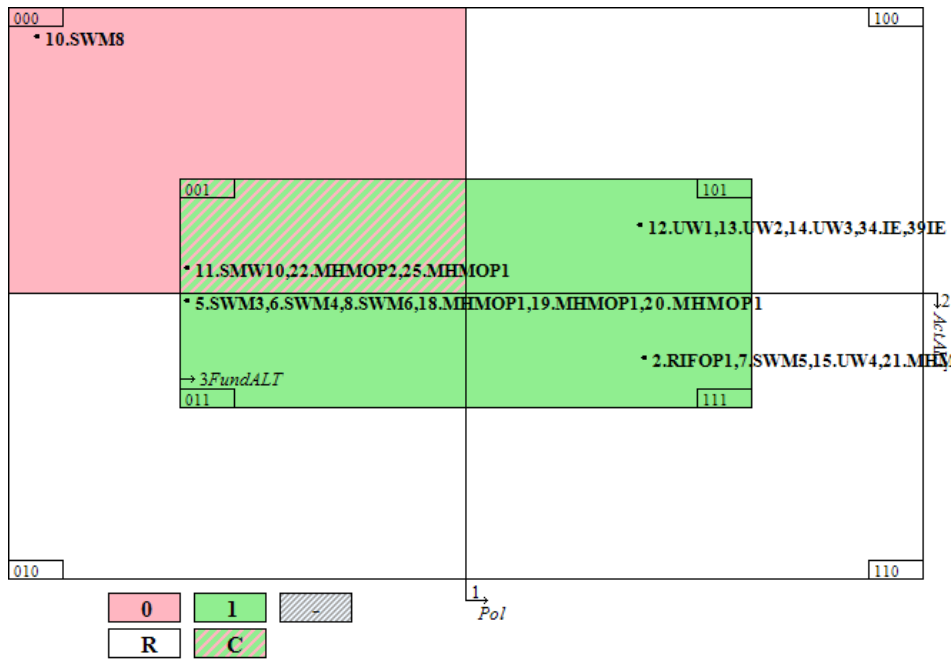

Figure 8: Outcome 2B

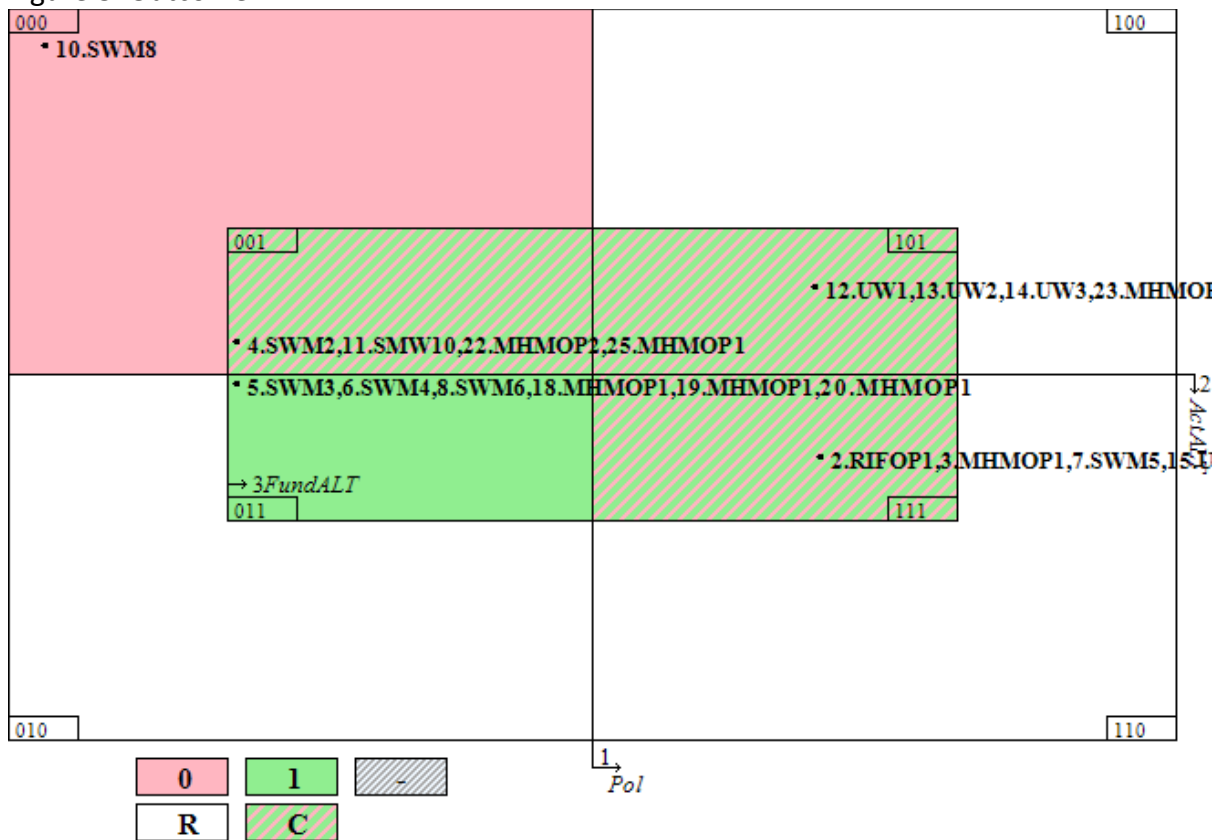
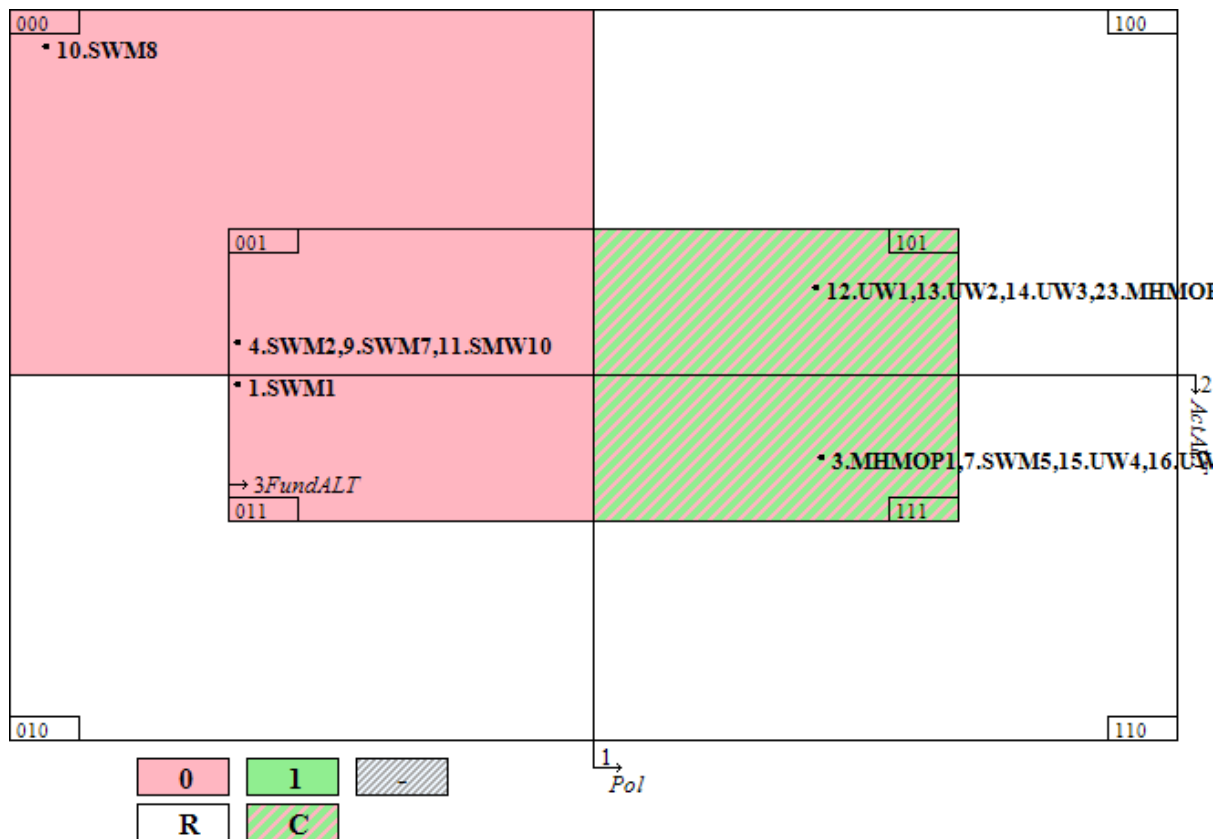

Figure 9: Outcome 3



5.0 Other interesting models have emerged, like Politics, Actors, HR, and Funding. **FUNDING** continues to be both necessary and sufficient on its own for Outcome 1, despite the stricter sufficiency conditions of the Boolean minimisation. The other important combinations are **ACTORS*FUNDING**, which covers 85% of cases with a positive Outcome 2A and Outcome 2B (here the consistency is 89%). If we add one condition, **POLITICS*ACTORS*FUNDING** covers 88% of cases with a positive Outcome 3 (85% uniquely, with 85% consistency)

Figure 10: Outcome 1

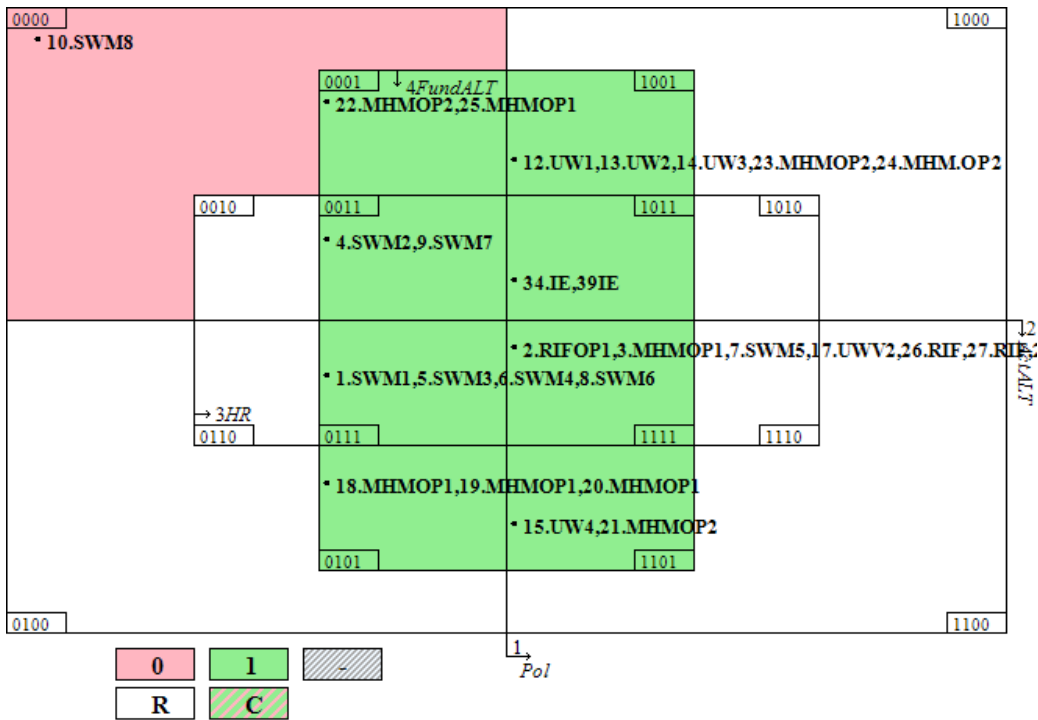

Figure 11: Outcome 2A

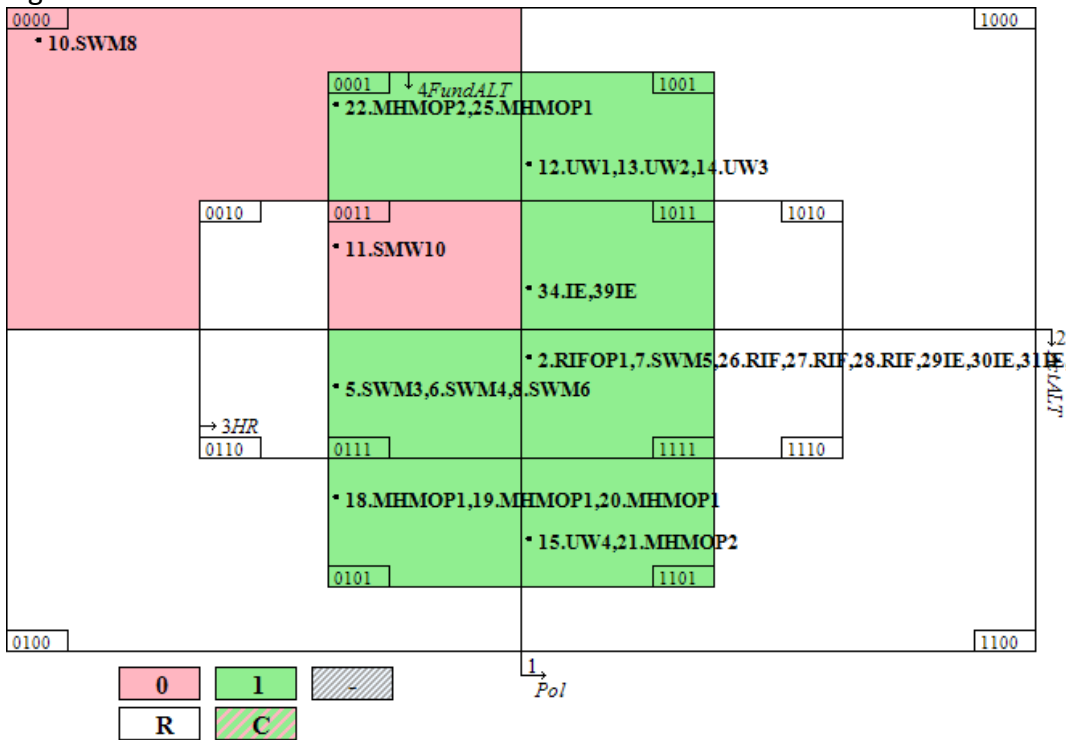

Figure 12: Outcome 2B

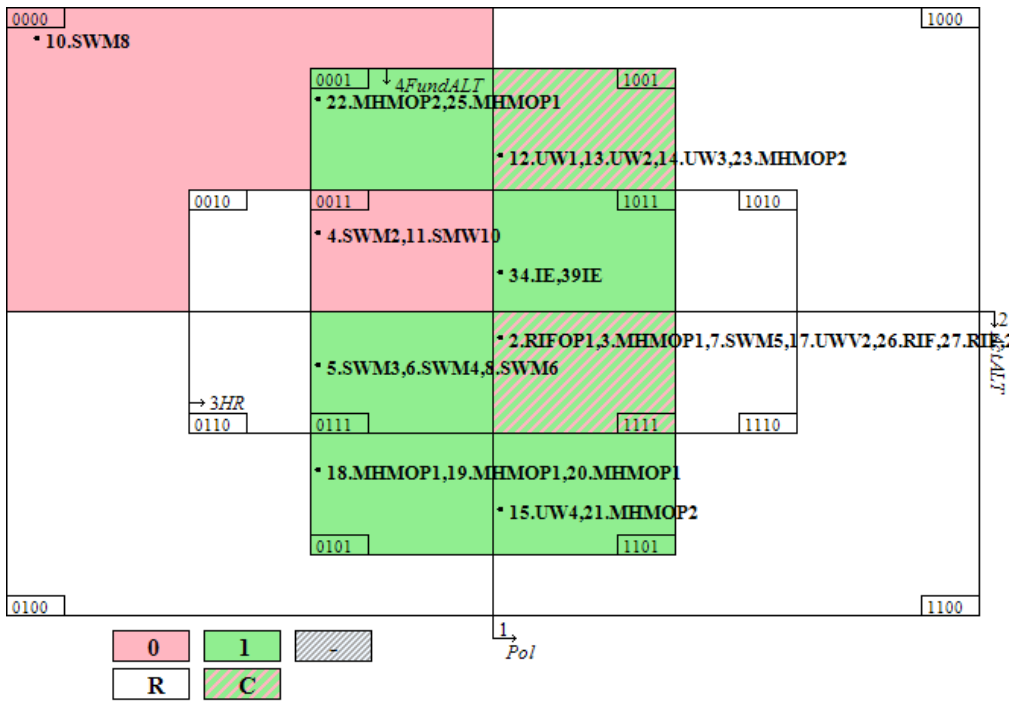
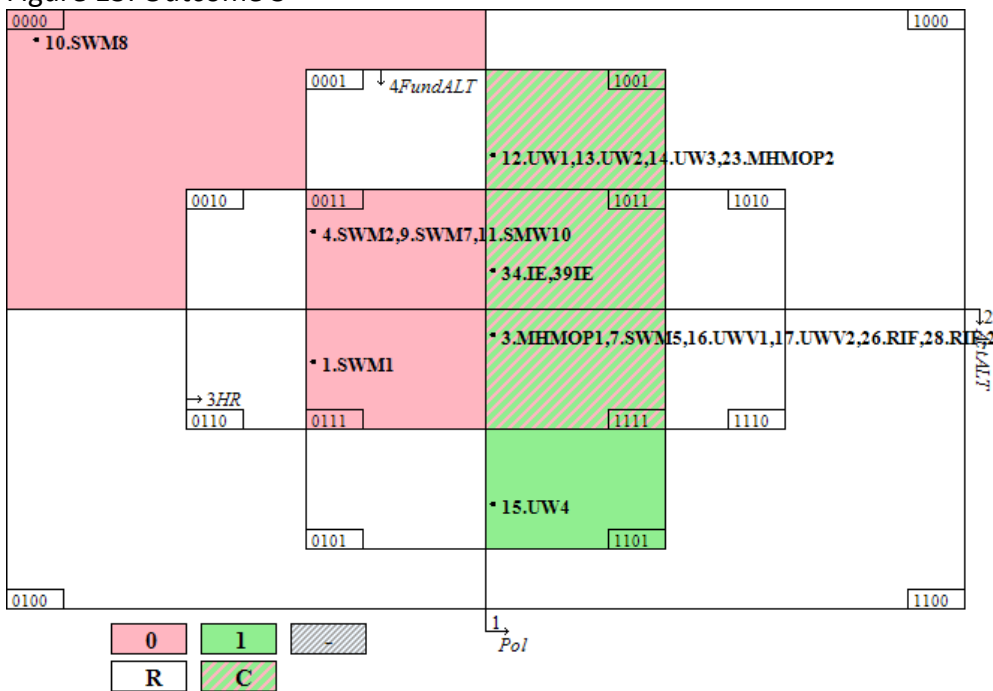

Figure 13: Outcome 3



6.0 The only combination that is consistently positive across the four outcomes is 1101 (POLITICS*ACTORS*hr*FUNDING), although it only covers one case.

Politics

1.0studies + 1.1apestudies + 1.2pol_att + 1.3mediaatt + 1.4polstake + 1.5resanalysedl + 1.6resanalysedt + 1.7followpolant + 1.8authorisinge

Superset and subset analysis

7.0 The first two datasets are similar: the one analysed for Outcome 1 has 51 cases, of which 50 positive and one negative (10.SWM8_Wastepickers_advocacy); the one analysed for Outcome 2A has 45 cases, of which 43 positive and two negative (10.SWM8_Wastepickers_advocacy and 11.SMW10_bag_model). The one with Outcome 2B has 51 cases, of which 43 positive and 8 negative. The Outcome 3 dataset has 28 cases, of which 18 positive and 10 negative.

7.1 For all four outcomes, three conditions are necessary for a positive outcome: the absence of 1.1apestudies; the presence of 1.5RESANALYSEDLIGHTTOUCH and the presence of 1.8AUTHORISINGENV. However these three conditions are also present in the negative outcome (with one exception for 1.8 in Outcome 2B) and they might be trivial – or not very informative in terms of factors causing the outcome because present in every single case considered, whether positive or negative. For Outcome 3, four more conditions are necessary for a positive Outcome 3: 1.0STUDIES, 1.2POL_ATT, 1.4POLSTAKE, 1.5RESANALYSEDL, and the absence of 1.6resanalysedt. The last two (1.5 and 1.6) are trivial (they're always present in the negative outcome as well).

7.2 For Outcome 1, the only case with a negative outcome presents 1.5, 1.7, and 1.8 – therefore these conditions, unlike all the others (1.0STUDIES, 1.2POL_ATT, 1.3MEDIAATT, 1.4POLSTAKE, 1.6RESANALYSEDTHOROUGH) are not constantly associated with a positive Outcome 1 (whenever they are present, the outcome is also present). The situation is similar but not identical for Outcome 2A: 1.4, 1.5, 1.7, and 1.8 are present in at least one negative outcome and cannot be considered sufficient for a positive one, unlike 1.0STUDIES, 1.2POL_ATT, 1.3MEDIAATT, and 1.6RESANALYSEDTHOROUGH. No single conditions are sufficient for the other two outcomes.

Boolean minimisations

8.0 The Boolean minimisations conducted on the 9-condition model indicated that the following six conditions might provide a good case coverage for both outcomes (in addition to the expected perfect consistency): 1.0studies, 1.1apestudies, 1.2pol_att, 1.4polstake, 1.5resanalysedl, 1.8authorisinge.

8.1 When applied to this 6-condition model, the Boolean minimisations returned the following results:
1.0STUDIES*1.1apestudies*1.4POLSTAKE*1.5RESANALYSEDL*1.8AUTHORISINGE is the most important combination for both outcomes, covering 92% of cases of Outcome 1 (88% uniquely) and 93% of cases for Outcome 2A (91% uniquely).

1.0STUDIES*1.1apestudies*1.2pol_att*1.5RESANALYSEDL*1.8AUTHORISINGE is an alternative combination that is sufficient but covers only between 5% and 6% of cases for both outcomes (2% uniquely)

8.2 Both combinations cover 94% of positive cases.

For Outcome 2B and Outcome 3 the following combination is the most important (91% of Outcome 3 positive cases covered, all uniquely (albeit with consistency of 93%); and 100% of Outcome 3 positive cases covered – although with consistency of only 75%):

1.0STUDIES*1.1apestudies*1.2POL_ATT*1.4POLSTAKE*1.5RESANALYSEDL*1.8AUTHORISINGE

9.0 This result suggests that the 4-condition model 1.0studies + 1.1apestudies + 1.5resanalysedl + 1.8authorisinge is worth exploring for a less complex solution in the hope that coverage is preserved.

9.1 The Boolean minimisation conducted on these four conditions return the following result:

1.0STUDIES*1.1apestudies*1.5RESANALYSEDL*1.8AUTHORISINGE is the only combination in the solution, and it covers 94% of cases with a positive Outcome 1; 95% of cases with a positive Outcome 2A or Outcome 2B (all uniquely: although for Outcome 2B the consistency is 91%) and 100% of cases with a positive Outcome 3 (although the consistency is relatively low at 72%).

9.2 The Venn diagrams for the four outcomes are very similar: the vast majority of (positive) cases are included in the 1011 rectangle. The combination 0011 is present but inconsistent and covers an average of 4 cases: some positive and some negative for the first three outcomes and all negative for Outcome 3.

Figure 21. Outcome 1

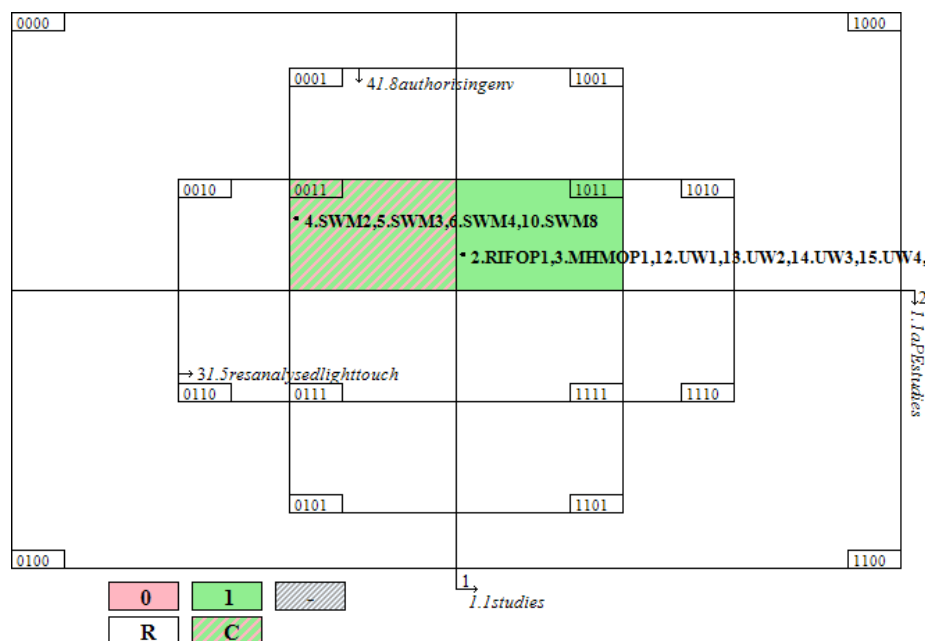

Figure 22. Outcome 2A

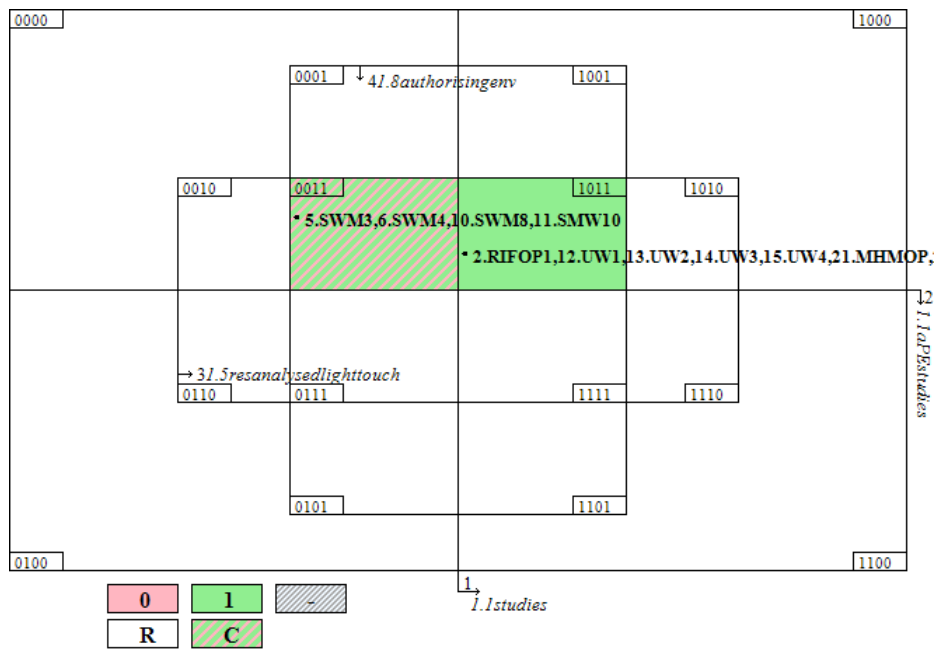

Figure 23. Outcome 2B

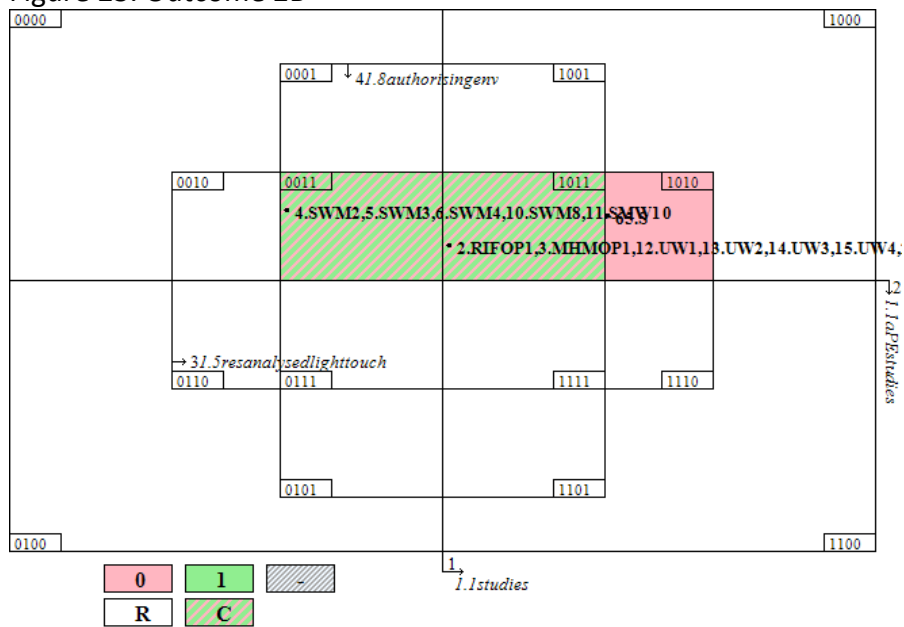
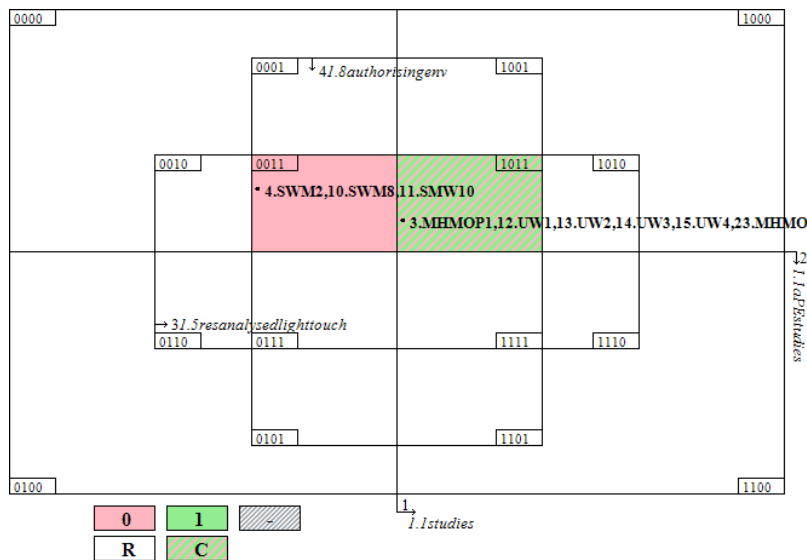

Figure 24. Outcome 3



10.0 We can visualise the 5-condition model 1.0studies, 1.1apestudies, 1.4polstake, 1.5resanalysedl, 1.8authorisinge (except for Outcome 1) which returns the same 4-condition single combination, which covers 95% of cases with a positive Outcome 2A or a positive Outcome 2B (being 91% consistent in the latter case).

10.1 **1.0STUDIES*1.1apestudies*1.5RESANALYSEDL*1.8AUTHORISINGE**

If we add 1.4, the resulting combination leads to a positive Outcome 3 in 72% of the cases where it's observed, and is present in 100% of the positive Outcome 3 cases.

10.2 **1.0STUDIES*1.1apestudies*1.4POLSTAKE*1.5RESANALYSEDL*1.8AUTHORISINGE**

10.3 The Venn diagram shows that the vast majority of Outcome 2A positive cases is concentrated in the rectangle 10111 (which is contradictory for Outcome 2B and Outcome 3); with one case in 10011 (not included in Outcome 3). 00011 is a contradictory combination with mixed outcomes for Outcome 2A and Outcome 2B, which becomes consistently negative in Outcome 3. 00111 is covered by only one (negative) case for all three outcomes.

Figure 25. Outcome 2A

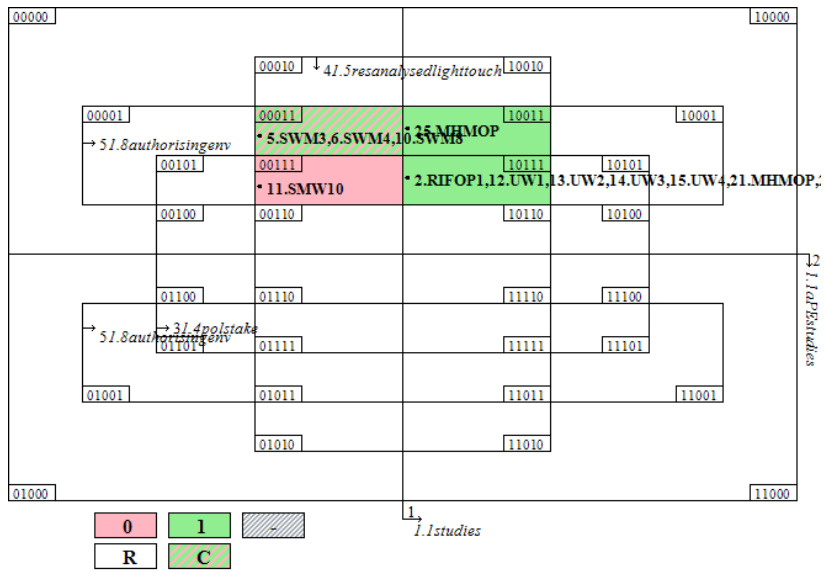

Figure 26. Outcome 2B

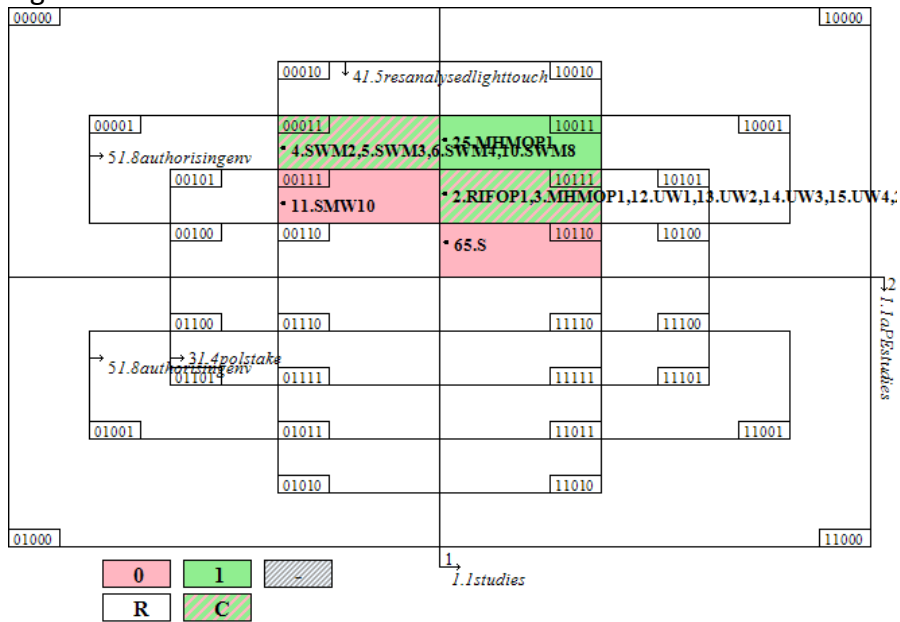
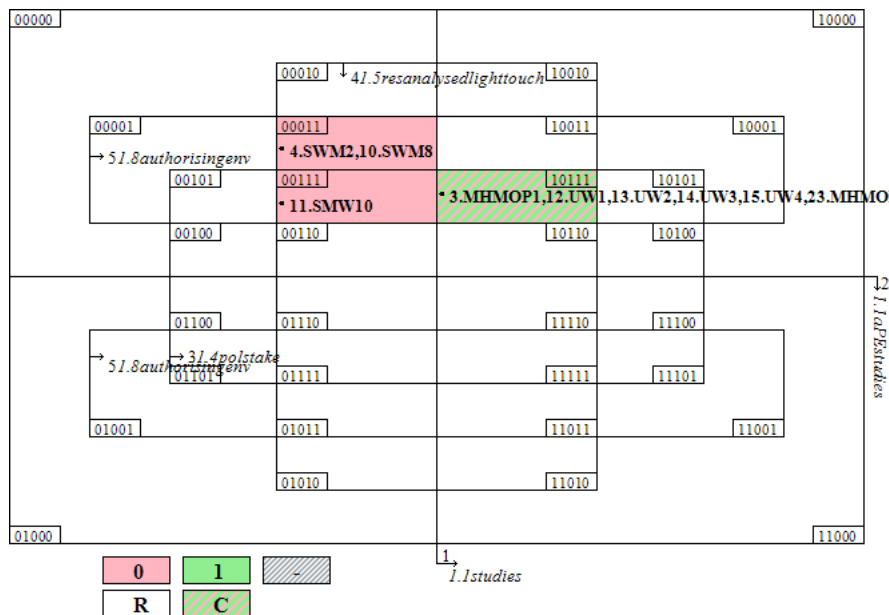

Figure 27. Outcome 3



11.0 Since 1.0, 1.5, and 1.8 are necessary conditions, we can remove them from the original 9-condition model and see what happens. We subsequently remove 1.7 so we can test the following 5-condition model:

11.1 1.0studies, 1.2pol_att, 1.3mediaatt, 1.4polstake, 1.6resanalysedt

The most important combination covers 66% of cases with a positive Outcome 1 (46% uniquely)

1.0STUDIES*1.4POLSTAKE*1.6resanalysedt

11.2 If we add 1.2POL_ATT, the resulting combination covers 67% of positive Outcome 2A and positive Outcome 2B cases (47% uniquely); and 100% of cases with a positive Outcome 3 (although consistency is only 75% here):

11.3 1.0STUDIES*1.2POL_ATT*1.4POLSTAKE*1.6resanalysedt

The third most important combination covers 44% of cases with positive Outcome 1, Outcome 2A, and Outcome 2B, between 23% and 26% uniquely (Outcome 2B being 93% consistent):

11.4 1.0STUDIES*1.2POL_ATT*1.3mediaatt*1.4POLSTAKE

Finally, the least important combination covers only 4% of cases with a positive Outcome 1, Outcome 2A, and Outcome 2B:

11.5 1.0STUDIES*1.2pol_att*1.3mediaatt*1.6resanalysedt

The Venn diagrams for the first three outcomes are very similar; the increase in the number of negative cases is visible.

Figure 28. Outcome 1

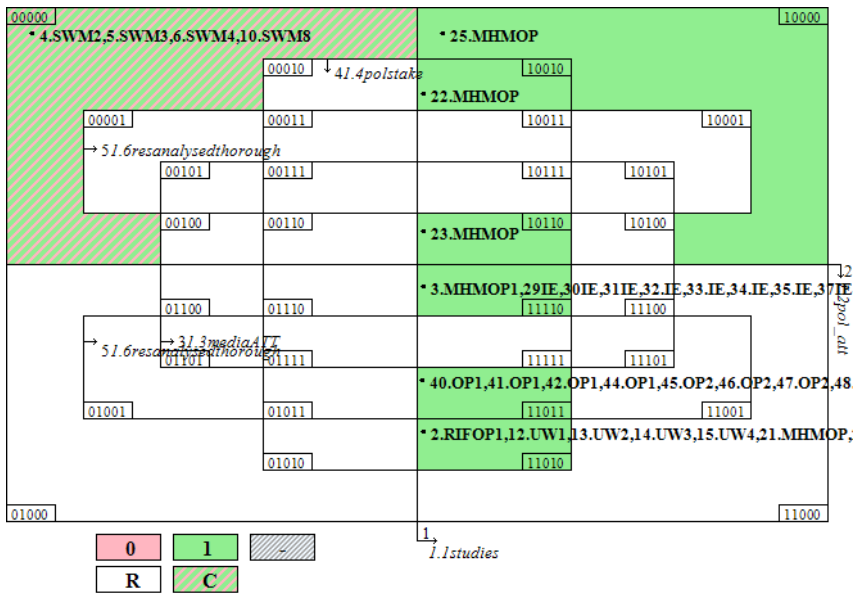

Figure 29. Outcome 2A

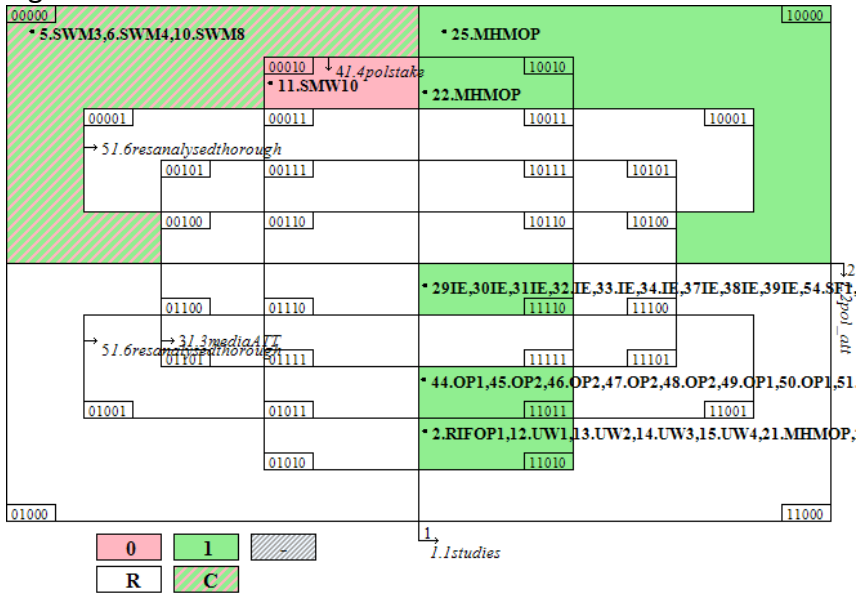

Figure 30. Outcome 2B

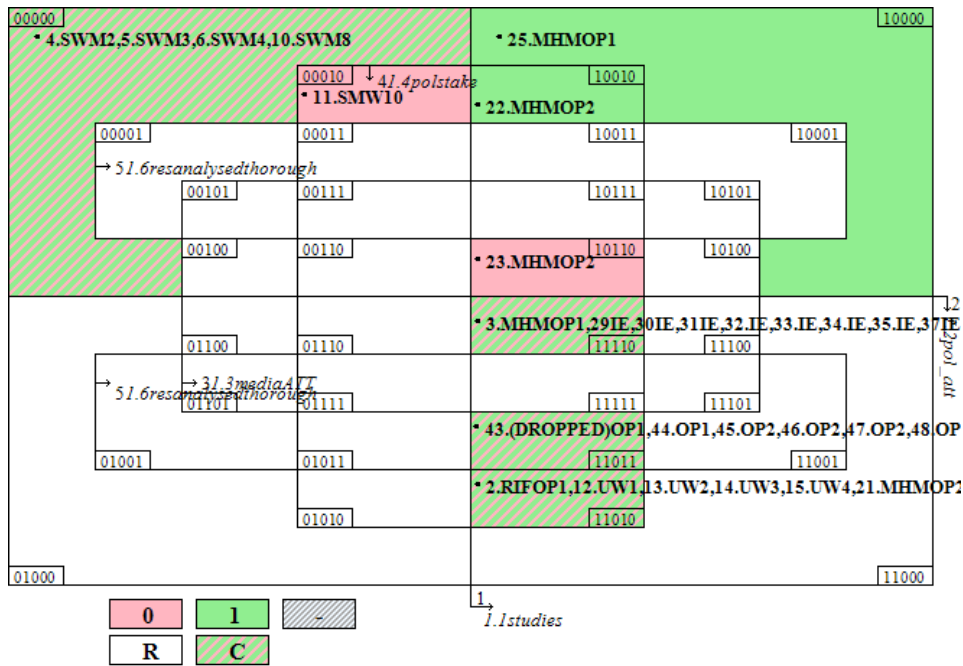
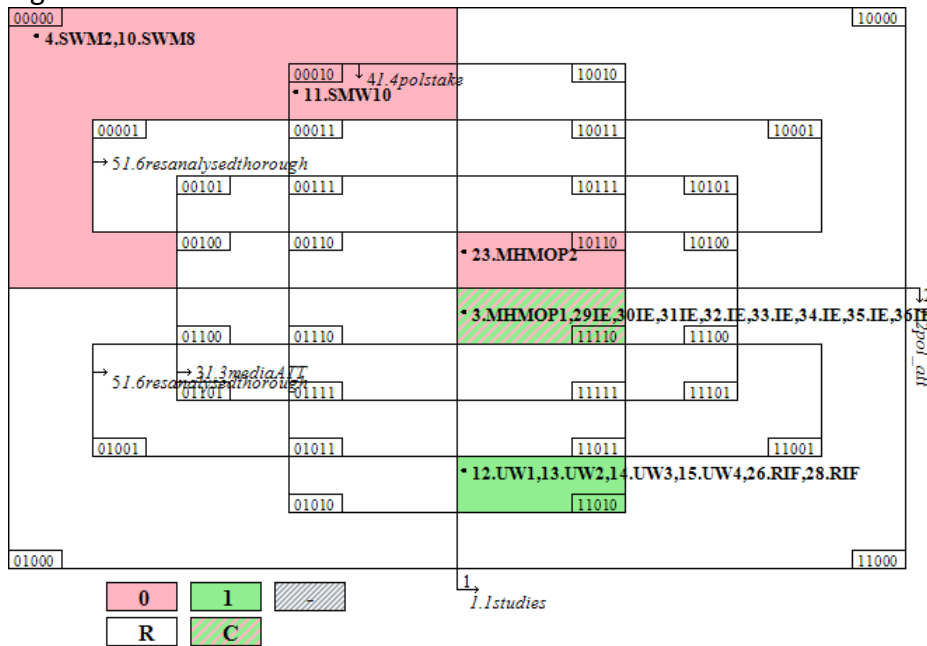

Figure 31. Outcome 3



11.6 It's interesting that in the first two diagrams, the negative cases are all on the left: if a case is on the right, then it's positive. This changes in the third and in the fourth the positive cases are confined to the bottom-right quadrant: the cases on top of the diagram are all negative.

12.0 The 4-condition model 1.0studies + 1.2pol_att + 1.4polstake + 1.6resanalysedt preserves high levels of consistency and coverage and returns the following findings. The most important combination, covering 88% of cases with a positive Outcome 1 (uniquely), 91% of cases with a positive Outcome 2A (uniquely), and 91% of cases with a positive Outcome 2B (uniquely, although consistency is also 91%) is:
1.0STUDIES*1.2POL_ATT*1.4POLSTAKE

12.1 If 1.6resanalysedt is added,

1.0STUDIES*1.2POL_ATT*1.4POLSTAKE*1.6resanalysedt covers 100% of cases with a positive Outcome 3 (although consistency is 75%).

The other important combination cover between 4% and 6% of cases for Outcome 1 and Outcome 2A:

1.0STUDIES*1.2pol_att*1.6resanalysedt

If we add 1.4polstake, the resulting combination covers 2% of cases with a positive Outcome 2B:

1.0STUDIES*1.2pol_att*1.4polstake*1.6resanalysedt.

Figure 32. Outcome 1

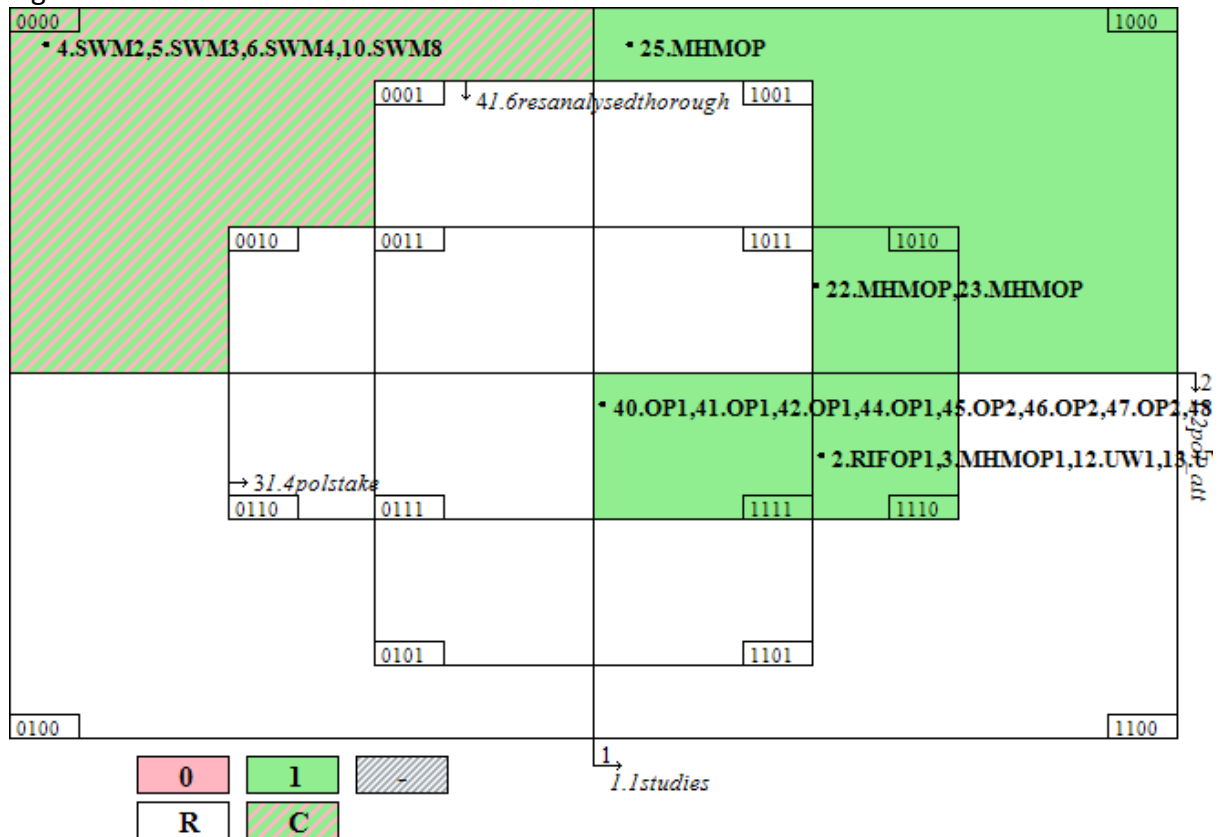

Figure 33. Outcome 2A

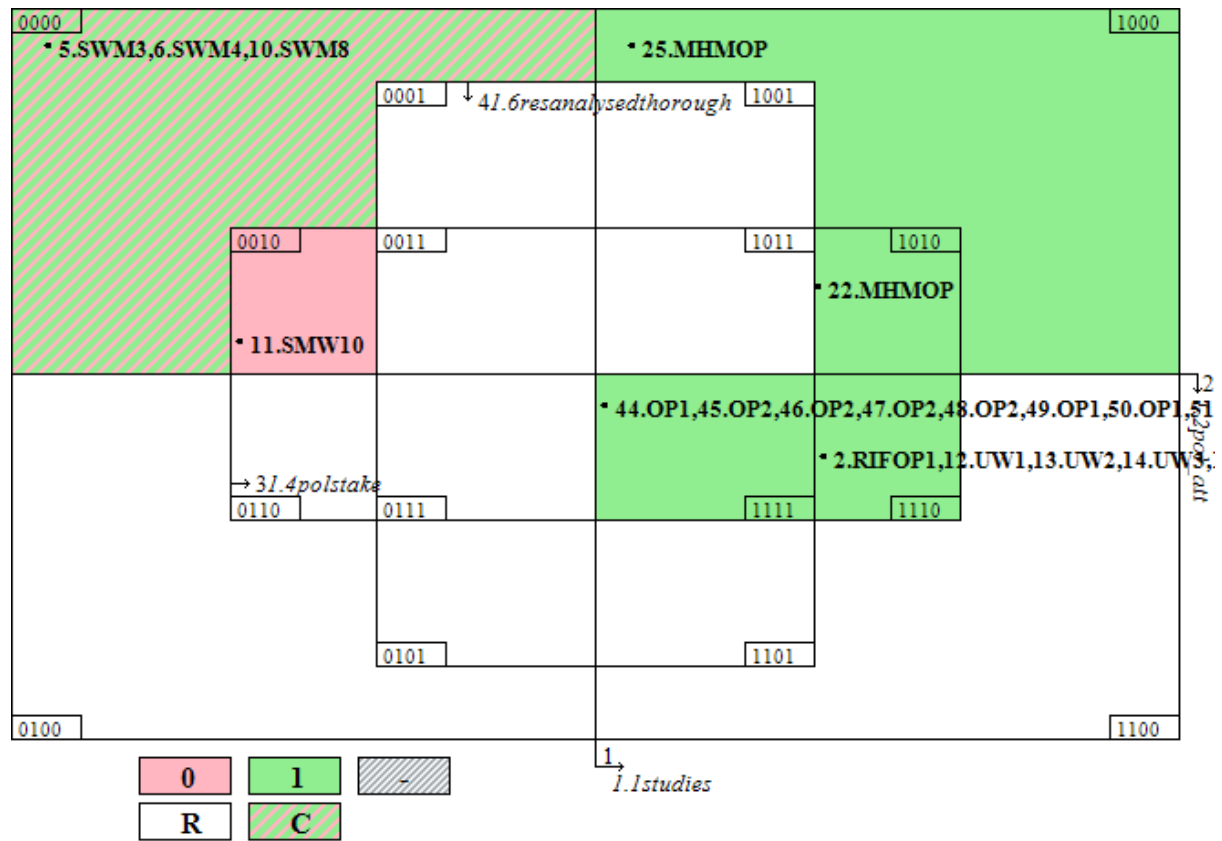

Figure 34. Outcome 2B

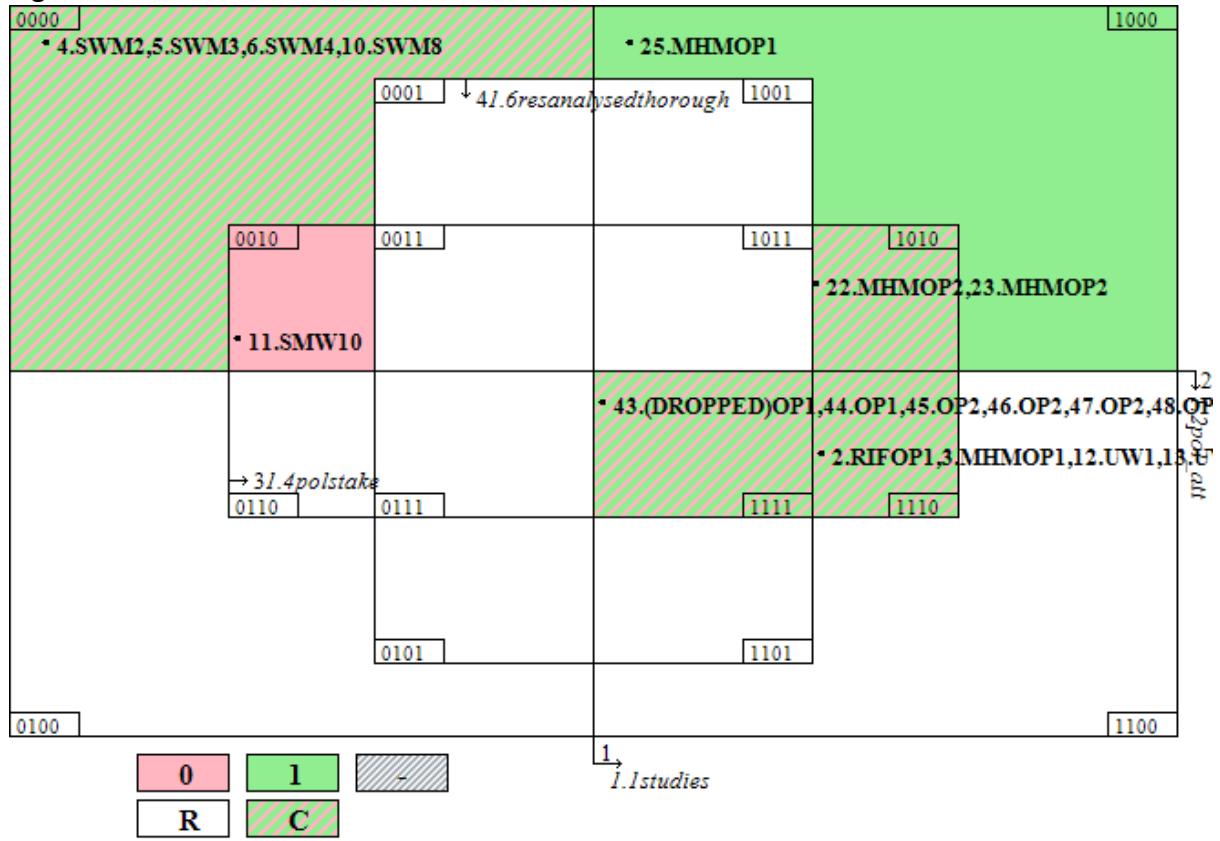
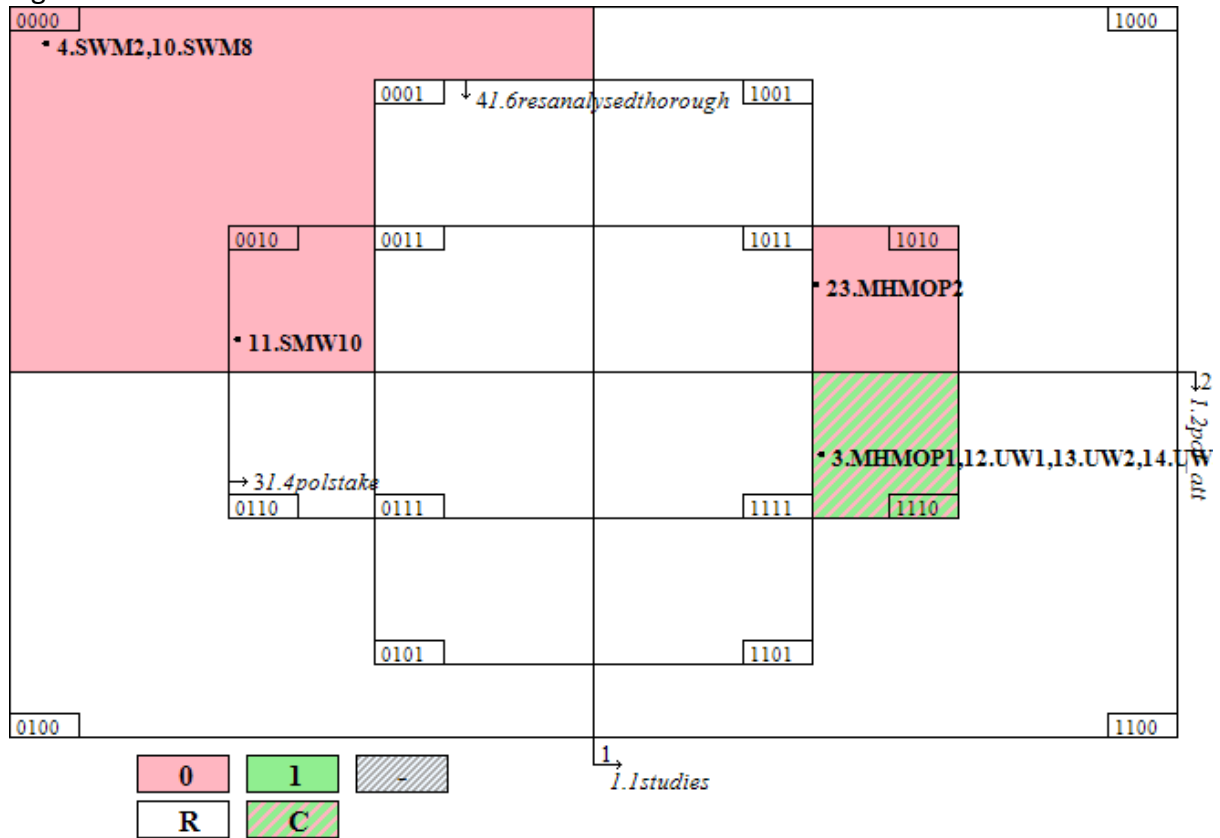

Figure 35. Outcome 3



Design

2.1rigres, 2.2sysapp, 2.3oned, 2.4humcen, 2.5posdev, 2.6adpextbp

13.0 The first two datasets are similar: the one analysed for Outcome 1 has 48 cases, of which 47 positive and one negative (10.SWM8_Wastepickers_advocacy); the one analysed for Outcome 2A has 40 cases, of which 38 positive and two negative (10.SWM8_Wastepickers_advocacy and 11.SMW10_bag_model). The third dataset has 44 cases, of which 38 positive and 6 negative. The Outcome 3 dataset has 34 cases, of which 22 positive and 12 negative. The condition 2.3oned is always absent except for one case in the Outcome 2B dataset.

13.1 There is no necessary condition but 2.2SysRes is present in about 90% of the positive cases for all outcomes. It's perhaps interesting that either absence of 2.1rigres or presence of 2.2 SYSAPP are needed for a positive Outcome 1 and Outcome 2A; and either 2.5POSDEV or 2.6EXTBP are needed for a positive Outcome 3.

13.2 For Outcome 1, the only case with a negative outcome does not present any of the six conditions except 2.6AdpExtBP; therefore whenever one of 2.1RIGRES, 2.2SYSAPP, 2.4HUMCEN, or 2.5POSDEV are present, Outcome 1 is positive. For outcome Outcome 2A, only 2.1.RIGSYSRES and 2.2.SYSRES are sufficient for a positive outcome as 2.4, 2.5 and 2.6 are sometimes associated with a negative outcome. For outcomes Outcome 2B and Outcome 3, no condition in itself is sufficient for the outcome.

Boolean minimisations

14.0 The Boolean minimisations conducted on the 6-condition model presents a complex picture where 2.4humcen is the weakest explanatory condition for the first two outcomes, and 2.3oned is the weakest for Outcome 2B, so we tested the 5-condition models 2.1rigres, 2.2sysapp, 2.3onedim, 2.5posdev, 2.6adpextbp and models 2.1rigres, 2.2sysapp, 2.4humcen, 2.5posdev, 2.6adpextbp

14.1 We start with the first model 2.1rigres, 2.2sysapp, 2.3onedim, 2.5posdev, 2.6adpextbp.

For Outcome 1, the Boolean minimisation conducted on this model covers 94% of positive cases for Outcome 1 and 92% for Outcome 2A and the most important combination is: **2.2SYSRES*2.3oned*2.5POSDEV**, which covers 70% of cases (23% uniquely) for Outcome 1 and 71% of cases (53% uniquely) for Outcome 2A. If we add 2.1rigres, the resulting combination covers 55% of cases with positive Outcome 2B (37% uniquely, with 95% consistency)

2.1rigres*2.2SYSRES*2.3oned*2.5POSDEV

14.2 **2.1rigres*2.2SYSRES*2.3oned*2.6EXTBP** is also important, covering 32% of cases (15% uniquely) for Outcome 1 and 37% of cases (18% uniquely) for Outcome 2A and Outcome 2B (the latter with 93% consistency); and 59% of cases with a positive Outcome 3 (all uniquely, with a consistency of 93%).

14.3 The Venn diagrams for the first two outcomes are virtually identical; the only difference concerns the consistency of the 00010 combination / rectangle: it's contradictory (one positive and one negative outcome) for Outcome 2A and consistent for Outcome 1.

14.4 The combination covering the largest number of positive cases is -101- or 2.2SYSRES*2.3oned*2.5POSDEV (both left and right, bottom, outside the horizontal rectangle, inside the vertical rectangle, both inside and outside the fifth condition area). The diagrams for Outcome 2B and Outcome 3 are, however, very different and there are no combinations that remain consistent across all four outcomes.

Figure 36. Outcome 1

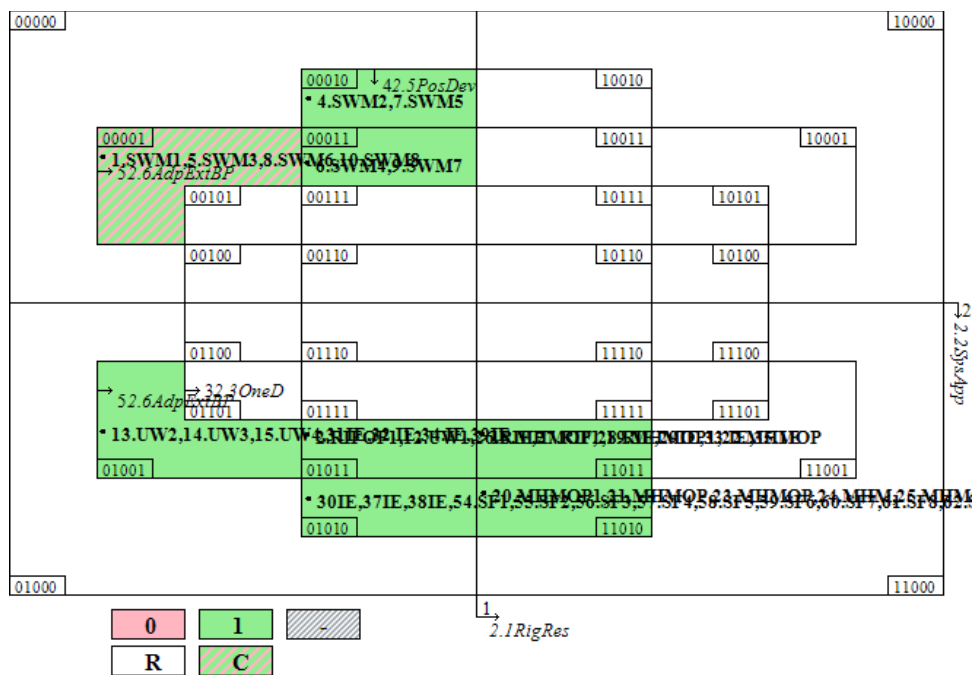

Figure 37. Outcome 2A

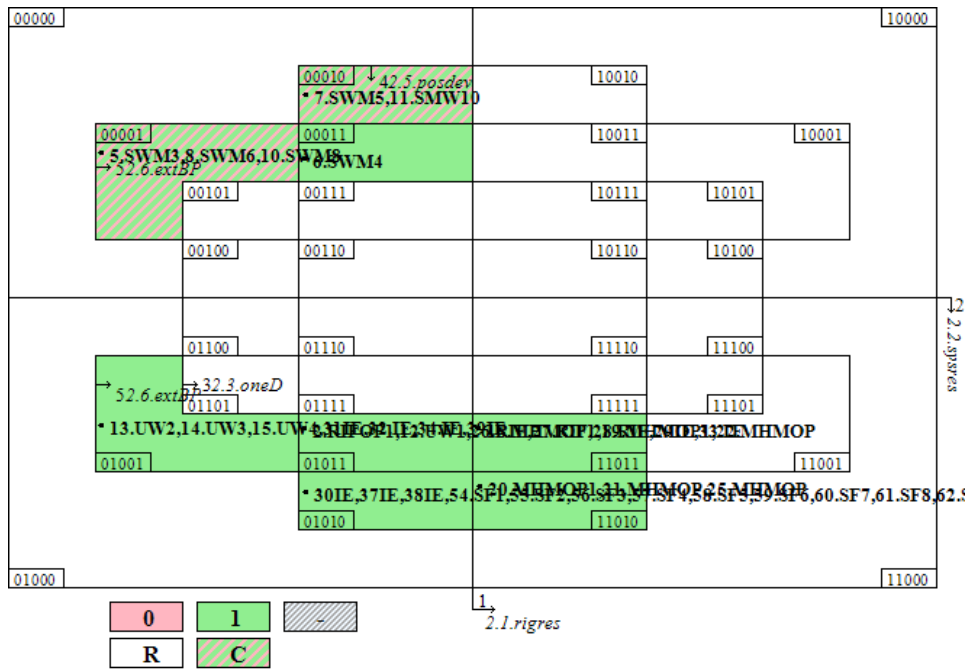

Figure 38. Outcome 2B

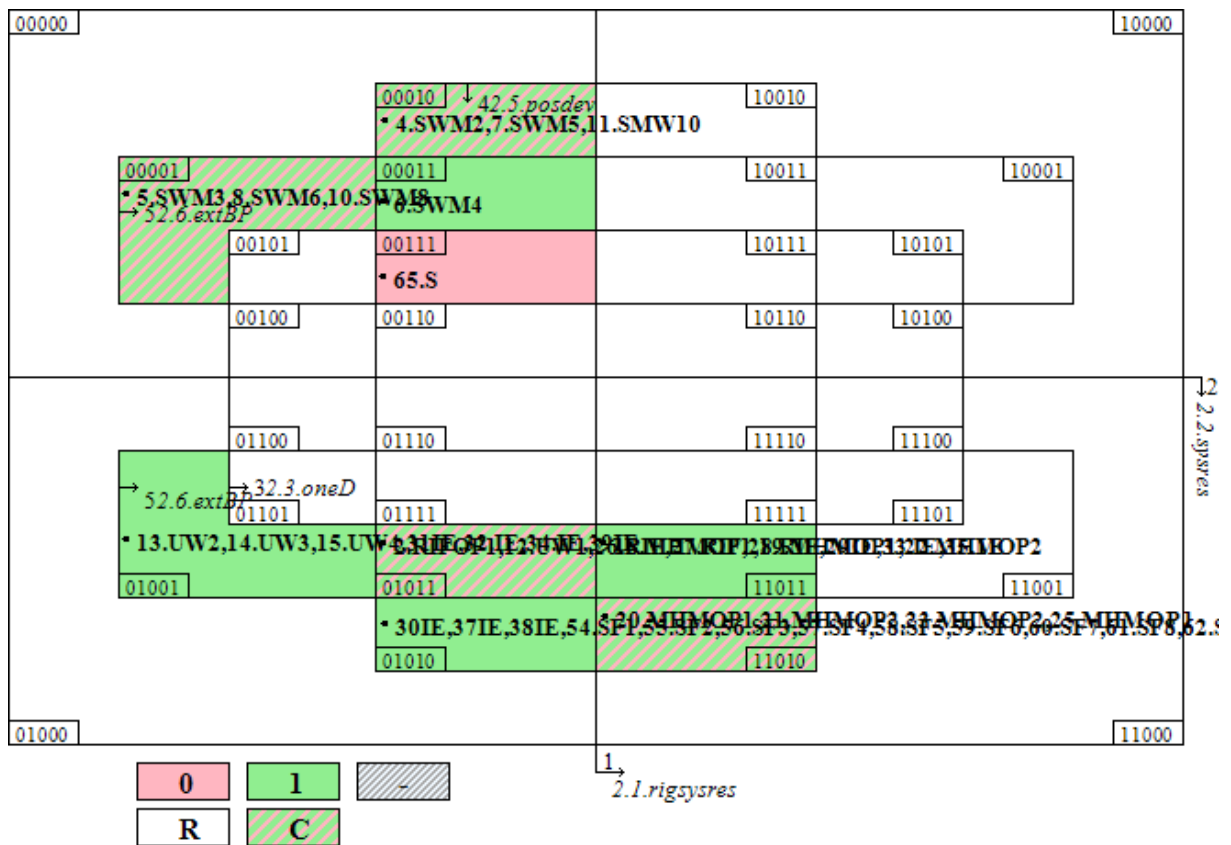
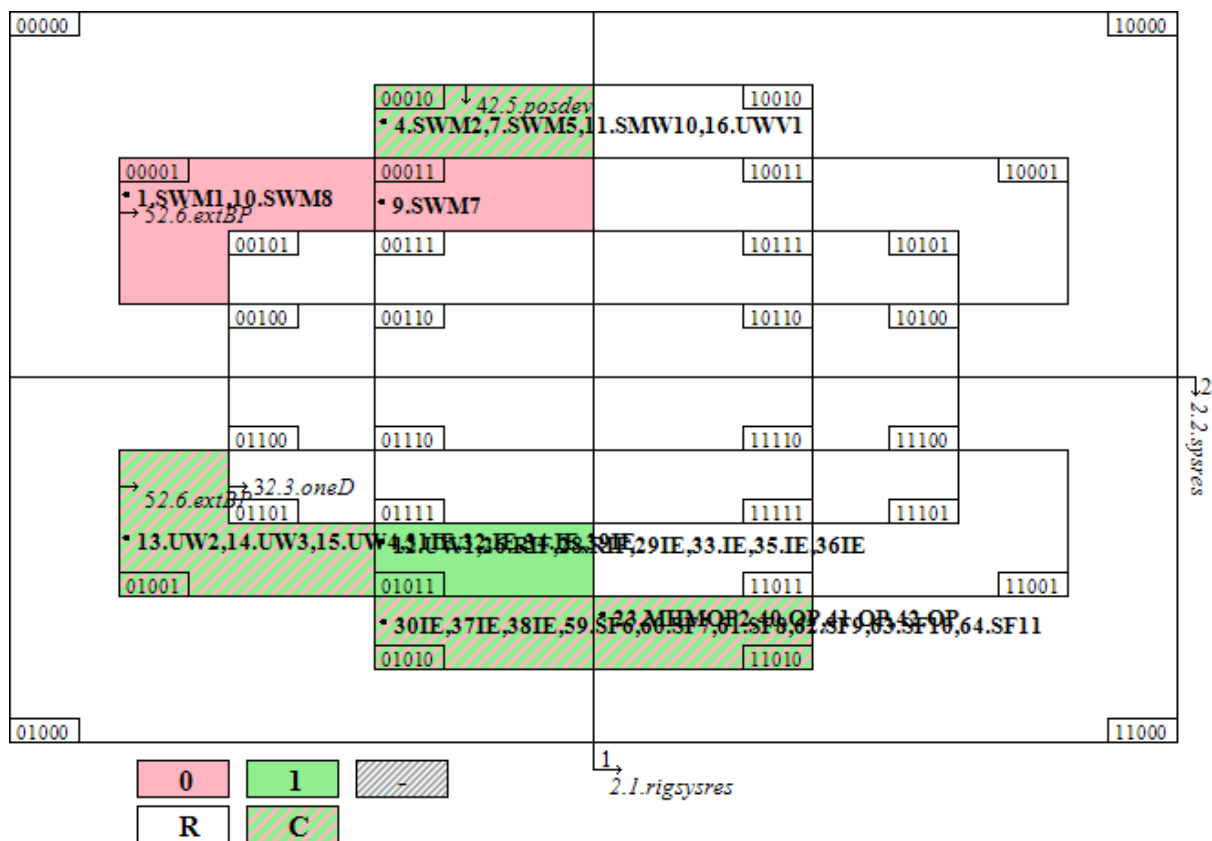

Figure 39. Outcome 3



15.0 Since the first condition doesn't seem to be particularly relevant, we can test the reduced 4-condition model 2.2.sysres, 2.3.oned, 2.5.posdev, 2.6.extbp.

In this model most important combination is

2.3oned*2.5POSDEV which covers 79% of cases with a positive Outcome 1, of which 55% uniquely. In the first Venn diagram below, it is the area at the top and inside the horizontal rectangle (-01-).

15.1 For Outcome 2A and Outcome 2B, we need to add one condition (for Outcome 2B the combination has 93% consistency):

2.2.SYSRES*2.3oned*2.5POSDEV which covers 71% of cases (45% uniquely). In the second Venn diagram, it is the area to the right, top, and inside the horizontal rectangle (101-) The combination **2.2SYSRES*~2.3oned*2.6EXTBP** is also important, covering 38% of cases (15% uniquely) for Outcome 1 and 45% (18% uniquely) for Outcome 2A and Outcome 2B (for the latter it's 94% consistent). This combination also covers 59% of the cases where Outcome 3 is positive, all uniquely with 93% consistency. In both Venn diagrams, it is the 1001 rectangle.

15.2 The only combination remaining consistent (and positive) across all four outcomes is **2.2SYSRES*2.3oned*2.5POSDEV*2.6EXTBP (1011)**

2.2sysres*2.3oned*2.6EXTBP 00-1 consistently leads to a negative outcome (over 3 cases).

Figure 40. Outcome 1

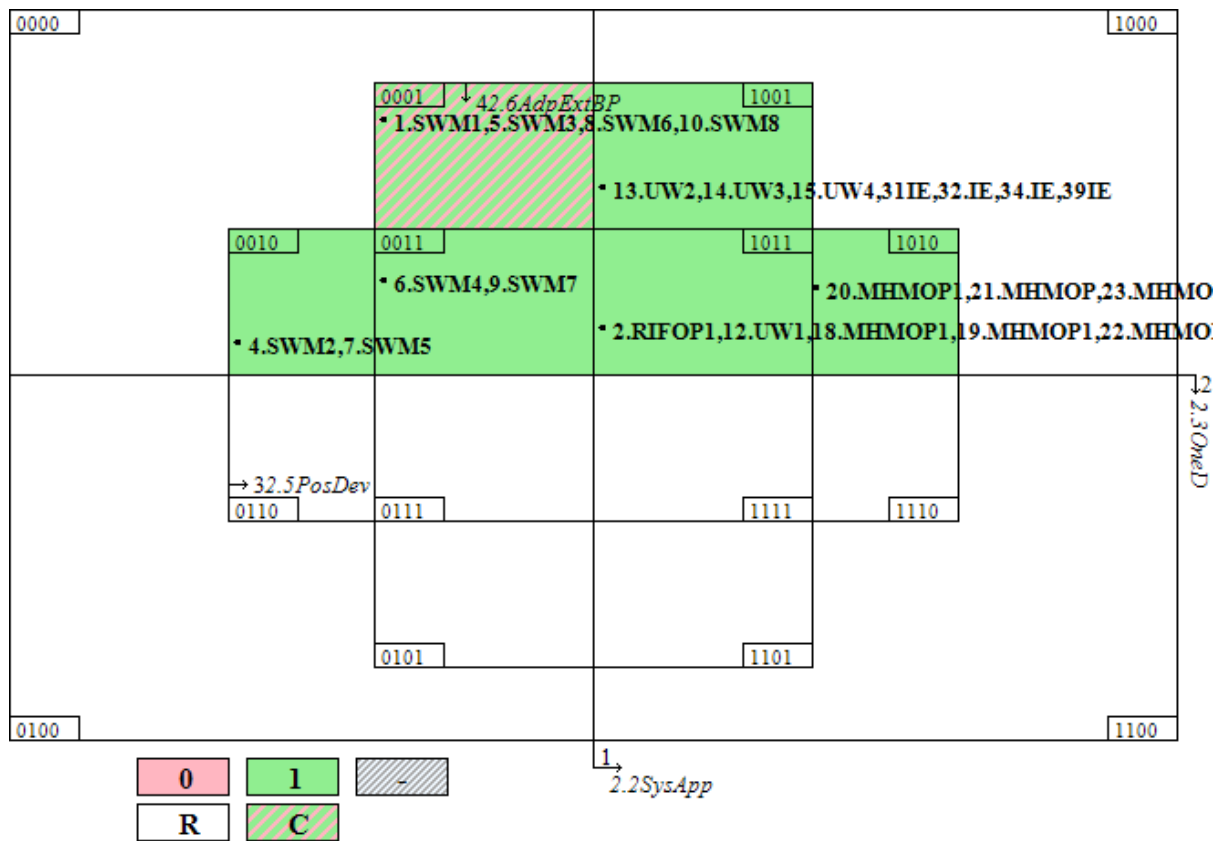

Figure 41. Outcome 2A

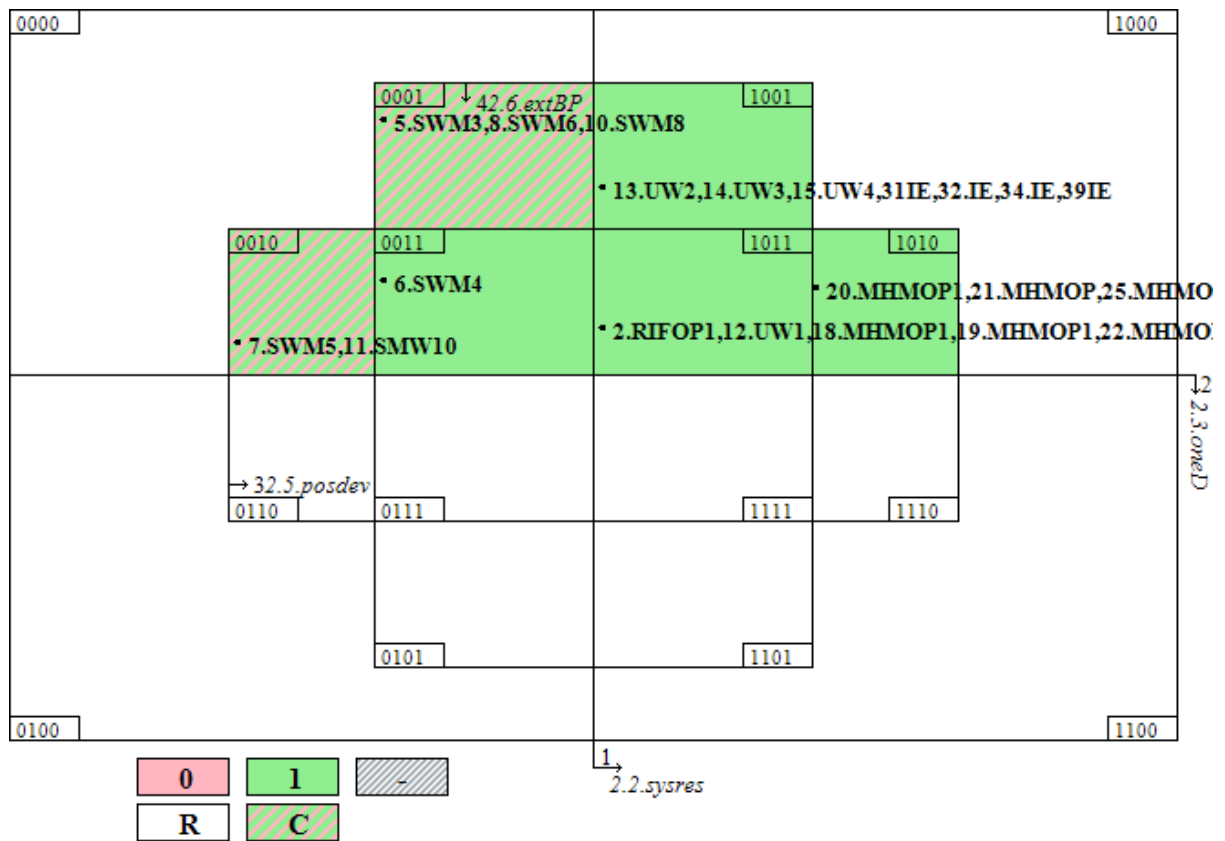

Figure 42. Outcome 2B

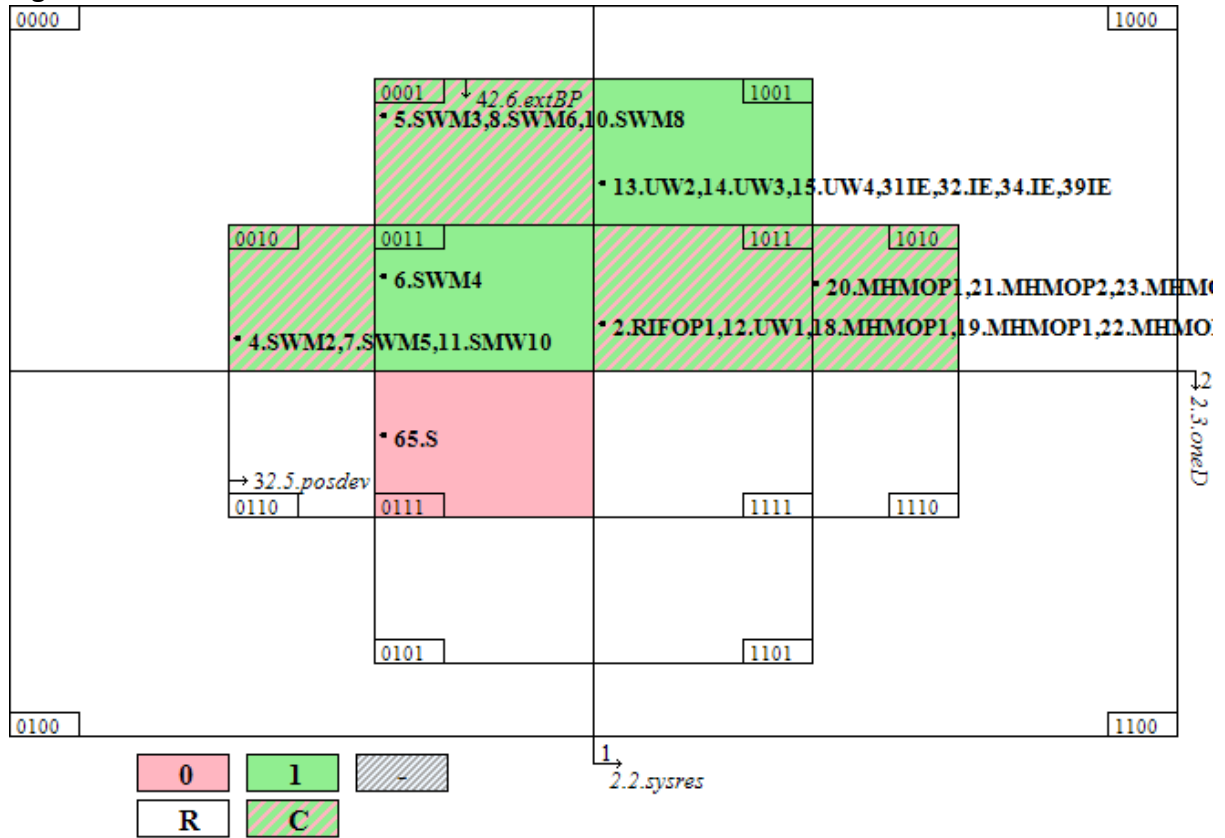
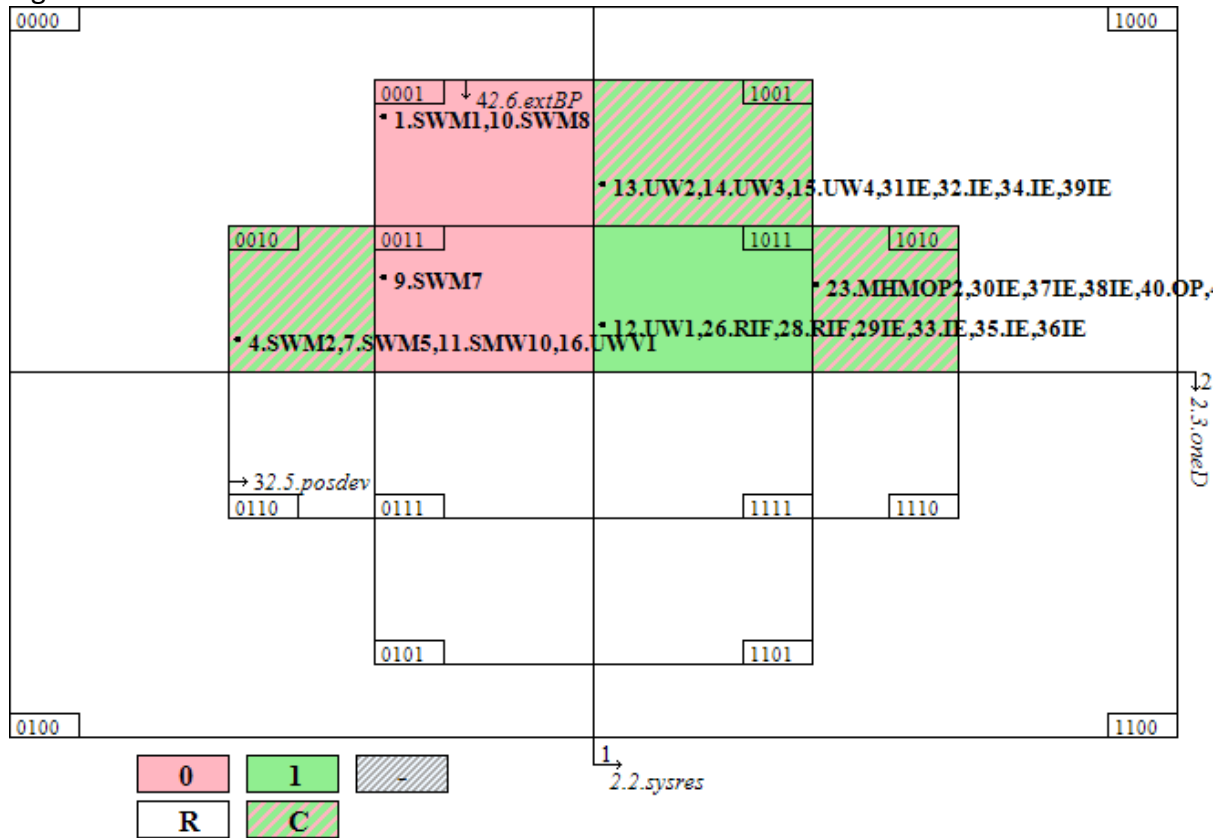

Figure 43. Outcome 3



16.0 The previous test tells us that the first three conditions are particularly important so we can test the 3-condition model 2.2.sysres, 2.3.oned, 2.5.posdev.

The solution for Outcome 2A and Outcome 2B is simpler and presents only one consistent combination, covering 89% of positive cases (uniquely): **2.2.SYSRES*2.3.oned** (It's the top-right rectangle in both Venn diagrams below for Outcome 2B it's 94% consistent). It's important for Outcome 3 too, covering 91% of cases although the consistency is only 74%.

16.1 This combination is very important for Outcome 1 as well, covering 85% of the positive cases, of which 15% uniquely. However the solution for Outcome 1 needs to include 001 as well, which covers four cases and can merge with 101, to obtain -01 or the area at the top and inside the central rectangle:

2.3oned*2.5POSDEV covers 79% of cases, of which 9% uniquely.

16.2 No combination remains consistent across the four outcomes (see below).

Figure 44. Outcome 1

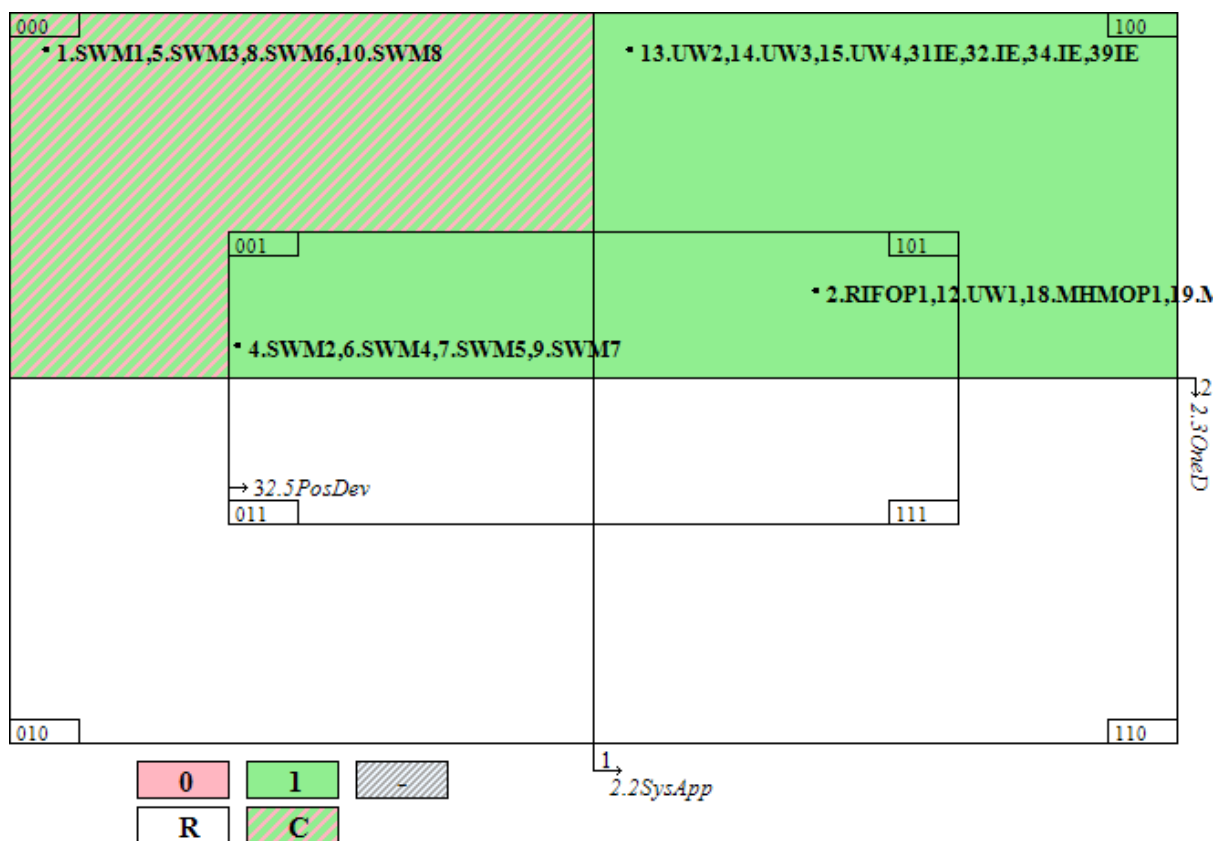

Figure 45. Outcome 2A



Figure 46. Outcome 2B

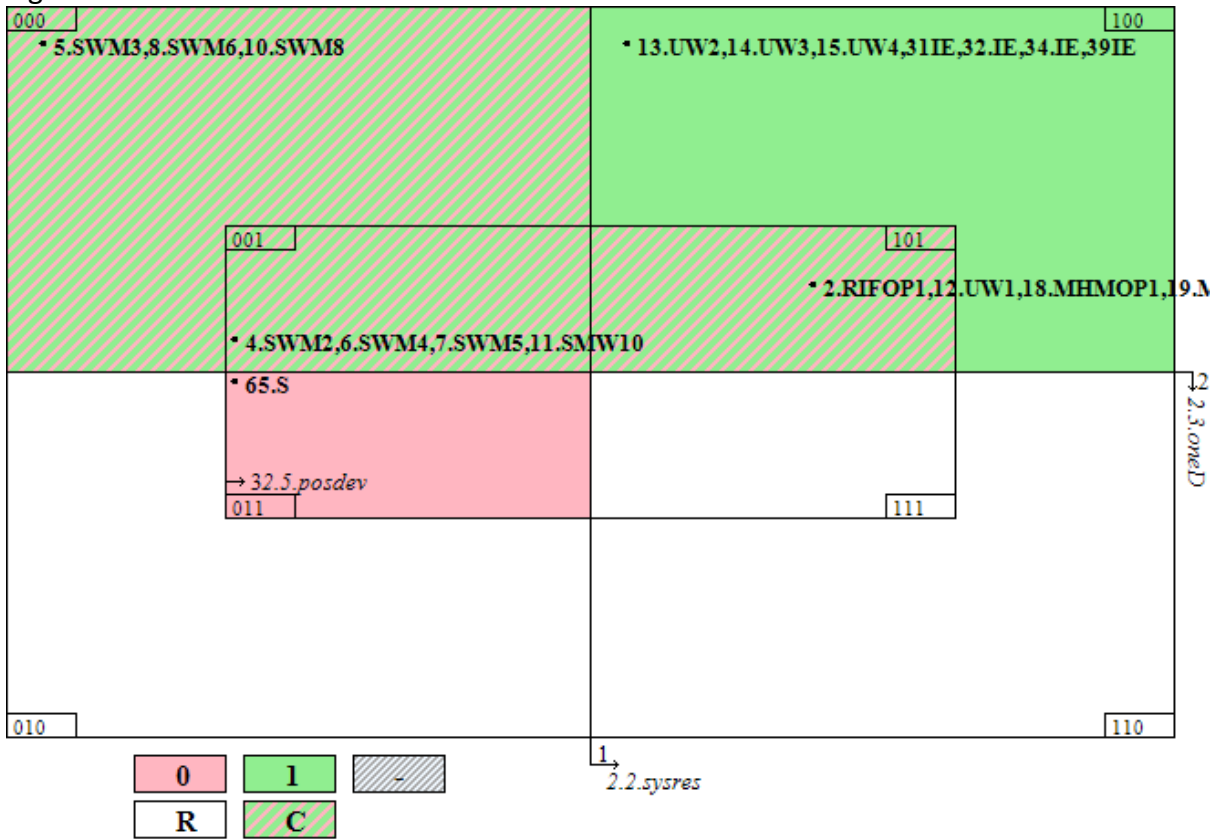
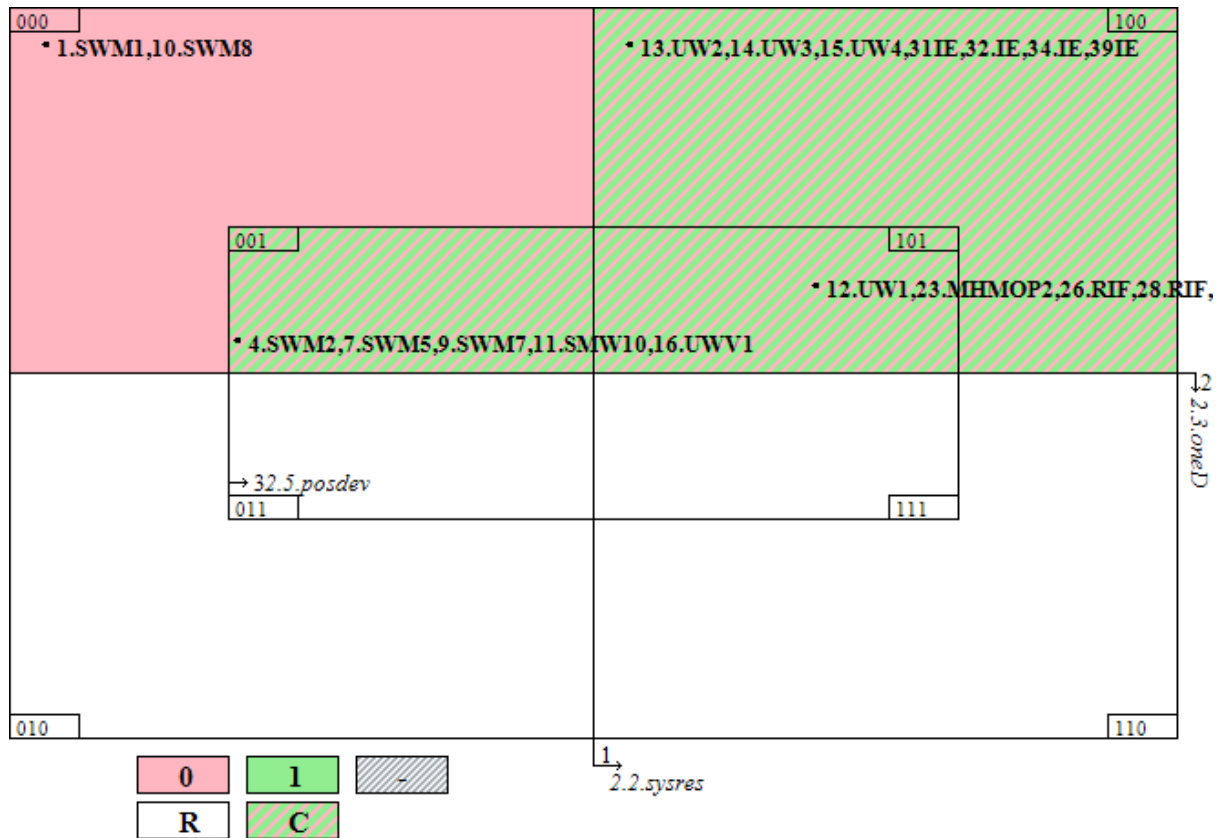

Figure 47. Outcome 3



17.0 We can argue that the first two are the most important conditions and test the two-condition model 2.2 and 2.3.

The solution, covering 85% of cases for Outcome 1 and 89% for Outcome 2A, is made of only one combination:

2.2SYSRES*2.3oned

It's represented by the top-right corner (10) or the Venn diagrams below. As the diagrams show, the consistency decreases for Outcome 2B (94%) and Outcome 3 (74%).

Figure 48. Outcome 1

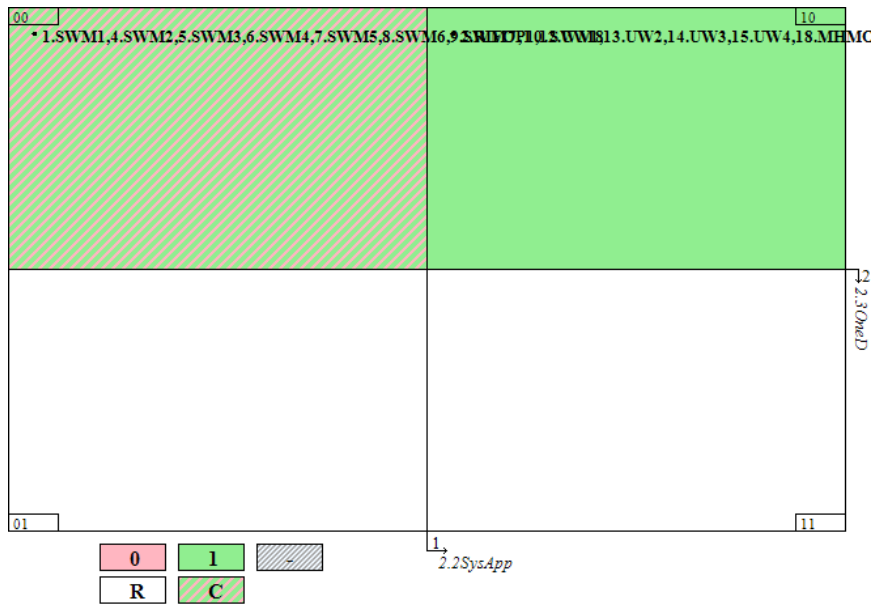

Figure 49. Outcome 2A

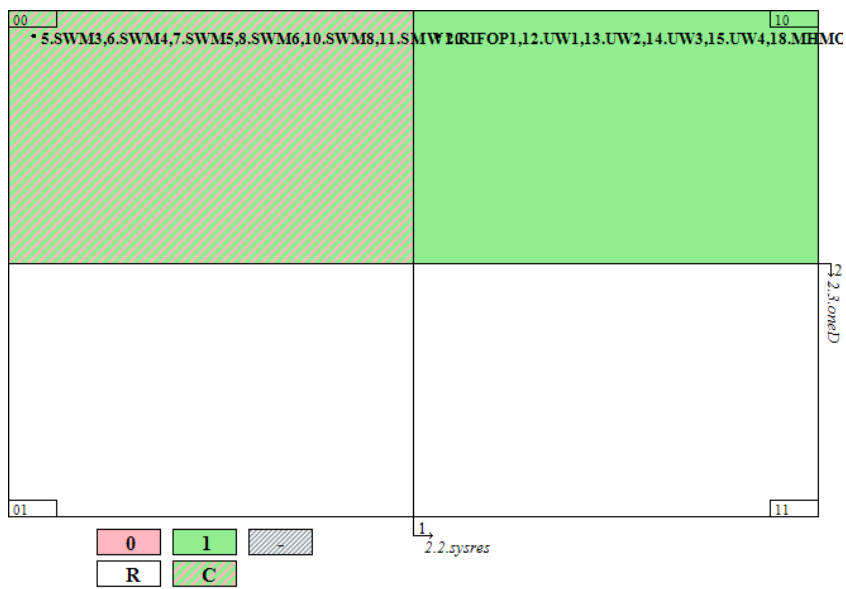

Figure 50. Outcome 2B

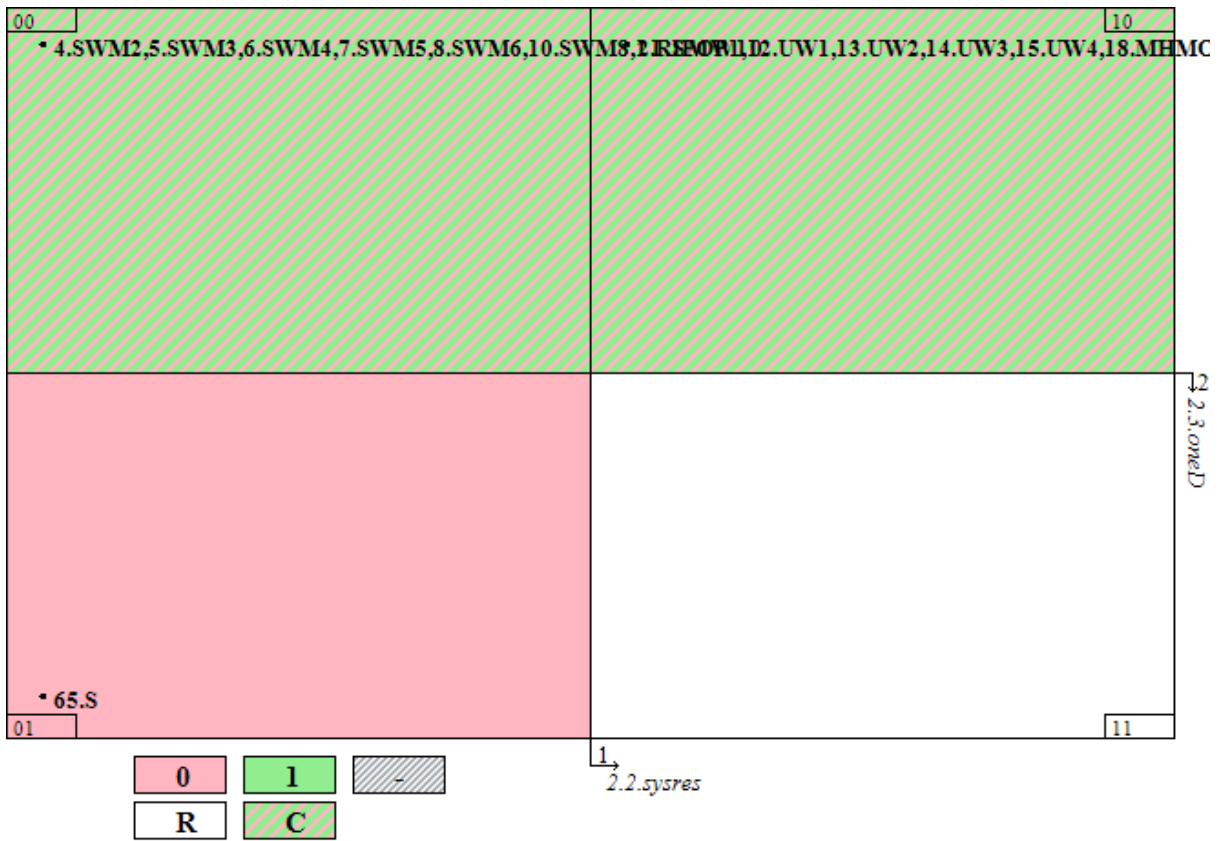
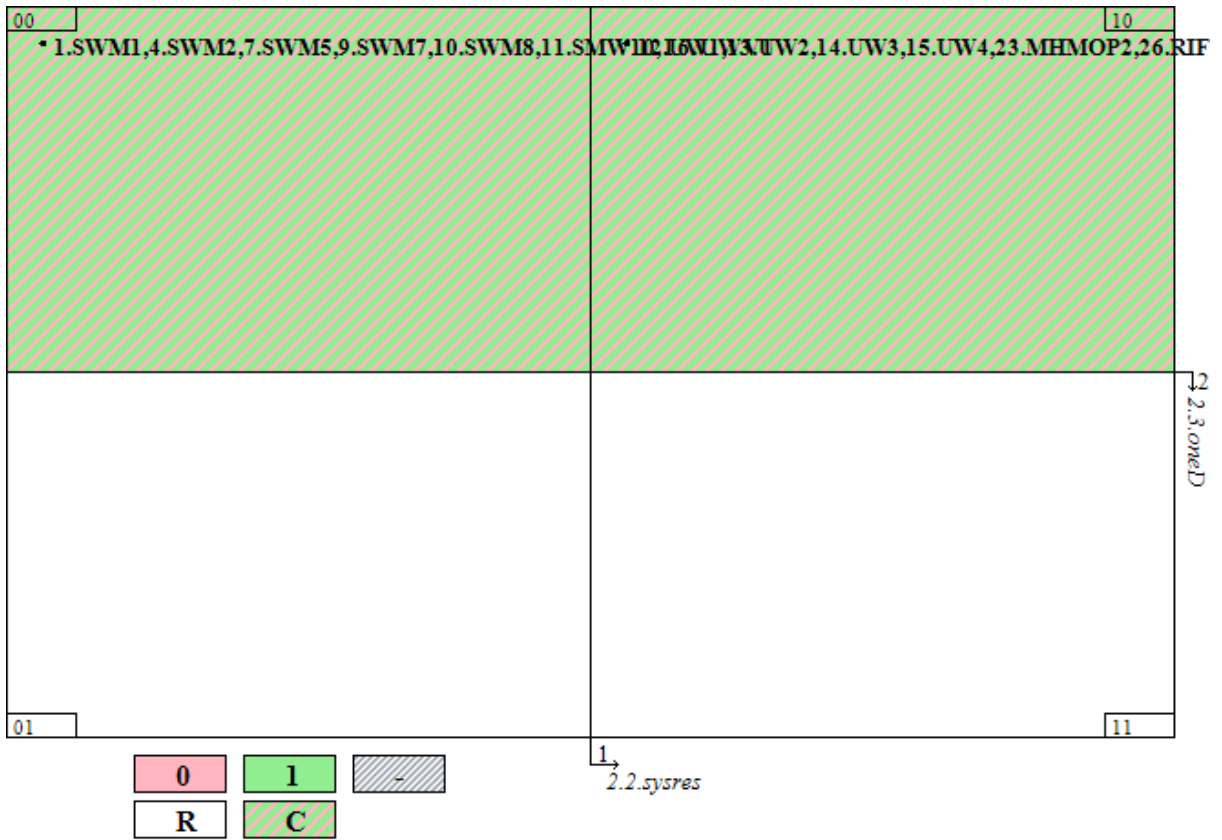

Figure 51. Outcome 3



18.0 As anticipated, the second 5-condition model tested is 2.1.rigres + 2.2.sysapp + 2.4.humcen + 2.5.posdev + 2.6.adpextbp. The most important combination is **2.2SYSRES*2.5POSEDEV** which covers 70% of cases with a positive Outcome 1 and Outcome 2A (around 50% uniquely). If we add either the absence of 2.1.rigres or the presence of 2.4HUMAN, the combinations **2.1rigres*2.2SYSRES*2.5POSEDEV** and **2.2SYSRES*2.4HUMAN*2.5POSEDEV** each cover 55% of cases where Outcome 2B is positive.

18.1 The second most important combination is **2.1.rigres*2.2.SYSRES*2.6.EXTBP** which covers 32% of cases where Outcome 1 is positive (15% uniquely); 37% of cases where Outcome 2A and Outcome 2B are positive (18% uniquely, with a 93% consistency for Outcome 2B); and 59% of cases where Outcome 3 is positive (55% uniquely, with a consistency of 93%).

18.2 Finally, if we add 2.4HUMAN, **2.1.rigsysres*2.2.SYSRES*2.4.HUMAN*2.6.EXTBP** covers 41% of cases where Outcome 3 is positive.

18.3 The Venn diagrams for the first two outcomes are identical. Moving to Outcome 2B, we can see that more combinations where 2.2 is absent become inconsistent and combinations remain consistent only when 2.2 is present. Only a few areas remain consistent when moving to Outcome 3.

Figure 52. Outcome 1

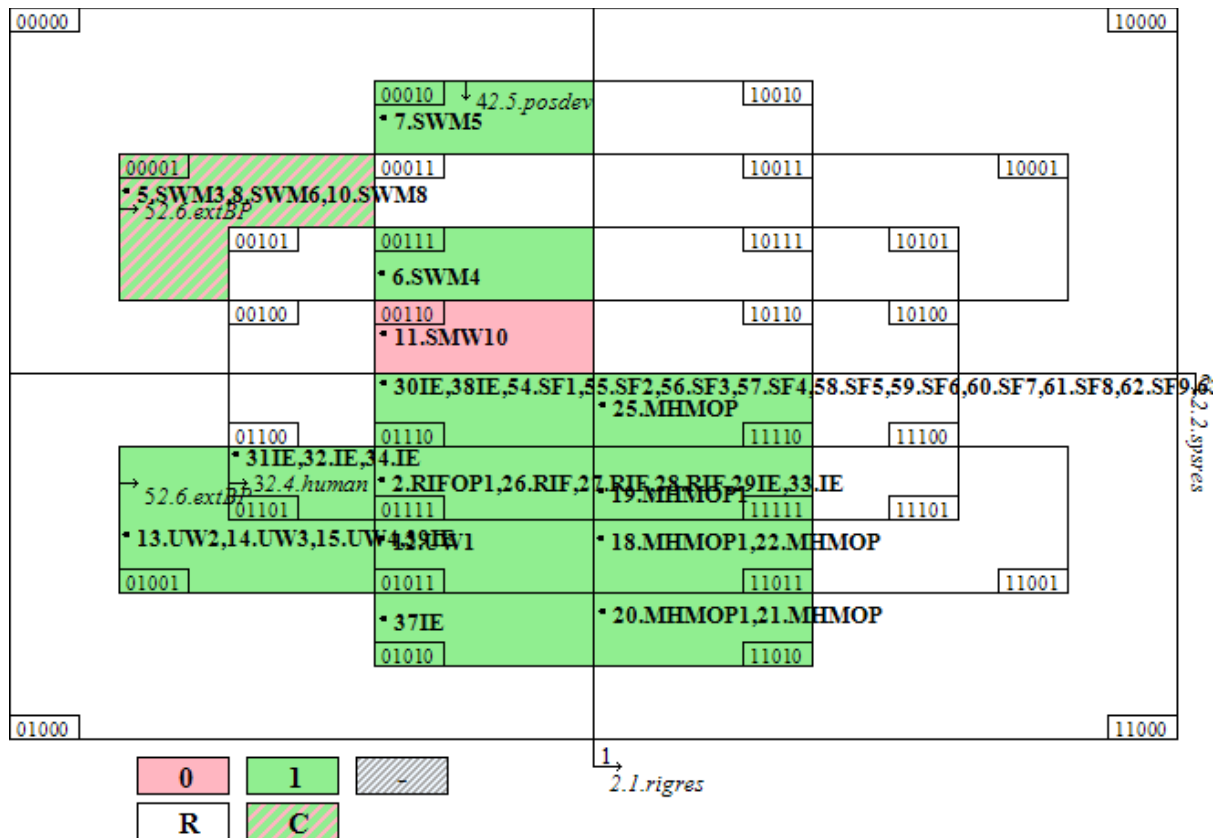

Figure 53. Outcome 2A

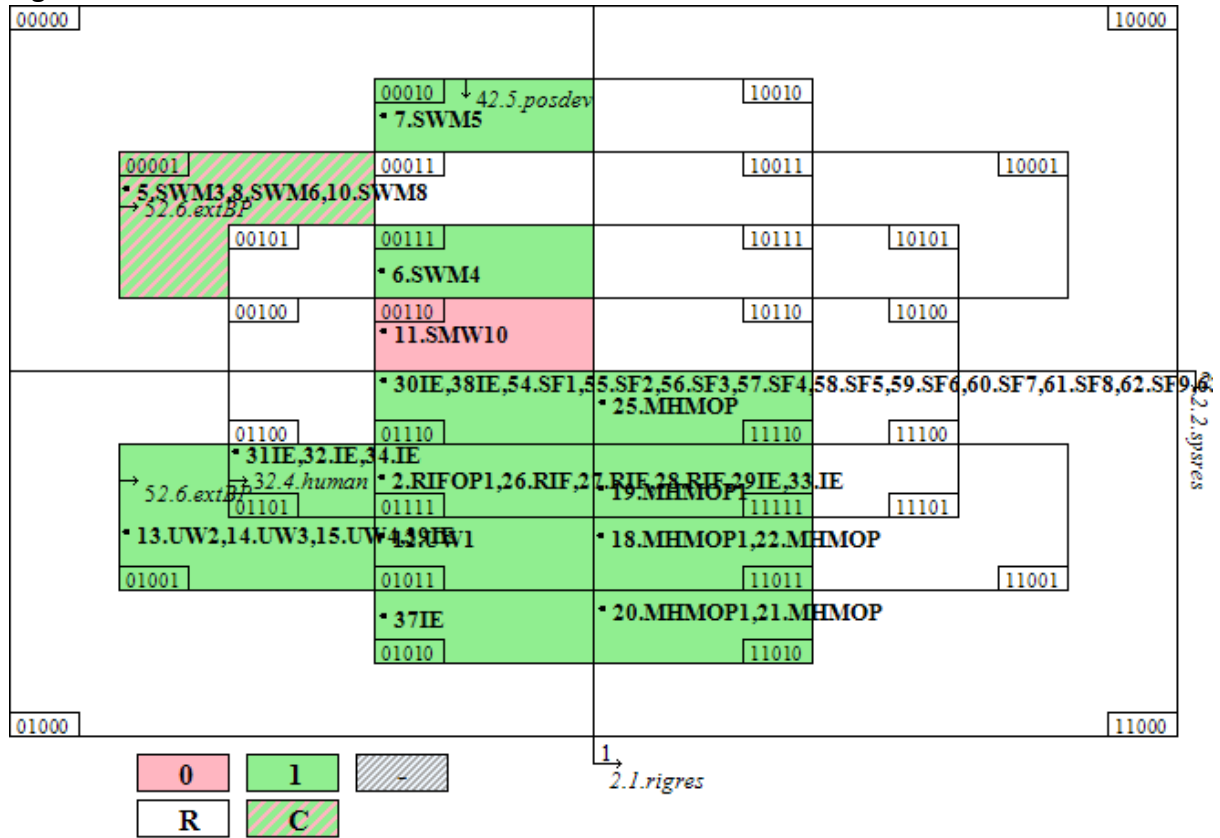

Figure 54. Outcome 2B

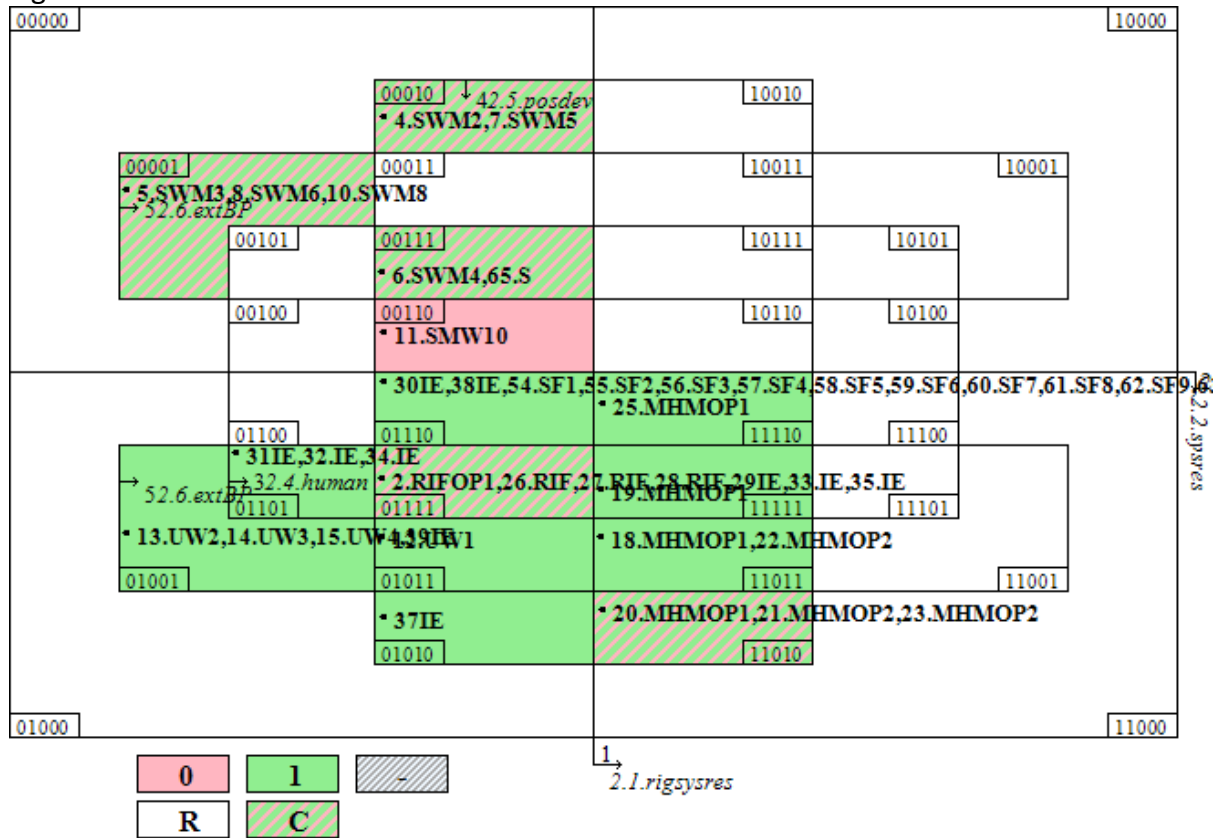
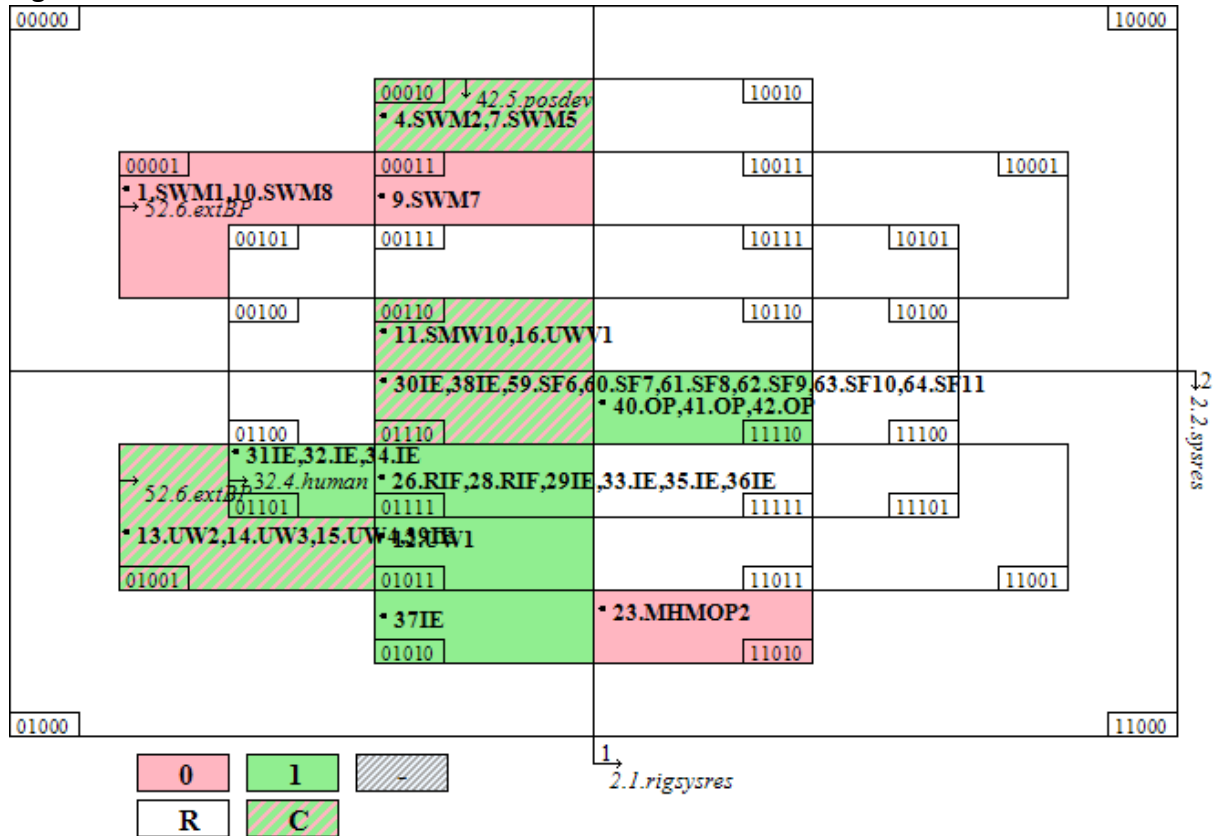

Figure 55. Outcome 3



19.0 Finally, the model coming out of the Outcome 3 analyses is 2.1.rigsysres + 2.4.human + 2.6.extbp

2.4.HUMAN is the most important conditions, covering 61% of cases with a positive Outcome 1 and 23% uniquely; 66% of cases with a positive Outcome 2A (26% uniquely with 96% consistency) and 66% of cases with a positive Outcome 2B (37% uniquely, with 89% consistency). It is also the most important condition for Outcome 3, and is consistently positively when combined with the other two conditions:

2.1.RIGSYSRES*2.4.HUMAN*2.6.extbp and 2.1.rigsysres*2.4.HUMAN*2.6.EXTBP.

19.1 **2.1 RIGRES** and **2.6.extbp** are also important for Outcome 1 and Outcome 2A; while **2.6EXTBP** is so for Outcome 2B.

Figure 56. Outcome 1



Figure 57. Outcome 2A



Figure 58. Outcome 2B

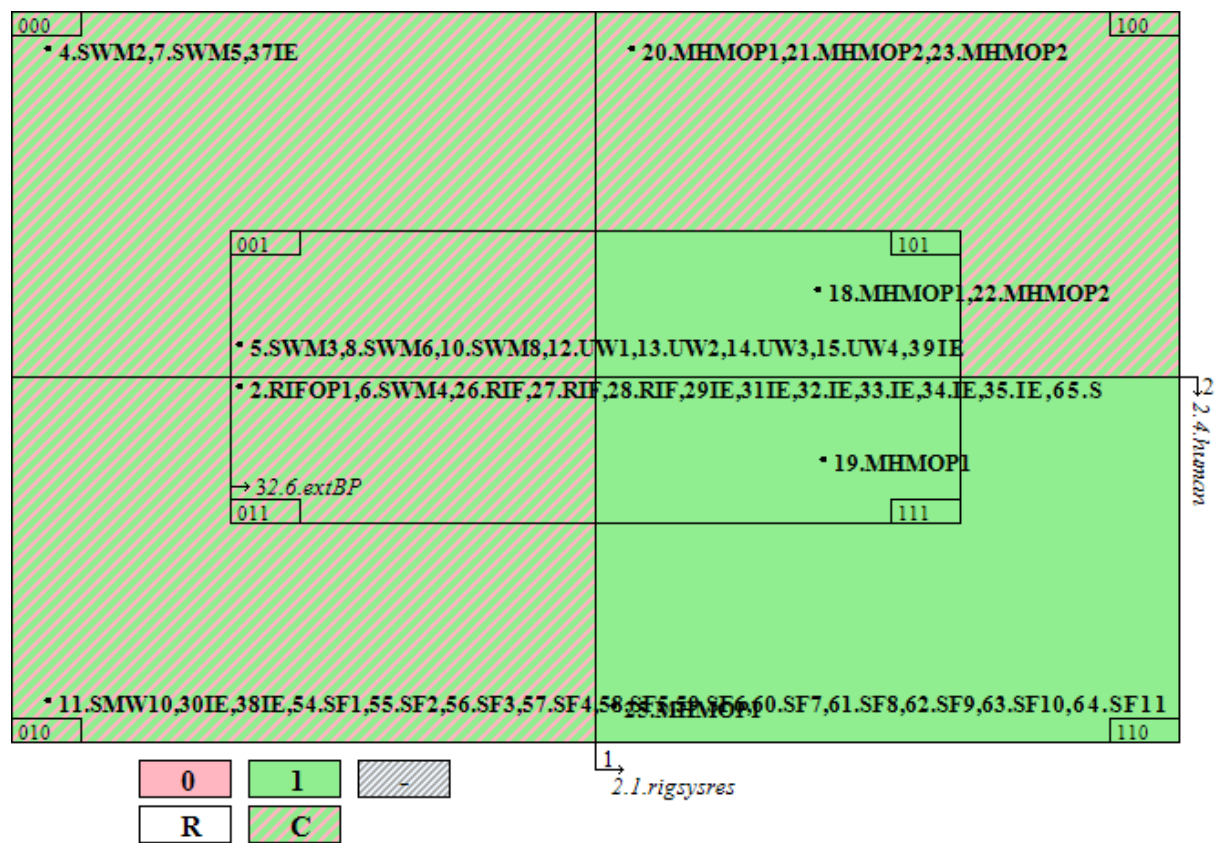
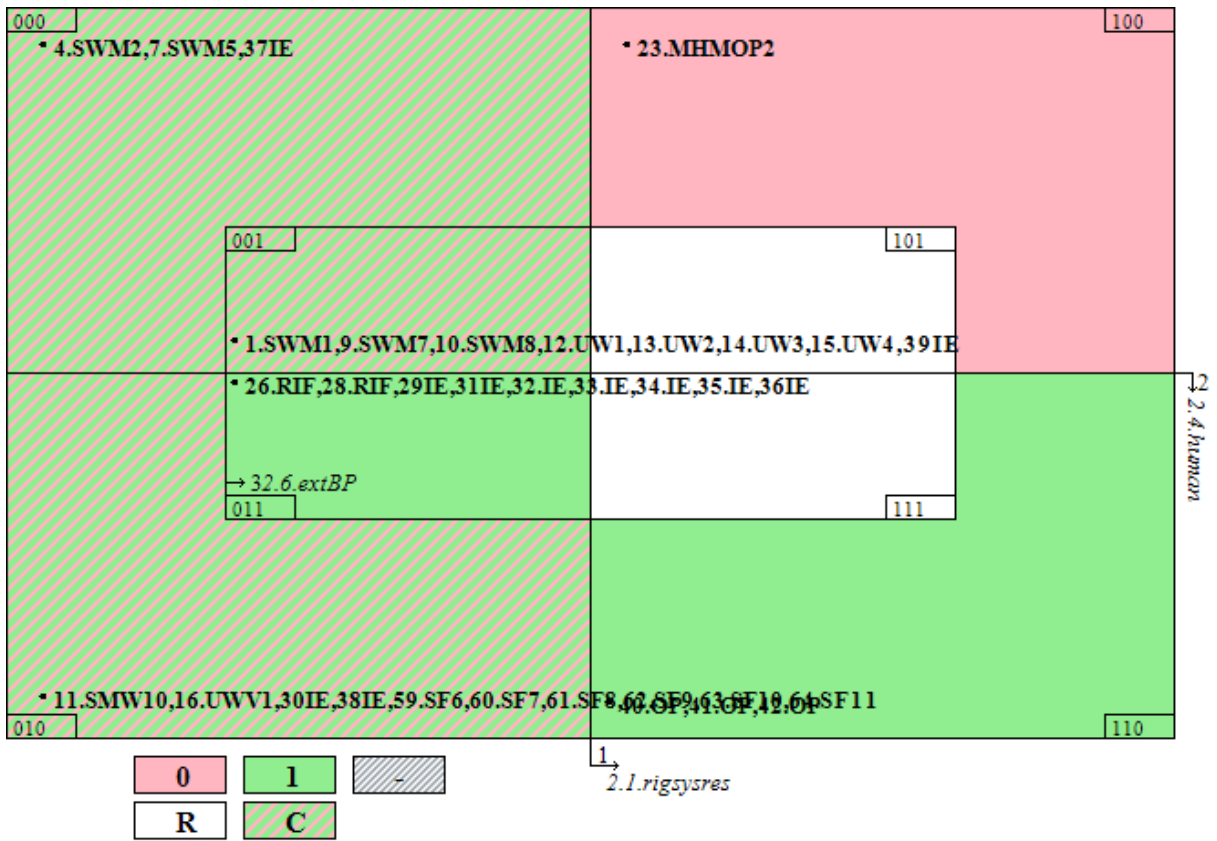

Figure 59. Outcome 3



Actors

3.1buyinhlp, 3.2buyinllp, 3.3buyinimpl, 3.4locstate, 3.5oppint =

20.0 The first two datasets are similar: the one analysed for Outcome 1 has 49 cases, of which 48 positive and one negative (10.SWM8_Wastepickers_advocacy); the one analysed for Outcome 2A has 39 cases, of which 37 positive and two negative (10.SWM8_Wastepickers_advocacy and 11.SMW10_bag_model). The Outcome 2B dataset has 44 cases, of which 37 positive and 7 negative. Finally, the Outcome 3 dataset has 34 cases, of which 23 positive and 11 negative.

20.1 No single condition is necessary for either outcome, with the exception of 3.3BUYINIMPL for Outcome 3; and the partial exception of 3.4LOCSTATE which is present in 94% of cases with a positive Outcome 2B.

20.2 The case where Outcome 1 is negative does not present any of the five conditions in the model except 3.5: therefore every time either of the first four conditions (3.1BUYINHLP, 3.2BUYINLLP, 3.3BUYINIMPL, 3.4LOCSTATE) is positive, the outcome is also positive. The cases where Outcome 2A is negative never present the first and third conditions: therefore, whenever they are present (3.1BUYINHLP OR 3.3BUYINIMPL), Outcome 2A is always positive.

20.3 The Boolean minimisations conducted on the 5-condition model presents a relatively complex solution with one central combination covering 52% of the cases with a positive Outcome 1, including uniquely; and 57% of the cases with a positive Outcome 2A, including uniquely; the same combination is also the most relevant one for Outcome 2B:
3.1BUYINHLP*3.3BUYINIMPL*3.4LOCSTATE*3.5OPPINT

20.4 It thus seems appropriate to test the corresponding reduced 4-condition model. The most important combination is then the following:
3.1BUYINHLP*3.3BUYINIMPL*3.4LOCSTATE which covers 64% of cases with a positive Outcome 1 (52% uniquely); 70% of cases with a positive Outcome 2A (57% uniquely); and 87% of cases with a positive Outcome 3 (all uniquely, although with 80% consistency). This is the 111- rectangle in the Venn diagram: right, bottom, and inside the horizontal central rectangle. If we add 3.5OPPINT, the resulting combination covers 57% of the cases with a positive Outcome 2B (with 95% consistency):

3.1BUYINHLP*3.3BUYINIMPL*3.4LOCSTATE*3.5OPPINT

3.4LOCSTATE*3.5oppint is also important, covering 42% of cases with a positive Outcome 1 (19% uniquely) and 38% of cases with a positive Outcome 2A (14% uniquely). This is - -10: the area outside of the vertical central rectangle and simultaneously inside the horizontal central rectangle. If we add 3.1.HLBUYIN*3.3.implbuyin the combination is also relevant for Outcome 2B.

Finally, **3.1buyinhlp*3.3BUYINIMPL*3.5oppint** covers between 16% and 17% of cases for the first three outcomes. This is the area on the left, bottom, and outside the vertical central rectangle (01-0). If we add 3.4locstate it is also relevant for Outcome 3.

20.5 The first two Venn diagrams are virtually identical. Notice that there are no contradictory / inconsistent combinations, and the negative pathways are: 00-1 or 3.1buyinhlp*3.3buyinimpl*3.5OPPINT for Outcome 2A and 0001 or 3.1buyinhlp*3.3buyinimpl*3.4locstate*3.5OPPINT for Outcome 1.

Figure 60. Outcome 1

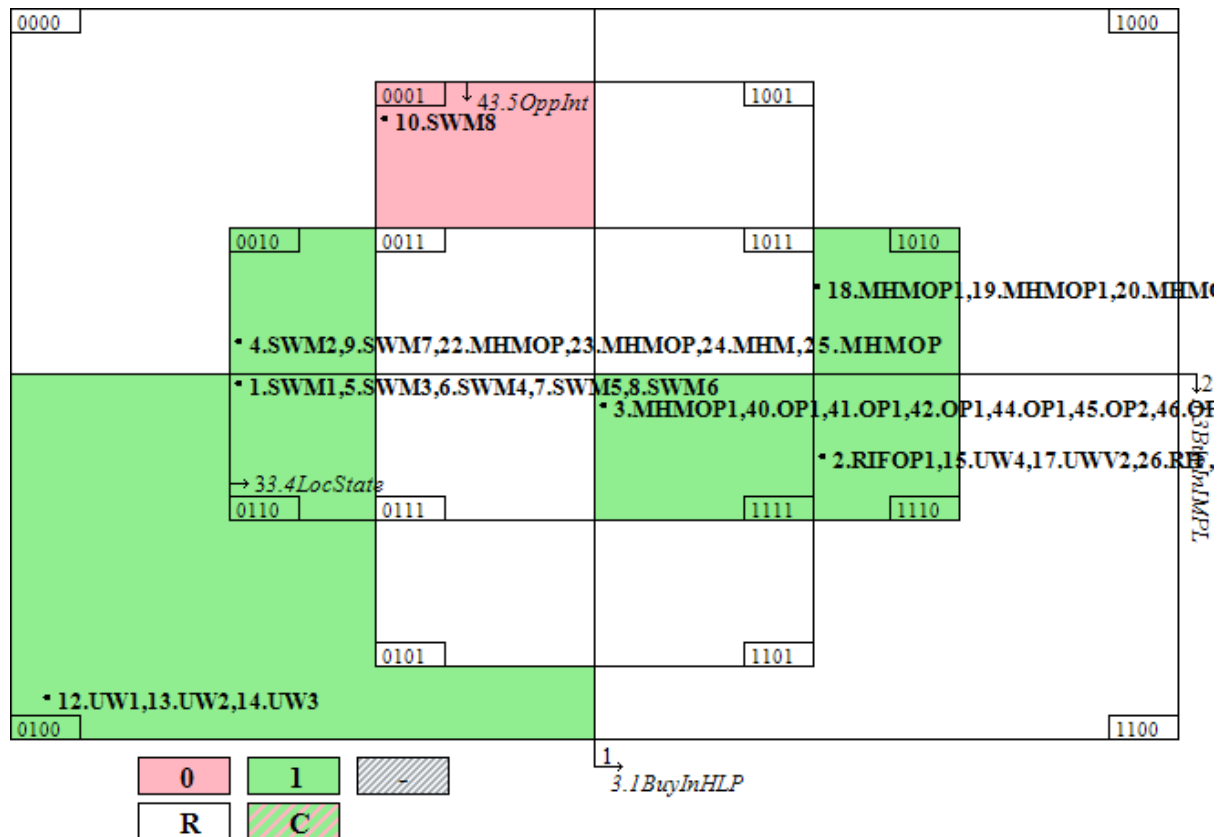

20.6 In the diagram for Outcome 2B three areas become inconsistent (0010 and 111-). The former become consistently negative for Outcome 3. The only combination that is consistently positive across all the four outcomes is 0100.

20.7 For Outcome 3, the combinations 00-1 and 001- are consistently negative. Actually, in the whole top-left quadrant 3.1buyinhlp*3.3buyinimpl there are no positive cases at all. It's also noteworthy that the bottom-left area outside of the vertical rectangle (01-0) is almost constantly positive except for one case in Outcome 3.

Figure 61. 012A

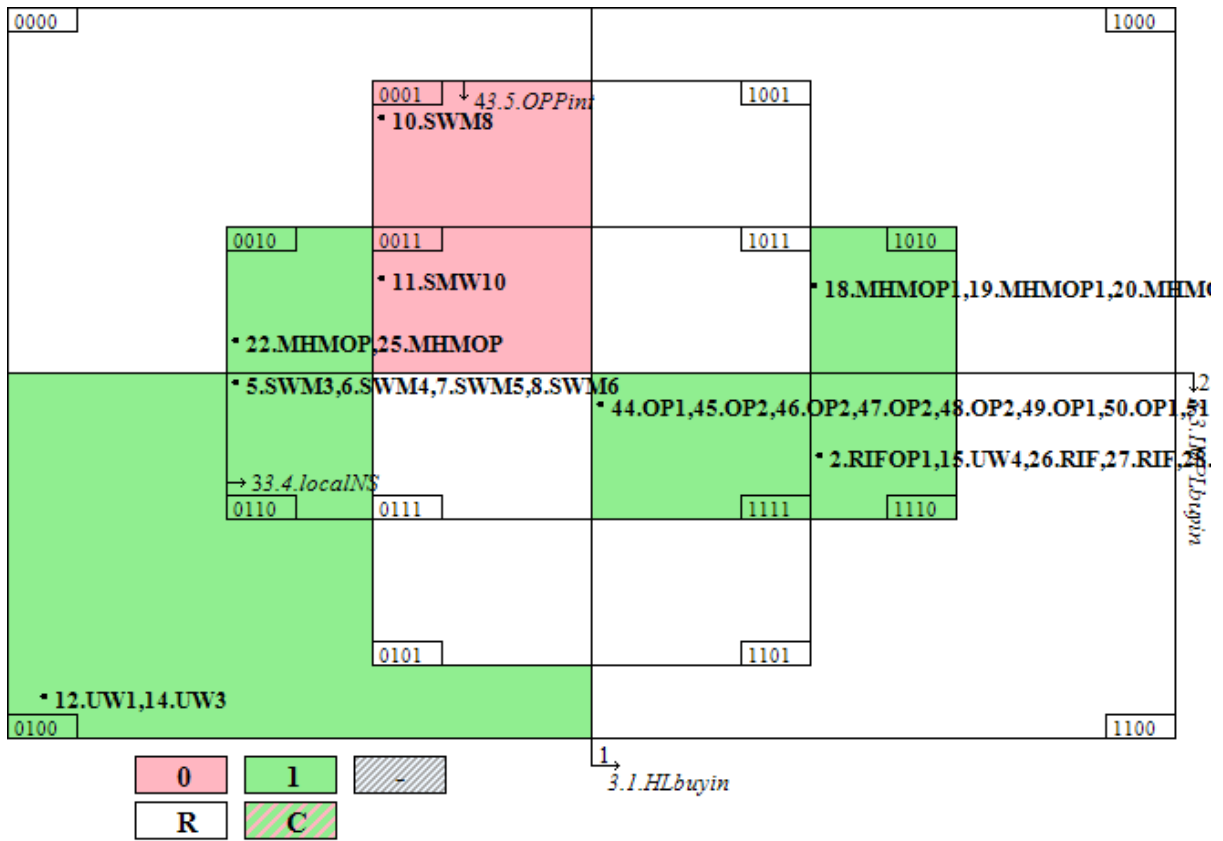

Figure 62. Outcome 2B

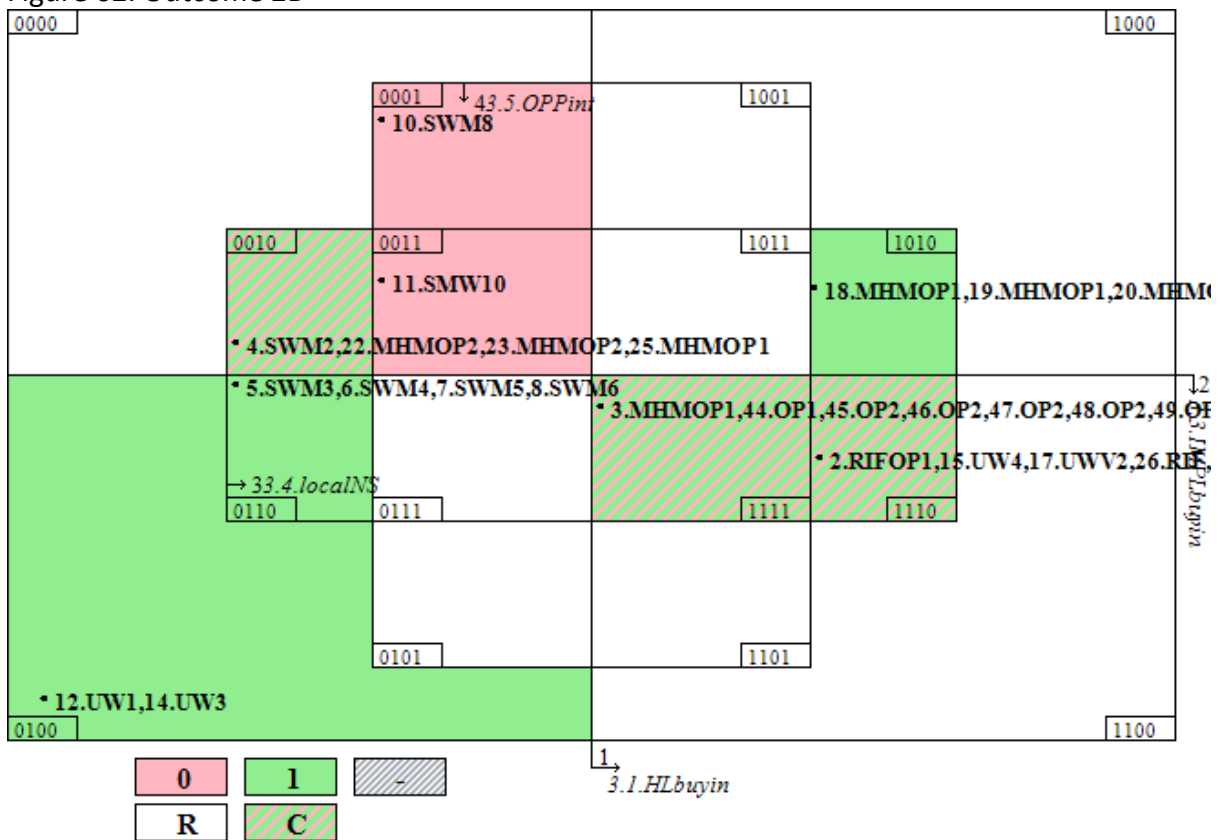
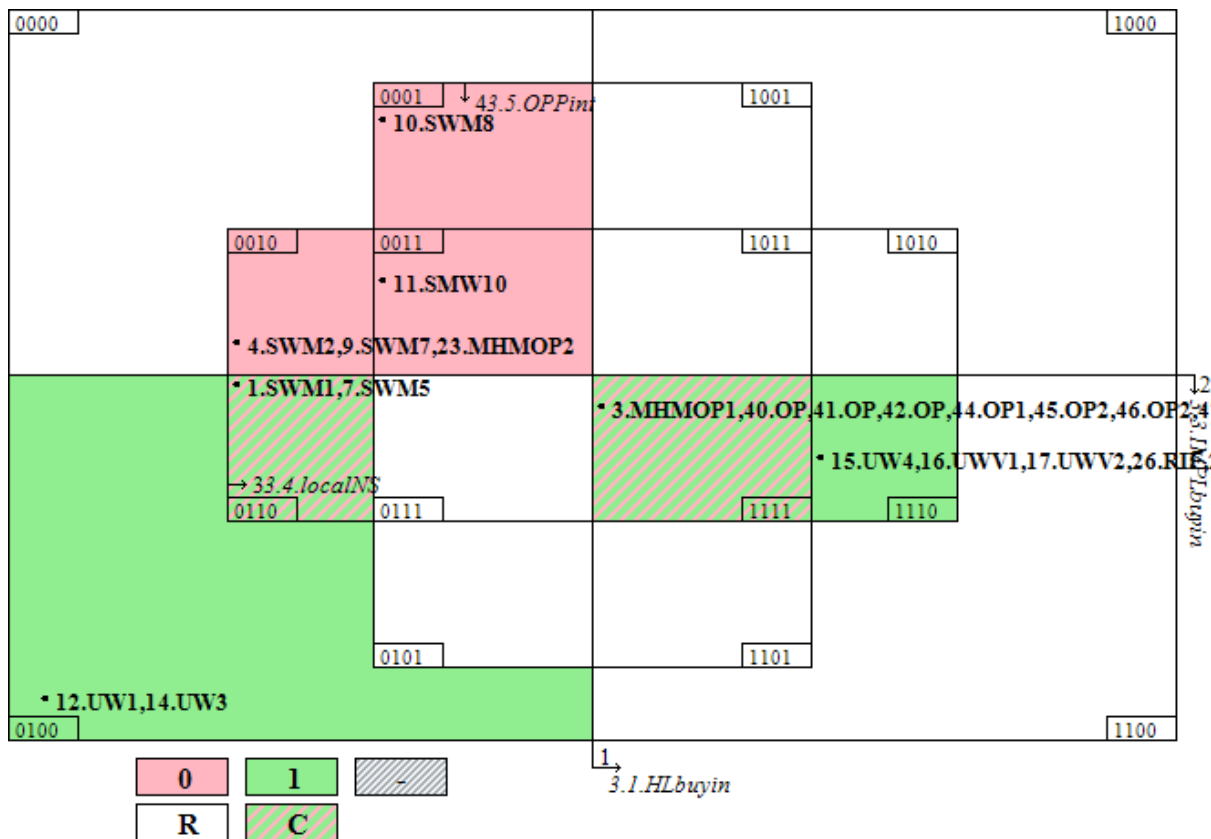

Figure 63. Outcome 3



20.8 We can play around with two 3-condition models that preserve perfect coverage and consistency (with two virtually identical Venn diagrams).

The first is the model 3.1buyinhlp, 3.3buyinimpl, 3.5oppint.

The most important combination in this model is:

3.1BUYINHLP*3.3BUYINIMPL, which covers 65% of cases with a positive Outcome 1 (52% uniquely), 70% of cases with a positive Outcome 2A and Outcome 2B (57% uniquely, with 90% consistency for Outcome 2B); and 87% of cases with a positive Outcome 3 (65% uniquely). In the Venn diagram this is the bottom-right quadrant (11-).

20.9 The other combination is

3.5oppint, which covers 48% of cases with a positive Outcome 1 (35% uniquely) and 43% of cases with a positive Outcome 2A (30% uniquely). In the Venn diagram, this is the area outside (and around) the central rectangle.

20.10 Adding 3.3IMPLBUYIN, the combination **3.3IMPLBUYIN*3.5oppint** is relevant for Outcome 2B and Outcome 3 but consistency is not very high (85%-89%).

20.11 The first two Venn diagrams are virtually identical.

Notice how the top-left quadrant **3.1buyinhlp*3.3buyinimpl** is consistently pink / negative for Outcome 3.

No area stays consistently positive across the four outcomes but combination 001

3.1buyinhlp*3.3buyinimpl*3.5OPPINT stays consistently negative.

Figure 64. Outcome 1

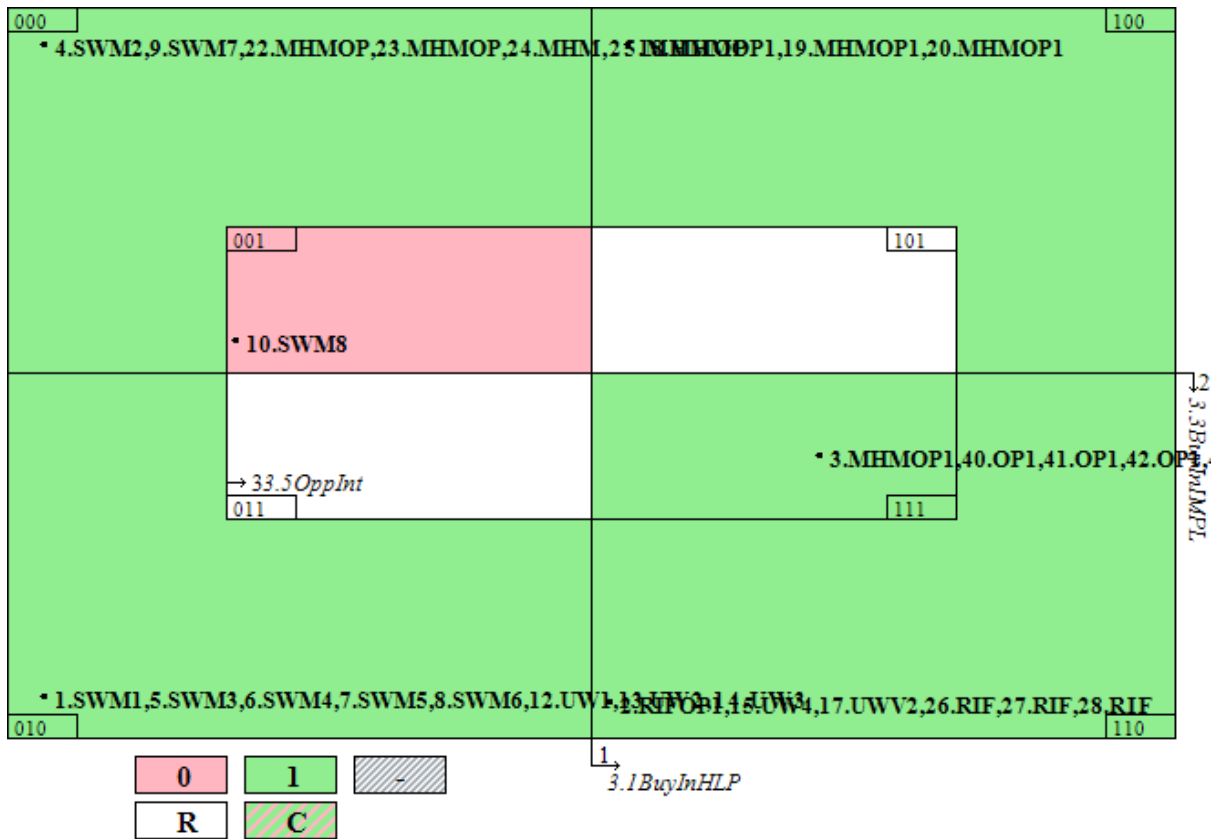

Figure 65. Outcome 2A

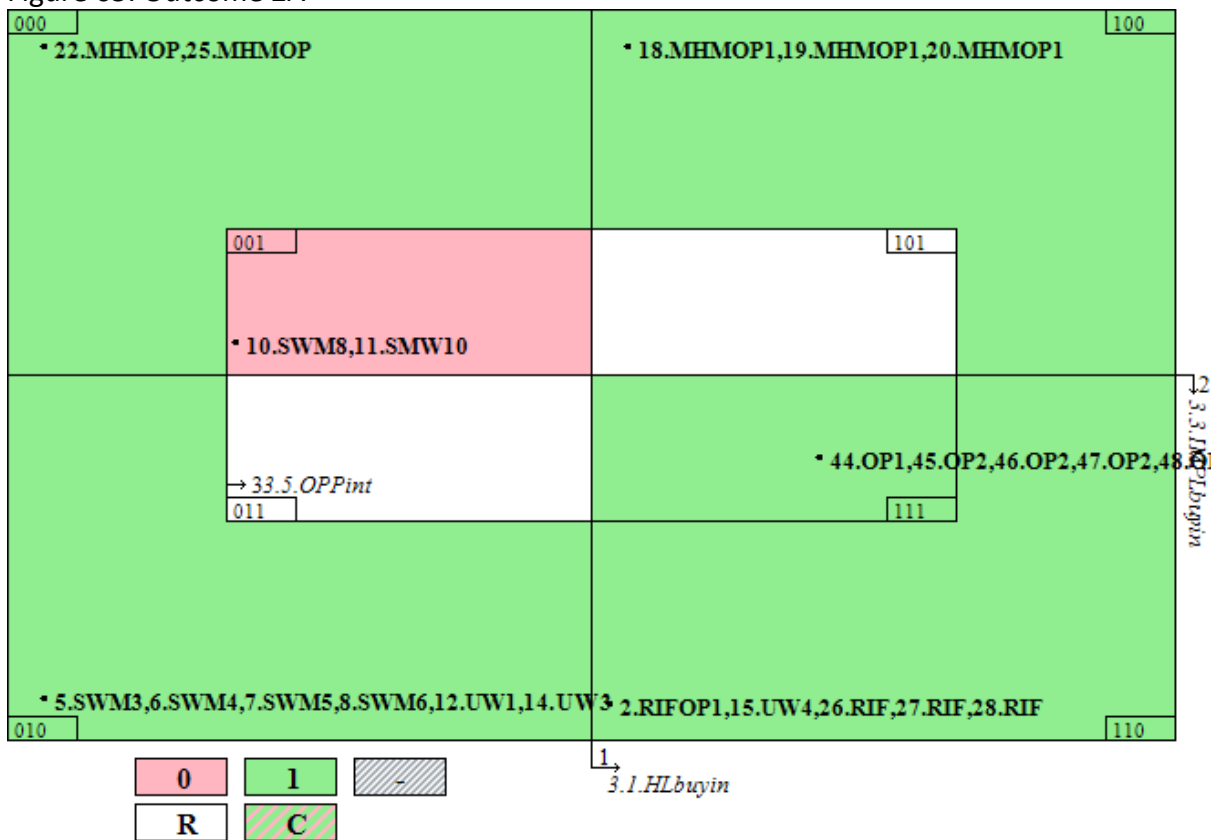

Figure 66. Outcome 2B

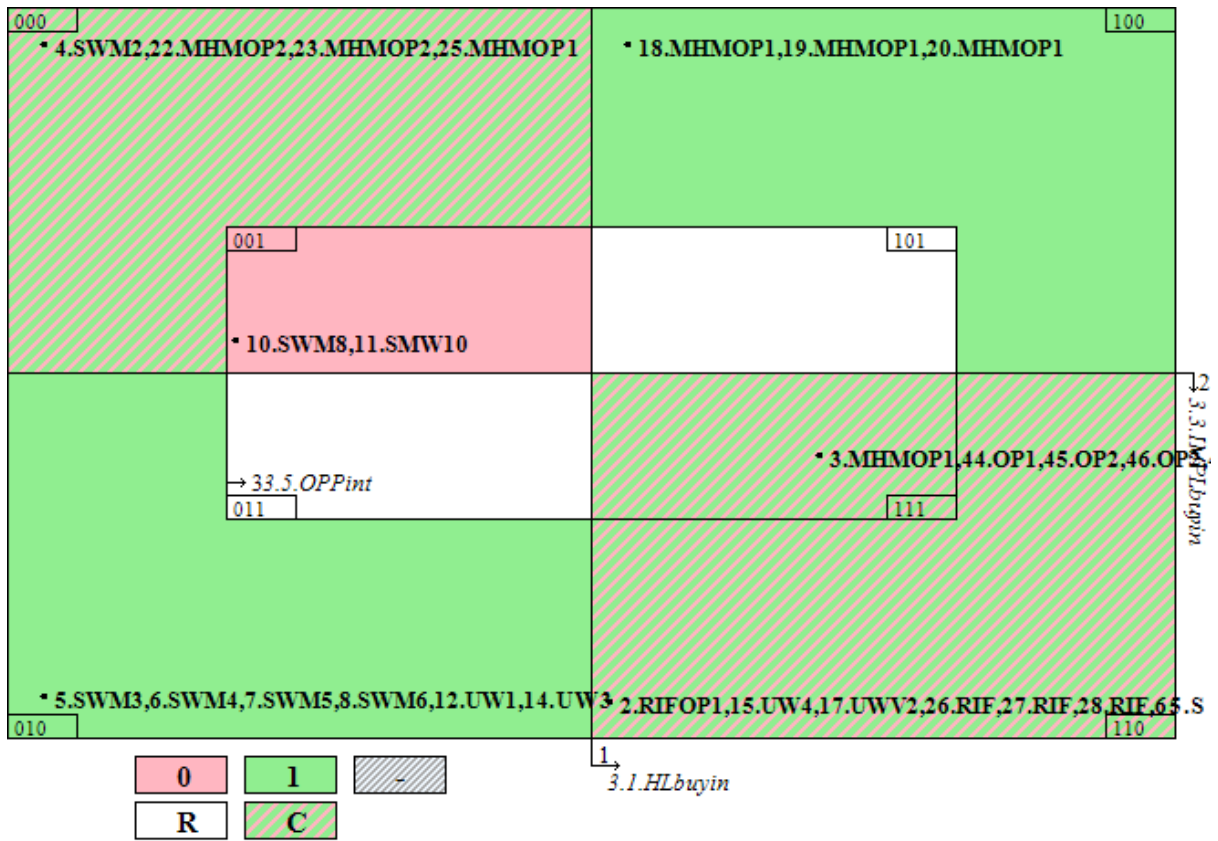
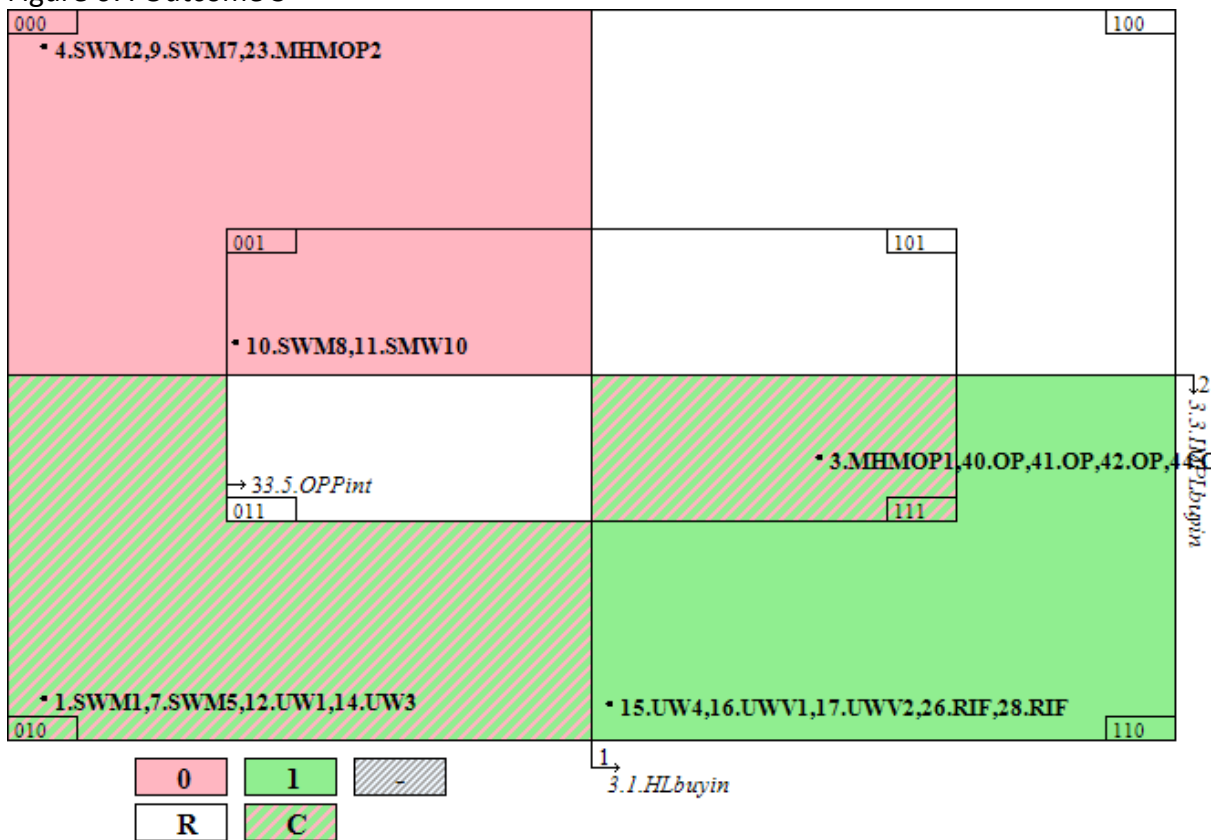

Figure 67. Outcome 3



21.0 The second is the model 3.3buyinimpl, 3.4locstate, 3.5oppint.

The most important combination here is

3.3BUYINIMPL*3.4LOCSTATE, which covers 75% of cases with a positive Outcome 1 (52% uniquely) and 81% of cases with a positive Outcome 2A and Outcome 2B (57% uniquely – with 91% consistency for Outcome 2B). For Outcome 3, the consistency of this combination is 78% and its coverage 91% (65% unique). In the Venn diagram, this is the bottom-right quadrant (11-).

21.1 Then we have **3.4LOCSTATE*3.5oppint** which covers 42% of cases with a positive Outcome 1 (19% uniquely) and 38% of cases with a positive Outcome 2A and Outcome 2B (14% uniquely, although consistency is only 78% for Outcome 2B). For Outcome 3, this combination is 89% consistent and covers 35% of positive cases (9% uniquely). In the Venn diagram, this is the bottom area outside the central rectangle (-10).

21.2 Finally, **3.3BUYINIMPL*3.5oppint** covers 29% of cases with a positive Outcome 1 (6% uniquely) and 30% of cases with a positive Outcome 2A and Outcome 2B (5% uniquely, with 85% consistency for Outcome 2B). In the Venn diagram, this is the area on the right outside of the central rectangle (1-0).

21.3 Notice that, while the green areas are the same in the first two Venn diagrams, the one case where Outcome 1 is negative is described as 001 3.3buyinimpl*3.4locstate*3.5OPPINT, while the pink area for Outcome 2A and Outcome 2B is larger and is described as 0-1 3.3buyinimpl*3.5OPPINT.

21.4 As we move through the outcomes, the bottom area becomes inconsistent as more negative cases are added, until the whole bottom-left quadrant becomes consistently negative for Outcome 3. The only combination remaining constantly positive is 100: 3.3BUYINIMPL*3.4locstate*3.5oppint

Figure 68. Outcome 1

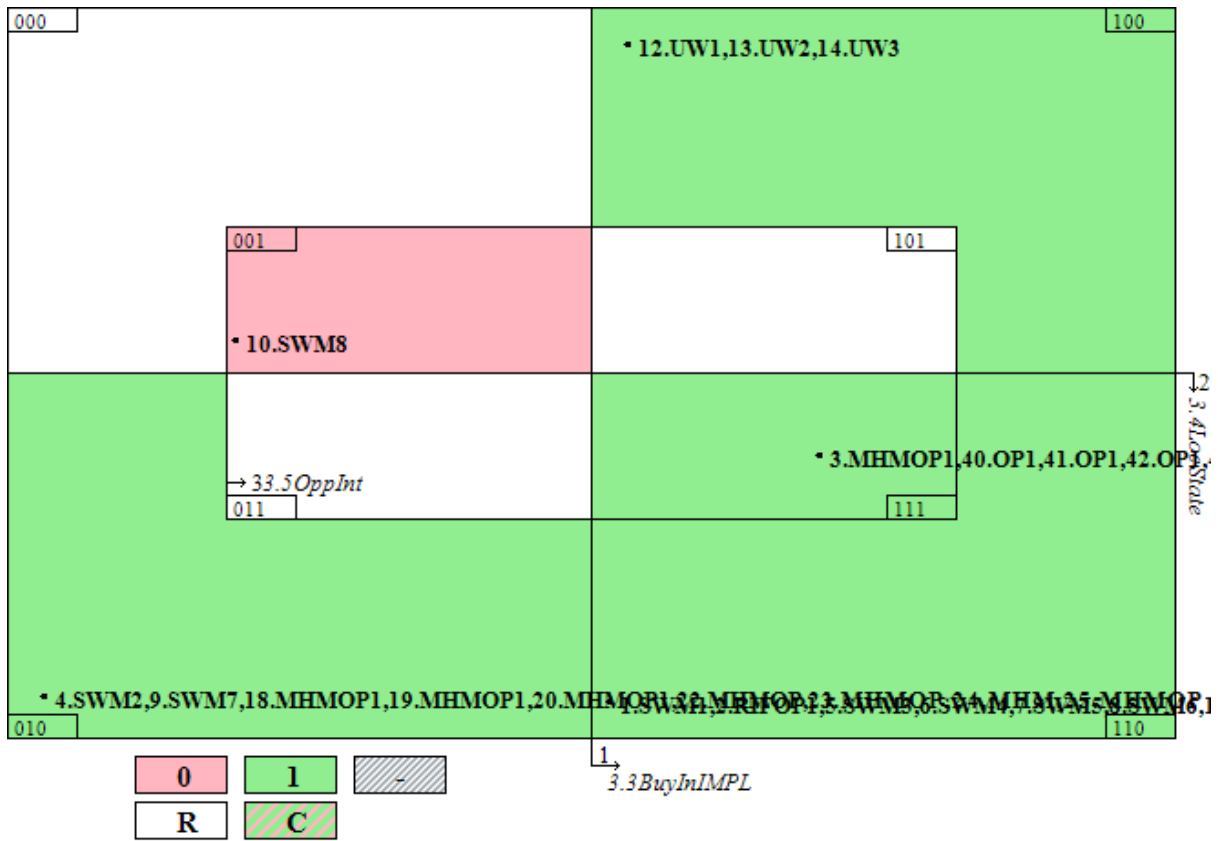

Figure 69. Outcome 2A

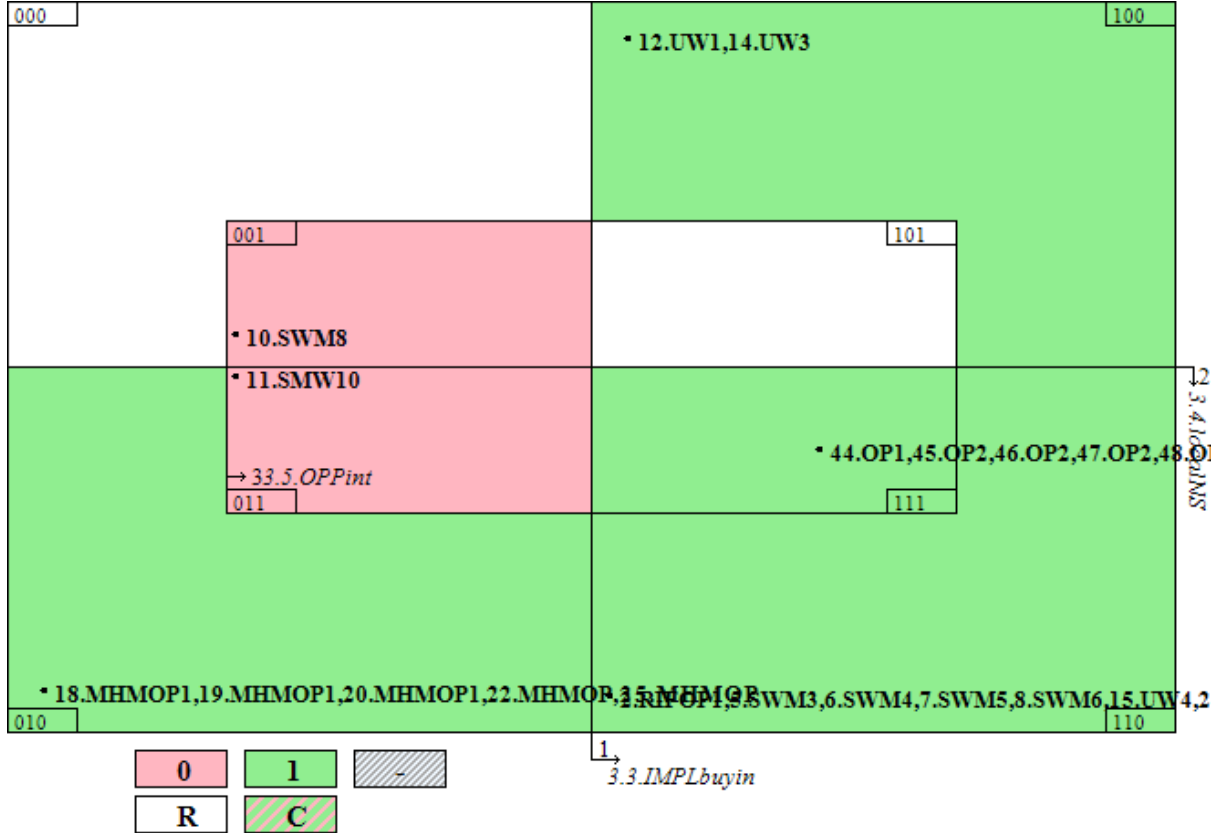

Figure 70. Outcome 2B

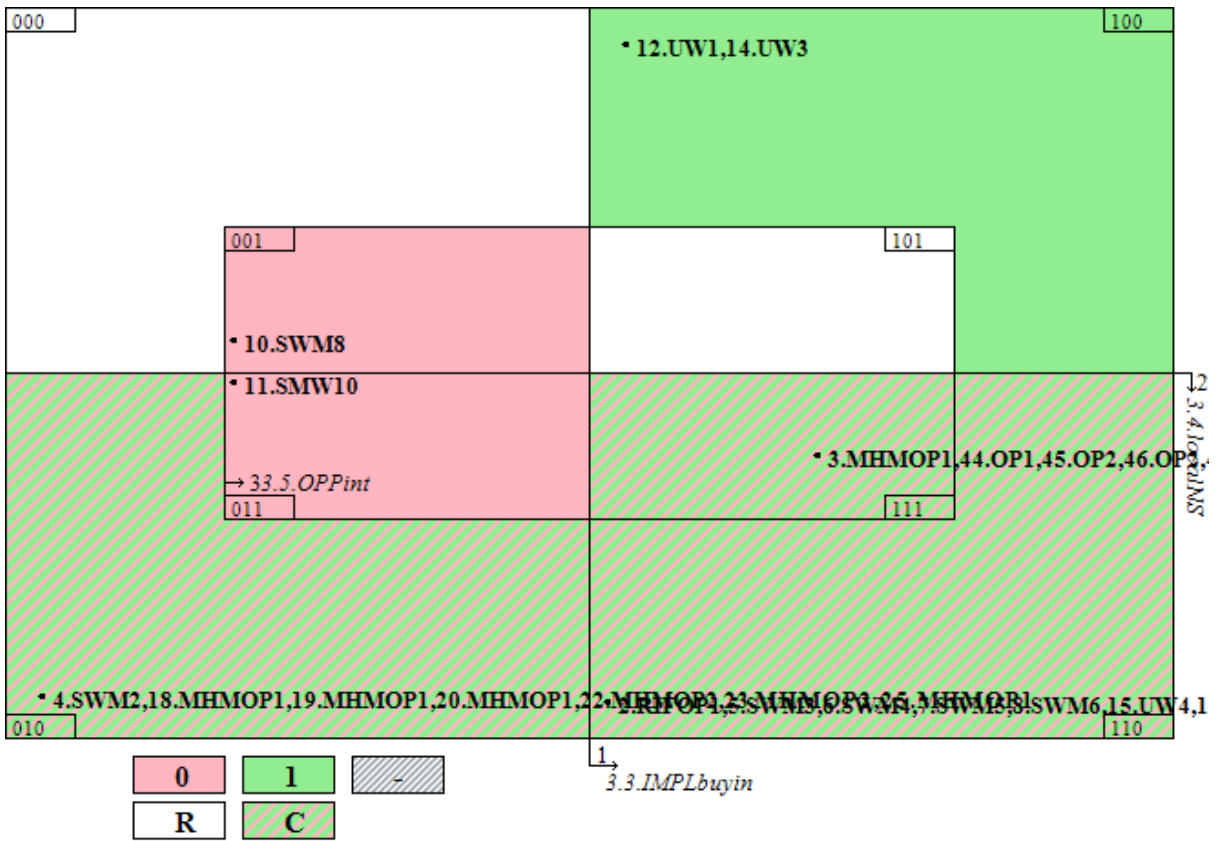
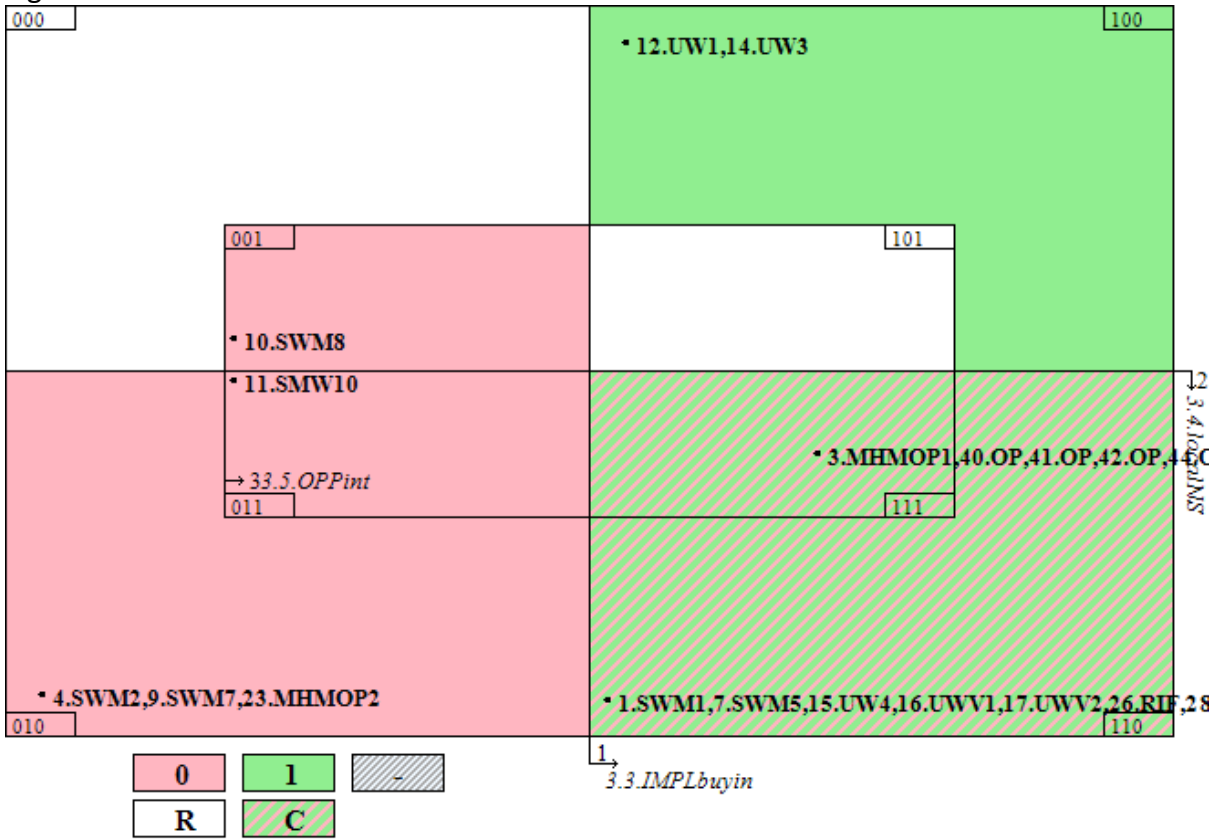

Figure 71. Outcome 3



22.0 An additional model that seemed promising is 3.1buyinhlp + 3.2buyinllp + 3.3buyinimpl + 3.4locstate

As above, the most important combination is still **3.3BUYINIMPL*3.4LOCSTATE** which covers 75% of cases with a positive Outcome 1 (44% uniquely) and 81% of cases with a positive Outcome 2A or Outcome 2B (46% uniquely). If we add 3.2, the combination **3.2BUYINLLP*3.3BUYINIMPL*3.4LOCSTATE** covers 83% of cases with a positive Outcome 3, all uniquely (and – uncharacteristically – consistency is preserved across all the outcomes). The second most important combination is **3.2buyinllp*3.4LOCSTATE** which covers 50% of cases with a positive Outcome 1 (19% uniquely) and 49% of cases with a positive Outcome 2A (14% uniquely). If we add 3.1BUYINHLP, the combination **3.1BUYINHLP*3.2buyinllp*3.4LOCSTATE** covers 38% of cases with a positive Outcome 2B (8% uniquely, with 87.5% consistency).

22.1 The least important combination is **3.1buyinhlp*3.2buyinllp*3.3BUYINIMPL** covers 12.5% of cases with a positive Outcome 1 (6% uniquely), and 11% of cases with a positive Outcome 2A or Outcome 2B (5% uniquely). If we add 3.4locstate, the combination **3.1buyinhlp*3.2buyinllp*3.3BUYINIMPL*3.4locstate** covers 9% of cases with a positive Outcome 3, all uniquely.

22.2 The first two Venn diagrams are identical, except for one more negative combination in Outcome 2A. For Outcome 2B, three formerly positive areas become inconsistent. The only two consistently positive combinations across all four outcomes are 0010 and 0111. For Outcome 3, we have several combinations consistently leading to negative outcomes:

- 3.1buyinhlp*3.2buyinllp*3.3buyinimpl
- 3.1buyinhlp*3.2buyinllp*3.4LOCSTATE
- 3.1buyinhlp*3.3buyinimpl*3.4LOCSTATE

Figure 72. Outcome 1

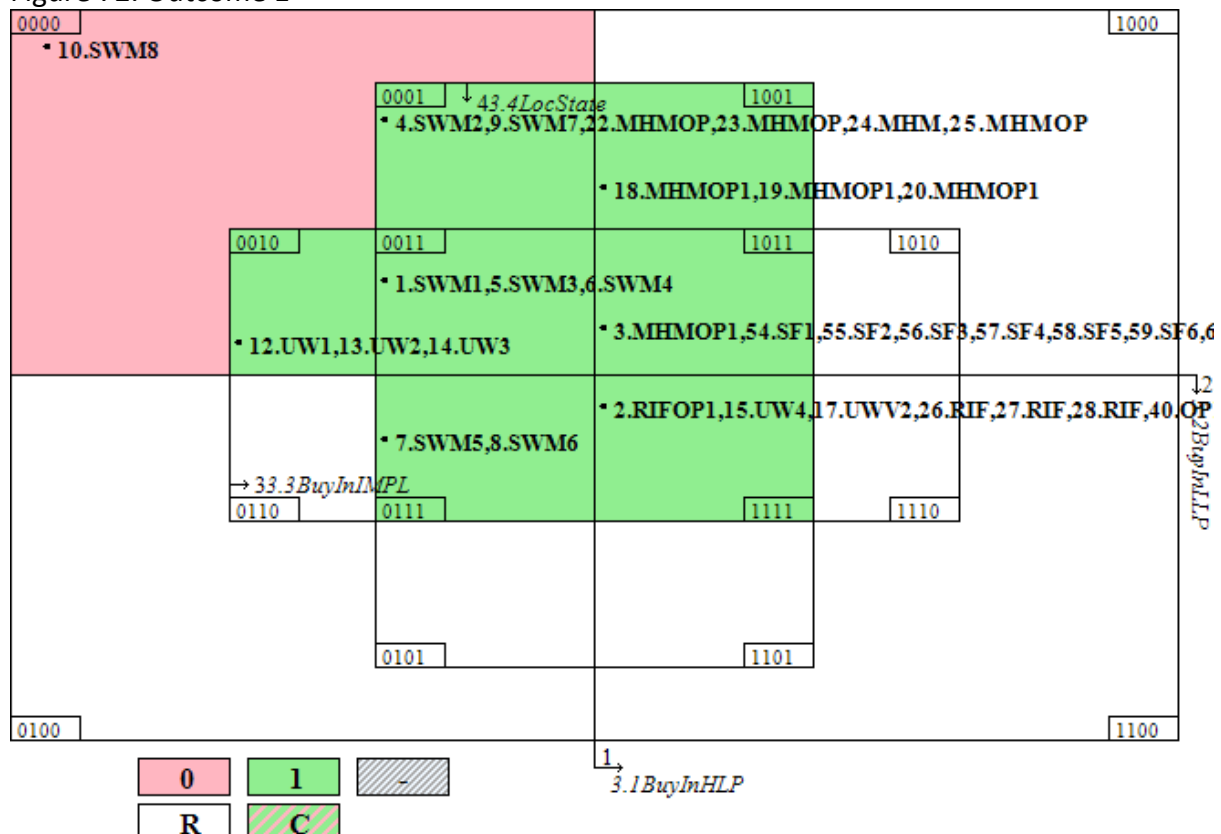

Figure 73. Outcome 2A

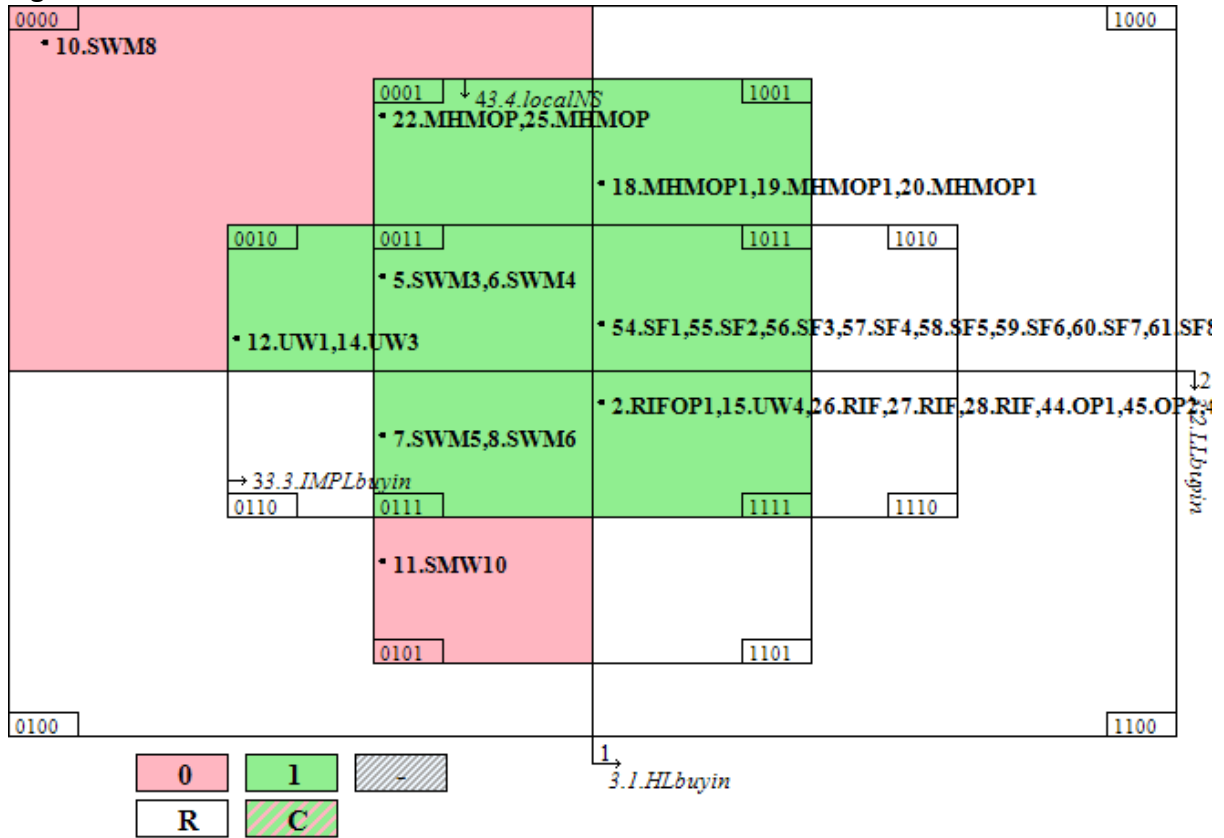

Figure 74. Outcome 2B

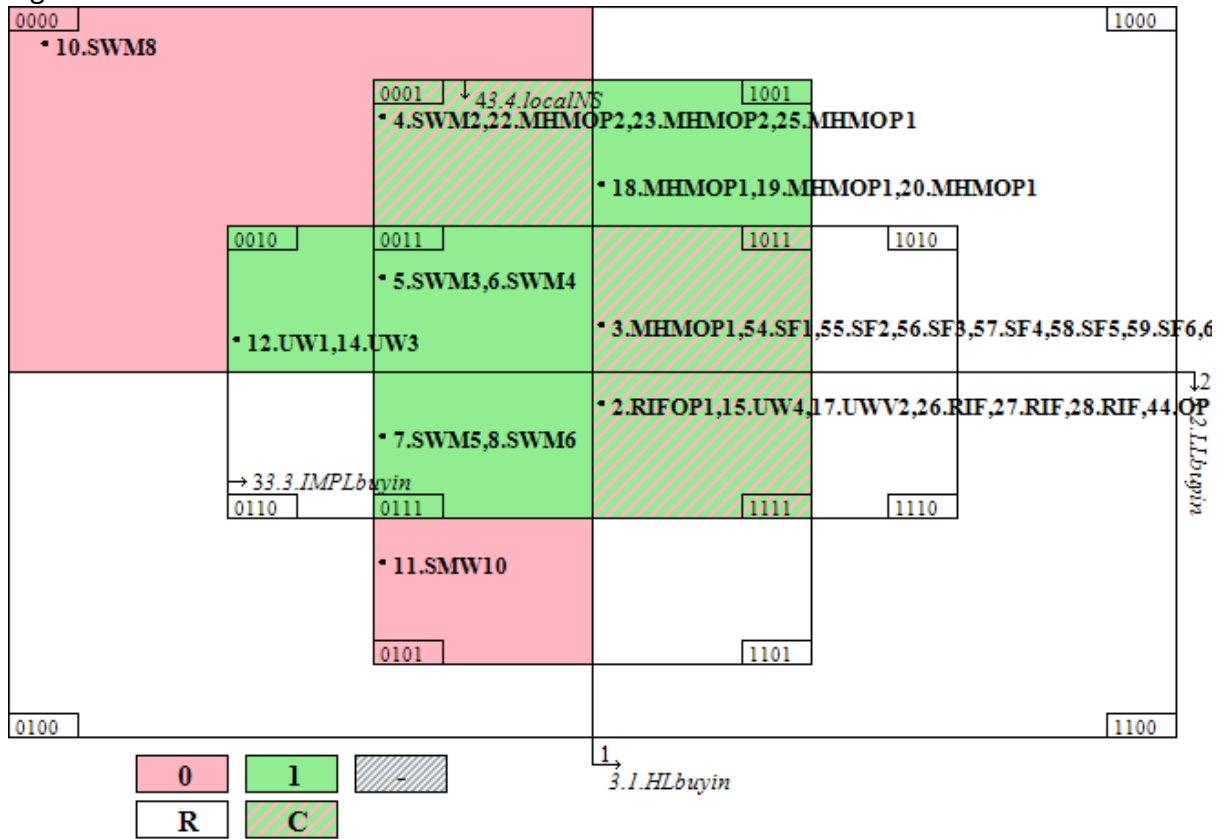
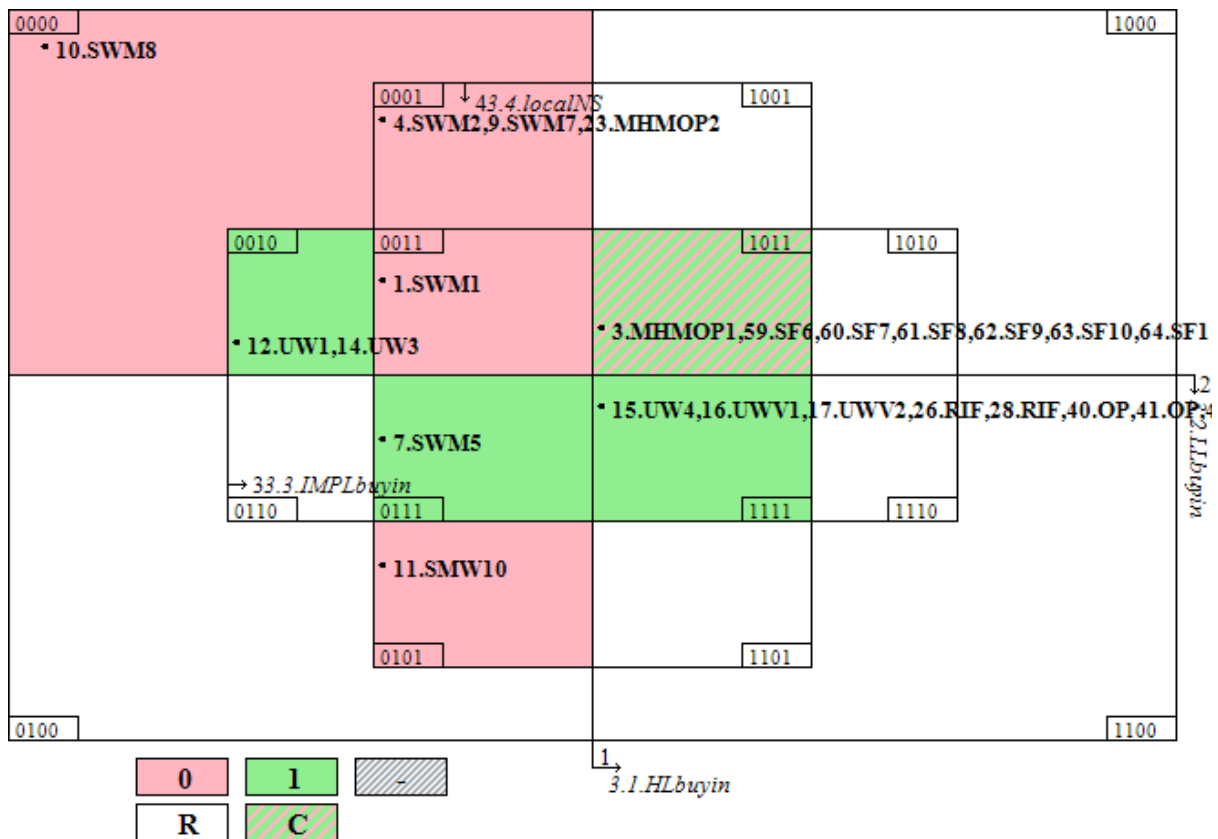

Figure 75. Outcome 3



23.0 Since 3.1 seems to be the least important condition in the above model, we can remove it and test the three-condition model 3.2buyinllp + 3.3buyinimpl + 3.4locstate and see if consistency and coverage are preserved.

23.1 The most important combination is **3.3BUYINIMPL*3.4LOCSTATE** and covers 75% of cases where Outcome 1 is positive (44% uniquely) and 81% of cases where Outcome 2A or Outcome 2B are positive (46% uniquely – with 91% consistency for Outcome 2B). If we add 3.2, the combination **3.2BUYINLLP*3.3BUYINIMPL*3.4LOCSTATE** covers 83% of cases with a positive Outcome 3, all uniquely (and consistency is preserved with Outcome 3).

23.2 The second most important combination is **3.2buyinllp*3.4LOCSTATE** which covers 50% of cases with a positive Outcome 1 (19% uniquely) and 49% of cases with a positive Outcome 2A or Outcome 2B (14% uniquely, with Outcome 2B having 82% consistency).

23.3 The least important combination is **3.2buyinllp*3.3BUYINIMPL** covers 37.5% of cases with a positive Outcome 1 (6% uniquely), and 41% of cases with a positive Outcome 2A or Outcome 2B (5% uniquely, with 88% consistency for Outcome 2B). If we add 3.4locstate, the combination **3.2buyinllp*3.3BUYINIMPL*3.4locstate** covers 9% of cases with a positive Outcome 3, all uniquely.

The first two venn diagrams are identical except for one more negative combination in Outcome 2A. The combinations presenting 3.4 become inconsistent going from Outcome 2A to Outcome 2B. And those which also present absence of 3.3 become consistently negative in Outcome 3. There are two combinations which remain consistently positive across the four outcomes: **3.2buyinllp*3.3BUYINIMPL*3.4locstate** (010) and

3.2BUYINLLP*3.3BUYINIMPL*3.4LOCSTATE (111). Notice that these are all in the bottom area where 3.3BUYINIMPL is positive.

23.4 Indeed, the absence of this condition (3.3buyinimpl) becomes sufficient for a negative Outcome 3 (so its presence is necessary for a positive Outcome 3, as we noted at the very beginning).

Figure 76. Outcome 1

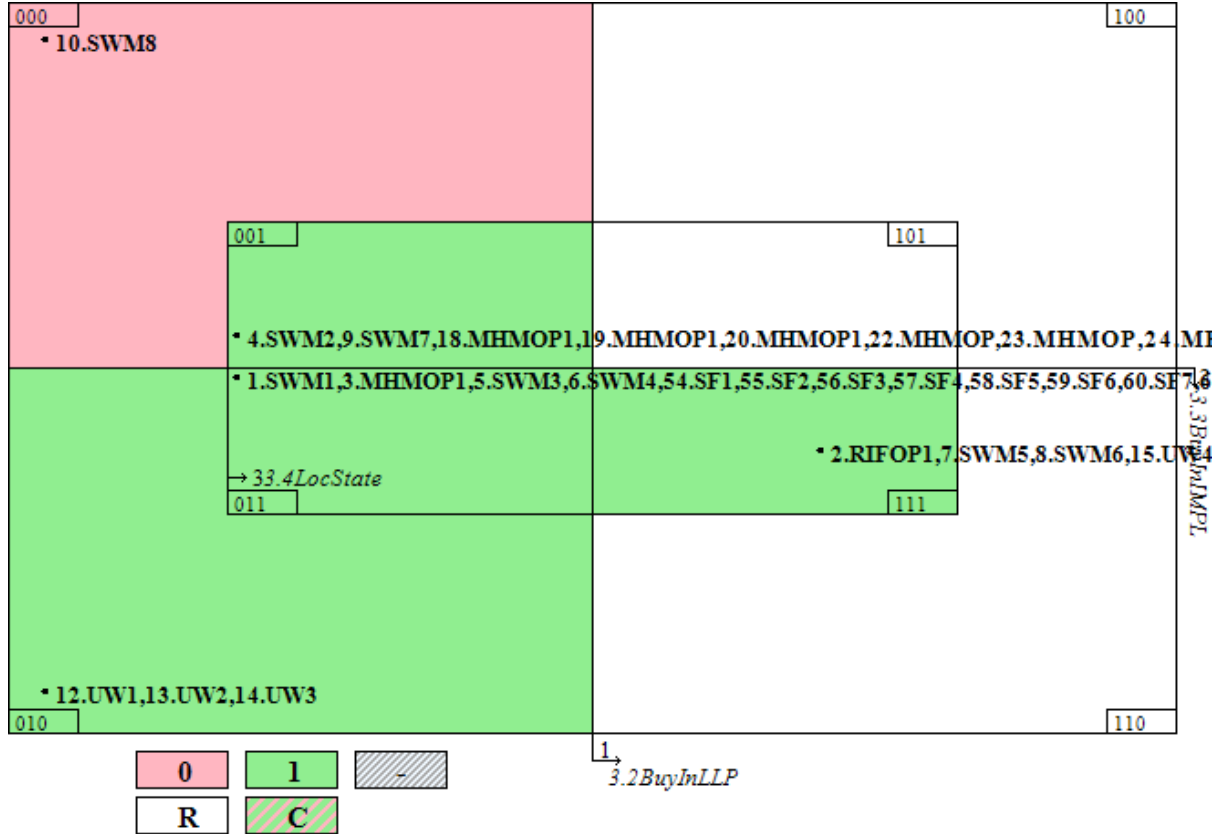

Figure 77. Outcome 2A

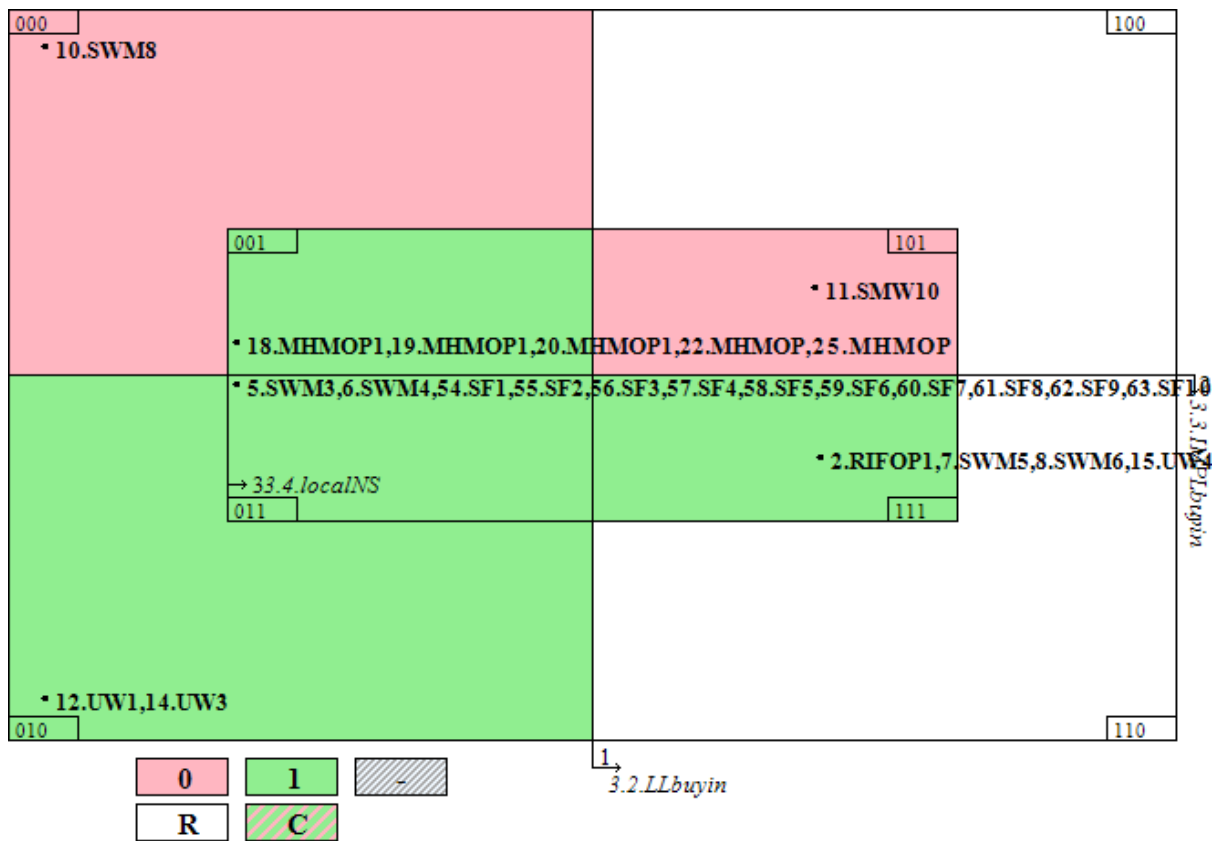

Figure 78. Outcome 2B

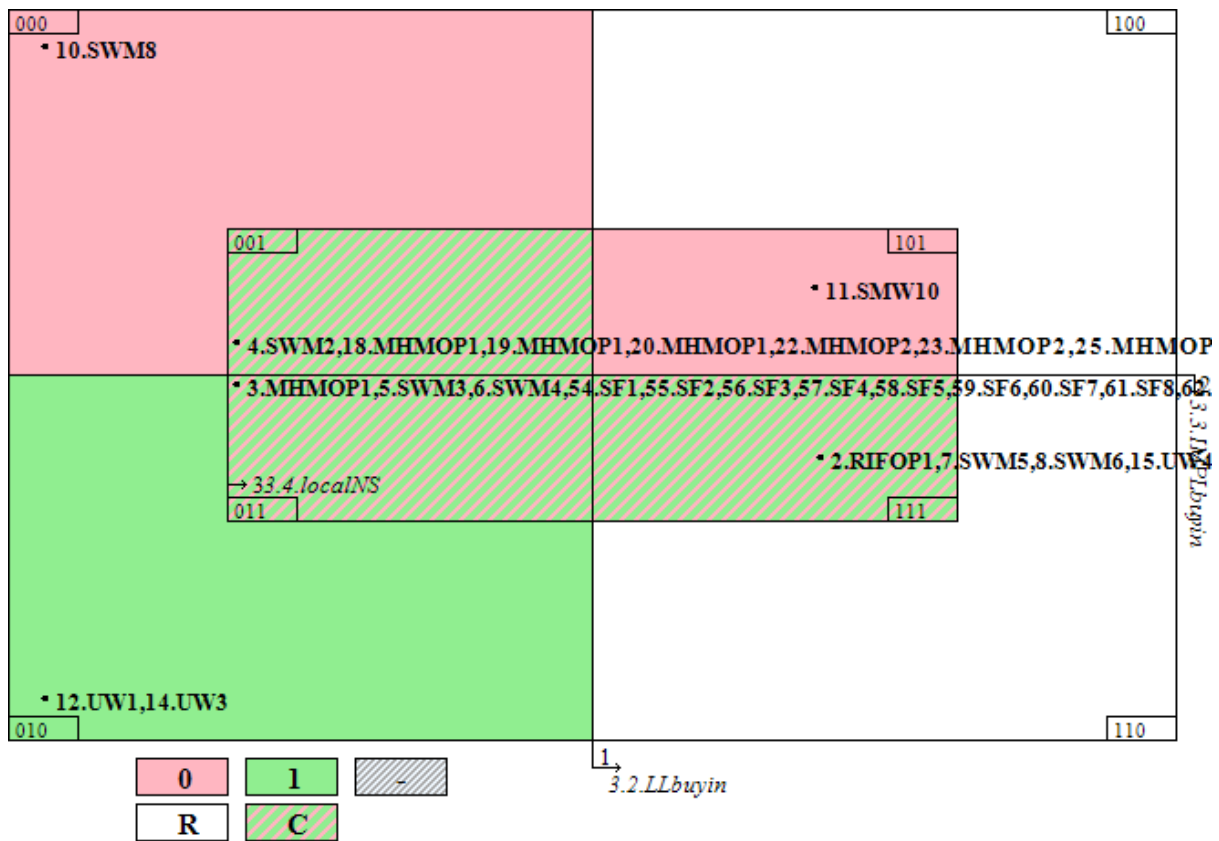

Figure 79. Outcome 3



4.1locnet + 4.2restanz + 4.3natorg + 4.4known + 4.5connnet + 4.6idopp + 4.7trackrec =

24.0 The first two datasets are similar: the one analysed for Outcome 1 has 37 cases, of which 36 positive and one negative (10.SWM8_Wastepickers_advocacy); the one analysed for Outcome 2A has 32 cases, of which 30 positive and two negative (10.SWM8_Wastepickers_advocacy and 11.SMW10_bag_model). The Outcome 2B dataset has 37 cases, 30 positive and 7 negative; while the Outcome 3 dataset has 31 cases, 19 positive and 12 negative.

24.1 The condition **4.6idopp** is **always absent** across all cases and all outcomes, while the two conditions **4.2RESTANZ** and **4.7TRACKREC** are **always present** across all cases and outcomes. In addition to these two, the only case with a negative Outcome 1 presents 4.5 connnet, and doesn't present any other conditions. Therefore, conditions 4.1LOCNET, 4.3NATORG, and 4.4KNOWN are "sufficient" for a positive Outcome 1 outcome (whenever they are present, Outcome 1 is positive). By contrast, only 4.3NATORG is sufficient for Outcome 2A because the cases presenting a negative value of Outcome 2A also present at least one of the other conditions except 4.3 (and also except 4.6 which is always negative). No single condition is sufficient for either a positive Outcome 2B or a positive Outcome 3.

24.2 The Boolean minimisations has been applied to the 4-condition model obtained after removing the conditions above which are either always present or always absent: 4.1locnet + 4.3natorg + 4.4known + 4.5connnet.

24.3 The most important combination is:

4.1LOCNET*4.3NATORG*4.4KNOWN, which covers 61% of cases where Outcome 1 is positive, all uniquely; and 70% of cases where Outcome 2A or Outcome 2B is positive, all uniquely (consistency is 91% for Outcome 2B). In the Venn diagrams, this is 111-, the green rectangle on the right and inside both central rectangles. If we add the absence of 4.5, **4.1LOCNET*4.3NATORG*4.4KNOWN*4.5connnet** covers 5% of cases with a positive Outcome 3, all uniquely.

24.4 The second most important combination is **4.1locnet*4.4known*4.5connnet** (the green area on the left, outside both central rectangles: 0-00), which covers 17% of cases where Outcome 1 or Outcome 2A are positive. To cover cases presenting a positive Outcome 2B, the absence of 4.3 needs to be added:

4.1locnet*4.3natorg*4.4known*4.5connnet covers 13% of cases with a positive Outcome 2B, all uniquely; and 21% of cases with a positive Outcome 3, all uniquely.

24.5 The third most important combination is **4.3natorg*4.4KNOWN*4.5CONNNET** which covers 22% of cases where Outcome 1 is positive (uniquely) (the green area inside both central rectangles in the first Venn diagram, or -011)

24.6 Most green areas in the diagrams become striped / inconsistent as negative cases are added. The only combinations / areas that remain consistently positive throughout are 0000 (perhaps unexpectedly?) and 1110 (although the central less consistent areas presents

a higher number of cases). Turning 4.3 positive makes a big difference for Outcome 3 as 0100 becomes consistently negative. 00-1 is consistently negative for both Outcome 2B and Outcome 3.

Figure 80. Outcome 1

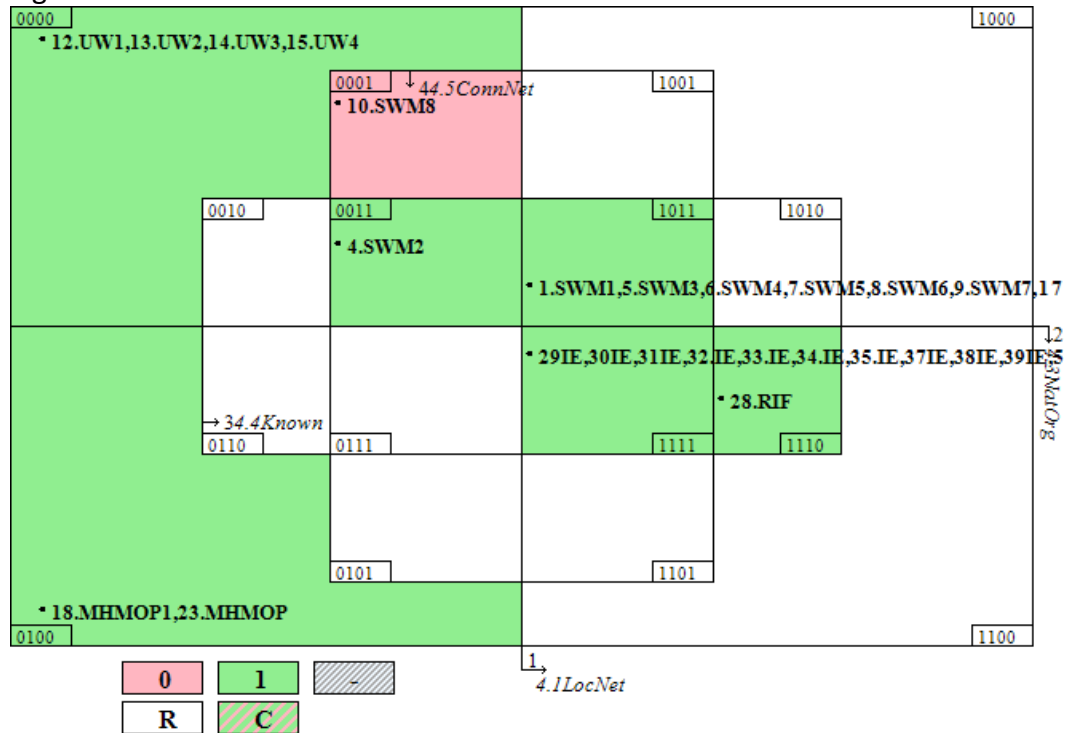

Figure 81. Outcome 2A

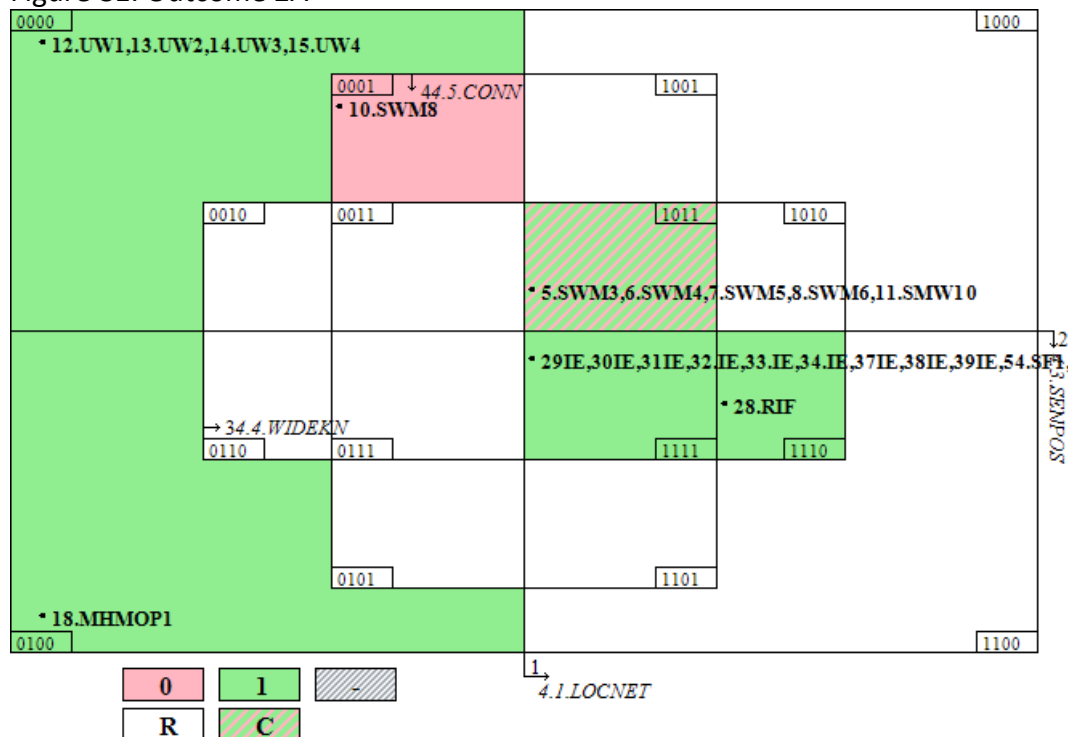

Figure 82. Outcome 2B

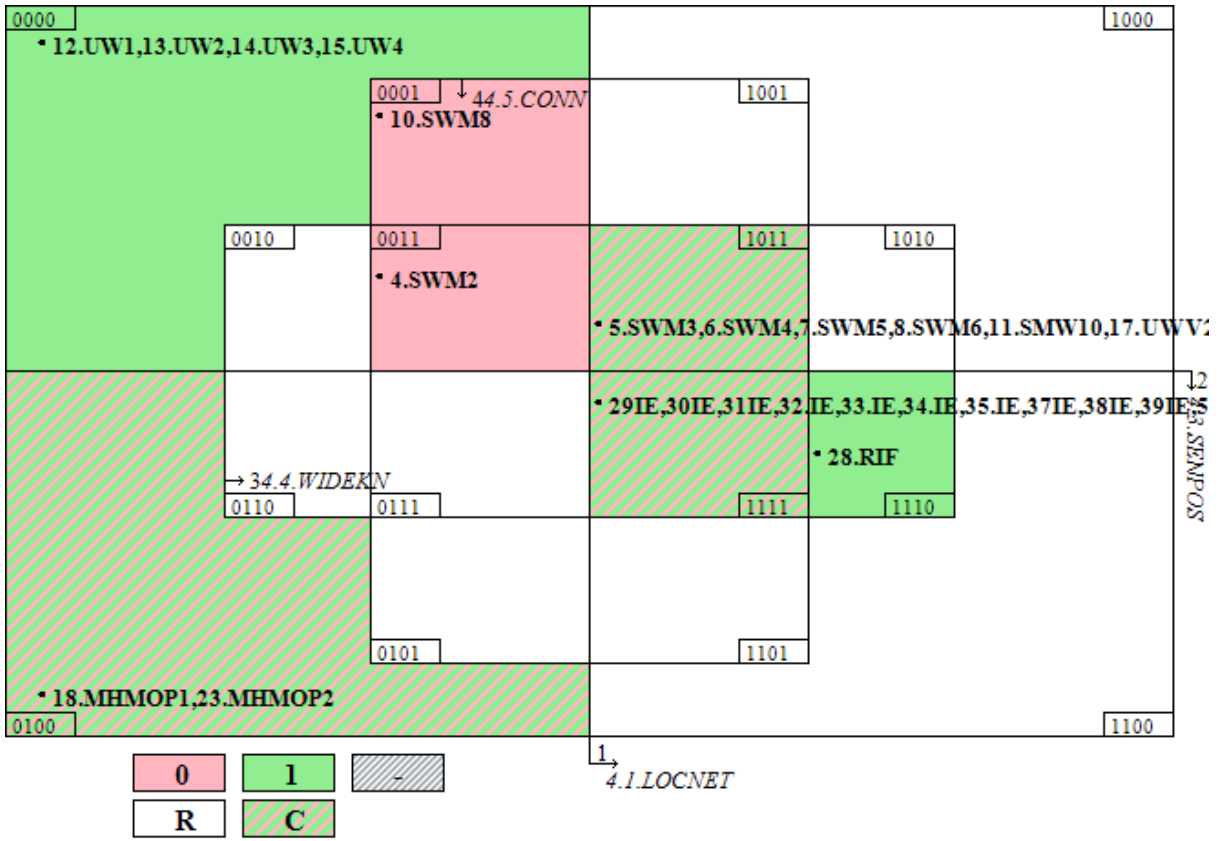
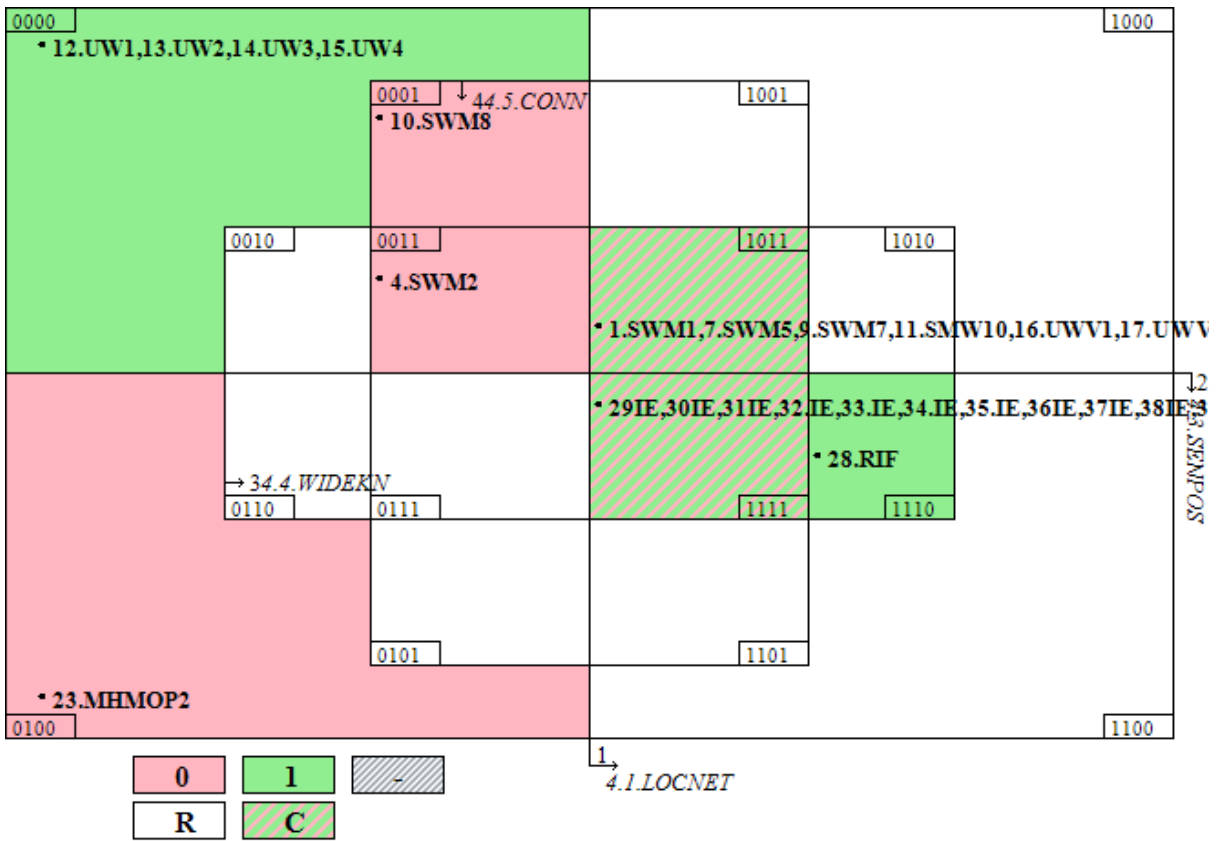

Figure 83. Outcome 3



Learning

5.1hypform, 5.2multhyp, 5.3condtest, 5.4impltest, 5.5systan, 5.6steps, 5.7plansu =

25.0 The first two datasets are similar: the one analysed for Outcome 1 has 49 cases, of which 48 positive and one negative (10.SWM8_Wastepickers_advocacy); the one analysed for Outcome 2A has 41 cases, of which 39 positive and two negative (10.SWM8_Wastepickers_advocacy and 11.SMW10_bag_model). The Outcome 2B dataset has 46 cases, of which 39 positive and 7 negative; and the Outcome 3 has 34 cases, of which 22 positive and 12 negative. The condition 5.2 is present in any extremely low number of cases.

25.1 All seven conditions in the model are absent in the only case with a negative Outcome 1, which makes them sufficient for a positive Outcome 1 as single conditions. At the same time, only 5.2 is consistently absent in cases with a negative value of Outcome 2A, so that is the only condition to the sufficient for a positive Outcome 2A and Outcome 2B. 5.5 is also relative rare. 5.6 and 5.7 have a pretty high consistency, by themselves as single conditions.

26.0 The Boolean minimisations applied to the 7-condition model returns an extremely complicated solution. Trying various reduced models doesn't help reduce complexity and the tradeoff between coverage and consistency for Outcome 1; however for Outcome 2A a 4-condition model was found which represented a relatively good fit. We tested this model for all outcomes and then added conditions back to see if more nuance could be achieved without losing consistency or clarity but with no success.

26.1 We present the model 5.2multhyp, 5.5systan, 5.6steps, 5.7plansu. The most important combination, covering 77% of cases with a positive Outcome 1 (35% uniquely) is **5.2multhyp*5.7PLANSU** (in the V.D. this is 0- -1, the area on the left inside the vertical central rectangle).

26.2 If we add absence of 5.6, the pathway covers 41% of cases (uniquely) for Outcome 2A: **5.2multhyp*5.6steps*5.7PLANSU**.

26.3 If we add absence of 5.5, the pathway **5.2multhyp*5.5systan*5.7PLANSU** covers 74% of cases with a positive Outcome 2B (38% uniquely, with 97% consistency).

26.4 If we add 5.6STEPS to the latter, the combination **5.2multhyp*5.5systan*5.6STEPS*5.7PLANSU** covers 64% of cases with a positive Outcome 3, all uniquely.

26.5 The combination below is also important, more for Outcome 2A and Outcome 2B than for Outcome 1 (covering 38% of the cases but only 2% uniquely – 94% consistency for Outcome 2B):

5.2multhyp*5.5systan*5.6STEPS (the area 001-, on the top-left quadrant inside the horizontal central rectangle)

26.7 The first two Venn diagrams are almost identical, with added inconsistency for Outcome 2A. The inconsistency increases with Outcome 2B, and some consistently negative combinations for Outcome 3. No combination remains consistently positive through the four outcomes.

Figure 84. Outcome 1

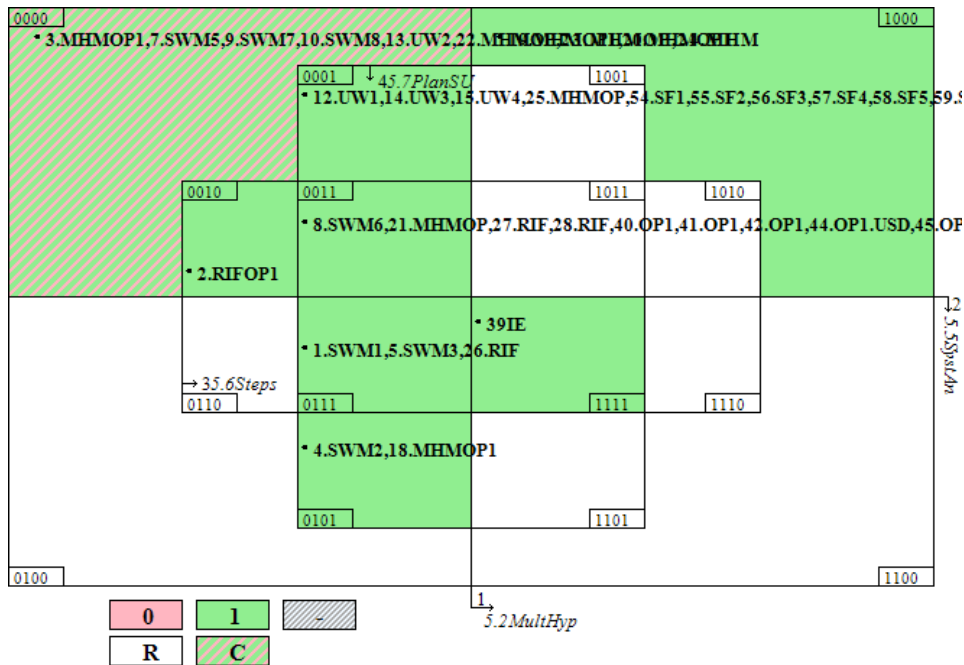

Figure 85. Outcome 2A

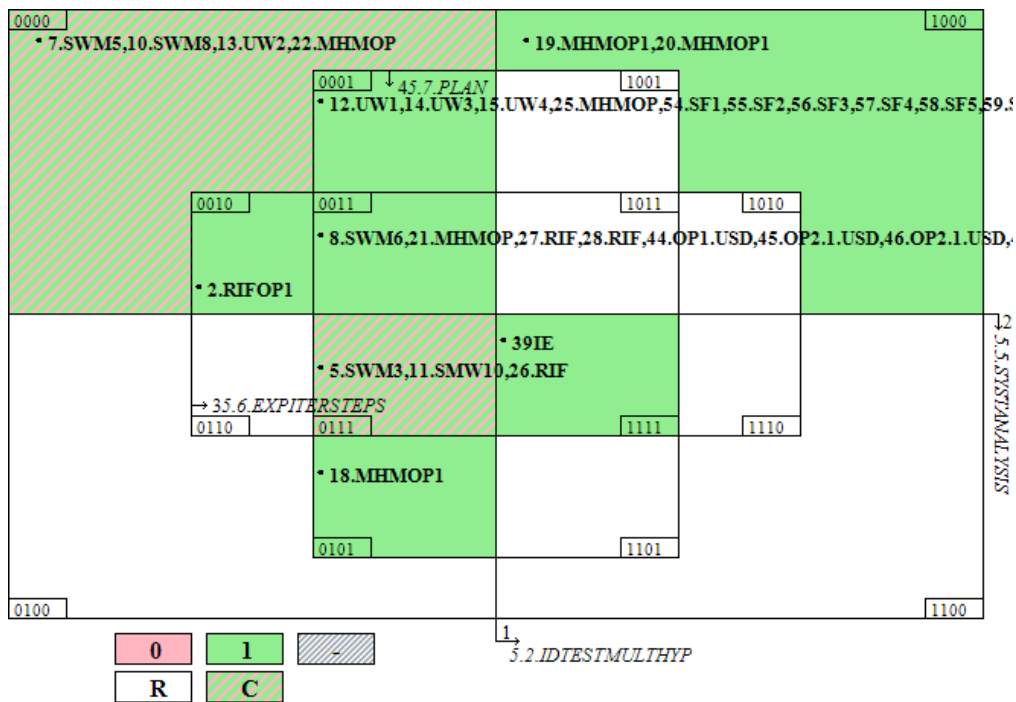

Figure 86. Outcome 2B

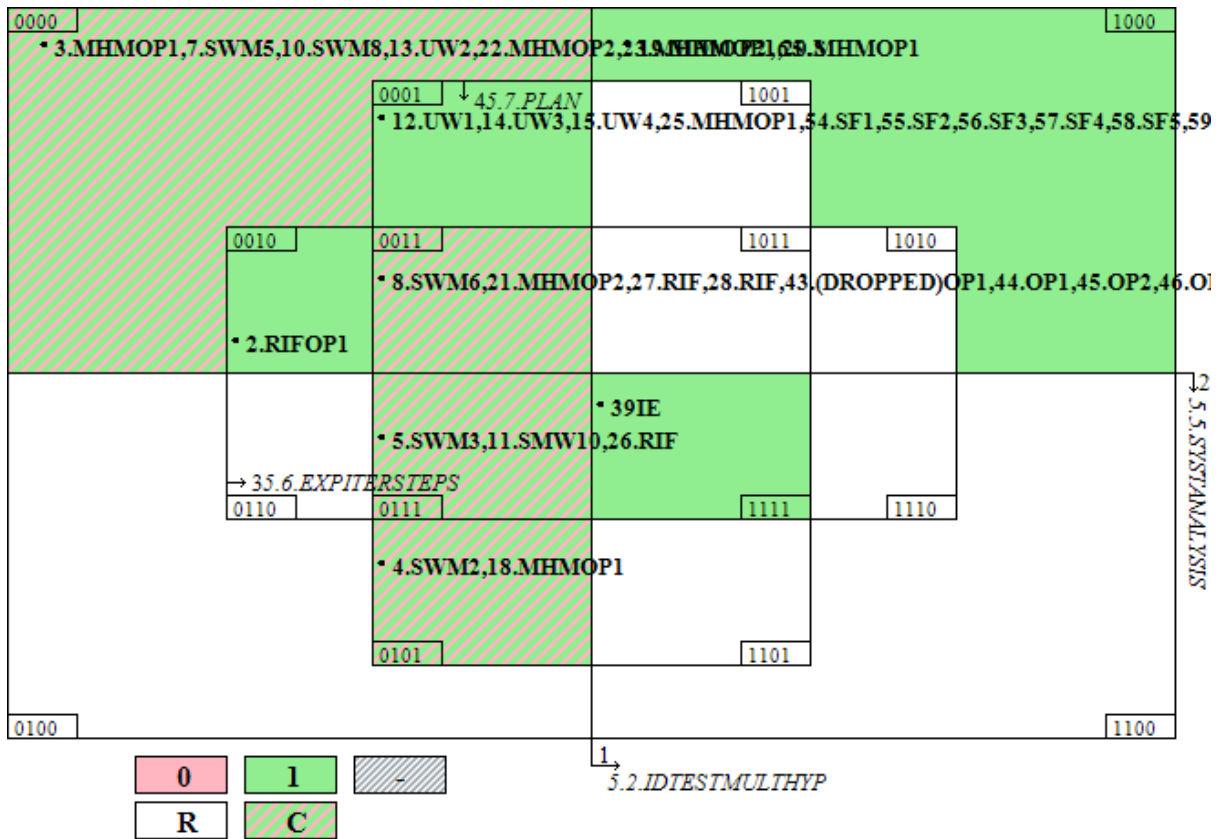
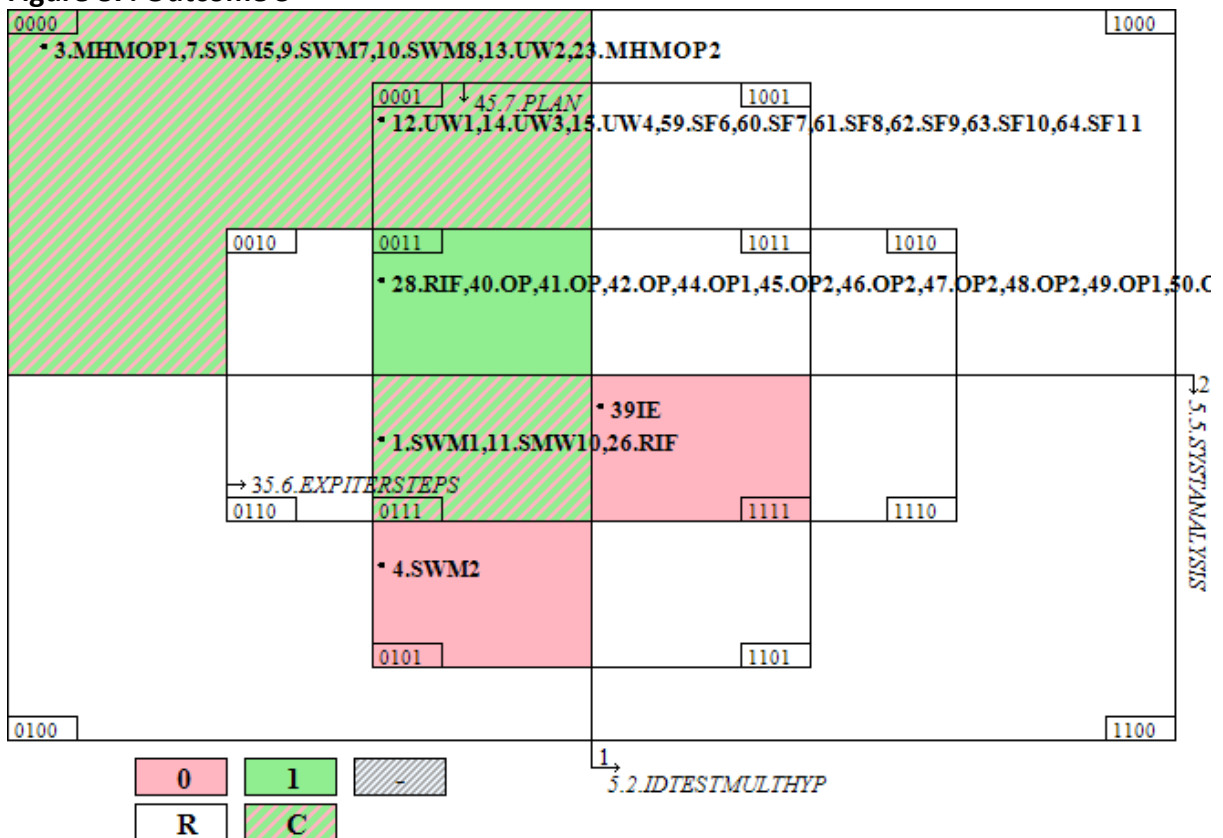

Figure 87. Outcome 3



27.0 A comparison of the various 5-condition models mentioned above suggested that we test the 4-condition model 5.1hypform, 5.2multhyp, 5.5systan, 5.7plansu.

The most important combination covers 67% of the cases with a positive Outcome 1; 74% of the cases with a positive Outcome 2A or Outcome 2B (all uniquely, too – but consistency for Outcome 2B is 97%); and 82% of the cases with a positive Outcome 3 (all uniquely, but with 78% consistency)

5.2multhyp*5.5systan*5.7PLANSU (-001: it's the area on the top inside the vertical central rectangle and outside the horizontal central rectangle)

27.1 The second most important combination covers 16% of cases with a positive Outcome 1 and 10% of cases with a positive Outcome 2A (all uniquely):

5.1HYPFORM*5.5systan*5.7plansu (it's 1-00, the large area on the right, outside of both central rectangles) To remain relevant for Outcome 2B, this combination needs to be added 5.2MULTHYP (5%)

27.2 Finally, another combination covers 12% of cases with a positive Outcome 1:

5.1HYPFORM*5.5SYSTAN*5.7PLANSU (it's 1-11, the central area inside both rectangles and on the right)

27.3 And a similar combination covers 3% of cases with a positive Outcome 2A or Outcome 2B:

5.1HYPFORM*5.2MULTHYP*5.5SYSTAN*5.7PLANSU (the area 1111, on the right, bottom, and inside both central rectangles)

27.4 The Venn diagrams show that the only combination to survive the addition of negative cases is

5.1hypform*5.2multhyp*5.5systan*5.7PLANSU (0001)

Figure 88. Outcome 1

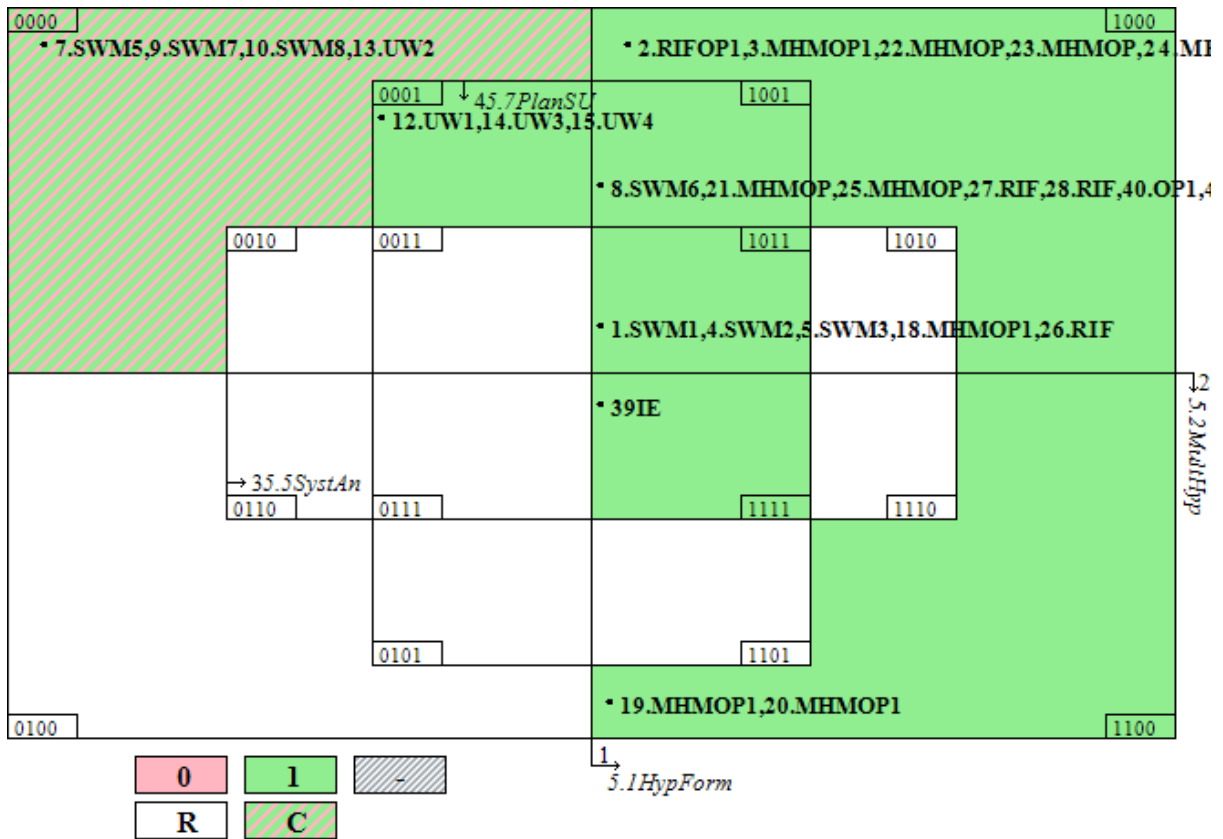

Figure 89. Outcome 2A

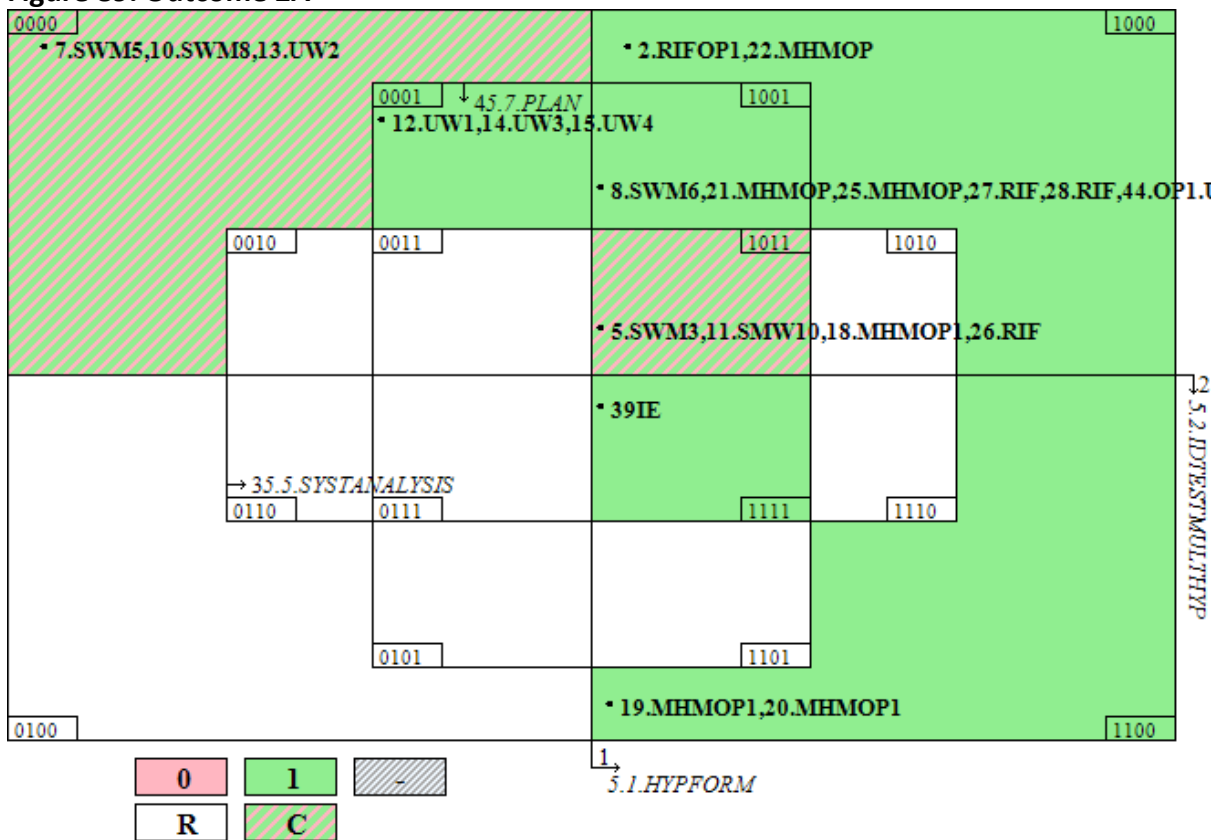

Figure 90. Outcome 2B

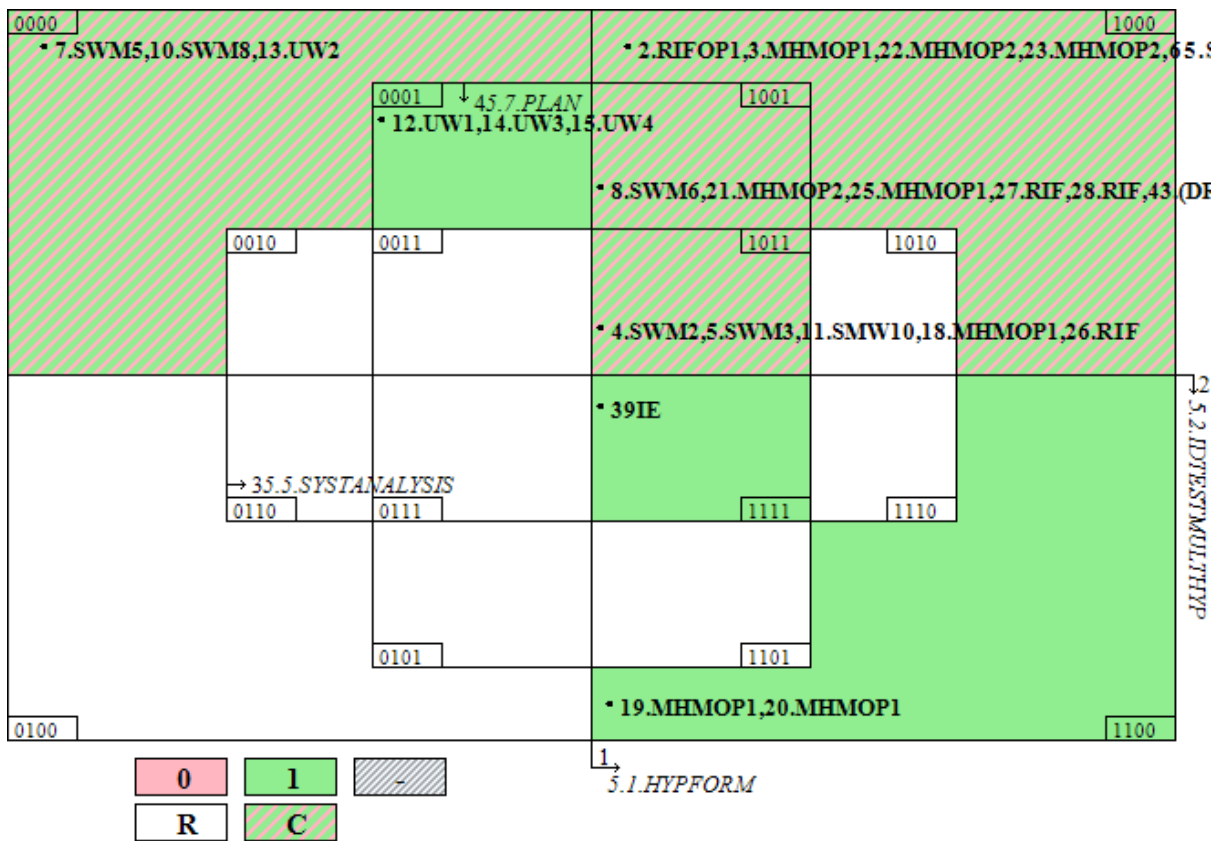
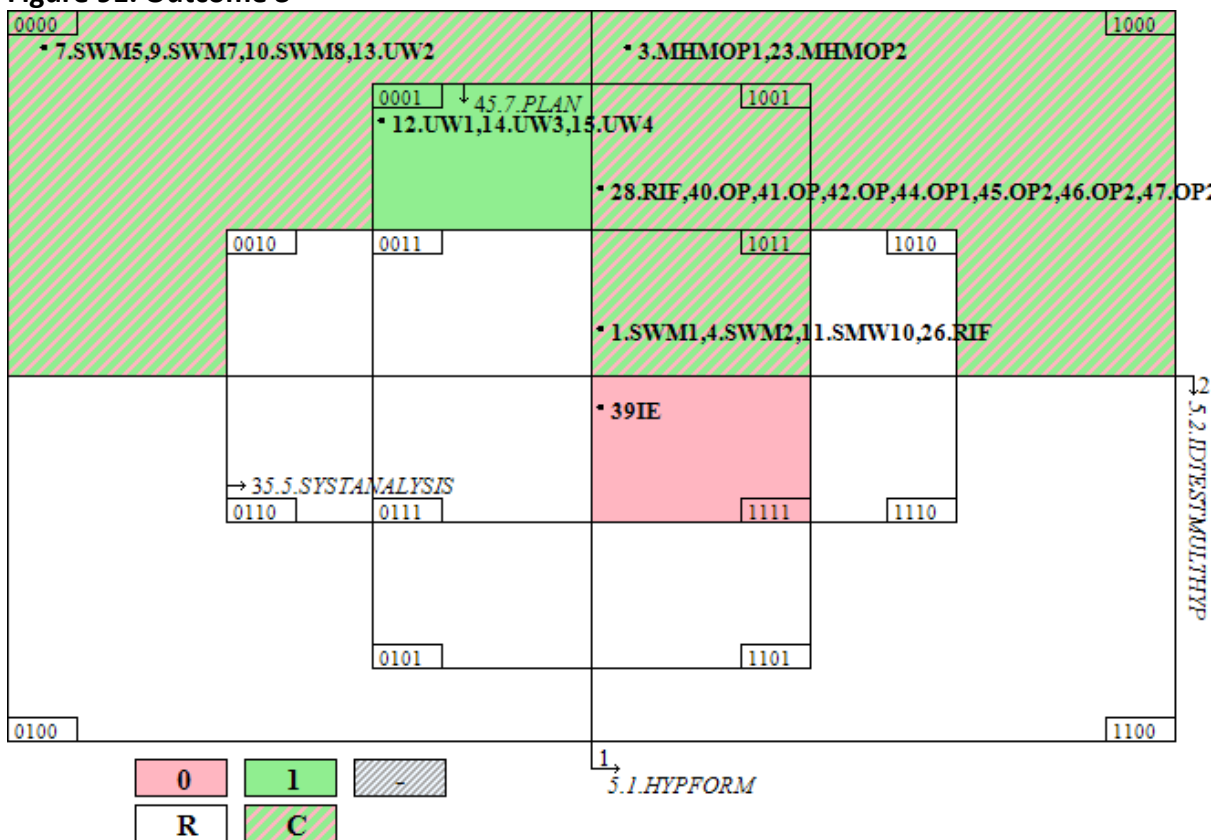

Figure 91. Outcome 3



28.0 Since not many cases present 5.1, we can try and see what happens if we test the 3-condition model obtained by removing the latter condition from the model above; and test 5.2multhyp + 5.5systan + 5.7plansu

28.1 The most important combination covers for Outcome 1 is **5.2multhyp*5.7PLANSU** 77% of cases with a positive Outcome 1 (67% uniquely, the left side of the central rectangle); while the most important combination for Outcome 2A is quite different and the presence of 5.7 is replaced by the absence of 5.5, covering 85% of cases with a positive Outcome 2A (74% uniquely, 97% consistency): **5.2multhyp*5.5systan** (the top-left quadrant).

28.2 To make the last combination relevant for Outcome 2B and Outcome 3, too, we need to add back the presence of 5.7: **5.2.idtestmult*5.5.systanalyssi*5.7.PLAN (001)** covers 74% of cases with a positive Outcome 2B (all uniquely, with 97% consistency) and 82% of cases with a positive Outcome 3 (all uniquely, but consistency is only 78%).

Figure 92. Outcome 1

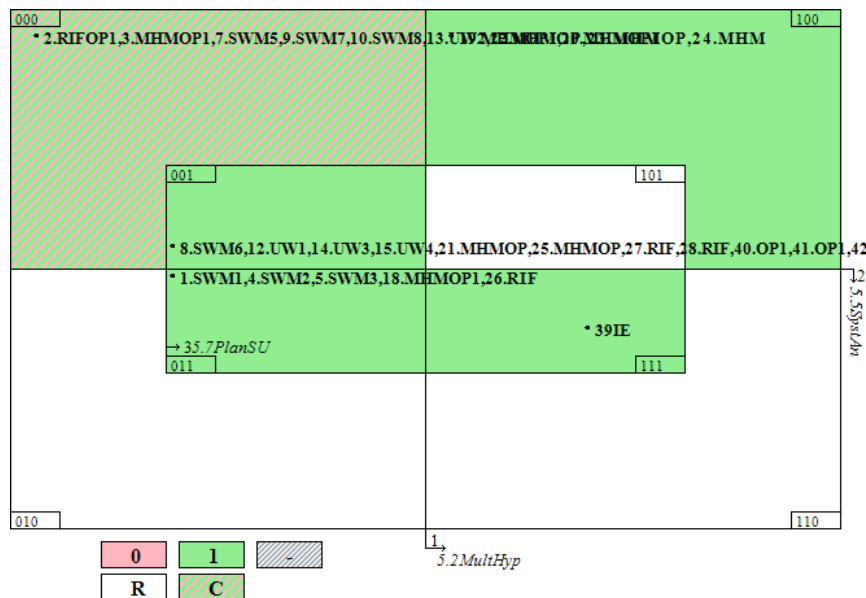

Figure 93. Outcome 2A

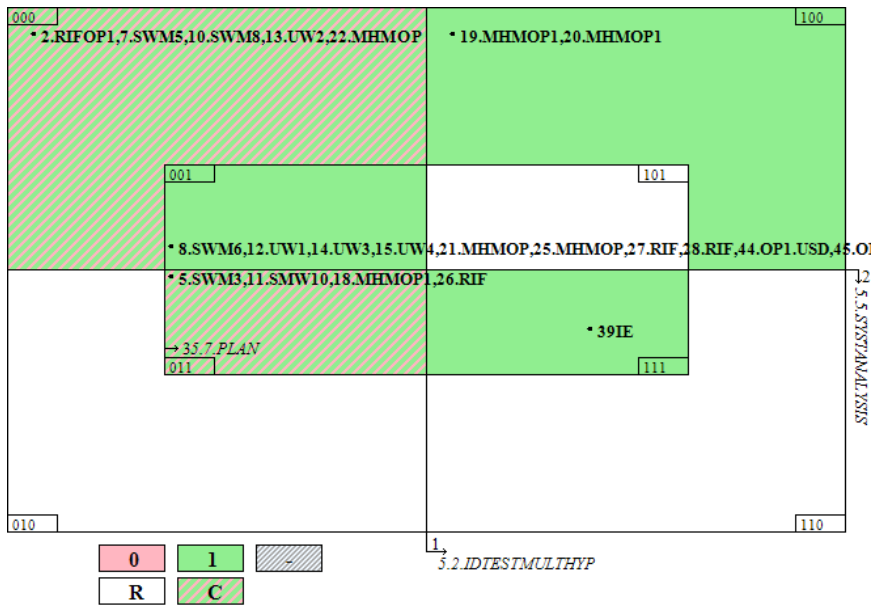

Figure 94. Outcome 2B

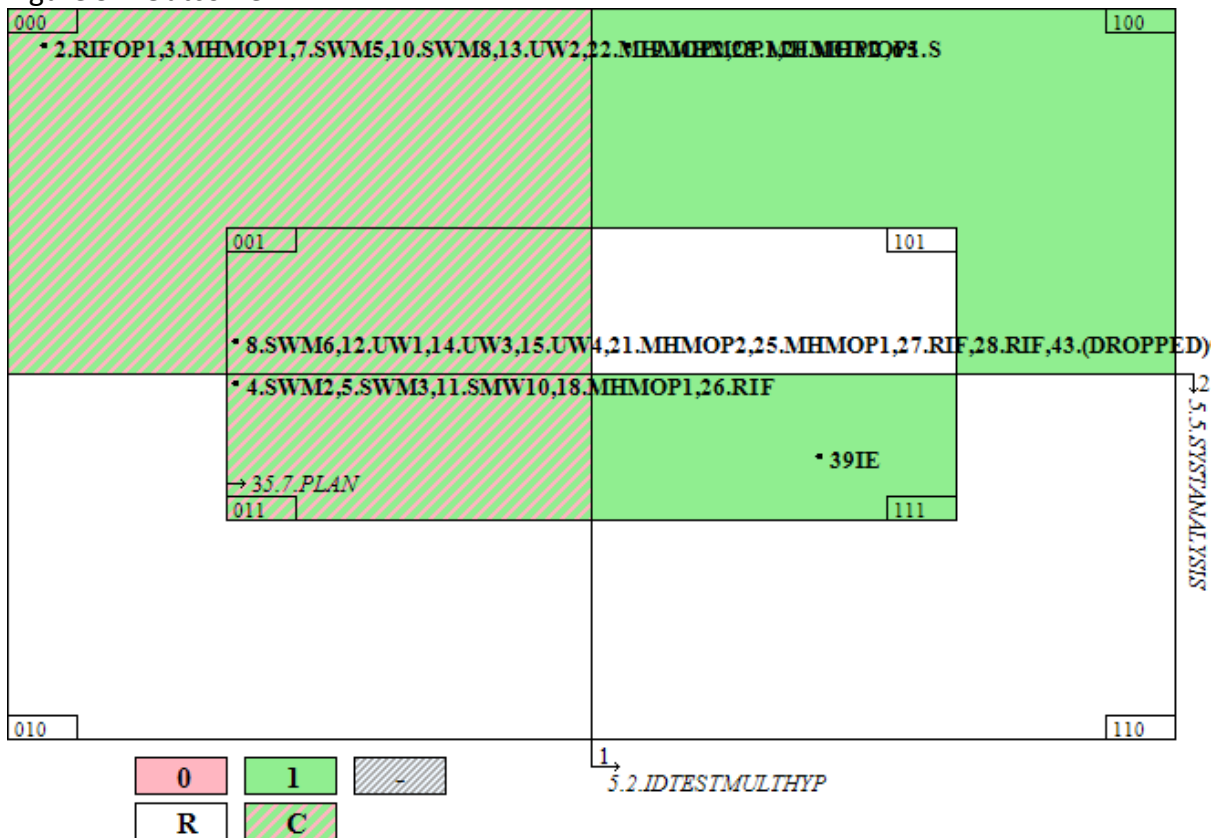
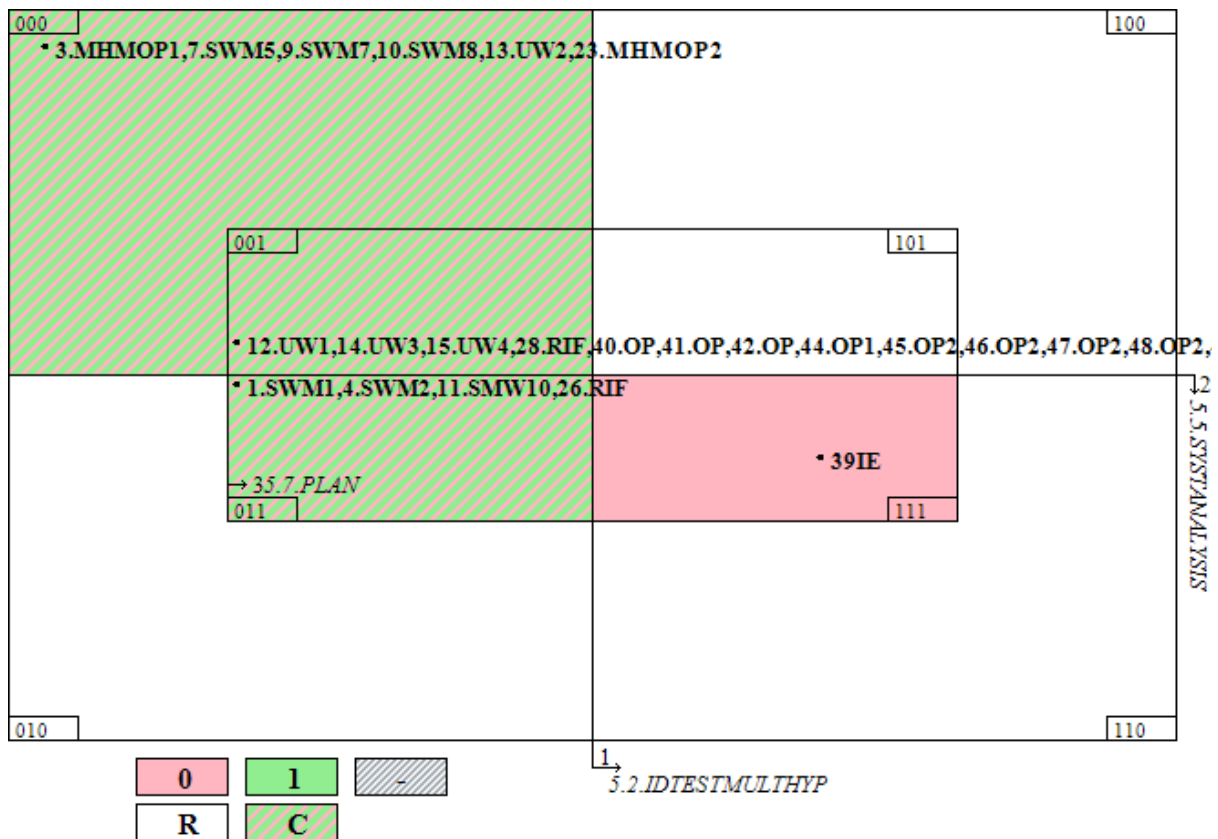

Figure 95. Outcome 3



29.0 We now remove both conditions that are rarely present in the dataset (5.2 and 5.5) from the original model, and test the 5-condition model 5.1hypform + 5.3condtest + 5.4impltest + 5.6steps + 5.7plansu.

29.1 The most important combination is **5.1HYPFORM*5.6STEPS*5.7PLANSU (1- -11)** which covers 44% of cases (36% uniquely) with a positive Outcome 1 or a positive Outcome 2A (94% consistency) or a positive Outcome 2B (89% consistency). These are the four rectangles on the right, inside the vertical rectangle and inside the two wide short rectangles representing the fifth condition (10011, 10111, 11111, 11011). To make the combination relevant for Outcome 3, two conditions need to be added: **5.1.HYPFORM*5.3.condhpytest*5.4.HYPRIG*5.6.EXPITERSTEP*5.7.PLAN (10111)** covers 59% of cases with a positive Outcome 3 (all uniquely).

29.2 The second most important combination, **5.3condtest*5.4impltest*5.6steps*5.7PLANSU (-0001)**, covers 29% of cases with a positive Outcome 1 (6% uniquely), and 36% of cases with a positive Outcome 2A or Outcome 2B (all uniquely). These are the two areas at the top, 10001 and 00001. If we add the absence of 5.1, **5.1hypform*5.3condtest*5.4impltest*5.6steps*5.7PLANSU (00001)** covers 14% of cases with a positive Outcome 3, all uniquely.

29.3 Finally, **5.1HYPFORM*5.3CONDTEST*5.4IMPLTEST (111- -)**, covers 21% of cases with a positive Outcome 1 (12.5% uniquely) and 18% of cases with a positive Outcome 2A (3% uniquely, with 87.5% consistency). This is the area in the bottom-right quadrant inside the

central horizontal rectangle, made of 11100, 11110, 11101, and 11111). If we add the presence of 5.6, **5.1HYPFORM*5.3CONDTEST*5.4IMPLTEST*5.6STEPS (1111-)** covers 10% of cases with a positive Outcome 2B (3% uniquely).

29.4 The only two combinations that remain positive through the four outcomes are the following:

5.1hypform*5.3condtest*5.4impltest*5.6steps*5.7PLANSU (00001)

5.1HYPFORM*5.3CONDTEST*5.4impltest*5.6STEPS*5.7PLANSU (11011)

29.5 The combination **5.1HYPFORM*5.3condtest*5.4impltest*5.6steps*5.7plansu (10000)** consistently leads to a negative Outcome 2B and

In addition to the one above, the following combinations consistently lead to a negative Outcome 3:

5.1HYPFORM*5.3CONDTEST*5.4IMPLTEST*5.7PLANSU (111-1)

5.1hypform*5.3condtest*5.4IMPLTEST*5.6steps*5.7plansu (00100)

Figure 96. Outcome 1

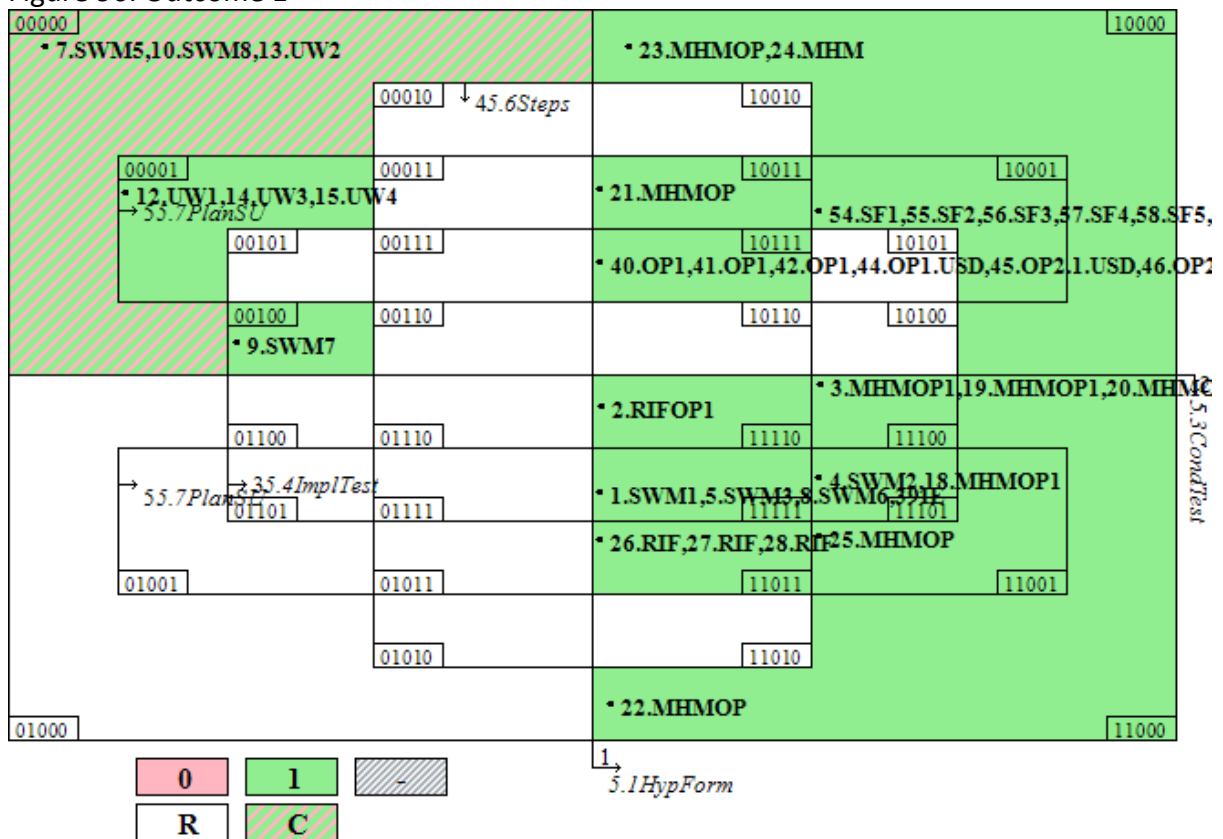

Figure 97. Outcome 2A

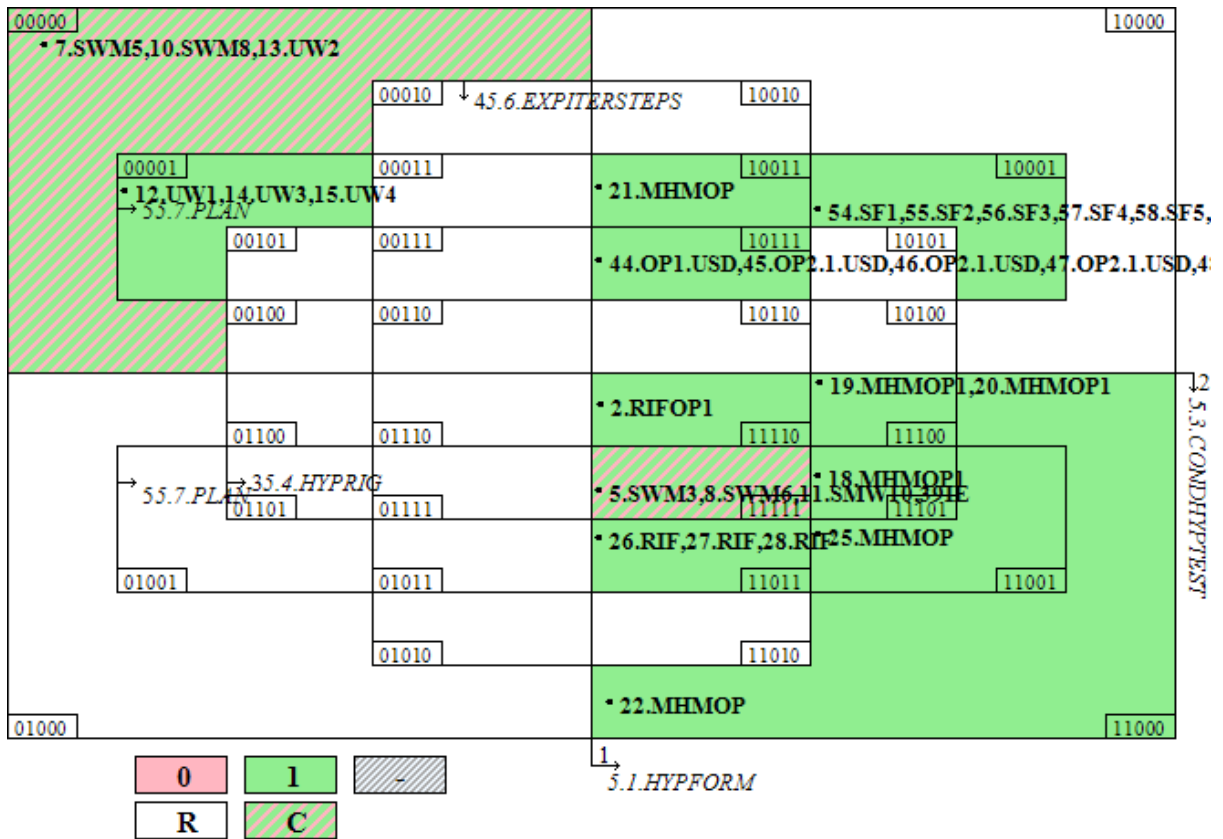

Figure 98. Outcome 2B

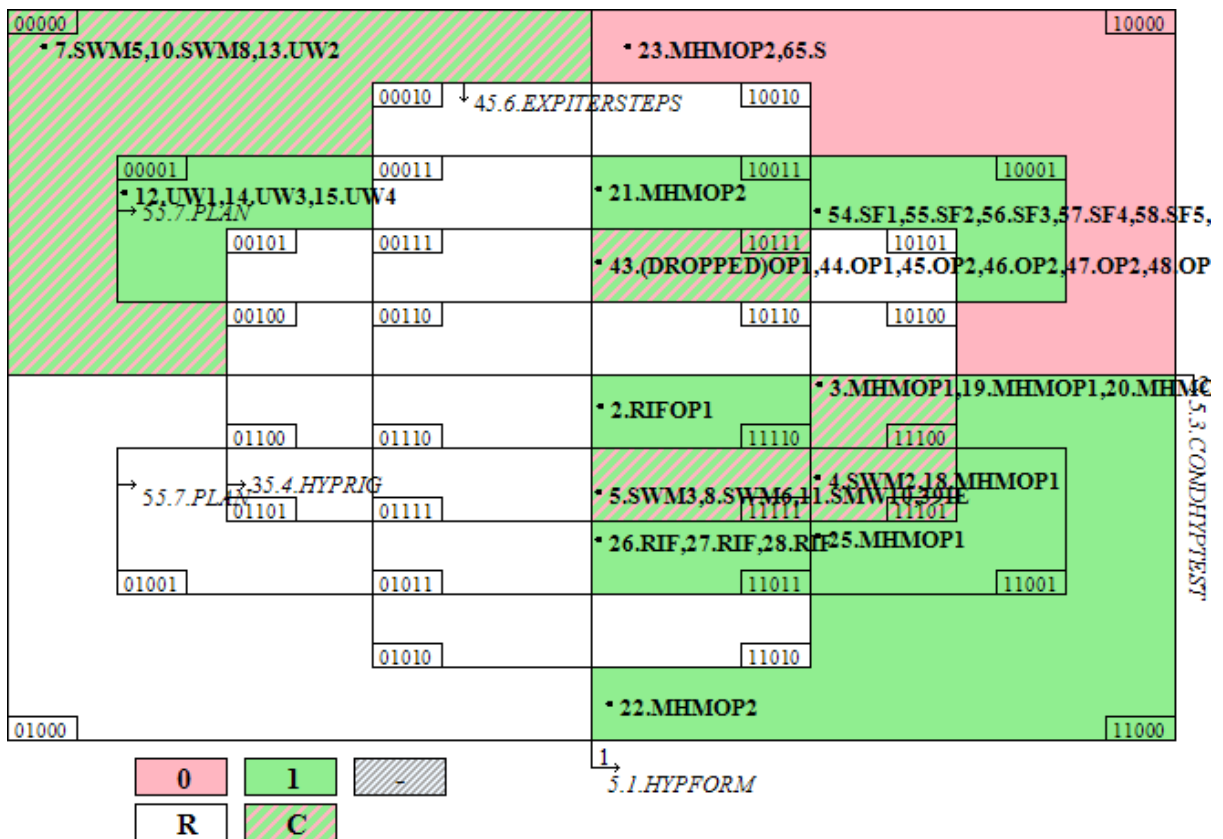
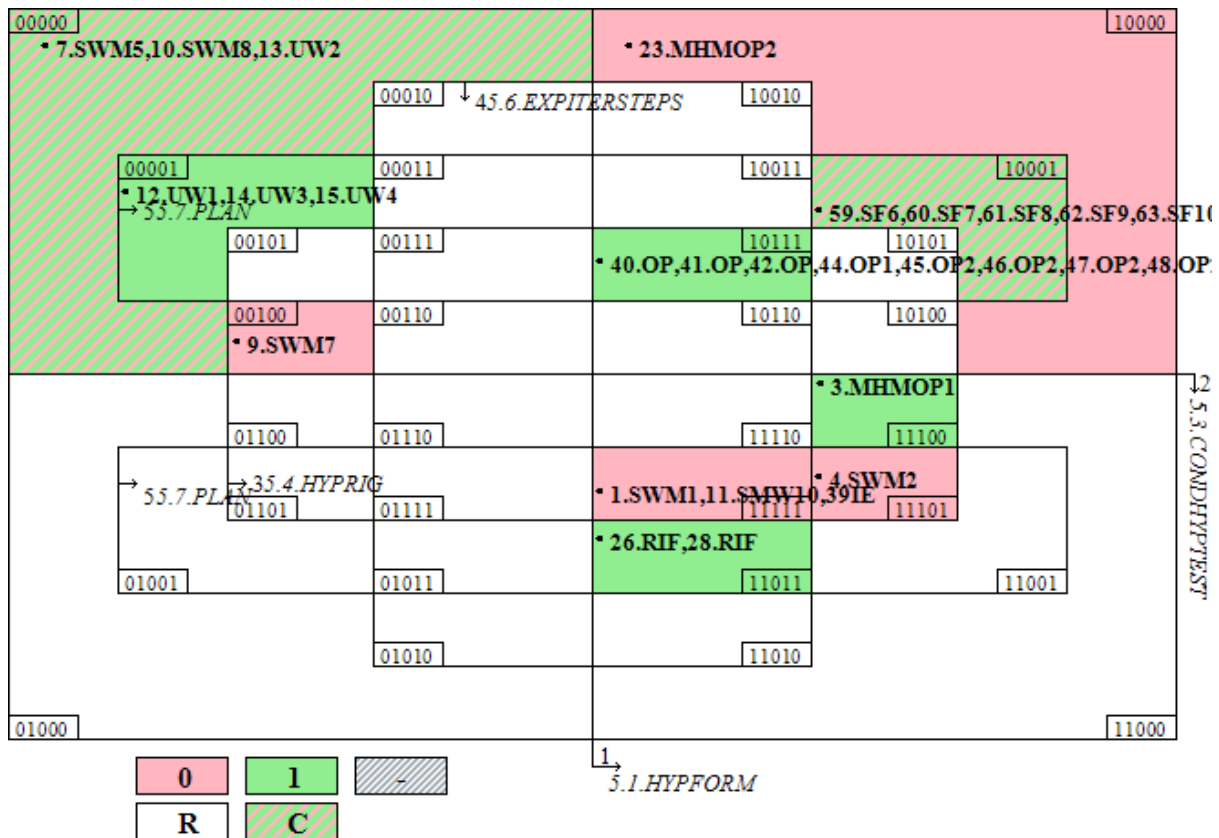

Figure 99. Outcome 3



30.0 Another 5-condition model that seemed promising for at least some of the outcomes is 5.1.hypform + 5.3.condtest + 5.4.impltest + 5.5.systan + 5.6.steps

30.1 There are two most important combinations. The first is **5.1HYPFORM*5.4impltest*5.5systan** which covers 37.5% cases with a positive Outcome 1 (31% uniquely), 41% of cases with a positive Outcome 2A (33% uniquely); and 41% of cases with a positive Outcome 2B (5% uniquely, with 89% consistency).

30.2 The second one is **5.1HYPFORM*5.5systan*5.6STEPS**, which covers 37.5% of cases with a positive Outcome 1 (27% uniquely); 38% of cases with a positive Outcome 2A or Outcome 2B (31% uniquely, with 94% consistency for Outcome 2B). If we add absence of 5.3 and presence of 5.4, the combination **5.1.HYPFORM*~5.3.condtest*5.4.IMPLTEST*5.5.systan*5.6.STEPS** covers 59% of cases with a positive Outcome 3 (all uniquely).

30.3 Another combination that is relevant for Outcome 2B and Outcome 3 is **5.1.hypform*5.3.condtest*5.4.impltest*5.5.systan*5.6steps** covers 23% of cases with a positive Outcome 3 (all uniquely). If we remove the first condition, **5.3.condtest*5.4.impltest*5.5.systan*5.6steps** covers 41% of cases with a positive Outcome 2B (13% uniquely) with 84% consistency.

30.4 The only combination that survives the addition of more negative cases with outcomes Outcome 2B and Outcome 3 is

5.1.HYPFORM*5.3.CONDTEST*5.4.impltest*5.6STEPS (110-1). Notice that the two following combinations consistently lead to a negative Outcome 3:

5.1.HYPFORM*5.3.CONDTEST*5.4.IMPLTEST*5.5.SYSTAN (1111-) and

5.1.hypform*5.3.condtest*5.4.IMPLTEST*5.5.systan*5.6steps (00100)

Figure 100. Outcome 1

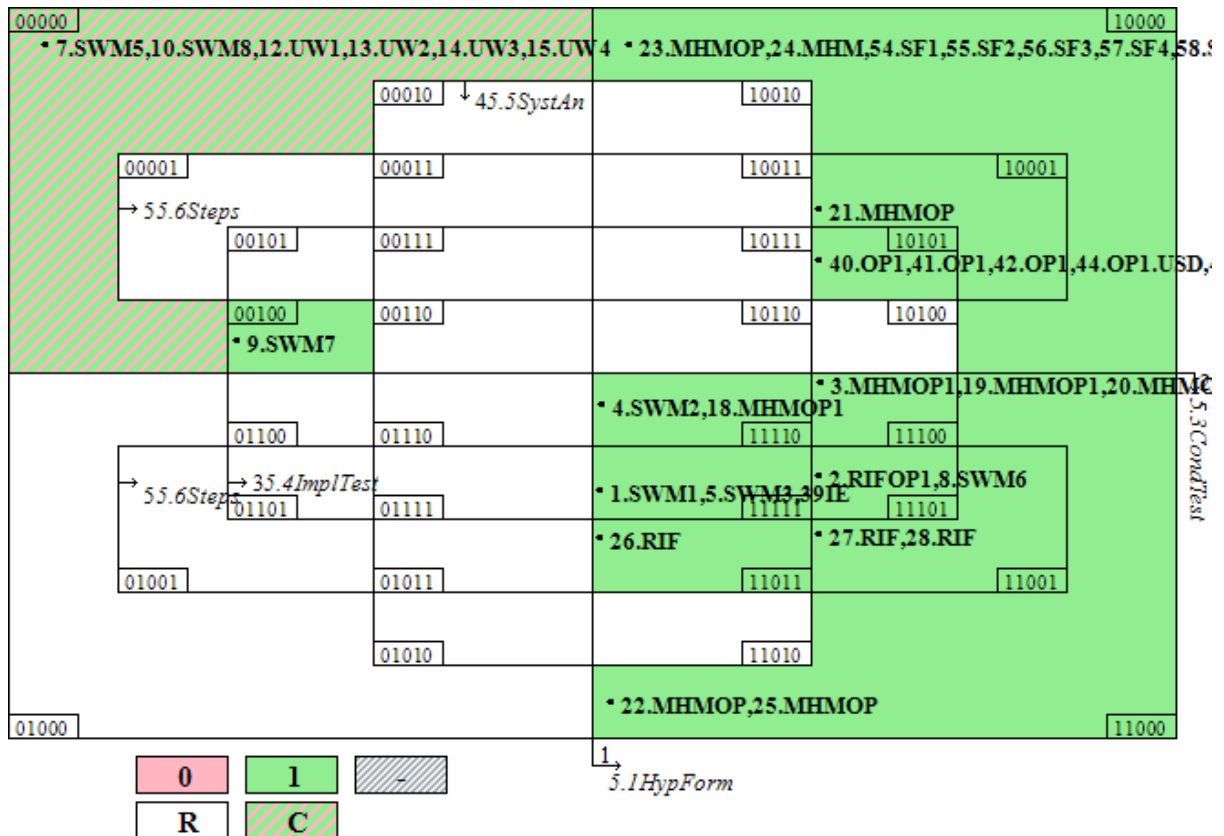

Figure 101. 012A

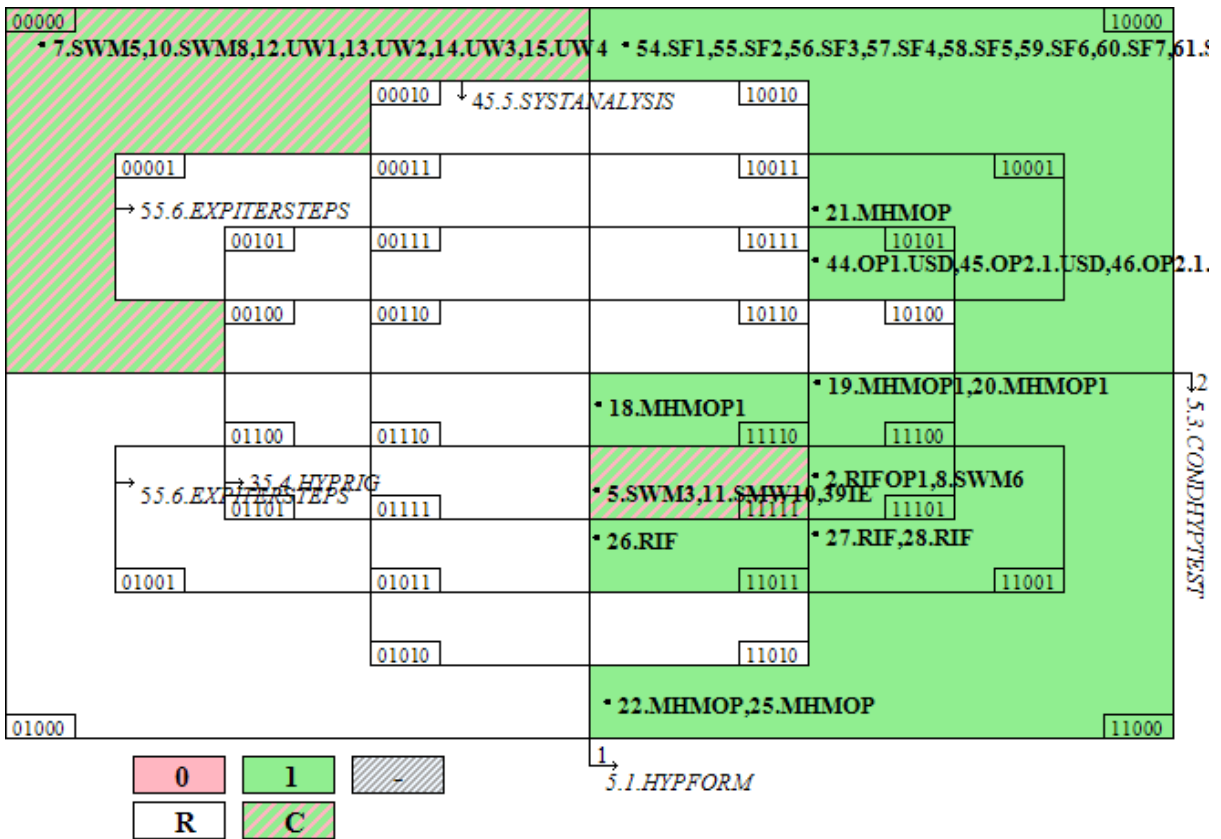

Figure 102. Outcome 2B

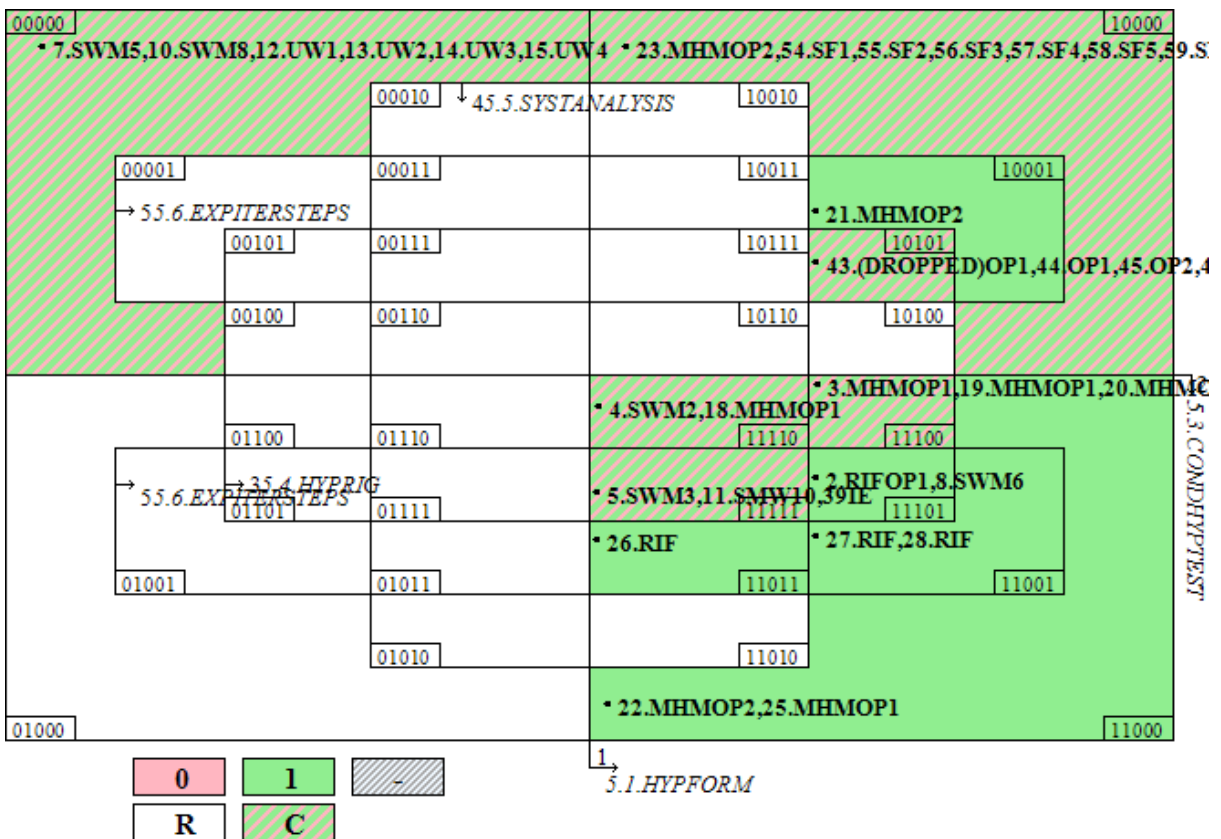
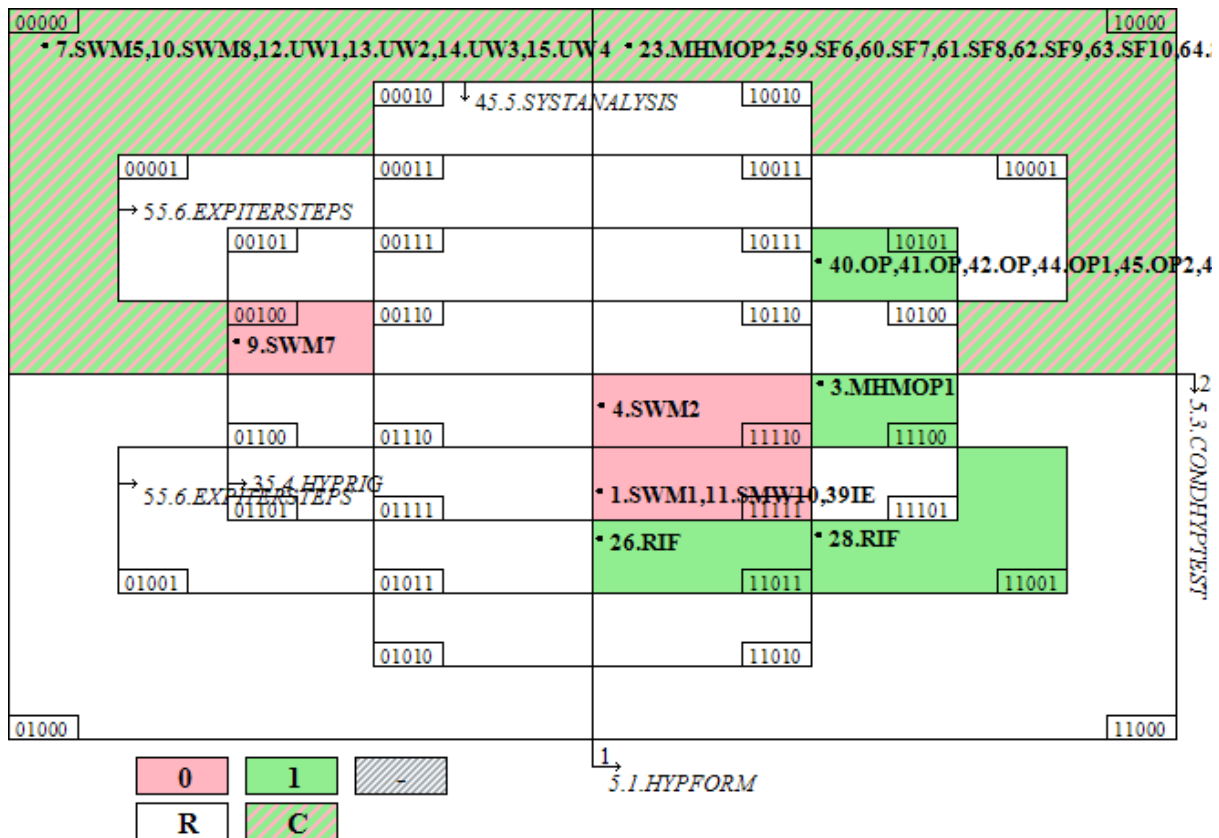

Figure 103. Outcome 3



31.0 Since very few cases seem to be inside 5.5, we remove it from the above model and test 5.1.hypform + 5.3.condtest, 5.4.impltest + 5.6.steps. Four combinations emerge that seem to have similar importance:

31.1 **5.1HYPFORM*5.6STEPS** covers 46% of cases with a positive Outcome 1 (27% uniquely) and 46% of cases with a positive Outcome 2B (36% uniquely, with 90% consistency). If we add the absence of 5.3, **5.1HYPFORM*5.3condtest*5.6STEPS** covers 28% of cases with a positive Outcome 2A (26% uniquely). If further add the presence of 5.4, **5.1HYPFORM*5.3condtest*5.4IMPLTEST*5.6STEPS** covers 59% of cases with a positive Outcome 3 (all uniquely).

31.2 **5.1HYPFORM*5.4impltest** covers 40% of cases with a positive Outcome 1 (27% uniquely); 44% of conditions with a positive Outcome 2A (8% uniquely), and 44% of cases with a positive Outcome 2B (5% uniquely, 89% consistency)

31.3 **5.1HYPFORM*5.3CONDTEST** covers 31% of cases with a positive Outcome 1 (10% uniquely). If we add the absence of 5.6, **5.1HYPFORM*5.3CONDTEST*5.6steps** covers 13% of cases with a positive Outcome 2A (8% uniquely).

31.4 Finally, **5.3.condtest*5.4.impltest*5.6.steps** covers 41% of cases (13% uniquely) with a positive Outcome 2A (94% consistency) or Outcome 2B (84% consistency). If we add the absence of 5.1, the combination

5.1.hypform*5.3.condtest*5.4.impltest*5.6.steps covers 23% of cases with a positive Outcome 3 (all uniquely).

31.4 The only combination surviving the addition of more negative cases is

5.1HYPFORM*5.3CONDTEST*5.4impltest*5.6STEPS (1101).

Two combinations consistently lead to a negative Outcome 3:

5.1hypform*5.3condtest*5.4IMPLTEST*5.6steps (0010) and

5.1HYPFORM*5.3CONDTEST*5.4IMPLTEST*5.6STEPS (1111)

Figure 104. Outcome 1

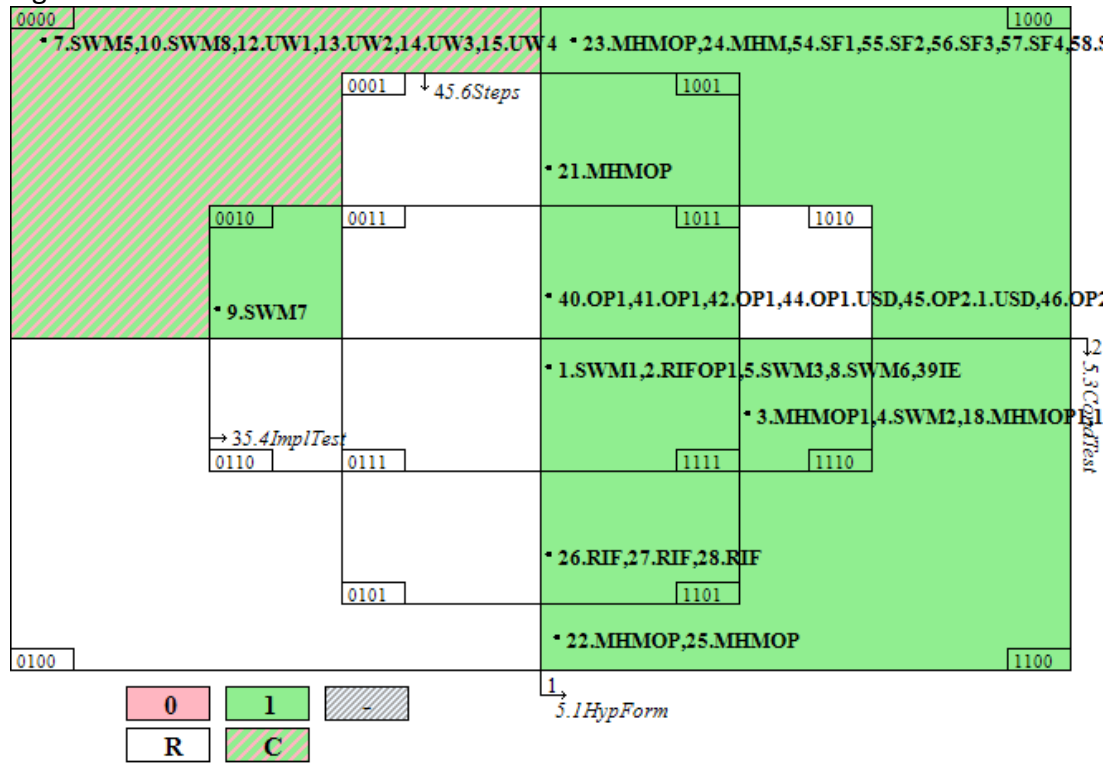

Figure 105. Outcome 2A

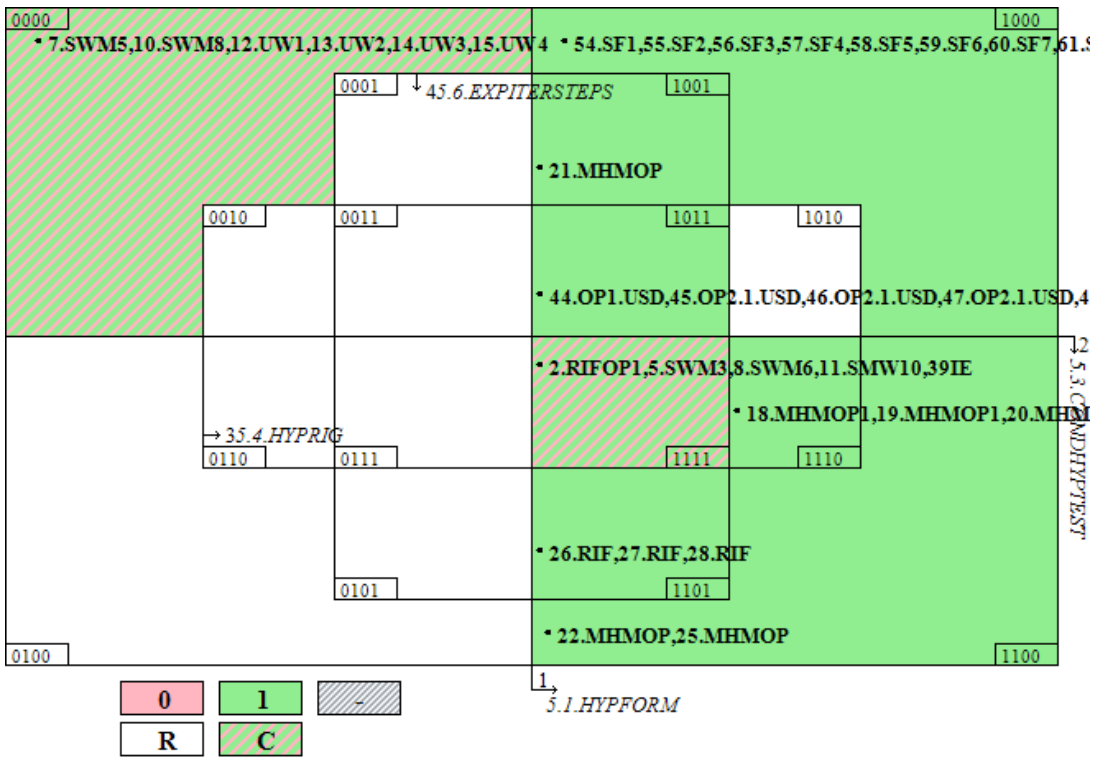

Figure 106. Outcome 2B

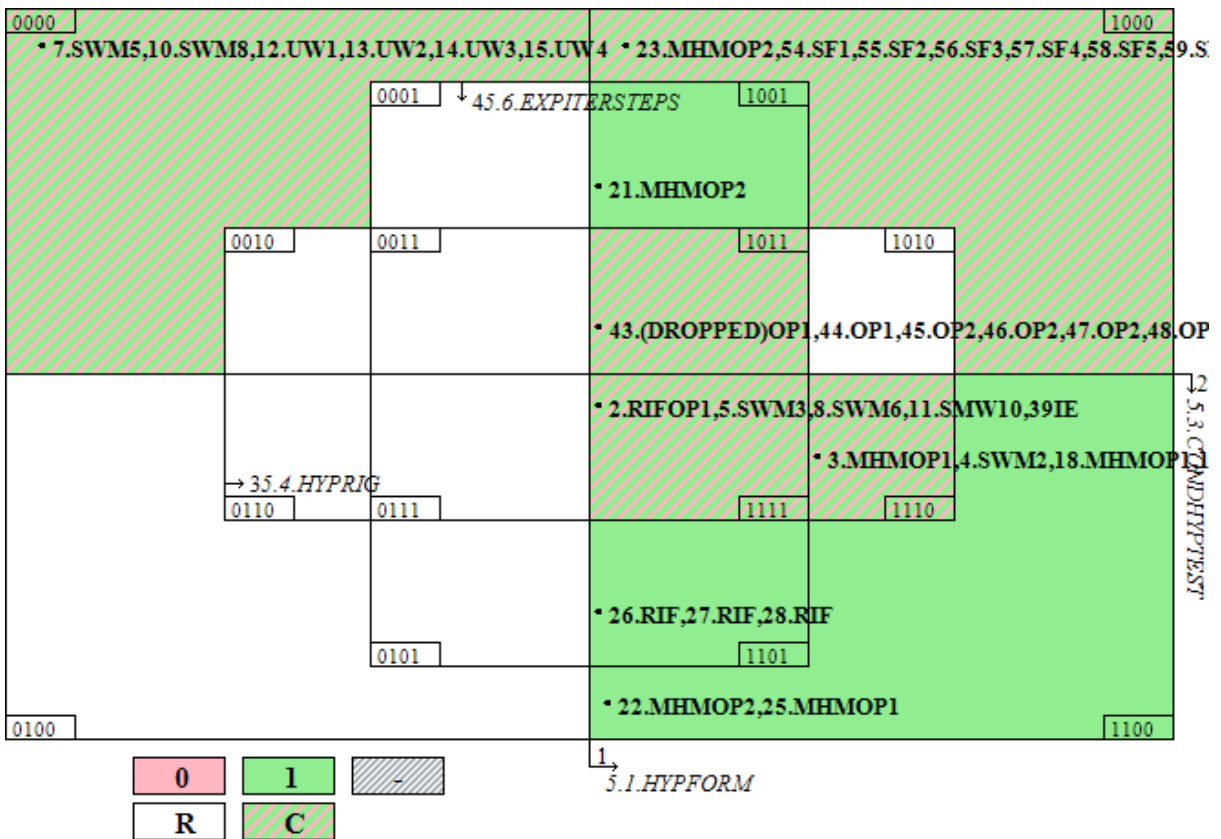
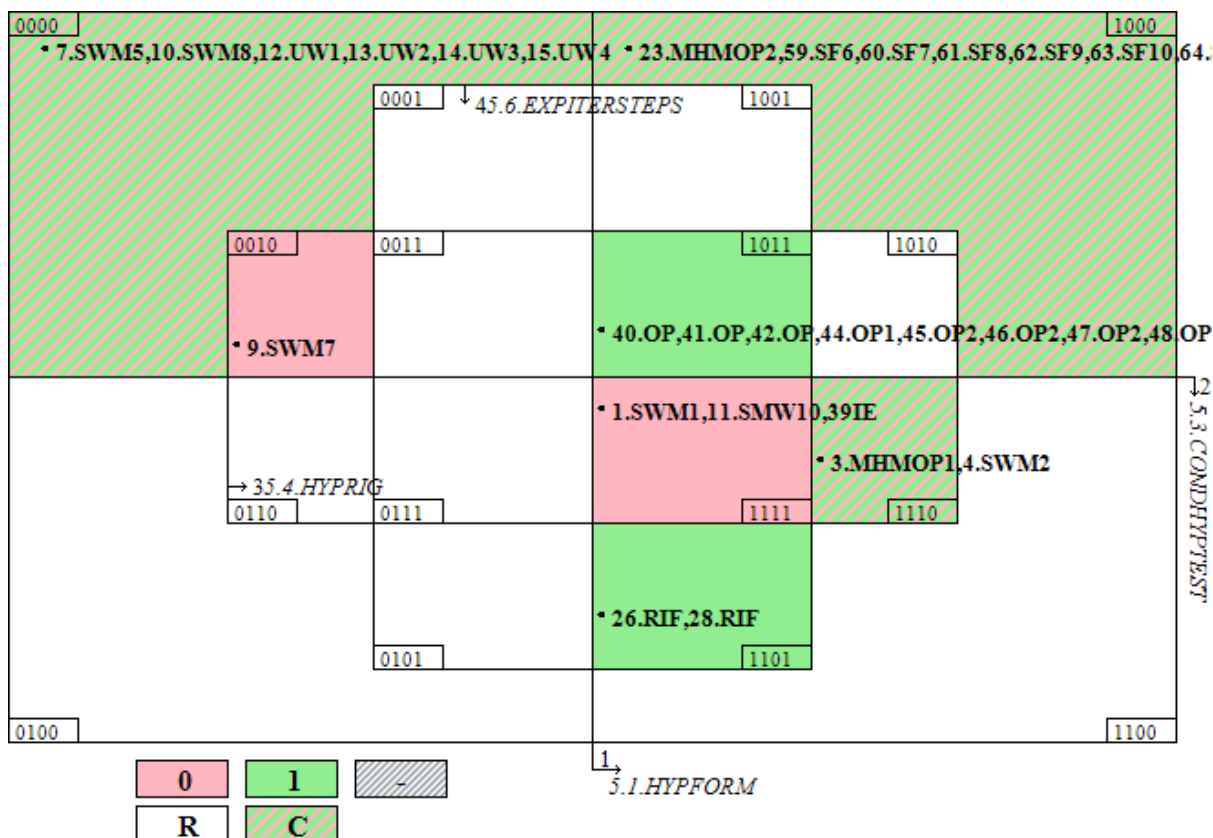

Figure 107. Outcome 3



32.0 The following shorter model was tested because it seemed particularly relevant to Outcome 3: 5.1.hypform + 5.4.impltest + 5.6.steps

32.1 The most important combination is **5.1HYPFORM** which covers 87.5% of cases with a positive Outcome 1 (77% uniquely); 87% of cases with a positive Outcome 2A (54% uniquely). If we add the presence of 5.6, **5.1HYPFORM*5.6STEPS** covers 46% of cases with a positive Outcome 2B (all uniquely, 90% consistency) and 68% of cases with a positive Outcome 3 (all uniquely, 83% consistency).

32.2 The second most important combination is **5.4impltest*5.6steps**, which covers 46% of cases with a positive Outcome 2A (13% uniquely, 95% consistency) and 46% of cases with a positive Outcome 2B (all uniquely, 86% consistency). If we add the absence of 5.1, **5.1hypform*5.4impltest*5.6steps** covers 23% of cases with a positive Outcome 3 (all uniquely).

The only combination surviving the addition of negative cases and the change in outcome is **5.1HYPFORM*5.4impltest*5.6STEPS (101)**.

Coincidentally, **5.1hypform*5.4IMPLTEST*5.6steps (010)** is the only combination to consistently lead to a negative Outcome 3 (but is positive for Outcome 1).

Figure 108. Outcome 1

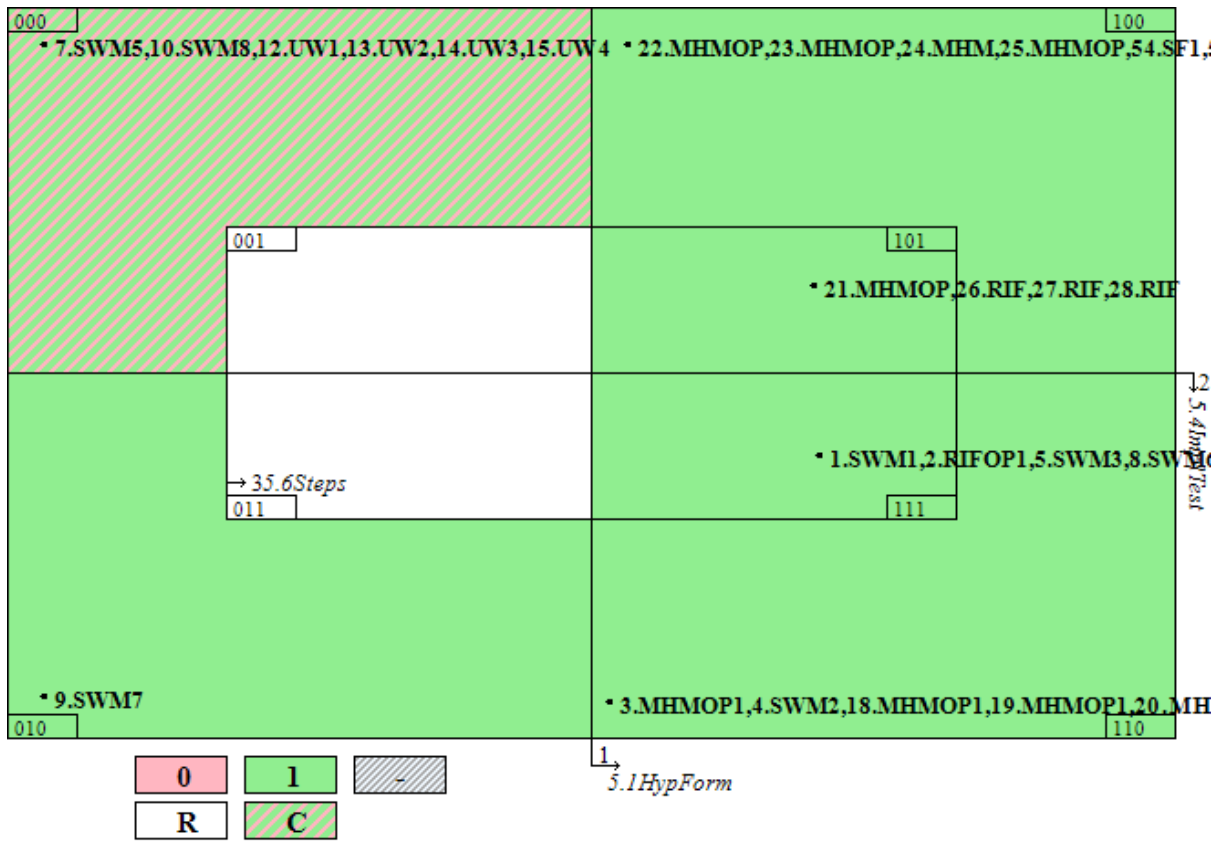

Figure 109. Outcome 2A

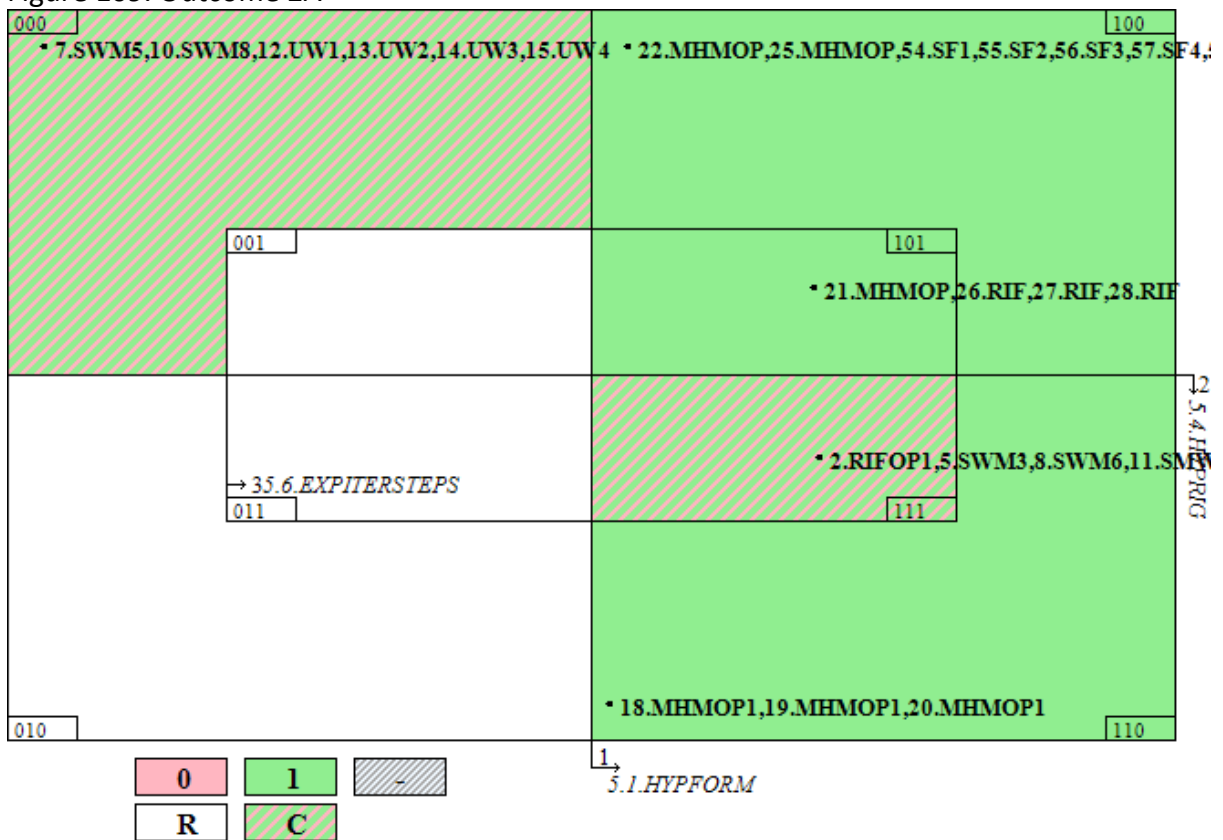

Figure 110. Outcome 2B

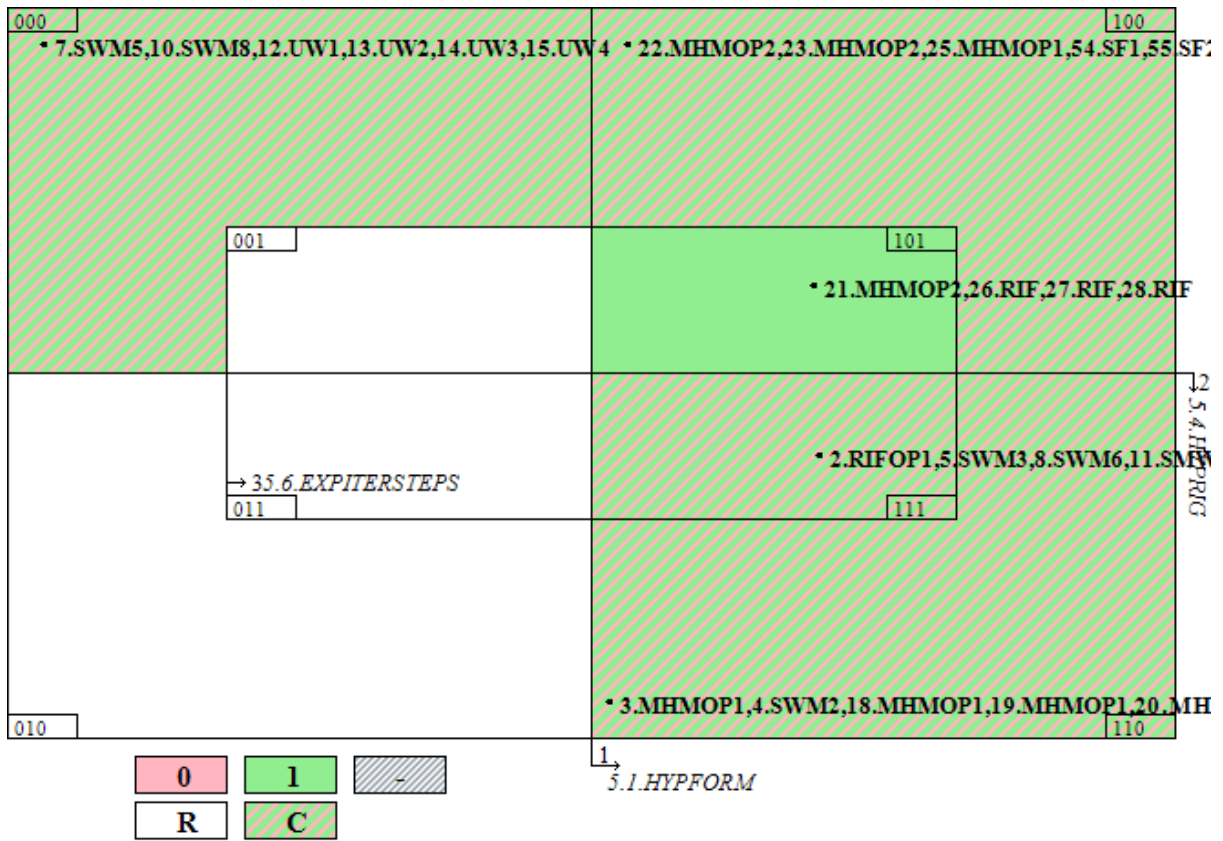
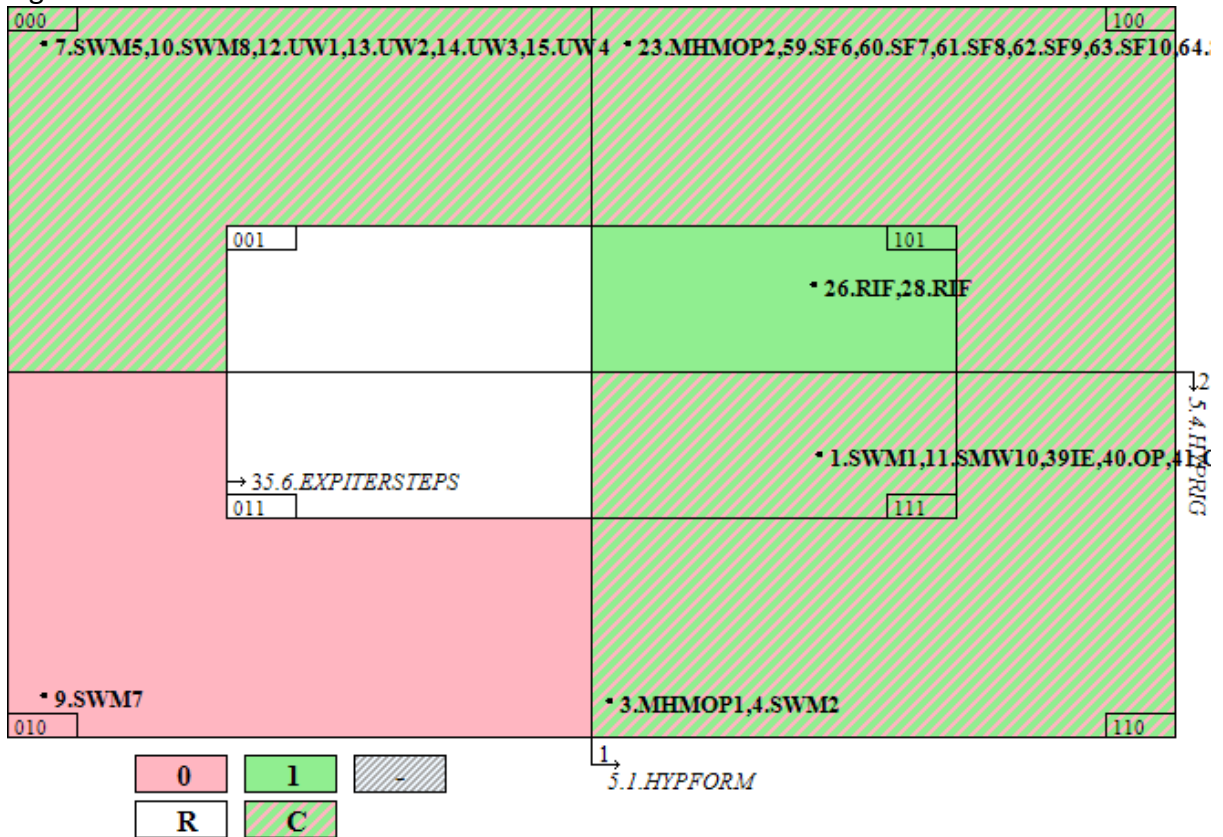

Figure 111. Outcome 3



Funding

6.2smartstrat + 6.3brokconv + 6.4reqcapinv + 6.5budgsuff =

33.0 The first two datasets are similar: the one analysed for Outcome 1 has 55 cases, all positive; the one analysed for Outcome 2A has 45 cases, of which 44 positive and one negative (11.SMW10_bag_model). The Outcome 2B dataset has 52 cases, of which 44 positive and 8 negative, while the Outcome 3 dataset has 42 cases, of which 31 positive and 11 negative.

No condition is strictly necessary for the first three outcomes, but 6.2SMARTSTRAT and 6.5BUDGSUFF are almost necessary, being present in all (positive) cases except one or two. The situation is different for Outcome 3, for which the presence of 6.5BUDGSUFF is necessary. The presence of 6.2 and 6.4 and the absence of 6.3 are almost necessary for Outcome 3, as 97% of cases with a positive Outcome 3 present 6.2 and 6.4 and do not present 6.3.

34.0 The Boolean minimisations applied to the 4-condition model returns the following findings.

34.1 The most important combination, covering 83% of cases with a positive Outcome 1 (20% uniquely); 87% of cases with a positive Outcome 2A (25% uniquely, with 97.5% consistency); 89% of cases with a positive Outcome 2B (25% uniquely with 87% consistency) is:

6.2SMARTSTRAT*6.4REQCAPINV*6.5BUDGSUFF (this is 1-11, the area on the right inside both central rectangles. Note that the consistency for Outcome 2A is 97.5%, not 100% like for Outcome 1).

If we add absence of 6.3, the combination

6.2SMARTSTRAT*6.3brokconv*6.4REQCAPINV*6.5BUDGSUFF covers 90% of cases with a positive Outcome 3, all uniquely with 87.5% consistency.

34.2 The second most important pathway, covering 75% of cases with a positive Outcome 1 and 71% for Outcome 2A (although not many uniquely) is:

6.2SMARTSTRAT*6.3brokconv*6.5BUDGSUFF (this is 10-1, the area on the top-right quadrant inside the vertical central rectangle. The consistency for Outcome 2A is 97%)

34.3 Another important pathway covers 67% of cases with a positive Outcome 1 and 66% Outcome 2A (but not many uniquely):

6.3brokconv*6.4REQCAPINV*6.5BUDGSUFF (this is -011, the top are inside both central rectangles, slightly inconsistent for Outcome 2A)

34.4 Finally, the last combination covers 65% of positive Outcome 1 cases and 66% of positive Outcome 2A or Outcome 2B cases (not many uniquely).

6.2SMARTSTRAT*6.3brokconv*6.4REQCAPINV is similar to the above in importance (this is 101-, the area in the top-right quadrant inside the horizontal central rectangle; not perfectly consistent for Outcome 2A)

Figure 112. Outcome 1

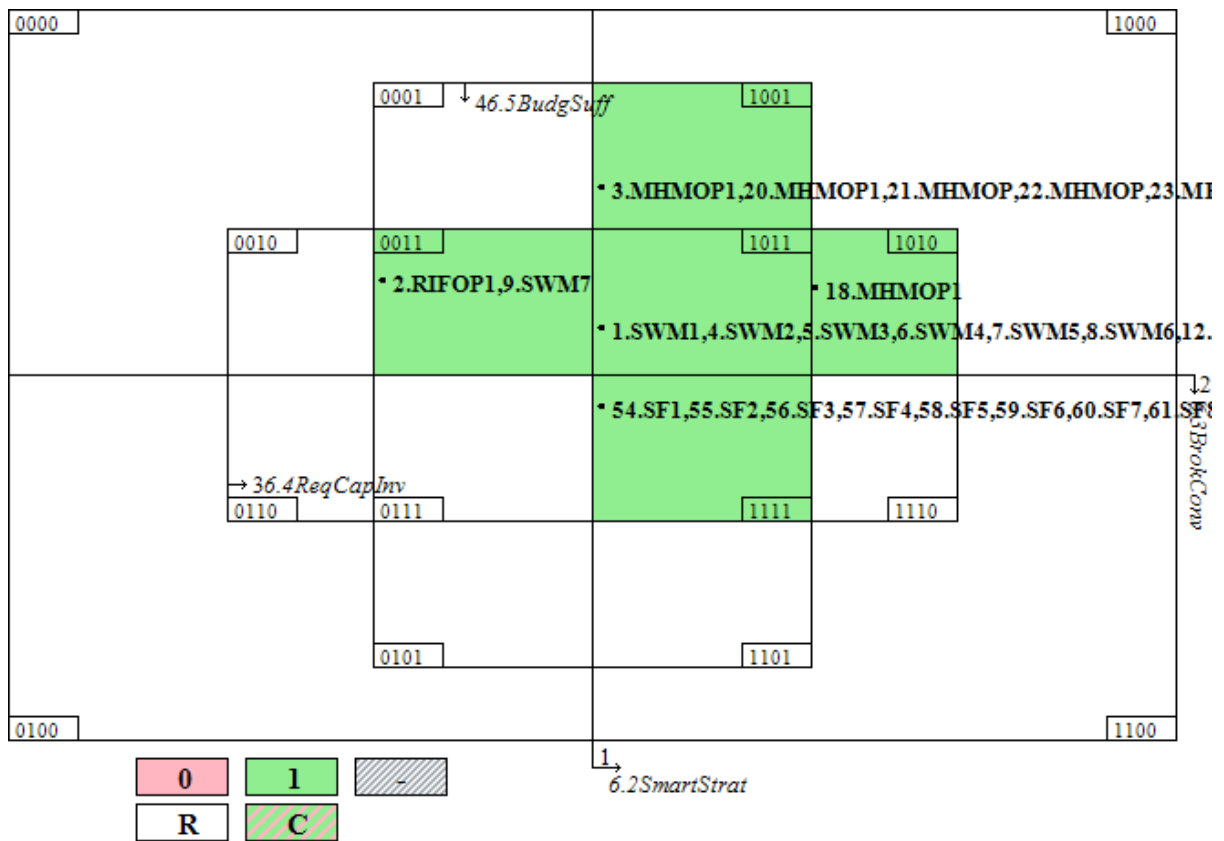

Figure 113. Outcome 2A

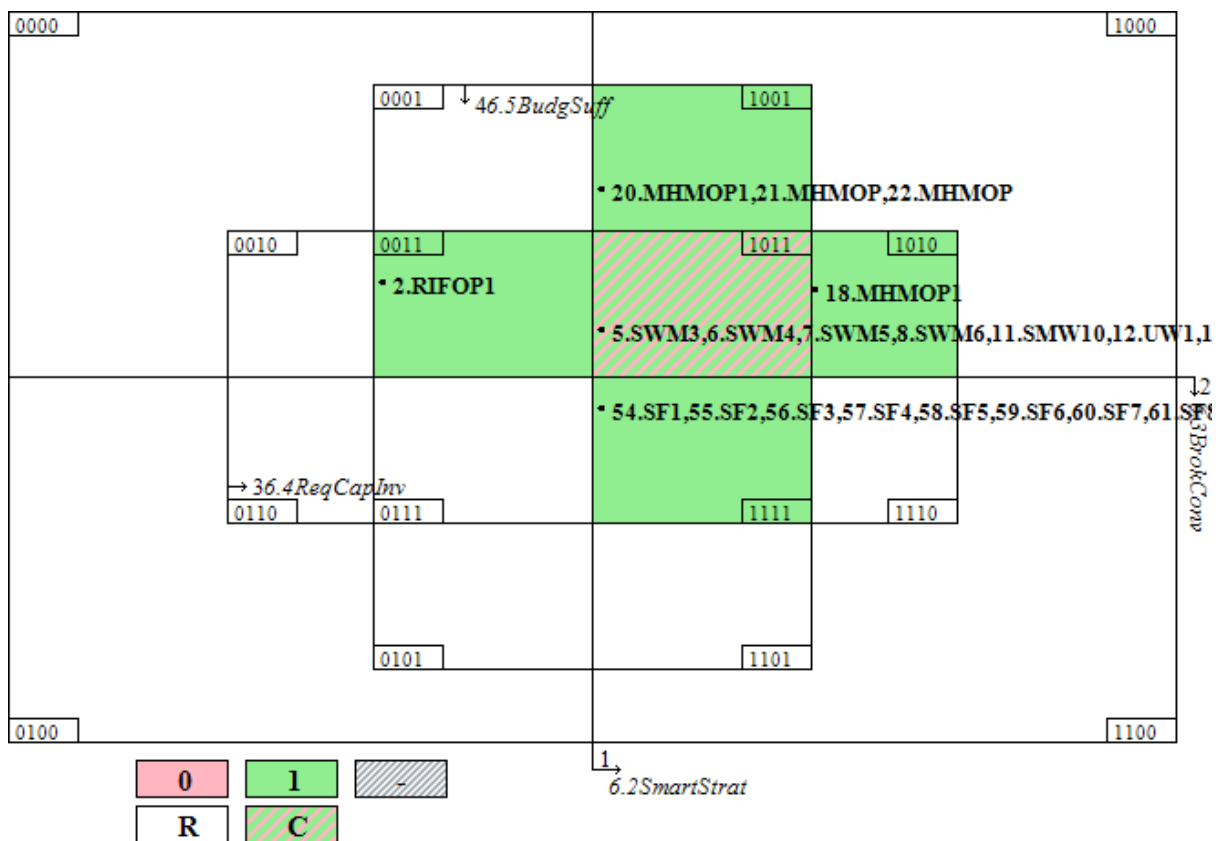

Figure 114. Outcome 2B

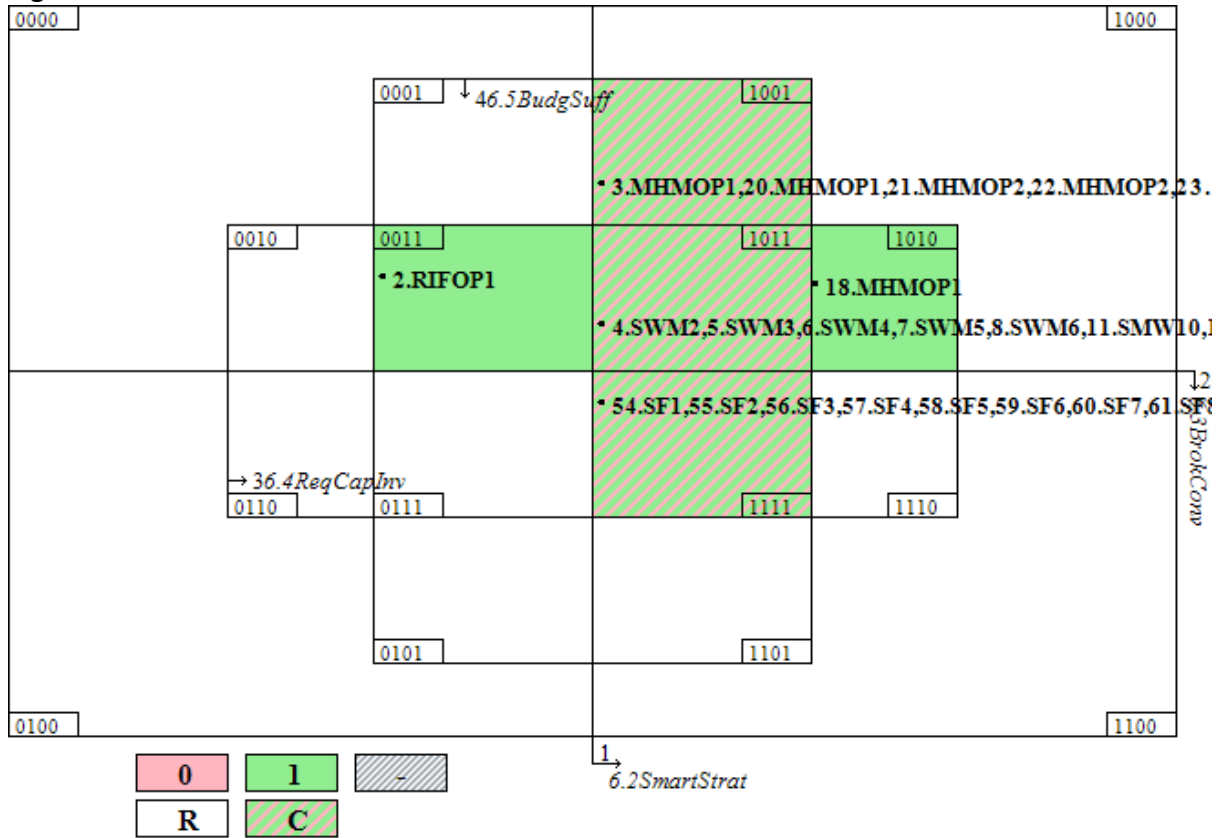
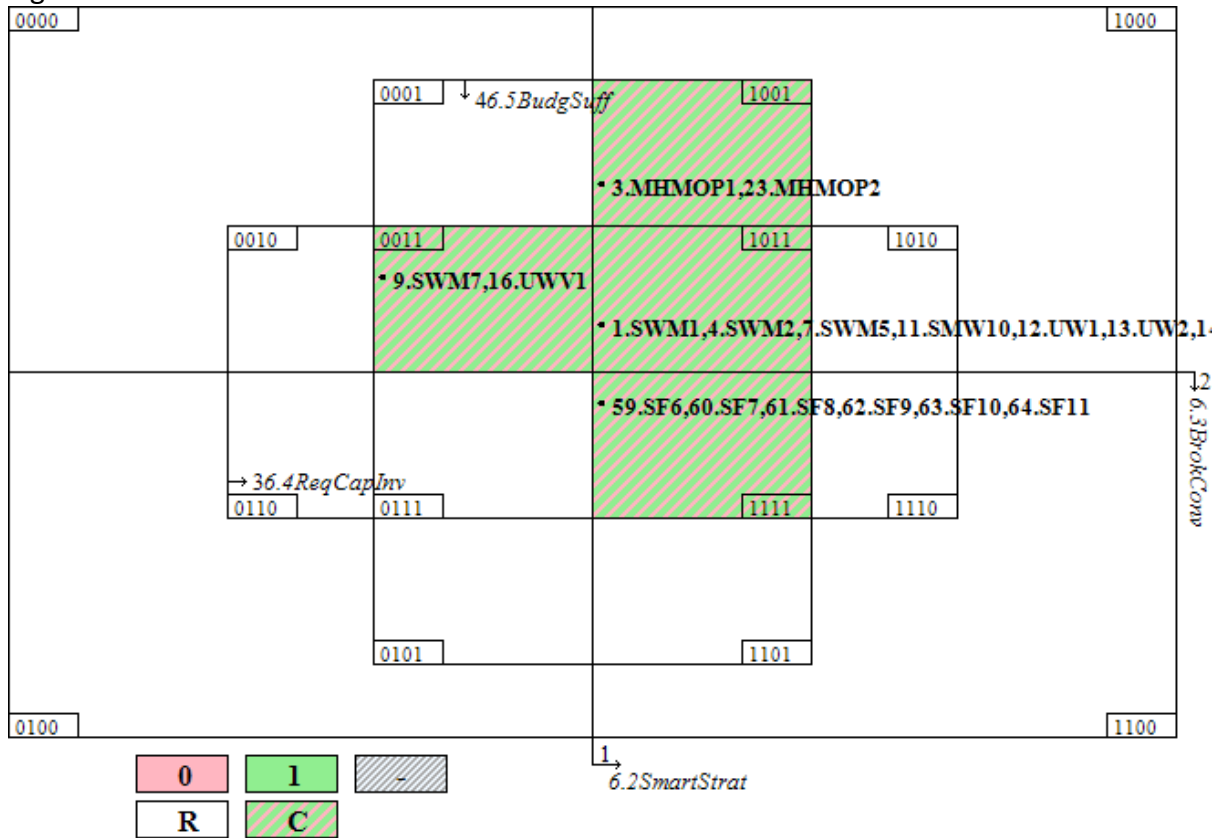

Figure 115. Outcome 3



35.0 The model 6.2smartstrat + 6.4reqcapinv + 6.5budgsuff returns the following findings (notice that all the combinations have very poor unique coverage):

6.2SMARTSTRAT*6.4REQCAPINV covers 85% of cases with a positive Outcome 1 and 91% of cases with a positive Outcome 2A or Outcome 2B (98% consistency for Outcome 2B). If we add the presence of 6.5, **6.2SMARTSTRAT*6.4REQCAPINV*6.5BUDGSUFF** covers 94% of cases with a positive Outcome 3 but consistency is only 76%.

6.4REQCAPINV*6.5BUDGSUFF covers 87% of cases with a positive Outcome 1, and 91% of cases with a positive Outcome 2A (98% consistency) or Outcome 2B (87% consistency).

6.2SMARTSTRAT*6.5BUDGSUFF covers 95% of cases with a positive Outcome 1 or Outcome 2A (98% consistency for Outcome 2A).

Figure 116. Outcome 1

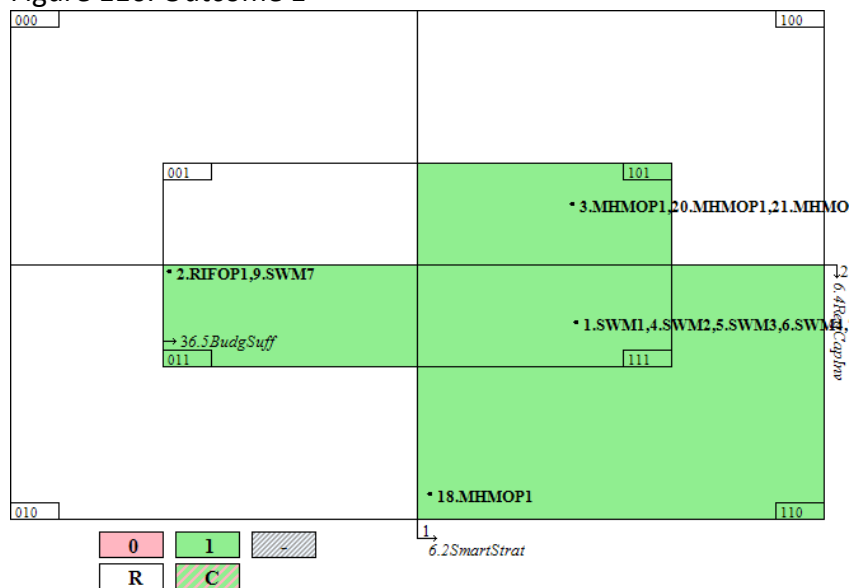

Figure 117. Outcome 2A

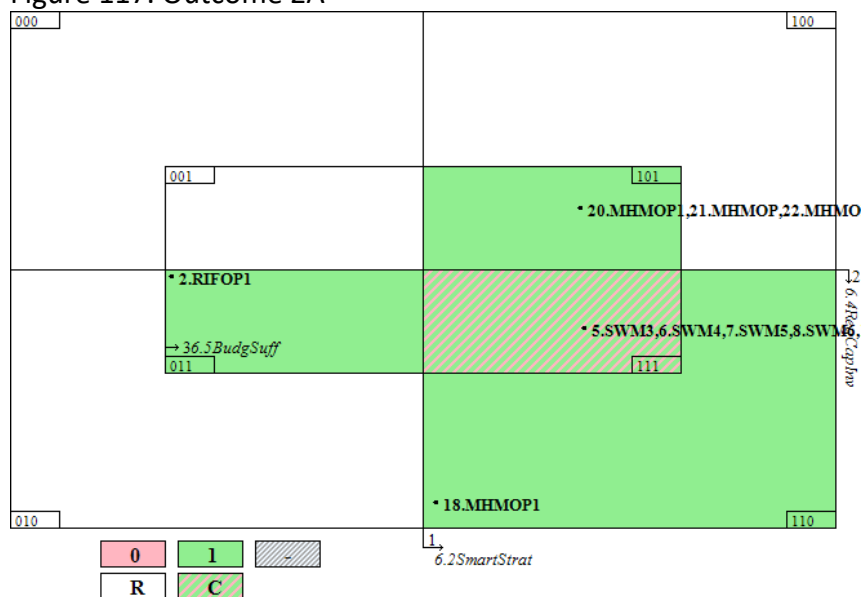

Figure 118. Outcome 2B

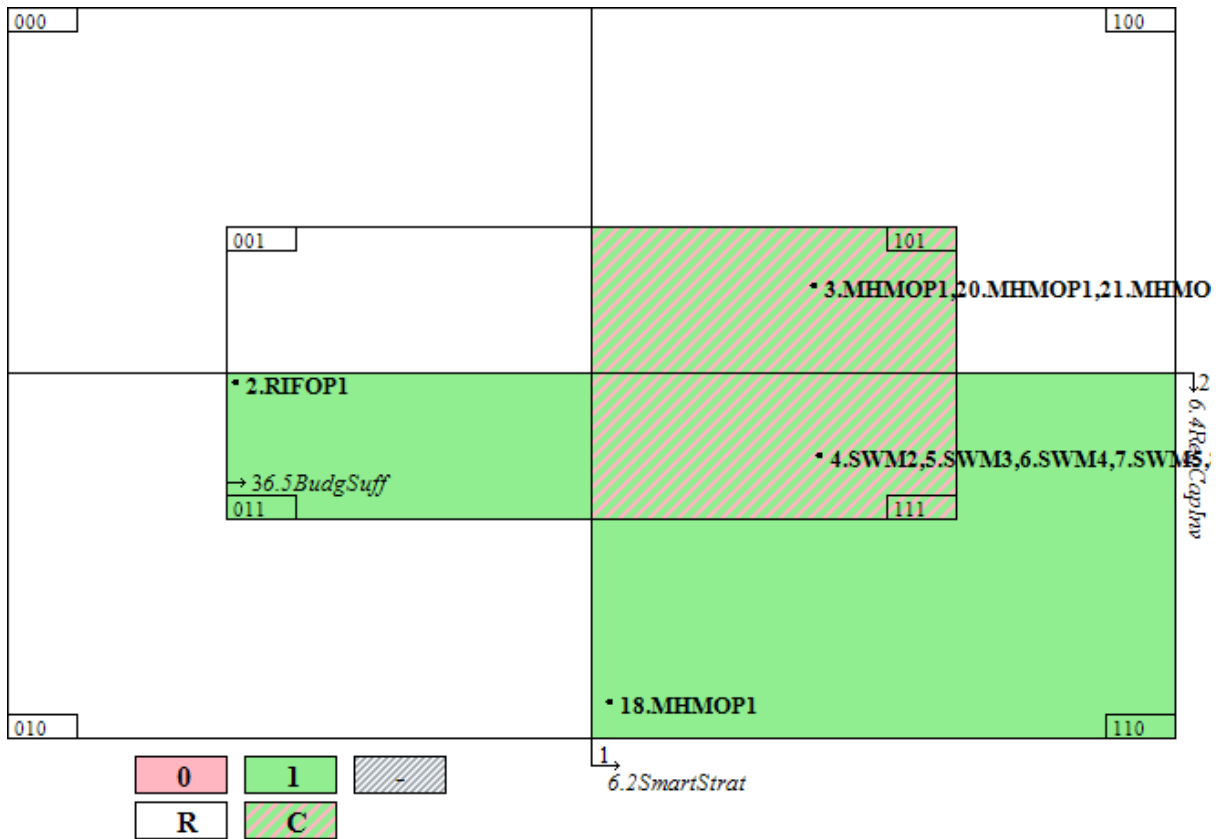
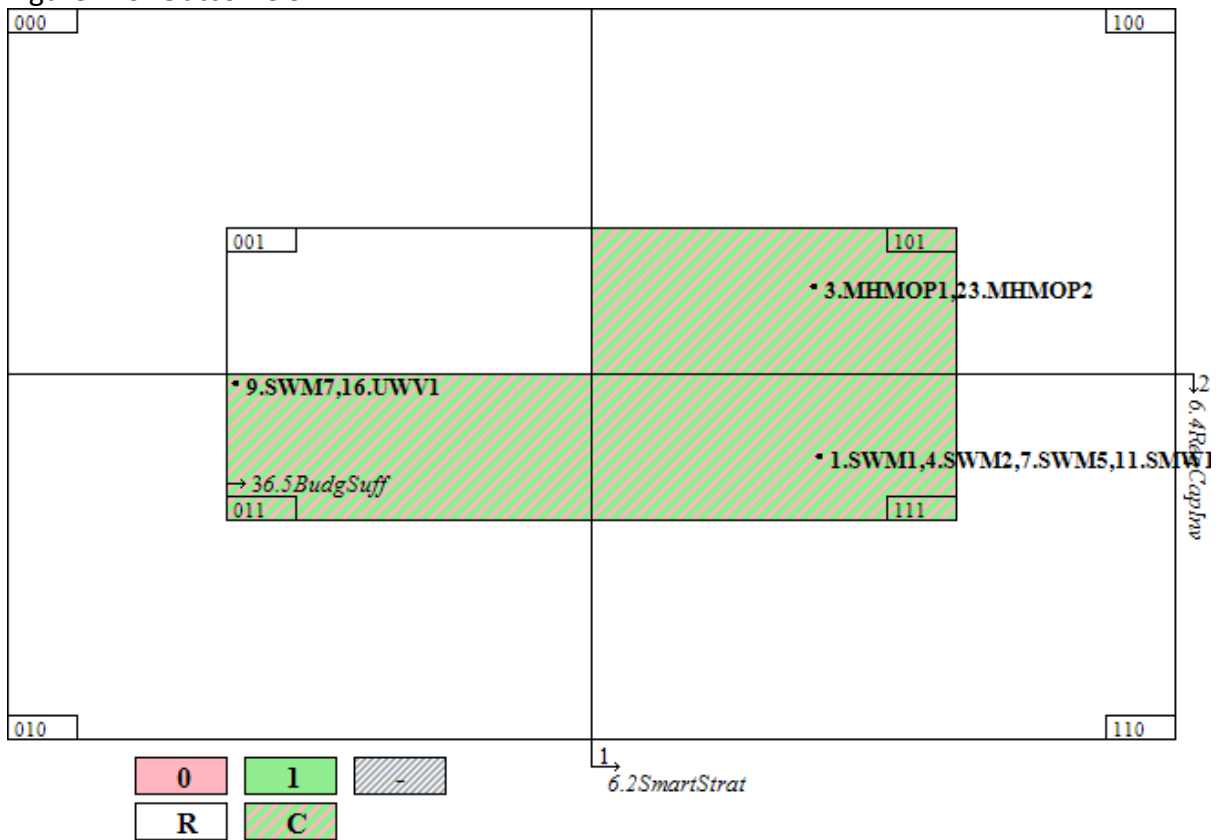

Figure 119. Outcome 3



36.0 The above test suggests that 6.2 and 6.5 have a relatively higher explanatory power than the other four conditions. The Boolean minimisation conducted on this two-condition

model returns two single conditions that cover an average of 97% of cases by themselves (although not many uniquely) and taken together as a logical union, cover all the (positive) cases of the first three outcomes:

6.2SMARTSTRAT (right area: note that consistency is 98% for Outcome 2A and 84% for Outcome 2B)

6.5BUDGSUFF (bottom area: note that consistency is 98% for Outcome 2A and 84% for Outcome 2B)

Outcome 3 is covered by their logical combination **6.2SMARTSTRAT*6.5BUDGSUFF** (the bottom-right quadrant), which covers 97% of cases with a positive Outcome 3 and has 75% consistency.

Figure 120. Outcome 1

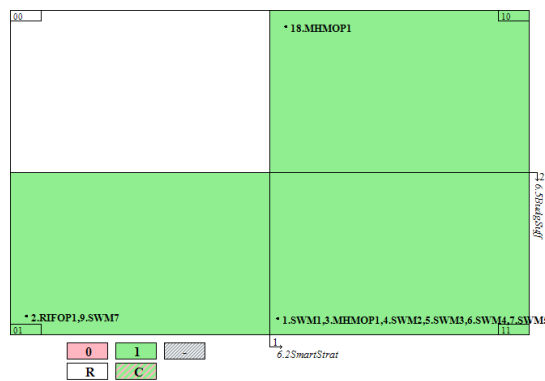

Figure 121. Outcome 2A

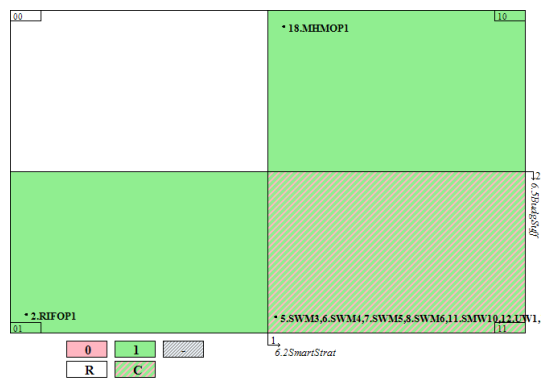

Figure 122. Outcome 2B

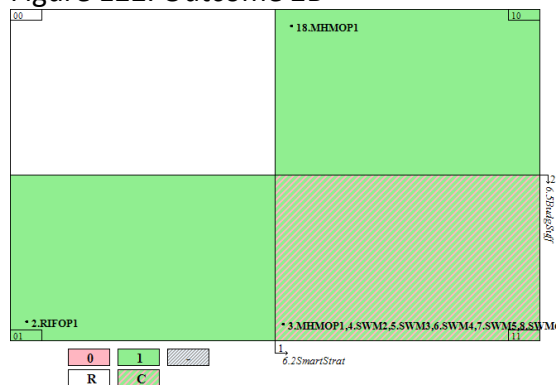
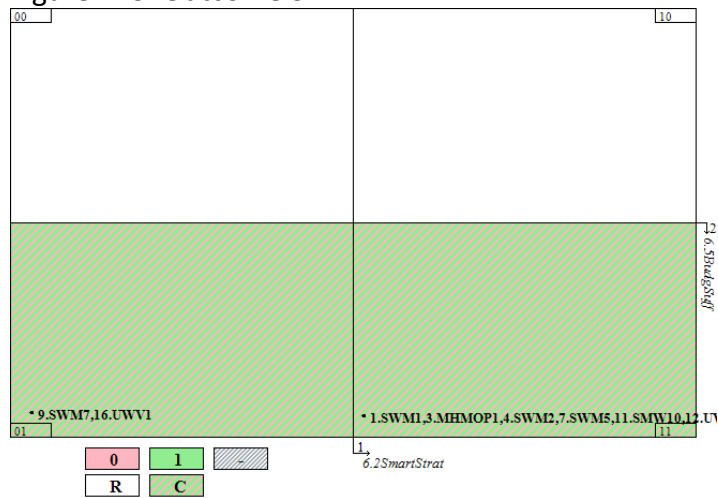

Figure 123. Outcome 3



37.0 Notice that almost all cases present 6.2 and 6.5 so removing these conditions could be interesting, to test 6.3 + 6.4. The first two outcomes can be explained by a logical union of:

6.3brokconv, which covers 80% of cases with a positive Outcome 1 (11%) and 75% of cases with a positive Outcome 2A (7% uniquely, with 97% consistency) and

6.4REQCAPINV, which covers 89% of cases with a positive Outcome 1 (20%) and 93% of cases with a positive Outcome 2A (25% uniquely, with 98% consistency). This last combination also covers 93% of cases with a positive Outcome 2B, all uniquely with 87% consistency.

37.1 The combination of those two conditions, **6.3brokconv*6.4REQCAPINV** (the bottom-left quadrant), covers 94% of cases with a positive Outcome 3 (all uniquely, with 85% consistency).

Figure 124. Outcome 1

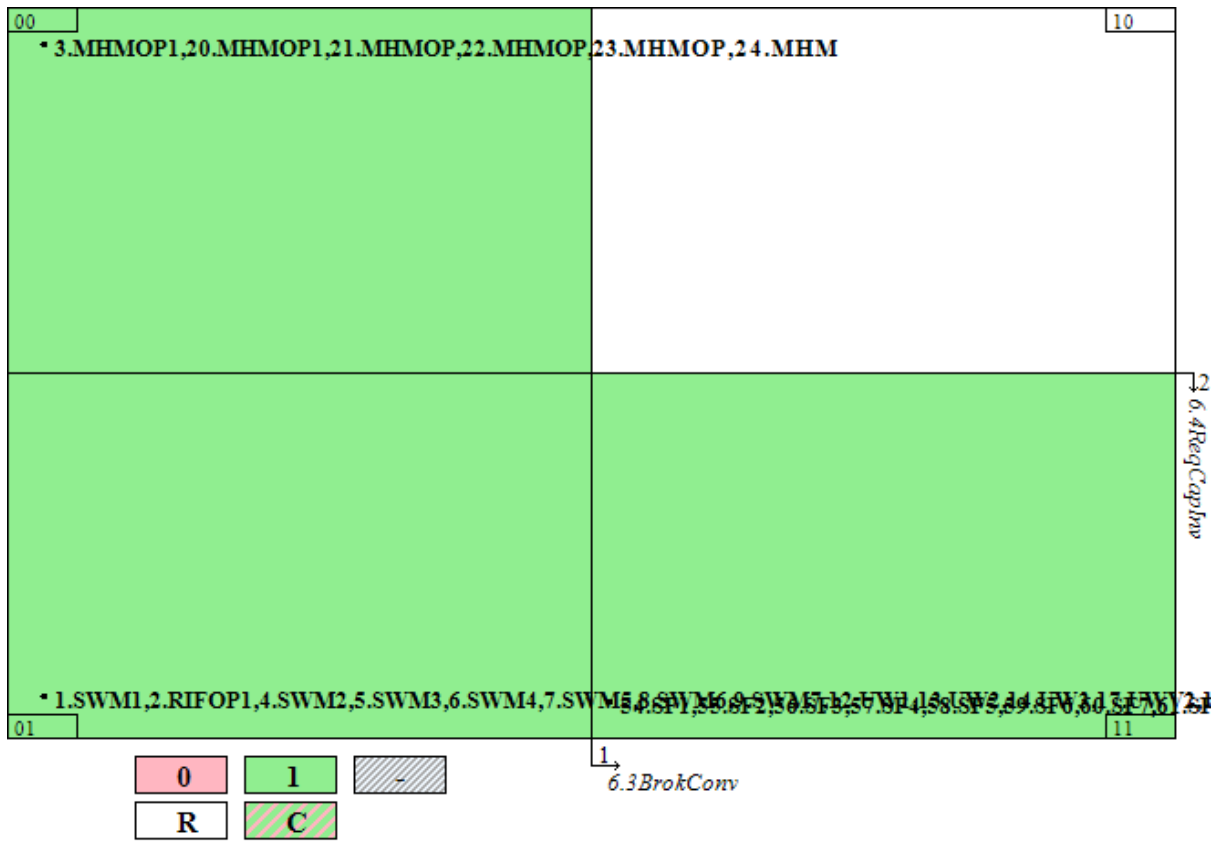

Figure 125. Outcome 2A

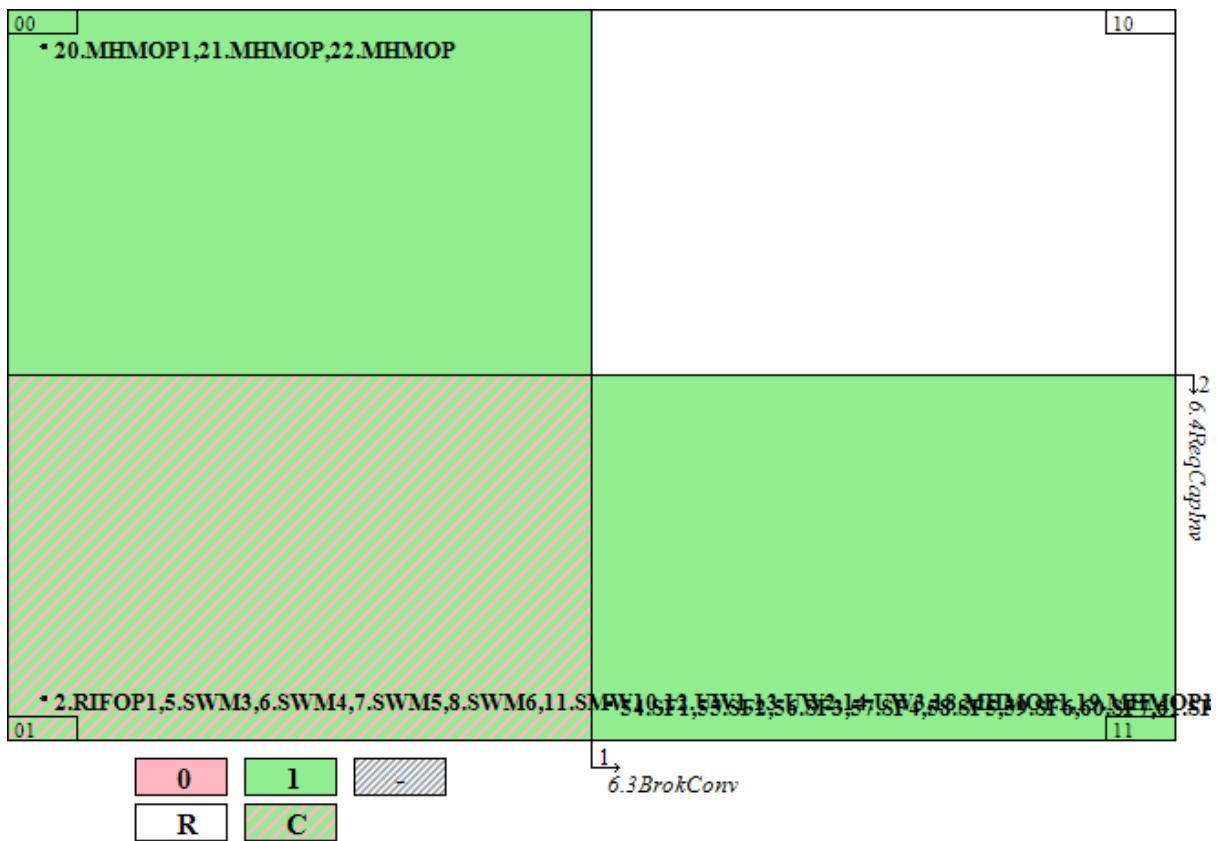

Figure 126. Outcome 2B

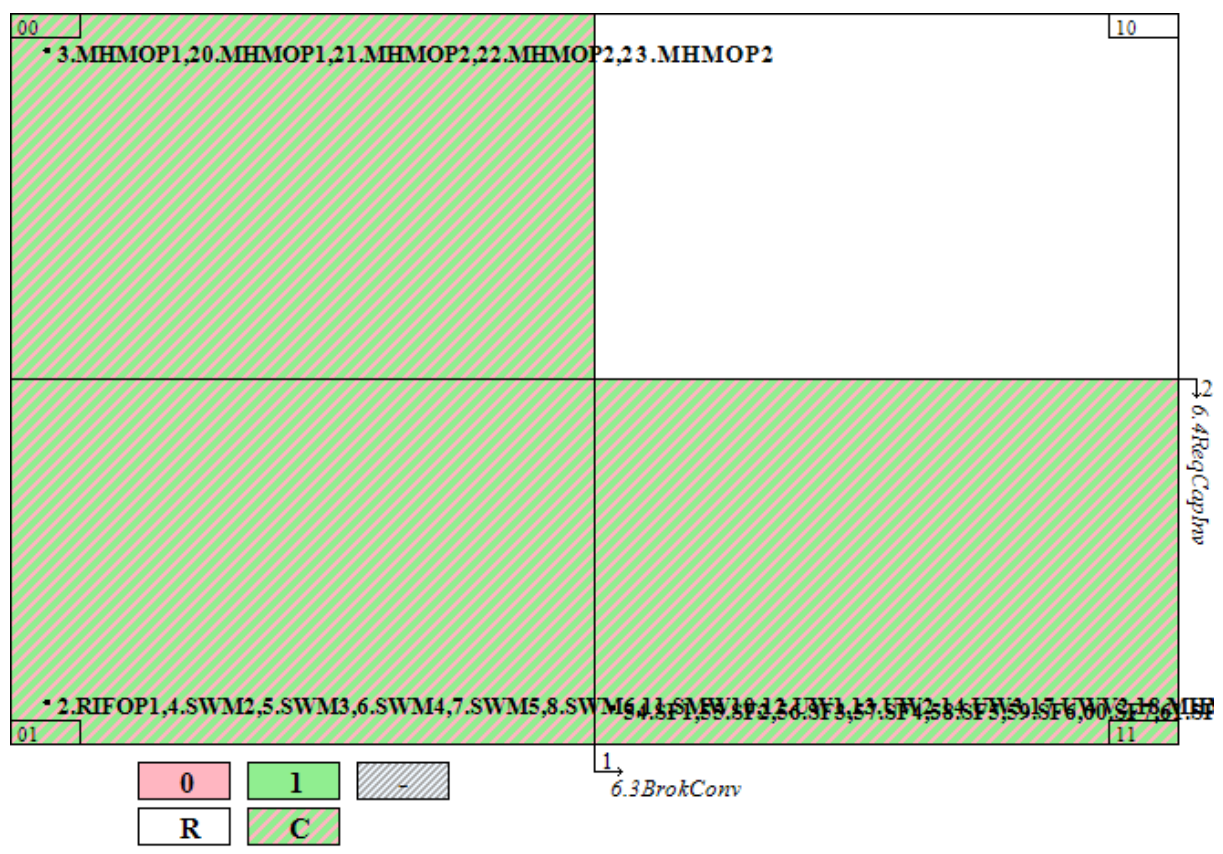
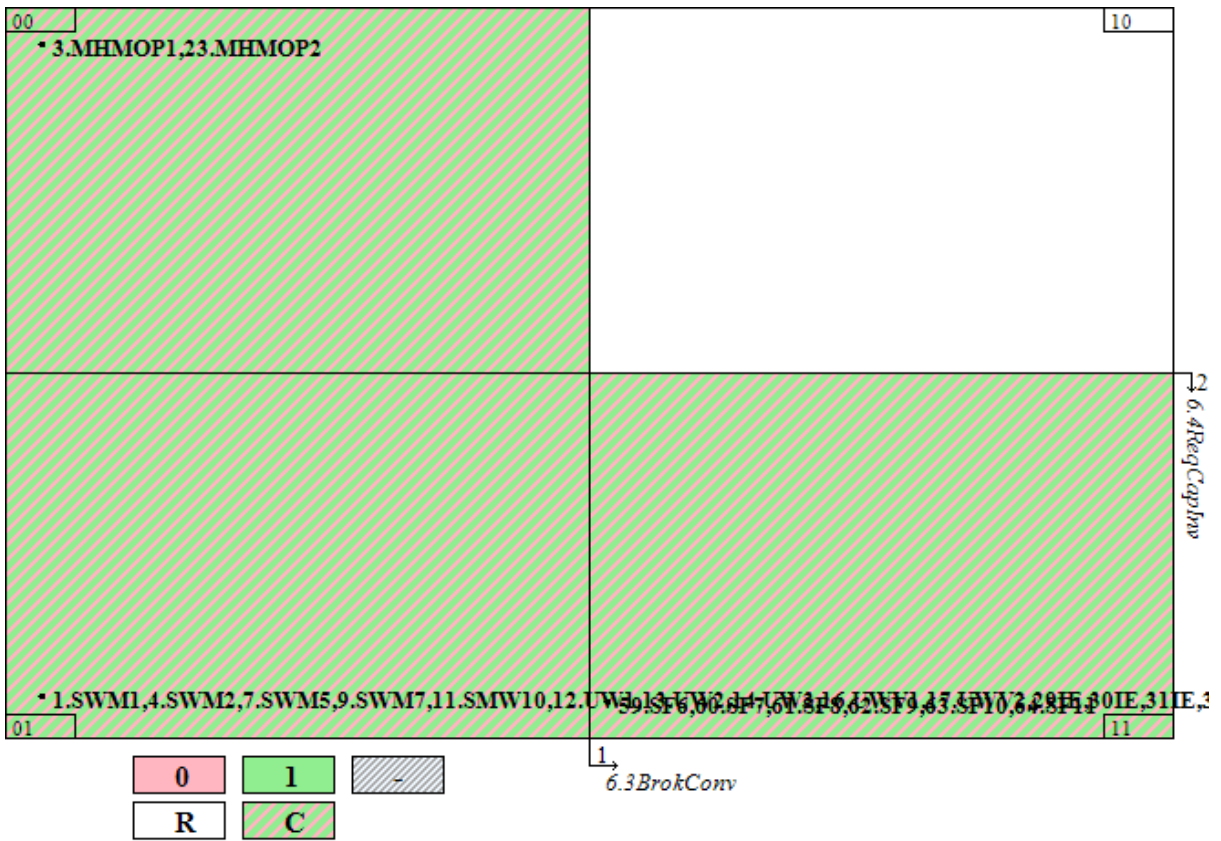

Figure 127. Outcome 3



Capacity

7.1inntech, 7.2innbeh, 7.3ftex =

38.0 The Boolean minimisations applied to the 3-condition model returns the following findings.

No combination covers any case with a positive Outcome 1 or Outcome 2A uniquely, so there are plenty of options to cover the dataset. Combinations will be listed by the amount of cases they cover, in a descending order.

7.1inntech*7.3FTEX covers 45% of cases with a positive Outcome 1 and 49% of cases with a positive Outcome 2A. It's 0-1, the left area inside the central rectangle.

7.2innbeh*7.3FTEX covers 43% of cases with a positive Outcome 1 and 46% of cases with a positive Outcome 2A. It's -01, the top area of the central rectangle.

7.1INNTECHP*7.3ftex covers 36% of cases with a positive Outcome 1 and 30% of cases with a positive Outcome 2A. It's 1-0, the large area outside the central rectangle, on the right.

7.1INNTECHP*7.2innbeh covers 30% of cases with a positive Outcome 1 and 24% of cases with a positive Outcome 2A. It's 10-, the top-right quadrant.

7.2INNBEH*7.3ftex covers 25% of cases with a positive Outcome 1 and 27% of cases with a positive Outcome 2A. It's -10, the large area below and outside the central rectangle.

7.1inntech*7.2INNBEH covers 20% of cases with a positive Outcome 1 and 24% of cases with a positive Outcome 2A. It's 01-, the bottom-left quadrant.

38.1 The situation is different for the last two outcomes. Three important combinations emerge:

7.1.inntech*7.2.INN.BEH, covering 24% of cases with a positive Outcome 2B (19% uniquely) and 35% of cases with a positive Outcome 3 (all% uniquely with a consistency cutoff of 70%, 5% otherwise).

7.1.inntech*7.3.FINETUNE, covering 49% of cases with a positive Outcome 2B (43% uniquely, with 95% consistency)

7.2.inn.beh*7.3.finetune, covering 40% of cases with a positive Outcome 3 (all uniquely, 72% consistency)

38.2 The first two Venn diagrams are virtually identical. It's interesting that the two combinations that are empirically missing (and are missing from the positive cases) are those where the three conditions are all positive (111) or all negative (000).

Figure 128. OC11

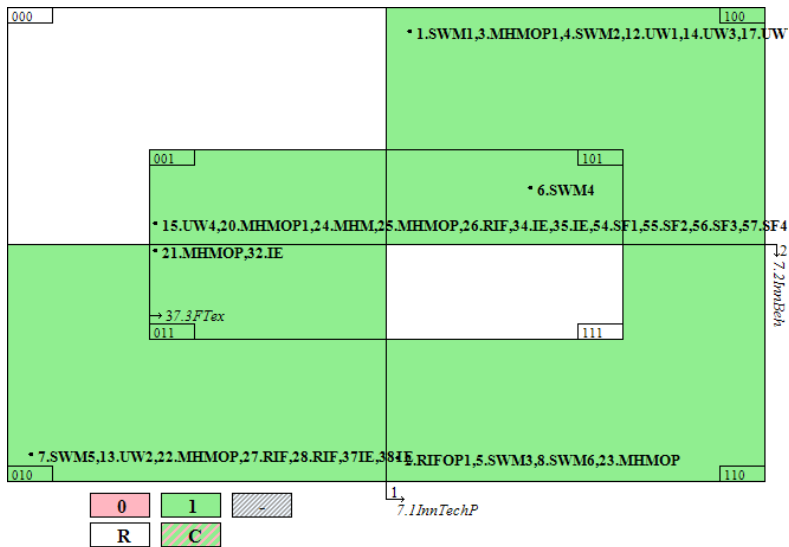
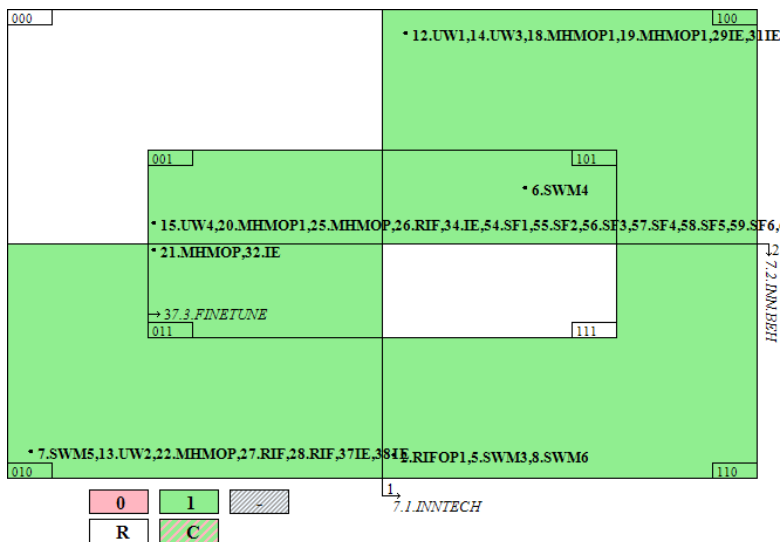

Figure 129. OC12A



39.0 Notice that the only combination that stays consistently positive across the four outcomes is **7.1.inntech*7.2.INN.BEH** or the bottom-left quadrant. The presence of the first two conditions or the bottom-right quadrant **7.1.INNTECH*7.2.INN.BEH** becomes negative for Outcome 3 – although that only concerns one case.

Figure 130. Outcome 2B

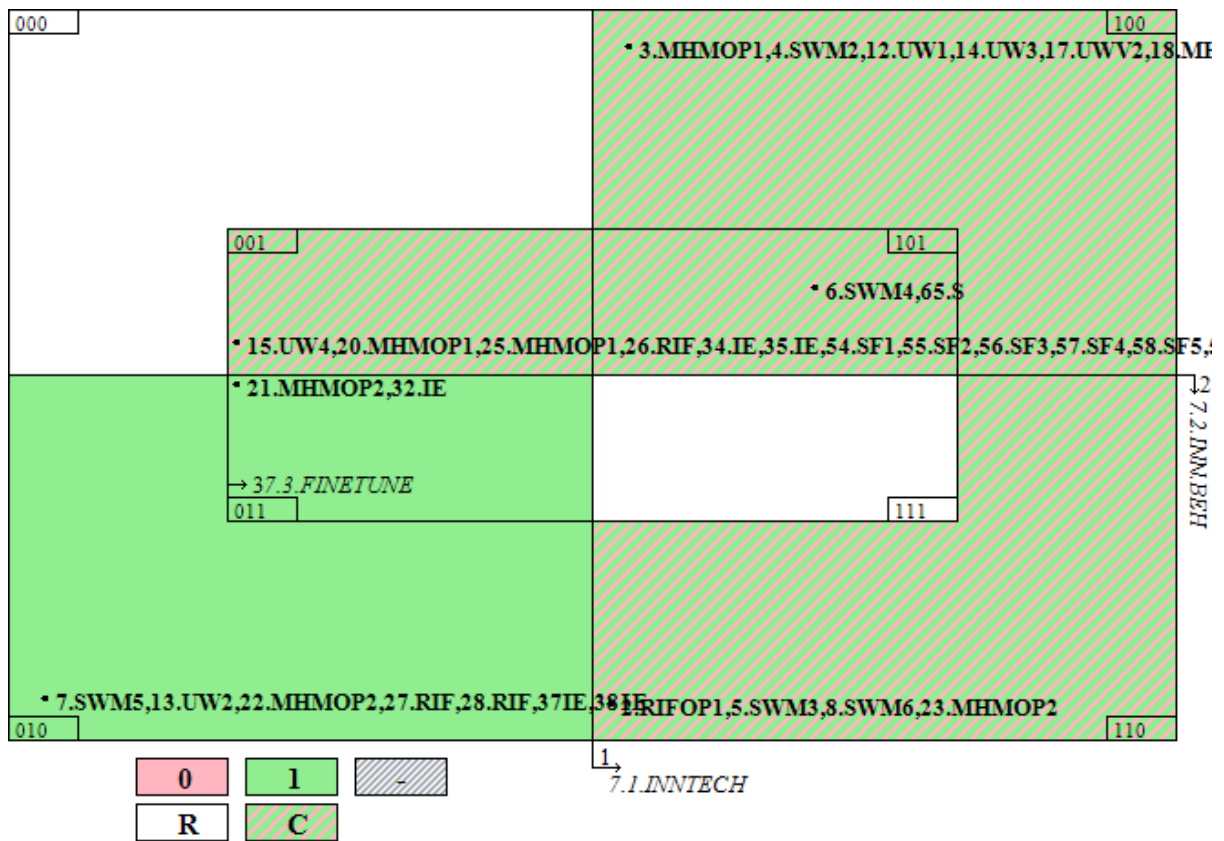

Figure 131. Outcome 3

