

Sun, Shouqiang; Su, Yumei; Yin, Chengbo; Kittisak Jernsittiparsert

Article

Optimal parameters estimation of PEMFCs model using Converged Moth Search Algorithm

Energy Reports

Provided in Cooperation with:

Elsevier

Suggested Citation: Sun, Shouqiang; Su, Yumei; Yin, Chengbo; Kittisak Jernsittiparsert (2020) : Optimal parameters estimation of PEMFCs model using Converged Moth Search Algorithm, Energy Reports, ISSN 2352-4847, Elsevier, Amsterdam, Vol. 6, pp. 1501-1509, <https://doi.org/10.1016/j.egyr.2020.06.002>

This Version is available at:

<https://hdl.handle.net/10419/244139>

Standard-Nutzungsbedingungen:

Die Dokumente auf EconStor dürfen zu eigenen wissenschaftlichen Zwecken und zum Privatgebrauch gespeichert und kopiert werden.

Sie dürfen die Dokumente nicht für öffentliche oder kommerzielle Zwecke vervielfältigen, öffentlich ausstellen, öffentlich zugänglich machen, vertreiben oder anderweitig nutzen.

Sofern die Verfasser die Dokumente unter Open-Content-Lizenzen (insbesondere CC-Lizenzen) zur Verfügung gestellt haben sollten, gelten abweichend von diesen Nutzungsbedingungen die in der dort genannten Lizenz gewährten Nutzungsrechte.

Terms of use:

Documents in EconStor may be saved and copied for your personal and scholarly purposes.

You are not to copy documents for public or commercial purposes, to exhibit the documents publicly, to make them publicly available on the internet, or to distribute or otherwise use the documents in public.

If the documents have been made available under an Open Content Licence (especially Creative Commons Licences), you may exercise further usage rights as specified in the indicated licence.



<https://creativecommons.org/licenses/by/4.0/>



Research paper

Optimal parameters estimation of PEMFCs model using Converged Moth Search Algorithm



Shouqiang Sun ^a, Yumei Su ^{b,*}, Chengbo Yin ^c, Kittisak Jermsittiparsert ^{d,*}

^a International Business School, Qingdao Huanghai University, Shandong Qingdao, 266427, China

^b School of Construction Engineering, Qingdao Huanghai University, Shandong Qingdao, 266427, China

^c College of Big Data, Qingdao Huanghai University, Shandong Qingdao, 266427, China

^d Social Research Institute, Chulalongkorn University, Bangkok 10330, Thailand

ARTICLE INFO

Article history:

Received 16 April 2020

Received in revised form 2 June 2020

Accepted 3 June 2020

Available online xxxx

Keywords:

PEMFC

A total of the squared deviations

Optimal parameter estimation

Moth Search Algorithm

ABSTRACT

One important part of designing and manufacturing of the fuel cells is their model identification. The present study proposes an optimal method for optimal parameter estimation of the undetermined parameters in Proton Exchange Membrane Fuel Cells (PEMFCs). The method uses a novel modified version of the Moth Search Algorithm, called Converged Moth Search Algorithm (CMSA) to minimize the total of the squared deviations (TSD) between the output voltage and the experimental data. The method is then applied to two different test cases including BCS 500-W PS6 and NedStack PS6. The results show that the suggested CMSA has a TSD and running time equal to 0.012 and 2.96 for BCS and 2.15 and 3.19 for the NedStack that are the minimum values for both case studies toward the other compared algorithms. therefore, the results showed that the suggested method has a good data agreement with the experimental data.

© 2020 Published by Elsevier Ltd. This is an open access article under the CC BY-NC-ND license (<http://creativecommons.org/licenses/by-nc-nd/4.0/>).

1. Introduction

With the advancement of technology and increasing the need for energy, the use of fossil fuels exponentially increased (Mirzapour et al., 2019). This reason increased the amount of carbon dioxide in the atmosphere which causes climate changes, environmental pollution, and global warming (Aghajani and Ghadimi, 2018). Energy experts believe that the process of global warming can be kept constant by up to two degrees if the use of fossil fuels is completed by 2050 (Hosseini Firouz and Ghadimi, 2016). Hydrogen is a kind of clean and renewable energy that is far healthier than fossil fuels (Leng et al., 2018). Hydrogen has always been known as an excellent and complete fuel (Fan et al., 2020). There are lots of hydrogen in the earth which are utilized as fuel (Liu et al., 2017a). The hydrogen burning is not only safe but also helpful to nature. Once hydrogen burns, it combines with oxygen and produces harmless water vapor (Gollou and Ghadimi, 2017). Of course, hydrogen is also obtained by burning fossil fuels (Hamian et al., 2018). In the future, it may be possible to use fossil fuels in such a way that we first convert them to hydrogen as a healthy and harmless fuel. In these centers, pollutants are converted into simpler and harmless substances during some

processes before they enter the air. However, hydrogen cannot be considered as a key energy source such as coal and oil, it carries clean electricity. Hydrogen can be released and converted into electricity with the help of Fuel Cell technology (Selem et al., 2020; El-Fergany et al., 2019; El-Fergany, 2017).

The fuel cell is one of the cleanest, quietest, and cheapest energy generating systems in the world. The fuel cell system contains a set of fuel cells with a supplementary system (El-Fergany, 2018; Agwa et al., 2019). This new energy system is a very interesting and up-to-date mechanism which will be replaced by fossil fuels in the near future. Fuel cell systems are rapidly growing and commercializing (Guo et al., 2020). In the recent years, due to the expansion of renewable energies and their untrustworthy features, the fuel cell technology can be considered as a good backup for increasing their robustness in such a way that once the generated energy is more than the required demand, the leftover energy is consumed for producing and storing the hydrogen and when the generated energy is less than the demand value, the stored hydrogen is used to direct electricity generation by the fuel cells for supplying the demand. Braved on the electrolyte type, fuel cells have been divided into several types such that each type has different advantages and disadvantages (Mekhilef et al., 2012). Polymer Electrolyte Membrane Fuel Cells (PEMFCs), due to their highest efficiency among different types of fuel cells and also other advantages such as low operating temperature, needing less time for the startup, high power density and lack of pollution and

* Corresponding authors.

E-mail addresses: yumieisu@126.com (Y. Su), kittisak.j@chula.ac.th (K. Jermsittiparsert).

noises, have been turned to the most interesting fuel cell in recent years (Nejad et al., 2019).

Designing of PEMFCs due to their multi-coupled and multi-variable features is a challenging and complicated task. Several research works have been performed for mathematical modeling of PEMFCs fuel cells (Chandan et al., 2013; Liu et al., 2016; Rasheed et al., 2017; Özgür and Yakaryılmaz, 2018).

Papadopoulos et al. (2014) proposed two dynamic electrical equivalent models for PEMFC based on a semi-empirical model. Besides, a model representation based on the transfer function was presented. The main idea was to determine an optimal parametric model for the PEMFC system.

Cheng et al. (2015) presented a nonlinear model of the PEMFC using NNARX. The study used a multilayer perception (MLP) to calculate the NNARX model structure. The model validation was performed based on voltage vs. current profile between the achieved model and the measured data. The final results showed a good efficiency for the achieved NNARX model.

There are also different types of model identification methods that are developed for modeling the PEMFC (Yin and Razmjoooy, 2020). However, using classic methods for optimal parameter estimation of the PEMFCs is a complicated task and has some restrictions during the process. Due to the considering all the physical concepts during the model identification based on the classic methods and ideal viewpoint of classic methods, they fail in modeling some nonlinear complicated models, particularly in the real-time uses. Besides, to develop the model accuracy to obtain an efficient model for the PEMFC, it is significant to achieve the best parameter values. In recent years, the use of metaheuristics in solving optimization problems has been increasingly accelerated. Metaheuristics have different types that most of them inspired by nature (Razmjoooy and Ramezani, 2014). There are different research works about using metaheuristic methods in model parameters identification of PEMFCs. For example, differential evolution algorithm (Sun et al., 2015), Multi-verse optimizer (Fathy and Rezk, 2018), particle swarm optimization (Li et al., 2010), dragonfly algorithm (Hamal et al., 2018), and Genetic algorithm (Ariza et al., 2018). Some of these works are given in the following. Fathy et al. (2020) presented a combined method using a vortex search algorithm for the optimal selection of the PEMFC parameters. The purpose was to minimize the sum of square error between the achieved and the experimental data. The proposed design was then applied to two 250 W and 500 W practical PEMFC stacks to indicate the method's efficiency. Final results showed that the efficiency of the suggested method against the others.

Yu et al. (2019) developed an optimal PEMFC model identification using a modified and optimized Elman neural network. The method was a combination of the advantages of the Fluid Search Optimization (FSO) algorithm and the World Cup Optimization (WCO) algorithm. The method was validated based on various operational conditions and its results were compared with some well-known methods to specify its higher efficiency.

Cao et al. (2019) presented a model using a seagull optimization algorithm for the optimal selection of undetermined parameters of a PEMFC model. Lévy flight mechanism was employed to improve the convergence speed of the algorithm. The method was then verified based on two practical PEMFC models and for more analysis, different operational conditions were studied. The method results were finally compared with some well-known techniques to indicate the method of effectiveness toward the other methods.

Rao et al. (2019) proposed a modified shark smell optimizer (SSO) for parameter estimation of a PEMFC. The suggested method was then compared with some different techniques. The final results indicated that the presented method had the

leading results among the analyzed methods. The method was then performed to two practical PEMFC models to indicate the method efficiency. As it is clear from the literature, adopting metaheuristics gives better results for the PEMFC model estimation which is due to their high ability in escaping from the local minimum that leads to a global optimum (Yu and Ghadimi, 2019). Based on the above explanation and motivation, although metaheuristics are widely used in PEMFCs, there is still lots of potential for improving the model estimation. The main purpose of this study is to use a newly developed method for parameter estimation of the PEMFCs based on the Moth Search Algorithm. The fitness function is the total of the squared deviations (TSD) between the output voltage and the experimental data. The main contributions of the paper have been addressed in the following:

- A new optimal method is provided for parameter estimation of PEMFCs.
- The idea is to minimize the total of the squared deviations between actual and estimated data.
- The minimization is applied by a new Converged Moth Search Algorithm
- The results are verified by two test cases.
- The efficiency of the new algorithm is compared with some other works from the literature

The next sections of the paper have been explained in the following. In Section 2, the main materials and methods including the mathematical model of the PEMFC, the main objective function, and the proposed Converged Moth Search Algorithm are represented. Section 3 shows the results of applying the proposed method on two different case studies, and Section 4 indicates the conclusions of the paper.

2. Materials and methods

2.1. The mathematical definition of PEMFCs

Fuel cell modeling develops the design and construction of fuel cells by considering the lower cost for construction, better, enhances the fuel performance, and can greatly help develop fuel cells. Models must be strong and accurate and able to faster solving of the fuel cell model identification problems. A good model should predict fuel cell efficiency during a wide range of fuel cell operating conditions. Even a medium fuel cell model has a lot of predictive power (Liu et al., 2017b). The PEMFCs contains three main parts, a cathode, an anode, and an electrolyte in the middle of them. In the anode side of PEMFC, a reaction between hydrogen and a catalyst results in a positive ion and a negative electron. In the electrode, protons move through the electrons to make current (Akbari et al., 2019). In the cathode side, oxygen reacts with positive and negative ions which result in water and heat. The mathematical model for electrochemical reactions over the anode and the cathode in the PEMFC is defined in the following equation (Cao et al., 2019):

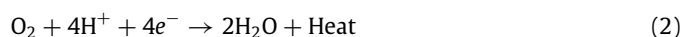

And, the general reaction for the PEMFC is obtained as follows:



During the voltage generation, the current vs. voltage polarization profile for a PEMFC decreases with high speed due to the activation voltage losses (Ebrahimian et al., 2018). Afterward, the profile has been dropped slowly due to the Ohmic resistive voltage losses. Then, diffusion over-potential loss drops the profile with high loading conditions. By considering the aforementioned

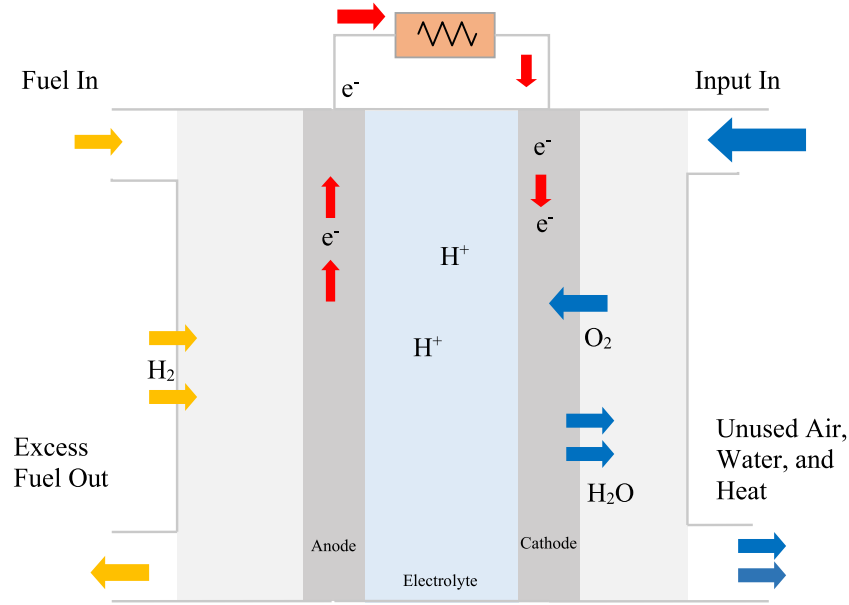

Fig. 1. The general structure of the PEMFC.

explanations, the mathematical model for the output voltage in PEMFC is achieved as follows (Khodaei et al., 2018; Bagal et al., 2018):

$$E = E_N - E_{cons} - E_{act} - E_{\Omega} \quad (4)$$

where, E_N defines the Nernst voltage, E_{cons} stands for the concentration voltage drop, E_{act} describes the activation voltage drop, and E_{Ω} represents the Ohmic voltage drop (Gheydi et al., 2016).

Due to the low value of the PEMFC output voltage (between 0.9 and 1.23) because of irreversibility losses and entropy, numerous numbers of them are combined, i.e.

$$V_t = N_{cell} \times E \quad (5)$$

where, N_{cell} stands for the number of combined cells. Fig. 1 shows the main architecture of the PEMFC.

By considering Eq. (4), the mathematical model for Nernst voltage during the temperatures less than 100 °C is achieved as follows (Ye et al., 2020):

$$E_N = 1.23 - 85 \times 10^{-5}(T_{PEM} - 298.15) + 4.31 \times 10^{-5}T_{PEM} \ln(P_{H_2} \sqrt{P_{O_2}}) \quad (6)$$

where,

$$P_{O_2} = R_{hc} \times P_{H_2O} \left[\frac{1}{\frac{R_{hc} \times P_{H_2O}}{P_c} \times e^{\frac{1.635I_{PEM}/A}{T_{PEM}^{1.334}}} - 1} \right] \quad (7)$$

$$P_{H_2} = \frac{R_{ha} \times P_{H_2O}}{2} \left[\frac{1}{\frac{R_{ha} \times P_{H_2O}}{P_a} \times e^{\frac{1.635I_{PEM}/A}{T_{PEM}^{1.334}}} - 1} \right] \quad (8)$$

$$P_{H_2O} = 29.5 \times 10^{-3}T_c - 91.81 \times 10^{-6}T_c^2 + 14.4 \times 10^{-8}T_c^3 - 2.18 \quad (9)$$

$$T_c = T_{PEM} - 273.15 \quad (10)$$

where, T_{PEM} represents the operating cell temperature with 25 °C reference temperature in the operating variations, P_a and P_c define the inlet pressures for anode and cathode, R_{hc} and R_{ha} are the

vapor relative humidity at anode and cathode, respectively, and P_{O_2} , P_{H_2} , and P_{H_2O} are the partial pressure of the O_2 , H_2 , and H_2O , respectively. The mathematical model of the Ohmic voltage drop (E_{Ω}) is achieved as follows:

$$E_{\Omega} = I_{PEM} \times (R_m + R_c) \quad (11)$$

where R_m and R_c describe the membrane resistance and the resistance of the connections.

$$R_m = \frac{\rho_m \times l}{A} \quad (12)$$

$$\rho_m = \frac{181.6 \times \left[1 + 0.03\left(\frac{I_{PEM}}{A}\right) + 0.062 \times \left(\frac{T_{PEM}}{303}\right)^2 \times \left(\frac{I_{PEM}}{A}\right)^{2.5} \right]}{\left[\lambda - 0.634 - 3\left(\frac{I_{PEM}}{A}\right) \right] \times e^{4.18 \times \frac{T_{PEM} - 303}{T_{PEM}}} } \quad (13)$$

where λ represents the adjustable parameter, ρ_m defines the membrane resistivity, l describes the membrane thickness, A describes the membrane surface (cm^2), and I_{PEM} represents the operating current for the PEMFC. Besides, based on the activation voltage drop is achieved by the following formula:

$$E_{act} = -\left[\beta_1 + \beta_2 \times T_{PEM} + \beta_3 \times T_{PEM} \times \ln(C_{O_2}) + \beta_4 \times T_{PEM} \times \ln(I_{PEM}) \right] \quad (14)$$

where β_i describes the empirical coefficients,

$$C_{O_2} = \frac{P_{O_2}}{50.8 \times 10^5} \times e^{\frac{498}{T_{PEM}}} \quad (15)$$

$$C_{H_2} = \frac{P_{H_2}}{10.9 \times 10^5} \times e^{-\frac{77}{T_{PEM}}} \quad (16)$$

where C_{H_2} and C_{O_2} describe the concentration of hydrogen and oxygen (mol/cm^3). Accordingly, the concentration voltage drop is obtained by the following equation:

$$E_{cons} = -\beta \times \ln\left(\frac{J_{max} - J}{J_{max}}\right) \quad (17)$$

where β represents a parametric coefficient, J describes the real current density, and J_{max} is the maximum value of J .

By using the mathematical model of the PEMFC that is explained above, there are seven unknown parameters in the system model that are not given in the manufacturer's datasheet. Consequently, the best model of PEMFC will be reached once all the seven parameters including $\beta_1, \beta_2, \beta_3, \beta_4, \beta, R_c, \lambda$ obtained the best values with minimum error value between the experimental data and the estimated data.

2.2. The objective function for optimizing the PEMFC model

In this study, to present an optimal model for a PEMFC, the minimum value of the total of the squared deviations (TSD) between the output voltage and the experimental data has been considered as the cost function that is given below:

$$\min TSD(x) = \sum_{i=1}^N (V_T - V_{est})^2 \quad (18)$$

where, N defines the estimation data, and $x = [x_1, x_2, x_3, x_4, x_5, x_6, x_7] = [\beta_1, \beta_2, \beta_3, \beta_4, \beta, R_c, \lambda]$ includes the optimization variables such that (Liu et al., 2020):

$$\begin{aligned} \beta_{\min} &\leq \beta \leq \beta_{\max} \\ \lambda_{\min} &\leq \lambda \leq \lambda_{\max} \\ R_{c,\min} &\leq R_c \leq R_{c,\max} \\ \beta_{i,\min} &\leq \beta_i \leq \beta_{i,\max}, \forall i = 1, 3, 4 \end{aligned} \quad (19)$$

where, β_{\min} and β_{\max} describe the lower and the higher ranges of the model parameters, λ_{\min} and λ_{\max} define the lower and the higher ranges for the water content, $R_{c,\min}$ and $R_{c,\max}$ are the lower and the higher ranges of the cell connections resistance, and $\beta_{i,\min}$ and $\beta_{i,\max}$ define the lower and the higher ranges for the data achieved by the empirical data.

Eqs. (18) and (19) illustrate the cost function and the constraints of a PEMFC model based on TSD. To obtain a minimum value of TSD between the empirical output voltage and the output voltage, a proper optimization algorithm is required. Recently, the facility of metaheuristic algorithms for solving complicated optimization problems is getting increased such that they turned into the first option for solving the complicated identification problems (Meng et al., 2020; Cai et al., 2019). This reason leads us to propose a new modified metaheuristic method, called *Converged Moth Search Algorithm* for optimal selection of the PEMFC parameters for optimal model estimation.

2.3. Converged moth search algorithm

Optimization techniques are divided into two categories: exact methods and approximate methods. The exact methods are can find the optimal solution accurately, but often fail in solving the hard optimization problems and their execution time increases exponentially according to the dimensions of the problems. Approximate algorithms are able to find good (near-optimal) short-term solutions to difficult optimization problems (Saeedi et al., 2019). Metaheuristics are a branch of Approximate algorithms that are used to resolve two main problems of exact methods including getting stuck in the optimal local locations and premature convergence to these locations (Yu and Ghadimi, 2019). Metaheuristic algorithms provide innovative algorithms to solve these problems, i.e. metaheuristic algorithms can solve the exiting local optimal points and can be used in a wide range of issues (Razmjoooy et al., 2016). Unlike exact methods, metaheuristic methods generate appropriate solutions at an acceptable time for large-scale problems. The development and application of these methods in recent decades among researchers in various sciences such as system identification are increasing and their use

in various problems indicates the satisfaction of these methods in practice. Features of metaheuristic algorithms include general and directional logic, random search algorithms, inspiration by nature, and sensitivity to initial parameters. There are several kinds of these algorithms. Some of the new models of these algorithms are the Teaching learning based optimization (TLBO) algorithm (Sahu et al., 2016), Grass Fibrous Root Optimization Algorithm (GRA) (Akkar and Mahdi, 2017), Butterfly Optimization Algorithm (BOA) (Arora and Singh, 2019), and Krill Herd (KH) algorithm (Gandomi and Alavi, 2012).

2.3.1. Basic moth search algorithm

In recent years, Wang et al. developed a new optimization algorithm inspired by the behavior of moths including Lévy flights and Phototaxis. The method is called Moth Search Algorithm (MSA) (Wang, 2018).

One important feature of the moths is *Phototaxis behavior*. Based on this characteristic, moths have a tendency to move into the light source. several hypotheses have been presenting for explaining this phenomenon. Based on a more prominent hypothesis, the angle between the moth and the light source keeps changing, but mostly it escapes from observation due to the long distance. Besides, if a moth individual selects a local light source for navigation, the angle variations will be obvious. The moths keep flying until they achieve the best orientation to the light source. This phenomenon leads to a spiral path for flight to get closer to the light source (Callahan, 1977).

Another attractive feature of the moths is their Lévy flight due to their random flies which is modeled by a Non-Gaussian, heavy-tailed statistic. This model defines a class of random walks with Lévy distribution steps. By assuming closer distance between the moths and the best individual, they will fly in that area with a Lévy flight motion. This model can be defined by the following equation:

$$x_i^{t+1} = x_i^t + \beta L(s) \quad (20)$$

where i describes the moth number, t determines the current iteration, x_i^{t+1} and x_i^t are the updated and the original positions for iteration t , respectively, $L(s)$ is the Lévy flights step down, and β stands for the scale factor achieved by the following equation:

$$\beta = S_{max}/t^2 \quad (21)$$

where, S_{max} describes the max walk step.

The Lévy flight is obtained by the following equation:

$$L(s) = \frac{1}{\pi s^\alpha} \times (\alpha - 1) \times \Gamma(\alpha - 1) \times \sin\left(\frac{\pi(\alpha - 1)}{2}\right) \quad (22)$$

where s is a positive value, $\Gamma(i)$ defines the gamma function, and α is a constant equal to 1.5.

Sometimes, moth individuals with more distance from the source fly to the light source. is modeled as follows:

$$x_i^{t+1} = \gamma \times (x_i^t + \rho \times (x_{best}^t - x_i^t)) \quad (23)$$

where, x_{best}^t defines the best moth individual of the current iteration (t), ρ determines the acceleration factor, and γ is a scale factor.

There is also a different motion for the moths such that they move to a position far from the light source that is formulated by the following equation:

$$x_i^{t+1} = \gamma \times \left(x_i^t + \frac{1}{\rho} (x_{best}^t - x_i^t) \right) \quad (24)$$

where, γ is a random number represents the scale factor to develop the diversity of the population and to control the algorithm convergence speed, x_i, x_{best} , and $x_{i,new}$ define the original position, the best position, and the updated position for moth number i , respectively.

Table 1
The main information about the employed test functions.

Model	Function	Formulation	Optimal
Unimodal	Rotated high conditioned elliptic	$F_1(x) = f_1(M(x - o_1)) + F_1^*$	100
	Rotated bent cigar	$F_2(x) = f_2(M(x - o_2)) + F_2^*$	200
	Rotated discuss	$F_3(x) = f_3(M(x - o_3)) + F_3^*$	300
Multimodal	Shifted and rotated Rosenbrock	$F_4(x) = f_4\left(M\left(\frac{2.048(x - o_4)}{100}\right) + 1\right) + F_4^*$	400
	Shifted and rotated Ackley	$F_5(x) = f_5(M(x - o_5)) + F_5^*$	500

2.3.2. Converged moth search algorithm

However, the Moth Search Algorithm (MSA) has a good result in solving the optimization problems (Feng and Wang, 2018; Elaziz et al., 2019; Strumberger et al., 2018a,b), it has an important shortcoming for reaching a satisfying convergence. In this research, two developments have been proposed to modify the efficiency of the MSA to resolve the clarified shortcoming. To improve the algorithm efficiency here, two different mechanisms have been used. Using a Quasi-oppositional mechanism is one mechanism that is adopted here to speed up the algorithm’s total establishment and increasing its exploration feature. The quasi-opposite number for a considered x_i is achieved by the following equation:

$$x_i^t = rand\left(\frac{x_l^t + x_u^t}{2}, y_i^t\right) \tag{25}$$

where, x_l^t and x_u^t are the lower and the upper ranges of the x_i^t , and y_i^t describes the opposite number and is achieved by the following equation:

$$y_i^t = x_l^t + x_u^t - x_i^t \tag{26}$$

$$i = 1, 2, \dots, D \tag{27}$$

that are placed in a D-dimension search space. Indeed, the opposite number is used in the algorithm for using it as a value to compare the opposite value of an individual with itself to select the best candidate (Tizhoosh, 2005; Çelik, 2020). The other mechanism to modify the algorithm performance is to adopt chaos theory. The chaotic theory happens unpredictably in any system. This theory is utilized to increase the diversity of the population and avoidance from the local optimum (Yang et al., 2007; Rim et al., 2018). The present study adopts the logistic map mechanism as chaotic for improving algorithm efficiency. This mechanism is defined by the following equation:

$$\delta_{i,n}^{q+1} = 4\delta_{i,n}^q(1 - \delta_{i,n}^q) \tag{28}$$

where i defines the number of system generators, q represents the number of iterations, n describes the number of population, δ_n signifies the chaotic mechanism value at iteration n between 0 and 1 (Yang et al., 2007; Rim et al., 2018).

Therefore, the updated equation for the distant individuals and the position for the individuals far from the light source are reformulated as follows:

$$x_i^{t+1} = \delta_{i,n}^q \times (x_i^t + \rho \times (x_{best}^t - x_i^t)) \tag{29}$$

$$x_i^{t+1} = \delta_{i,n}^q \times \left(x_i^t + \frac{1}{\rho} (x_{best}^t - x_i^t)\right) \tag{30}$$

The flowchart diagram of the suggested CMSA is shown in Fig. 2.

The population size and the maximum number of the iteration are considered 100.

2.3.3. Algorithm validation

To verify the proposed CMSA, it is verified by five different test functions and the final results are compared with some different metaheuristics including Dragonfly Algorithm (DA) (Hamal et al.,

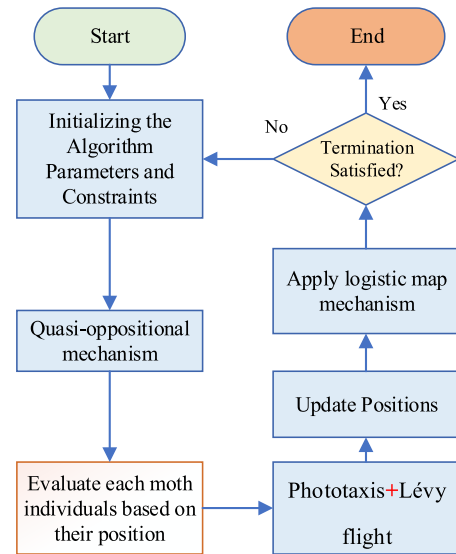

Fig. 2. The flowchart diagram of the suggested CMSA.

2018), Improved Whale Optimization Algorithm (IWOA) (Cao et al., 2020), and the basic MSA. The main information of the employed test functions is given in Table 1.

To validate the optimization algorithms, four different features of the algorithm have been analyzed including *Median* to show the median value of the test function, *std* to obtain the standard deviation value of the functions, and *minimum* and *maximum* values to obtain the minimum and the maximum values of the cost function, respectively. Table 2 indicates the comparative analysis of the algorithms.

From Table 2, it is clear that the suggested CMSA gives the optimized value among the different algorithms. The minimum value of std for the suggested CMSA also shows the robustness of the proposed method.

3. Results and discussions

For numerical simulation of the system, the model has been designed based on MATLAB Simulink environment (version R2017b) under Windows 10 Pro 64-bit operating system with a hardware configuration of a Core™ i7-4720 HQ laptop with processor 2.60 GHz CPU and 16 GB RAM. In this research, for validating the performance of the presented technique, two case studies including commercial BCS 500-W PEMFC stacks and commercial NedStack PS6 PEMFC stacks are employed. To achieve a fair study, the range of parameters value is considered as the same of parameters from the literature as follows (Priya et al., 2015):

$$0.0136 \leq \beta \leq 0.5 \tag{31}$$

$$13 \leq \lambda \leq 23$$

Table 2
The comparative analysis of the algorithms.

		CMSA	MSA	DA (Hamal et al., 2018)	IWOA (Cao et al., 2020)
F_1	Maximum	3.76E+06	6.81E+07	6.94E+06	9.82E+05
	Minimum	1.19E+05	2.37E+05	1.63E+05	4.65E+04
	Median	3.62E+05	4.82E+05	5.38E+05	4.19E+05
	std	1.39E+05	3.75E+05	3.17E+05	2.16E+05
F_2	Maximum	2.45E+03	8.34E+03	8.53E+03	4.38E+03
	Minimum	2.74E+02	4.28E+06	4.81E+02	3.71E+02
	Median	2.07E+02	4.83E+02	6.69E+02	3.16E+02
	std	2.69E+02	3.37E+06	6.88E+02	3.57E+02
F_3	Maximum	9.43E+03	13.41E+04	14.28E+03	12.37E+03
	Minimum	2.34E+02	3.31E+02	6.61E+03	4.61E+02
	Median	2.95E+02	5.48E+02	7.51E+03	4.28E+02
	std	1.07E+02	3.11E+02	3.94E+04	3.67E+02
F_4	Maximum	8.27E+01	3.67E+02	3.95E+02	2.35E+02
	Minimum	6.78E+01	2.39E+02	1.62E+02	3.30E+02
	Median	7.75E+01	2.93E+02	6.50E+02	4.01E+02
	std	7.22	4.28E+01	3.29E+01	3.57E+01
F_5	Maximum	7.95E+01	4.40E+02	6.96E+02	5.83E+02
	Minimum	9.83E+01	5.71E+02	4.19E+02	6.27E+02
	Median	8.67E+01	5.62E+02	5.77E+02	6.58E+02
	std	3.69E-05	1.40E-04	3.93E-04	6.49E-05

Table 3
The main information for BCS 500-W.

Parameter	Value	Unit	Parameter	Value	Unit
N_{cells}	32	–	T_{PEM}	59.85	°C
A	64	cm ²	P_{O_2}	0.2075	atm
L	178	μm	P_{H_2}	1	atm
J_{max}	0.469	A/cm ²			

$$0.1 \text{ m}\Omega \leq R_c \leq 0.8 \text{ m}\Omega$$

$$-1.12 \leq \beta_1 \leq -0.85$$

$$1E-3 \leq \beta_2 \leq 5E-3$$

$$3.6E-5 \leq \beta_3 \leq 9.8E-5$$

$$-2.6E-4 \leq \beta_4 \leq -9.54E-5$$

And the relative humidity values for the vapors at both anode and cathode are considered 1. The parameters of the algorithm have been obtained by trials and errors. Based on this justification, the main parameters for the algorithms are: number of kept moths at each generation is considered 2, ρ is equal to 0.62, the max walk step (S_{max}) is assumed 1, β is equal to 1.5, and the population size for all the algorithms is considered 70 with 50 independent runs for all of the algorithms.

3.1. Test case 1: BCS 500-W PEM stack

The first case is a practical PEMFC constructed by the American Company BCS Technologies (Co, 0000). The model of the PEMFC is called BCS PEMFC that has a power of 500 W with a 30 A maximum current. The general information of the model is indicated in Table 3 (Khodaei et al., 2018).

The model of BCS 500-W PEM stack has been simulated by MATLAB Simulink and the suggested CMSA is applied to minimize the total of the squared deviations between the actual data and the estimated data for optimal parameters estimation of the PEMFC. For clarification, the ability of the method has been also compared with some other methods including Dragonfly Algorithm (DA) (Hamal et al., 2018), Improved Whale Optimization Algorithm (IWOA) (Cao et al., 2020), Neural Network Algorithm (NNA), and Basic MSA. Table 4 indicates the results of the simulation.

As can be observed from Table 4, the minimum value for the total of the squared deviations is achieved by the suggested

Table 4
The results of the total of the squared deviations based on the analyzed methods for BCS 500-W PS6.

Parameter	Algorithm				
	CMSA	MSA	DA (Hamal et al., 2018)	IWOA (Cao et al., 2020)	NNA (Selem et al., 2020)
β_1	-0.785	-0.791	-0.853	-0.891	-0.847
β_2	4.50E-3	4.61E-3	3.93E-3	3.83E-3	4.27E-3
β_3	8.86E-5	8.61E-5	8.27E-5	6.82E-5	8.79E-5
β_4	-1.93E-4	-1.93E-4	-1.88E-4	-1.93E-4	-1.92E-4
λ	23.000	23.000	23.000	21.00	23.000
R_c	0.312	0.312	0.317	0.320	0.317
β	0.017	0.017	0.017	0.018	0.016
TSD	0.012	0.011	0.016	0.025	0.014
Running time	2.96	4.08	5.34	3.86	6.74

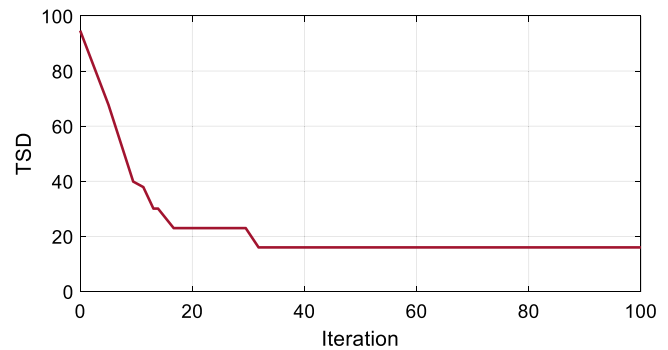

Fig. 3. The TSD value optimizing of the BCS 500-W PEMFC using CMSA.

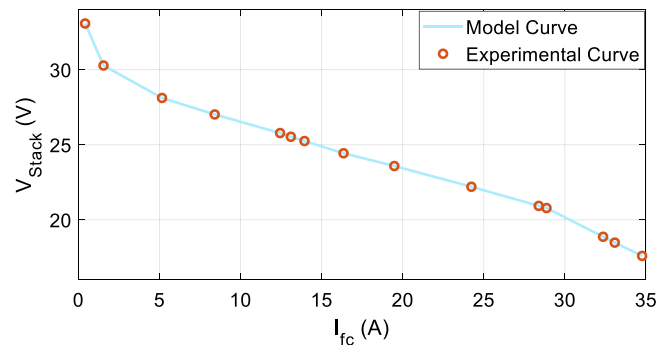

Fig. 4. The current vs. voltage profile of the experimental data of the BCS 500-W PEMFC and its estimated values based on CMSA.

CMSA, i.e. CMSA has better performance with minor TSD value toward the others during 50 independent runs. The results also show a fast running time for the improved MSA. The convergence curve of the algorithm is also shown in Fig. 3 that shows the algorithm good convergence (iteration 32) for optimizing the TSD value of the BCS 500-W PEMFC. The diagram also shows that this algorithm has a rapid decline to the minimum value of the total of the squared deviations.

The current vs. voltage profile of the experimental data of the BCS 500-W PEMFC and its estimated values based on CMSA is shown in Fig. 4. The results showed that the estimation has a high confirmation with the experimental data.

To do more analysis on the CMSA-based PEMFC identification, the current vs. voltage profile of the BCS 500-W is performed during different conditions of temperatures and pressures. Fig. 5 shows the partial pressure changes for 2.5/1.5 bar, 1.5/1 bar, and 1/0.21 bar and Fig. 6 shows the temperature variations for 99.85 °C, 59.85 °C, and 29.85 °C.

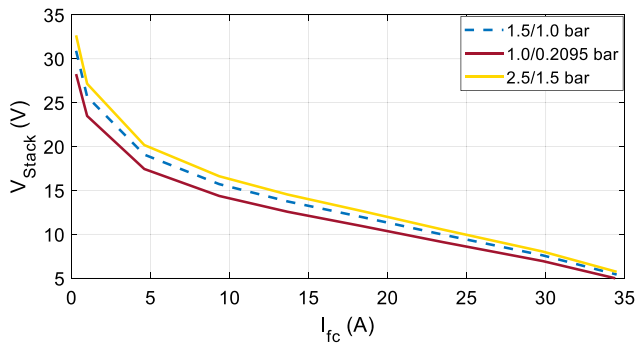

Fig. 5. The current vs. voltage profile of the BCS 500-W PEMFC with different partial pressures.

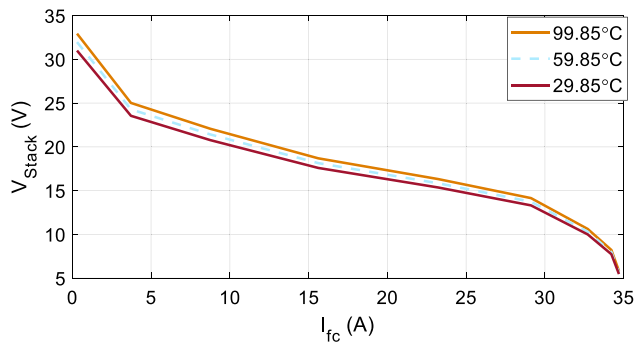

Fig. 6. Current vs. voltage profile of the BCS 500-W PEMFC with different temperatures.

Table 5
The main information for NedStack PS6.

Parameter	Value	Unit	Parameter	Value	Unit
N_{cells}	65	–	V_T	[32, 60]	V
A	240	cm^2	I_{PEM}	[0, 225]	A
L	178	μm	P	[0.5, 5]	bar
T_{PEM}	69.85	$^{\circ}\text{C}$	J_{max}	0.86	A/cm^2

From Fig. 5, it can be observed that supply pressures increasing of the $P_{\text{H}_2}/P_{\text{O}_2}$ enhances the output voltage of the stack. Fig. 6 also indicates that increasing the temperature value, increases the stack output voltage.

3.2. Test case 2: NedStack PS6 of 6 kW

The second test case is the 6 kW NedStack PS6 PEMFC model. This practical test case is used several times in different research works to validate their methods' capability. The production datasheet has been extracted from (Technology, 0000; El Monem et al., 2014). More information has been given in Table 5 (El-Hay et al., 2018).

Based on the information, the model is simulated and the seven unknown parameters have been optimized by the proposed CMSA and some other methods including Dragonfly Algorithm (DA) (Hamal et al., 2018), Improved Whale Optimization Algorithm (IWOA) (Cao et al., 2020), Developed Sunflower Optimization Algorithm (DSOA) (Yuan et al., 2020), and Basic MSA for indicating the ability of the proposed method. Table 6 indicates the results.

The results show that the minimum value for the TSD value is obtained by the suggested CMSA again. The results also show a fast running time for the improved MSA. Fig. 7 shows the convergence curve for the suggested CMSA applied to the NedS stack PS6.

Table 6
The TSD value validation for NedStack PS6.

Parameter	Algorithm				
	CMSA	MSA	DA (Hamal et al., 2018)	IWOA (Cao et al., 2020)	DSOA (Yuan et al., 2020)
β_1	−0.975	−0.927	−1.195	−1.186	−1.191
β_2	3.43E−3	3.55E−3	3.53E−3	3.29E−3	3.44E−3
β_3	7.85E−5	7.69E−5	5.32E−5	4.42E−5	5.70E−5
β_4	−9.67E−5	−9.59E−5	−9.62E−5	−9.37E−5	−9.29E−5
λ	13.00	13.00	13.00	13.010	13.00
β	0.051	0.046	0.043	0.061	0.049
R_c	0.100	0.100	0.100	0.141	0.100
TSD	2.15	2.19	2.57	2.18	2.22
Running time (s)	3.19	4.83	6.38	12.41	9.18

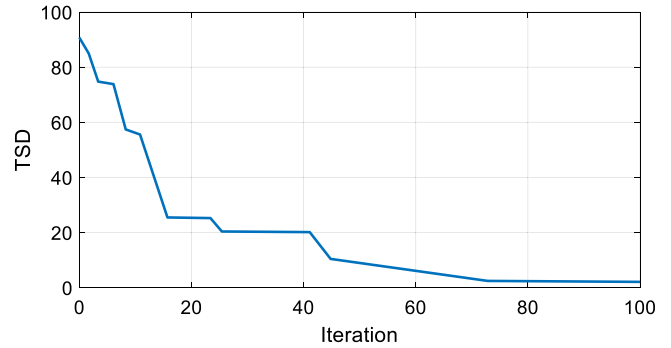

Fig. 7. The TSD value optimizing of the NedS stack PS6 PEMFC based on CMSA.

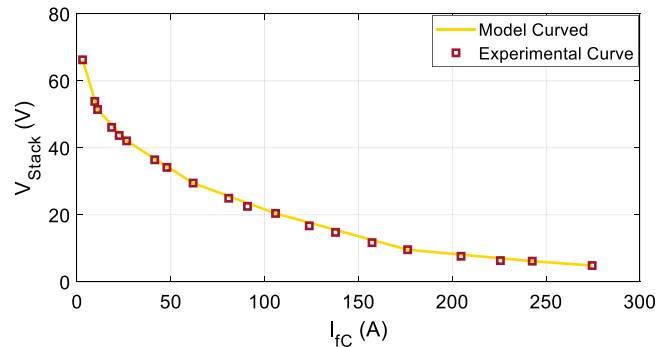

Fig. 8. The current vs. voltage profile of the experimental data of the NedS stack PS6 PEMFC and its estimated values based on CMSA.

The minimum value of the TSD among different methods is achieved by the suggested CMSA. It is observed that after only 68 iterations, the TSD reached its minimum value that indicates very fast convergence characteristic. The current vs. voltage profile of the experimental data of the NedS stack PS6 PEMFC and its estimated values based on CMSA is given in Fig. 8. As can be seen that the results of the estimation have a high confirmation with the experimental data.

As can be observed, the results of the estimation have a good confirmation with the experimental data. For more verification of the test case, it is analyzed under different temperatures and partial pressures and the voltage vs. current polarization curves in which the temperature varies with 49.85 $^{\circ}\text{C}$, 69.85 $^{\circ}\text{C}$, and 89.85 $^{\circ}\text{C}$ and the partial pressures vary with 1/1 bar, 2/1.5 bar, and to 3/2 bar. The results are shown in Figs. 9 and 10.

It is observed that increasing the supply pressures of the $P_{\text{H}_2}/P_{\text{O}_2}$ increases the stack output voltage and increasing the temperature, increases the output voltage of the stack.

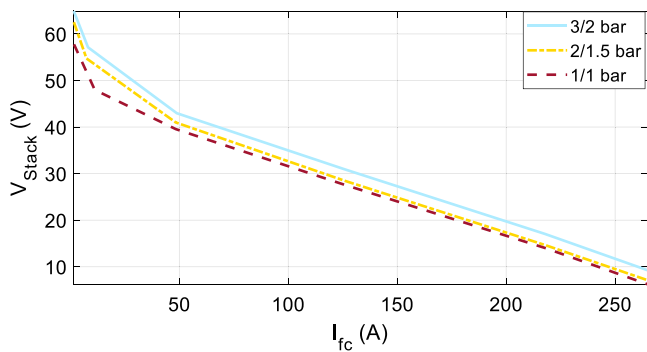

Fig. 9. The current vs. voltage profile of the NedS stack PS6 PEMFC with different partial pressures.

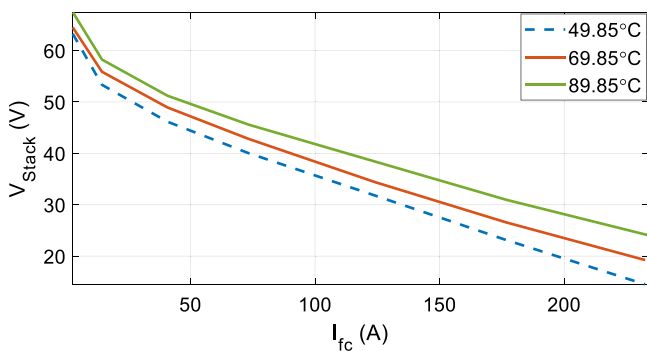

Fig. 10. The current vs. voltage profile of the NedS stack PS6 PEMFC with different temperatures.

4. Conclusions

The present paper proposes an optimal parameter estimation method for Proton exchange membrane fuel cells (PEMFCs). The idea was to minimize the total of the squared deviations (TSD) between the output voltage and the experimental data. The minimization in this paper was performed based on a new modified metaheuristic, called Converged Moth Search Algorithm. After designing the algorithm, it was performed into two experimental test cases and was compared with some well-known methods including Dragonfly Algorithm (DA), Improved Whale Optimization Algorithm (IWOA), Developed Sunflower Optimization Algorithm (DSOA), and the Basic MSA. The results indicated that the suggested CMSA has a TSD and running time equal to 0.012 and 2.96 for BCS and 2.15 and 3.19 for the NedStack which were the minimum values for both case studies toward the other compared algorithms. Final results showed higher efficiency of the suggested algorithm in finding the minimum TSD with higher convergence speed. The future work will be to optimal using of the proposed fuel cell along with a Combined Cooling, Heating, and Power (CCHP) system to design an efficient and green system power production system.

CRedit authorship contribution statement

Shouqiang Sun: Conceptualization, Data curation, Writing - original draft, Writing - review & editing. **Yumei Su:** Conceptualization, Data curation, Writing - original draft, Writing - review & editing. **Chengbo Yin:** Conceptualization, Data curation, Writing - original draft, Writing - review & editing. **Kittisak Jermsittiparsert:** Conceptualization, Data curation, Writing - original draft, Writing - review & editing.

Declaration of competing interest

The authors declare that they have no known competing financial interests or personal relationships that could have appeared to influence the work reported in this paper.

Acknowledgments

2019 Shandong province colleges and universities young talents introduction plan construction team project: big data and business intelligence social service innovation team.

References

- Aghajani, G., Ghadimi, N., 2018. Multi-objective energy management in a micro-grid. *Energy Rep.* 4, 218–225.
- Agwa, A.M., El-Fergany, A.A., Sarhan, G.M., 2019. Steady-state modeling of fuel cells based on atom search optimizer. *Energies* 12 (10), 1884.
- Akbary, Paria, et al., 2019. Extracting appropriate nodal marginal prices for all types of committed reserve. *Comput. Econ.* 53 (1), 1–26.
- Akbar, H.A., Mahdi, F.R., 2017. Grass fibrous root optimization algorithm. *Int. J. Intell. Syst. Appl.* 11 (6), 15.
- Ariza, H., Correcher, A., Sánchez, C., Pérez-Navarro, Á., García, E., 2018. Thermal and electrical parameter identification of a proton exchange membrane fuel cell using genetic algorithm. *Energies* 11 (8), 2099.
- Arora, S., Singh, S., 2019. Butterfly optimization algorithm: a novel approach for global optimization. *Soft Comput.* 23 (3), 715–734.
- Bagal, Asadi, Hamid, et al., 2018. Risk-assessment of photovoltaic-wind-battery-grid based large industrial consumer using information gap decision theory. *Sol. Energy* 169, 343–352.
- Cai, Wei, et al., 2019. Optimal bidding and offering strategies of compressed air energy storage: A hybrid robust-stochastic approach. *Renew. Energy* 143, 1–8.
- Callahan, P.S., 1977. Moth and candle: the candle flame as a sexual mimic of the coded infrared wavelengths from a moth sex scent (pheromone). *Appl. Opt.* 16 (12), 3089–3097.
- Cao, Y., Li, Y., Zhang, G., Jermsittiparsert, K., Nasser, M., 2020. An efficient terminal voltage control for PEMFC based on an improved version of whale optimization algorithm. *Energy Rep.* 6, 530–542.
- Cao, Y., et al., 2019. Experimental modeling of PEM fuel cells using a new improved seagull optimization algorithm. *Energy Rep.* 5, 1616–1625.
- Çelik, E., 2020. A powerful variant of symbiotic organisms search algorithm for global optimization. *Eng. Appl. Artif. Intell.* 87, 103294.
- Chandan, A., et al., 2013. High temperature (HT) polymer electrolyte membrane fuel cells (PEMFC)—A review. *J. Power Sources* 231, 264–278.
- Cheng, S.-J., Chang, T.-J., Tan, K.-H., Kuo, S.-L., 2015. Nonlinear modeling of the PEMFC based on NNARX approach. *World Acad. Sci. Eng. Technol. Int. J. Comput. Control Quantum Inf. Eng.* 9 (5).
- Co, B.T., 0000. Data Sheet for a 500-W FC Stack. accessed.
- Ebrahimian, Homayoun, et al., 2018. The price prediction for the energy market based on a new method. *Econ. Res.-Ekon. Istraž.* 31 (1), 313–337.
- El-Fergany, A.A., 2017. Electrical characterisation of proton exchange membrane fuel cells stack using grasshopper optimiser. *IET Renew. Power Gener.* 12 (1), 9–17.
- El-Fergany, A.A., 2018. Extracting optimal parameters of PEM fuel cells using salp swarm optimizer. *Renew. Energy* 119, 641–648.
- El-Fergany, A.A., Hasanien, H.M., Agwa, A.M., 2019. Semi-empirical PEM fuel cells model using whale optimization algorithm. *Energy Convers. Manage.* 201, 112197.
- El-Hay, E.A., El-Hameed, M.A., El-Fergany, A.A., 2018. Performance enhancement of autonomous system comprising proton exchange membrane fuel cells and switched reluctance motor. *Energy* 163, 699–711.
- El Monem, A.A., Azmy, A.M., Mahmoud, S., 2014. Effect of process parameters on the dynamic behavior of polymer electrolyte membrane fuel cells for electric vehicle applications. *Ain Shams Eng. J.* 5 (1), 75–84.
- Elaziz, M.A., Xiong, S., Jayasena, K., Li, L., 2019. Task scheduling in cloud computing based on hybrid moth search algorithm and differential evolution. *Knowl.-Based Syst.* 169, 39–52.
- Fan, H.X., et al., 2020. Multi-objective optimization for the proper selection of the best heat pump technology in a fuel cell-heat pump micro-CHP system. *Energy Rep.* 6, 325–335.
- Fathy, A., Elaziz, M.A., Alharbi, A.G., 2020. A novel approach based on hybrid vortex search algorithm and differential evolution for identifying the optimal parameters of PEM fuel cell. *Renew. Energy* 146, 1833–1845.
- Fathy, A., Rezk, H., 2018. Multi-verse optimizer for identifying the optimal parameters of PEMFC model. *Energy* 143, 634–644.
- Feng, Y.-H., Wang, G.-G., 2018. Binary moth search algorithm for discounted 0-1 knapsack problem. *IEEE Access* 6, 10708–10719.

- Gandomi, A.H., Alavi, A.H., 2012. Krill herd: a new bio-inspired optimization algorithm. *Commun. Nonlinear Sci. Numer. Simul.* 17 (12), 4831–4845.
- Gheydi, Milad, Nouri, Alireza, Ghadimi, Noradin, 2016. Planning in microgrids with conservation of voltage reduction. *IEEE Syst. J.* 12 (3), 2782–2790.
- Gollou, A.R., Ghadimi, N., 2017. A new feature selection and hybrid forecast engine for day-ahead price forecasting of electricity markets. *J. Intell. Fuzzy Systems* 32 (6), 4031–4045.
- Guo, Y., et al., 2020. An optimal configuration for a battery and PEM fuel cell-based hybrid energy system using developed Krill herd optimization algorithm for locomotive application. *Energy Rep.* 6, 885–894.
- Hamal, N.S., Isa, Z.M., Nayan, N.M., Arshad, M.H., Kajaan, N.A.M., 2018. Optimizing PEMFC model parameters using dragonfly algorithm: a performance study.
- Hamian, M., Darvishan, A., Hosseinzadeh, M., Lariche, M.J., Ghadimi, N., Nouri, A., 2018. A framework to expedite joint energy-reserve payment cost minimization using a custom-designed method based on mixed integer genetic algorithm. *Eng. Appl. Artif. Intell.* 72, 203–212.
- Hosseini Firouz, M., Ghadimi, N., 2016. Optimal preventive maintenance policy for electric power distribution systems based on the fuzzy AHP methods. *Complexity* 21 (6), 70–88.
- Khodaei, Hossein, et al., 2018. Fuzzy-based heat and power hub models for cost-emission operation of an industrial consumer using compromise programming. *Appl. Therm. Eng.* 137, 395–405.
- Leng, H., Li, X., Zhu, J., Tang, H., Zhang, Z., Ghadimi, N., 2018. A new wind power prediction method based on ridgelet transforms, hybrid feature selection and closed-loop forecasting. *Adv. Eng. Inform.* 36, 20–30.
- Li, Q., Chen, W., Wang, Y., Liu, S., Jia, J., 2010. Parameter identification for PEM fuel-cell mechanism model based on effective informed adaptive particle swarm optimization. *IEEE Trans. Ind. Electron.* 58 (6), 2410–2419.
- Liu, Y., Lehnert, W., Janßen, H., Samsun, R.C., Stolten, D., 2016. A review of high-temperature polymer electrolyte membrane fuel-cell (HT-PEMFC)-based auxiliary power units for diesel-powered road vehicles. *J. Power Sources* 311, 91–102.
- Liu, Y., Wang, W., Ghadimi, N., 2017a. Electricity load forecasting by an improved forecast engine for building level consumers. *Energy* 139, 18–30.
- Liu, Yang, Wang, Wei, Ghadimi, Noradin, 2017b. Electricity load forecasting by an improved forecast engine for building level consumers. *Energy* 139, 18–30.
- Liu, Jun, et al., 2020. An IGDT-based risk-involved optimal bidding strategy for hydrogen storage-based intelligent parking lot of electric vehicles. *J. Energy Storage* 27, 101057.
- Mekhilef, S., Saidur, R., Safari, A., 2012. Comparative study of different fuel cell technologies. *Renew. Sustain. Energy Rev.* 16 (1), 981–989.
- Meng, Qing, et al., 2020. A single-phase transformer-less grid-tied inverter based on switched Capacitor for PV application. *J. Control Autom. Electr. Syst.* 31 (1), 257–270.
- Mirzapour, F., Lakzaei, M., Varamini, G., Teimourian, M., Ghadimi, N., 2019. A new prediction model of battery and wind-solar output in hybrid power system. *J. Ambient Intell. Humaniz. Comput.* 10 (1), 77–87.
- Nejad, H.C., Tavakoli, S., Ghadimi, N., Korjani, S., Nojavan, S., Pashaei-Didani, H., 2019. Reliability based optimal allocation of distributed generations in transmission systems under demand response program. *Electr. Power Syst. Res.* 176, 105952.
- Özgür, T., Yakarılmaz, A.C., 2018. A review: exergy analysis of PEM and PEM fuel cell based CHP systems. *Int. J. Hydrogen Energy* 43 (38), 17993–18000.
- Papadopoulos, P.N., Kandyla, M., Kourtza, P., Papadopoulos, T.A., Papagianis, G.K., 2014. Parametric analysis of the steady state and dynamic performance of proton exchange membrane fuel cell models. *Renew. Energy* 71, 23–31.
- Priya, K., Babu, T.S., Balasubramanian, K., Kumar, K.S., Rajasekar, N., 2015. A novel approach for fuel cell parameter estimation using simple genetic algorithm. *Sustain. Energy Technol. Assess.* 12, 46–52.
- Rao, Y., Shao, Z., Ahangarnejad, A.H., Gholamalizadeh, E., Sobhani, B., 2019. Shark smell optimizer applied to identify the optimal parameters of the proton exchange membrane fuel cell model. *Energy Convers. Manag.* 182, 1–8.
- Rasheed, R.K.A., Liao, Q., Caizhi, Z., Chan, S.H., 2017. A review on modelling of high temperature proton exchange membrane fuel cells (HT-PEMFCs). *Int. J. Hydrogen Energy* 42 (5), 3142–3165.
- Razmjoo, N., Khalilpour, M., Ramezani, M., 2016. A new meta-heuristic optimization algorithm inspired by FIFA world cup competitions: Theory and its application in PID designing for AVR system. *J. Control Autom. Electr. Syst.* 27 (4), 419–440.
- Razmjoo, N., Ramezani, M., 2014. An improved quantum evolutionary algorithm based on invasive weed optimization. *Indian J. Sci. Res.* 4 (2), 413–422.
- Rim, C., Piao, S., Li, G., Pak, U., 2018. A niching chaos optimization algorithm for multimodal optimization. *Soft Comput.* 22 (2), 621–633.
- Saeedi, M., Moradi, M., Hosseini, M., Emamifar, A., Ghadimi, N., 2019. Robust optimization based optimal chiller loading under cooling demand uncertainty. *Appl. Therm. Eng.* 148, 1081–1091.
- Sahu, R.K., Panda, S., Rout, U.K., Sahoo, D.K., 2016. Teaching learning based optimization algorithm for automatic generation control of power system using 2-DOF pid controller. *Int. J. Electr. Power Energy Syst.* 77, 287–301.
- Selem, S.I., Hasanien, H.M., El-Fergany, A.A., 2020. Parameters extraction of PEMFC's model using manta rays foraging optimizer. *Int. J. Energy Res.* 44 (6), 4629–4640.
- Strumberger, I., Sarac, M., Markovic, D., Bacanin, N., 2018a. Moth search algorithm for drone placement problem. *Int. J. Comput.* 3.
- Strumberger, I., Tuba, E., Bacanin, N., Beko, M., Tuba, M., 2018b. Wireless sensor network localization problem by hybridized moth search algorithm. In: 2018 14th International Wireless Communications & Mobile Computing Conference (IWCMC). IEEE, pp. 316–321.
- Sun, Z., Wang, N., Bi, Y., Srinivasan, D., 2015. Parameter identification of PEMFC model based on hybrid adaptive differential evolution algorithm. *Energy* 90, 1334–1341.
- Technology, N.F.C., 0000. NedStack Fuel Cell Technology. <http://www.fuelcellmarkets.com/content/images/articles/ps6.pdf> accessed.
- Tizhoosh, H.R., 2005. Opposition-based learning: a new scheme for machine intelligence. In: International Conference on Computational Intelligence for Modelling, Control and Automation and International Conference on Intelligent Agents, Web Technologies and Internet Commerce (CIMCA-IAWTIC'06), Vol. 1. IEEE, pp. 695–701.
- Wang, G.-G., 2018. Moth search algorithm: a bio-inspired metaheuristic algorithm for global optimization problems. *Memetic Comput.* 10 (2), 151–164.
- Yang, D., Li, G., Cheng, G., 2007. On the efficiency of chaos optimization algorithms for global optimization. *Chaos Solitons Fractals* 34 (4), 1366–1375.
- Ye, Haixiong, et al., 2020. High step-up interleaved dc/dc converter with high efficiency. *Energy Sources, Part A: Recov. Util. Environ. Effects* 1–20.
- Yin, Z., Razmjoo, N., 2020. Pemfc identification using deep learning developed by improved deer hunting optimization algorithm. *Int. J. Power Energy Syst.* 40 (2).
- Yu, Dongmin, Ghadimi, Noradin, 2019. Reliability constraint stochastic UC by considering the correlation of random variables with copula theory. *IET Renew. Power Gener.* 13 (14), 2587–2593.
- Yu, D., et al., 2019. System identification of PEM fuel cells using an improved elman neural network and a new hybrid optimization algorithm. *Energy Rep.* 5, 1365–1374.
- Yuan, Z., Wang, W., Wang, H., Razmjoo, N., 2020. A new technique for optimal estimation of the circuit-based PEMFCs using developed sunflower optimization algorithm. *Energy Rep.* 6, 662–671.