

Ufa, Ruslan et al.

Article

Analysis of application of back-to-back HVDC system in Tomsk electric power system

Energy Reports

Provided in Cooperation with:

Elsevier

Suggested Citation: Ufa, Ruslan et al. (2020) : Analysis of application of back-to-back HVDC system in Tomsk electric power system, Energy Reports, ISSN 2352-4847, Elsevier, Amsterdam, Vol. 6, pp. 438-444, <https://doi.org/10.1016/j.egyr.2020.01.017>

This Version is available at:

<https://hdl.handle.net/10419/244046>

Standard-Nutzungsbedingungen:

Die Dokumente auf EconStor dürfen zu eigenen wissenschaftlichen Zwecken und zum Privatgebrauch gespeichert und kopiert werden.

Sie dürfen die Dokumente nicht für öffentliche oder kommerzielle Zwecke vervielfältigen, öffentlich ausstellen, öffentlich zugänglich machen, vertreiben oder anderweitig nutzen.

Sofern die Verfasser die Dokumente unter Open-Content-Lizenzen (insbesondere CC-Lizenzen) zur Verfügung gestellt haben sollten, gelten abweichend von diesen Nutzungsbedingungen die in der dort genannten Lizenz gewährten Nutzungsrechte.

Terms of use:

Documents in EconStor may be saved and copied for your personal and scholarly purposes.

You are not to copy documents for public or commercial purposes, to exhibit the documents publicly, to make them publicly available on the internet, or to distribute or otherwise use the documents in public.

If the documents have been made available under an Open Content Licence (especially Creative Commons Licences), you may exercise further usage rights as specified in the indicated licence.



<https://creativecommons.org/licenses/by-nc-nd/4.0/>



Research paper

Analysis of application of back-to-back HVDC system in Tomsk electric power system



Ruslan Ufa^{b,*}, Alexandr Gusev^b, Ahmed A. Zaki Diab^c, Aleksey Suvorov^b, Nikolay Ruban^b, Mikhail Andreev^b, Alisher Askarov^b, Vladimir Rudnik^b, Omer Abdalla^{a,d}, Ziad M. Ali^{a,e}, Ahmed Ibrahim^b, Raef Aboelsaud^b

^a College of Engineering at Wadi Addawaser, Prince Sattam bin Abdulaziz University, 11991 Wadi Aldawaser, Saudi Arabia

^b Tomsk Polytechnic University, Lenina avenue 30, Tomsk, Russian Federation

^c Minia University, Minia 61111, Egypt

^d Sudan University of Science and Technology, College of Engineering, Khartoum, Sudan

^e Aswan University, 81542 Aswan, Egypt

ARTICLE INFO

Article history:

Received 10 July 2019

Received in revised form 28 December 2019

Accepted 30 January 2020

Available online xxxx

Keywords:

Back-to-back HVDC system

Electric power system

Asynchronous interconnection

Planning

Sizing

ABSTRACT

In this article the research results of application of back-to-back HVDC system in the Tomsk electric power system are presented. Historically, power transmission between the South to the North parts of the Tomsk electric power system is realized via the long double-circuit 220 kV overhead transmission line. However, due to electrical load increasing and growing complexity of the grid, as well as the length (about 800 km) and low transfer capacity of this transit, it cannot be used as a reliable link for parallel operation of these parts, as a consequence, there is an operational section at this transit. To solve this task, the back-to-back HVDC system is proposed to provide an asynchronous link for parallel operation of these parts. Therefore, appropriate studies and calculations were performed, in particular the optimal location and sizing of back-to-back HVDC system were defined. Extra researches of back-to-back HVDC's impact on emergency scenarios of Tomsk electric power system power are conducted. It is shown, that its installation decreases the level of short-circuit current and oscillations in electric power system, and as a result increases the stability of load operation, especially motor load.

© 2020 The Authors. Published by Elsevier Ltd. This is an open access article under the CC BY-NC-ND license (<http://creativecommons.org/licenses/by-nc-nd/4.0/>).

1. Introduction

Nowadays the electric power system (EPS) of Tomsk region consists of the North part, where oil and gas facilities are concentrated, and the South part, where thermal power plants are located. Historically, power transmission between the South to the North parts is realized via the long double-circuit 220 kV overhead transmission line from Nizhnevartovsk power station (United power system (UPS) of Ural) – Tomsk substation (UPS of Siberia) (Fig. 1). However, due to electrical load increasing (in particular, the North part) and growing complexity of the grid, as well as the length (about 800 km) and low transfer capacity of this transit, it cannot be used as a reliable link for parallel operation of the North and South EPS parts (Shakaryan et al.,

2012; Fokin, 2015; Vainshtein et al., 2012), as a consequence, there is an operational section at Substation (Ss) No.7. Thus, it significantly decreases the reliability and efficiency of the electric power supply for consumers, especially oil and gas facilities during the period of routine switching operations by the system operator.

In this regard, the interconnection (even for a short period on the time) or asynchronous interconnection of the South and North parts of Tomsk EPS can solve this task and provide the reliable electric power transmission between UPS of Ural and UPS of Siberia (these power systems are currently connected via transmission through the Omsk EPS and UPS of the Republic of Kazakhstan), as well as increase the flexibility and sustainability of the Tomsk EPS operation in general.

There are several ways to solve this problem (Kaijian et al., 2014; Khaled et al., 2015; Raza et al., 2017):

- (1) interconnection via synchronization tools and busbar circuit breakers (for example, at Ss_4 or Ss_7). This approach is limited by the value of voltage angle difference (δ) between buses, at which parallel operation is possible without any power oscillations in interconnected parts of EPS,

* Corresponding author.

E-mail addresses: hecn@tpu.ru (R. Ufa), gusev_as@tpu.ru (A. Gusev), a.diab@mu.edu.eg (A.A.Z. Diab), suvorovaa@tpu.ru (A. Suvorov), rubanny@tpu.ru (N. Ruban), andreevmv@tpu.ru (M. Andreev), aba7@tpu.ru (A. Askarov), fordlp006@mail.ru, ver3@tpu.ru (V. Rudnik), o.abdalla@psau.edu.sa (O. Abdalla), dr.ziad.elhalwany@aswu.edu.eg (Z.M. Ali), ibragim@tpu.ru (A. Ibrahim), aboelsaud@tpu.ru (R. Aboelsaud).

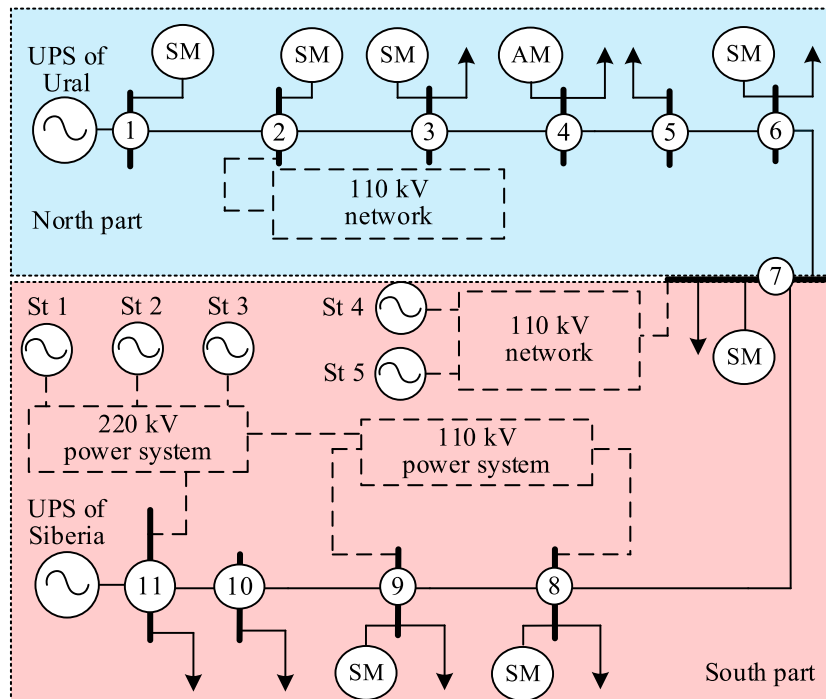

Fig. 1. Part of the studies scheme of the Tomsk EPS, where 1–11 substations, St – electric power station, SM – synchronous motor, AM – asynchronous motor, UPS – unified power system.

and by the time, at which the synchronization conditions are met: equality of angular frequencies, voltage magnitudes and phase angle between these voltages;

- (2) use of modern technologies – back-to-back (B2B) High-Voltage Direct Current (HVDC) system based on voltage source converter (VSC) (Kaijian et al., 2014; Khaled et al., 2015; Raza et al., 2017), which provides the asynchronous interconnection at any value of δ , angular frequencies and voltage magnitudes.

It should be noted that, the VSC HVDC is a new type of direct current transmission technology, which based on a high-power switching (IGBT, GTO) with the pulse-width modulation method of controlling (Flourentzou et al., 2009; Latorre and Gandhari, 2011; Andersen et al., 2002). The properties and characteristics of VSC provide the key opportunities for effective interconnection of power systems, which consist in: (1) the independent regulation of the active and reactive power flows (via operation in four quadrants), (2) the implementation of the power flow reverse without changing the polarity of voltage, the ability of VSC connection to a weak grid and etc. (Zhang et al., 2010, 2011).

However, the number of deep studies and comprehensive analysis should be carried out to provide the asynchronous interconnection of South and North parts of Tomsk EPS, mainly the optimal placement and capacity of the B2B HVDC system should be found. These studies and analysis are becoming even more relevant due to lack of operating experience of VSC HVDC in Russia.

The paper is organized as follows: In Section 2 the description of the Tomsk EPS is presented. The analysis of interconnection via synchronization tools and busbar circuit breakers, and via the B2B HVDC system are shown. Section 3 presents the formed requirements for minimum bandwidth capacity of the B2B HVDC (i.e. the minimum required power of B2B HVDC system), results of calculation of the maximum permissible active power flow in the controlled 220 kV transit. Based on these results the optimal place and capacity of the B2B HVDC system are determined. Besides, the researches of B2B HVDC's impact on emergency scenarios of Tomsk EPS are shown. Section 4 presents the conclusions.

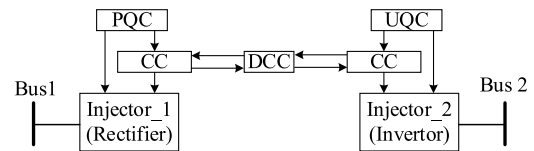

Fig. 2. B2B HVDC model structure.

2. Analysis of possible solutions

2.1. Configuration of the studied system

To prepare the calculation scheme the Eurostag (Standard models library, 2008) and RastrWin (Aleksandrov et al., 0000) software programs were used. In particular, the simulation of the interconnection of the South and North parts of Tomsk EPS via synchronization tools and busbar circuit breakers, and the B2B HVDC system were performed in the Eurostag software, while the RastrWin software was used for calculating the maximum permissible active power flow.

According to Cole and Haut (2013) a B2B HVDC model is realized base on the two dynamic controlled injectors, which deliver the consumed or produced power into the node (Fig. 2). Different macroblocks are used to realize a control system of the HVDC. In particular, control system of each converters includes Current Controller (CC) and Active and Reactive Power Controller (PQC) macroblocks, thus for other one PQC macroblock is replaced by the DC Voltage and Reactive Power Controller (UQC). In the direct current circuit (DCC) macroblock the direct current network equations are realized.

In the RastrWin software, which is designed to solve the tasks of calculating, analyzing and optimizing EPS modes, the simulation results of determining of steady-state stability limit and the maximum permissible power flow through the 220 kV Ss_1 – Ss_11 transit in normal and abnormal (repair scheme) are presented. In Table 1 the initial data for the calculation are given,

Table 1
Initial data for the calculation.

Generation	P (MW)		Q (Mvar)	
St 1	331		199	
St 2	140		84	
St 3	549		329	
St 4	36		22	
St 5	8		5	

Substation	Load		Electrical motor	
	P (MW)	Q (Mvar)	P (MW)	Q (Mvar)
Ss_1	121	70	21	6
Ss_2	47	22	10	8
Ss_3	12	8	4	3
Ss_4	8	5	4	3
Ss_5	2	3	-	-
Ss_6	5	4	4	4
Ss_7	16	8	10	3
Ss_8	27	18	12	5
Ss_9	35	22	15	9
Ss_10	23	23	-	-
Ss_11	10	4	-	-

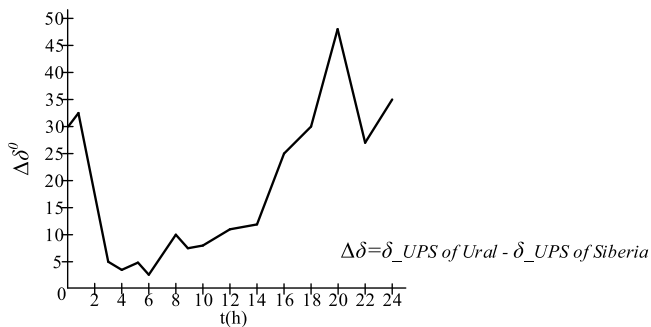

Fig. 3. The measurement plot of hourly average values of angle (δ) between the vectors of voltages of the Tomsk EPS parts.

while the initial mode of the calculation scheme is set according to the measurements from the operational and informational software complex (the Russian equivalent of Supervisory Control and Data Acquisition systems) of the Tomsk EPS.

2.2. Interconnection via synchronization tools and busbar circuit breakers

According to simulation studies of normal and abnormal (repair scheme) of North and South part of Tomsk EPS the variation range of the angle (δ) is around $\pm 30^\circ$ (Fig. 3). At the same time, according to field measurements of the angle (δ°) between voltages of UPS of Ural and UPS of Siberia, which were carried out at Ss_7 (Litvak et al., 1990), the range of variation of the angle ($\Delta\delta^\circ$) reached 50° (Fig. 3).

Further, the simulation of the opportunity of interconnection via synchronization tools and busbar circuit breakers at each substations at various value of angles was carried out. Based on these simulation results the maximum value of angle (δ_{max}), wherein the stability operation of the EPS does not lose (Table 2), is defined (the maximum power surge and generated balanced current do not exceed the maximum permissible value for thermal withstand, the voltage value is set at the nominal level and electric motor load does not lose synchronism). For example, the interconnection at Ss_7 at the angle ($\delta \approx 40^\circ$) leads to instability and loss of the EPS stability (Fig. 4), in particular the synchronous motor (SM) at Ss_7 is lose the synchronism. Thus, the interconnection via synchronization tools and busbar circuit breakers is quite complicated approach, which limited by

Table 2

The maximum value of angle between the voltages of Ss buses, wherein the stability operation of the EPS does not lose.

	The maximum value of angle ($\delta_{max}, ^\circ$)	
	Leading of U_UPS of Ural (bus_1)	Leading of U_UPS of Siberia (bus_2)
Ss_1	66	60
Ss_2	62	57
Ss_3	57	52
Ss_4	54	50
Ss_5	50	46
Ss_6	49	43
Ss_7	45	38

the value of angle and the time interval, while this value will be in the allowed range. Besides, it remains unknown how long this angle will be within the “safe” range.

2.3. Asynchronous interconnection via B2B HVDC system

It is known, that B2B HVDC system provides the asynchronous interconnection at any value of angle between the voltages, angular frequencies and magnitude of the voltages. To confirm this opportunity the simulation result of B2B HVDC system application at Ss_7 are presented in Fig. 5. It is seen, that even angle is around $\delta \approx 180^\circ$ (theoretically worst mode) the asynchronous link does not disturb the stability of the Tomsk EPS, the level of voltage does not significantly reduce ($\Delta \leq 1\%$) and does not lead to a shutdown the electric motors.

At the same time, the obtained simulation results show a positive effects of the B2B HVDC system application during short-circuit fault on the transit: the voltage at the connecting buses practically does not change, the level of oscillations and mutual influence of short-circuit current reduce in the unified parts of the Tomsk EPS, as a result the stability operation of load nodes, especially the motor loads, is improved (Figs. 6, 7).

3. Analysis of optimal place and capacity of the B2B HVDC system in the Tomsk EPS

The following requirements shall be taken into account for determining the minimum bandwidth capacity of the B2B HVDC system:

(1) the value of the maximum possible emergency unbalance of active power arising from a disconnection of generator unit or a surge of active power resulting of switching-off of largest consumer.

Thermal power plants can regulate power flow through the B2B HVDC system in normal and abnormal EPS modes. In this regard, the possibility to reserve the generation units of these stations should be considered in case of their emergency and planned outages – the power of the largest generation unit is around 140 MW.

In separation operation of North and South parts of Tomsk EPS a short-circuit faults occurring in the link Ss_1–Ss_2 leads to disconnection of consumers of at least five substations with a total load up to 95 MW, or disconnection of consumers of at least four substations with a total load up to 140 MW in case of short-circuit faults occurring in the link Ss_10–Ss_11.

(2) the value of the maximum permissible active power flow (MPP) in the controlled 220 kV transit.

There are two controlled transit sections, in which MPP shall be calculated:

- Ss_1–Ss_2 controlled transit section (1st and 2nd circuit lines);

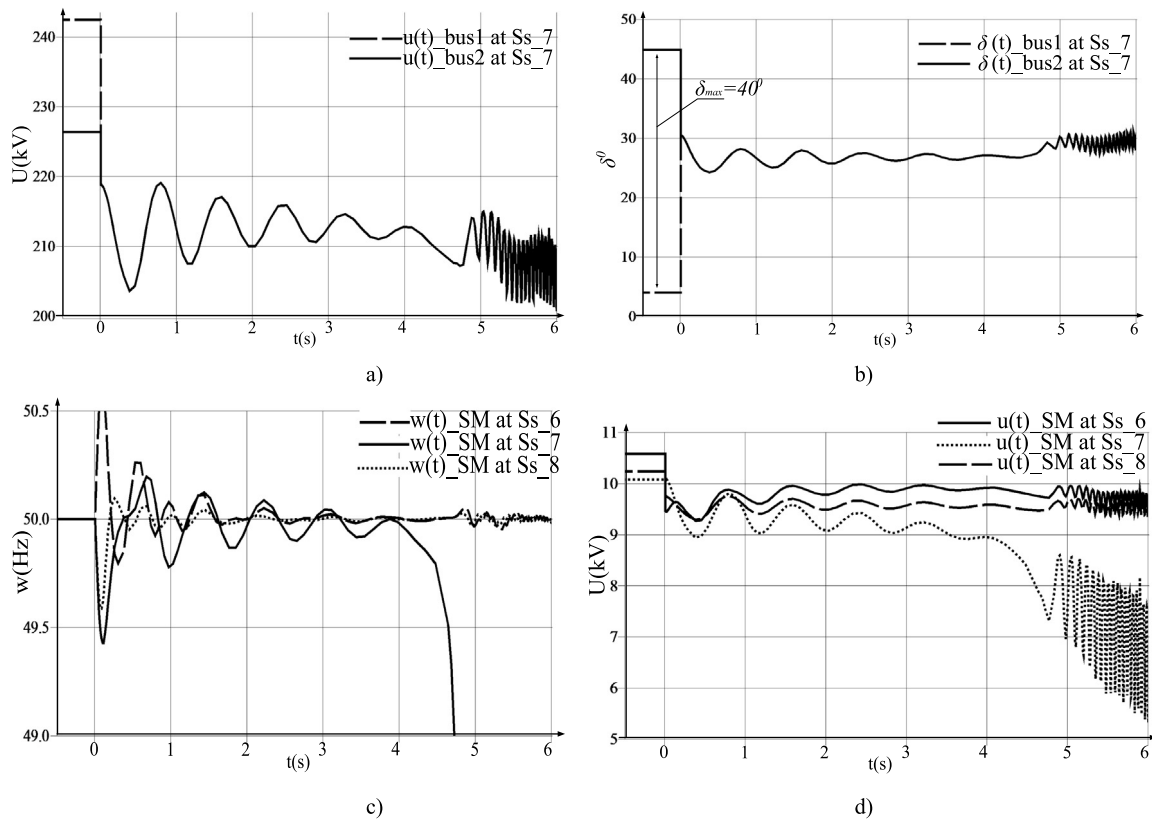

Fig. 4. The waveform of voltage (a) and angle between voltage of bus1 and bus2 of Ss_7 (b), rotational speed (c) and voltage of electrical motors (d).

Table 3

The calculation of MPP and determination of capacity of B2B HVDC system for Ss_1.

Value of MPP for the controlled transit section in normal scheme	Section Ss_1–Ss_2	$P_{MPP1} = 268 \text{ MW}$	It is determined by the criterion of non-exceeding of the emergency permissible current load (EPCL) for the 1st circuit line of the 220 kV overhead line Ss_1–Ss_2 in the post-emergency mode (PEM) under switching-off the 2nd circuit line of 220 kV overhead line Ss_1–Ss_2, and vice versa.
	Section Ss_11–Ss_10	$P_{MPP2} = 204 \text{ MW}$	It is determined by the criterion of non-exceeding of the EPCL for the 1st circuit line of the 220 kV overhead line Ss_11–Ss_10 in the PEM under switching-off the 2nd circuit line of 220 kV overhead line Ss_1–Ss_2, and vice versa.
Power consumption of the controlled 220 kV transit	Ss_1	$P_{L3} = 142 \text{ MW}$	Sum of power consumption of Ss_1
	From Ss_11 to Ss_2	$P_{L4} = 244 \text{ MW}$	Sum of power consumption from Ss_11 to Ss_2; there are additional generation units (St_4 and St_5) injected to the grid 44 MW.
Determination of capacity of the B2B HVDC system	$P_{B2B} = P_{MPP1} - P_{L3} = 268 - 142 = 126 \text{ MW}$		Maximum possible flow of active power through the B2B HVDC system from Ss_1 to Ss_2 (from the UPS of Urals to the UPS of Siberia)
	$P_{B2B} = P_{MPP2} - P_{L4} + 50 = 204 - 244 + 44 = 4 \text{ MW}$		Maximum possible flow of active power through the B2B HVDC system from Ss_2 to Ss_1 (from the UPS of Siberia to the UPS of Ural)

Accordingly, the recommended installed capacity of the B2B HVDC system taking into account the reserve is around $\pm 140 \text{ MW}$. However, power transfer through B2B HVDC system, installed at Ss_1, can be carried out only from the Ss_1 to the Ss_2 (from the Urals Ural to the OES of Siberia).

- Ss_11–Ss_10 controlled transit section (1st and 2nd circuit lines);

To obtain the largest transit power flow through the B2B HVDC system a minimum consumption mode of the EPS is considered. As an example, the results of MPP calculation, determination of capacity and placement of B2B HVDC system for Ss_1 and Ss_7 are presented in Tables 3 and 4.

According to the obtained result the Ss_7 is the most optimal placement for B2B HVDC system (in particular because it will

provide power flow reversibility) with rated power is around $\pm 140 \text{ MW}$.

It should be mentioned that, obviously, the installation of the B2B HVDC system will not provide a reliable and «strong» link between the UPS of Ural and the UPS of Siberia. However, under the existing operation condition of the 220 kV transit (operational section at Ss_7, «weak» link between the UPS of Ural and the UPS of Siberia, responsible consumers), the properties and capabilities of the B2B HVDC system will provide the asynchronous interconnection of the South and North parts of Tomsk EPS for

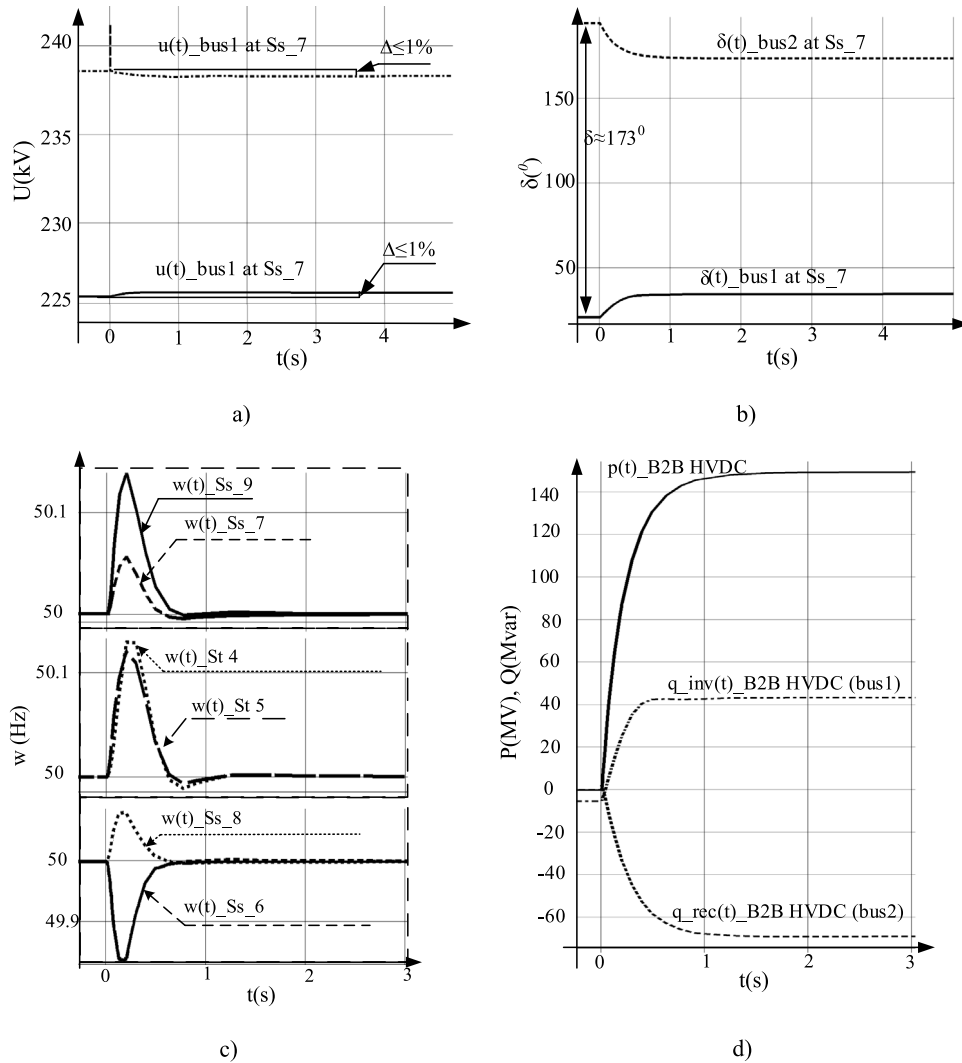

Fig. 5. The waveform of voltage (a) and angle between voltage of bus1 and bus2 of Ss_7 (b), rotational speed of electrical motors (c) and through the B2B HVDC system (d) at $\delta \approx 180^\circ$.

Table 4

The calculation of MPP and determination of capacity of the B2B HVDC system for Ss_7.

Value of MPP for the controlled transit section in normal scheme	Section Ss_1–Ss_2	$P_{MPP1} = 268 \text{ MW}$	It is determined by the criterion of non-exceeding of the EPCL for the 1st circuit line of the 220 kV overhead line Ss_1–Ss_2 in the PEM under switching-off the 2st circuit line of 220 kV overhead line Ss_1–Ss_2, and vice versa.
	Section Ss_11–Ss_10	$P_{MPP2} = 204 \text{ MW}$	
Power consumption of the controlled 220 kV transit	From Ss_1 to Ss_6	$P_{L1} = 238 \text{ MW}$	Sum of power consumption from Ss_1 to Ss_6
	From Ss_11 to Ss_7	$P_{L2} = 148 \text{ MW}$	Sum of power consumption from Ss_11 to Ss_7; there are additional generation units (St_4 and St_5) injected to the grid 44 MW.
Determination of capacity of the B2B HVDC system	$P_{B2B} = P_{MPP1} - P_{L1} = 268 - 238 = 30 \text{ MW}$		Maximum possible flow of active power through the B2B HVDC system from Ss_6 to Ss_7 (from the UPS of Urals to the UPS of Siberia)
	$P_{B2B} = P_{MPP2} - P_{L2} + 50 = 204 - 148 + 44 = 100 \text{ MW}$		Maximum possible flow of active power through the B2B HVDC system from Ss_7 to Ss_6 (from the UPS of Siberia to the UPS of Ural)

Accordingly, the recommended installed capacity of the B2B HVDC system taking into account the reserve is more than $\pm 110 \text{ MW}$.

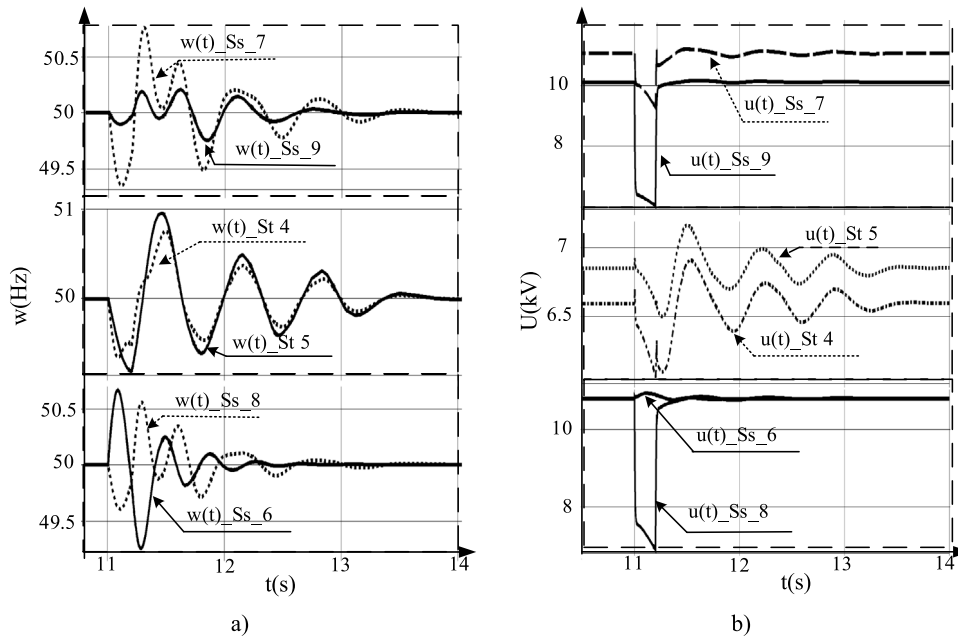

Fig. 6. The waveform of rotational speeds of electrical motors (a) and voltage (b) under short-circuits fault (at $t = 11$ s) on the inverter side of the B2B HVDC, installed in Ss_7 .

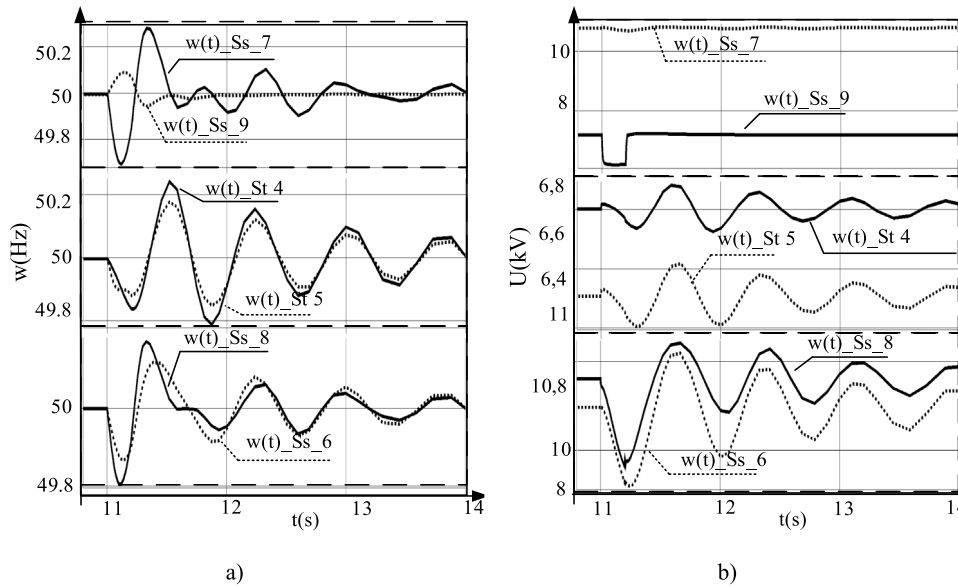

Fig. 7. The waveforms of rotational speeds of electrical motors (a) and voltage (b) under short-circuits fault (at $t = 11$ s) on the inverter side of the B2B HVDC, installed in Ss_1 .

Table 5
Short-circuit current under fault at Ss_7 .

Overhead lines	Before installation, A	After installation, A	Difference, A
1–2	590	440	150
2–3	600	460	140
3–4	650	480	170
4–5	1200	870	330
5–6	1240	880	360
6–7	1300	910	390
7–8	970	260	710
8–9	780	310	470
9–10	760	340	420
10–11	740	350	390

Table 6
Short-circuit current under fault at Ss_1 .

Overhead lines	Before installation, A	After installation, A	Difference, A
1–2	650	650	0
2–3	500	360	140
3–4	450	350	100
4–5	820	650	170
5–6	800	620	180
6–7	780	610	170
7–8	540	460	80
8–9	480	420	60
9–10	460	400	60
10–11	440	380	60

bidirectional power flow, ensuring the reliable electric power supplies.

However, installation of the B2B HVDC system at Ss₇ reduces the level of the short-circuit in the EPS (Tables 5–6), which accordingly reduces the current requirements for the equipment and increases its service life.

4. Conclusion

1. The problem of parallel operation of the South and North parts of the Tomsk EPS and the analysis of ways to solve this task are presented

2. The maximum value of angle between the voltages of substation buses, wherein the stability operation of EPS is not lose, for each substation are determined. This result show that the interconnection via synchronization tools and busbar circuit breakers is quite complicated approach, which limited by the value of angle and the time while this value will be in the allowed range. Besides, it remains unknown how long this angle will be within the “safe” range.

3. The B2B HVDC system was proposed as an alternative approach to solve this problem and to provide asynchronous interconnection at any value of the angle and any moment of time (for example during a routine switching).

4. The obtained results show that the Ss₇ is the most optimal placement for the B2B HVDC system with rated power is around ± 140 MW.

5. The B2B HVDC's impact on emergency scenarios of the Tomsk EPS is conducted. It is shown, that the B2B HVDC system provides faster initial transient recovery, the mutual influence of short-circuits in the unified parts of the EPS is reduced, the voltage at the connection point of the B2B HVDC system is practically unchanged, the level of oscillations in the EPS is reduced.

Future work will be focused on defining necessity in extra functions of the B2B HVDC system, particularly, voltage balancing and frequency regulation, defining optimal topology of voltage-source converter, as well as structure, settings and algorithms of automatic control and protection system.

CRedit authorship contribution statement

Ruslan Ufa: Conceptualization, Validation, Writing - original draft, Writing - review & editing. **Alexandr Gusev:** Conceptualization, Methodology, Writing - review & editing. **Ahmed A. Zaki Diab:** Investigation - review & editing. **Aleksey Suvorov:** Software, Formal analysis. **Nikolay Ruban:** Software. **Mikhail Andreev:** Validation. **Alisher Askarov:** Resources, Writing - original draft. **Vladimir Rudnik:** Resources, Writing - original draft. **Omer Abdalla:** Methodology, Funding acquisition - review & editing. **Ziad M. Ali:** Funding acquisition. **Ahmed Ibrahim:** Formal analysis - review & editing. **Raef Aboelsaud:** Simulation programming.

Declaration of competing interest

The authors declare that they have no known competing financial interests or personal relationships that could have appeared to influence the work reported in this paper.

Acknowledgments

This work was supported by the Russian Science Foundation under the governmental grant №18-79-10006 “Investigation the problem of processes calculations reliability in electric power systems with active-adaptive networks and distributed generation and development the methodology of their comprehensive validation”.

The research is funded from Tomsk Polytechnic University, Russia Competitiveness Enhancement Program.

References

- Aleksandrov, A., Neuymin, V., Mashalov, E., Bagryntsev, A., Smirnov, I., Sutkin, A., Maksimenko, D., Using RastrWin3 software for planning and control of active-adaptive (smart) grids. [Online] http://www.rastrwin.ru/en/Files/AlexandrovRastrWin_6_.pdf.
- Andersen, B.R., Xu, L., Horton, P.J., Cartwright, P., 2002. Topologies for VSC transmission. *Power Eng. J.* 16, 142–150.
- Cole, S., Haut, B., 2013. Robust modeling against model-solver interactions for high-fidelity simulation of VSC HVDC systems in EUROSTAG. *IEEE Trans. Power Syst.* 28 (3), 2635–2638.
- Flourentzou, N., Agelidis, V.G., Demetriades, G.D., 2009. VSC-based HVDC power transmission systems: An overview. *IEEE Trans. Power Electron.* 24, 592–602.
- Fokin, V., 2015. Controlled reactive power compensators in electric networks of Russia: Past, present and future. *Power Technol. Eng.* 2 (1003), 75–88.
- Kaijian, O., Hong, R., Zexiang, C., Haiping, G., 2014. MMC-HVDC simulation and testing based on real-time digital simulator and physical control system. *IEEE J. Emerg. Sel. Top. Power Electron.* 2 (4), 1109–1116.
- Khaled, M.H., Mohamed, M., Moustafa, Z., 2015. Performance and control of a back to back MMC-HVDC for asynchronous networks interconnection. In: *IEEE 28th Canadian Conference on Electrical and Computer Engineering*. pp. 1066–1071.
- Latorre, H.F., Ghandhari, M., 2011. Improvement of power system stability by using a VSC-HVdc. *Int. J. Electr. Power Energy Syst.* 33 (2), 332–339.
- Litvak, V., Markman, G., Lebedev, N., 1990. Measurement of the angle of divergence of the voltage vectors of the Tomsk and Tyumen energy systems. In: *Collection Processes and Modes of Electrical Systems*. pp. 55–59.
- Raza, A., Dianguo, X., Xunwen, S., Weixing, L., Williams, B.W., 2017. A novel multiterminal VSC-HVdc transmission topology for offshore wind farms. *IEEE Trans. Ind. Appl.* 53 (2), 1316–1325.
- Shakaryan, Yu, Timashova, L., Kareva, S., Postolatiy, V., Bykova, E., Suslov, V., 2012. Technical aspects of creation of compact controlled overhead transmission line 220 and 500 kV. *Electr. Transm. Distrib.* 3 (12), 106–111.
- Standard models library, 2008. Eurostag package: User guide. p. 250, Release 4.4.
- Vainshtein, R.A., Kats, I.M., Kolomiets, N.V., Pilot, D.S., Prihodko, S.N., Rusol, D.A., Shestakova, V.V., 2012. The experience of calculating electromechanical transients in complex electric power systems. *Electr. Technol. Russia* 6, 21–24.
- Zhang, L., Harnefors, L., Nee, H.P., 2010. Power-synchronization control of grid-connected voltage-source converters. *IEEE Trans. Power Syst.* 25 (2), 809–820.
- Zhang, L., Harnefors, L., Nee, H.P., 2011. Interconnection of two very weak AC systems by VSC-HVDC links using power-synchronization control. *IEEE Trans. Power Syst.* 26 (1), 344–355.