

Celik, Adem; Yilmaz, Mehmet; Yildiz, Omer Faruk

## Article

# Improvement of diesel engine startability under low temperatures by vortex tubes

Energy Reports

**Provided in Cooperation with:**

Elsevier

*Suggested Citation:* Celik, Adem; Yilmaz, Mehmet; Yildiz, Omer Faruk (2020) : Improvement of diesel engine startability under low temperatures by vortex tubes, Energy Reports, ISSN 2352-4847, Elsevier, Amsterdam, Vol. 6, pp. 17-27, <https://doi.org/10.1016/j.egyr.2019.11.027>

This Version is available at:

<https://hdl.handle.net/10419/244012>

### Standard-Nutzungsbedingungen:

Die Dokumente auf EconStor dürfen zu eigenen wissenschaftlichen Zwecken und zum Privatgebrauch gespeichert und kopiert werden.

Sie dürfen die Dokumente nicht für öffentliche oder kommerzielle Zwecke vervielfältigen, öffentlich ausstellen, öffentlich zugänglich machen, vertreiben oder anderweitig nutzen.

Sofern die Verfasser die Dokumente unter Open-Content-Lizenzen (insbesondere CC-Lizenzen) zur Verfügung gestellt haben sollten, gelten abweichend von diesen Nutzungsbedingungen die in der dort genannten Lizenz gewährten Nutzungsrechte.

### Terms of use:

*Documents in EconStor may be saved and copied for your personal and scholarly purposes.*

*You are not to copy documents for public or commercial purposes, to exhibit the documents publicly, to make them publicly available on the internet, or to distribute or otherwise use the documents in public.*

*If the documents have been made available under an Open Content Licence (especially Creative Commons Licences), you may exercise further usage rights as specified in the indicated licence.*



<https://creativecommons.org/licenses/by-nc-nd/4.0/>



## Research paper

## Improvement of diesel engine startability under low temperatures by vortex tubes

Adem Celik<sup>a,\*</sup>, Mehmet Yilmaz<sup>b</sup>, Omer Faruk Yildiz<sup>c</sup><sup>a</sup> 8st Regional Directorate, General Directorate of State Hydraulic Works, Erzurum, Turkey<sup>b</sup> Department of Mechanical Engineering, Faculty of Engineering, Inonu University, Malatya, Turkey<sup>c</sup> Chairmanship of Investment Monitoring and Coordination, Şehitkamil, Gaziantep, Turkey

## ARTICLE INFO

## Article history:

Received 18 April 2019

Received in revised form 8 November 2019

Accepted 16 November 2019

Available online xxxx

## Keywords:

Diesel engine

Cold start

Low temperature

Vortex tube

## ABSTRACT

Cold start is one of the most problematic combustion phases for diesel engines. During this phase, a large proportion of pollutants are produced within the cylinder due to misfiring and incomplete combustion due to the low engine temperatures. Furthermore, exhaust after-treatment devices work inefficiently since their minimum operation temperatures cannot be reached. In addition to this, at temperatures below 0 °C the possibility of continuous misfiring could actually impede the engine start. Ambient temperature is one of the most important factors affecting the diesel engine cold startability.

The aim of this study is to improve diesel engine startability under low temperatures by vortex tubes. A vortex tube was used to increase the intake air temperature in a six cylinders, four stroke and direct injection diesel engine of a truck. The hot air obtained from the hot outlet of the vortex tube was mixed with the air coming from the inlet of the intake manifold and the warmer air was sent to the cylinders. The compressed air required for the operation of the vortex tube was provided from the air tank of the compressed-air brake system of the truck. The effects of variation in ambient temperature on the engine cranking speed and in-cylinder pressure were analyzed and presented. Experiments were conducted for ambient air temperatures of −5, 0 and +4 °C. It was found that the reduction in ambient temperature resulted in prolonged cranking periods along with the longer time taken to reach idling speed as well as increased combustion instability for the engine without vortex tube. The use of the vortex tube increased the intake air temperature, which decreased durations of engine starting–cranking, cranking–idling, and idling–stabling. These results indicate that the cold starting performance of the diesel engine could be improved by using vortex tubes.

© 2019 The Authors. Published by Elsevier Ltd. This is an open access article under the CC BY-NC-ND license (<http://creativecommons.org/licenses/by-nc-nd/4.0/>).

## 1. Introduction

Diesel engine is widely regarded as a critical power source for transportation vehicles, construction machinery vehicles, and military-equipment due to its advantages of significant horse power, higher fuel efficiency, greater reliability, and more (Liu et al., 2017). Diesel engine technologies have been improved through high fuel pressure, direct injection, smaller size injector holes, split injection, advanced electronic control units, and exhaust after-treatment devices such as diesel oxidation catalyst (DOC), diesel particulate filter (DPF) and nitrogen oxide (NO<sub>x</sub>) reduction technologies (Ramadhas and Xu, 2018). In spite of all the improvements made in diesel technology to the date, starting at low (below 0 °C) ambient temperatures is still a problem which has not been properly solved (Pastor et al., 2011). Diesel engines still need improvement in cold start characteristics.

Cold start is defined as starting the engine, which was parked overnight, at the ambient temperature condition (Ramadhas and Xu, 2018). According to Ramírez-Hernández (2012) “cold start means any engine start when the temperature of oil, coolant and engine block is equal to the ambient temperature”. Differently to conventional (room temperature) cold start, low temperature cold start is defined as any engine start when the temperature of oil, coolant and engine block is such that mixture ignition needs to be assisted.

Ambient temperature is one of the most important factors affecting the diesel engine cold startability. The cold start problem is more severe when the ambient temperature is reduced to sub-zero. Lower initial combustion chamber wall temperature, poor performance of battery and higher viscosity of engine oil are also causes for lower cranking speed at cold ambient conditions. The temperature and pressure achieved at the end of compression stroke of the cold start process are much lower than those under normal operating conditions. These inferior conditions for the flammable mixture preparation lead to unstable fuel combustion

\* Corresponding author.

E-mail addresses: [acelik\\_25@hotmail.com](mailto:acelik_25@hotmail.com) (A. Celik), [m.yilmaz@inonu.edu.tr](mailto:m.yilmaz@inonu.edu.tr) (M. Yilmaz), [farukmakina@hotmail.com](mailto:farukmakina@hotmail.com) (O.F. Yildiz).

### Nomenclature

$A$	Cross-section
$DOC$	Diesel oxidation catalyst
$DPF$	Diesel particulate filter
$i$	Enthalpy
$L$	Length
$NO_x$	Nitrogen oxide
$p$	Pressure
$R$	Radius
$T$	Temperature
$u$	Air velocity
$TBC$	Thermal barrier coatings

### Subscripts

$c$	Cold
$h$	Hot
$o$	Orifice

and even misfiring. Diesel engine cold start performance is influenced by the ambient temperature conditions, engine design, fuel, lubricant and engine operating conditions (Ramadhas and Xu, 2018). Gupta (1988) states that four operating factors influence the diesel engine starting: (i) engine design, (ii) properties of lubricating oils, fuels and coolant, (iii) battery conditions and starter motor, and (iv) use of starting aids. The most important engine parameters that influence the cold start quality and the connection between these parameters are presented in Fig. 1.

Available studies on low temperature cold start combustion process start from the 1970's, but only recently they have become more systematic aiming at engine cold start optimization (Ramírez-Hernández, 2012). Potential solutions to diesel engine cold-start issues can be classified under the following headings: exhaust gas energy recovery (Jarrier et al., 2000; Peng et al., 2008), the use of thermal barrier coatings (TBC) in the combustion chamber (Ciniviz et al., 2008), standard insulation (Bürgin, 2011), pre heated coolant (Xu and Johnson, 1984; Krause and Spies, 1996; Zammit et al., 2012; Bent et al., 2013; Liu et al., 2011), coolant flow control (Brace et al., 2008); lubricant flow diversion (Law et al., 2007); phase change material (Gumus, 2009; Kaltakkıran et al., 2014), intake air heating (intake air heaters and intake manifold combustion systems) (Ramadhas and Xu, 2018; Mertz, 1997; Lindl and Schmitz, 1999; Du and Zhao, 2003; Payri et al., 2006), glow plugs (Pastor et al., 2011; Lindl and Schmitz, 1999; Ramadhas and Xu, 2016; Kawamura and Yamamoto, 1983; Phatak and Nakamura, 1983a,b; Kobayashi et al., 1984), newly formulated fuel (Hara et al., 1999; Palanisamy, 2013; Broatch et al., 2014; Tinprabath et al., 2015, 2016; Roy et al., 2016), injection system development (Liu et al., 2017; Kobayashi et al., 1984; Palanisamy, 2013; Osuka et al., 1994; Desantes et al., 2011; Chartier et al., 2009; Wang et al., 2015, 2016; Liu et al., 2012), warming up lubricating oil to improve the fuel efficiency (Will and Boretti, 2011), oil injection into the cylinder (Malozemov et al., 2016), cold start optimization (John et al., 2011; Deng et al., 2018).

Last et al. (2008) described the functionality and potential of modern cold start systems. A review paper on the approaches taken to improve engine cold-start performance was presented by Roberts et al. (2014). The findings were assessed and the likely effectiveness of strategies based on system performance and materials optimization discussed. Ramadhas et al. (2015) presented a review paper on the factors affecting the cold start

performance of diesel engines and the cold start aids in the modern engine design. The factors were classified into four categories; fuels properties, lubricants, engine geometry and fuel injection strategy. Summary of potential solutions to engine cold-start issues is presented in Table 1.

A vortex tube is a device without moving mechanical parts, which converts a gas flow initially homogeneous in temperature into two separate flows of differing temperatures, as shown in Fig. 2. It separates compressed gas stream into a low total temperature region and a high one. Such a separation of the flow into regions of low and high total temperature is referred to as the temperature (or energy) separation effect. The vortex tube contains the following parts: one or more inlet nozzles, a vortex chamber, a cold-end orifice, a hot-end control valve and a tube. Vortex tubes have widely been used in various applications where compactness, safety, and low equipment cost are basic factors: heating and cooling applications, gas liquefaction, separation of gas mixtures, drying of gases, chemical industry, electric production, snow making, etc. (Ahlborn et al., 1994; Cockerill, 1998; Gao, 2005; Yilmaz et al., 2009; Çelik, 2007; Yıldız, 2009).

Numerous experimental and theoretical research has been done on vortex tubes. There are, however, a limited number of studies related to the use of vortex tubes in internal combustion engines. Phatak and Nakamura (1983a,b) investigated the transition characteristics of diesel engines to cold first motion in a single-cylinder research engine. Engine cooling was achieved by circulating chilled alcohol through the engine. Cold air was supplied with the help of compressed air and three vortex tubes. The combustion air temperature was controlled by adjusting the cold air fraction of the vortex tubes. Lindberg and Lewis (2001) received a patent to use a vortex tube in an engine, to cool air prior to the air entering the intake manifold to improve the performance of the engine by increasing volumetric efficiency. By employing different structural interconnections of the vortex tube with the turbocharger or supercharger, compressed air is cooled prior to entering the engine's intake manifold. In order to improve engine performance and reduce emissions of pollutants, it is found to be advantageous to cool the exhaust gases that are being recirculated by the use of various devices, such as air-to-air coolers, water to air coolers, or other heat transfer devices. In a patent by Holtman and Cavanagh (2005), vortex tube was suggested to be used for cooling recirculated exhaust gases. A vortex tube was suggested to be used in exhaust system of a diesel engine for both cooling of recirculated gas and provision of comfort temperature of exhaust gas on the input in oxidation catalyst to provide an efficient operation at all diesel functioning modes. Kukis et al. (2015) presented the results of vortex tube usage in exhaust gas recirculation system of a diesel engine. The usage of the vortex tube allowed reducing the temperature of recirculated gas up to 60 °C and significantly diminished the content of nitrogen oxide and particulate matter in exhaust gases of an engine at general operation modes.

The basic motivation of the limited number of researches mentioned above was to reduce the temperature of the air or recirculating gas to the engine in order to increase the volumetric efficiency of the engine. In all of these studies, cold air from the cold outlet of the vortex tube was used. There is no study using hot air from the hot outlet of the vortex tube in order to improve the cold start characteristics of diesel engines. In this study, a vortex tube was used to increase the intake air temperature in a six cylinders, four stroke and direct injection diesel engine of a truck. The hot air obtained from the hot outlet of the vortex tube was mixed with the air coming from the inlet of the intake manifold and the warmer air is sent to the cylinders, which could contribute to the trouble free operation of the engine in cold conditions. Our previously published study (Çelik

**Table 1**  
Summary table of potential solutions to engine cold-start issues (Roberts et al., 2014).

	Lubricant warm-up	Combustion warm-up	Catalytic converter functionality	Vehicle integration	Overall effect on fuel economy	Overall effect on emissions quality
Exhaust gas energy recovery	Positive	Positive	Negative	Negative	Positive	Neutral
Use of TBCs	Neutral	Positive	Positive	Positive	Positive	Positive
Standard insulation	Positive	Positive	Positive	Negative	Positive	Positive
Pre heated coolant	Positive	Positive	Positive	Negative	Positive	Positive
Coolant flow control	Negative	Positive	Positive	Positive	Positive	Positive
Lubricant flow diversion	Positive	Neutral	Neutral	Positive	Positive	Positive
Stop start technology	Negative	Negative	Negative	Positive	Positive	Neutral
Phase change material	Negative	Negative	Negative	Positive	Neutral	Neutral

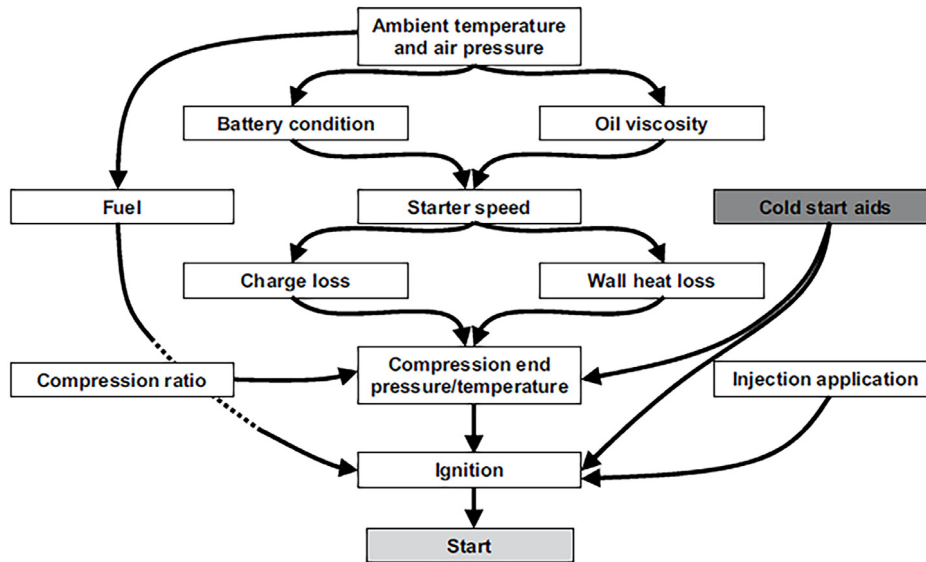

**Fig. 1.** Influencing parameters on cold start (Last et al., 2008).

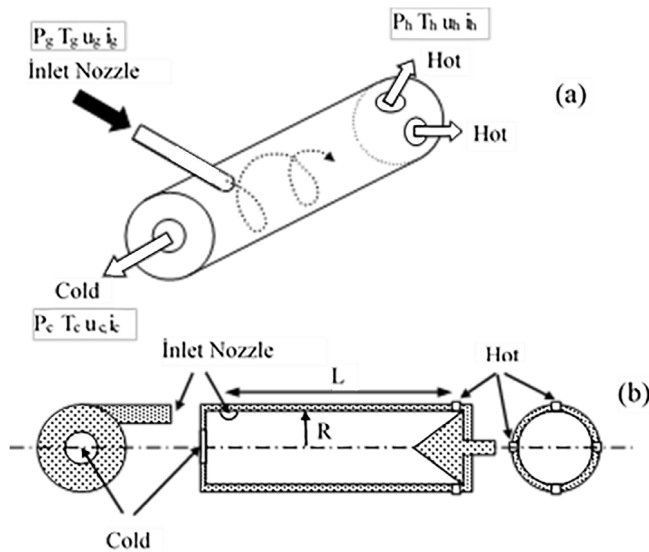

**Fig. 2.** Vortex tube. (a) Sketch of operation and definition of parameters. (b) Geometry of tube (Ahlborn et al., 1994).

et al., 2013) gives preliminary study results. It presents only in-cylinder pressure and engine speed variation at 0 °C ambient temperatures with/without using vortex tube. In this study, in-cylinder pressure and engine speed variation at -5 °C, 0 °C and +4 °C ambient temperatures with/without using vortex tube are obtained and the results are compared with each other. In

**Table 2**  
Test engine specifications (Çelik, 2012).

Specifications	Values
Engine type	Mercedes OM 401 LA V/1
Type and number of cylinders	V type, 6 cylinders
Bore (mm) x stroke (mm)	125 x 130
Displacement volume (mm <sup>3</sup> )	9572
Compression ratio	16.5:1
Maximum power	230 kW at 2100 rpm
Maximum torque	1340 Nm at 1250 rpm
Idle speed	600: 10 rpm
Valve cut	5-3-6-1-4-2
Oil	Diesel
Cooling system	Water-cooled
Nominal cranking speed	2100 rpm

addition the variation of the intake manifold temperature with ambient air, the variation in the air temperature entering the engine cylinder and the variation in the engine speed for the engine without/with vortex tube are presented in detail. This allowed a detailed study of the effect of using of vortex tubes on cold start characteristics of the diesel engines.

**2. Experimental setup**

Vortex tube was used to improve the cold start performance of a six cylinders, four stroke and direct injection diesel engine of a truck. To increase the engine intake air temperature, the hot exhaust of the vortex tube was connected to the engine intake manifold. Cold start experiments were carried out in Erzurum, one of the coldest cities in Turkey. A schematic layout of the

**Table 3**  
Vortex tube specifications (Yildiz, 2009; Çelik, 2012).

Specifications	Values
Material	Stainless steel
Vortex tube length	106 mm
Inner diameter of vortex tube	11.4 mm
Cold exit hole diameter	6.2 mm
Hot exit hole diameter	11.0 mm
Nozzle height	0.97 mm
Nozzle width	1.41 mm
Flow rate band	226–991 l/min
Number of nozzle holes	5 cold and 5 hot
The minimum operating temperature	−60 °C
Maximum operating temperature	+110 °C

**Table 4**  
Specifications of pressure transducer (Çelik, 2012).

Specifications	Values
Temperature coefficient for accuracy	±0.01%/0 °C
Measuring range, bar	0–200
Precision, pC/bar	16.2
Capacitance, pF	110
Natural frequency, kHz	130
Acceleration accuracy	0.005
Linearity, % FSO	<±0.6

experimental setup used is presented in Fig. 3. The setup consists mainly of diesel engine, vortex tube, and measuring instruments and devices. The experimental setup and the test equipment used for this study are described as follows. See further detailed information in Ref. (Çelik, 2012).

### 2.1. Engine

The engine used in the study is a 9.6 L six cylinder, direct injection diesel engine of a truck and the specifications of the engine are given in Table 2. Vortex tube was used to improve the cold start performance of this engine.

### 2.2. Vortex tube

Vortex tubes are classified by their main technological and design features: flow configuration, the method of heat supply (removal), and how removal of low-pressure gas streams is organized. For the positioning of the cold exhaust, there are two different types: counterflow vortex tubes and parallel flow (uniflow) vortex tubes (Yilmaz et al., 2009). In this study, a counterflow vortex tube, as shown in Fig. 4, is used. The specifications of the vortex tube are given in Table 3. In counterflow vortex tubes the cold exhaust is placed on the other side from the hot exhaust, as shown in Fig. 4. The working gas is tangentially injected into the vortex tube via inlet nozzles positioned next to the cold exhaust. A strongly swirling flow is created and the gas proceeds along the tube. The outer region of the flow is found to be warmer than the inlet gas, while gas towards the center of the tube experiences cooling. Part of the gas in the vortex tube reverses for axial component of the velocity, and it moves from

the hot end to the cold end. An orifice positioned just behind the flow inlets separates the cool central gas, which then exits the tube at the lefthand side. The warm peripheral flow leaves at the righthand side of the tube, where a valve is positioned to allow regulation of the relative quantities of hot and cold gas (Cockerill, 1998; Gao, 2005; Yilmaz et al., 2009; Çelik, 2007; Yildiz, 2009).

Vortex tube needs compressed air for operation. In order to provide the necessary compressed air for the operation of the vortex tube, a diesel engine with compressed air tank was used. These tanks could provide up to 8 bar pressure. The vortex tube has an entry port, cold exit port and a hot exit port. The vortex tube entry port was placed in communication with the air tank's compressed air outlet. This causes the compressed air to enter the vortex tube, and be separated into a hot portion and a cold portion. The hot portion exits the vortex tube hot exit port and is routed to the engine's intake manifold. The cold portion exits the vortex tube cold port and is routed to ambient.

For the engine without vortex tube, after passing through the air filter the ambient air enters the engine cylinders through the intake manifold. The temperature of the air entering the intake manifold is the ambient air temperature and the pressure is atmospheric pressure. For the engine with vortex tube, by passing the compressed air through the vortex tube, hot air is obtained from the hot outlet of the vortex tube and cold air is obtained from the cold outlet. When the engine is first started, the compressed air tank is opened and compressed air is sent to the vortex tube to obtain hot air from the hot outlet end of the vortex tube. This hot air is sent to the engine by mixing with the cold ambient air in the intake manifold, so that the first operation of the motor is made with air with much higher temperature than the ambient air.

### 2.3. Measuring instruments and devices

Variation in the cold starting events was observed by both the cylinder pressure data and the engine crankshaft. Fig. 5 shows a schematic view of the electronic indicator system. In-cylinder pressure was measured in one cylinder. In-cylinder pressure measurement was accomplished using KISTLER quartz pressure transducer connected to a charge amplifier. The technical specifications of the piezoelectric pressure transducer used are given in Table 4. Crank angle was measured by a magnetic shaft encoder. The magnetic shaft encoder was rigidly mounted to the front of the engine and connected to the crank shaft with a flexible coupler. The data from charge amplifier including cylinder pressure and encoder were collected by National Instruments high speed M series, 6250 model, 1.25 MS/s DAQ Card in a Intel(R) 4 CPU 2.00 GHz personal computer. Data were recorded using a software package NI-DAQmx obtained from National Instruments Corp. Analysis of in-cylinder pressure and the variation of engine speed according to the crank angle data during starting engine were performed by using software developed in MATLAB (Çelik et al., 2013).

At different locations, temperature measurements were made using a data acquisition card and a personal computer in order to provide the same initial conditions for experiments with and

**Table 5**  
Transition characteristics to stable regime and fuel consumption data.

	−5 °C		0 °C		+4 °C	
	Without vortex	With vortex	Without vortex	With vortex	Without vortex	With vortex
Cranking time (s)	15	10	3	2	2	2
Time to reach the idling conditions (s)	8	7	15	10	2	2
Time to reach the stable regime (s)	23	17	18	12	4	4
Steady state idle speed (rpm)	480	500	530	565	565	580
Fuel consumption (ml/s)	0.624	0.614	0.483	0.442	0.385	0.320



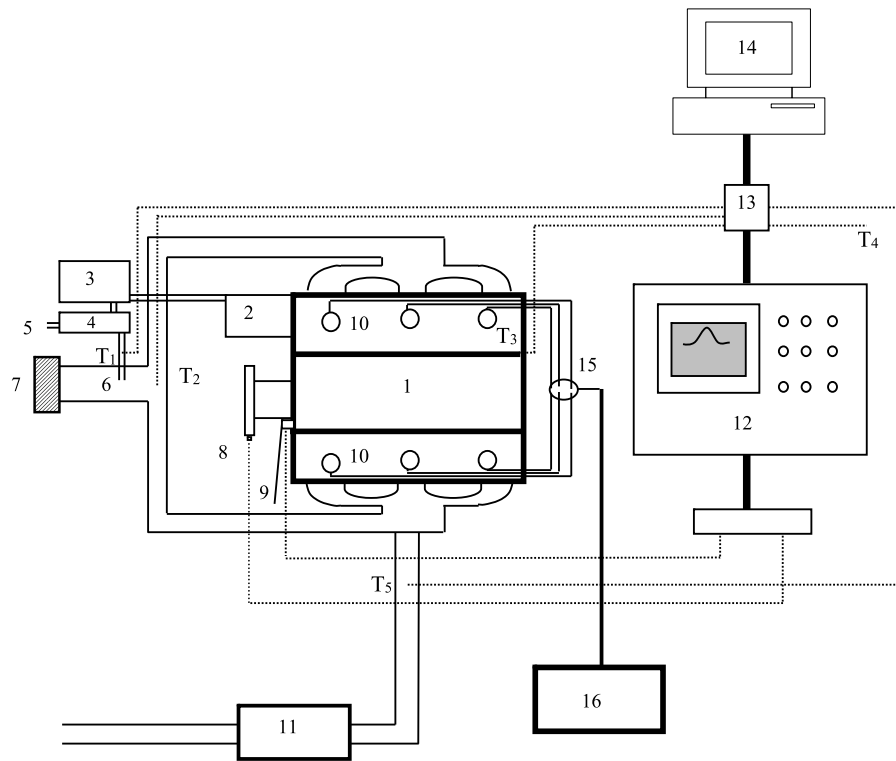

1- Engine	9- Piezoelectric transducer
2- Air compressor	10- Injectors
3- Air tanks	11- Muffler
4- Vortex tube	12- Charge amplifier ad oscilloscop
5- Cold exhaust of vortex tube	13- Analog to digital converter
6- Hold exhaust of vortex tube	14- Personel computer
7- Air filter	15- Fuel pump
8- Shaft endecoder	16- Fuel metering unit

### Locations of thermocouples

T<sub>1</sub> - Hot outlet temperature of vortex tube

T<sub>2</sub> - Intake manifold air temperature

T<sub>3</sub> - Air temperature entering the cylinder

T<sub>4</sub> - Ambient air temperature

T<sub>5</sub> - Exhaust gas temperature

Fig. 3. Schematic diagram of the experimental setup (Çelik et al., 2013; Çelik, 2012).

without vortex tube. Thus, the vortex tube hot outlet temperature, the engine air inlet temperature, the engine exhaust gas temperature, the engine coolant outlet temperature and ambient air temperature were measured. All of the thermocouples were type-K (Cr–Al). The thermocouples used had typically an accuracy of 0.5 °C. Temperature measuring locations and points of thermocouples are presented in Fig. 3. All the measurements were performed on the engine not disassembled from truck.

#### 2.4. Test procedure

Six series of experiments were carried out at –5, 0 and 4 °C ambient air temperatures with and without using vortex tube. First series of experiments were performed without using vortex

tube, and then second series of experiments with using vortex tube at the same level of temperature.

Before the engine was started for vortex tube experiments, the hot air from hot exhaust of vortex tube was transferred into the engine intake manifold for about 3 s in order to take it into the cylinders for the first cycles. Then, the engine was started and hot air was continuously transferred into the manifold. Subsequently followed data recording using NI-DAQmx data acquisition system. The engine operated with hot air for the period until stable, and after the regeneration, the vortex tube was disengaged and the engine was switched to normal operation. The cold start period included the cranking period and the acceleration period to reach peak engine speed.

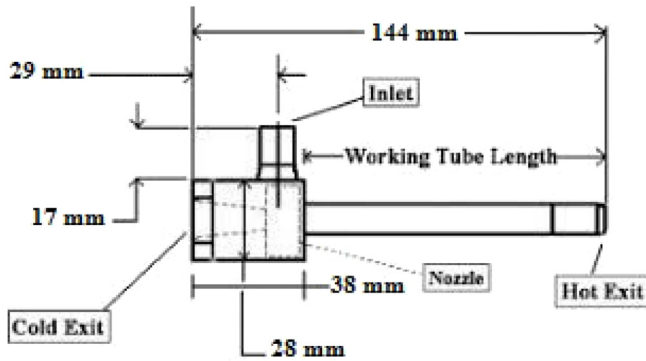

Fig. 4. A schematic diagram and photograph of the counterflow vortex tube used in the experiments (Yıldız, 2009; Çelik, 2012).

### 3. Results and discussions

#### 3.1. Intake manifold air temperature

Fig. 6 shows variation in intake manifold air temperature for various ambient air temperatures for the engine without vortex tube. Variation in intake manifold air temperature for various ambient air temperatures for the engine with vortex tube is shown in Fig. 7. It can be seen that the intake manifold air temperature increases as the ambient air temperature increases in both for the engine without vortex tube and for the engine with vortex tube.

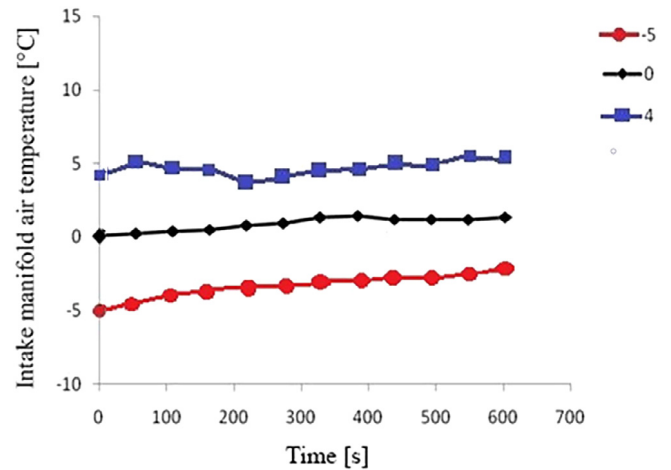
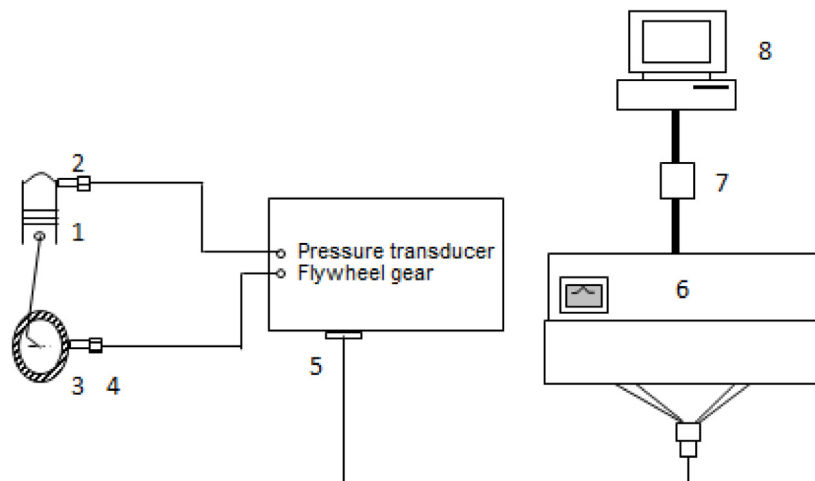

Fig. 6. Variation of intake manifold air temperature with ambient air temperature for the engine without vortex tube.

Comparison of the engine without vortex tube and the engine with vortex tube in terms of the inlet manifold air temperatures for  $-5$ ,  $0$  and  $+4$  °C ambient air temperatures is given in Figs. 8–10, respectively. The examination of these figures reveals that there is an increase in the intake manifold air temperatures of up to  $10$  °C for the engine with vortex tube depending on the ambient air temperatures. This temperature increase is expected to improve the cold start characteristics of the diesel engine.

#### 3.2. Air temperature entering the engine cylinder

Variations in the air temperature entering the engine cylinder without and with vortex tube are shown in Figs. 11 and 12, respectively. It can be seen that the air temperature entering the engine cylinder increases as the ambient air temperature increases in both for the engine without vortex tube and for the engine with vortex tube. The following inferences can be made from these figures:



1- Cylinder	5- Interface
2- Piezoelectric pressure transducer	6- Oscilloscope
3- Flywheel	7- Interface
4- Flywheel inverter	8- Personal computer

Fig. 5. A schematic view of the electronic indicator system (Çelik, 2012).

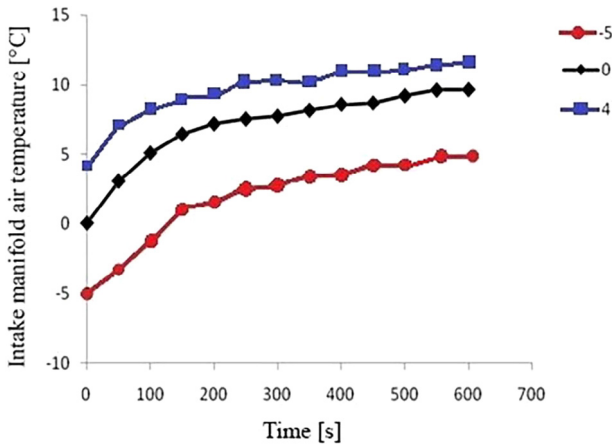

Fig. 7. Variation of intake manifold air temperature with ambient air temperature for the engine with vortex tube.

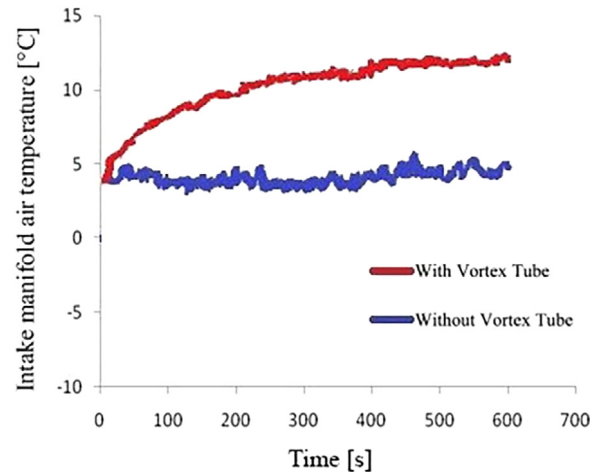

Fig. 10. Variation in intake manifold air temperature ( $T_{\text{ambient}} = +4$  °C).

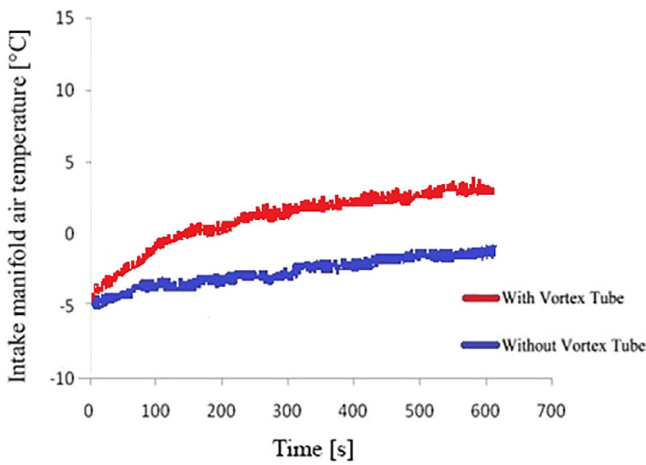

Fig. 8. Variation in intake manifold air temperature ( $T_{\text{ambient}} = -5$  °C).

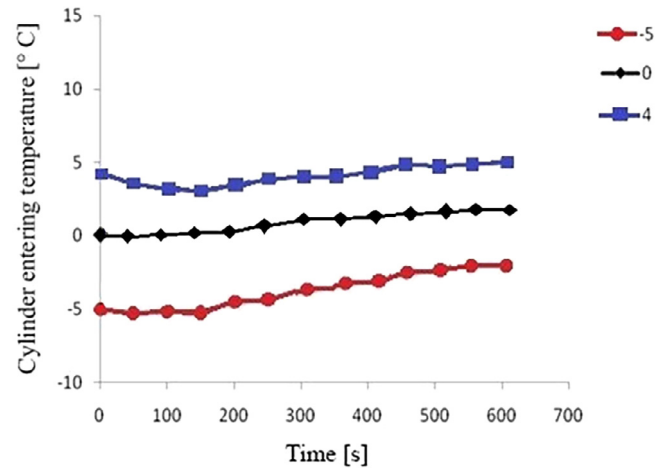

Fig. 11. Variation in the air temperature entering the engine cylinder for the engine without vortex tube.

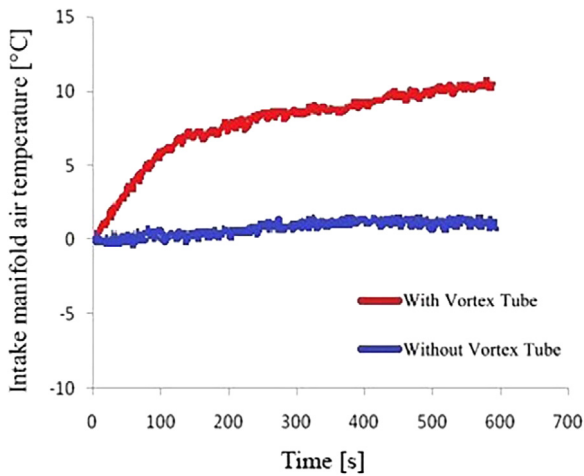

Fig. 9. Variation in intake manifold air temperature ( $T_{\text{ambient}} = 0$  °C).

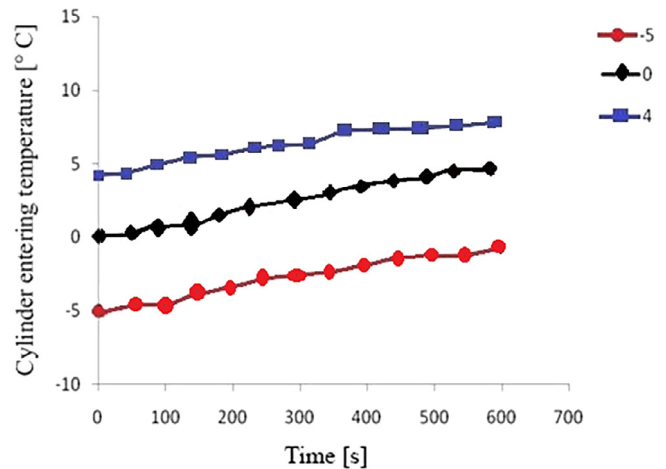

Fig. 12. Variation in the air temperature entering the engine cylinder for the engine with vortex tube.

(a) The air temperature entering the engine cylinder increases as time passes from the time the engine is first started. The same result was obtained when the vortex tube was used. This can be attributed to the heating of the engine, intake manifold and pipes as the engine starts.

(b) The use of the vortex tube allows warmer air to enter the engine.

(c) The difference between the air temperature entering the engine cylinder for the engine with vortex tube and for the engine



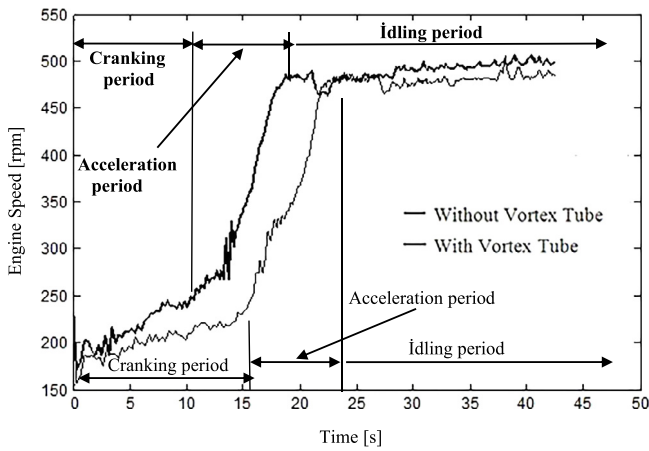

Fig. 13. Variation in engine speed ( $T_{\text{ambient}} = -5 \text{ }^\circ\text{C}$ ).

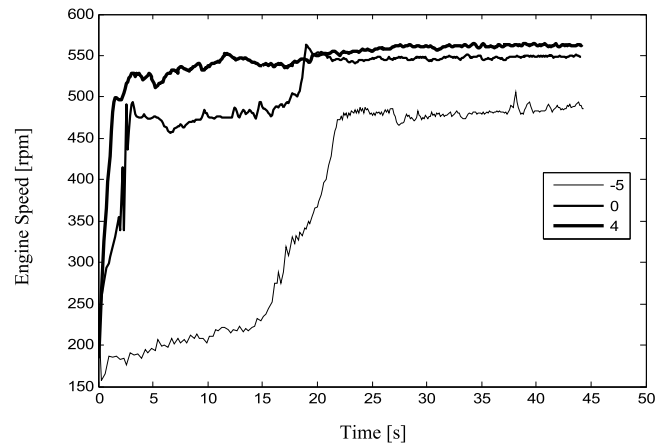

Fig. 16. Variation in the engine speed for the engine without vortex tube.

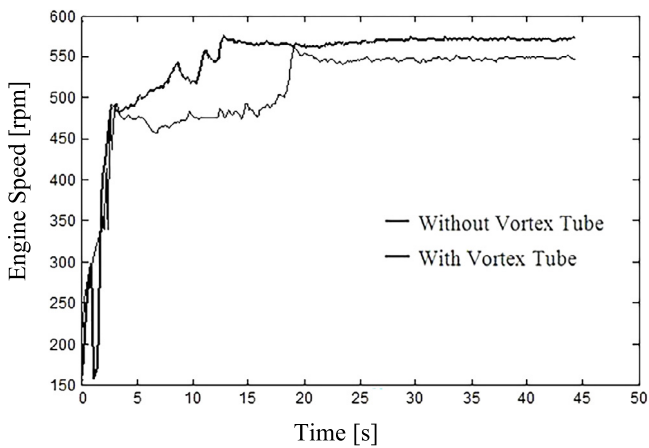

Fig. 14. Variation in engine speed ( $T_{\text{ambient}} = 0 \text{ }^\circ\text{C}$ ).

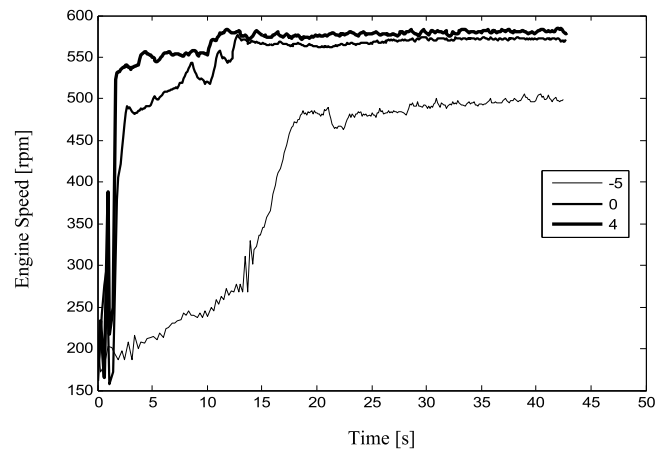

Fig. 17. Variation in the engine speed for the engine with vortex tube.

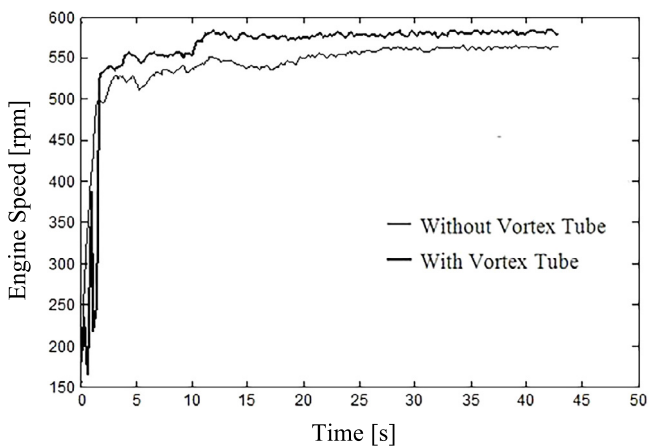

Fig. 15. Variation in engine speed ( $T_{\text{ambient}} = +4 \text{ }^\circ\text{C}$ ).

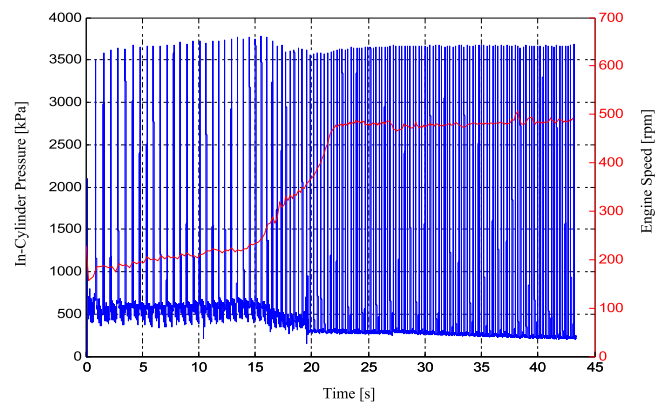

Fig. 18. Pressure and engine speed variation for the engine without vortex tube ( $T_{\text{ambient}} = -5 \text{ }^\circ\text{C}$ ).

without vortex tube is relatively low during the start-up period, this difference increases with time.

### 3.3. Engine speed

When observing the engine speed variation during cold start, it follows some stages of accelerating and faltering, and finally reaches the governing speed to complete the starting. The period

could be divided into several stages of accelerating or faltering. The time for the engine to reach a stable speed is one of the important parameters of engine performance. How the vortex tube affects the engine speed is shown in Figs. 13–17. The following points can be highlighted: It can be deduced that it takes a certain amount of time for the engine to reach a stable speed. This period varies according to the ambient air temperature. It takes approximately 23 s for the engine to reach the stable speed at  $-5 \text{ }^\circ\text{C}$  ambient temperature. This period becomes about 18

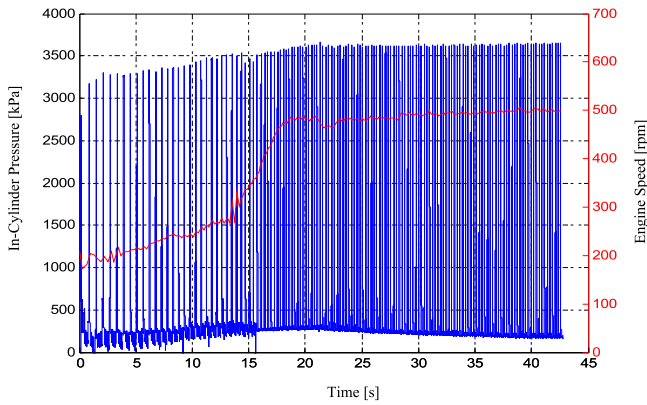

**Fig. 19.** Pressure and engine speed variation for the engine with vortex tube ( $T_{\text{ambient}} = -5\text{ }^{\circ}\text{C}$ ).

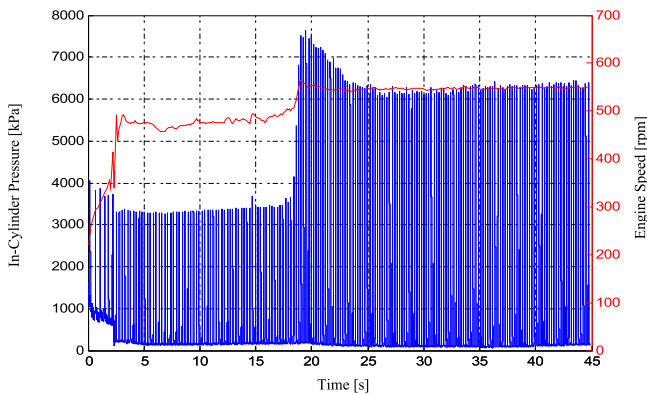

**Fig. 20.** Pressure and engine speed variation for the engine without vortex tube ( $T_{\text{ambient}} = 0\text{ }^{\circ}\text{C}$ ).

s at an ambient temperature of  $0\text{ }^{\circ}\text{C}$ , about 4 s at an ambient temperature of  $+4\text{ }^{\circ}\text{C}$ . Using the vortex tube provided a higher speed at all ambient temperatures. This means that the use of the vortex tube allows the engine to reach a stable speed in a shorter time.

### 3.4. In-cylinder pressure

Variations in-cylinder pressure and engine speed at  $-5\text{ }^{\circ}\text{C}$  ambient air temperature for the engine without and with vortex tube are shown in Figs. 18 and 19, respectively. Figs. 20 and 21 show in-cylinder pressure and engine speed variation at  $0\text{ }^{\circ}\text{C}$  ambient air temperature for the engine without and with vortex tube, respectively. In-cylinder pressure and engine speed variation at  $+4\text{ }^{\circ}\text{C}$  ambient air temperature for the engine without and with vortex tube are shown in Figs. 22 and 23, respectively. As can be seen from all these figures, the engine speed increases as the change frequency of the in-cylinder pressure increases. For the three different temperature levels, during the engine start the combustion did not occur in about the first three cycles in the cylinder. In the following cycles, the combustion was realized but the engine could not be started because a sufficient amount of energy could not be transferred to the crankshaft. The details of the events encountered and the contributions of the vortex tube during the engine start for the three temperature conditions are described below.

Fig. 18 presents in-cylinder pressure and engine speed variation at  $-5\text{ }^{\circ}\text{C}$  ambient air temperature for the engine without vortex tube. Since the ambient air temperature was low ( $T_{\text{amb}} =$

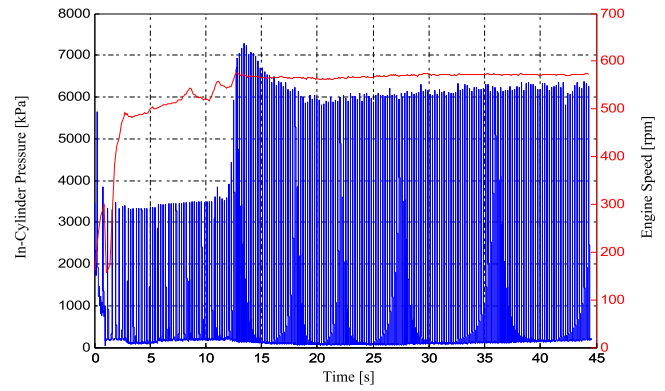

**Fig. 21.** Pressure and engine speed variation for the engine with vortex tube ( $T_{\text{ambient}} = 0\text{ }^{\circ}\text{C}$ ).

$-5\text{ }^{\circ}\text{C}$ ), the air temperature inside the cylinder remained low during the engine start (Fig. 11). The low temperature of the air entering the cylinder and the engine block delayed the ignition time. Therefore, no combustion occurred at the first crankshaft revolutions. The crankshaft was then driven only by the starter engine, which took about 15 s. This period is the total cranking duration. When the cylinder pressure data is examined, it is seen that the frequency and maximum pressures continue to be low during this period. During this period, the engine speed is about 220 rpm. Then, the engine speed starts to increase, but the engine has not yet fully reached idling conditions, and the main reason for this is the lack of low combustion, due to low temperatures. The engine has now taken about 8 s to reach the idling conditions. The total transition time to stable idle conditions lasted approximately 23 s. Then, the engine speed rises to about 500 rpm and the engine has now reached idle conditions.

In-cylinder pressure and engine speed variation at  $-5\text{ }^{\circ}\text{C}$  ambient air temperature for the engine with vortex tube are shown in Fig. 19. Comparison of the results for the engine with vortex tube with those for the engine without vortex tube shows that the vortex tube has a positive contribution to the engine start. While the total cranking time was around 15 s for the engine without vortex tube, it decreased to 10 s for the engine with vortex tube. Then, the transition time to idling conditions lasted for 7 s and the total idling time was approximately 17 s. This period was determined to be approximately 23 s in the engine without vortex tube.

The examination of Fig. 20, that presents in-cylinder pressure and engine speed variation at  $0\text{ }^{\circ}\text{C}$  ambient air temperature for the engine without vortex tube reveals that cranking period lasted approximately 3 s. Then the engine speed increased to approximately 480 rpm and this period continued for approximately 15 s. At the end of this period, the engine has not yet fully reached to the idling conditions. Then, the engine speed rose to approx. 530 rpm and the engine has now reached to the idling conditions.

Fig. 21 shows in-cylinder pressure and engine speed variation at  $0\text{ }^{\circ}\text{C}$  ambient air temperature for the engine with vortex tube. Comparison of the results for the engine with vortex tube with those for the engine without vortex tube shows that the vortex tube has a positive contribution to the engine start. While the cranking time around 3 s for the engine without vortex tube, it decreased to 2 s for the engine with vortex tube. Subsequently, the engine reached the idling conditions in a much more stable manner and the engine speed increased to 510 rpm in a total of 4 s. In total, the transition time to idling conditions was approximately 12 s. This period was determined as about 18 s for the engine without vortex tube.

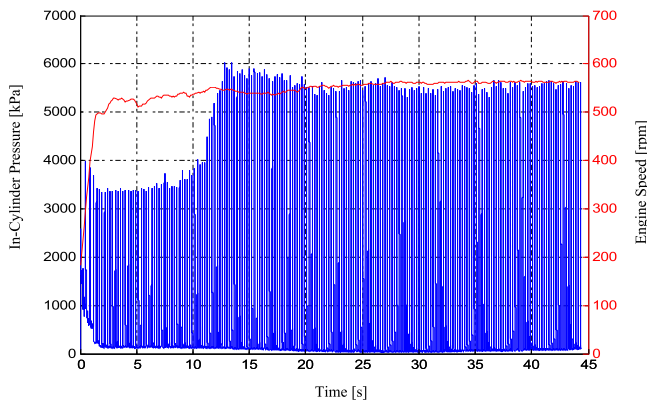

**Fig. 22.** Pressure and engine speed variation for the engine without vortex tube ( $T_{\text{ambient}} = +4\text{ }^{\circ}\text{C}$ ).

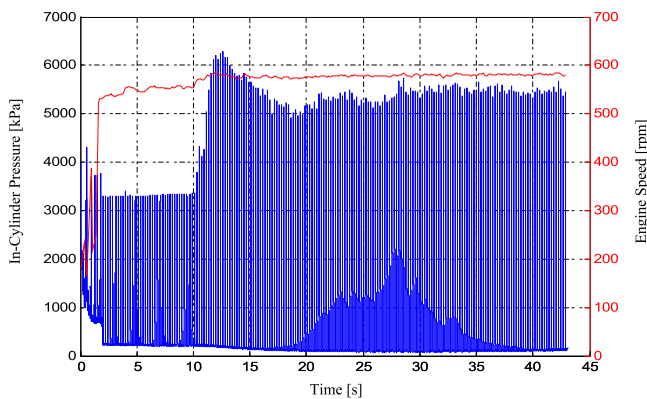

**Fig. 23.** Pressure and engine speed variation for the engine with vortex tube ( $T_{\text{ambient}} = +4\text{ }^{\circ}\text{C}$ ).

In-cylinder pressure and engine speed variation at  $+4\text{ }^{\circ}\text{C}$  ambient air temperature for the engine without vortex tube are shown in Fig. 22. The three stages that occurred at  $-5\text{ }^{\circ}\text{C}$  and  $0\text{ }^{\circ}\text{C}$  for the engine without vortex tube were also observed at this temperature, but reaching to cranking and idle conditions was completed in a much shorter time. After approximately 3 s, the crankshaft reached the engine speed of 565 rpm, which is the idle speed of the engine.

The comparison of Fig. 23 with Fig. 22 shows that the use of the vortex tube has little positive effect on the events experienced during the cranking period, but it increased the steady state idle speed for the ambient temperature of  $+4\text{ }^{\circ}\text{C}$ . The steady state idling speed was approximately 565 rpm when not using the vortex tube, but this value increased to approximately 580 rpm with the use of the vortex tube.

The cranking time, the time to reach the idling conditions and the time to reach the stable regime for the engine without vortex tube and with vortex tube cases are shown in Table 5. Table 5 also presents fuel consumption data. Examination of Table 5 reveals that fuel consumption is reduced by using vortex tube for the same ambient air temperature.

#### 4. Conclusions

This study aims the improvement of diesel engine startability under low temperatures by vortex tubes. For this purpose, a diesel engine experiment system with vortex tube was established and experimental studies were conducted. A counterflow vortex tube was used to increase the intake air temperature in

a six cylinders, four stroke and direct injection diesel engine of a truck. The compressed air required for the operation of the vortex tube was provided from the air tank of the compressed-air brake system of the truck. Experiments were conducted for ambient air temperatures of  $-5$ ,  $0$  and  $+4\text{ }^{\circ}\text{C}$  both for the engine without vortex tube and the engine with vortex tube. The main conclusions are as follows:

(a) By using the vortex tube, higher air temperatures were obtained in the intake manifold. There was an increase in the intake manifold temperatures of up to  $10\text{ }^{\circ}\text{C}$  for the engine with vortex tube depending on the ambient air temperatures.

(b) The use of the vortex tube allowed warmer air to enter the engine. There was an increase in the air temperatures entering the engine cylinder of up to  $3.5\text{ }^{\circ}\text{C}$  for the engine with vortex tube depending on the ambient air temperatures. The warmer air was found to improve the cold start characteristics of the diesel engine.

(c) It takes a certain amount of time for the engine to reach a stable speed. The increase in the ambient air temperature reduced the time for the engine to reach a stable speed. Cranking period and total time to reach the idle speed were found to be reduced by using vortex tube. It took about 23 s, 18 s and 4 s for the engine without vortex tube to reach a constant speed at an ambient temperature of  $-5\text{ }^{\circ}\text{C}$ ,  $0\text{ }^{\circ}\text{C}$ ,  $+4\text{ }^{\circ}\text{C}$ , respectively. However, this time decreased to 17 s, 12 s and 4 s for the engine with vortex tube.

(d) The use of the vortex tube at all ambient temperatures provided a higher engine speed. In other words, the use of the vortex tube allowed the engine to reach a stable speed in a shorter time.

(e) It is important to note that vortex tube should be deactivated after the engine warm-up conditions to prevent the negative effect of increasing temperature of intake air on engine volumetric efficiency. After the warmup conditions, cold air from hot exhaust of vortex tube can be transferred to the engine intake manifold or it can be used to improve the efficiency of engine intercooler.

(f) In the diesel engine used in this study, the pressure in the air tanks was around 8 bar. The use of a higher pressure compressor can contribute to a further improvement in the cold starting performance of the diesel engine.

#### References

- Ahlborn, B., Keller, J.U., Staudt, R., Treitz, G., Rebhen, E., 1994. Limits of temperature separation in a vortex tube. *J. Phys. D: Appl. Phys.* 27, 480–488.
- Bent, E., Shayler, P., La Rocca, A., 2013. The effectiveness of stop-start and thermal management measures to improve fuel economy. In: Presented at VTMS 11.
- Brace, C.J., Hawley, G., Akehurst, S., Piddock, M., Pegg, I., 2008. Cooling system improvements-assessing the effects on emissions and fuel economy. *Proc. Inst. Mech. Eng. D* 222 (4), 579–591.
- Broatch, A., Tormos, B., Olmeda, P., Novella, R., 2014. Impact of biodiesel fuel on cold starting of automotive direct injection diesel engines. *Energy* 73, 653–660.
- Bürgin, T., 2011.  $\text{CO}_2$  and emission reduction by means of heat storage in the powertrain. In: Presented at VTMS 10.
- Çelik, A., 2007. The Investigation of Vortex Tubes Experimentally and Theoretically (Master's thesis). Ataturk University, Erzurum, Turkey.
- Çelik, A., 2012. Using of Vortex Tubes in Diesel Engines To Facilitate Startability and To Enhance the Exhaust Emission Characteristics in Cold Conditions (Ph.D. thesis). Ataturk University, Erzurum, Turkey.
- Çelik, A., Ceviz, M.A., Yilmaz, M., Öner, İ.V., Karagöz, Ş., 2013. Effects of using vortex tubes on events during cold start of a direct injection diesel engine. *J. Renew. Sustain. Energy* 5, 021411(1–8).
- Chartier, C., Aronsson, U., Andersson, Ö., Egnell, R., 2009. Effect of injection strategy on cold start performance in an optical light-duty DI diesel engine. *SAE Trans.* 2 (2), 431–442.
- Ciniviz, M., Hasimoglu, C., Sahin, F., Salman, M.S., 2008. Impact of thermal barrier coating application on the performance and emissions of a turbocharged diesel engine. *Proc. Inst. Mech. Eng. D* 222 (12), 2447–2455.

- Cockerill, T.T., 1998. Thermodynamics and Fluid Mechanics of a Ranque–Hilsch Vortex Tube (Ph.D. thesis). University of Cambridge, Cambridge, England.
- Deng, Y., Liu, H., Zhao, X., E, J., Chen, J., 2018. Effects of cold start control strategy on cold start performance of the diesel engine based on a comprehensive preheat diesel engine model. *Appl. Energy* 210, 279–287.
- Desantes, J.M., Garcia-Oliver, J.M., Pastor, J.M., Ramírez-Hernández, J.G., 2011. Influence of nozzle geometry on ignition and combustion for high-speed direct injection diesel engines under cold start conditions. *Fuel* 90 (11), 3359–3368.
- Du, W., Zhao, F.T., 2003. Electronically controlling the system of preheating intake air by flame for diesel engine cold-start. *J. Beijing Inst. Technol. (Engl. Ed.)* 12 (2), 158–161.
- Gao, C., 2005. Experimental Study on the Ranque–Hilsch Vortex Tube (Ph.D. thesis). Technische Universiteit Eindhoven, Eindhoven, Netherlands.
- Gumus, M., 2009. Reducing cold-start emission from internal combustion engines by means of thermal energy storage system. *Appl. Therm. Eng.* 29 (4), 652–660.
- Gupta, R.B., 1988. Cold starting of IC engines. *Def. Sci. J.* 38 (1), 77–85.
- Hara, H., Itoh, Y., Henein, N.A., Bryzik, W., 1999. Effect of Cetane Number with and Without Additive on Cold Startability and White Smoke Emissions in a Diesel Engine. SAE Technical Paper 1999-01-1476.
- Holtman, R.H., Cavanagh, M.S., 2005. Method and apparatus for exhaust gas recirculation cooling using a vortex tube to cool recirculated exhaust gases. United States Patent, US 2005/0091977 A1. US 6, 895, 752 B1.
- Jarrier, L., Champoussin, J.C., Yu, R., Gentile, D., 2000. Warm-Up of a DI Diesel Engine: Experiment and Modeling. SAE Technical Paper 2000-01-0299.
- John, D., Ghodke, P., Gajjarlawar, N., Ing, J.J., 2011. Experiences in Cold Start Optimization of a Multi-Purpose Vehicle Equipped with 22L Common Rail Diesel Engine. SAE Technical Paper 2011-01-0124.
- Kaltakıran, G., Ceviz, M.A., Kaya, F., Güner, E., Efe, Ş., Akolaş, H.İ., 2014. Dizel motor ilk hareket destekeyicisi olarak faz deęiřtiren malzemeler. In: *Otomotiv Teknolojileri Kongresi*.
- Kawamura, H., Yamamoto, S., 1983. Improvement of Diesel Engine Startability By Ceramic Glow Plug Start System. SAE Technical Paper 830580.
- Kobayashi, A., Kurashima, A., Endo, S., 1984. Analysis of cold start combustion in a direct injection diesel engine. *SAE Trans.* 93 (1), 641–648.
- Krause, W., Spies, K.H., 1996. Dynamic Control of the Coolant Temperature for a Reduction of Fuel Consumption and Hydrocarbon Emissions. SAE Technical Paper 960271.
- Kukis, V.S., Omelchenko, E.A., Rznoshinskaia, A.V., 2015. Results of vortex tube usage in diesel exhaust gas recirculation system. *Procedia Eng.* 129, 151–155.
- Last, B., Houben, H., Rottner, M., Stotz, I., 2008. Influence of modern diesel cold start systems on the cold start, warm-up and emissions of diesel engines. In: *8th Stuttgart International Symposium*.
- Law, T., Shayler, P., Pegg, I., 2007. Investigations of sump design to improve the thermal management of oil temperature during engine warm up. In: *Presented at VTMS 8*.
- Lindberg, R.L., Lewis, W.S., 2001. Vortex tube affixed to a turbocharger, supercharger or intake manifold of an engine. United States Patent, US 6, 247, 460 B1.
- Lindl, B., Schmitz, H.G., 1999. Cold Start Equipment for Diesel Direct Injection Engines. SAE Technical Paper 1999-01-1244.
- Liu, H., Zhang, P., Li, Z., Luo, J., Zheng, Z., Yao, M., 2011. Effects of temperature inhomogeneities on the HCCI combustion in an optical engine. *Appl. Therm. Eng.* 31, 2549–2555.
- Liu, F., Zhang, Z., Wua, H., Li, Y., Maa, Y., Li, X., Dua, W., 2017. An investigation on a diesel jet's ignition characteristics under cold-start conditions. *Appl. Therm. Eng.* 121, 511–519.
- Liu, H., Zheng, Z., Yao, M., Zhang, P., Zheng, Z., He, B., Qi, Y., 2012. Influence of temperature and mixture stratification on HCCI combustion using chemiluminescence images and CFD analysis. *Appl. Therm. Eng.* 33–34, 135–143.
- Malozemov, A.A., Bondar, V.N., Kukis, V.S., 2016. Improvement of the forced diesel engines cold starting characteristics by oil injection into the cylinder. *Procedia Eng.* 150, 1149–1155.
- Mertz, R., 1997. Electric intake air heating for small and medium-sized diesel engines. *Mot. Z.* 58 (4), 208–212.
- Osuka, I., Nishimura, M., Tanaka, Y., Miyaki, M., 1994. Benefits of new fuel injection system technology on cold startability of diesel engines improvements on cold startability and white smoke reduction by means of multi injection with common rail fuel system (ECD-U2). *SAE Trans.* 103 (3), 952–962.
- Palanisamy, M., 2013. Characteristics of Cold Start of a Diesel Engine using Jp8 and Ulsd Fuels (Master's thesis). Wayne State University, Detroit, Michigan, USA.
- Pastor, J.V., García-Oliver, J.M., Pastor, J.M., Ramírez-Hernández, J.G., 2011. Ignition and combustion development for high speed direct injection diesel engines under low temperature cold start conditions. *Fuel* 90, 1556–1566.
- Payri, F., Broatch, A., Serrano, J.R., Rodriguez, L.F., Esmoris, A., 2006. Study of the Potential of Intake Air Heating in Automotive DI Diesel Engines. SAE Technical Paper 2006-01-1233.
- Peng, H., Cui, Y., Shi, L., Deng, K., 2008. Effects of exhaust gas recirculation (EGR) on combustion and emissions during cold start of direct injection (DI) diesel engine. *Energy* 33 (3), 471–479.
- Phatak, R., Nakamura, T., 1983a. Cold Startability of Open-Chamber Direct-Injection Diesel Engines-Part I: Measurement Technique and Effects of Compression Ratio. SAE Technical Paper 831335.
- Phatak, R., Nakamura, T., 1983b. Cold startability of open-chamber direct-injection diesel engines-Part II: Combustion chamber design and fuel spray geometry and additional air and glow plug as a starting aid. *SAE Trans.* 92 (3), 1031–1040.
- Ramadhass, A.S., Xu, H., 2016. Improving Cold Start and Transient Performance of Automotive Diesel Engine At Low Ambient Temperatures. SAE Technical Paper 2016-01-0826.
- Ramadhass, A.S., Xu, H., 2018. Intake air heating strategy to reduce cold-start emissions from diesel engines. *Biofuels* 9 (3), 405–414.
- Ramadhass, A., Xu, H., Liu, M.D., Tian, M.J., 2015. Key factors affecting the cold start of diesel engines. *Int. J. Green Energy* <http://dx.doi.org/10.1080/15435075.2014.938748>.
- Ramírez-Hernández, J.G., 2012. Combustion Studies for High Speed Direct Injection Diesel Engines under Low Temperature Cold Start Conditions (Ph.D. thesis). Universidad Politecnica de Valencia, Departamento de Maquinas y Motores Termicos, Spain.
- Roberts, A., Brooks, R., Shipway, P., 2014. Internal combustion engine cold-start efficiency: a review of the problem, causes and potential solutions. *Energy Convers. Manage.* 82, 327–350.
- Roy, M., Calder, J., Wang, W., Mangad, A., Diniz, F., 2016. Cold start idle emissions from a modern tier-4 turbo-charged diesel engine fueled with diesel-biodiesel, diesel-biodiesel-ethanol, and diesel-biodiesel-diethyl ether blends. *Appl. Energy* 180, 52–65.
- Tinprabath, P., Hespel, C., Chanchaona, S., Foucher, F., 2015. Influence of biodiesel and diesel fuel blends on the injection rate under cold conditions. *Fuel* 144, 80–89.
- Tinprabath, P., Hespel, C., Chanchaona, S., Foucher, F., 2016. Impact of cold conditions on diesel injection processes of biodiesel blends. *Renew. Energy* 96, 270–280.
- Wang, Z., Ding, H., Wyszynski, M.L., Tian, J., Xu, H., 2015. Experimental study on diesel fuel injection characteristics under cold start conditions with single and split injection strategies. *Fuel Process. Technol.* 131, 213–222.
- Wang, Z., Li, Y., Wang, C., Xu, H., Wyszynski, M.L., 2016. Near-nozzle microscopic characterization of diesel spray under cold start conditions with split injection strategy. *Fuel* 181, 366–375.
- Will, F., Boretti, A., 2011. A New Method To Warm Up Lubricating Oil To Improve the Fuel Efficiency During Cold Start. SAE Technical Paper 2011-01-0318.
- Xu, Z., Johnson, J.H., 1984. The Design and Testing of a Computer-Controlled Cooling System for a Diesel-Powered Truck. SAE Technical Paper 841712.
- Yıldız, Ö.F., 2009. Vortex Tube Models (Master's thesis). Ataturk University, Erzurum, Turkey.
- Yilmaz, M., Kaya, M., Karagoz, S., Erdogan, S., 2009. A review on design criteria for vortex tubes. *Heat Mass Transf.* 45, 613–632.
- Zammit, J.-P., Shayler, P.J., Gardiner, R., Pegg, I., 2012. Investigating the potential to reduce crankshaft main bearing friction during engine warm-up by raising oil feed temperature. 5 (3). SAE Technical Paper 2012-01-1216.