

Ravaro, Leandro P.; Zanoni, Kassio P. S.; de Camargo, Andrea S.S.

Article

Luminescent Copper(I) complexes as promising materials for the next generation of energy-saving OLED devices

Energy Reports

Provided in Cooperation with:

Elsevier

Suggested Citation: Ravaro, Leandro P.; Zanoni, Kassio P. S.; de Camargo, Andrea S.S. (2020) : Luminescent Copper(I) complexes as promising materials for the next generation of energy-saving OLED devices, Energy Reports, ISSN 2352-4847, Elsevier, Amsterdam, Vol. 6, Iss. 4, pp. 37-45,
<https://doi.org/10.1016/j.egy.2019.10.044>

This Version is available at:

<https://hdl.handle.net/10419/244005>

Standard-Nutzungsbedingungen:

Die Dokumente auf EconStor dürfen zu eigenen wissenschaftlichen Zwecken und zum Privatgebrauch gespeichert und kopiert werden.

Sie dürfen die Dokumente nicht für öffentliche oder kommerzielle Zwecke vervielfältigen, öffentlich ausstellen, öffentlich zugänglich machen, vertreiben oder anderweitig nutzen.

Sofern die Verfasser die Dokumente unter Open-Content-Lizenzen (insbesondere CC-Lizenzen) zur Verfügung gestellt haben sollten, gelten abweichend von diesen Nutzungsbedingungen die in der dort genannten Lizenz gewährten Nutzungsrechte.

Terms of use:

Documents in EconStor may be saved and copied for your personal and scholarly purposes.

You are not to copy documents for public or commercial purposes, to exhibit the documents publicly, to make them publicly available on the internet, or to distribute or otherwise use the documents in public.

If the documents have been made available under an Open Content Licence (especially Creative Commons Licences), you may exercise further usage rights as specified in the indicated licence.



<https://creativecommons.org/licenses/by-nc-nd/4.0/>



Review article

Luminescent Copper(I) complexes as promising materials for the next generation of energy-saving OLED devices



Leandro P. Ravaro, Kassio P.S. Zanoni, Andrea S.S. de Camargo*

Laboratory of Spectroscopy of Functional Materials, São Carlos Institute of Physics, University of São Paulo, PO Box 369, 13560-970 São Carlos, SP, Brazil

ARTICLE INFO

Article history:

Received 30 June 2019

Received in revised form 13 October 2019

Accepted 30 October 2019

Available online 11 November 2019

Keywords:

Light emitting devices

OLED

TADF

Cu(I) complexes

ABSTRACT

The increasing demand for electrical energy by a longer living and increasing population justifies the search for new, more efficient lighting systems. In this context, organo-metallic compounds have been largely investigated as efficient materials for organic light emitting diodes (OLEDs). Special interest has been demonstrated for neutral copper(I) complexes due to their high emission quantum efficiency and fast photoluminescence response time. In particular, Cu(I) complexes that present thermally activated delayed fluorescence (TADF) are one of the most promising materials for the next generation of lighting devices. In this work, we present an overview of the development of OLEDs, by comparing the mechanisms and efficiencies of different complexes and discussing the reasons why Cu(I) complexes have potential to be one of the most efficient alternatives for energy saving in lighting.

© 2019 The Authors. Published by Elsevier Ltd. This is an open access article under the CC BY-NC-ND license (<http://creativecommons.org/licenses/by-nc-nd/4.0/>).

Contents

1. Introduction.....	37
2. Fundamentals of OLEDs.....	38
2.1. Architecture of OLED assemblies.....	38
2.2. Operating principle.....	38
2.3. Internal emission quantum yield.....	39
3. Copper(I) complexes.....	39
4. Conclusions and perspectives.....	42
Acknowledgments.....	43
References.....	43

1. Introduction

The consumption of electric energy has been increasing due to the increase in world population and the consequent higher demand for modern electronic and lighting devices. This way, awareness has been raised to the need of alternative ways to reduce energy consumption by developing more efficient light emitting alternatives. For example, the luminous efficiency for conventional light bulbs is ~ 16 lm/W and for fluorescent lamps it is 70 lm/W, whereas lamps based on light-emitting diodes (LEDs) can reach up to 300 lm/W (Khanna, 2014). Therefore, LED devices have been progressively replacing old lighting technologies. Energy (2008), MacIsaac et al. (1999), Mottier (2009) and Trifunovic et al. (2009). A state of the art LED is usually based

on inorganic III-nitride semiconductors such as GaN and GaAs in which light is generated from a central point (Li et al., 2018). Organic light-emitting diodes (OLEDs) are also efficient emitting systems, however in their case light is generated planarly (Evans et al., 2006; Fyfe, 2009; Krasnov, 2003; Lee et al., 2017; Minaev et al., 2014a; Xiao et al., 2011) from an emissive layer composed essentially by an organic material (undoped or doped).

In this work, we present an overview of the development of OLED devices, in particular those based on Cu(I) complexes, which show potential to be one of the most efficient alternatives for energy saving in lighting. A review of the literature is presented and work developed at our workgroup at the São Carlos Institute of Physics, University of São Paulo, during the last five years, is also discussed in light of possible applications.

* Corresponding author.

E-mail address: andreas@ifsc.usp.br (A.S.S. de Camargo).

2. Fundamentals of OLEDs

The electroluminescence of organic compounds was observed for the first time in 1953 when a high voltage was applied to acridine orange (Bernanose and Vouaux, 1953). The first OLED device was built in 1987, after 3 decades of studies and developments (Tang and VanSlyke, 1987). The construction of a device in a layered structure decreased the operating voltage, making its commercial distribution viable. OLEDs have the advantages of being flexible, not warming up like conventional lamps, being able to display tunable colors and brightness, and not containing toxic metals. They have been progressively used in the manufacturing of last generation displays, smartphones, lighting ceilings and TV screens with higher contrast, brightness, lightweight and lower power consumption when compared to older technologies such as LCD (Zanoni et al., 2015).

2.1. Architecture of OLED assemblies

The architecture of an OLED consists of a layer-by-layer stack of thin films, sequentially deposited in high vacuum or via wet-deposition techniques. To that end, among the most common thin film deposition methods are vacuum-assisted thermal evaporation, plasma-assisted evaporation (R.F. magnetron sputtering) and spin-coating.

In the simplest device, monolayer configuration, the emissive layer (EML) is sandwiched between two injection electrodes. In this configuration, low quantum emission efficiency is observed due to the large disparity between holes and electron transport mobility for most organic materials. This causes random electron–hole recombination in the emissive layer, concentrating the formation of excitons near the interface of the electrodes with efficiency losses (see Fig. 1; and Section 2.2 for more information about the working mechanism). This problem can be minimized by using a multi-layer configuration of organic compounds with specific charge transport properties, so the electron–hole recombination region becomes more ordered within the emissive layer, and distant from the electrodes. In these more-complex devices, the active EML is positioned in between p- and n-type organic/inorganic semiconductor buffer layers that minimize the energy barrier for charge passage and selectively transport one sort of charge carrier while blocking the opposite charge carrier. These layers are usually referred to as HTL (hole transport layer) and ETL (electron transfer layer). Both, mono- and multiple layers architectures can be built on various types of substrates, including flexible ones that add to modern design flexibility.

2.2. Operating principle

When an external voltage is applied between the electrodes, holes are injected through the anode and electrons are injected through the cathode. The holes are transported through the HTL to reach the EML and fill the highest occupied molecular orbital (HOMO). On the other hand, electrons percolate through the ETL to fill the lowest unoccupied molecular orbital (LUMO) in the EML.

The injected electrons and holes then migrate within the emissive layer until they are very close to each other in a region known as “recombination zone”. As the electron approaches the hole, Coulomb interaction between them becomes effective until the separation between electron and hole fall below a critical value where both particles can be considered to form a bound state called exciton (the wave functions of both particles start to overlap when the electron approaches the hole within a radius of about 15 Å). According to exciton statistics (Penfold et al., 2018; Yang et al., 2017), electrons and holes can form four different

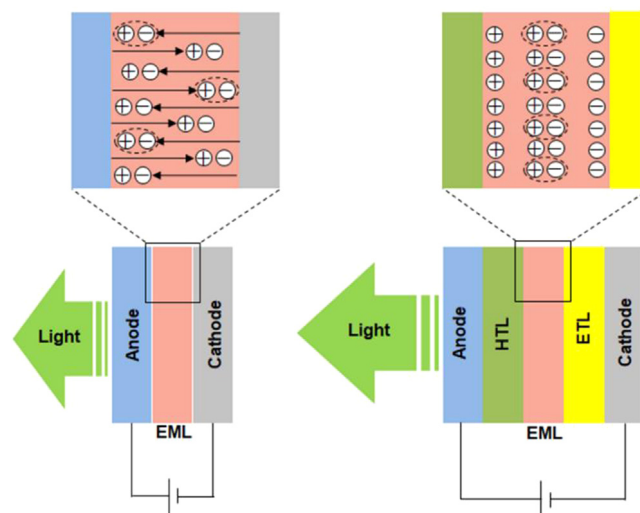

Fig. 1. Structure of OLED emitting devices. Left: in the monolayer configuration the electron–hole recombination occurs in different regions in the emissive layer, and the greatest loss of quantum efficiency is due to recombination near the electrodes. Right: in a more complex configuration, the electronic mobility is balanced by HTLs and ETLs directing the recombination of respective charge carriers to the center of the EML.

exciton states, one singlet and three triplet in a ratio of 1:3. All four states are nearly degenerate, hence an even population of all states is expected. The spins of the produced excitons remain unchanged until they fill the excited states of the emitting molecule, which follows multiplicity rule: singlet excitons can only populate singlet molecular states and triplet excitons only populate triplet molecular states. Consequently, 75% of the emitting molecules will be in their lowest-lying triplet excited state (T_1) while only 25% of the molecules will be in their lowest-lying singlet excited state (S_1).

For most purely organic fluorescent emitters, light is produced via fluorescence, i.e. a rapid radiative decay from S_1 to the ground state S_0 (part of the energy of S_1 is also lost by non-radiative decay). Intersystem crossings (ISC) from S_1 to T_1 is a spin-forbidden process (due to the absence of effective spin-orbit coupling – SOC) and the rate for such a process is significantly slower (milliseconds) than the faster fluorescence (pico- to nanoseconds). Consequently, in OLEDs based on fluorescent compounds, ISC is neglected (see Fig. 2) and all of the triplet excitons decay non-radiatively, therefore most of the energy produced in the electron–hole recombination (at least 75%) is lost and the maximum internal quantum efficiency is limited to a maximum of 25% (Minaev et al., 2014a). The above description applies to the emitters in the first generation of OLEDs.

The development of other compounds capable of converting the energy from triplet states into phosphorescence emission has been under intense investigation. Most strategies rely on increasing spin-orbit coupling (SOC), which in turn can drastically increase the rates of ISC, becoming quicker than the $S_1 \rightarrow S_0$ fluorescence (Hedley et al., 2008; Hsu et al., 2011; Tschierlei et al., 2014; Yersin and Donges, 2001). Under high SOC conditions and a 10^3 cm^{-1} separation between S_1 and T_1 states, emission from the singlet state will not be observed as practically all singlet energy will be transferred to T_1 before fluorescence can occur. This mechanism where all excitons are collected by T_1 is called triplet harvesting. SOC also adds significant allowance to the otherwise spin-forbidden phosphorescence from T_1 to S_0 , with decay times of nano- to microseconds (Cheng et al., 2013; Hofbeck and Yersin, 2010; Rausch et al., 2009; Wang et al., 2014; Yersin et al., 2011). As a consequence, OLEDs utilizing SOC-induced

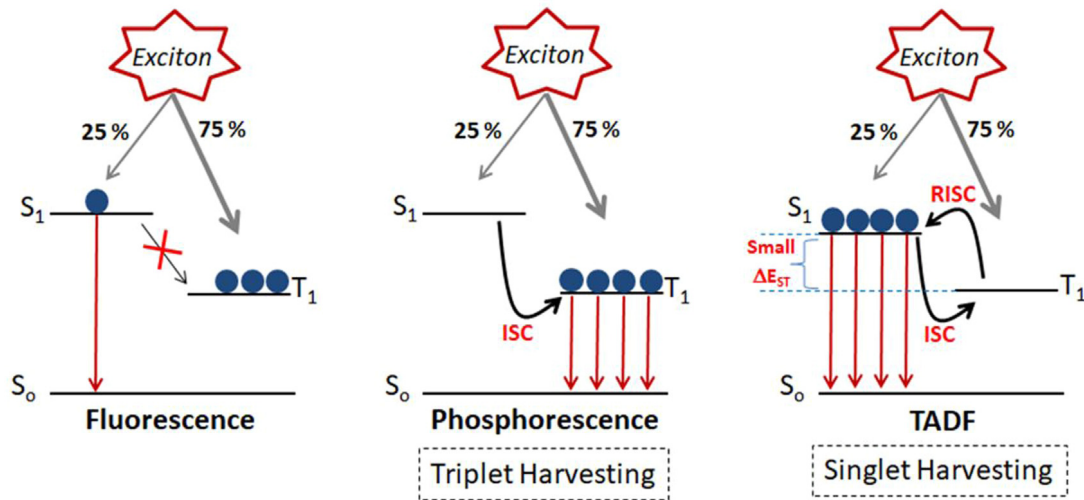

Fig. 2. Simplified emission mechanism for three different types of emitting materials in OLEDs. Left: first generation; middle: second generation; right: third generation.

phosphorescent emitters can reach theoretical efficiencies of almost 100%. As an example, transition-metal compounds usually have a central metal atom with intrinsic significant SOC. For the usage of these complexes in OLEDs, they are usually doped into an organic semiconductor host where the excitons are generated and posteriorly transferred to the phosphorescent guest complex molecules. This arrangement corresponds to the second generation of OLEDs. In these devices, Ir(III) and Pt(II) coordination compounds are the most efficient emitters for green and red light (Cheng et al., 2013; Wang et al., 2014); however, obtaining suitable blue emitters through this methodology remains a challenge. To supplement commercial demand for blue light emitting displays, the less efficient 1st generation fluorescent emitters are still used in OLEDs. For portable electronics this is a problem as the blue OLED consumes much more power and reduces battery lifetime.

The third generation OLEDs are composed of fluorescent emitting materials that exhibit thermally activated delayed fluorescence (TADF) due to a reverse intersystem crossing (RISC) mechanism between T_1 and S_1 , also with theoretical efficiencies reaching 100%. In a TADF emitter, the energy difference between S_1 and T_1 levels is much smaller ($\Delta E_{ST} \leq 100$ meV) than in typical organic molecules so these states are strongly coupled even at room temperature, favoring thermal re-population of the singlet from the triplet state reservoir (Parker and Hatchard, 1961). RISC is a slow process and the S_1 -fluorescence arising from the excitons coming from the triplet state occurs much slower than the fluorescence from the excitons created directly in the S_1 state; for this reason, the process is also referred to as “delayed fluorescence”. This is only a simplified description of the TADF mechanism and more detailed information can be found elsewhere (Penfold et al., 2018; Yang et al., 2017). The phenomenon was first reported in 1929 (Delorme et al., 1929) and its studies continued intensively for 4 decades (Lewis et al., 1941; Parker and Hatchard, 1961) with impacts to these days, as third generation OLEDs are under intensive development. Since the first efficient OLED based on TADF was built in 2012 (Uoyama et al., 2012), several groups have been investigating new systems capable of supplying current and future commercial demand. In special, they are very promising for blue light generation.

2.3. Internal emission quantum yield

Besides the inherent characteristic of the EML material, the energy efficiency of an OLED depends on the design of the deposited

layers. For the evaluation of the light generation efficiency, the internal emission quantum yield η (Brütting et al., 2013; Yu et al., 2015) corresponds to the probability with which a photon is generated by an exciton in the emissive layer.

$$\eta = \beta(\phi_{PL})\gamma \quad (1)$$

In Eq. (1), the spin–statistics factor described in Section 2.2 is represented by β , which depends on the emitting material class. As previously introduced, conventional fluorescent emitters possess $\beta = 0.25$ whereas phosphorescent and TADF emitters have a four times larger value, with $\beta = 1$ (Baldo et al., 1998; Yersin et al., 2013; Yersin and Finkenzeller, 2008). The photoluminescence quantum yield of the emissive compound is given by ϕ_{PL} , which can be expressed as the ratio between the radiative rate and the sum of radiative and non-radiative rates (Zanoni et al., 2015, 2014). Finally, γ represents the charge-balance factor which describes the ratio between the injected charge carriers (electrons/holes) and the produced excitons (Yu et al., 2015). A charge-balance factor smaller than 1 indicates that there is an excess of charge carriers accumulating in the device which then cannot contribute to the generation of light. Thus, the charge balance factor is strongly dependent on the design of the OLED layer stack but not on the emitter material itself.

3. Copper(I) complexes

Cu(I) complexes are gaining prominence as new emitting materials with TADF properties and thus satisfactorily complementing the third generation class of OLEDs (Bizzarri et al., 2018; Czerwieniec et al., 2011, 2013; Hamze et al., 2019; Hashimoto et al., 2011; Leitl et al., 2013; Linfoot et al., 2014; Liu et al., 2014; Ma et al., 1999; Volz et al., 2014; Wallesch et al., 2014; Zink et al., 2013). They present lower processability costs and are less prone to self-quenching effects when compared to other noble metal (Au, Pt, Ir) compounds, leading to high emission efficiencies (Kawamura et al., 2005; Murawski et al., 2013; Reineke and Baldo, 2012) (Czerwieniec et al., 2013; Leitl et al., 2013; Wallesch et al., 2014; Yersin et al., 2013), and allowing the construction of low-cost OLED devices with high-brightness (Chen et al., 2013; Wallesch et al., 2014; Wei et al., 2014). Several papers have been recently published reporting high (above 90%) photoluminescence quantum yields of blue-emitting Cu(I) complexes (Bergmann et al., 2016; Bizzarri et al., 2018; Czerwieniec et al., 2011; Hamze et al., 2019; Krylova et al., 2014; Leitl et al., 2014,

Table 1

Some examples of Cu(I) complexes with potential application in OLEDs. (λ_{em}/nm) Emission at room temperature (λ_{em}/nm), lifetime (τ/s) and PL quantum yield (Φ_{PL}).

Copper (I) complex	λ_{em} (nm)	τ (μs)	Φ_{PL}	Reference
[Cu(PCy ₃) ₂] ₂	488	3.8	0.43	Neshat et al. (2018)
[Cu(PPh ₂ Me)] ₄	544	1.9	0.25	Neshat et al. (2018)
Cu ₄ I ₄ (PPh ₂ py) ₂	521	2.1	0.23	Neshat et al. (2018)
CAAC ^{men} -CuCz	474	2.8	1.0	Hamze et al. (2019)
CAAC ^{men} -Cu(CN ₂ Cz)	426	240	0.82	Hamze et al. (2019)
CAAC ^{men} -Cu(OMe ₂ Cz)	518	2.3	1.0	Hamze et al. (2019)
CAAC ^{men} -Cu(NPh ₂)	532	2.6	0.78	Hamze et al. (2019)
[DtBCzDBFDP] ₂ Cu ₄ I ₄	480	–	0.65	Xie et al. (2019)
[DCzDBFDP] ₂ Cu ₄ I ₄	491	–	0.46	Xie et al. (2019)

CAAC = Cyclic(alkyl)(amino)carbene; MeCz = 1,8-dimethyl-9-H-carbazole; NPh₂ = diphenylamide; Cz = Carbazole; CzCN = 3,5-dicyano-9-H-carbazole; CzOMe = 3,5-dimethoxy-9-H-carbazole.

2013; Neshat et al., 2018; Schinabeck et al., 2019; Wallesch et al., 2014; Xie et al., 2019; Zink et al., 2013).

Cu(I) halide complexes, CuX (X = F, Cl, Br or I), are commonly used for the synthesis of organometallic complexes, in particular Cu(I) iodide (CuI) because of its good chemical stability in oxidizing atmospheres and high quantum efficiency (Ford et al., 1999). The iodide ion (I[−]) can coordinate with four Cu(I) atoms. When this coordination number is decreased to two atoms, interactions between adjacent Cu(I) atoms can occur leading to formation of cluster salts, (CuI)_n, making it possible to add additional binders (L = Lewis base nitrogenous organic). This allows various complex geometries with slightly different structurally driven emissive properties. These different molecular arrangements can range from mononuclear systems Cu(L)₃, rhombohedral dimers of (CuI)₂L₄, tetramers cubes of (CuI)₄L₄ to the [(Cu₂I₂)₂(Cu₄I₄)](CH₂Cl₂)(CH₃CN)_n polymer with “zig-zag” structure in steps format (Hardt and Pierre, 1977). By molecular engineering, changes in the L ligands can lead to emission color tuning in the whole UV/Vis spectral range, being a very strategic strategy from the technological point of view. Furthermore, through theoretical studies by computational simulations, it is possible to predict and construct molecular structures with desired properties for various applications. To cite a few, Cu(I) can be used as catalysts (Feldman and Fraile, 2016; Zhan et al., 2017; Zhao and Montgomery, 2016), biomarkers (Fazaeli et al., 2016; Gai et al., 2016; Ma et al., 2013), gas sensors (Guangying and Jun, 2016; Lane et al., 2014; Smith et al., 2010; Wang et al., 2017), vapochromic sensors (Bailey and Hupp, 2002; Bencini et al., 2009; Kui et al., 2006; Ohara et al., 2017), solvatochromic sensors (Dias et al., 2003; Yam et al., 2002) and, in particular, third generation OLEDs (Dumur, 2015; Volz et al., 2012; Yersin and Finkenzeller, 2008; Zhang et al., 2017).

Indeed, Cu(I) complexes have been gaining increasing attention since the last decade due to the possibility of obtaining highly efficient OLED devices with emission ranging from red to blue, at fairly low cost. To exemplify their interesting photophysical properties, Table 1 presents emission wavelength, lifetime and quantum yields of neutral Cu(I) complexes, promising for OLED, reported in the last two years.

In our research group, the design, synthesis and photophysical properties of mono-, di- and tetra-nuclear copper(I) complexes have been studied for the past five years. The understanding of such properties is important for future applications, including OLEDs. For the emissive mononuclear CuI(PPh₃)(L) (1, L = 4,4-dimethoxy-2,2-bipyridine), with red emission at 705 nm, structural changes and rigidochromism were investigated upon cooling and incorporation of the guest complex molecules in

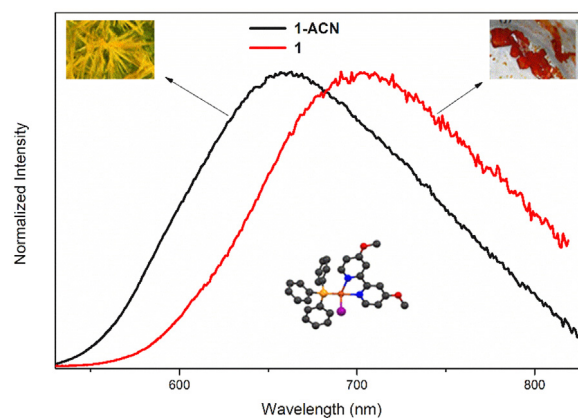

Fig. 3. Normalized PL spectra ($\lambda_{exc} = 420$ nm) for powders of **1** = CuI(PPh₃)(L) (red curve) and **1-ACN** (black curve) at room temperature. Detail: photograph of the orange (right) and yellow (left) compounds. (For interpretation of the references to colour in this figure legend, the reader is referred to the web version of this article.)

mesoporous silica sol gel host matrices (Ravaro et al., 2018). After recrystallization from acetonitrile, the originally orange complex changes color to yellow while its broad emission spectrum is blue-shifted. This process is reversible when the yellow form is recrystallized from dichloromethane. It was found that the yellow compound has acetonitrile molecules in its crystalline structure interacting with the 4,4-dimethoxy-2,2-bipyridine and triphenylphosphine ligands. Fig. 3 shows the PL spectra for this mononuclear complex before and after being recrystallized from acetonitrile. As exhibited in Fig. 4, these changes are a consequence of structural rearrangements of the complex's molecular packaging (2D visualization).

Luminescent homoleptic dinuclear copper(I) complexes bear three P₃N ligands in the ligand sphere (Zink et al. 2013b) (which could allow for emission color tuning of the complexes by changing the electronic characteristics of the ligands). For the dinuclear Cu(I) complex Cu₂I₂(PyrPhos)(PPh₃)₂, where (PyrPhos = Diphenyl-2 pyridylphosphine and PPh₃ = triphenylphosphine), a maximum emission is observed at 520 nm (see Fig. 5), with a lifetime of $\tau = 2.75$ ns ($\lambda_{exc} = 350$ nm) and PL quantum yields of $\Phi_{PL} = 0.86$. This complex is currently in the stage of device testing for high-performance OLED device.

Xie et al. reported the first sky blue OLED based on Cu(I) clusters or tetranuclear complexes (Xie et al., 2019). Polynuclear Cu(I) clusters and polymers show two distinct types of emission bands, whose intensities and frequencies display marked sensitivity and temperature dependence. For example, Fig. 6 shows the PL spectrum for the Cu₄I₄py₄ complex at low temperature (77 K) and room temperature under different excitations. The Cu₄I₄py₄ cluster exhibits a high-energy (HE) luminescence in the blue wavelength region, ascribed to a halide-to-ligand charge transfer (XLCT) excited state, and a low-energy (LE) emission near 690 nm, which has been assigned to a (CuI)₄ cluster centered (CC) transition, with influences from halide-to-metal charge transfer (XMCT) and metal-centered 3d → 4s, 4p transitions). Consistent with this assignment, the HE transitions are found to respond sensitively to the electron-accepting character of the ligand, whereas the LE transitions are largely insensitive to these effects. However, the LE counterpart experiences remarkable thermochromism (Ford et al., 1999; Hardt and Pierre, 1977) and rigidochromism (Tran et al., 1997) due to significant nuclear rearrangements occurring in the triplet excited states associated with the CC transition, as rationalized on the basis of DFT calculations of ground state and excited-state geometries (De Angelis et al., 2006). In Fig. 6, it can

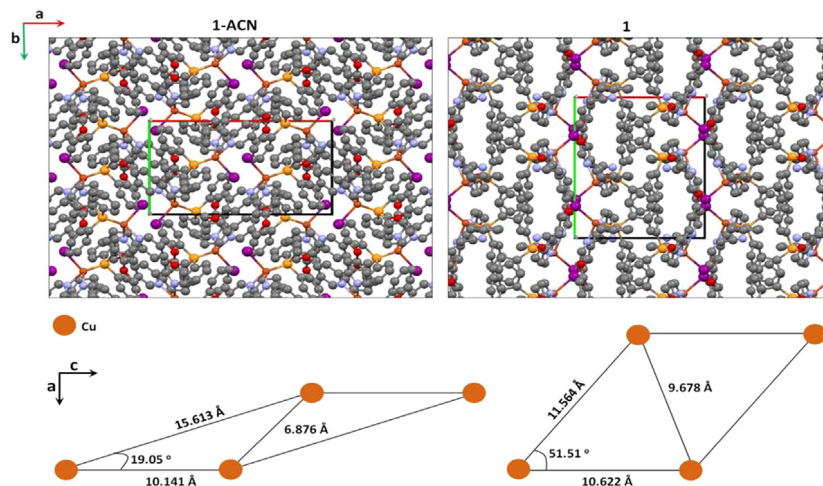

Fig. 4. 2D visualization of the molecular packing for compound **1-ACN** (left) and **1** (right). The atoms Cu, N, P, O, I, C are represented by the orange, blue, yellow, red, violet and gray colors, respectively. Hydrogen atoms were left out for better visualization of the molecular packaging. (For interpretation of the references to colour in this figure legend, the reader is referred to the web version of this article.)

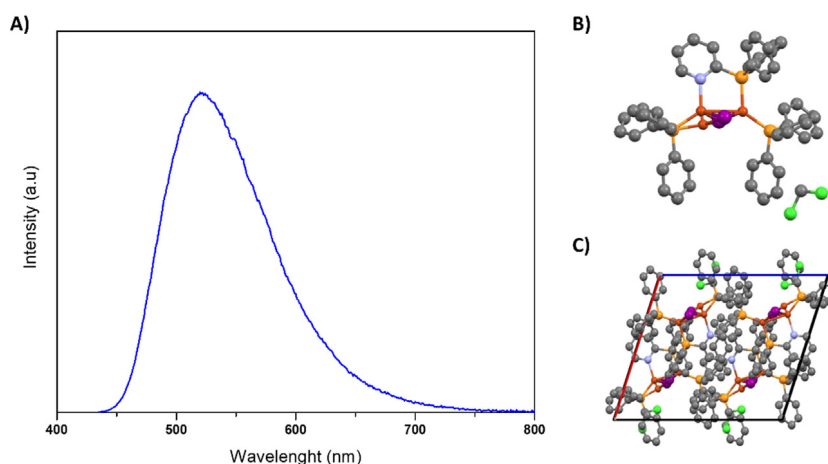

Fig. 5. (a) PL spectrum ($\lambda_{exc} = 400$ nm) for the dinuclear copper(I) complex $Cu_2I_2(PyrPhos)(PPh_3)_2$. 2D visualization for (b) structural and (c) molecular packaging.

be seen that when the temperature decreases to 77 K, the HE emission becomes more intense than the LE emission (Ravaro et al., 2016). It is notable that owing to distortions along different trajectories, the two emitting states are poorly coupled, even at room temperature, and hence display different excited state lifetime values. Besides the strong thermochromic and rigidochromic effects observed for these molecules, their non-centrosymmetric character and the large molecular polarizabilities give rise to strong non-linear optical effects, such as optical limiting owing to the activation of two-photon excitation (Zhang et al., 2000).

Fig. 7 exhibits the emission spectra of seven other $Cu_4I_4L_4$ clusters with different ligands (L): $Cu_4I_4(PPh_3)_4$ (**1**), $Cu_4I_4(PPh_2CH_3)_4$ (**2**), $Cu_4I_4(PPh_2Cl)_4$ (**3**), $Cu_4I_4(PPh_3(CH_3)_3)_4$ (**4**), $Cu_4I_4(4-Phpy)_4$ (**5**), $Cu_4I_4(4-pic)_4$ (**6**), $Cu_4I_4(py)_4$ (**7**). The chemical structures of the respective ligands are exhibited in Fig. 8. Table 2 summarizes the maximum excitation and emission for the tetranuclear copper(I) complexes.

Note that, at room temperature, the photophysical properties of these tetranuclear complexes are exclusively related to the electronic transitions of the cluster-centered excited state 3CC (LE emission), therefore the emission should not be dependent on the electronic nature of the ligand (Cariati et al., 2016). Then, the shifts observed in emission energy can be rationalized by different distortions of the crystal packing caused by the size, geometry, polarity and steric effects of the ligands.

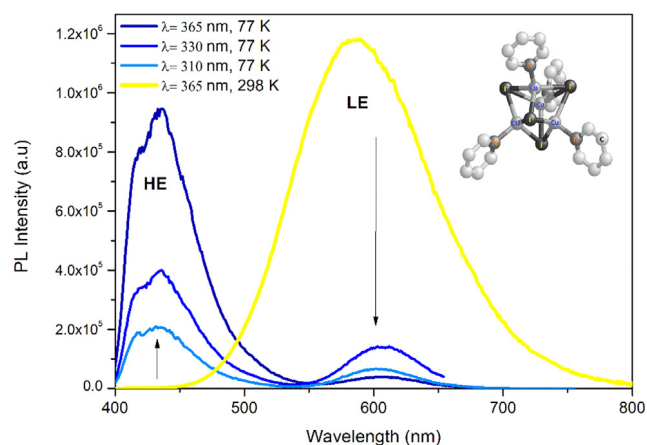

Fig. 6. PL spectra ($\lambda_{exc} = 310, 330$ e 365 nm) at 77 K and 298 K ($\lambda_{exc} = 365$ nm) for $Cu_4I_4py_4$ powder sample.

For example, the $Cu_4I_4L_4$ cluster with the L_1 ligand can be obtained both in the monoclinic or cubic forms from recrystallization of chloroform or toluene solutions, respectively. The

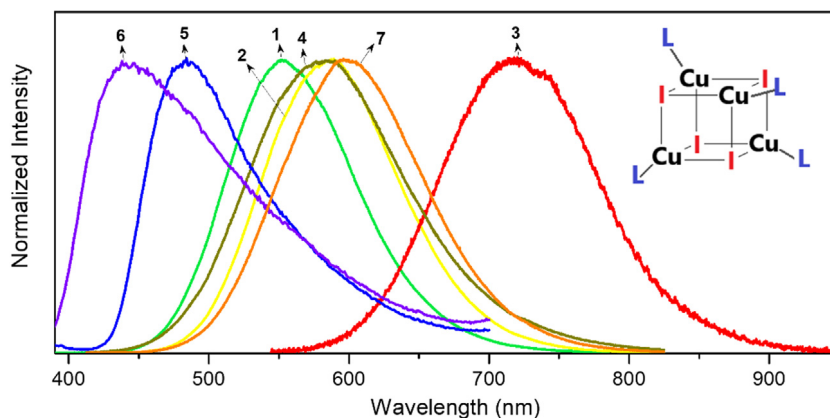

Fig. 7. PL spectra for tetranuclear copper (I) complexes from **1** to **7**. $\text{Cu}_4\text{I}_4(\text{PPh}_3)_4$ (**1**), $\text{Cu}_4\text{I}_4(\text{PPh}_2\text{CH}_3)_4$ (**2**), $\text{Cu}_4\text{I}_4(\text{PPh}_2\text{Cl})_4$ (**3**), $\text{Cu}_4\text{I}_4(\text{PPh}_3(\text{CH}_3)_3)_4$ (**4**), $\text{Cu}_4\text{I}_4(4\text{-Phpy})_4$ (**5**), $\text{Cu}_4\text{I}_4(4\text{-pic})_4$ (**6**), $\text{Cu}_4\text{I}_4(\text{py})_4$ (**7**). Detail: powder samples under UV/Vis light lamp.

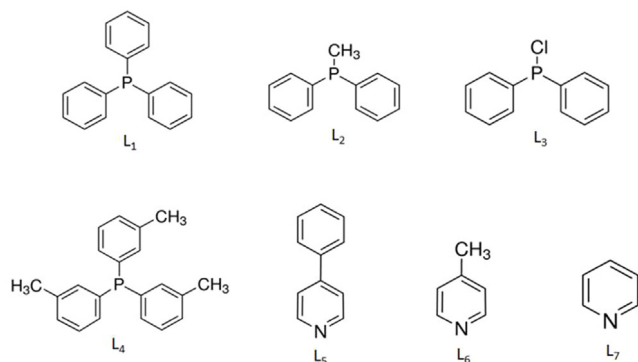

Fig. 8. Binders used to obtain the tetranuclear copper(I) complexes. $L_1 = \text{PPh}_3$ (L_1), PPh_2CH_3 (L_2), PPh_2Cl (L_3), *m*-tolyl (L_4), 4-pyPh (L_5), 4-pic (L_6) and py (L_7) and $(\text{PPh}_3) = \text{triphenylphosphine}$, $(\text{PyrPHOS}) = \text{Diphenyl-2-pyridylphosphine}$, $(\text{PY}) = \text{pyridine}$, $(\text{PPh}_2\text{CH}_3) = \text{methyl-diphenylphosphine}$, $(\text{PPh}_2\text{Cl}) = \text{chloro-diphenylphosphine}$, (*m*-tolyl) = tri(*m*-tolyl)phosphine, (4-pic) = 4-methylpyridine and (4-pyPh) = 4-phenylpyridine.

Table 2

Maximum emission and excitation values obtained from PL and PLE spectra for tetranuclear halide copper (I) complexes at room temperature.

Copper (I) complex	λ_{exc} (nm)	Emission (nm)	Number
$\text{Cu}_4\text{I}_4(\text{PPh}_3)_4$	357	548	1
$\text{Cu}_4\text{I}_4(\text{PPh}_2\text{CH}_3)_4$	355	578	2
$\text{Cu}_4\text{I}_4(\text{PPh}_2\text{Cl})_4$	392	748	3
$\text{Cu}_4\text{I}_4(\text{PPh}_3(\text{CH}_3)_3)_4$	365	576	4
$\text{Cu}_4\text{I}_4(4\text{-Phpy})_4$	370	484	5
$\text{Cu}_4\text{I}_4(4\text{-pic})_4$	363	440	6
$\text{Cu}_4\text{I}_4(\text{py})_4$	365	580	7

more-distorted monoclinic form has a maximum emission at 548 nm, while the more-isometric cubic form has a maximum emission at 520 nm (Kitagawa et al., 2010). Ligand L_1 (P-donor ligand) has only phenyl groups attached to the P atom. Changing one phenyl group to other smaller groups, e.g. $R = \text{CH}_3$ (L_2) or Cl (L_3), shifts the emission spectrum of the copper(I) complex to the red, with a more prominent redshift to the less sterically hindered substituent ($-\text{Cl}$) in ligand L_3 due to a lower molecular distortion of the complex. L_4 (also a P-donor ligand) is larger than L_1 , however the electron donating $-\text{CH}_3$ substituents on the phenyl rings promote changes in polarity that affect the crystal

packing and ultimately shifts the emission spectrum to lower energies when compared to L_1 . N-donor ligands usually follow the same rationale for ligand sizes, with complexes formed by larger ligands leading to broader blue-shifts in the emission spectra, as exemplified from comparing L_5 to L_7 . For L_6 , however, the $-\text{CH}_3$ substituent leads to additional changes in crystal packing that ultimately results in a blue-shifted emission energy.

The tetranuclear copper (I) complexes presented here (1–7) do not exhibit TADF properties. However, Xie and colleagues (Xie et al., 2019) have recently reported a new class of tetranuclear complexes with such property. According to the authors, in this case the S_1 and T_1 excited states of $[\text{DCzDBFDP}]_2\text{Cu}_4\text{I}_4$ are remarkably reduced from 0.16 eV to 0.07 eV, improving thermally activated delayed fluorescence (TADF). Therefore, the continued study of promising new tetranuclear Cu(I) complexes seems a worthwhile effort.

4. Conclusions and perspectives

The design, synthesis and characterization of new architectures for copper(I) complexes has contributed to the identification and understanding of emission mechanisms leading to high quantum efficiency values, required in electroluminescent devices such as OLEDs. Particularly, the TADF Fluorescence mechanism is observed in some Cu(I) complexes and results in high fluorescence quantum efficiency ($\sim 100\%$). Based on that, Cu(I) complexes promise to be one of the main promising players in supplying the commercial demand for more efficient emitters (mainly in the blue) in the coming next years, contributing to the reduction of global energy consumption. The advantages of these copper(I) complexes are directly related to their low cost, the absence of emission self-quenching and, above all, the low energy consumption. Work in progress at our research group aims at developing new Cu(I) complex molecules that will meet the specific needs of next generation OLEDs.

The next challenges in the field will be to elucidate the internal charge transfer processes of the inorganic nucleus $(\text{Cu})_n$ as a function of ligand types and crystal packing to identify structural-optical properties relations that could lead to the desired molecular engineering of new compounds with specific properties. In this context, an integrated structural (e.g. via XRD and NMR solid state spectroscopy) and electronic characterization (e.g. via photophysical measurements and theoretical calculations) will be very important to correlate such effects and contribute to develop new and more appropriate ligands.

Acknowledgments

This work was supported by CeRTEV – Center for Research, Technology and Education in Vitreous Materials, funded by FAPESP – Fundação de Amparo à Pesquisa do Estado de São Paulo (Project No. 2013/07793-6). L.P.R. is personally thankful to FAPESP for a BEPE scholarship (2016/17495-0) and to CNPq – Conselho Nacional de Desenvolvimento Científico e Tecnológico for a postdoctoral scholarship (152438/2018-1). K.P.S.Z. acknowledges the FAPESP postdoctoral scholarship (2016/07706-4).

References

- Bailey, R.C., Hupp, J.T., 2002. Large-scale resonance amplification of optical sensing of volatile compounds with chemoresponsive visible-region diffraction gratings. *J. Am. Chem. Soc.* 124, 6767–6774. <http://dx.doi.org/10.1021/ja0177354>.
- Baldo, M.A., O'Brien, D.F., You, Y., Shoustikov, A., Sibley, S., Thompson, M.E., Forrest, S.R., 1998. Highly efficient phosphorescent emission from organic electroluminescent devices. *Nature* 395, 151–154. <http://dx.doi.org/10.1038/25954>.
- Bencini, A., Casarin, M., Forrer, D., Franco, L., Garau, F., Masciocchi, N., Pandolfo, L., Pettinari, C., Ruzzi, M., Vittadini, A., 2009. Magnetic properties and vapochromic reversible guest-induced transformation in a bispyrazolato copper(II) polymer: an experimental and dispersion-corrected density functional theory study. *Inorg. Chem.* 48, 4044–4051. <http://dx.doi.org/10.1021/ic801928b>.
- Bergmann, L., Hedley, G.J., Baumann, T., Bräse, S., Samuel, I.D.W., 2016. Direct observation of intersystem crossing in a thermally activated delayed fluorescence copper complex in the solid state. *Sci. Adv.* 2, e1500889. <http://dx.doi.org/10.1126/sciadv.1500889>.
- Bernanose, A., Vouaux, P., 1953. Électroluminescence organique : étude du mode d'émission. *J. Chim. Phys.* 50, 261–263. <http://dx.doi.org/10.1051/jcp/1953500261>.
- Bizzarri, C., Spuling, E., Knoll, D.M., Volz, D., Bräse, S., 2018. Sustainable metal complexes for organic light-emitting diodes (OLEDs). *Coord. Chem. Rev.* 373, 49–82. <http://dx.doi.org/10.1016/j.ccr.2017.09.011>.
- Brütting, W., Frischaen, J., Schmidt, T.D., Scholz, B.J., Mayr, C., 2013. Device efficiency of organic light-emitting diodes: Progress by improved light outcoupling. *Phys. Status Solidi* 210, 44–65. <http://dx.doi.org/10.1002/pssa.201228320>.
- Cariati, E., Lucenti, E., Botta, C., Giovanella, U., Marinotto, D., Righetto, S., 2016. Cu(I) hybrid inorganic-organic materials with intriguing stimuli responsive and optoelectronic properties. *Coord. Chem. Rev.* 306, 566–614. <http://dx.doi.org/10.1016/j.ccr.2015.03.004>.
- Chen, X.-L., Yu, R., Zhang, Q.-K., Zhou, L.-J., Wu, X.-Y., Zhang, Q., Lu, C.-Z., 2013. Rational design of strongly blue-emitting cuprous complexes with thermally activated delayed fluorescence and application in solution-processed OLEDs. *Chem. Mater.* 25, 3910–3920. <http://dx.doi.org/10.1021/cm4024309>.
- Cheng, G., Chow, P.-K., Kui, S.C.F., Kwok, C.-C., Che, C.-M., 2013. High-efficiency polymer light-emitting devices with robust phosphorescent platinum(II) emitters containing tetradentate dianionic O[−] N[−] C[−] N[−] ligands. *Adv. Mater.* 25, 6765–6770. <http://dx.doi.org/10.1002/adma.201302408>.
- Czerwieńec, R., Kowalski, K., Yersin, H., 2013. Highly efficient thermally activated fluorescence of a new rigid Cu(I) complex [Cu(dmp)(phanePhos)]⁺. *Dalt. Trans.* 42, 9826. <http://dx.doi.org/10.1039/c3dt51006a>.
- Czerwieńec, R., Yu, J., Yersin, H., 2011. Blue-light emission of Cu(I) complexes and singlet harvesting. *Inorg. Chem.* 50, 8293–8301. <http://dx.doi.org/10.1021/ic200811a>.
- De Angelis, F., Fantacchi, S., Sgamellotti, A., Cariati, E., Ugo, R., Ford, P.C., 2006. Electronic transitions involved in the absorption spectrum and dual luminescence of tetranuclear cubane [Cu₄I₄(pyridine)₄] cluster: a density functional theory/time-dependent density functional theory investigation. *Inorg. Chem.* 45, 10576–10584. <http://dx.doi.org/10.1021/ic061147f>.
- Delorme, R., Perrin, F., Perrin Durées, F., 1929. Durées de fluorescence des sels d'uranyle solides et de leurs solutions. *J. Phys. Radium* 10, 177–186. <http://dx.doi.org/10.1051/jphysrad:01929001005017700>[1].
- Dias, H.V.R., Diyabalanage, H.V.K., Rawashdeh-Omary, M.A., Franzman, M.A., Omary, M.A., 2003. Bright phosphorescence of a trinuclear copper(I) complex: Luminescence thermochromism, solvatochromism, and concentration luminochromism. *J. Am. Chem. Soc.* 125, 12072–12073. <http://dx.doi.org/10.1021/ja036736o>.
- Dumur, F., 2015. Recent advances in organic light-emitting devices comprising copper complexes: A realistic approach for low-cost and highly emissive devices? *Org. Electron.* 21, 27–39. <http://dx.doi.org/10.1016/j.orgel.2015.02.026>.
- Energy, U.S.D. of, 2008. *Energy savings estimates of light emitting diodes in niche lighting applications*.
- Evans, R.C., Douglas, P., Winscom, C.J., 2006. Coordination complexes exhibiting room-temperature phosphorescence: Evaluation of their suitability as triplet emitters in organic light emitting diodes. *Coord. Chem. Rev.* 250, 2093–2126. <http://dx.doi.org/10.1016/j.ccr.2006.02.007>.
- Fazaeli, Y., Feizi, S., Jalilian, A.R., Hejrani, A., 2016. Grafting of [64Cu]-TPPF20 porphyrin complex on Functionalized nano-porous MCM-41 silica as a potential cancer imaging agent. *Appl. Radiat. Isot.* 112, 13–19. <http://dx.doi.org/10.1016/j.apradiso.2016.03.003>.
- Feldman, R.A., Fraile, J.M., 2016. Non-covalent immobilization of chiral copper complexes on Al-MCM41: Effect of the nature of the ligand. *Catal. Commun.* 83, 74–77. <http://dx.doi.org/10.1016/j.catcom.2016.05.015>.
- Ford, P.C., Cariati, E., Bourassa, J., 1999. Photoluminescence properties of multinuclear Copper(I) compounds. *Chem. Rev.* 99, 3625–3648. <http://dx.doi.org/10.1021/cr960109i>.
- Fyfe, D., 2009. LED technology: Organic displays come of age. *Nat. Photonics* 3, 453–455. <http://dx.doi.org/10.1038/nphoton.2009.132>.
- Gai, Y., Sun, L., Hui, W., Ouyang, Q., Anderson, C.J., Xiang, G., Ma, X., Zeng, D., 2016. New bifunctional chelator p-SCN-PhPr-NE3TA for Copper-64: Synthesis, peptidomimetic conjugation, radiolabeling, and evaluation for PET imaging. *Inorg. Chem.* 55, 6892–6901. <http://dx.doi.org/10.1021/acs.inorgchem.6b00395>.
- Guangying, L., Jun, F., 2016. A series of phosphorescent Cu(I) complexes: Synthesis, photophysical feature and optical oxygen sensing performance in MCM-41 silica matrix. *Sensors Actuators B* 233, 347–354. <http://dx.doi.org/10.1016/j.snb.2016.04.078>.
- Hamze, R., Peltier, J.L., Sylvainson, D., Jung, M., Cardenas, J., Haiges, R., Soleilhavoup, M., Jazzar, R., Djurovich, P.I., Bertrand, G., Thompson, M.E., 2019. Eliminating nonradiative decay in Cu(I) emitters: & gt; 99% quantum efficiency and microsecond lifetime. *Science* (80-.) 363, 601–606. <http://dx.doi.org/10.1126/science.aav2865>.
- Hardt, H.D., Pierre, A., 1977. Fluorescence thermochromism and symmetry of copper(I) complexes. *Inorganica Chim. Acta* 25, L59–L60. [http://dx.doi.org/10.1016/S0020-1693\(00\)95644-5](http://dx.doi.org/10.1016/S0020-1693(00)95644-5).
- Hashimoto, M., Igawa, S., Yashima, M., Kawata, I., Hoshino, M., Osawa, M., 2011. Highly efficient green organic light-emitting diodes containing luminescent three-coordinate copper(I) complexes. *J. Am. Chem. Soc.* 133, 10348–10351. <http://dx.doi.org/10.1021/ja202965y>.
- Hedley, G.J., Ruseckas, A., Samuel, I.D.W., 2008. Ultrafast luminescence in Ir(ppy)₃. *Chem. Phys. Lett.* 450, 292–296. <http://dx.doi.org/10.1016/j.cplett.2007.11.028>.
- Hofbeck, T., Yersin, H., 2010. The triplet state of fac-Ir(ppy)₃. *Inorg. Chem.* 49, 9290–9299. <http://dx.doi.org/10.1021/ic100872w>.
- Hsu, C.-W., Lin, C.-C., Chung, M.-W., Chi, Y., Lee, G.-H., Chou, P.-T., Chang, C.-H., Chen, P.-Y., 2011. Systematic investigation of the metal-structure-photophysics relationship of emissive d¹⁰-complexes of group 11 elements: The prospect of application in organic light emitting devices. *J. Am. Chem. Soc.* 133, 12085–12099. <http://dx.doi.org/10.1021/ja2026568>.
- Kawamura, Y., Goushi, K., Brooks, J., Brown, J.J., Sasabe, H., Adachi, C., 2005. 100% phosphorescence quantum efficiency of Ir(III) complexes in organic semiconductor films. *Appl. Phys. Lett.* 86, 071104. <http://dx.doi.org/10.1063/1.1862777>.
- Khanna, V.K., 2014. *Fundamentals of Solid-State Lighting, Fundamentals of Solid-State Lighting: LEDs, OLEDs, and their Applications in Illumination and Displays*. CRC Press, <http://dx.doi.org/10.1201/b17076>.
- Kitagawa, H., Ozawa, Y., Toriumi, K., 2010. Flexibility of cubane-like Cu₄I₄ framework: temperature dependence of molecular structure and luminescence thermochromism of [Cu₄I₄(PPh₃)₄] in two polymorphic crystalline states. *Chem. Commun.* 46, 6302. <http://dx.doi.org/10.1039/c0cc01434f>.
- Krasnov, A.N., 2003. Electroluminescent displays: history and lessons learned. *Displays* 24, 73–79. [http://dx.doi.org/10.1016/S0141-9382\(03\)00015-5](http://dx.doi.org/10.1016/S0141-9382(03)00015-5).
- Krylova, V.A., Djurovich, P.I., Conley, B.L., Haiges, R., Whited, M.T., Williams, T.J., Thompson, M.E., 2014. Control of emission colour with n-heterocyclic carbene (NHC) ligands in phosphorescent three-coordinate Cu(*scpi*) complexes. *Chem. Commun.* 50, 7176–7179. <http://dx.doi.org/10.1039/C4CC02037E>.
- Kui, S.C.F., Chui, S.S.-Y., Che, C.-M., Zhu, N., 2006. Structures, photoluminescence, and reversible vapoluminescence properties of neutral platinum(II) complexes containing extended π-conjugated cyclometalated ligands. *J. Am. Chem. Soc.* 128, 8297–8309. <http://dx.doi.org/10.1021/ja061422x>.
- Lane, A.C., Vollmer, M.V., Laber, C.H., Melgarejo, D.Y., Chiarella, G.M., Fackler, J.P., Yang, X., Baker, G.A., Walensky, J.R., 2014. Multinuclear copper(I) and silver(I) amidinate complexes: Synthesis, luminescence, and CS 2 insertion reactivity. *Inorg. Chem.* 53, 11357–11366. <http://dx.doi.org/10.1021/ic501694d>.
- Lee, S.-M., Kwon, J.H., Kwon, S., Choi, K.C., 2017. A review of flexible OLEDs toward highly durable unusual displays. *IEEE Trans. Electron Dev.* 64, 1922–1931. <http://dx.doi.org/10.1109/TEDE.2017.2647964>.
- Leitl, M.J., Krylova, V.A., Djurovich, P.I., Thompson, M.E., Yersin, H., 2014. Phosphorescence versus thermally activated delayed fluorescence, controlling singlet-triplet splitting in brightly emitting and sublimable Cu(I) compounds. *J. Am. Chem. Soc.* 136, 16032–16038. <http://dx.doi.org/10.1021/ja508155x>.

- Leitl, M.J., Küchle, F.-R., Mayer, H.A., Wesemann, L., Yersin, H., 2013. Brightly blue and green emitting Cu(I) dimers for singlet harvesting in OLEDs. *J. Phys. Chem. A* 117, 11823–11836. <http://dx.doi.org/10.1021/jp402975d>.
- Lewis, G.N., Lipkin, D., Magel, T.T., 1941. Reversible photochemical processes in rigid media. A study of the phosphorescent state. *J. Am. Chem. Soc.* 63, 3005–3018. <http://dx.doi.org/10.1021/ja01856a043>.
- Li, S., Xie, R.-J., Takeda, T., Hirotsaki, N., 2018. Critical review—Narrow-band nitride phosphors for wide color-gamut white LED backlighting. *ECS J. Solid State Sci. Technol.* 7, R3064–R3078. <http://dx.doi.org/10.1149/2.0051801jss>.
- Linfoot, C.L., Leitl, M.J., Richardson, P., Rausch, A.F., Chepelin, O., White, F.J., Yersin, H., Robertson, N., 2014. Thermally activated delayed fluorescence (TADF) and enhancing photoluminescence quantum yields of [Cu I (diimine)(diphosphine)] + complexes—Photophysical, structural, and computational studies. *Inorg. Chem.* 53, 10854–10861. <http://dx.doi.org/10.1021/ic500889s>.
- Liu, Z., Qiu, J., Wei, F., Wang, J., Liu, X., Helander, M.G., Rodney, S., Wang, Z., Bian, Z., Lu, Z., Thompson, M.E., Huang, C., 2014. Simple and high efficiency phosphorescence organic light-emitting diodes with codeposited copper(I) emitter. *Chem. Mater.* 26, 2368–2373. <http://dx.doi.org/10.1021/cm5006086>.
- Ma, Y.-G., Chan, W.-H., Zhou, X.-M., Che, C.-M., 1999. Light-emitting diode device from a luminescent organocopper(I) compound. *New J. Chem.* 23, 263–265. <http://dx.doi.org/10.1039/a808763f>.
- Ma, D.-L., He, H.-Z., Leung, K.-H., Chan, D.S.-H., Leung, C.-H., 2013. Bioactive luminescent transition-metal complexes for biomedical applications. *Angew. Chemie Int. Ed.* 52, 7666–7682. <http://dx.doi.org/10.1002/anie.201208414>.
- Maclsaac, D., Kanner, G., Anderson, G., 1999. Basic physics of the incandescent lamp (lightbulb). *Phys. Teach.* 37, 520–525. <http://dx.doi.org/10.1119/1.880392>.
- Minaev, B., Baryshnikov, G., Agren, H., 2014a. Principles of phosphorescent organic light emitting devices. *Phys. Chem. Chem. Phys.* 16, 1719–1758. <http://dx.doi.org/10.1039/C3CP53806K>.
- Mottier, P., 2009. LEDs for Lighting Applications. ISTE.
- Murawski, C., Leo, K., Gather, M.C., 2013. Efficiency roll-off in organic light-emitting diodes. *Adv. Mater.* 25, 6801–6827. <http://dx.doi.org/10.1002/adma.201301603>.
- Neshat, A., Aghakhanpour, R.B., Mastrorilli, P., Todisco, S., Molani, F., Wojtczak, A., 2018. Dinuclear and tetranuclear copper(I) iodide complexes with P and P^N donor ligands: Structural and photoluminescence studies. *Polyhedron* 154, 217–228. <http://dx.doi.org/10.1016/j.poly.2018.07.045>.
- Ohara, H., Ogawa, T., Yoshida, M., Kobayashi, A., Kato, M., 2017. Reversible luminescent colour changes of mononuclear copper(II) (<sc>i>P</i> and <sc>i>P^N</i> donor ligands: Structural and photoluminescence studies. *Polyhedron* 154, 217–228. <http://dx.doi.org/10.1016/j.poly.2018.07.045>.
- Ohara, H., Ogawa, T., Yoshida, M., Kobayashi, A., Kato, M., 2017. Reversible luminescent colour changes of mononuclear copper(II) (<sc>i>P</i> and <sc>i>P^N</i> donor ligands: Structural and photoluminescence studies. *Polyhedron* 154, 217–228. <http://dx.doi.org/10.1016/j.poly.2018.07.045>.
- Ohara, H., Ogawa, T., Yoshida, M., Kobayashi, A., Kato, M., 2017. Reversible luminescent colour changes of mononuclear copper(II) (<sc>i>P</i> and <sc>i>P^N</i> donor ligands: Structural and photoluminescence studies. *Polyhedron* 154, 217–228. <http://dx.doi.org/10.1016/j.poly.2018.07.045>.
- Parker, C.A., Hatchard, C.G., 1961. Triplet-singlet emission in fluid solutions. Phosphorescence of eosin. *Trans. Faraday Soc.* 57, 1894. <http://dx.doi.org/10.1039/ft9615701894>.
- Penfold, T.J., Dias, F.B., Monkman, A.P., 2018. The theory of thermally activated delayed fluorescence for organic light emitting diodes. *Chem. Commun.* 54, 3926–3935. <http://dx.doi.org/10.1039/C7CC09612G>.
- Rausch, A.F., Thompson, M.E., Yersin, H., 2009. Blue light emitting Ir(III) compounds for OLEDs - new insights into ancillary ligand effects on the emitting triplet state. *J. Phys. Chem. A* 113, 5927–5932. <http://dx.doi.org/10.1021/jp902261c>.
- Ravaro, L.P., Almeida, T.R., Albuquerque, R.Q., de Camargo, A.S.S., 2016. The polynuclear complex Cu 4 I 4 py 4 loaded in mesoporous silica: photophysics, theoretical investigation, and highly sensitive oxygen sensing application. *Dalt. Trans.* 45, 17652–17661. <http://dx.doi.org/10.1039/C6DT03121H>.
- Ravaro, L.P., Mafud, A.C., Li, Z., Reinheimer, E., Simone, C.A., Mascarenhas, Y.P., Ford, P.C., de Camargo, A.S.S., 2018. New emissive mononuclear copper (I) complex: Structural and photophysical characterization focusing on solvatochromism, rigidochromism and oxygen sensing in mesoporous solid matrix. *Dye. Pigment.* 159, 464–470. <http://dx.doi.org/10.1016/j.dyepig.2018.07.020>.
- Reineke, S., Baldo, M.A., 2012. Recent progress in the understanding of exciton dynamics within phosphorescent OLEDs. *Phys. Status Solidi* 209, 2341–2353. <http://dx.doi.org/10.1002/pssa.201228292>.
- Schinabeck, A., Chen, J., Kang, L., Teng, T., Homeier, H.H.H., Suleymanova, A.F., Shafikov, M.Z., Yu, R., Lu, C.-Z., Yersin, H., 2019. Symmetry-based design strategy for unprecedentedly fast decaying thermally activated delayed fluorescence (TADF). application to dinuclear Cu(I) compounds. *Chem. Mater.* 31, 4392–4404. <http://dx.doi.org/10.1021/acs.chemmater.9b00671>.
- Smith, C.S., Branham, C.W., Marquardt, B.J., Mann, K.R., 2010. Oxygen gas sensing by luminescence quenching in crystals of Cu(xantphos)(phen) + Complexes. *J. Am. Chem. Soc.* 132, 14079–14085. <http://dx.doi.org/10.1021/ja103112m>.
- Tang, C.W., VanSlyke, S.A., 1987. Organic electroluminescent diodes. *Appl. Phys. Lett.* 51, 913–915. <http://dx.doi.org/10.1063/1.98799>.
- Tran, D., Bourassa, J.L., Ford, P.C., 1997. Pressure-induced luminescence rigidochromism in the photophysics of the cuprous iodide cluster Cu 4 I 4 py 4. *Inorg. Chem.* 36, 439–442. <http://dx.doi.org/10.1021/ic960959g>.
- Trifunovic, J., Mikulovic, J., Djuric, Z., Djuric, M., Kostic, M., 2009. Reductions in electricity consumption and power demand in case of the mass use of compact fluorescent lamps. *Energy* 34, 1355–1363. <http://dx.doi.org/10.1016/j.energy.2009.05.014>.
- Tschierlei, S., Karnahl, M., Rockstroh, N., Junge, H., Beller, M., Lochbrunner, S., 2014. Substitution-controlled excited state processes in heteroleptic Copper(I) photosensitizers used in hydrogen evolving systems. *ChemPhysChem* 15, 3709–3713. <http://dx.doi.org/10.1002/cphc.201402585>.
- Uoyama, H., Goushi, K., Shizu, K., Nomura, H., Adachi, C., 2012. Highly efficient organic light-emitting diodes from delayed fluorescence. *Nature* 492, 234–238. <http://dx.doi.org/10.1038/nature11687>.
- Volz, D., Baumann, T., Flügge, H., Mydlak, M., Grab, T., Bächle, M., Barner-Kowollik, C., Bräse, S., 2012. Auto-catalysed crosslinking for next-generation OLED-design. *J. Mater. Chem.* 22, 20786. <http://dx.doi.org/10.1039/c2jm33291d>.
- Volz, D., Wallesch, M., Grage, S.L., Göttlicher, J., Steininger, R., Batchelor, D., Vitova, T., Ulrich, A.S., Heske, C., Weinhardt, L., Baumann, T., Bräse, S., 2014. Labile or stable: Can homoleptic and heteroleptic PyrPHOS–Copper complexes be processed from solution? *Inorg. Chem.* 53, 7837–7847. <http://dx.doi.org/10.1021/jc500135m>.
- Wallesch, M., Volz, D., Zink, D.M., Schepers, U., Nieger, M., Baumann, T., Bräse, S., 2014. Bright opportunities: Multinuclear Cu I complexes with N-P ligands and their applications. *Chem. A Eur. J.* 20, 6578–6590. <http://dx.doi.org/10.1002/chem.201402060>.
- Wang, Q., Oswald, I.W.H., Perez, M.R., Jia, H., Shahub, A.A., Qiao, Q., Gnade, B.E., Omary, M.A., 2014. Doping-free organic light-emitting diodes with very high power efficiency, simple device structure, and superior spectral performance. *Adv. Funct. Mater.* 24, 4746–4752. <http://dx.doi.org/10.1002/adfm.201400597>.
- Wang, L., Wang, Z., Xiang, Q., Chen, Y., Duan, Z., Xu, J., 2017. High performance formaldehyde detection based on a novel copper (II) complex functionalized QCM gas sensor. *Sensors Actuators B* 248, 820–828. <http://dx.doi.org/10.1016/j.snb.2016.12.015>.
- Wei, F., Zhang, T., Liu, X., Li, X., Jiang, N., Liu, Z., Bian, Z., Zhao, Y., Lu, Z., Huang, C., 2014. Efficient nondoped organic light-emitting diodes with Cu I complex emitter. *Org. Electron.* 15, 3292–3297. <http://dx.doi.org/10.1016/j.orgel.2014.09.004>.
- Xiao, L., Chen, Z., Qu, B., Luo, J., Kong, S., Gong, Q., Kido, J., 2011. Recent progresses on materials for electrophosphorescent organic light-emitting devices. *Adv. Mater.* 23, 926–952. <http://dx.doi.org/10.1002/adma.201003128>.
- Xie, M., Han, C., Liang, Q., Zhang, J., Xie, G., Xu, H., 2019. Highly efficient sky blue electroluminescence from ligand-activated copper iodide clusters: Overcoming the limitations of cluster light-emitting diodes. *Sci. Adv.* 5, eaav9857. <http://dx.doi.org/10.1126/sciadv.aav9857>.
- Yam, V.W.-W., Wong, K.M.-C., Zhu, N., 2002. Solvent-induced aggregation through metal...metal/π...π interactions: Large solvatochromism of luminescent organoplatinum(II) terpyridyl complexes. *J. Am. Chem. Soc.* 124, 6506–6507. <http://dx.doi.org/10.1021/ja025811c>.
- Yang, Z., Mao, Z., Xie, Z., Zhang, Y., Liu, S., Zhao, J., Xu, J., Chi, Z., Al-dred, M.P., 2017. Recent advances in organic thermally activated delayed fluorescence materials. *Chem. Soc. Rev.* 46, 915–1016. <http://dx.doi.org/10.1039/C6CS00368K>.
- Yersin, H., Donges, D., 2001. Low-lying electronic states and photophysical properties of organometallic Pd(II) and Pt(II) compounds. In: *Modern Research Trends Presented in Detailed Case Studies*. Springer, Berlin, Heidelberg, pp. 81–186. http://dx.doi.org/10.1007/3-540-44474-2_3.
- Yersin, H., Finkenzeller, W.J., 2008. Triplet emitters for organic light-emitting diodes: Basic properties. In: *Highly Efficient OLEDs with Phosphorescent Materials*. Wiley-VCH Verlag GmbH & Co., KGaA, Weinheim, Germany, pp. 1–97. <https://doi.org/10.1002/9783527621309.ch1>.
- Yersin, H., Rausch, A.F., Czerwiec, R., 2013. Organometallic emitters for OLEDs: Triplet harvesting, singlet harvesting, case structures, and trends. In: *Physics of Organic Semiconductors*. Wiley-VCH Verlag GmbH & Co., KGaA, Weinheim, Germany, Germany, pp. 371–424. <http://dx.doi.org/10.1002/9783527654949.ch13>.
- Yersin, H., Rausch, A.F., Czerwiec, R., Hofbeck, T., Fischer, T., 2011. The triplet state of organo-transition metal compounds. Triplet harvesting and singlet harvesting for efficient OLEDs. *Coord. Chem. Rev.* 255, 2622–2652. <http://dx.doi.org/10.1016/j.ccr.2011.01.042>.
- Yu, T., Liu, L., Xie, Z., Ma, Y., 2015. Progress in small-molecule luminescent materials for organic light-emitting diodes. *Sci. China Chem.* 58, 907–915. <http://dx.doi.org/10.1007/s11426-015-5409-7>.
- Zanoni, K.P.S., Coppo, R.L., Amaral, R.C., Murakami Iha, N.Y., 2015. Ir(<sc>i>iii</i>) complexes designed for light-emitting devices: beyond the luminescence color array. *Dalt. Trans.* 44, 14559–14573. <http://dx.doi.org/10.1039/C5DT01644D>.
- Zanoni, K.P.S., Kariyazaki, B.K., Ito, A., Brennaman, M.K., Meyer, T.J., Murakami Iha, N.Y., 2014. Blue-green iridium(III) emitter and comprehensive photophysical elucidation of heteroleptic cyclometalated iridium(III) complexes. *Inorg. Chem.* 53, 4089–4099. <http://dx.doi.org/10.1021/ic500070s>.

- Zhan, G., Zhong, W., Wei, Z., Liu, Z., Liu, X., 2017. Roles of phenol groups and auxiliary ligand of copper(II) complexes with tetradentate ligands in the aerobic oxidation of benzyl alcohol. *Dalt. Trans.* 46, 8286–8297. <http://dx.doi.org/10.1039/C7DT01716B>.
- Zhang, Fuli, Guan, Y., Chen, X., Wang, S., Liang, D., Feng, Y., Chen, S., Li, S., Li, Z., Zhang, Fuqiang, Lu, C., Cao, G., Zhai, B., 2017. Syntheses, photoluminescence, and electroluminescence of a series of sublimable bipolar cationic cuprous complexes with thermally activated delayed fluorescence. *Inorg. Chem.* 56, 3742–3753. <http://dx.doi.org/10.1021/acs.inorgchem.6b01847>.
- Zhang, C., Song, Y., Jin, G., Fang, G., Wang, Y., Raj, S.S.S., Fun, H.-K., Xin, X., 2000. Two novel anion cluster compounds with a planar 'open' structure [Et₄N]₂[MS₄Cu₄(SCN)₄(2-pic)₄] (M = W, Mo; 2-pic = 2-methylpyridine): synthesis, structural characterization, nonlinear response and large optical limiting properties. *J. Chem. Soc. Dalt. Trans.* 1317–1323. <http://dx.doi.org/10.1039/a909656f>.
- Zhao, W., Montgomery, J., 2016. Cascade copper-catalyzed 1, 2, 3-trifunctionalization of terminal allenes. *J. Am. Chem. Soc.* 138, 9763–9766. <http://dx.doi.org/10.1021/jacs.6b05216>.
- Zink, D.M., Volz, D., Baumann, T., Mydlak, M., Flügge, H., Friedrichs, J., Nieger, M., Bräse, S., 2013. Heteroleptic, dinuclear copper(I) complexes for application in organic light-emitting diodes. *Chem. Mater.* 25, 4471–4486. <http://dx.doi.org/10.1021/cm4018375>.