

Chakir, Asmae et al.

Article

Optimal energy management for a grid connected PV-battery system

Energy Reports

Provided in Cooperation with:

Elsevier

Suggested Citation: Chakir, Asmae et al. (2020) : Optimal energy management for a grid connected PV-battery system, Energy Reports, ISSN 2352-4847, Elsevier, Amsterdam, Vol. 6, Iss. 3, pp. 218-231,
<https://doi.org/10.1016/j.egyr.2019.10.040>

This Version is available at:

<https://hdl.handle.net/10419/243994>

Standard-Nutzungsbedingungen:

Die Dokumente auf EconStor dürfen zu eigenen wissenschaftlichen Zwecken und zum Privatgebrauch gespeichert und kopiert werden.

Sie dürfen die Dokumente nicht für öffentliche oder kommerzielle Zwecke vervielfältigen, öffentlich ausstellen, öffentlich zugänglich machen, vertreiben oder anderweitig nutzen.

Sofern die Verfasser die Dokumente unter Open-Content-Lizenzen (insbesondere CC-Lizenzen) zur Verfügung gestellt haben sollten, gelten abweichend von diesen Nutzungsbedingungen die in der dort genannten Lizenz gewährten Nutzungsrechte.

Terms of use:

Documents in EconStor may be saved and copied for your personal and scholarly purposes.

You are not to copy documents for public or commercial purposes, to exhibit the documents publicly, to make them publicly available on the internet, or to distribute or otherwise use the documents in public.

If the documents have been made available under an Open Content Licence (especially Creative Commons Licences), you may exercise further usage rights as specified in the indicated licence.



<https://creativecommons.org/licenses/by-nc-nd/4.0/>

Tmrees, EURACA, 04 to 06 September 2019, Athens, Greece

Optimal energy management for a grid connected PV-battery system

Asmae Chakir^{a,b}, Mohamed Tabaa^{c,*}, Fouad Moutaouakkil^{a,b}, Hicham Medromi^{a,b},
Maya Julien-Salame^d, Abbas Dandache^d, Karim Alami^c

^a Foundation of Research, Development and Innovation in Sciences and Engineering, Casablanca, Morocco

^b EAS Research team, Laboratory of Research in Engineering, ENSEM Casablanca, Morocco

^c Pluridisciplinary Laboratory of Research & Innovation (LPRI), EMSI Casablanca, Morocco

^d LGIPM Lab, Lorraine University, France

Received 19 September 2019; accepted 28 October 2019

Available online 13 November 2019

Abstract

The increase demand for electricity and the non-renewable nature of fossil energy makes the move towards renewable energies required. However, the common problem of renewable sources, which is the intermittence, is overcome by the hybridization of complementary sources. Thus, whenever the load demand is not fully covered by the primary source, the second one will absolutely support it.

Furthermore, the production, the interaction with the grid and the storage system must be managed by the grid-connected hybrid renewable energy system, which is the main objective of this paper. Indeed, we propose a new system of a grid-connected PV-battery, which can manage its energy flows via an optimal management algorithm. The DC bus source connection topology in our proposed hybrid architecture tackles the synchronization issues between sources when the load is powered. We consider in this work that choosing a battery discharge and charge limiting power provides an extension of the battery life. On the other hand, we simulated the dynamic behavior of the architecture's various components according to their mathematical modeling. Following this, an energy management algorithm was proposed, and simulated using MATLAB/SIMULINK to serve the load. The results have shown that the load was served in all cases, taking into account the electrical behavior of the inhabitants as well as the weather changes on a typical day. Indeed, the load was served either by instant solar production between sunrise and sunset, or the recovery from sunset to 10pm, which could be a stored or injected energy without exceeding the 1000W per hour.

© 2019 Published by Elsevier Ltd. This is an open access article under the CC BY-NC-ND license (<http://creativecommons.org/licenses/by-nc-nd/4.0/>).

Peer-review under responsibility of the scientific committee of the Tmrees, EURACA, 2019.

Keywords: Renewable energy; PV-battery; Hybrid renewable system; Energy management; Hybrid architecture

1. Introduction

In last few years, the energy consumption has been raised in Africa, but energy source systems still under developed to meet the demand. In fact, energy consumption in Africa was about 752 million tons of oil, and 20%

* Corresponding author.

E-mail address: med.tabaa@gmail.com (M. Tabaa).

<https://doi.org/10.1016/j.egy.2019.10.040>

2352-4847/© 2019 Published by Elsevier Ltd. This is an open access article under the CC BY-NC-ND license (<http://creativecommons.org/licenses/by-nc-nd/4.0/>).

Peer-review under responsibility of the scientific committee of the Tmrees, EURACA, 2019.

Nomenclature

PV	Photovoltaic
COP	Conference of the parties
TOU	Time of use
AC	Alternative current
DC	Direct current
SOC	State of charge
NWP	Numerical weather predictions

of it was dedicated just to North Africa [1]. Although, this location is characterized by a significant renewable energy potential [2]. This explains the policy of Morocco, as a country in North Africa, to accomplish 52% of renewable energy in the total energy mix by 2030 [3]. Indeed, the target could be achieved by large scale renewable plant as concentrated farms, but the development of hybrid energy system as small scale plant could be also a track. Therefore, renewable energy is a good alternative to achieve the green objectives set by Morocco [4], but the intermittency and uncertain nature still be a challenge. The first issue is tackled by hybridization, which is considered as a system exploiting two or more complimentary sources, especially renewable ones [5]. Otherwise, the behavior's prediction of renewable energy could be simulated by mathematical model using the meteorological parameters, which is developed in our study. For other models with non-access to Numerical Weather Predictions (NWP), authors in [6] proposed an offline model to forecast the short term PV power. Alternatively, and for potential availability constraints, the system can be satisfied with a single primary source with a backup storage. Following this, several researchers have begun to be interested in the study of feasibility, techno-economic optimality, or even the energy management of hybrid sources, which spawned several reviews in this sense [7].

With a hybrid bus configuration, authors in [8] propose a method to find which hybridization of the photovoltaic (PV)-Wind-Battery system is cost effective. In [9], they showed the coupled PV-wind as the optimal solution for Morocco. Authors in [10], by taking into account the Time Of Use (TOU), using two switching methods for a hybrid grid-connected PV-battery system and they succeed to reduce electricity bill consumption to 50%. Likewise, in [11] they developed a parallel resource switch control of PV-Wind-Battery hybrid system which deals with autonomous systems. Otherwise, in [12] authors sized a hybrid system as a backup source during blackouts; its energy management objectives were to minimize the cost of total energy consumed from the grid and prolong the battery lifetime. For the same purpose, the authors in [13] performed a predictive model control of a grid connected PV system with hybrid storage.

We notice that all the structures proposed in works cited previously have dealt with the problem of sizing components and the cost minimizing of electricity purchased from grid. However, the design of the system does not take into account the technical constraints, such as the threshold of continuous bus voltage, especially for grid-connected systems. On the other hand, the problem of synchronization still present especially in hybrid bus configurations, even if the reliability of the system is remarkable. In addition, the management of renewable surplus production and critical cases due to insufficient energy were neglected.

In this work, the main goal is to study a new hybrid architecture solution for the PV-battery system connected to the grid. The latter, using our energy management algorithm, is able to manage its energy sources, and estimate its consumption from each source, in a time step of one hour. Our hybrid grid-connected PV-battery architecture was developed respecting technical constraints and components health state. Also the system can work in both isolated and connected mode. To do so, a modeling of the different sources and constraints of the system was developed and simulated. The same constraints were taken into consideration when designing the flowchart of the energy management procedure, as well as the algorithm implemented on MATLAB. Furthermore, the proposed system overcomes other limitations such as AC sources synchronization issues, deterioration of the battery's health status, inadequate energy management during surpluses and energy shortages. This is proven by MATLAB simulation.

The paper structured as follow, the first section dedicated to the presentation of the hybrid architecture of the PV-battery system; and devoted to the mathematical sub-components modeling. The second section describes the proposed energy management system. The third section presents simulation and results. A discussion is drawn in the fourth section. We conclude this work with summarizing results and we anticipate future researches.

2. Hybrid system architecture and design

2.1. Our proposed architecture

The choice of renewable sources to hybridize still important, but the connection of these components also remains a major element for a reliable system to avoid the technical problems that can affect the performance of the system. The interaction between power elements, the current form and its transformation inside the system classify it into various configurations. Indeed, configurations could be summarized into DC coupled, AC coupled and hybrid coupled system. Otherwise, the choice depends on the system application, and some criteria reported in [14]; noticing that there is not one fit all configuration. The main objective of our study is to propose PV-hybrid battery architecture able to connect or disconnect from the grid to manage its excess/lack of energy. The idea is to connect a PV-battery hybrid installation in a house already connected to the grid and minimize the energy consumed from the grid. This will contribute to reduce the environmental impact by using the renewable energy instead of conventional sources; as well as reduce the house's monthly bill. For this purpose, the proposed hybrid structure is presented in Fig. 1. The figure shows our hybrid system on which our study is based. Indeed, the system includes a battery bank and its bidirectional DC/DC converter, a photovoltaic installation and its unidirectional DC/DC converter to extract its maximum power, the electrical grid and its AC/DC converter to avoid the synchronization problem, the DC/AC converter to serve the load and finally $e_i(t)$ with $i = \{1,2,3,4\}$, which represent all the control switches in Fig. 1. System will be able to manage its excess energy while feeding it into the grid or storing it in the battery storage system for future use if necessary. However, it is necessary to respect a number of technical constraints related to the proper functioning of the installation, indeed, the rectifier is a bidirectional system that cannot work in its two modes simultaneously and for the battery health, it cannot be charged and discharged at the same time.

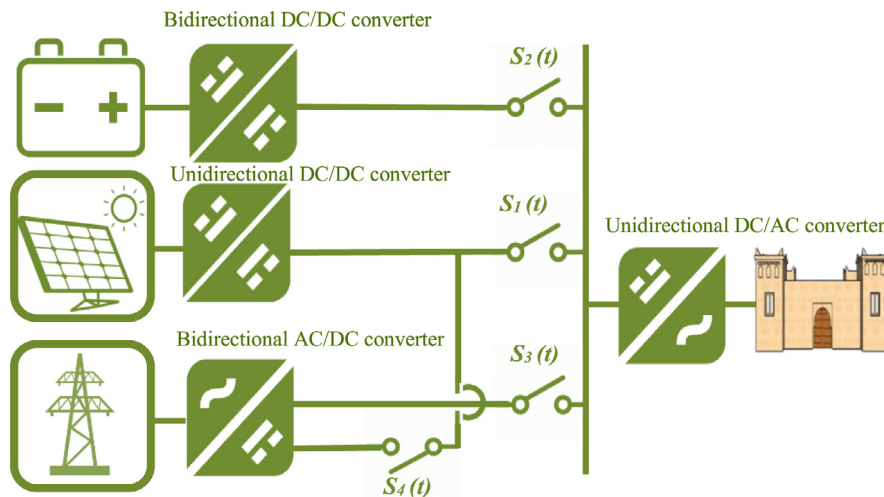

Fig. 1. The switching structure of the hybrid system.

In our case, we want to secure a solar power plant supplying a Moroccan house with a battery storage system. According to the world perspectives, carried out by the World Bank, in 2020, the average consumption per person will be around 1111 kWh/yr [15]. Forecasts have been made to estimate this consumption from 2015 to 2020 (Table 1) by the World Bank via estimates based on Jacob Cohen's analysis [16].

Moreover, according to the High Commission for the Plan, the average size of a household is around four people. Therefore, a household will be a consumer of electricity requesting a daily energy around 13 kWh. By taking into account these specifications and other constraints related to the DC bus threshold, average battery capacity autonomy of three days, the technical specifications of the hybrid system are shown in Table 2.

To manage the energy of this hybrid system, a good knowledge of the energy status of each component of the system is required. To do this, the following sub-section focuses on the mathematical modeling of hybrid system components.

Table 1. Electrical consumption forecast from 2015 to 2020 [15].

Year	Consumption (kWh/person)	Variation (%)
2015	948	5.15
2016	980	3.46
2017	1013	3.34
2018	1046	3.24
2019	1076	3.13
2020	1111	3.04

Table 2. Hybrid system design.

DC bus voltage (V)	Solar power plant (W)	Battery capacity (Ah)
400 V	20 panels of 300 Wp	600 Ah

2.2. Mathematical component modeling

2.2.1. PV array

The solar panel could be modeled using a single or double diode circuit. The most common circuit model is the single diode one, which was considered in many studies [17,18]. For our case, the PV panel is modeled using the single diode equivalent diagram. Following this, the solar output current is expressed as Eq. (1) while considering that the characteristic resistances are neglected [19,20], i.e. the circuit in Fig. 2. is ideal.

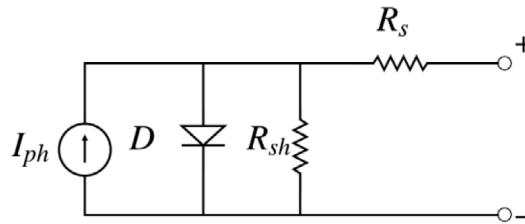

Fig. 2. The equivalent circuit of the PV.

$$i_{PV}(G, T) = \frac{G}{G_n} [I_{scn} + k_i(T - T_n)] - \frac{I_{scn} + k_i(T - T_n)}{\exp\left(\frac{V_{ocn} + k_v(T - T_n)}{nN_s k_B T/q}\right) - 1} \cdot \left[\exp\left(\frac{v_{PV}}{nN_s k_B T/q}\right) - 1 \right] \quad (1)$$

where G (W/m^2) and T ($^\circ\text{C}$) are considered as the ambient irradiation and temperature, G_n and T_n are the irradiation and temperature at standard conditions ($1000 \text{ W}/\text{m}^2$, $25 \text{ }^\circ\text{C}$). Noting that, q ($1.6021646 \times 10^{-19} \text{ C}$) the electron charge, k_B ($1.3806503 \times 10^{-23} \text{ J}/^\circ\text{K}$) the Boltzmann constant, n is the diode ideality factor, generally taken between [1, 2], I_{scn} (A) is the cell's short circuit current at standard test condition, k_i ($\text{A}/^\circ\text{C}$) is the coefficient of short circuit current, otherwise V_{ocn} (V) the open circuit voltage and k_v ($\text{V}/^\circ\text{C}$) is the open circuit voltage variation coefficient and finally N_s is the series connected cells on the panel, respectively. Eq. (1) give us the output current for a single PV panel, if we want to visualize the behavior of a PV plant, we must take into regard the numbers N_{ss} , N_p of panels connected in series and in parallel, respectively, which is presented by Eq. (2). We propose in our PV panel mathematical model to express the output current of a cell as a function of the voltage v_{pv} . Thus, the power extracted from the panels is the product of the output current and the voltage at its terminals Eq. (3).

$$i_{PV}(G, T) = \frac{G}{G_n} N_p [I_{scn} + k_i(T - T_n)] - \frac{(I_{scn} + k_i(T - T_n))N_p}{\exp\left(\frac{(V_{ocn} + k_v(T - T_n))N_{ss}}{nN_s N_{ss} k_B T/q}\right) - 1} \cdot \left[\exp\left(\frac{v_{PV}}{nN_s N_{ss} k_B T/q}\right) - 1 \right] \quad (2)$$

$$P_{pv}(T, G) = i_{pv}(G, T)v_{pv}(G, T) \quad (3)$$

To obtain the maximum, we will derive the function of the power in term of panel voltage; therefore the new characteristic function of the output power is expressed as below:

$$P_{pv}(T, G, v_{pv}) = \left\{ \frac{G}{G_n} N_p [I_{scn} + k_i (T - T_n)] - \frac{(I_{scn} + k_i (T - T_n)) N_p}{\exp\left(\frac{(V_{ocn} + k_v (T - T_n)) N_{ss}}{n N_s N_{ss} k_B T}\right) - 1} \cdot \left[\exp\left(\frac{v_{pv}}{q}\right) - 1 \right] \right\} \times v_{pv}(G, T) \quad (4)$$

This modeling will allow us to have for each combination (T, G) a maximum power to be physically extracted via several MPPT maximum power extraction methods [21,22]. For a combination (T, G), we assume the following constants:

$$A(T, G) = \frac{G}{G_n} [I_{scn} + k_i (T - T_n)] N_p \quad (5)$$

$$B(T, G) = \frac{(I_{scn} + k_i (T - T_n)) N_p}{\exp\left(\frac{(V_{ocn} + k_v (T - T_n)) N_{ss}}{v_t}\right) - 1} \quad (6)$$

$$v_t = \frac{n N_s k_B T N_{ss}}{q} \quad (7)$$

Therefore, the power will be expressed as follow, taking into account the Eqs. (5)–(7) which are assumed to be constant for each pair (T, G).

$$P_{pv}(T, G, v_{pv}) = (A(T, G) - B(T, G) e^{\frac{v_{pv}}{v_t}}) v_{pv} \quad (8)$$

On the other hand, the derivative of the power function with respect to the voltage is given by Eq. (9).

$$dP_{pv}(T, G, v_{pv}) = A(T, G) - B(T, G) e^{\frac{v_{pv}}{v_t}} - \frac{(B(T, G) v_{pv} e^{\frac{v_{pv}}{v_t}})}{v_t} \quad (9)$$

The voltage corresponding to the maximum power is the one that cancels Eq. (9), its expression is as follow.

$$v_{mpp} = v_t \left(\text{Lambert}w\left(0, \frac{A(T, G) \exp(1)}{B(T, G)}\right) - 1 \right) \quad (10)$$

where the Lambert W function is the reverse function of the expression $v_{pv} e^{\frac{v_{pv}}{v_t}}$ present in Eq. (10), more details are described in [23]. So the maximum power is found while replacing each term of v_{pv} in Eq. (8), by the v_{mpp} expression described by Eq. (10).

What has been demonstrated is our method estimation of the available power available to be injected into the DC bus. However, the efficiencies of the conversion equipment are taken into account in our study. As a result, the final estimation of the available power is given by Eq. (11). Where, η_{DC} is the efficiency of the DC/DC converter linked to the solar system.

$$P_{pv}(G, T) = P_{pv}(G, T, v_{mpp}) \eta_{DC} \quad (11)$$

2.2.2. Storage system

The equivalent circuit of a battery could be considered as a simple electrical model of a battery cell, where the electromotive force E is connected in series with the internal resistance r of the battery. Indeed, by applying the Kirchhoff's law, we find the following expression. E_b is the voltage of the source; R_{batt} is the internal resistance and n_b is the cell number.

$$U_{batt} = n_b \times E_b \mp n_b \times R_{batt} \times I_{batt} \quad (12)$$

The battery capacity is given by Eq. (13) [24]. With ΔT is the temperature of the accumulator, C_{I0} the nominal capacity for a nominal current of I_{I0} . Moreover, the state of charge is expressed by Eq. (14), with t is the discharge time at a current of I_{batt} . On the other hand, the charge and discharge voltages are expressed by Eqs. (15) and (16) respectively [25].

$$C_{Batt} = C_{I0} \frac{1.67 \times (1 + 0.005 \times \Delta T)}{1 + 0.67 \times \left(\frac{I}{I_{I0}}\right)^{0.9}} \quad (13)$$

$$SoC = 1 - \frac{I_{batt} \times t}{C_{batt}} \quad (14)$$

$$V_{Charge} = n_b \times (2 + 0.16 \times SOC) + n_b \times \frac{I_{batt}}{C_{10}} \left(\frac{6}{1 + I_{batt}^{1.3}} + \frac{0.27}{SOC^{1.5}} + 0.002 \right) \times (1 - 0.007 \times \Delta T) \quad (15)$$

$$V_{DisCharge} = n_b \times (2 + 0.16 \times SOC) - n_b \times \frac{I_{batt}}{C_{10}} \left(\frac{6}{1 + I_{batt}^{1.3}} + \frac{0.27}{SOC^{1.5}} + 0.002 \right) \times (1 - 0.007 \times \Delta T) \quad (16)$$

The most significant element of a battery's energy state is its state of charge (SOC). The latter depends essentially on the charge and discharge process of the battery. Indeed, the state of charge is the available energy compared to the maximum total energy of the battery. So we have:

$$\frac{dE_{batt}}{dt} = P_{batt} \quad (17)$$

where, E_{batt} is the battery energy and R_{batt} the energy power. In our case, the variation of the energy in the system is determined by the power available on the DC bus. Indeed, it is zero, positive or negative, which means that the battery is not operational, in a state of charge or in discharge, respectively. Following this, the variation in battery energy is estimated by Eq. (18). Using Eq. (15) and taking into account the two states of charge and discharge of the battery, the variation in battery energy is expressed by the system (19).

$$E_{batt}(t) = E_{batt}(t-1) + \Delta E_{batt} \quad (18)$$

$$\Delta E_{batt} = \begin{cases} P_{bus} \eta_{ch} \eta_{DC/DC} & \text{if } P_{bus} > 0 \\ \frac{P_{bus}}{\eta_{DC/DC} \eta_{dis}} & \text{if } P_{bus} < 0 \end{cases} \quad (19)$$

By considering that the Δt is equal to one hour, the variation of energy is the power available on the bus. The energy stored in the battery is less than the energy presented in the bus, because of losses caused by battery charging $P_{bus}(1-\eta_{ch})$ and by DC/DC conversion due to its efficiency $\eta_{DC/DC}$. Otherwise, the battery should support the discharging losses, and those caused by DC/DC converter while supporting the demand in the DC bus. i.e. $P_{bus} < 0$.

3. Our proposed energy management and switching system

Our control system must find the right state to assign to the decision vector defined as the group of switches presented in Fig. 1, i.e. $e(t) = [e_1(t), e_2(t), e_4(t), e_4(t)]$. At each instant, we want to compensate the power consumed from the grid. Furthermore, the idea is to give the highest priority to the PV, then to the batteries to meet the load demand. In lack of energy cases, the house executes its local management system, i.e. the load shedding, reduction or translation of tolerant load demand; otherwise, the system takes energy from the grid, which will be the recovery of the energy injected during the excess production. Indeed, over a selected period T , the steady-state searched is that defined with the following equation:

$$e_3(t) P_{Res}(t) + e_1(t) P_{pv}(t) \eta_{DC} + e_2(t) P_{batt}(t) \eta_{DC/DC} = \frac{P_{load}}{\eta_{inverter}} + \frac{e_4(t) P_{pv}(t) \eta_{DC}}{\eta_{Red}} \quad (20)$$

In order to work within standards, several constraints must be respected by our system. Indeed, the three sources cannot inject energy at the same time, the injection into the grid cannot be made while consuming the energy from it, and finally the battery must not supply energy within its recommended range nor be charged and discharged at the same time. These constraints are modeled with the following equations.

$$e_3(t) + e_4(t) \leq 1 \quad (21)$$

$$e_1(t) + e_2(t) + e_3(t) \leq 2 \quad (22)$$

$$P_{min} \leq P_{Batt}(t) \leq P_{max} \quad (23)$$

Our management system begins by the estimation of the hybrid energy resource using the mathematical model described in the previous section then move on to the study of the state of the switches according to the flowchart below Fig. 4. The algorithm that describes the flowchart steps in details is presented by Fig. 3. According to this management algorithm, the state mode system could be: state of balance, excess or lack of energy. Also, the battery

Algorithm 1: Energy management algorithm

Result: control switching states

initialization
 Collect (T,G), P_{load} ;
 Initialize state of battery with its maximum state of charge and power SOC_{max} , $P_{battmax}$;
 $P_{grid} = 0$, $E_i = [0000]$

while While 1 **do**
 Estimate P_{mpp} ;
if $P_{mpp} == P_{load}$ **then**
 $P_{grid} = 0$;
 $E_i = [1000]$;
 Hold previous battery state;
end
if $P_{mpp} > P_{load}$ **then**
 if $SOC == SOC_{max}$ **then**
 $E_i = [1001]$;
 $P_{grid} = P_{mpp} - P_{load}$;
 Hold previous battery state of charge and power;
 else
 Estimate the battery lack power P_{battn} ;
 if $P_{battn} > P_{mpp} - P_{load}$ **then**
 Update SOC, P_{batt} ;
 $P_{grid} = 0$;
 $E_i = [1100]$;
 else
 $P_{grid} = P_{mpp} - P_{load} - P_{batt}$;
 Update SOC, P_{batt} ;
 $E_i = [1101]$;
 end
 end
end
if $SOC == SOC_{min}$ **then**
 $E_i = [1010]$;
 $P_{grid} = P_{mpp} - P_{load}$;
 Hold previous battery state of charge and power;
else
 Estimate the battery available power P_{battn} ;
 if $P_{battn} > P_{load} - P_{mpp}$ **then**
 Update SOC, P_{batt} ;
 $P_{grid} = 0$;
 $E_i = [1100]$;
 else
 $P_{grid} = P_{mpp} - P_{load} + P_{batt}$;
 $SOC = SOC_{min}$;
 $P_{batt} = P_{battmin}$;
 $E_i = [1010]$;
 end
end

Fig. 3. Proposed energy management and switching algorithm.

could be in charge, discharge or in rest mode. Moreover, the grid could be connected to inject the surplus of production, or during the critical state just as a backup line. The hybrid system consists of four switches, which correspond to binary control variables. In probability, this system accepts 24 possibilities; this is equivalent to 16 options. However, the majority of possibilities are eliminated by constraints or by non-valid conditions for example, 0000 and 1111 or even 0010 which represent the non-connection of any source, the presence of all sources and the injection of all energy without serving the demand, respectively. Contrary to several solutions represented in many works based on optimization method, our proposed energy algorithm takes into account the simplicity and the low cost implementation of the algorithm developed to solve the energy management problem. Indeed, the

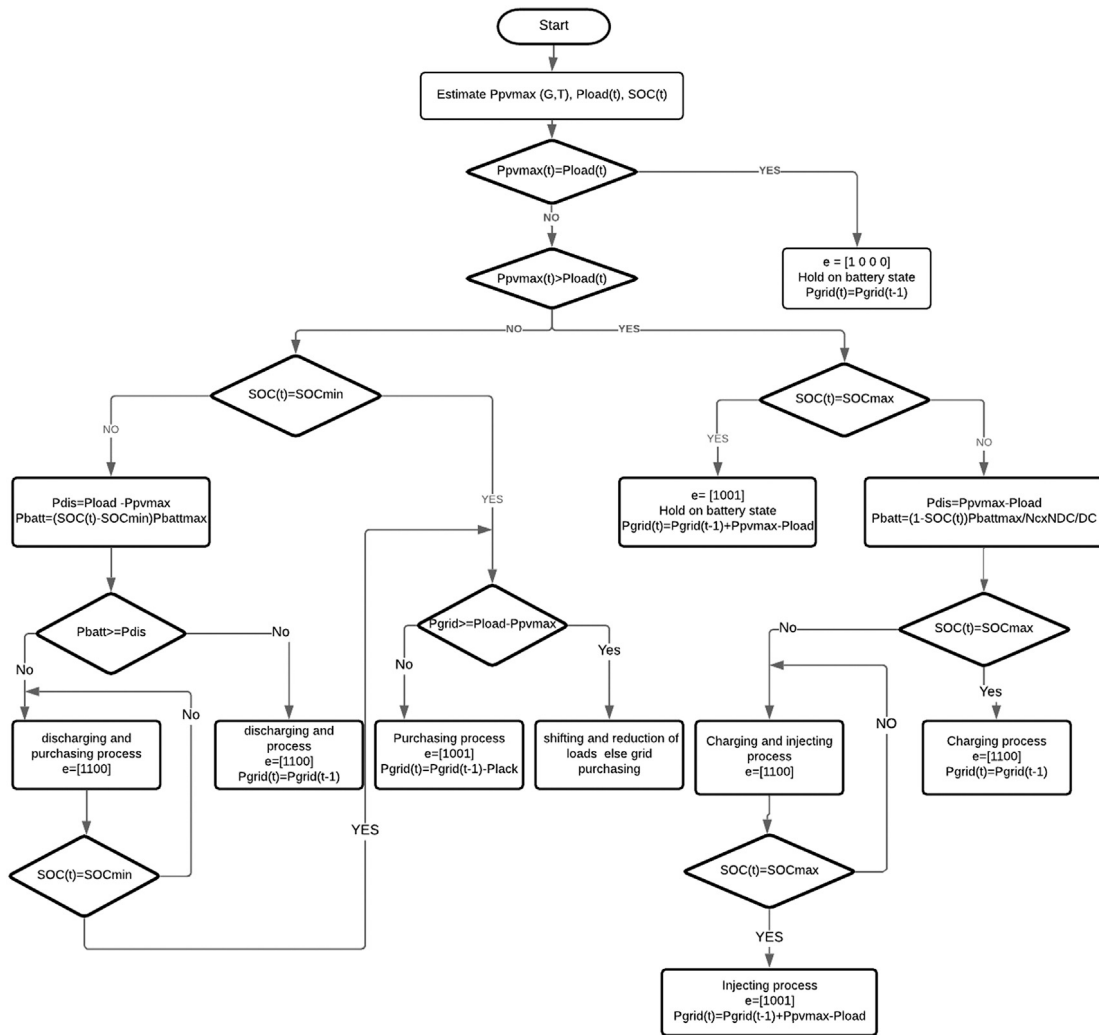

Fig. 4. Proposed energy management and switching flowchart.

system does not require much memory, or mathematical equations that are difficult to solve which is the case for other alternatives. Furthermore, the algorithm responds to a problem with the execution of real-time switching, i.e. based on the demand of the residents. The load we are looking to satisfy is not constant throughout the day, a consumption sensor makes its estimation and a random vector that varies between zero and the maximum power of the considered study house ensures its dynamics on the simulation. The system also takes into account the losses caused by the power electronics converters. As a result, the system calculates each time the power available on the DC bus noted P_{dis} in the flowchart, which is none other than the power produced by the source corrected by the conversion system efficiency coefficient that has been combined with it. The charging system is based on the summation of the consumption of all the loads that are in operation at t instant of day. In case of lack, the global management system initiates the local management system that depending on the type of load decides its criticality to be powered during the t instant mode or not. Indeed, the loads are divided into two categories, fixed and mobile loads. Mobile loads are also divided into reducible, interruptible and non-interruptible loads.

So the local management system starts by limiting the load demand by eliminating interruptible loads and programming them during excess energy hours, and reducing the reducible loads to 50% of their consumption. After this correction if the requested load remains higher than the one produced, the electrical network takes over.

4. Simulation and results

4.1. Uncertain variables: temperature, irradiation and power demand

The uncertain variables of our system are: Energy demand and weather conditions, namely: temperature and irradiance. The determination of a site's renewable potential can be done by interpolating reliable measurement point data from nearby regions, which has been achieved by using neural networks in [26], in order to determine the solar potential in Morocco.

Otherwise, the energy demand is estimated by studying the electrical behavior of the inhabitants. However, this parameter does not influence the results of our algorithm. Indeed, our program is managed in real time and does not require a prior processing. To simulate our program and validate it in all cases, an interval of random consumption [0, 1500 W] was considered, see Fig. 6. This value (1500 W) was estimated as the dispersion of the total energy consumed daily over an average consumption time of 9 h. For temperature and irradiances, we simulate our study for a house in Marrakech, Morocco with an average daily irradiances of 5.4959 kWh/m² [27], the distribution of this irradiances over one day, was carried out via TRNSYS, combined to METEONORM as a reliable database of metrological conditions, which is presented by Fig. 5.

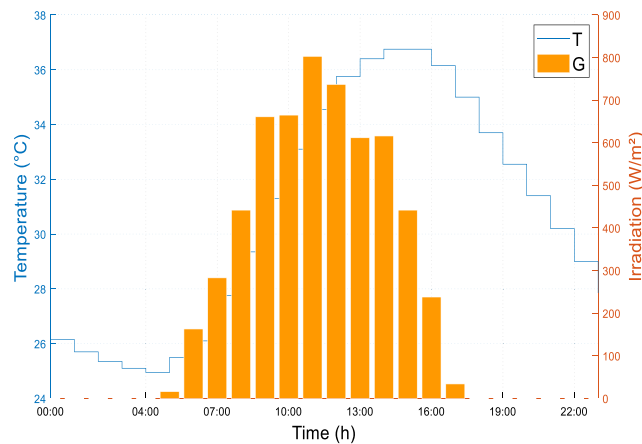

Fig. 5. Temperature and irradiation variation.

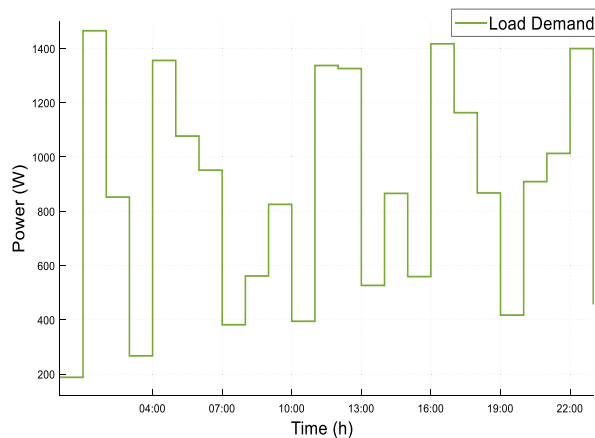

Fig. 6. Electrical power demand variation.

4.2. PV panel and plant behavior

The power equation is a triple-parameter function, namely: irradiation, temperature and voltage. Thus for each pair of metrological conditions (G,T), the panel responds by producing a power for each voltage applied to these

terminals, explained in Fig. 7. The irradiation is the parameter that strongly affects the production of a panel. Although the voltage decreases while increasing temperature, this slightly reduces the output power. Contrarily, the irradiances directly affect the creation of current in the junctions. Also, the difference between the 300 Wp mentioned by the constructor and the 314.6 Wp found by simulation is due to losses in the serial and parallel resistances caused by real tests.

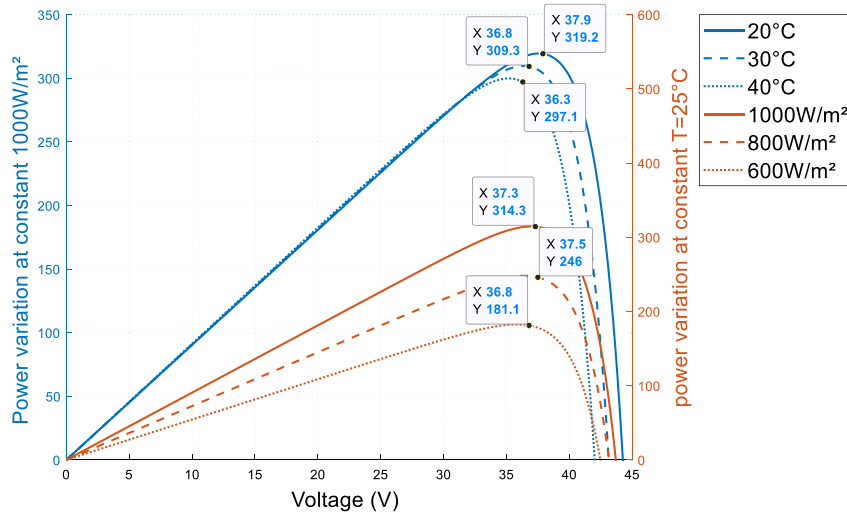

Fig. 7. PV panel behavior under different meteorological conditions.

4.3. Battery storage behavior

The behavior study of all battery's types [28] is divided into electrical part [29] and battery aging prediction part [30]. In the electrical part, we consider the study of the link between the different electrical parameters, namely: current, capacity, voltage and the state of charge. Assuming no temperature variation, the battery capacity decreases by increasing the discharge current. Indeed, the capacity mentioned by the constructor does not correspond to the capacity of the battery during all operating conditions. The temperature, operating time and the required electric current effects should not be neglected, which is held in account by Eq. (13). Also, the higher the charging current is the shorter the recovery time of the storage energy will be. But, the charging current must not exceed a maximum value to protect the battery's from degradation. The presence of the state of charge in the equations, explains why some researchers consider voltage as a variable decision of battery's state. Indeed, by applying a battery charging technique [31] the battery voltage starts to increase until it reaches the float voltage, otherwise during discharge, the voltage decreases with time and demand current Fig. 8.

For a battery with a nominal voltage of 12 V, the recommended control system cut-off voltage is 11.8 V that corresponds to $SOC_{min} = 50\%$. However, during the final stages of charging cell voltage is usually regulated to a float value, typically as a maximum 2.35 – 2.45 V [29], in our case it is around 13.8 V by battery unit.

4.4. Energy management and control simulation

Our algorithm is considered intuitively predictive, because we have assumed that the power demand variation depends on time slots, and the battery power is the average consumption/hour of the charge. Also solar irradiances can be assumed to vary significantly per hour. The power required by the load and the system behavior in response to this demand are explained in Fig. 9. The priority is given to solar production, battery, and in case of excess or lack of energy the grid intervenes, respectively. This is ensured by switches transition. We notice that when one of the sources intervenes, its switch takes the unit state to collaborate on the DC bus. The differences between the required power and the actual power consumed are due to the efficiencies of the conversion systems that were taken into account during MATLAB modeling and simulation. Indeed, when the solar system is able to supply all

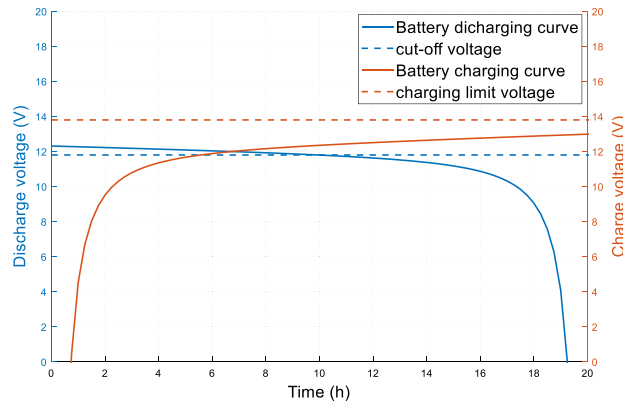

Fig. 8. Charging and discharging curve of a battery storage.

the electricity to the load, the excess is fed into the grid unless the battery is not at its maximum state of charge. However, if the power required by the load exceeds the power produced by the solar system, then the difference is ensured by the battery. If the battery is at its minimum state of charge and the panels are still unable to ensure the lack, the grid compensates the difference.

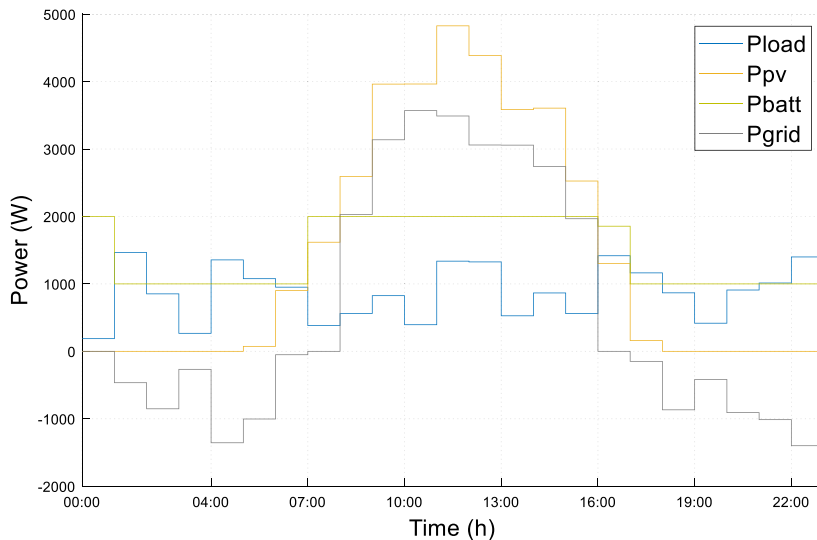

Fig. 9. Result of the dynamics of the hybrid system connected to the network.

5. Discussion

Several studies have dealt with the case of energy management; the difference was noticed in the sources used, the storage system taken into account and the connection or not to the grid. Among these works, we find those mentioned in Table 3. Indeed, Wu et al. [10] the authors compared the intuitive solution with the optimal control. The results showed that the optimal system could reduce the cost of electricity more than the predictive system. This is a consequence, because they did not take into account the cost constraint or the price per time slot for the intuitive approach. Furthermore, the system architecture does not take into regard the injection of PV energy in case of excess. In addition, battery constraints force the battery to be either in charge or discharge mode, but neither in rest mode. Others in [12] consider the battery lifetime for their proposed system. Indeed, the study deals with countries where electricity producers distribute available energy according to a specific schedule, which results in planned blackouts. Indeed, as a consequence of mixed integer non-linear programming problem solved via the

Table 3. Comparative study of related work.

References	Energy sources	Storage system	Bus configuration	Energy management system strategy	Optimization objectives	Energy management system approach
Wu et al. [10]	PV	Battery	AC bus	Grid-connected	Minimizing the electricity cost	Linear programming / intuitive control
Sabiri et al. [11]	PV/Wind	Battery	DC bus	Standalone	Satisfying the demand	Flowcharts
Alramlawi et al. [12]	PV	Battery	Hybrid bus	Grid-connected	Satisfying the demand/ minimizing the total cost of the grid consumed energy/ prolong battery lifetime	Dynamic optimization problem, Economic Model Predictive Control (EMPC)
Guichi et al. [32]	PV	Battery	Hybrid bus	Grid-connected	satisfy the battery, loads and grid energy needs	Flowchart
Bartolucci et al. [13]	PV	Battery, FC	DC bus	Grid-Connected	Minimizing total cost of the system	Mixed integer linear programming/ role based control/ model predictive control
Our proposed	PV	Battery	DC bus	Grid-connected	Optimal energy manage	Flowchart /Algorithm

genetic algorithms, a predictive switching program with a prediction horizon equal to the network availability period (ON–OFF) was obtained. However, the architecture forces the electrical current of the system to be unidirectional except for the battery. This, as well as constraints on switch status, disadvantages the management of excess PV and still considers the grid as a primary source. However, with hybrid energy storage, authors in [13] studied the comparison between two different energy control management strategies. The first is a rule-based method, and the second is a model predictive control. Their structure shows that the battery is connected directly to the DC bus, which leads to a health deterioration. On the other hand, the choice of DC bus voltage does not respect the inverter input voltage threshold, whether for injection or AC load supply. In addition, the intuitive system uses a decision variable that is not relevant for control, such as the voltage for determining the state of charge of the battery. We notice that the above work used a linear and dynamic programming; otherwise energy management can be performed with a reduced state number algorithm, which is the case for the work discussed below. The architecture developed by Sabiri et al. [11] carried out a PV-wind-battery hybrid system. The work used a parallel resource solution to manage the use of energy, which may cause losses when the energy is available to be supplied by both renewable sources. The storage control is not considered in this study according to significant states of charge (SOC). With also a flowchart solution, the authors of Guichi et al. [32] sized the solar system to power the load and charge the battery. This system follows the variations in grid demand. The limited power point mode was applied to overcome the excess of power produced by the panels due to the oversizing of the installation. Indeed, the authors must first take into account the maximum power that can be injected into the grid before sizing. Otherwise, their management system disadvantages the battery's health state by using 85% of its total capacity. Therefore, for our case, we studied the energy shared between sources of a grid-connected PV-battery system to meet the load. Indeed, following a mathematical modeling of the different components of our hybrid system, our energy management control forces the grid to be considered as an emergency line. At each time slot, the flowchart evaluates the energy coming from the PV plant, if it cannot support the load, the battery will take over. In critical situation the energy sold to the grid will be recovered.

6. Conclusion and future trends

A renewable hybrid system can be optimized in several ways, including sizing, extracting maximum power, or energy management. The latter is the most relevant in a renewable hybrid system and especially for those connected to the grid, and this is the case that has been discussed in our work. In this paper, we analyzed the end-user electricity

satisfaction by using a grid-connected system as a local micro grid. We proposed an energy management algorithm to handle the energy consumed by each source, namely: the solar source, the grid and the battery storage. The system configuration plays a very important role in the system; both at the sizing and management level. So to meet the technical constraints, the DC bus topology was considered and new hybrid architecture was proposed. The proposed energy management system comes to give priority to solar production, if not to the storage system, then to the national electricity grid. Furthermore, the energy produced by the solar system is managed even during excess. As results given by simulation are the same given by the constructor our mathematical modeling of the solar system is proven reliable, with a few watts accuracy due to the resistances losses. The proposed energy management algorithm is able to minimize the operational energy losses of a household. Indeed, a one-day simulation with a one-hour simple step was performed, and the results showed that the system is fully compliant with the technical constraints imposed during modeling and respect the priority orders mentioned above. Subsequently, the system will take into account the real electrical behavior of the Moroccan consumer, via the simulation of its statistical laws of behavior. On the other hand, our algorithm is perfectly adapted to a low-cost implementation that will also be taken into regard for our future work.

References

- [1] Ouedraogo S, Nadia. Africa energy future: Alternative scenarios and their implications for sustainable development strategies. *Energy Policy* 2017;106:457–71.
- [2] K. Boubaker. Renewable energy in upper North Africa: Present versus 2025-horizon perspectives optimization using a Data Envelopment Analysis (DEA) framework. *Renew Energy* 2012;43:364–9.
- [3] League of Arab States RCREEE, and IRENA. Renewable energy in the arab region, overview of developments. 2016.
- [4] Cantoni, Roberto, Rignall Karen. Kingdom of the Sun: a critical, multiscale analysis of Morocco's solar energy strategy. *Energy Res Soc Sci* 2019;51:20–31.
- [5] Juras Jakub, Beluco Alexandre, Canales Fausto A. The impact of complementarity on power supply reliability of small scale hybrid energy systems. *Energy* 2018;161:737–43.
- [6] Fentis Ayoub, Bahatti Lhoussain, Tabaa Mohamed, Mestari Mohammed. Short-term nonlinear autoregressive photovoltaic power forecasting using statistical learning approaches and in-situ observations. *Int J Energy Environ Eng* 2019;8.
- [7] Khan Faizan, Pal Nitai, Saeed Syed H. Review of solar photovoltaic and wind hybrid energy systems for sizing strategies optimization techniques and cost analysis methodologies. *Renew Sustain Energy Rev* 2018;92:937–47.
- [8] Roy, Anindita, Bandyopadhyay Santanu. Design and optimization of wind-PV-battery hybrid system. In: *Wind power based isolated energy systems*. Cham: Springer; 2019, p. 167–80.
- [9] Boussetta M, El Bachtiri R, Khanfara M, El Hammoumi K. Assessing the potential of hybrid PV–Wind systems to cover public facilities loads under different Moroccan climate conditions. *Sustain Energy Technol Assess* 2017;22:74–82.
- [10] Wu, Zhou, Xia Xiaohua. Optimal switching renewable energy system for demand side management. *Sol Energy* 2015;114:278–88.
- [11] Sabiri Zakaria, Machkour Nadia, Majdoub Khalid El, Kheddioui Elm'kaddem, Ouoba David, Ailane Abdellah. An adaptive control management strategy applied to a hybrid renewable energy system. *Int Rev Model Simul* 2017;10:258–67.
- [12] Alramlawi Mansour, Gabash Aouss, Mohagheghi Erfan, Li Pu. Optimal operation of hybrid PV-battery system considering grid scheduled blackouts and battery lifetime. *Sol Energy* 2018;161:125–37.
- [13] Bartolucci Lorenzo, Cordiner Stefano, Mulone Vincenzo, Rossi Joao Luis. Hybrid renewable energy systems for household ancillary services. *Electr Power Energy Syst* 2019;107:282–97.
- [14] Upadhyay, Subho, Sharma MP. A review on configurations, control and sizing methodologies of hybrid energy systems. *Renew Sustain Energy Rev* 2014;38:47–63.
- [15] Banque modiale. *Perspective Monde*. 2019, <http://perspective.usherbrooke.ca/bilan/tend/MAR/fr/EG.USE.ELEC.KH.PC.html>.
- [16] Cohen Jacob. The concepts of power analysis. In: *Statistical power analysis for the behavioral sciences (Revised Edition)*. 1977, p. 1–17, Chap. 1.
- [17] Barth Nicolas, Jovanovic Raka, Ahzi Saïd, Khaleel Mohammad A. PV panel single and double diode models: Optimization of the parameters and temperature dependence. *Sol Energy Mater Sol Cells* 2016;148:87–98.
- [18] Rasool Fahad, Drieberg Micheal, Badruddin Nasreen, Mahinder Singh Balbir Singh. PV panel modeling with improved parameter extraction technique. *Sol Energy* 2017;153:519–30.
- [19] Yang Yongheng, Kim Katherine A, Blaabjerg Frede, Sangwongwanich Ariya. PV system modeling, monitoring, and diagnosis. In: *Advances in grid-connected photovoltaic power conversion systems*. 2019, p. 45–74, Chap. 3.
- [20] Yang Yongheng, Kim Katherine A, Ding Tao. Modeling and control of PV systems. In: *Control of power electronic converters and systems*. 2019, p. 243–68, Chap. 9.
- [21] Verma Deepak, Nema Savita, Shandilya AM, Dash Soubhagya K. Maximum power point tracking (MPPT) techniques: Recapitulation in solar photovoltaic systems. *Renew Sustain Energy Rev* 2016;54:1018–34.
- [22] Chakir Asmae, Tabaa Mohamed, Fouad Moutaouakkil, Medromi Hicham, Alami Karim. Comparative study of MPPT methods for PV systems : Case of Moroccan house. In: *30th international conference on microelectronics (ICM)*. 2018, p. 311–4.
- [23] Veberič Darko. Lambert W function for applications in physics. *Comput Phys Comm* 2012;183:2622–8.
- [24] Rekioua, Djamila, Matagne Ernest. Optimization of photovoltaic power systems modelization, simulation and control. 2012.

- [25] Mokrani Zahra, Rekioua Djamilia, Rekioua Toufik. Modeling control and power management of hybrid photovoltaic fuel cells with battery bank supplying electric vehicle. *Int J Hydrogen Energy* 2014;39:15178–87.
- [26] Ouammi Ahmed, Zejli Driss, Dagdougui Hanane, Benchrifa Rachid. Artificial neural network analysis of Moroccan solar potential. *Renew Sustain Energy Rev* 2012;16:4876–89.
- [27] MASEN. Atlas de la ressource solaire du maroc. 2019.
- [28] Dehghani-Sanij AR, Tharumalingam E, Dusseault MB, Fraser R. Study of energy storage systems and environmental challenges of batteries. *Renew Sustain Energy Rev* 2019;104:192–208.
- [29] Badeda J, Huck M, Sauer DU, Kabzinski J, Wirth J. Basics of leadacid battery modelling and simulation. In: *Lead-acid batteries for future automobiles*. 2017, p. 463–507, Chap. 16.
- [30] Cai Jie, Zhang Hao, Jin Xing. Aging-aware predictive control of PV-battery assets in buildings. *Appl Energy* 2019;236:478–88.
- [31] Hussein Ala A, Fardoun Abbas A. Design considerations and performance evaluation of outdoor PV battery chargers. *Renew Energy* 2015;82:85–91.
- [32] Guichi Amar, Talha Abdelaziz, Berkouk El Madjid, Mekhilef Saad. Energy management and performance evaluation of grid connected PV-battery hybrid system with inherent control scheme. *Sustainable Cities Soc* 2018;41:490–504.