

Novotny, Vaclav; Vitvarova, Monika; Spale, Jan; Jakobsen, Jana Poplsteinova

Article

Intermediate pressure reboiling in geothermal flash plant for increased power production and more effective non-condensable gas abatement

Energy Reports

Provided in Cooperation with:

Elsevier

Suggested Citation: Novotny, Vaclav; Vitvarova, Monika; Spale, Jan; Jakobsen, Jana Poplsteinova (2020) : Intermediate pressure reboiling in geothermal flash plant for increased power production and more effective non-condensable gas abatement, Energy Reports, ISSN 2352-4847, Elsevier, Amsterdam, Vol. 6, Iss. 3, pp. 20-27, <https://doi.org/10.1016/j.egyr.2019.10.014>

This Version is available at:

<https://hdl.handle.net/10419/243975>

Standard-Nutzungsbedingungen:

Die Dokumente auf EconStor dürfen zu eigenen wissenschaftlichen Zwecken und zum Privatgebrauch gespeichert und kopiert werden.

Sie dürfen die Dokumente nicht für öffentliche oder kommerzielle Zwecke vervielfältigen, öffentlich ausstellen, öffentlich zugänglich machen, vertreiben oder anderweitig nutzen.

Sofern die Verfasser die Dokumente unter Open-Content-Lizenzen (insbesondere CC-Lizenzen) zur Verfügung gestellt haben sollten, gelten abweichend von diesen Nutzungsbedingungen die in der dort genannten Lizenz gewährten Nutzungsrechte.

Terms of use:

Documents in EconStor may be saved and copied for your personal and scholarly purposes.

You are not to copy documents for public or commercial purposes, to exhibit the documents publicly, to make them publicly available on the internet, or to distribute or otherwise use the documents in public.

If the documents have been made available under an Open Content Licence (especially Creative Commons Licences), you may exercise further usage rights as specified in the indicated licence.



<https://creativecommons.org/licenses/by-nc-nd/4.0/>



Tmrees, EURACA, 04 to 06 September 2019, Athens, Greece

Intermediate pressure reboiling in geothermal flash plant for increased power production and more effective non-condensable gas abatement

Vaclav Novotny^{a,b,*}, Monika Vitvarova^b, Jan Spale^a, Jana Poplsteinova Jakobsen^c

^a University Centre for Energy Efficient Buildings, Czech Technical University in Prague, Trinecka 1024, Bustehrad, 27343, Czech Republic

^b Faculty of Mechanical Engineering, Czech Technical University in Prague, Techicka 4, Prague 6, 16607, Czech Republic

^c Department of Chemical Engineering, Norwegian University of Science and Technology (NTNU), Trondheim 7491, Norway

Received 30 September 2019; accepted 18 October 2019

Available online 5 November 2019

Abstract

Non-condensable gases (NCG) in condensing geothermal flash plants have negative effects as they reduce heat transfer and thus deteriorate vacuum in condenser. Therefore, it is necessary to evacuate the condenser by vacuum pumps which substantially increases the parasitic load of the plant. Furthermore, NCG consist mostly of CO₂ and H₂S, gases for which methods of abatement are being searched for. In such case, further compressors or blowers are usually required to push the gas through absorption systems.

Alternative methods of NCG separation consider a reboiler upstream of a turbine. This process is however connected with significant loss of steam enthalpy, moreover the NCG in high content have also certain work potential. Therefore, this method is often not considered as very perspective.

We are proposing a novel solution where the turbine is split in two parts at high and low pressure. The splitting point is at a pressure right above an ambient pressure, wherein a reboiler is placed. By doing so the NCG stream is easily obtained without energy penalty of vacuum pumps, without decreasing turbine admission parameters, and also utilizes its pressure potential. This stream is thus easily ready for processing and subsequent CO₂ separation and conditioning. Condensed water is from large part turned back to steam in the cold side of reboiler which gives further work in low pressure turbine with achievable lower backpressure and therefore potential for higher power production. Another advantage of this method is liquid phase elimination from the turbine thus achieving higher turbine efficiency.

© 2019 Published by Elsevier Ltd. This is an open access article under the CC BY-NC-ND license (<http://creativecommons.org/licenses/by-nc-nd/4.0/>).

Peer-review under responsibility of the scientific committee of the Tmrees, EURACA, 2019.

Keywords: Geothermal; Emissions; CO₂; Non-condensable gases; Flash plant; Reboiler

1. Introduction

Non-condensable gases (NCGs) are naturally occurring in geothermal fluids. Their concentration in geothermal steam depends on the particular geochemical reservoir characteristics but can vary largely between different sites as

* Corresponding author at: Faculty of Mechanical Engineering, Czech Technical University in Prague, Techicka 4, Prague 6, 16607, Czech Republic.

E-mail address: Vaclav.Novotny@cvut.cz (V. Novotny).

<https://doi.org/10.1016/j.egy.2019.10.014>

2352-4847/© 2019 Published by Elsevier Ltd. This is an open access article under the CC BY-NC-ND license (<http://creativecommons.org/licenses/by-nc-nd/4.0/>).

Peer-review under responsibility of the scientific committee of the Tmrees, EURACA, 2019.

well as in fluids from different wells within the same geothermal reservoir [1–3]. Typical NCGs concentrations are in the range of 0.5–5%wt of steam, but there are cases of exceeding 20%wt of steam [1,4,5]. The most common NCG in geothermal fluids is CO₂ (typical concentration of 90–98%wt and global need for abatement), in lesser extent there are present H₂S (also need for abatement), H₂, Ar, NH₃ and CH₄ [3].

In geothermal flash power plants, where the geothermal fluid is throttled (flashed) and gaseous phase is directly utilized in a condensing turbine, the NCGs accumulate in the condenser, decreasing heat transfer and raising the turbine condensing pressure. They lower net power output by lowering the obtainable vacuum. Due to lowering heat transfer coefficient there is also a need for higher heat transfer surface area of the condenser. To remove these gases large vacuum pumps are required, significantly adding to the cost of the plant and to the parasitic load, further reducing the obtainable net power output. Careful optimization between condensing pressure and required size and power of the evacuation system is usually needed.

There is also growing demand for abatement or utilization of CO₂ from various sources in a hope to fight the climate change. Geothermal emissions in this perspective come as not too large, but potentially effectively addressable, source of CO₂ emissions, as the CO₂ comes in a highly concentrated stream. Most of the remaining components in the vented gas stream however typically need to be separated for either CO₂ sequestration or especially for the utilization.

1.1. Technologies for NCGs separation

Evacuation systems of the condensers can be considered as traditional method for the NCGs separation from the geothermal fluid, which comes as mandatory for the condensing plants. The system configuration (neglecting auxiliary systems) is in Fig. 1. Several vacuum pump types come into consideration, steam jet ejector vacuum pumps offer a simple and reliable way of producing a vacuum with a relatively low installation cost, have no moving parts, are easy to install, and handle corrosive steam mixtures. They can also be installed in a multi-stage configuration for higher vacuum [6,7]. Similar to steam jet ejectors is the operating principle of a water jet ejector, where instead of steam, part of cooling water serves as the motive fluid as it is pressurized by a designated pump and routed to an ejector nozzle. Efficiency of jet vacuum pumps is however typically below 30% [8]. Water-ring vacuum can be applied for NCG evacuation. Water ring pumps use a multi-bladed impeller whose shaft is placed eccentrically in the casing. When it rotates, a large pocket is formed in the inlet side of the casing. This pocket decreases in size when the impeller reaches the discharge side, and the gas is compressed. This relatively simple design minimizes noise and vibration as well as maintenance time. Efficiency (isothermal) of water ring pumps is typically between 30%–50% [8]. Lastly given the large amount of NCG, turbocompressors can be also applied to the geothermal plants [1]. They may have higher isentropic efficiency compared to the previous methods but, on the other hand the compression is closer to adiabatic than isothermal process so the difference in power input is not large. In many installations it is quite common to use a combination of the above mentioned methods to get the optimal performance and cost [1]. In some cases with high NCG content it is even considered unfeasible to build and operate the condenser with a large vacuum system, so that a backpressure turbine with an exhaust into the atmosphere is used.

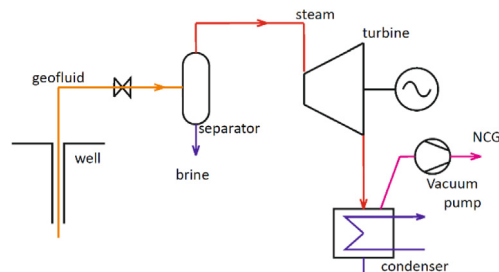

Fig. 1. Schematic configuration of a traditional flash plant with all the NCG being evacuated from the condenser.

Given the issues with the large evacuation systems, it has been proposed to remove the NCG upstream of the turbine using a concept of reboilers. In the reboiler a continuous condensation of the geothermal steam, venting the non-condensed content (only to an extent given by a thermodynamic equilibrium between NCG and vapour) and

subsequent re-boiling of nearly gas-free liquid is used to separate nearly all the NCGs from the steam. Following this process the clean vapour (separated from re-boiled vapour–liquid mixture) is routed to the turbine. Additionally, dissolved solids should mostly remain in a liquid blowdown as not all the condensate re-evaporates. In overall there were proposed four different types of reboilers, three of them based on surface heat exchangers (vertical tube evaporator, horizontal tube, and kettle) and on a direct contact heat exchanger [9,10]. Schematically the principles of the reboilers and overall plant configuration are depicted in Fig. 2. The vented gas can then undergo further treatment based on requirements and demand, such as CO₂ utilization or H₂S abatements treatment.

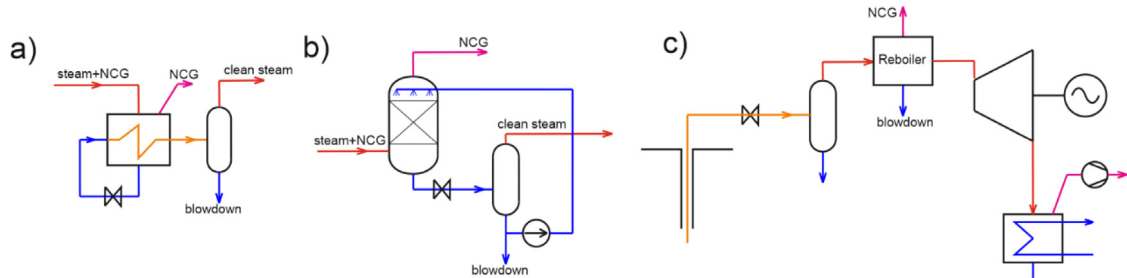

Fig. 2. (a) Surface exchanger type reboiler; (b) Direct contact exchanger type reboiler; (c) Overall upstream reboiler configuration.

All the concepts except for the horizontal tube type were demonstrated in geothermal application in pilot or in commercial operation with some success. The vertical tube reboiler has been tested for over 1000 h of accumulated test time at The Geysers (USA) geothermal field (vapour dominated) already around 1980 and except for other findings a very high heat transfer coefficient was reported. Around 1985 was this concept further tested in Cerro Prieto (México), to evaluate the process in a liquid-dominated geothermal resource, removing 94 wt. % of the NCG from the steam. For the kettle type reboiler, there exists a commercial experience for example from the North Brawley Geothermal Area (USA) or from fields in New Zealand. In 1999, a test program for the direct contact reboilers has been developed at the Kizildere power plant in Turkey with approximately 260 h of run time over a 3-month period of time. The NCG removal efficiency was approximately $76 \pm 23\%$ for a wide range of parameters, varying primarily by the vent rate. Issues encountered were rather high drift of liquid in the vent and issues related to control of the process [9–11].

Low commercial application shows at many issues related to the upstream reboilers. One of the issues is that rejecting the NCG from the high pressure directly to the atmosphere puts into a waste the potential of this gas to provide work. This shows that the benefit of decreasing the NCG content in the steam only hardly offsets in actual applications the negative effects due to throttling and the wasted work potential. In the concepts in [10] is a suggestion of using a separate expander for the separated NCG. On the other hand however this would add a lot of complexity and cost to the overall system. Other potential issues might be in necessity of constructing vessels at relatively high pressures or the mentioned control issues.

2. Intermediate pressure reboiler configuration

2.1. Overall concept

The idea of the intermediate pressure (IP) reboiler is proposed to avoid several disadvantages of both excessive condenser evacuation and upstream reboiler systems respectively. Upstream reboiler (Fig. 2(c)) has the drawback that it is located at relatively high pressure and temperature, so that high cost and potentially high heat loss are incurred. Furthermore, there is a significant loss of steam pressure, thus of work potential. The separated NCG stream at higher than ambient pressure has a work potential as well, but typically is too little to economically put an additional expander on it. Routing all the NCG with the steam to the condenser, as in traditional flash plant (Fig. 1), results in large and costly evacuation system, which also causes large parasitic load.

When the reboiler is designed at an intermediate pressure with condensation right above atmospheric pressure as suggested in Fig. 3, the NCG deliver their work potential they have against the ambient. The equipment will have much lower strength requirements with respect to pressure and also will be operating at lower temperature.

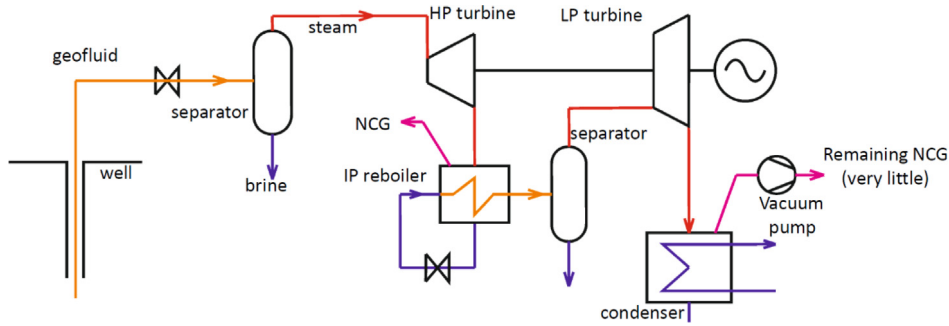

Fig. 3. Schematic configuration of the proposed intermediate pressure reboiler configuration.

2.2. Thermodynamic models

In order to provide an assessment of the benefit of the intermediate reboiler concept, it has been modelled along with the traditional flash plant configuration. In the adopted models, the geofluid is for simplicity considered to contain only water and CO₂ mixture at a specified composition. This assumption follows that the CO₂ is the most dominant constituent of the NCG, typically at very high concentrations. The models of the process schemes of the plants have been developed in AspenPLUS[®] software package with the Peng–Robinson equation of state for the working fluid. In the models separate flash tanks after the exchangers were modelled for separation of the vented or evacuated gas phase and the remaining liquid phase. Pressure loss in the equipment (except for desired throttling) and heat loss of the equipment were neglected. Other assumptions and boundary conditions are summarized in Table 1. In the table *p* stands for pressure, *T* for temperature, $\Delta T_{min,pinch}$ for minimal temperature difference in heat exchangers (pinch points), \dot{m} stands for mass flow rate, η stands for efficiency and subscripts *is*, *it* and *el+mech* stand for isentropic, isothermal and electrical with mechanical respectively. Layout of the models in the AspenPLUS[®] environment is shown in Fig. 4.

Table 1. A list of assumptions and boundary conditions for the models.

<i>p</i> _{well} MPa	<i>p</i> _{separator} kPa	<i>p</i> _{NCG-reject} kPa	<i>T</i> _{geofluid,well} °C	<i>T</i> _{cool.water} °C	$\Delta T_{min,pinch}$ K	$\dot{m}_{geofluid}$ kg/s	$\eta_{turbine,is}$ %	$\eta_{vac.pump,it}$ %	$\eta_{el+mech}$ %
10	500	110	200	25	5	100	80	50	98

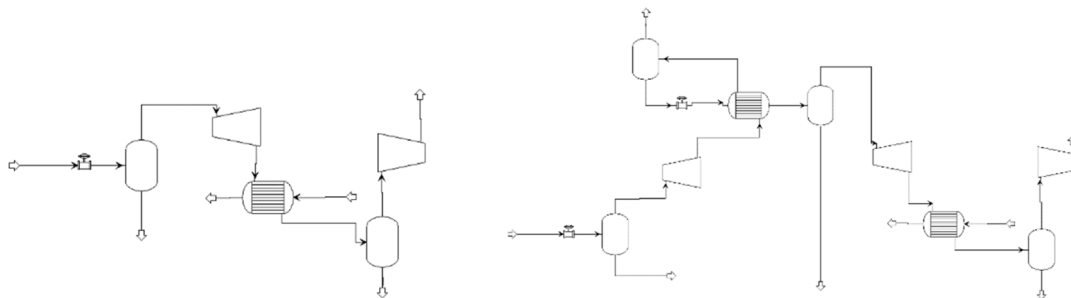

Fig. 4. AspenPLUS models layout for (a) Traditional flash plant configuration; (b) IP reboiler configuration.

The analysed configurations considered a water-ring vacuum pump for the condenser evacuation. To model the compression which for water-ring pump is nearly isothermal and the power requirement, isothermal compression work for non-ideal fluid is first calculated based on Eq. (1), where *W* stands for work, *U* is internal energy and *Q* is transferred heat. Isothermal power is then divided by the isothermal efficiency of the vacuum pump and then electrical efficiency of the drive to get the electricity input.

$$W_{it} = \Delta U - Q = \Delta U - T \Delta S = W_{el.vacuum.pump} \cdot \eta_{vacuum.pump} \tag{1}$$

For each case of explored CO₂ concentration in the geofluid was found an optimal operating point based on an available degree of freedom. In the traditional configuration that was a condensing pressure, which defines together with a pinch point the end-point of condensation for the vapour-CO₂ mixture. Lower the condensing pressure is, higher the turbine output but also higher the power input for the vacuum pump. For the intermediate pressure reboiler, the residual amount of the CO₂ that flows into the condenser is practically the same regardless of upstream conditions and the condensing pressure is fixed by the boundary conditions. Condensation pressure in the reboiler is also fixed as it is specified. Give the pinch-point, varying the evaporation pressure in the reboiler however affects the condensation end point — the point of a vapour-liquid equilibrium defining how much vapour needs to exit with the CO₂. Lower the evaporation pressure is, less vapour there is escaping with the NCG vent stream, but also there is lower admission pressure to the LP turbine.

It can be argued that more parameters should be taken into account and investigated. Namely the first one would be flash pressure in the separator. Then the results could include also the overall plant auxiliary systems, e.g. with cooling or brine reinjection system or different types of vacuum systems. However this is only the first work showing the novel concept. The purpose of this work is to give information whether the intermediate pressure boiler is worth of future investigation.

2.3. Economic evaluation model

As the main purpose here is to compare the traditional and novel configurations, a costing for the equipment that differs between the configurations is performed in this section. Therefore the cost of systems such as wells, gathering system, cooling circuit, reinjection systems and other auxiliaries were not considered at this point.

For the overall economic performance is undertaken more simpler approach towards the equipment and construction costs. The costing of the equipment specified in the figures has been done by the AspenPLUS[®] inbuilt economic model with respect to a period of year 2016 and referenced to Rotterdam location. Note that the heat exchangers with liquid and vapour outlet are modelled as heat exchanger (shell & tube) followed by a flash tank. On the other hand cost of this additional piece of equipment justifies required modifications of the exchangers. There was used a modified ASEP model with 15 year lifetime and 7000 h per year of operation.

3. Results and discussion

The maximum net power output of the two configurations together with relative benefit of the IP reboiler configuration and with a specified NCG content in steam after the separator are shown in Fig. 5. This figure presents the point of 0.6 wt. % of the NCG content in the geofluid (just over 5% of NCG in steam), where the proposed configuration of the IP reboiler provides a thermodynamic benefit. The net power output of the traditional configuration decreases steadily as the NCG content increases. On the other hand the concept with the IP reboiler further provides an interesting behaviour, where after initial decrease; the power output becomes nearly constant and independent on the NCG content.

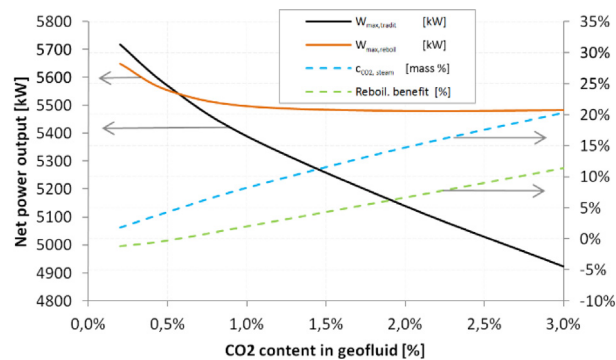

Fig. 5. Net power output, NCG content in steam after separator and relative comparison of the configurations.

The heat transfer in the heat exchangers with CO₂-vapour mixtures is for illustration depicted by Q - T diagrams for a 2% CO₂ content in geofluid. Fig. 6(a) shows the condenser of a traditional configuration, Fig. 6(b) shows then

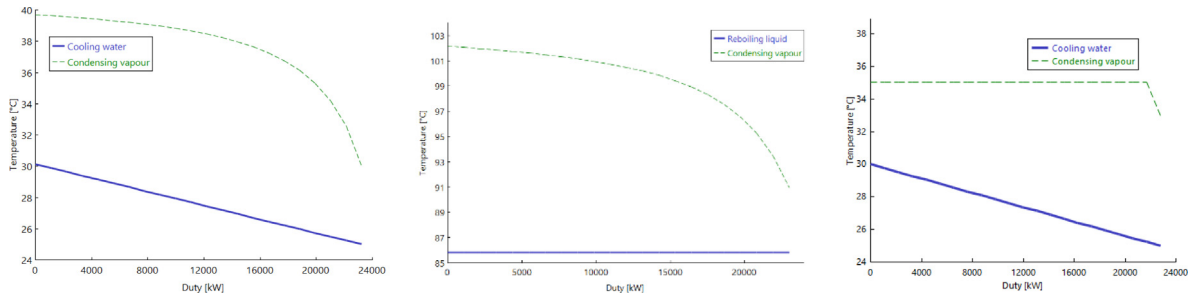

Fig. 6. Q-T diagrams for a 2% CO₂ geofluid content in (a) condenser of a traditional configuration, (b) IP reboiler, (c) condenser of the IP reboiler configuration.

the IP reboiler and Fig. 6(c) shows a condenser for the IP reboiler case. In the first two cases of a heat exchanger with significant CO₂ content in the condensing vapour clearly shows limitations that must be taken to fulfil the minimum temperature difference requirements. Once the steam is nearly free of the CO₂, it has nearly isothermal condensation allowing for lower condensation pressure.

A sensitivity study with respect to condensing pressure for the traditional scheme and reboiling pressure of the IP reboiler has been performed. Its results for the 2% CO₂ content in geofluid are presented in Fig. 7. It shows turbine power output, vacuum pump power requirement, net power output, concentration of the CO₂ in the vented stream entering the vacuum pump (mixture of CO₂ and vapour) and lastly vapour quality of the stream between condensation and liquid separation.

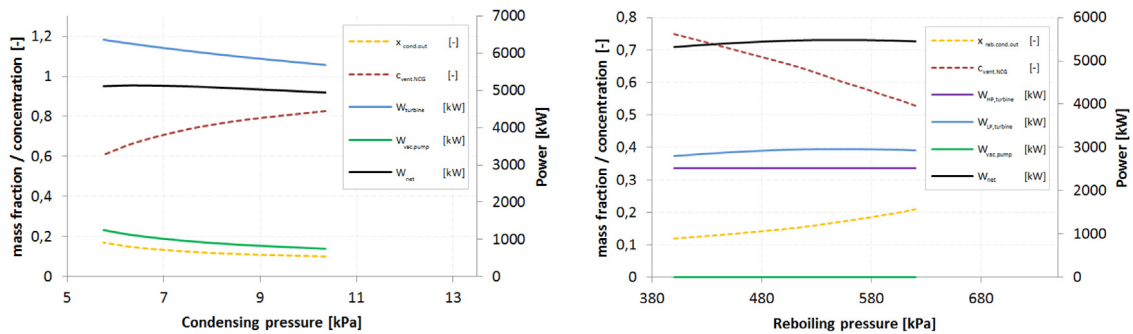

Fig. 7. Effect of (a) condensing pressure of the traditional configuration on plant parameters and (b) reboiling pressure in the IP reboiler configuration on plant parameters.

In case of the traditional configuration in Fig. 7(a) is shown that decreasing pressure results in increase in both, turbine output and vacuum pump input. Also it results in lower CO₂ concentration in the vented stream (more water vapour) higher content of uncondensed vapours in overall. Optimum pressure is seen for the pressure around 6.5 kPa. In Fig. 7(b) is on the other hand seen that the vacuum pump power input is very small and nearly constant as the gas is already vented upstream. Constant is also the HP turbine output. The difference with the boiling pressure is attributed mostly towards the LP turbine output. Optimum pressure is found here to be approximately 550 kPa. The vapour fraction after condensation and the CO₂ concentration of the vented stream is based on the thermodynamic balance between the condensing and evaporating streams.

From the equipment sizing point of view, Fig. 8 shows the difference for the optimized cases in a summarized UA product of the heat exchangers and the power input of the vacuum pump. The tradeoff between the traditional and the IP reboiler configuration is obvious in size of the heat exchangers and of the vacuum pump system. As the IP reboiler manages to separate nearly all NCG present in the steam, the required power of the vacuum pump system is for this configuration close to nil. Note that air leaks however are not considered in neither of the configurations.

Economic results comparing capital cost of the equipment, which varies for of each of the two explored configurations is shown in Fig. 9. The major difference is in the cost of the vacuum system, which grows significantly with the NCG content in the geofluid. As the overall power output or combined size of the turbine is similar, there

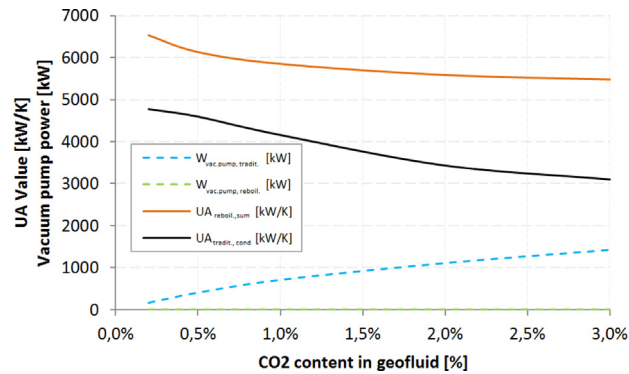

Fig. 8. Net power output, relative comparison of the configurations and NCG content in steam after separator.

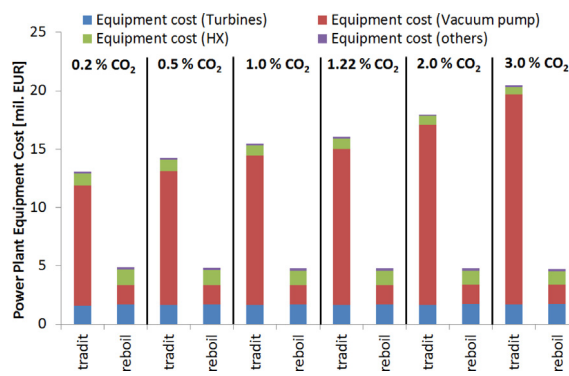

Fig. 9. CAPEX of the traditional and IP reboiler subsystem configurations.

is very small difference in its cost. The additional HX cost of the IP reboiler configuration is notable, though it is disproportionate to the vacuum system.

4. Discussion

In general the concept of IP reboiler can be further integrated not only into single flash condensing plants, but also into multiple-flash plants or as a retrofit to backpressure plants. In the multiple-flash system, instead of splitting the expansion process at the atmospheric pressure, it might be beneficial to use pressure of the lowest (above atmospheric) flash pressure as a condensing pressure of the reboiler (minimum additional equipment required). In case of current backpressure turbines exhausting the steam directly to the atmosphere, the IP reboiler concept requires additional equipment of the reboiler itself, LP turbine and a condenser with auxiliary systems. As such it can be however integrated with minimal impact on the current plant, which might be beneficial both from technical point of view as well as from economic system evaluation.

The IP reboiler configuration in comparison to the traditional one has a number of features, which can be described in a following list of advantages and disadvantages.

Advantages of the IP reboiler scheme:

- Passively operating system, except for possible control valve
- Largely reduced size of condenser vacuum pump
- At our boundary conditions higher net power production for NCG (CO_2) mass fraction $>0.6\%$ in geofluid (5% in steam)
- Lower precipitation risk of dissolved minerals on LP turbine stages
- Higher steam quality in LP turbine stages

- NCG (CO₂) stream vented right above atmospheric pressure — available for further treatment for utilization or sequestration
- Reboiler at near atmospheric pressure — low material strength requirements
- Retrofittable to current backpressure geothermal units
- Higher heat transfer coefficient in condenser (lower NCG content)
- Lower capital investment cost (mostly due to evacuation system of condenser)
- Relative independence of the total capital investment cost and net power output on the CO₂ content in the fluid

Disadvantages of the IP reboiler scheme

- Higher complexity and number of pieces of equipment
- Additional system for balance of the plant
- Untested for real operation
- Larger volumetric flow at the outlet of the turbine

5. Conclusion

There is proposed a novel concept for flash geothermal power plants for applications with a high content of non-condensable gases (NCG) in geofluid by integrating a reboiler at an intermediate pressure. This approach for a demonstrated case of 200 °C geofluid throttled at 5 bar and given conditions provides a higher output when the NCG content (represented here by CO₂ only) in the geofluid exceeds 0.6 wt. % (i.e. about 5 wt. % in steam). Major advantage is seen also in significantly lower cost of a vacuum system, that otherwise needs to evacuate these gases from condenser. The results may be relevant also for current backpressure system where integration of the intermediate reboiler concept should be very simple with minimal impact to the current plant equipment and operation.

Acknowledgements

This work has been supported by the Ministry of Education, Youth and Sports within National Sustainability Programme I (NPU I), project No. LO1605 – University Centre for Energy Efficient Buildings – Sustainability Phase and by Norway Grants under the Czech-Norwegian Research Programme CZ08, Fund for Bilateral Relations at Programme Level, Initiatives No. NF-CZ08-BFB-1-1026-2017 and No. NF-CZ08-BFB-1-025-2017.

References

- [1] DiPippo R. *Geothermal power plants : Principles, applications, case studies, and environmental impact*. Oxford, UK: Butterworth-Heinemann; 2012.
- [2] Swandaru RB. Thermodynamic analysis of preliminary design of power plant unit I patuha. Indonesia: West Java; 2006.
- [3] Khaghani A, Date A, Akbarzadeh A. *Renew Sustain Energy Rev* 2013;21:204–14.
- [4] Yildirim Ozcan N, Gokcen G. *Appl Therm Eng* 2009;29:3246–53.
- [5] Gokcen G, Yildirim N. *Int J Exergy* 2008;5:684–95.
- [6] Moerman F, Desanghere N. *PUMPS Process Mag*. 2011;21–6.
- [7] Walas SM. *Chemical process equipment; selection and design*. Reed Publishing; 1990.
- [8] Kaminský J, Kolarčík K, Pumpřla O. *Kompresory [Compressors]*, 1. vyd. Ostrava: VŠB - Technická univerzita Ostrava; 2004.
- [9] Awerbuch L, Van Der Mast V, Soo-Hoo R. *Geotherm Resour Counc Trans* 1984;8:21–6.
- [10] Ozcan NY. Modeling, simulation and optimization of flashed-steam geothermal power plants from the point of view of noncondensable gas removal systems. 2010.
- [11] Gunerhan GG, Coury G. *Proc. World Geotherm. Congr. Vol. 2000*. 2000, p. 3173–8, 3173–3178.